

Panasonic

Telephone Answering System

Model No. **KX-TMC98-B**

Pulse-or-tone dialing capability

Operating Instructions

Preparation

Telephone

Answering System

Useful Information



Jog Dial

2 LINE

Caller ID Compatible

PLEASE READ BEFORE USE AND SAVE.

Before Initial Use

Please read IMPORTANT SAFETY INSTRUCTIONS on pages 89–90 before use. Read and understand all instructions.

Thank you for purchasing your new Panasonic integrated telephone.

Caller ID and Visual Call Waiting (Call Waiting ID), where available, are telephone company services. After subscribing to Caller ID, this phone will display the caller's name and phone number. An added service, Visual Call Waiting, will display the second caller's name and phone number during call waiting.

Attach your purchase receipt here.

For your future reference

Serial No. _____

(found on the bottom of the unit)

Date of purchase _____

Name and address of dealer _____

Accessories (Included) To order, call 1-800-332-5368.

- AC Adaptorone
(p. 10)
Order No. KX-A11-6

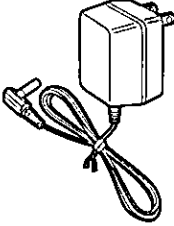

- Wall Mounting Adaptorone
(p. 79)
Order No. PQKL28Z0

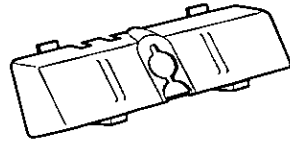

- Handsetone
(p. 10)
Order No. PQJX2PML01Z

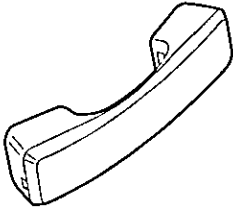

- Handset Cordone
(p. 10)
Order No. PQJA212V

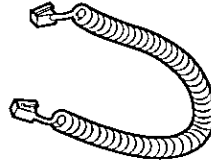

- 4-Wire Telephone Line Cord
with Green Plugsone
(p. 11, 12)

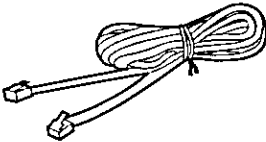

- 2-Wire Telephone Line Cord
with Transparent Plugsone
(p. 12)

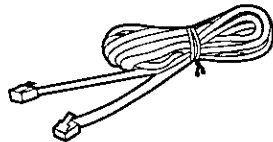

Contents

Preparation

Location of Controls	6
Display	8
Settings	10
Connecting the Handset/AC Adaptor	10
Connecting the Telephone Line Cord	11
Selecting the Dialing Mode	13
Selecting the Line Mode	14
Selecting the Ringer Volume	15
Storing the Area Code	16
Programming Summary of Preparations	17
Preparing the Answering System	18
Greeting Message	18
Selecting the Caller's Recording Time	21
Date and Time Adjustment	22
Selecting the Number of Rings	24
Setting the CPC (Calling Party Control) Function	25
Setting the Greeting Monitor Function	25

Telephone

Making Calls	26
Answering Calls	29
Using the Other Line During a Conversation	30
Conference Call	31
Caller ID Service	32
Using the Caller List	34
Viewing the Caller List	34
Calling Back from the Caller List	36
Editing the Caller's Phone Number	37
Storing the Caller List Information in the Directory	38
Clearing the Caller List Information	40
Using the Directory	42
Storing Names and Numbers in the Directory	42
Steps for Entering Names and Symbols	44
Finding Items in the Directory	46
Dialing from the Directory	47
Changing an Item in the Directory	48
Clearing an Item from the Directory	49

Special Features	50
For Call Waiting Service Users	50
Temporary Tone Dialing (For Rotary or Pulse Service Users)	51
How to Use the PAUSE Button (For Analog PBX Line/Long Distance Service Users)	51
Programmable Functions	52
Line Selection	52
Incoming Call Tone	53

Preparation

Answering System

Automatic Answering Operation	54
Setting the Unit to Answer Calls	54
Listening to Messages	57
Erasing Messages	60
Recording Your Telephone Conversation	62
Pager Call	63
Storing the Pager Number	63
Storing Your Home Telephone Number	65
Pager Mode Setting	67
Setting the Unit to Call a Pager	68
Remote Operation from a Touch Tone Phone	70
Setting the Remote Code	71
Voice Menu	72
Direct Remote Operation	74
Remote Operation Card	77

Telephone

Answering System

Useful Information

Wall Mounting	79
Using an Optional Headset	80
Connecting an Optional Headset to the Unit	80
Selecting the Headset/Speakerphone	81
How to Wear an Optional Headset	81
Making/Answering Calls	82
Using the Other Line During a Conversation	83
Before Requesting Help	84
Important Safety Instructions	89
FCC and Other Information	91

Useful Information

Location of Controls

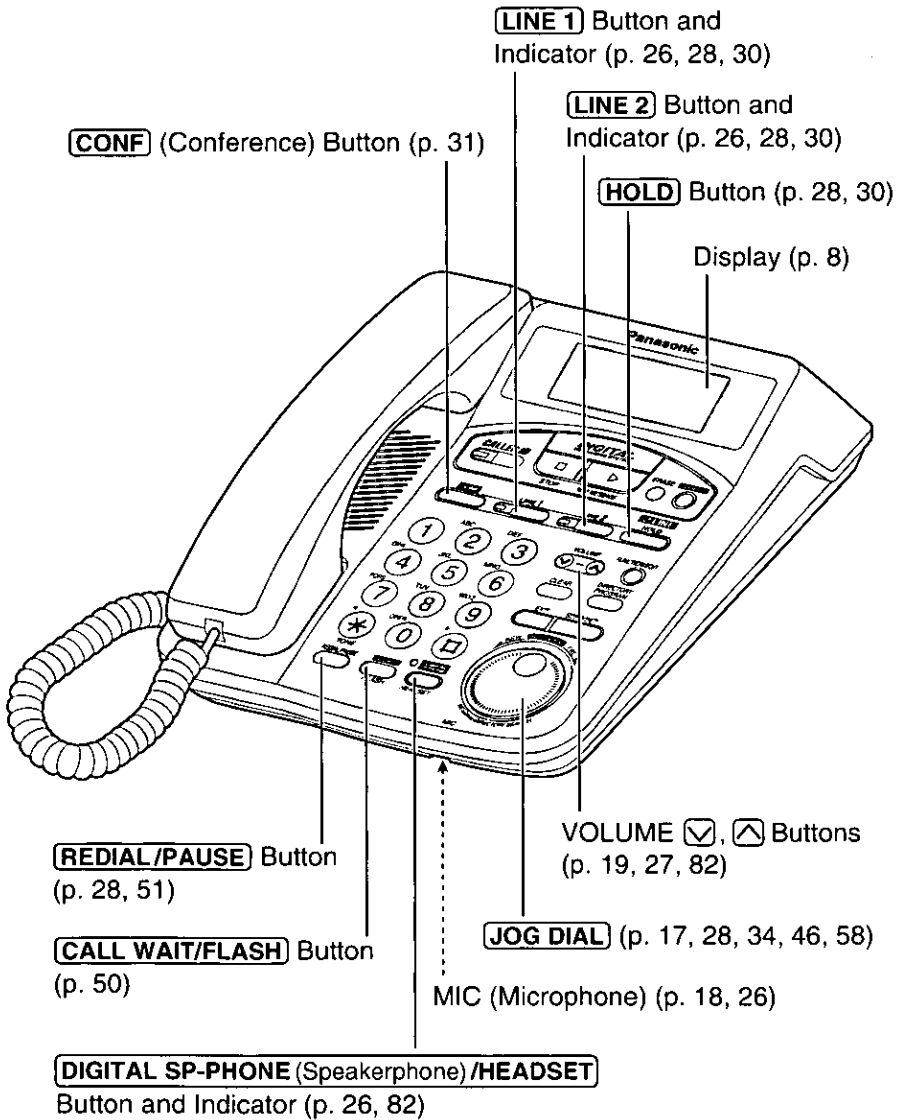

NEW MESSAGE Button
(p. 57, 58)

STOP Button (p. 58)

ERASE Button
(p. 20, 60)

CALLER ID Button and Indicator
(p. 33, 34)

ANSWER ON
Button (p. 55)

Headset Jack (p. 80) ----->

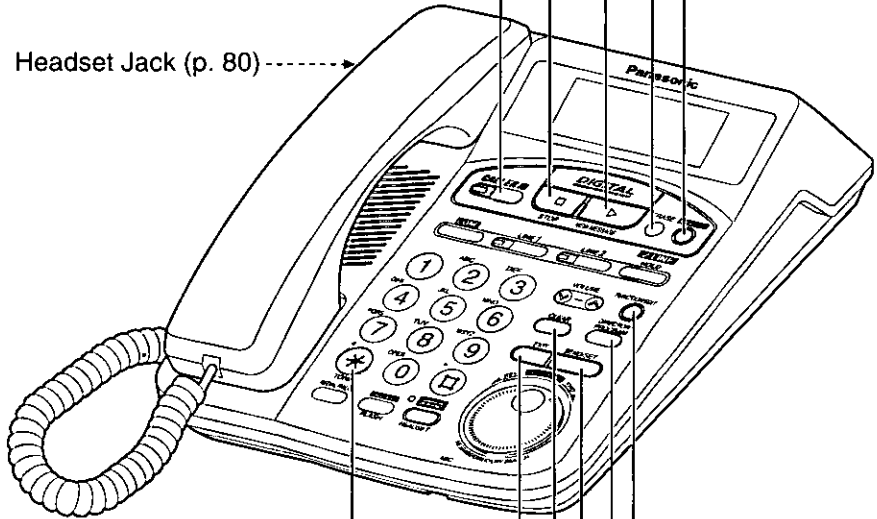

TONE Button (p. 51)

FUNCTION/EDIT
Button (p. 17, 37, 62)

EXIT Button (p. 17, 27, 34, 46)

DIRECTORY PROGRAM
Button (p. 38, 43)

CLEAR Button (p. 16, 27, 40, 49)

SEND/SET Button (p. 17, 27, 59)

Display

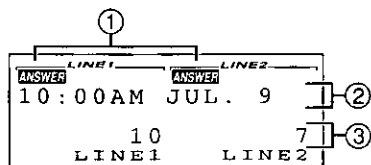

- In the stand-by mode, the display shows:
- ① the selected line(s) that can be answered by the answering system (p. 54). (Ex. Both lines are selected.)
 - ② the current time and date
 - ③ the number of recorded messages (Ex. 10 messages have been recorded on LINE 1 and 7 messages on LINE 2.)

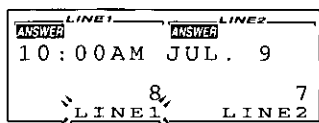

There are some new messages on LINE 1. (The "LINE 1" display flashes.)

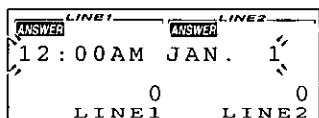

When the clock needs adjusting, the time and date flash (p. 22).

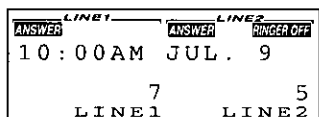

"**RINGER OFF**" is displayed when the ringer volume is set to "Off" (p. 15). (Ex. The LINE 2 ringer volume is "Off".)

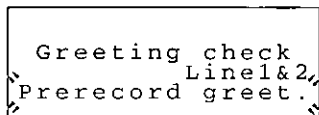

The pre-recorded messages for LINE 1 and LINE 2 are being played (p. 20). ("Prerecord greet." flashes.)

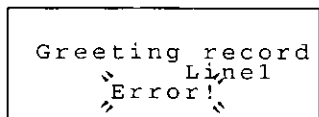

Your greeting message was not recorded correctly. ("Error!" flashes.) Record it again (p. 18).

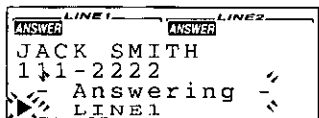

The answering system is recording a message on LINE 1 (p. 54). ("– Answering –" flashes.) "▶" flashes while messages are being recorded or played back.

Ex. Handset volume level: 2
Speaker volume level: 4

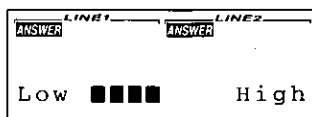

The display shows the volume level.
You can select:

- 4 levels (1–4) while using the handset (p. 27) or optional headset (p. 82).
- 8 levels (1–8) while using the speakerphone (p. 27).
- 9 levels (0–8) while using the answering system (p. 19, 57).

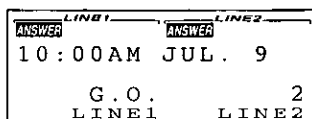

The LINE 1 recording time is set to "G.O. (greeting only)" (p. 21).

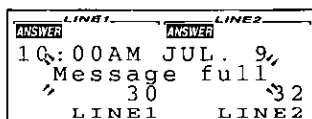

Message memory is full. ("Message full" flashes.) Erase some or all of the messages (p. 60).

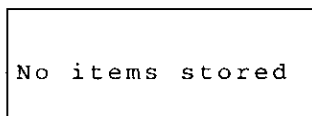

This display will be shown when:

- the redial list is empty,
- the Caller List for both lines is empty,
- the directory list is empty, or
- there are no stored items in the dialing button you pressed in the directory.

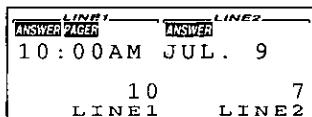

"**PAGER**" indicates that the unit is set to alert a pager when it records an incoming message or receives a Caller ID call (p. 68). (Ex. The LINE 1 pager call mode is "On".)

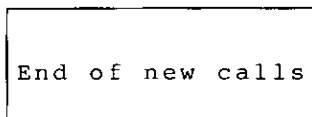

You have finished viewing the **NEW CALLS** in the Caller List. To exit, press **EXIT**.

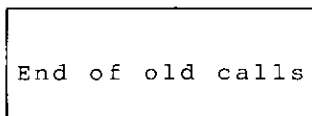

You have finished viewing the **OLD CALLS** in the Caller List. To exit, press **EXIT**.

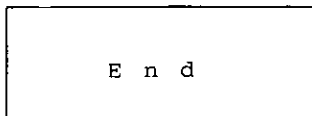

You are at the end of the Caller List. To exit, press **EXIT**.

Settings

Connecting the Handset/AC Adaptor

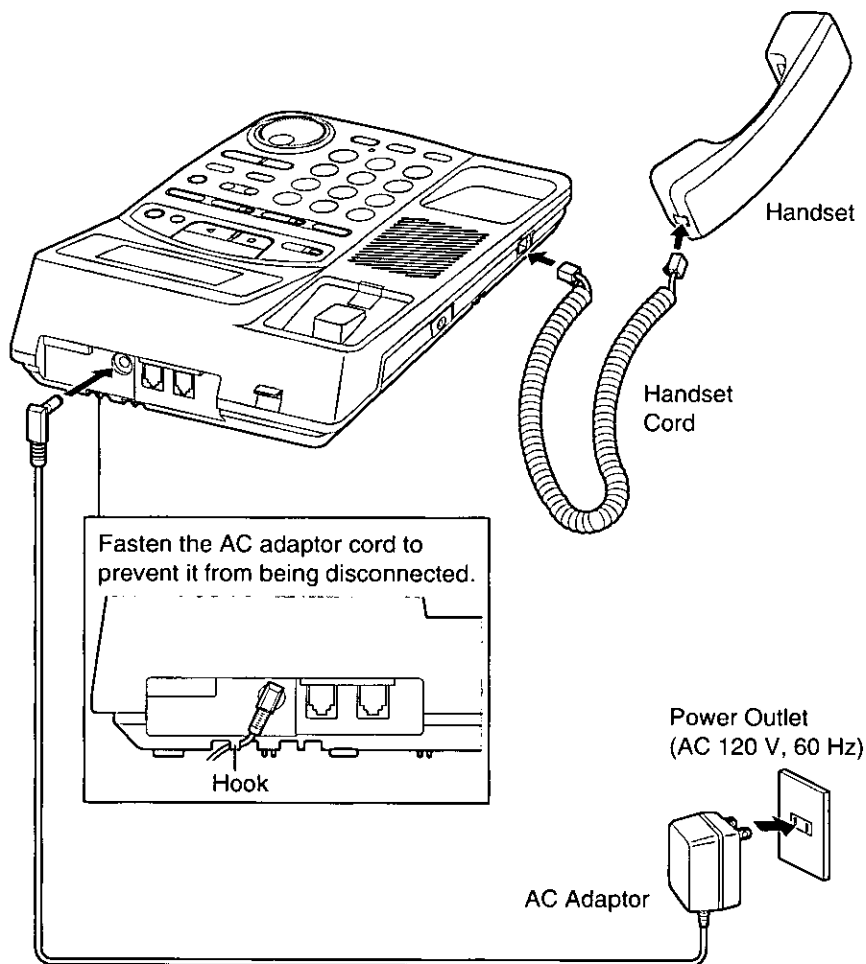

- Use only a Panasonic Handset for the KX-TMC98-B.
- **USE ONLY WITH Panasonic AC ADAPTOR KX-A11** (Order No. KX-A11-6).
- The AC adaptor must remain connected at all times. (It is normal for the adaptor to feel warm during use.)
- During a power failure the unit will work as a single-line telephone, but the speakerphone will not work and the line indicators will not light.
- If your unit is connected to a PBX which does not support Caller ID services, you cannot access those services.



Connecting the Telephone Line Cord

Connect the telephone line cord(s) to the unit as follows.

To connect a two-line telephone jack

Preparation

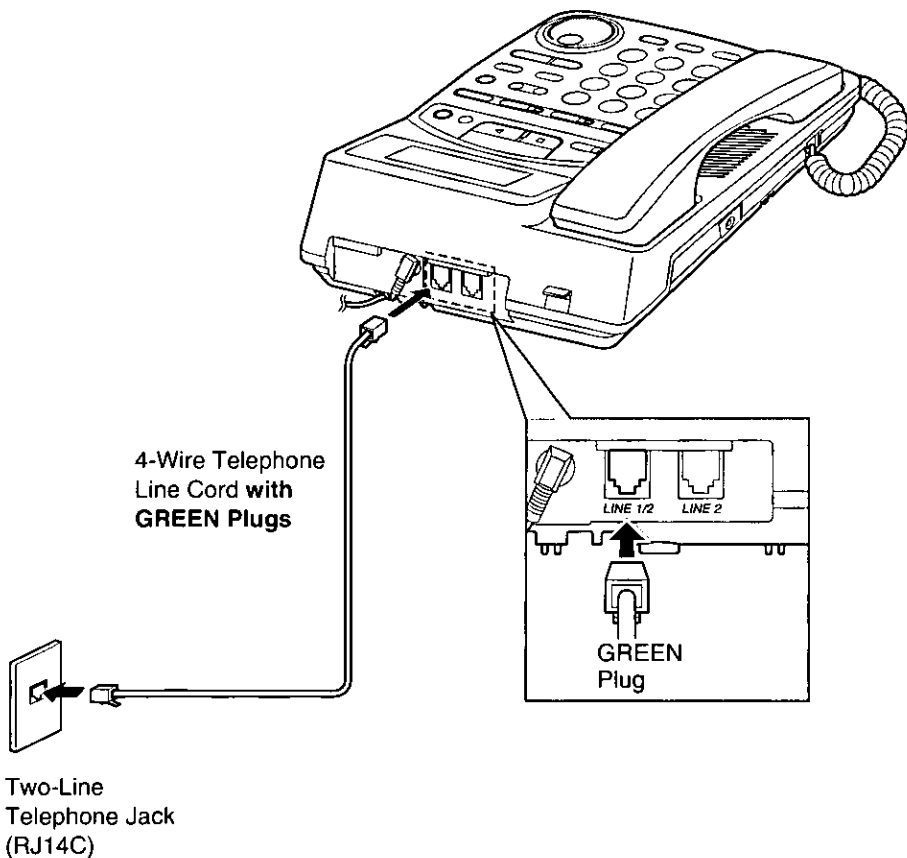

➔ Settings

To connect two single-line telephone jacks

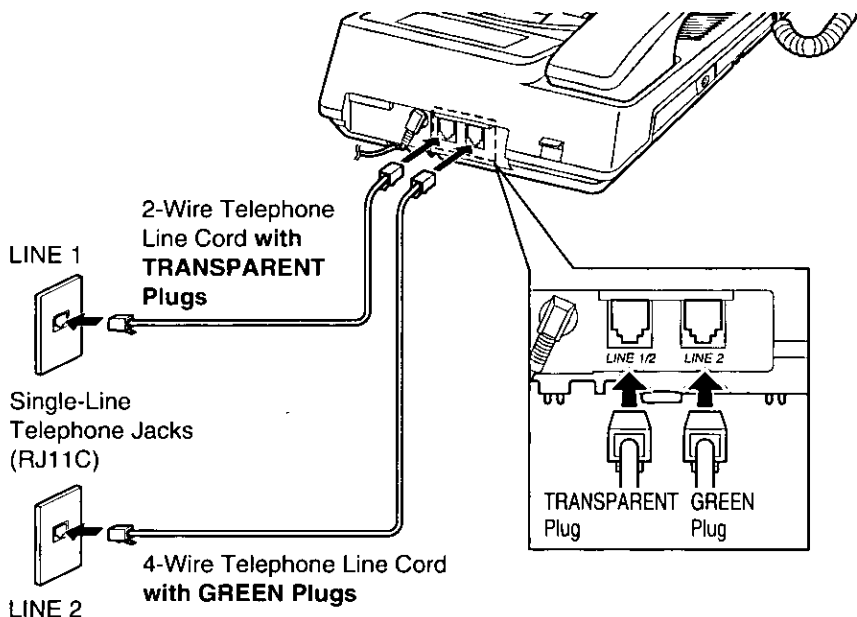

If you use the unit as a single-line telephone only

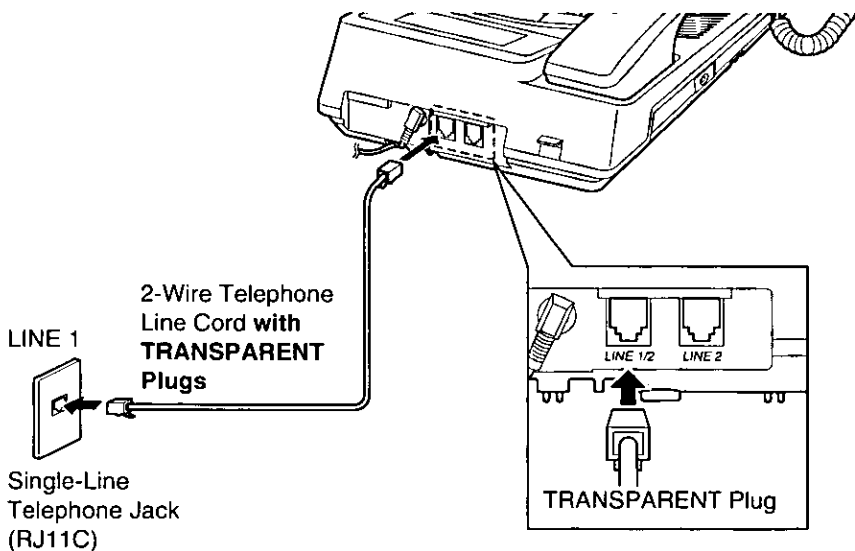

- For this connection, you can only use LINE 1.



Selecting the Dialing Mode

You can select the dialing mode by programming. If you have touch tone service, set to "Tone". If rotary or pulse service is used, set to "Pulse". Your phone comes from the factory set to "Tone".

Be sure that the handset is on the cradle, the AC adaptor is connected and the DIGITAL SP-PHONE indicator light is off.

1 Press **FUNCTION/EDIT**.

- The display shows "Rotate JOG and press SET", then the function list.

```

→Date and time
Answer line
Greeting record
-Function list-
  
```

2 Rotate **JOG DIAL** until "Dialing mode" is selected.

- The arrow points to "Dialing mode".

```

Line selection
→Dialing mode
Area code
-Function list-
  
```

3 Press **SEND/SET**.

- The current mode is displayed.

```

Dialing mode
: Tone
SET=Save
  
```

4 Rotate **JOG DIAL** until the desired mode is displayed.

```

Dialing mode
: Pulse
SET=Save
  
```

5 Press **SEND/SET** (Save key).

- A long beep sounds and the mode is saved.
- The display will return to the function list. To return to the stand-by mode, press **EXIT** or wait for 60 seconds.

```

Dialing mode
: Pulse
  
```

- You can exit the programming mode any time by pressing **EXIT**.
- If either line has rotary or pulse service, set to "Pulse". When making a call using a line which has touch tone service, press ***** first and then dial the number.

➔ Settings

Selecting the Line Mode

If a line is connected to a low voltage system such as a PBX, set to "B". If not, the following will not work: the line indicator will not operate properly, the unit will not ring, the Visual Call Waiting (Call Waiting ID) Service will not be available (p. 50), you will not hear the incoming call tone (p. 53), caller's messages will not be recorded and the unit will not alert your pager (p. 63). Both lines are preset to "A".

Be sure that the handset is on the cradle, the AC adaptor is connected and the DIGITAL SP-PHONE indicator light is off.

- 1 Press **FUNCTION/EDIT**.
 - The display shows "Rotate JOG and press SET", then the function list.
- 2 Rotate **JOG DIAL** until "Line mode" is selected.
 - The arrow points to "Line mode".
- 3 Press **SEND/SET**.
- 4 Rotate **JOG DIAL** to select the desired line, "Line1" or "Line2".
- 5 Press **SEND/SET** (Next key).
 - The current mode is displayed.
- 6 Rotate **JOG DIAL** until the desired mode is displayed.
- 7 Press **SEND/SET** (Save key).
 - A long beep sounds and the mode is saved.
 - The display will return to the function list. To program the other line, start from step 3.
 - To return to the stand-by mode, press **EXIT** or wait for 60 seconds.

```
→Date and time
Answer line
Greeting record
-Function list-
```

```
Headset select
→Line mode
Date and time
-Function list-
```

```
Line mode :Line1
SET=Next
```

```
Line mode :Line2
SET=Next
```

```
Line mode
Line2:A
SET=Save
```

```
Line mode
Line2:B
SET=Save
```

```
Line mode
Line2:B
```

- You can exit the programming mode any time by pressing **EXIT**.



Selecting the Ringer Volume

You can select the ringer volume for each line by programming. Set to "High" or "Low". When set to "Off", the selected line(s) will not ring. Both lines are preset to "High".

Be sure that the handset is on the cradle, the AC adaptor is connected and the DIGITAL SP-PHONE indicator light is off.

1 Press **FUNCTION/EDIT**.

- The display shows "Rotate JOG and press SET", then the function list.

```

→Date and time
Answer line
Greeting record
-Function list-
  
```

2 Rotate **JOG DIAL** until "Ringer volume" is selected.

- The arrow points to "Ringer volume".

```

→Ringer volume
Headset select
Line mode
-Function list-
  
```

3 Press **SEND/SET**.

```

Ringer volume
:Line1
SET=Next
  
```

4 Rotate **JOG DIAL** to select the desired line, "Line1" or "Line2".

```

Ringer volume
:Line2
SET=Next
  
```

5 Press **SEND/SET** (Next key).

- The current setting is displayed.

```

Ringer volume
Line2:High
SET=Save
  
```

6 Rotate **JOG DIAL** until the desired level is displayed.

```

Ringer volume
Line2:Low
SET=Save
  
```

7 Press **SEND/SET** (Save key).

- The selected volume rings. When set to "Off", a beep sounds.
- The display will return to the function list. To program the other line, start from step 3.
- To return to the stand-by mode, press **EXIT** or wait for 60 seconds.

```

Ringer volume
Line2:Low
  
```

- You can exit the programming mode any time by pressing **EXIT**.
- When set to "Off", "**RINGER OFF**" will be displayed for the line selected in step 4 when you exit the function list.

Storing the Area Code

We recommend that you program your area code first before using the Caller ID feature (p. 32). Then incoming calls from the same area code will be recorded in the Caller List without the area code. You do not have to remove the area code before calling back or storing. Also, when incoming calls from a different area code are received, "1" will be added before the area code automatically.

Be sure that the handset is on the cradle, the AC adaptor is connected and the DIGITAL SP-PHONE indicator light is off.

- 1 Press **FUNCTION/EDIT**.
- The display shows "Rotate JOG and press SET", then the function list.

```
→Date and time
Answer line
Greeting record
-Function list-
```

- 2 Rotate **JOG DIAL** until "Area code" is selected.
- The arrow points to "Area code".

```
Line selection
Dialing mode
→Area code
-Function list-
```

- 3 Press **SEND/SET**.
- The current setting is displayed. The factory preset is "---".

```
Area code      : ---
SET=Save
```

- 4 Enter your area code.
- If you enter a wrong number, press **CLEAR**, then enter the correct number.

```
Area code      : 123;
SET=Save
```

- 5 Press **SEND/SET** (Save key).
- A long beep sounds and the code is saved.
 - The display will return to the function list. To return to the stand-by mode, press **EXIT** or wait for 60 seconds.

```
Area code      : 123
```

- You can exit the programming mode any time by pressing **EXIT**.

To clear the area code

Press **FUNCTION/EDIT** ➔ rotate **JOG DIAL** until "Area code" is selected ➔ press **SEND/SET** ➔ **CLEAR** ➔ **SEND/SET** (SAVE key).

Programming Summary of Preparations

You can program the following functions. The display shows the programming instructions. See the corresponding pages for the function details.

Be sure that the handset is on the cradle, the AC adaptor is connected and the DIGITAL SP-PHONE indicator light is off.

Press **FUNCTION/EDIT**.

- "Rotate JOG and press SET" is displayed, then the display changes to the function list.



Rotate **JOG DIAL** until the desired function is selected.

- The arrow points to the selected function.



Press **SEND/SET**.

- To adjust the date and time, see page 22.
- To select the line(s) for the answering system, see page 54.
- To record the greeting message, see page 18.
- To check the greeting message, see page 20.
- To select the number of rings, see page 24.
- To select the caller's recording time, see page 21.
- To set the remote code, see page 71.
- To set the greeting monitor function, see page 25.
- To set the CPC (Calling Party Control) function, see page 25.
- To store the pager number, see page 63.
- To set the pager call on/off, see page 68.
- To call the pager, see page 66.
- To change the pager mode setting, see page 67.
- To store your home telephone number, see page 65.
- To change the line selection, see page 52.
- To select the dialing mode, see page 13.
- To store the area code, see page 16.
- To set on/off the incoming call tone, see page 53.
- To select the ringer volume, see page 15.
- To select the headset/speakerphone, see page 81.
- To select the line mode, see page 14.



When finished, press **SEND/SET** (Save key).

- You can exit the programming mode any time by pressing **EXIT**.

Preparing the Answering System

Greeting Message

You can record a personal greeting message for each line or a common greeting message for both lines. If a message is not recorded, one of two pre-recorded greetings will be played when a call is received (p. 20).

All messages (greeting, incoming, etc.) are stored in digital memory (p. 20). The **total recording time is about 33 minutes**.

We recommend you record a **brief greeting message** (see the sample on the next page) in order to leave more time in memory.

To record a greeting message

1 Press **FUNCTION/EDIT**.

```
→Date and time
Answer line
Greeting record
-Function list-
```

2 Rotate **JOG DIAL** until "Greeting record" is selected.

- The arrow points to "Greeting record".

```
Date and time
Answer line
→Greeting record
-Function list-
```

3 Press **SEND/SET**.

```
Greeting record
:Line1
SET=Start
```

4 a) To record a greeting for each line, rotate **JOG DIAL** until "Line1" or "Line2" is displayed.

b) To record a common greeting, rotate **JOG DIAL** until "Line1&2" is displayed.

Ex. To record a common greeting

```
Greeting record
:Line1&2
SET=Start
```

5 Press **SEND/SET** (Start key).

- "Record greeting after the beep" and a long beep are heard.

```
Greeting record
Line1&2
```

6 After the long beep, talk clearly about 8 inches (20 cm) away from the **MIC** (microphone).

- The display shows the elapsed recording time.

```
Greeting record
Line1&2
00-00
```



7 When finished, press **SEND/SET**.

- A long beep sounds and the recorded message is played.
- The display will return to the function list. To change the message or record a message for the other line, start from step 3.
- To return to the stand-by mode, press **EXIT** or wait for 60 seconds.

Greeting record
Line1&2

Greeting record
Line1&2
00-00

To increase the volume, press **VOLUME** .
To decrease, press **VOLUME** .

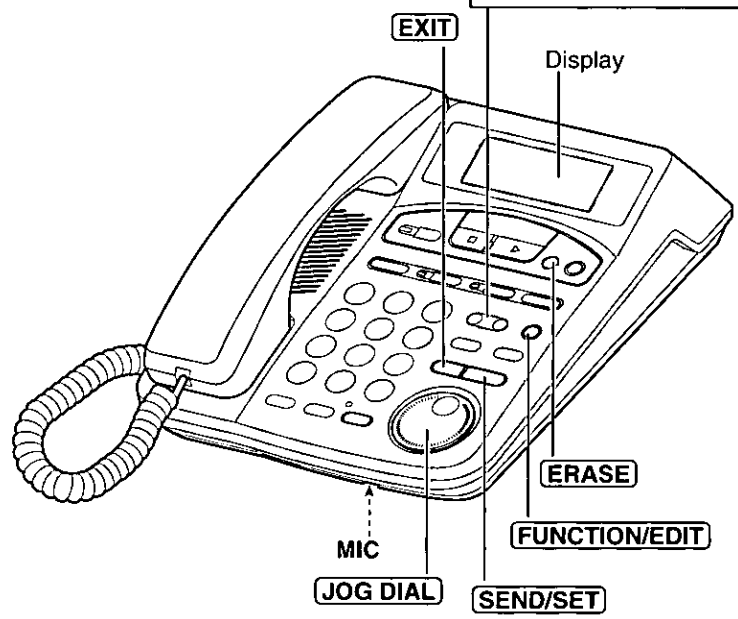

Greeting message sample

"Hello, this is (your name and/or number). Sorry I cannot take your call. Please leave a message after the beep. Thank you."

➔ Preparing the Answering System

Pre-recorded greeting message

If you do not record a greeting message (p. 18), one of the following two messages will be played when a call is received depending on the caller's recording time (p. 21).

- When the recording time is set to "1 minute" or "unlimited";
"Hello, we are not available now. Please leave your name, message and phone number after the beep. We will return your call."
- When the recording time is set to "greeting only";
"Hello, no one is available to take your call. Please call back later. Thank you."

To check the greeting message(s)

1. Press **FUNCTION/EDIT**.
2. Rotate **JOG DIAL** until "Greeting check" is selected.
3. Press **SEND/SET**.
4. Rotate **JOG DIAL** to select the desired line(s), "Line1", "Line2" or "Line1&2".
5. Press **SEND/SET** (Start key).
 - The greeting(s) is(are) played back.
 - When "Line1&2" is selected, the LINE 1 greeting will be played first.
 - The display will return to the function list. To return to the stand-by mode, press **EXIT** or wait for 60 seconds.

To erase the recorded greeting message

Repeat the checking procedure above, then press **ERASE** while the message is being played.

- The unit will answer a call with a pre-recorded greeting for the line(s).
- You cannot erase the recorded greetings for LINE 1 and LINE 2 at one time even if you select "Line1&2" in step 4. Only the greeting message which is being played can be erased.

Flash Memory Message Backup

Messages are stored indefinitely on a "flash memory" IC chip and will not be affected by power failures. All of the messages are saved until you erase them.



Selecting the Caller's Recording Time

You may select the caller's recording time of each line as either "1min (1 minute)", "Vox (unlimited)" or "G.O.(greeting only)". Both lines are preset to "Vox".

1 Press **FUNCTION/EDIT**.

```
→Date and time
Answer line
Greeting record
-Function list-
```

2 Rotate **JOG DIAL** until "Recording time" is selected.

```
Number of rings
→Recording time
Remote code
-Function list-
```

- The arrow points to "Recording time".

3 Press **SEND/SET**.

```
Recording time
:Line1
SET=Next
```

4 Rotate **JOG DIAL** to select the desired line, "Line1" or "Line2".

```
Recording time
:Line2
SET=Next
```

5 Press **SEND/SET** (Next key).

- The current setting is displayed.

1min: 1 minute

G.O.: Greeting only

Vox: Unlimited

```
Recording time
Line2:Vox
SET=Save
```

6 Rotate **JOG DIAL** until the desired setting is displayed.

```
Recording time
Line2:1min
SET=Save
```

7 Press **SEND/SET** (Save key).

- A long beep sounds and the setting is saved.
- The display will return to the function list. To program the other line, start from step 3: To return to the stand-by mode, press **EXIT** or wait for 60 seconds.

```
Recording time
Line2:1min
```

If you select "G.O.", the unit will answer a call with the greeting message, then hang up. The unit will not record any incoming messages.

➔ Preparing the Answering System

Date and Time Adjustment

Voice Date/Time Stamp: During playback, a synthesized voice will announce the date and time when each message was recorded.

If you subscribe to a Caller ID service (p. 32), please read the information on the next page.

1 Press **FUNCTION/EDIT**.

```
→Date and time
Answer line
Greeting record
-Function list-
```

2 Rotate **JOG DIAL** until "Date and time" is selected.

```
→Date and time
Answer line
Greeting record
-Function list-
```

- The arrow points to "Date and time".

3 Press **SEND/SET**.

- The current setting is displayed.

```
Date:1998.01.01
Time:12:00 AM
SET=Save
```

4 ① Enter the current year by using a 4-digit number, then the month and day using 2-digit number. (Ex. To set Sep. 5, 1998, enter "1998 09 05".)

```
Date:1998.09.05
Time:09:30 AM
SET=Save
```

② Enter the current time (hour and minute) by using a 4-digit number. (Ex. To set 9:30, enter "0930".)

- If you enter a wrong number, rotate **JOG DIAL** to move the cursor to the incorrect number. Then make the correction.

5 Press **1** (AM/PM key) to select "AM" or "PM".

```
Date:1998.09.05
Time:09:30 AM
1=AM/PM SET=Save
```



6 Press **SEND/SET** (Save key).

Date:1998.09.05
Time:09:30 PM

- A long beep sounds and the clock starts working.
 - The display will return to the function list. To return to the stand-by mode, press **EXIT** or wait for 60 seconds.
 - If 3 beeps sound, the entered date/time is not correct. Start from step 4.
-
- When you enter the hour in step 4, you cannot enter numbers greater than 12. **Do not use military time.** (To set 13:00, enter "0100" and select "PM" by pressing **1**.)
 - The accuracy of the clock is approximately ± 45 seconds a month at room temperature.

If a power failure occurs or the AC adaptor is disconnected for more than 30 minutes, the adjusted date/time will be erased.

For Caller ID service users (p. 32)

- The date and time will be adjusted by the incoming Caller ID information after the first ring. In this case, the year will not be adjusted. To adjust the year, follow steps 1 to 3 on page 22. Enter the current year by using a 4-digit number, then press **SEND/SET**.
- The Caller ID information will re-set the clock if the adjusted time and/or date is incorrect.
- The Caller ID information will automatically set the clock ahead at the beginning of summer and back at the beginning of winter.

➔ Preparing the Answering System

Selecting the Number of Rings

You may select the number of rings before the answering system answers a call, from "2" to "7" or "T.S. (Toll Saver)". Both lines are preset to "T.S."

1 Press **FUNCTION/EDIT**.

```
→Date and time
Answer line
Greeting record
-Function list-
```

2 Rotate **JOG DIAL** until "Number of rings" is selected.

- The arrow points to "Number of rings".

```
→Number of rings
Recording time
Remote code
-Function list-
```

3 Press **SEND/SET**.

```
Number of rings
:Line1
SET=Next
```

4 Rotate **JOG DIAL** to select the desired line, "Line1" or "Line2".

```
Number of rings
:Line2
SET=Next
```

5 Press **SEND/SET** (Next key).

- The current setting is displayed.
2-7: The unit will answer after the selected number of rings.
T.S.: Toll Saver*

```
Number of rings
Line2:T.S.
SET=Save
```

6 Rotate **JOG DIAL** until the desired number of rings is displayed.

```
Number of rings
Line2:6
SET=Save
```

7 Press **SEND/SET** (Save key).

- A long beep sounds and the setting is saved.
- The display will return to the function list. To program the other line, start from step 3. To return to the stand-by mode, press **EXIT** or wait for 60 seconds.

```
Number of rings
Line2:6
```

*Toll Saver

When you call the unit from a touch tone telephone:

If the unit answers on the 2nd ring, there is at least one new message.

If the unit answers on the 4th ring, there are no new messages.

Hang up when you hear the 3rd ring. This will save you the toll charge for the call.

Setting the CPC (Calling Party Control) Function

The CPC function is preset to "A". If you use a call waiting service, set to "B", or the call waiting tone will disconnect someone leaving a message.

1. Press **FUNCTION/EDIT**.
2. Rotate **JOG DIAL** until "CPC function" is selected.
3. Press **SEND/SET**.
 - The current setting, "A" or "B", is displayed.
4. Rotate **JOG DIAL** until the desired mode is displayed.
5. Press **SEND/SET** (Save key).
 - The display will return to the function list. To return to the stand-by mode, press **EXIT** or wait for 60 seconds.

Setting the Greeting Monitor Function

When your greeting message is being played to the caller, you can also listen to it through the speaker. To listen to your greeting, set to "On". Your phone comes from the factory set to "Off".

1. Press **FUNCTION/EDIT**.
2. Rotate **JOG DIAL** until "Greet. monitor" is selected.
3. Press **SEND/SET**.
 - The current setting, "Off" or "On", is displayed.
4. Rotate **JOG DIAL** until the desired mode is displayed.
5. Press **SEND/SET** (Save key).
 - The display will return to the function list. To return to the stand-by mode, press **EXIT** or wait for 60 seconds.

Making Calls

The unit will automatically select a free line which is not being used by the parallel connected telephone when you lift the handset to make a call. (To change the line selection, see page 52.) To hang up, place the handset on the cradle.

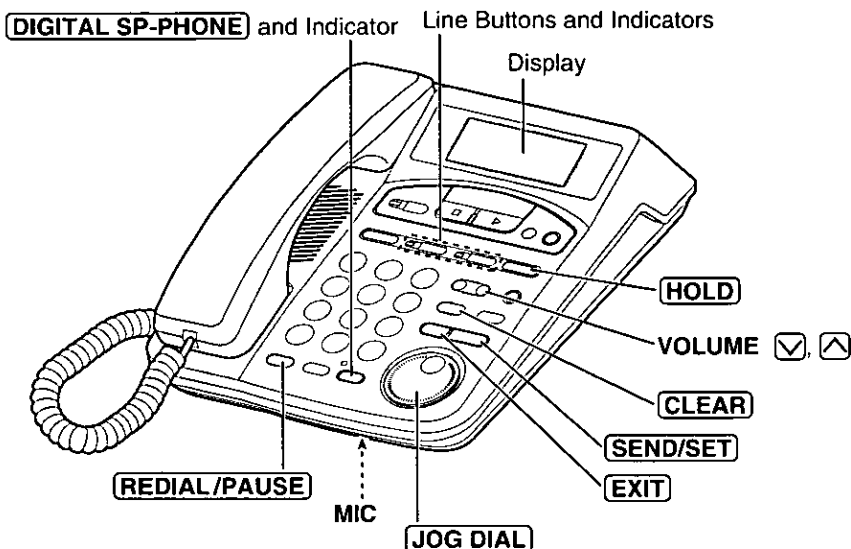

Using the digital duplex speakerphone

- 1 Press **DIGITAL SP-PHONE**.
 - The indicator lights.
 - A free line is automatically selected and the line indicator lights green.
- 2 Dial a phone number.
 - The dialed number is displayed.
 - If you misdial, hang up and dial again.
 - After a few seconds, the display will show the length of the call and selected line.
- 3 When the other party answers, talk into the **MIC** (microphone).
- 4 To hang up, press **DIGITAL SP-PHONE**.
 - The indicator lights go out.
 - The display will return to the stand-by mode.

```
>
```

```
>111-2222
```

```
7:37PM JUN. 1  
0-00-00  
LINE1
```

```
7:39PM JUN. 1  
0-01-30  
LINE1
```

• In step 1, you may select a line manually by pressing the line button instead of **DIGITAL SP-PHONE**.



To dial after confirming the entered number

1 Enter a phone number.

- If you misdial, press **CLEAR**.
Digits are erased from the right.
- To cancel, press **EXIT**.

111-2222[]

2 Lift the handset or press **DIGITAL SP-PHONE**.

- After a few seconds, the display will show the length of the call and selected line.
- You can also press **SEND/SET** or a line button instead of **DIGITAL SP-PHONE**.

>111-2222

7:37PM JUN. 1

0-00-00
LINE1

3 When the other party answers, talk into the handset or **MIC**.

4 To hang up, place the handset on the cradle or press **DIGITAL SP-PHONE**.

- The display will return to the stand-by mode.

7:39PM JUN. 1

0-01-30
LINE1

Telephone

To adjust the handset volume (4 levels) or the speaker volume (8 levels)

While using the handset or speakerphone, press **VOLUME** or .

Ex. Handset volume level: 4
Speaker volume level: 8

- The display shows the volume level.
- After a few seconds, the display will return to the length of the call.

Low High

Handsfree Digital Duplex Speakerphone

The digital duplex speakerphone enhances your telephone conversation. For best performance, please note the following:

- Use the speakerphone in a quiet room.
- Talk alternately with the caller.
- If the caller complains that your voice is hard to hear, press **VOLUME** to decrease the speaker volume.
- If the other party's voice from the speaker cuts in/out during a conversation, press **VOLUME** to decrease the speaker volume.
- You can switch to the handset by lifting up. To switch back to the speakerphone, press **DIGITAL SP-PHONE**.

➔ Making Calls

To redial the last number dialed

Lift the handset or press **[DIGITAL SP-PHONE]** ➔ press **[REDIAL/PAUSE]**.

To redial after confirming the numbers in the redial list

The unit automatically stores the last 5 numbers dialed into the redial list.

1. Press **[REDIAL/PAUSE]**.

- The display shows the last number dialed.

321-5555

-Redial list-

2. If necessary, rotate **[JOG DIAL]** until the desired number is selected.

- To search from the most recent to oldest number, rotate to the right.
To search from the oldest to most recent number, rotate to the left.
- To cancel, press **[EXIT]**.

3. Lift the handset or press **[DIGITAL SP-PHONE]**.

- You can also press **[SEND/SET]** or a line button instead of **[DIGITAL SP-PHONE]**.

To clear a number in the redial list, press **[REDIAL/PAUSE]** ➔ rotate **[JOG DIAL]** until the desired number is selected ➔ press **[CLEAR]**.

To put a call on hold

Press **[HOLD]**.

- The line indicator flashes green.
- If you are using the handset, you may place it on the cradle.

To release the hold

Press the line button.

- If another phone is connected on the same line, you can also release the hold by lifting its handset.

What the line indicator means

Off	The line is free.
On (green)	You are using the line.
On (red)	Someone else is using the line on the parallel connected telephone. The answering system is recording a message.
Flashing (green)	A call is on hold.
Flashing (red)	A call is being received.

Answering Calls

When a call is being received, the unit rings and the called line indicator flashes red. You can answer a call by simply lifting the handset. The line is automatically selected. (To change the line selection, see page 52.)

If you subscribe to a Caller ID service, the calling party information will be displayed after the first ring (p. 32). Please wait until the second ring to answer a call in order to view the Caller ID information.

Using the digital duplex speakerphone

- 1 Press **DIGITAL SP-PHONE**.
 - The indicator lights.
 - The called line indicator lights green.
- 2 Talk into the **MIC** (microphone).
- 3 To hang up, press **DIGITAL SP-PHONE**.
 - The indicator lights go out.

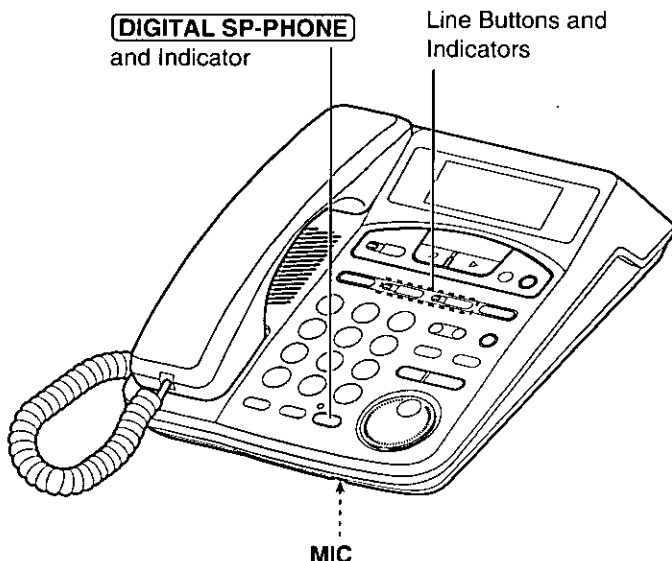

- You may answer a call by pressing the line button instead of **DIGITAL SP-PHONE**.
- When the ringer volume is set to "Off", the selected line(s) will not ring (p. 15).

Using the Other Line During a Conversation

During a conversation, if the other line indicator flashes red, an incoming call is being received on the line. You can answer the second call while holding the first call. You can also make a call without terminating the first call. If you subscribe to a Caller ID service, the second caller's information will be displayed when a call is being received on the other line (p. 32).

Ex: If you are using LINE 1

1 Press **HOLD** to put the first call (LINE 1) on hold.

```
7:37PM JUN. 1
0-00-50
LINE1
```

- The LINE 1 indicator flashes.

2 Press the other line button (LINE 2) to make or answer the second call.

```
7:37PM JUN. 1
0-00-58 0-00-00
LINE1 LINE2
```

- The LINE 2 indicator lights green.

3 To return to the first call (LINE 1), press the line button for the first call (LINE 1).

```
7:38PM JUN. 1
0-01-30
LINE1
```

- The second call is terminated.

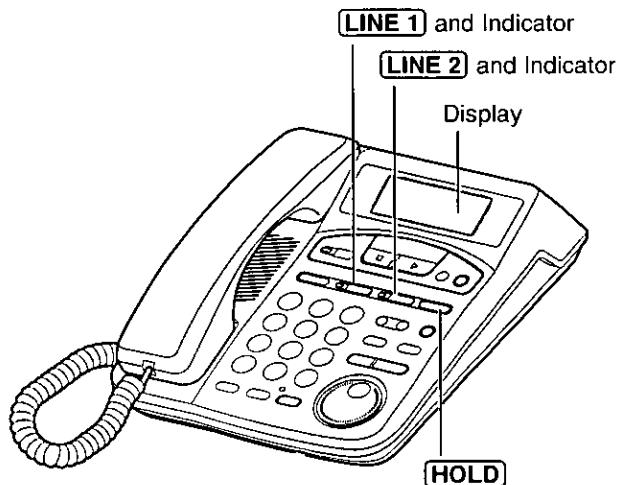

- To hold the second call in step 3, press **HOLD** before pressing the line button of the first call.
- You may be informed if another call arrives on the other line during a conversation by two tones (incoming call tone). For this setting, see page 53.

Conference Call

While having a conversation on one line, you can make or answer a second call on the other line and then combine both calls together to make a conference call.

Ex: If you are using LINE 1

1 Press **HOLD** to put the first call (LINE 1) on hold.

7:37PM JUN. 1

0-00-50
LINE1

- The LINE 1 indicator flashes.

2 Press the other line button (LINE 2) to make or answer a second call.

7:37PM JUN. 1

0-00-58 0-00-00
LINE1 LINE2

- The LINE 2 indicator lights green.

3 When the second call is connected, press **CONF** to make a conference call.

7:38PM JUN. 1

0-01-28 0-00-30
LINE1 LINE2

- Both line indicators light.

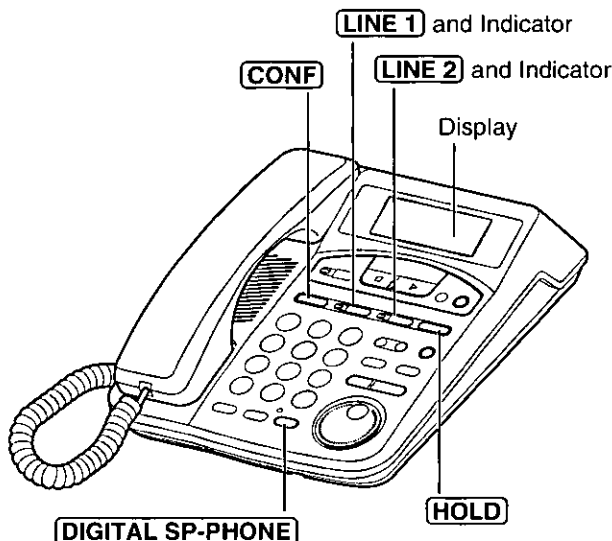

During a conference call:

- To hang up both lines, place the handset on the cradle or press **DIGITAL SP-PHONE**.
- To hang up only one line, press the line button you want to continue talking with.
- To put both lines on hold, press **HOLD**.
To talk with only one caller, press the corresponding line button.
To resume both lines, press **CONF**.

Caller ID Service

This unit is compatible with a Caller ID service offered by your telephone company. After you subscribe to a Caller ID service, the calling party information will be displayed after the first ring.

The unit can record a total of 30 different caller's information for both lines combined, including the time and date received, the number of times called and the called line, in the Caller List. The Caller List information is sorted by the most recent to oldest call.

Using the list, you can automatically call back a caller. You can store the caller's name and number from the Caller List into the directory.

If you subscribe to a Visual Call Waiting (Call Waiting ID) service, when a second call is received on the same line, the new caller's name and phone number will be displayed (p. 50).

How caller information is displayed when a call is received

The display shows the caller's name, number and the called line after the first ring.

TINA ROBINSON
1-000-222-3333

LINE1



After you answer the call, the display will show the length of the call.

10:00AM JUN.10
0-00-00
LINE1

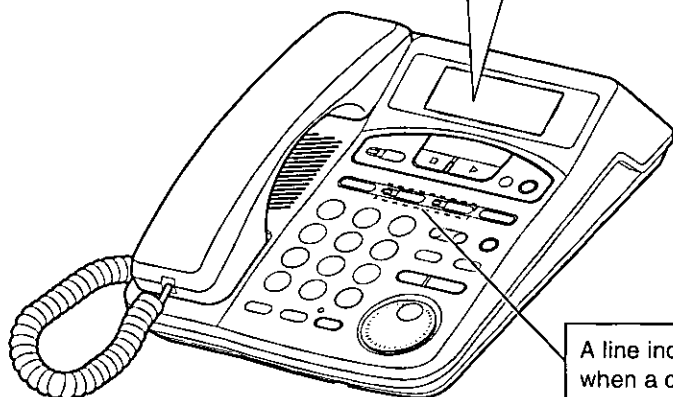

A line indicator will flash red when a call is being received.

- While both lines are receiving calls, each caller's information will be displayed alternately.

- In some cases, caller information cannot be displayed. The display will show as follows.

The caller dialed from an area which does not provide a Caller ID service.

Out of area

The caller has requested not to display their information.

Private caller

- If your unit is connected to a PBX which does not support Caller ID services, you cannot access those services.
- In some calling areas, the name display service may not be available. For further information, please contact your telephone company.

To check the number of new calls

Press **CALLER ID**.

- The display on the right is shown, then after a few seconds, the number of new calls on both lines will be displayed.

Ex. You have received 10 new calls on LINE 1 and 12 new calls on LINE 2.

CALLER ID key
=Select line
JOG=Listing



New calls	
10	12
LINE1	LINE2

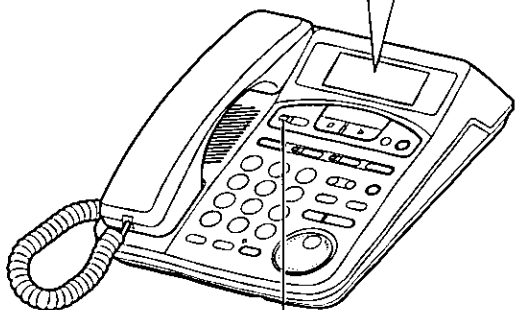

The CALLER ID indicator flashes when new calls have been received.

Using the Caller List

Viewing the Caller List

To confirm who has called you, follow the steps below.

- 1 Press **CALLER ID** to enter the list.
 - "CALLER ID key=Select line
JOG=Listing" is displayed, then the number of new calls on both lines will be shown.
- 2 a) To view callers on both lines, go to step 3.
b) To view callers on either line, press **CALLER ID** repeatedly to select the line.
 - Each time you press the button, the line will change.
- 3 Rotate **JOG DIAL**.
 - To search from the most recent to oldest call, rotate to the right.
 - To search from the oldest to most recent call, rotate to the left.
 - To move between callers, rotate **JOG DIAL**.
- 4 To exit the list, press **EXIT**.
 - The display will return to the stand-by mode.

New calls	
10	12
LINE1	LINE2

Ex. LINE 1 is selected.

New calls	
10	
LINE1	

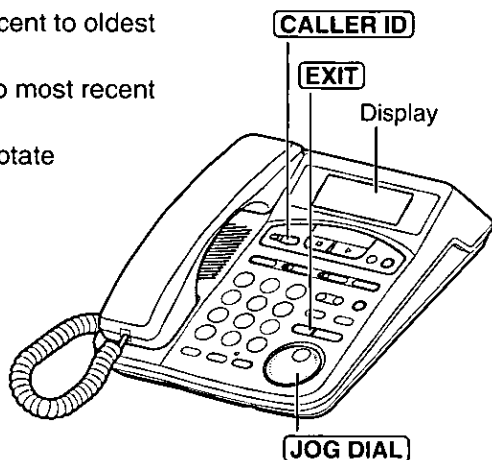

- Once NEW calls have been checked, they will be listed as OLD.
- When you answer a call or call back, the caller information will be listed as OLD.
- If "No items stored" is displayed in step 1, the Caller List is empty. The display will return to the stand-by mode.
- If more than one call is received from the same caller, the date and time of the last call will be recorded. Also, when the same caller calls again, the OLD call entry will be deleted.
- When viewing calls on both lines, they will be displayed in chronological order.



Ex. When you search from the most recent call on both lines:

Press **CALLER ID**.

- "CALLER ID key=Select line JOG=Listing" is displayed.

New calls

1 1
LINE1 LINE2

Rotate **JOG DIAL** to the right.

* JACK SMITH
111-2222
3:10P JUN. 10
LINE1 New

*If the caller does not have name information, the display will only show the phone number.

Rotate **JOG DIAL** to the right.

* KEVIN PARKER
333-4444
11:50A JUN. 10 X3
New LINE2

Rotate **JOG DIAL** to the right.

End of new calls

Rotate **JOG DIAL** to the right.

* NANCY BROWN
222-3333
1:54A JUN. 9 X2
LINE2

Rotate **JOG DIAL** to the right.

E n d

To return to the previous caller, rotate **JOG DIAL** to the left.

Rotate **JOG DIAL** to the right.

To exit the Caller List, press **EXIT**.
• The display will return to the stand-by mode.

Display signification:

- New: You have not checked the caller information, answered the call or called back the caller.
- X2-X9: The number of times they called (up to 9).

Calling Back from the Caller List

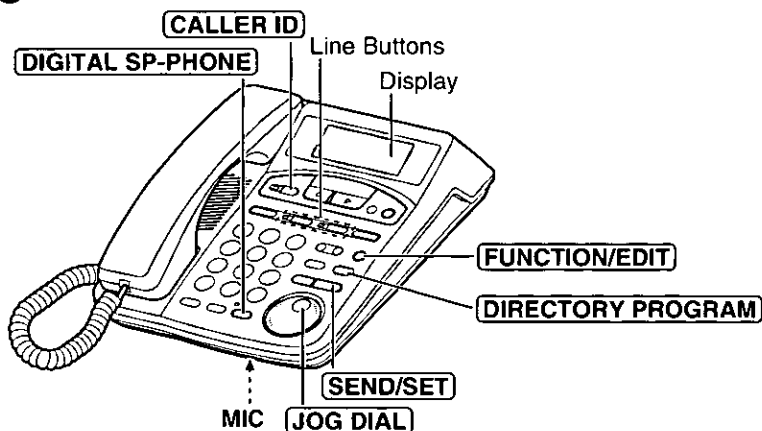

- 1 Press **CALLER ID** to enter the list.
 - "CALLER ID key=Select line JOG=Listing" is displayed, then the number of new calls on both lines will be shown.
- 2 a) To view callers on both lines, go to step 3.
b) To view callers on either line, press **CALLER ID** repeatedly to select the line.

```
New calls
      10      12
LINE1  LINE2
```

Ex. LINE 2 is selected.

```
New calls
                        12
                        LINE2
```

- 3 Rotate **JOG DIAL** until the desired caller is displayed.
- 4 Lift the handset or press **DIGITAL SP-PHONE**.
 - The displayed phone number is dialed automatically.
 - You can also press **SEND/SET** or a line button instead of **DIGITAL SP-PHONE**.

```
JACK SMITH
111-2222
3:10P JUN.10
      New  LINE2
```

```
JACK SMITH
>111-2222
```

- 5 When the other party answers, talk into the handset or **MIC**.
- 6 To hang up, place the handset on the cradle or press **DIGITAL SP-PHONE**.

- In some cases, you may have to edit the number before dialing (p. 37). (Ex. You may have to add "1" for long distance calls.)
If you did not store your area code (p. 16), the edited number will not be saved in the Caller List.
- If a phone number is not displayed in the caller information, you cannot call back that caller.



Editing the Caller's Phone Number

The unit can edit a phone number into one of 4 patterns.

- 1 Press **CALLER ID** to enter the list.
 - "CALLER ID key=Select line JOG=Listing" is displayed, then the number of new calls on both lines will be shown.
- 2 a) To view callers on both lines, go to step 3.
b) To view callers on either line, press **CALLER ID** repeatedly to select the line.

New calls	
10	12
LINE1	LINE2

Ex. LINE 1 is selected.

New calls	
10	
LINE1	

- 3 Rotate **JOG DIAL** until the desired caller is displayed.

FRED PARKER
321-5555
3:10P JUN.10
LINE1 New

- 4 Press **FUNCTION/EDIT** to select a pattern. Each time you press **FUNCTION/EDIT**, the number is rearranged into one of 4 different patterns.

- (a) 1 - Phone no.
- (b) 1 - Area code - Phone no.
- (c) Area code - Phone no.
- (d) Phone no.

- The order in which patterns (a) - (d) are displayed depends on which pattern the telephone number is displayed in step 3.

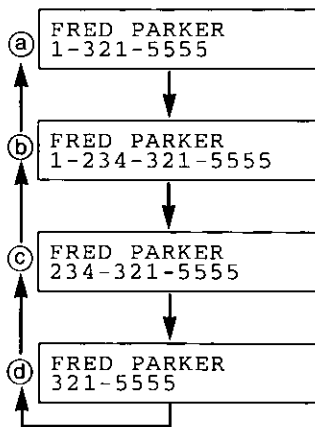

- 5 After you edit the number into the desired pattern, you can continue with calling back or storing procedures.

To call back, lift the handset or press **DIGITAL SP-PHONE** (p. 36).

To store the caller's name and number in the directory, press **DIRECTORY PROGRAM**, then follow the instructions on the display (see page 38, from step 4).

➔ Using the Caller List

Storing the Caller List Information in the Directory

You can store names and numbers that are in the Caller List into the directory. You can also select a separate ring tone for callers by selecting "Private ring" (p. 42).

- 1 Press **CALLER ID** to enter the list.
 - "CALLER ID key=Select line JOG=Listing" is displayed, then the number of new calls on both lines will be shown.
- 2 a) To view callers on both lines, go to step 3.
b) To view callers on either line, press **CALLER ID** repeatedly to select the line.

```
New calls
      10      12
  LINE1  LINE2
```

- 3 Rotate **JOG DIAL** until the desired caller is displayed.
 - If the number requires editing, see page 37.

Ex. LINE 1 is selected.

```
New calls
      10
  LINE1
```

- 4 Press **DIRECTORY PROGRAM**.

```
JACK SMITH
111-2222
3:10P JUN.10
LINE1 New
```

- 5 Press ***** (Yes key).

```
Save directory ?
JACK SMITH
111-2222
*=Yes          #=No
```

If the caller information you want to store does not have name information, just follow the instructions on the display.

- a) If you do not need to enter a name, press **#** (NO key).

```
Private ring ?
*=Yes          #=No
```

- b) If you need to enter a name, press ***** (Yes key). Then enter the name (p. 44). When finished, press **SEND/SET** (Next key).

```
Save name ?
111-2222
*=Yes          #=No
```

```
Private ring ?
*=Yes          #=No
```

```
Enter name >
...
JOG=←→  SET=Next
```



6 a) If you do not want to select private ring, press **#** (NO key).

```
JACK SMITH
111-2222
*** Saved ***
```

b) If you want to select private ring, press ***** (YES key).

```
JACK SMITH
111-2222
Private
*** Saved ***
```

- A long beep sounds and the programming is completed.
- The display will return to step 3. You can continue storing another item. To return to the stand-by mode, press **EXIT** or wait for 60 seconds.

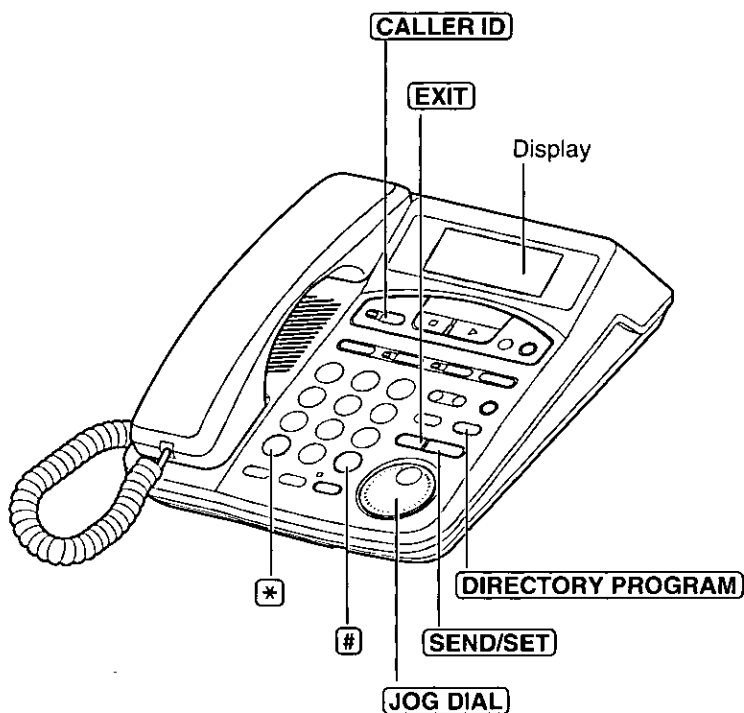

Telephone

- If the display shows "Directory full" in step 4, the display will return to step 3. Press **EXIT** to exit the list. To clear other stored items from the directory, see page 49.
- You cannot store caller information in the directory when a phone number is not displayed.

➔ Using the Caller List

Clearing the Caller List Information

You can clear some or all of the entries in the Caller List.

To clear a specific caller from the Caller List

- 1 Press **CALLER ID** to enter the list.
 - "CALLER ID key=Select line
JOG=Listing" is displayed, then the number of new calls on both lines will be shown.
- 2 a) To view callers on both lines, go to step 3.
b) To view callers on either line, press **CALLER ID** repeatedly to select the line.

```
New calls
      10      12
  LINE1    LINE2
```

Ex. LINE 1 is selected.

```
New calls
      10
  LINE1
```

- 3 Rotate **JOG DIAL** until the caller you want to clear is displayed.

```
TOM REAGAN
444-5555
3:10P JUN.10
LINE1
```

- 4 Press **CLEAR**.
 - A long beep sounds and the information is erased.
 - In a few seconds, the display will show the previous caller information.
 - To return to the stand-by mode, press **EXIT** or wait for 60 seconds.

```
C l e a r
```

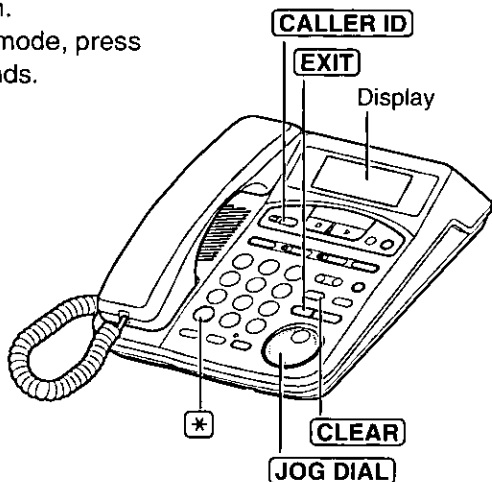

To clear all of the entries on the desired line(s) in the Caller List

- 1 Press **CALLER ID** to enter the list.
 - "CALLER ID key=Select line JOG=Listing" is displayed, then the number of new calls on both lines will be shown.
- 2 a) To clear callers on both lines, go to step 3.
b) To clear callers on either line, press **CALLER ID** repeatedly to select the line.
- 3 Press **CLEAR**.
- 4 Press ***** (YES key).
 - A long beep sounds and all of the entries for the selected line(s) are erased.
 - The display will return to the stand-by mode.

New calls	
0	12
LINE1	LINE2

Ex. LINE 1 is selected.

New calls	
0	
LINE1	

LINE1
All clear ?
*=Yes #=No

LINE1
All clear

- You can also clear all of the entries by setting the display to "End of new calls", "End of old calls" or "End" by rotating **JOG DIAL** after selecting the line in step 2.

Using the Directory

You can store up to 100 names and phone numbers in the directory. All directory items are sorted by the first word in alphabetical order.

Using the directory, you can make a call by selecting a name on the display.

You can also select a separate ring tone for items by selecting "Private ring" during storing. "Private ring" will sound after the first ring.

Storing Names and Numbers in the Directory

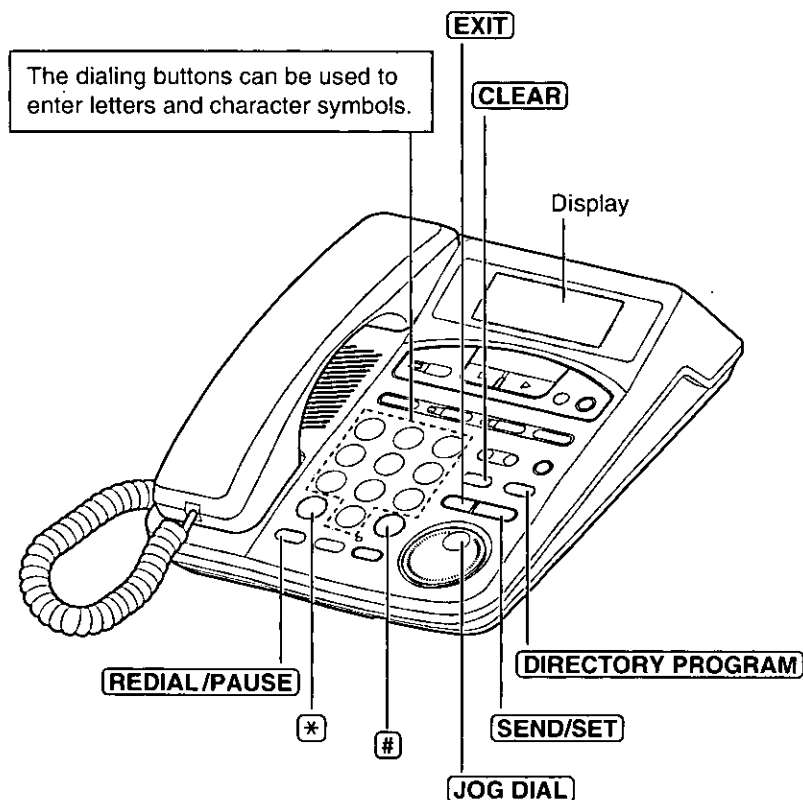



- 1 Press **DIRECTORY PROGRAM**.
- The display shows the number of remaining directory items, then "Enter name".

```
Program new
      directory
100
items remaining
```

```
Enter name >
{ }
JOG=<=> SET=Next
```

- 2 Enter a name up to 16 characters with the dialing buttons, **JOG DIAL**, ***** (←) or **#** (→).
- See the steps for entering names and symbols (p. 44).

```
Enter name >
Tom Jones
JOG=<=> SET=Next
```

- 3 Press **SEND/SET** (Next key).

```
Enter phone no. >
{ }
```

- 4 Enter a phone number up to 16 digits.
- If you misdial, press **CLEAR**. The digit at the cursor is erased.
 - You can use **JOG DIAL** to move the cursor to the right or left.

```
Enter phone no. >
0987654321;
JOG=<=> SET=Next
```

- 5 Press **SEND/SET** (Next key).

```
Private ring ?
* = Yes      # = No
```

- 6 a) If you do not want to select private ring, press **#** (NO key).
- b) If you want to select private ring, press ***** (YES key).

```
Tom Jones
098-765-4321
*** Saved ***
```

```
Tom Jones
098-765-4321
Private
*** Saved ***
```

- A long beep sounds and the item is saved.
 - The display will return to step 1. You can continue storing another item.
 - To return to the stand-by mode, press **EXIT** or wait for 60 seconds.
- If a pause is required for dialing, **REDIAL/PAUSE** can be stored in a phone number counting as one digit (p. 51) in step 4.
 - You can exit the programming mode any time by pressing **EXIT**.
 - If the display shows "Directory full" in step 1, the display will return to the stand-by mode. Erase other stored items from the directory (p. 49).

➔ Using the Directory

Steps for Entering Names and Symbols

The dialing buttons can be used to enter letters and character symbols.

Pressing each button selects a character as shown below.

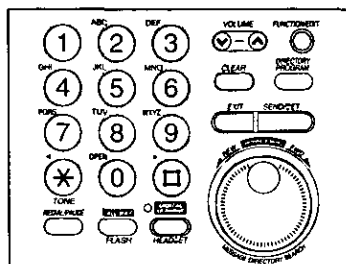

Keys	Number of times you press each key										
	1	2	3	4	5	6	7	8	9	10	11
①	#	&	'	()	*	,	-	.	/	1
②	A	B	C	a	b	c	2				
③	D	E	F	d	e	f	3				
④	G	H	I	g	h	i	4				
⑤	J	K	L	j	k	l	5				
⑥	M	N	O	m	n	o	6				
⑦	P	Q	R	S	p	q	r	s	7		
⑧	T	U	V	t	u	v	8				
⑨	W	X	Y	Z	w	x	y	z	9		
⑩	0	Blank									
JOG DIAL	To move the cursor [] to the right or left.										
*	To move the cursor [] to the left.										
#	To move the cursor [] to the right.										

If you make a mistake while entering a name

Use **JOG DIAL** to move the cursor to the incorrect character, then make the correction. You can also use * (←) or # (→) to move the cursor for corrections. You can delete one character by pressing **CLEAR**.



For example, to enter "Tom Jones":

- 1 Press **DIRECTORY PROGRAM**.
 - The display shows the number of remaining directory items, and then the display on the right is shown.
- 2 Press **8**.
- 3 Press **6** six times, then press **#** (**→**) to move the cursor to the right.
- 4 Press **6** four times.
- 5 Press **#** (**→**) twice to enter a blank.
- 6 Press **5**.
- 7 Press **6** six times, then press **#** (**→**) to move the cursor to the right.
- 8 Press **6** five times.
- 9 Press **3** five times.
- 10 Press **7** eight times.
- 11 When finished, press **SEND/SET** (NEXT key).
 - To continue entering a phone number, see page 43, from step 4.

```
Enter name >
[ ]
JOG=←→ SET=Next
```

```
Enter name >
T
JOG=←→ SET=Next
```

```
Enter name >
To[ ]
JOG=←→ SET=Next
```

```
Enter name >
Tom
JOG=←→ SET=Next
```

```
Enter name >
Tom [ ]
JOG=←→ SET=Next
```

```
Enter name >
Tom J
JOG=←→ SET=Next
```

```
Enter name >
Tom Jo[ ]
JOG=←→ SET=Next
```

```
Enter name >
Tom Joh[ ]
JOG=←→ SET=Next
```

```
Enter name >
Tom Jones
JOG=←→ SET=Next
```

```
Enter name >
Tom Jones[ ]
JOG=←→ SET=Next
```

```
Enter phone no. >
[ ]
```

Telephone

➔ Using the Directory

Finding Items in the Directory

Rotate **JOG DIAL** until the desired name is displayed.

- All directory items are sorted in the following order:

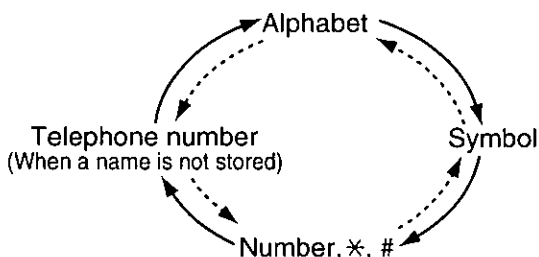

Rotate to the left. Rotate to the right.

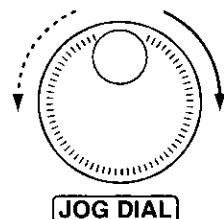

To search for a name by the initial

- 1 Rotate **JOG DIAL** to enter the directory.

```
ANN
456-7890
-Directory list-
```

- 2 Press the dialing button of the first letter of the desired name repeatedly (see the Index table below).

```
Fanny
123-4567
-Directory list-
```

Ex. To find "Frank", press **3** repeatedly until the first item under "F" is displayed.

- 3 Rotate **JOG DIAL** to the right until the desired name is displayed.

```
Frank
321-5555
-Directory list-
```

Keys	Index	Keys	Index
1	Other symbols, 1	6	M, N, O, 6
2	A, B, C, 2	7	P, Q, R, S, 7
3	D, E, F, 3	8	T, U, V, 8
4	G, H, I, 4	9	W, X, Y, Z, 9
5	J, K, L, 5	0	0

- You can leave the directory any time by pressing press **EXIT**.



Dialing from the Directory

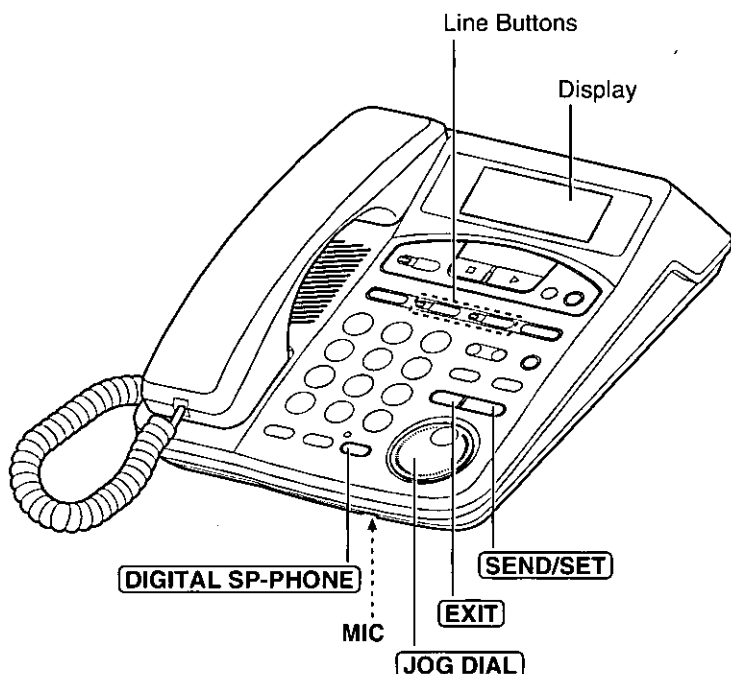

1 Rotate **JOG DIAL** until the desired name is displayed.

- You can also find the item by searching by the initial (p. 46).
- To exit the directory, press **EXIT**.

Mary 456-7890 -Directory list-

2 Lift the handset or press **DIGITAL SP-PHONE**.

- The number is dialed automatically.
- You can also press **SEND/SET** or a line button instead of **DIGITAL SP-PHONE**.

Mary >456-7890

3 When the other party answers, talk into the handset or **MIC**.

7:39PM JUN. 1 0-00-00 LINE1

4 To hang up, place the handset on the cradle or press **DIGITAL SP-PHONE**.

➔ Using the Directory

Changing an Item in the Directory

1 Rotate **JOG DIAL** until the desired item is displayed.

- You can also find the item by searching by the initial (p. 46).

```
Jane  
123-4567  
-Directory list-
```

2 Press **FUNCTION/EDIT**.

- If you do not need to change the name, go to step 4.

```
Enter name >  
Jane  
JOG=(←) SET=Next
```

3 Edit the name by using the dialing buttons, **JOG DIAL**, ***** (←) or **#** (→) (p. 44) up to 16 characters.

```
Enter name >  
Jane Walker  
JOG=(←) SET=Next
```

4 Press **SEND/SET** (Next key).

- If you do not need to change the number, go to step 6.

```
Enter phone no.>  
1234567  
JOG=(←) SET=Next
```

5 Enter the new number up to 16 digits.

- You can use **JOG DIAL** to move the cursor for corrections.
- The digit at the cursor is erased by pressing **CLEAR**.

```
Enter phone no.>  
0981234567  
JOG=(←) SET=Next
```

6 Press **SEND/SET** (Next key).

```
Private ring ?  
.  
*-Yes #No
```

7 a) If you do not want to select the private ring, press **#** (NO key).

```
Jane Walker  
098-123-4567  
*** Saved ***
```

b) If you want to select the private ring, press ***** (YES key).

- A long beep sounds and the changed item is saved.
- The display will return to step 1. You can continue editing another item.
- To return to the stand-by mode, press **EXIT** or wait for 60 seconds.

```
Jane Walker  
098-123-4567  
Private  
*** Saved ***
```

- You can exit the programming mode any time by pressing **EXIT**.

Clearing an Item from the Directory

1 Rotate **JOG DIAL** until the desired name is displayed.

- You can also find the item by searching by the initial (p. 46).

Ex. To erase "Helen"

```
Helen
333-4444
-Directory list-
```

2 Press **CLEAR**.

```
Clear directory?
Helen
333-4444
*=Yes      #=No
```

3 Press ***** (Yes key).

- A long beep sounds and the item is erased.
- In a few seconds, the display will show the next item.
- To return to the stand-by mode, press **EXIT** or wait for 60 seconds.

```
C l e a r
```

- You can exit the programming mode any time by pressing **EXIT**.

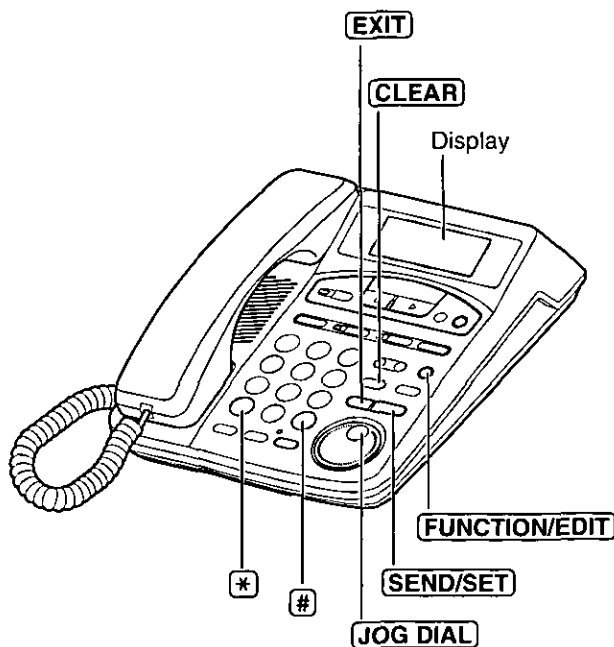

Special Features

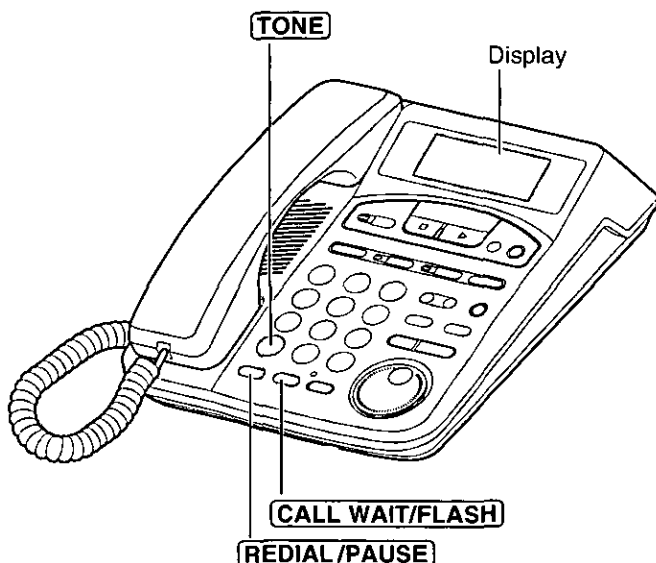

For Call Waiting Service Users

During a conversation, if another call is being received on the same line, you will hear a call-waiting tone.

Press **CALL WAIT/FLASH** to answer the second call.

- The first call is put on hold.
- To return to the first caller, press **CALL WAIT/FLASH** again.
- The call waiting service is not available when:
 - the answering system is recording a message on the same line,
 - you are having a conference call (p. 31), or
 - the parallel connected telephone on the same line is in use.

Visual Call Waiting (Call Waiting ID) Service

Visual Call Waiting (Call Waiting ID) Service allows the unit to display the second caller's information. After you hear a call-waiting tone while talking, the unit will display

"- Call waiting -", and the caller's name and phone number.

- Call waiting -
Nancy Brown
1-000-222-3333
LINE1

- Please contact your telephone company for details and availability in your area.

Temporary Tone Dialing

(For Rotary or Pulse Service Users)

Press **TONE** before entering access numbers which require tone dialing.

- The dialing mode changes to tone. You can enter numbers to access an answering service, electronic banking service, etc. When you hang up, the mode will return to pulse.

How to Use the PAUSE Button

(For Analog PBX Line/Long Distance Service Users)

We recommend you press **REDIAL/PAUSE** if a pause is required for dialing with a PBX or to access a long distance service.

Ex. Line access number **9** (PBX)

9 → **REDIAL/PAUSE** → Phone number

- Pressing **REDIAL/PAUSE** once creates a 3.5 second pause. This prevents misdialing when you redial or dial a stored number.
- Pressing **REDIAL/PAUSE** more than once increases the length of the pause between numbers.

Programmable Functions

Line Selection

The unit will automatically select a free line which is not being used by the parallel connected telephone when you make a call. Also the unit will select the called line when you answer a call. To change the line selection, program as follows.

Be sure that the handset is on the cradle, the AC adaptor is connected and the DIGITAL SP-PHONE indicator light is off.

1 Press **FUNCTION/EDIT**.

```
→Date and time
Answer line
Greeting record
-Function list-
```

2 Rotate **JOG DIAL** until "Line selection" is selected.

```
→Line selection
Dialing mode
Area code
-Function list-
```

- The arrow points to "Line selection".

3 Press **SEND/SET**.

- The current selection is displayed.

Line 1: Line 1 will be selected.

Line 2: Line 2 will be selected.

Auto: A free line will be selected (LINE 1 has priority) when making a call. The called line is automatically selected when answering a call (factory preset).

```
Line selection
:Auto
SET=Save
```

4 Rotate **JOG DIAL** until the desired line selection is displayed.

```
Line selection
:Line2
SET=Save
```

5 Press **SEND/SET** (Save key).

- A long beep sounds and the line selection is saved.
- The display will return to the function list. To return to the stand-by mode, press **EXIT** or wait for 60 seconds.

```
Line selection
:Line2
```

- You can exit the programming mode any time by pressing **EXIT**.
- Any line can be selected manually regardless of the mode selected in step 4 by pressing the line button.

Incoming Call Tone

While one line is being used, you may be informed if another call has arrived on the other line by two tones. This incoming call tone can be set/deleted by programming. Your phone comes from the factory set to "Off".

Be sure that the handset is on the cradle, the AC adaptor is connected and the DIGITAL SP-PHONE indicator light is off.

1 Press **FUNCTION/EDIT**.

```
→Date and time
Answer line
Greeting record
-Function list-
```

2 Rotate **JOG DIAL** until "Incoming call.." is selected.

```
Dialing mode
Area code
→Incoming call..
-Function list-
```

- The arrow points to "Incoming call..".

3 Press **SEND/SET**.

```
Incoming call
tone:Off
SET=Save
```

- The current setting is displayed.
On: The incoming call tone will be heard as long as the other line rings.
2: The incoming call tone will only be heard 2 times.
Off: The incoming call tone will not be heard (factory preset).

4 Rotate **JOG DIAL** until the desired setting is displayed.

```
Incoming call
tone:On
SET=Save
```

5 Press **SEND/SET** (Save key).

```
Incoming call
tone:On
```

- A long beep sounds and the setting is saved.
- The display will return to the function list. To return to the stand-by mode, press **EXIT** or wait for 60 seconds.

- You can exit the programming mode any time by pressing **EXIT**.

Automatic Answering Operation

When the unit answers a call, a greeting message is played and the caller's message is recorded. While recording, "- Answering -" will be displayed.

- The total recording time (including the greeting message) is **about 33 minutes**. If messages are recorded in noisy rooms, the time may be shortened up to 9 minutes.
- A maximum of 64 messages (including the greeting message) can be recorded.

Setting the Unit to Answer Calls

First, select the line(s) you want to record, then turn on the answering system.

Selecting the line(s) for the answering system

Your phone comes from the factory set to "Line1&2". If you want to turn on either line's answering system, select "Line1" or "Line2" by programming.

Be sure that the handset is on the cradle, the AC adaptor is connected and the DIGITAL SP-PHONE indicator light is off.

1 Press **FUNCTION/EDIT**.

```
→Date and time
Answer line
Greeting record
-Function list-
```

2 Rotate **JOG DIAL** until "Answer line" is selected.

```
Date and time
→Answer line
Greeting record
-Function list-
```

- The arrow points to "Answer line".

3 Press **SEND/SET**.

- The current setting is displayed.

```
Answer line
:Line1&2
SET=Save
```

4 Rotate **JOG DIAL** to select the desired line(s), "Line1&2", "Line1" or "Line2".

```
Answer line
:Line1
SET=Save
```

5 Press **SEND/SET** (Save key).

- A long beep sounds and the line(s) is(are) selected.

```
Answer line
:Line1
```



6 Press **EXIT**.

- “**ANSWER**” will be displayed for the selected line(s) as follows:

“Line1&2” is selected.

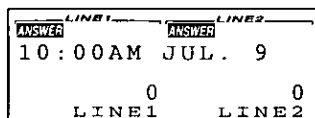

“Line1” is selected.

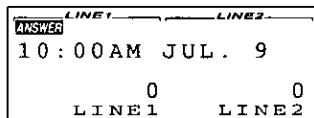

“Line2” is selected.

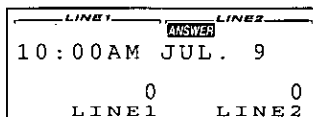

- You can exit the programming mode any time by pressing **EXIT**.

Turning on the answering system

Press **ANSWER ON**.

- The button lights.
- “Answer set” and the selected line(s) will be announced.

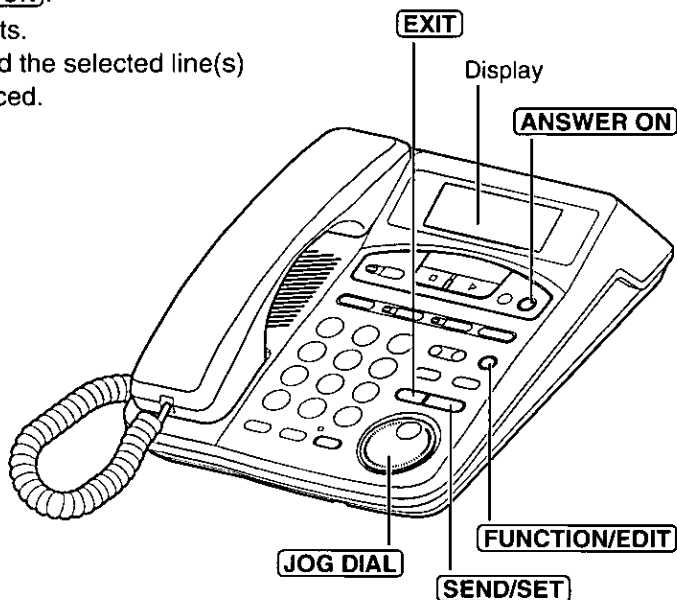

Answering System

- The unit will announce the remaining recording time if it is less than 5 minutes.
- If you hear “Memory is full”, “Message full” is displayed and the **ANSWER ON** button light flashes rapidly, erase some or all of the messages (p. 60).
- You can also turn on the answering system remotely (p. 76, 77).

➔ Automatic Answering Operation

The unit will not answer an incoming call while:

- you are answering the other line with the speakerphone, or
- the answering system is in use (recording a message, playing back a message, etc.).

To let the unit answer the incoming call, you must hang up the first call or stop using the answering system.



To turn off the answering system

Press **ANSWER ON** to turn off the answering system.

- The button light goes out and “Answer off” is heard.
- “**ANSWER**” remains on the display even after turning off the answering system.

Monitoring incoming calls

While a call is being recorded, you can monitor it through the speaker. To answer the call, press the called line button. The unit stops recording.

- You can adjust the monitor volume (9 levels) by pressing **VOLUME**  or .

Listening to Messages



The display shows the total number of recorded messages on each line. If the **ANSWER ON** button light and line display(s) flash, new messages have been recorded on the line(s).

Listening to only the new messages

Press **NEW MESSAGE** briefly.

- The unit announces the number of new messages **on the line(s) which have "ANSWER" displayed** (see pages 54 and 55) and plays them back.

Listening to all of the recorded messages

Press and hold **NEW MESSAGE** until a short beep sounds.

- The unit announces the number of messages **on the line(s) which have "ANSWER" displayed** (see pages 54 and 55) and plays them back.

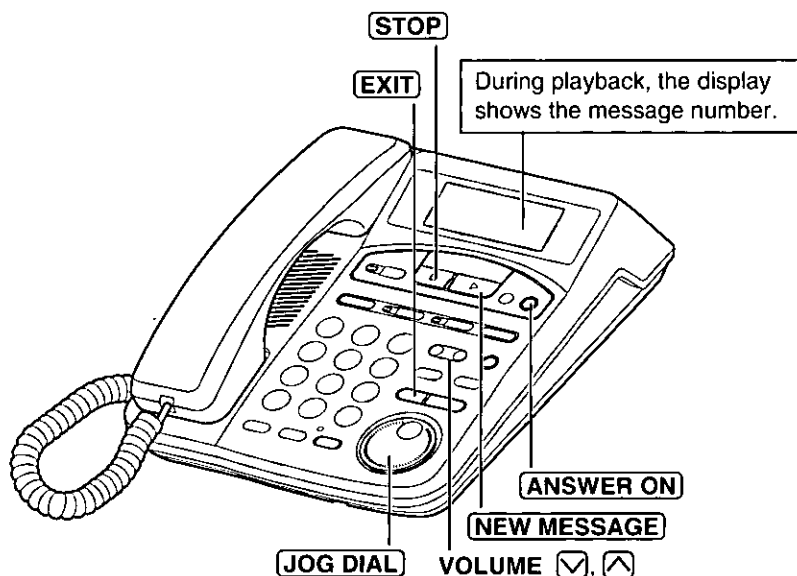

To adjust the speaker volume (9 levels):

While using the answering system, press **VOLUME** or .

- The display shows the volume level.

When the answering system for both lines is turned on:

- The messages are played back in chronological order.
- The corresponding line display will flash when a message on that line is being played.

➔ Listening to Messages

During playback

To repeat the message	Rotate [JOG DIAL] to the left. (If you rotate within 5 seconds of playback, the previous message will be played.)
To skip the message	Rotate [JOG DIAL] to the right. The next message is played.
To stop the operation	Press [STOP] . <ul style="list-style-type: none">To resume playback, press [NEW MESSAGE]. To return to the stand-by mode, press [EXIT].If you subscribe to a Caller ID service, you can call back the displayed caller by pressing [SEND/SET] (p. 59).

Listening to messages on the desired line(s)

To listen to new messages:

1. Press **[NEW MESSAGE]**.
2. While the unit is announcing the number of messages, press **[NEW MESSAGE]** repeatedly until the desired line is displayed.
 - The unit announces the number of new messages on the selected line(s) and plays them back.

To listen to all of the messages:

1. Press **[NEW MESSAGE]**.
2. While the unit is announcing the number of messages, press **[NEW MESSAGE]** repeatedly until the desired line is displayed. Then within one second, press and hold **[NEW MESSAGE]** until a short beep sounds.
 - The unit announces the number of messages on the selected line(s) and plays them back.

LINE 1 & 2 is selected.

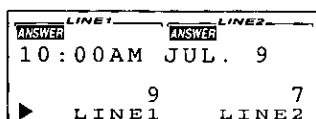

LINE 1 is selected.

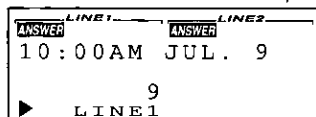

LINE 2 is selected.

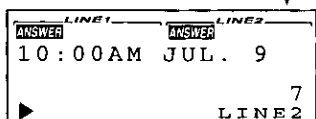

The line(s) that can be answered by the answering system will not change even if you select another line in step 2.

For Caller ID service users (p. 32)

- During playback, the display will show the called line and caller's name and/or number whose message is being played.

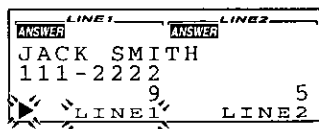

To call back the displayed number:

During playback, lift the handset or press **SEND/SET** to turn on the speakerphone.

- The unit stops playback and automatically dials the displayed phone number.

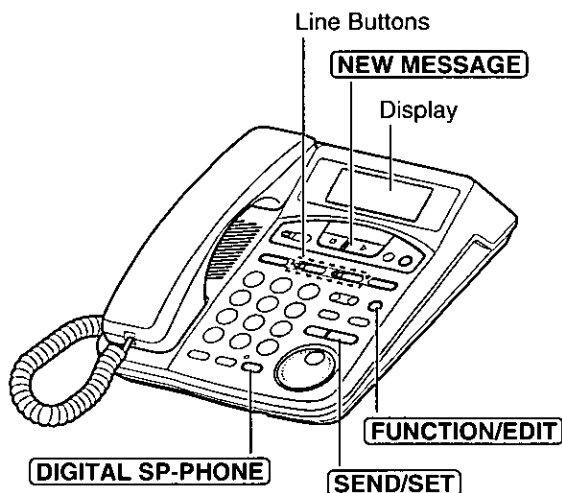

- You can also press **DIGITAL SP-PHONE** or a line button instead of **SEND/SET** to call back.
 - If you need to edit the number before calling back, press **FUNCTION/EDIT** repeatedly until the desired pattern is selected (p. 37).
 - To resume playback, press **NEW MESSAGE**.
- After you listen to the new incoming messages, the calls will be listed as OLD in the Caller ID Caller List (p. 34).

Erasing Messages

The unit will announce the remaining recording time after playback, if it is less than 5 minutes. New messages cannot be recorded when:

- “Memory is full” is heard.
- “Message full” is displayed.
- the **ANSWER ON** button light flashes rapidly.

Erase some or all of the messages. We recommend you erase unnecessary messages after each playback.

Erasing a specific message

Press **ERASE** while the message you want to erase is being played.

- The unit erases the message.
- A short beep will sound and the unit will continue to play the next message.

Erasing all of the messages on the line(s) which have “**ANSWER**” displayed

All of the recorded messages on the line(s) selected (p. 54, 55) can be erased at one time. The greeting message(s) will not be erased.

1 Press **ERASE**.

- “Press ERASE button again to erase all messages.” is heard.

2 Within 5 seconds, press **ERASE** again.

- A long beep sounds and “Line 1, no messages” and/or “Line 2, no messages” is heard.
- The display shows “0” for the line(s).
- The display will return to the stand-by mode.

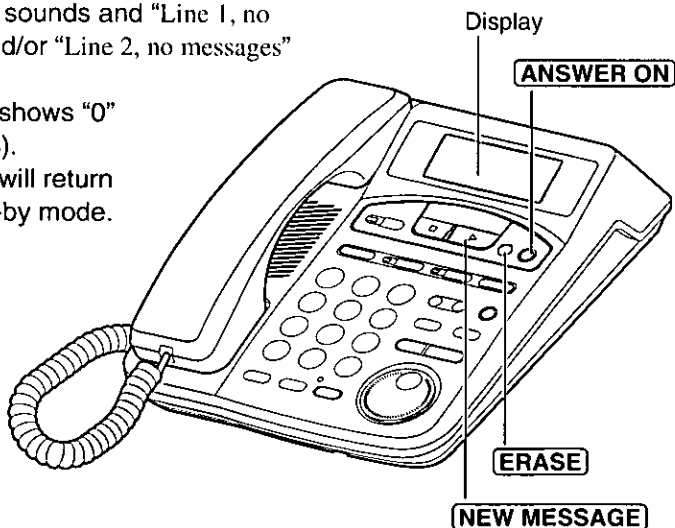

- The information in the caller list will not be erased.
To clear the Caller List information, see page 40.

Erasing all of the messages on the desired line(s)

All of the recorded messages on the desired line(s) can be erased at one time. The greeting message(s) will not be erased.

1. Press **NEW MESSAGE**.
2. While the unit is announcing the number of messages, press **NEW MESSAGE** repeatedly until the desired line(s) is(are) displayed on the bottom.

Ex. LINE 1 is selected.

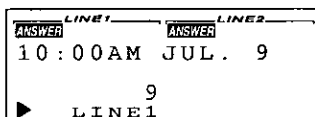

3. Press **ERASE** while the unit is announcing the number of messages on the desired line(s).
 - “Press ERASE button again to erase all messages.” is heard.
4. Within 5 seconds, press **ERASE** again.
 - A long beep sounds and “Line 1, no messages” and/or “Line 2, no messages” is heard.
 - The display shows “0” for the line(s).
 - The display will return to the stand-by mode.

Recording Your Telephone Conversation

You may record your telephone conversation in memory. This is not available when using the speakerphone.

- 1 During a conversation with the handset, press **FUNCTION/EDIT**.

```
2way recording ?
SET=Yes  EXIT=No
```

- 2 Press **SEND/SET** (Yes key).

```
7:38PM JUN. 1
- Recording -
01-30
LINE1
```

- 3 Continue your conversation.

- 4 When you finished recording the conversation, press **SEND/SET**.

```
7:45PM JUN. 1
0-09-50
LINE1
```

- A beep sounds.
- The recorded conversation is stored as a new message. To listen, press **NEW MESSAGE** briefly (p. 57, 58).
- If 6 beeps sound, the conversation was not recorded.

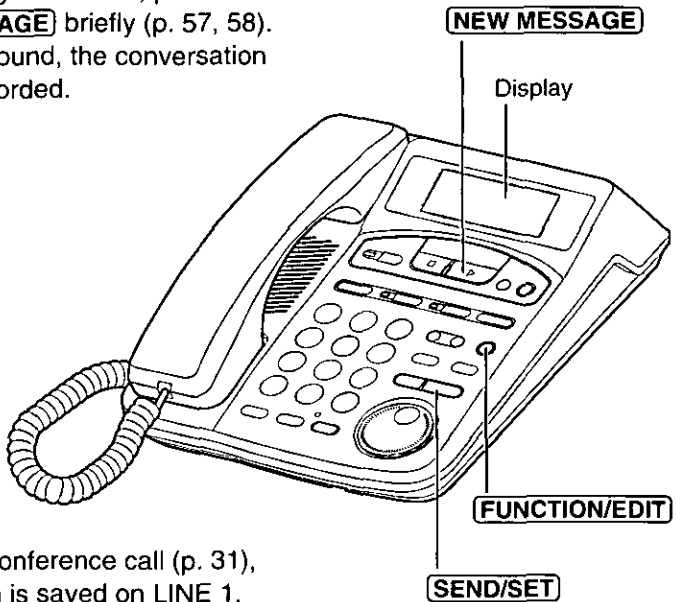

- If you record a conference call (p. 31), the conversation is saved on LINE 1.

Many states have imposed regulations on the manner in which 2-way telephone conversations may be recorded, so you should inform the other party that the conversation is being recorded. Consult your local telephone company for further information.



This feature allows you to alert your pager when the unit records an incoming message or receives a Caller ID call (p. 67). You can retrieve the message from a touch tone telephone (p. 70). If you subscribe to a Caller ID service, the caller's telephone number will be displayed on your pager. First, program the following settings (p. 63–67), then set the unit to call a pager.

Be sure that the handset is on the cradle, the AC adaptor is connected and the DIGITAL SP-PHONE indicator light is off.

Storing the Pager Number

If you use a 1-800 pager number, see the next page for the storing procedure.

1 Press **FUNCTION/EDIT**.

```
→Date and time
Answer line
Greeting record
-Function list-
```

2 Rotate **JOG DIAL** until "Pager number" is selected.

- The arrow points to "Pager number".

```
CPC function
→Pager number
Pager on/off
-Function list-
```

3 Press **SEND/SET**.

- "Enter pager no." is displayed.
- The current set number is displayed, if it was stored beforehand.

```
Enter pager no.>
□
SET=Save
```

4 Enter your pager number, then press **REDIAL/PAUSE** twice.* Enter the access code, if required by your pager company, and then press **REDIAL/PAUSE** twice again.*

- If you misdial, press **CLEAR**. Digits are erased from the right.
- You can enter a total of 44 digits.

```
12343215555PP□
SET=Save
```

5 Press **SEND/SET** (Save key).

- A long beep sounds and the number is saved.
- The display will return to the function list.

```
12343215555PP
*** Saved ***
```

To return to the stand-by mode, press **EXIT** or wait for 60 seconds.

* Pager companies require a delay after the pager number and/or the access code is dialed. Contact your pager company regarding the required pause time. Pressing **REDIAL/PAUSE** once creates a 3.5 second delay and counts as one digit.

- If the line(s) has(have) rotary or pulse service, press ***** between the pager number and **REDIAL/PAUSE** in step 4.

➔ Pager Call

Storing a 1-800 pager number

If you use a 1-800 pager number with a PIN code, store the pager number as follows.

1 Press **FUNCTION/EDIT**.

```
→Date and time  
Answer line  
Greeting record  
-Function list-
```

2 Rotate **JOG DIAL** until "Pager number" is selected.

```
CPC function  
→Pager number  
Pager on/off  
-Function list-
```

• The arrow points to "Pager number".

3 Press **SEND/SET**.

```
Enter pager no.>  
..  
SET=Save
```

- "Enter pager no." is displayed.
- The current set number is displayed, if it was stored beforehand.

4 ① Enter the 1-800 pager number, then press **REDIAL/PAUSE** 3 times.*

```
18002343215555PP  
P..  
SET=Save
```

② Enter the PIN code, then press **REDIAL/PAUSE** twice.*

```
18002343215555PP  
P1111222PP..  
SET=Save
```

- If you misdial, press **CLEAR**. Digits are erased from the right.
- You can enter a total of 44 digits.

5 Press **SEND/SET** (Save key).

```
18002343215555PP  
P1111222PP  
*** Saved ***
```

- A long beep sounds and the number is saved.
- The display will return to the function list. To return to the stand-by mode, press **EXIT** or wait for 60 seconds.

* Pager companies require a delay after the pager number and the PIN code are dialed. Contact your pager company regarding the required pause time. Pressing **REDIAL/PAUSE** once creates a 3.5 second delay and counts as one digit.

- If the line(s) has(have) rotary or pulse service, press ***** between the pager number and **REDIAL/PAUSE** in step 4.
- Alphanumeric voice dispatch pager service will not work with this function.



Storing Your Home Telephone Number

Store your home telephone number. Then the number will be displayed on your pager when your family wants you to call home. (See the useful information on page 66.)

1 Press **FUNCTION/EDIT**.

```
→Date and time
Answer line
Greeting record
-Function list-
```

2 Rotate **JOG DIAL** until "Home number" is selected.

```
Pager mode
→Home number
Line selection
-Function list-
```

- The arrow points to "Home number".

3 Press **SEND/SET**.

```
Enter phone no.>
[ ]
SET=Save
```

- "Enter phone no." is displayed.
- The current set number is displayed, if it was stored beforehand.

4 Enter your home telephone number up to 10 digits.

```
Enter phone no.>
222-333-4444]
SET=Save
```

- If you misdial, press **CLEAR**. Digits are erased from the right.

5 Press **SEND/SET** (Save key).

```
Enter phone no.>
222-333-4444
*** Saved ***
```

- A long beep sounds and the number is saved.
- The display will return to the function list. To return to the stand-by mode, press **EXIT** or wait for 60 seconds.

- Your pager will also display your home number when the unit receives a call from an area which does not provide the Caller ID service or the caller requests not to show their information. Please call home to check who alerted your pager.

➔ Pager Call

To confirm the stored pager and home numbers

1. Press **FUNCTION/EDIT**.
2. Rotate **JOG DIAL** until "Calling pager" is selected.
3. Press **SEND/SET**.

- The unit selects a free line and dials the stored pager number.
- The pager beeps, and displays your home number and "11".
- If the pager does not beep or does not display your home number and "11", store the pager and home numbers again (p. 63–65).

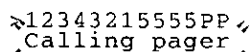

12343215555PP
Calling pager

Useful Information

Your family can let you know when they want you to call home by performing the above procedure.

* What "11" means

When your unit alerts your pager, "11" will be displayed after the caller's telephone number. "11" will not be displayed when another phone alerts your pager.

Ex. When the unit records a caller's message whose number is "2345678":
"234567811" will be displayed on your pager. If you selected the "Received call" mode (p. 67) and a caller did not leave a message, "00" will be displayed instead of "11".

Ex. When the caller whose number is "2345678" alerts your pager directly:
"2345678" will be displayed on your pager.

To clear the stored pager number

1. Press **FUNCTION/EDIT**.
2. Rotate **JOG DIAL** until "Pager number" is selected.
3. Press **SEND/SET**.
4. Press **CLEAR**.
5. Press **SEND/SET** (Save key).
 - The pager call mode will automatically return to "Off" (p. 68).

To clear the stored home telephone number

1. Press **FUNCTION/EDIT**.
2. Rotate **JOG DIAL** until "Home number" is selected.
3. Press **SEND/SET**.
4. Press **CLEAR**.
5. Press **SEND/SET** (Save key).



Pager Mode Setting

After subscribing to a Caller ID service (p. 32), you can select one of the following pager modes. The unit will alert your pager:

after the unit records an incoming message (**Recorded MSG** mode: factory preset),

OR

each time the unit receives a Caller ID call, even if the caller does not leave a message (**Received call** mode).

If you want to change the mode, proceed as follows.

- 1 Press **FUNCTION/EDIT**.

```
→Date and time
Answer line
Greeting record
-Function list-
```

- 2 Rotate **JOG DIAL** until "Pager mode" is selected.

```
Calling pager
→Pager mode
Home number
-Function list-
```

- The arrow points to "Pager mode".

- 3 Press **SEND/SET**.

```
Pager mode
:Recorded MSG:
SET=Save
```

- The current mode is displayed.

- 4 Rotate **JOG DIAL** until the desired mode is displayed.

```
Pager mode
:Received call:
SET=Save
```

- 5 Press **SEND/SET** (Save key).

```
Pager mode
:Received call
```

- A long beep sounds and the mode is saved.
- The display will return to the function list. To return to the stand-by mode, press **EXIT** or wait for 60 seconds.

- If you select "**Received call**" and set the unit to call a pager (p. 68), the unit will alert your pager even if the answering system is not turned on.
- Even if you select "**Received call**", the unit will not alert your pager when a Caller ID call which does not have a phone number is received.

➔ Pager Call

Setting the Unit to Call a Pager

1 Press **FUNCTION/EDIT**.

```
→Date and time  
Answer line  
Greeting record  
-Function list-
```

2 Rotate **JOG DIAL** until "Pager on/off" is selected.

```
→Pager on/off  
Calling pager  
Pager mode  
-Function list-
```

3 Press **SEND/SET**.

```
Pager on/off  
:Line1  
SET=Next
```

4 Rotate **JOG DIAL** to select the desired line, "Line1" or "Line2".

```
Pager on/off  
:Line2  
SET=Next
```

5 Press **SEND/SET** (Next key).

- The current setting "Off" (factory preset) or "On" is displayed.

```
Pager on/off  
Line2:Off  
SET=Save
```

6 Rotate **JOG DIAL** until "On" is displayed.

```
Pager on/off  
Line2:On  
SET=Save
```

7 Press **SEND/SET** (Save key).

- A long beep sounds and the setting is saved.
- The display will return to the function list. To program the other line, start from step 3.
- To return to the stand-by mode, press **EXIT** or wait for 60 seconds. "**PAGER**" will be displayed for the line selected in step 4.
- If 3 beeps sound, the pager number is not stored. Store the number (p. 63, 64), then try again.

```
Pager on/off  
Line2:On
```

To turn off the pager call mode, select "Off" in step 6.

- "**PAGER**" will disappear.

-
- The line which calls your pager depends on the “Line Selection” (p. 52).
 - If you have not subscribed to a Caller ID service, the caller’s telephone number will not be displayed on your pager.

- If another message (or Caller ID call) is received before the unit alerts your pager for a previous message (or Caller ID call), the previous caller information will not be sent to your pager. Only the last call received will be sent to your pager.
- If someone else makes or answers another call with the unit or the parallel connected phone before the unit alerts your pager for a previous message (or Caller ID call), the unit will stop alerting your pager for that message (or Caller ID call).
- When you receive a caller’s telephone number in your pager but can not recognize the caller, you may have received a direct inward dial (DID) call, such as from a PBX. Please call your unit to check the caller’s message.

Remote Operation from a Touch Tone Phone

You can operate the answering system from any touch tone phone. A synthesized voice menu will guide you on how to operate the unit (p. 72).

- To skip the voice menu and operate the unit directly, see page 74.

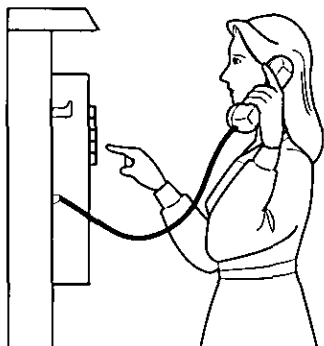

Summary of the remote operation

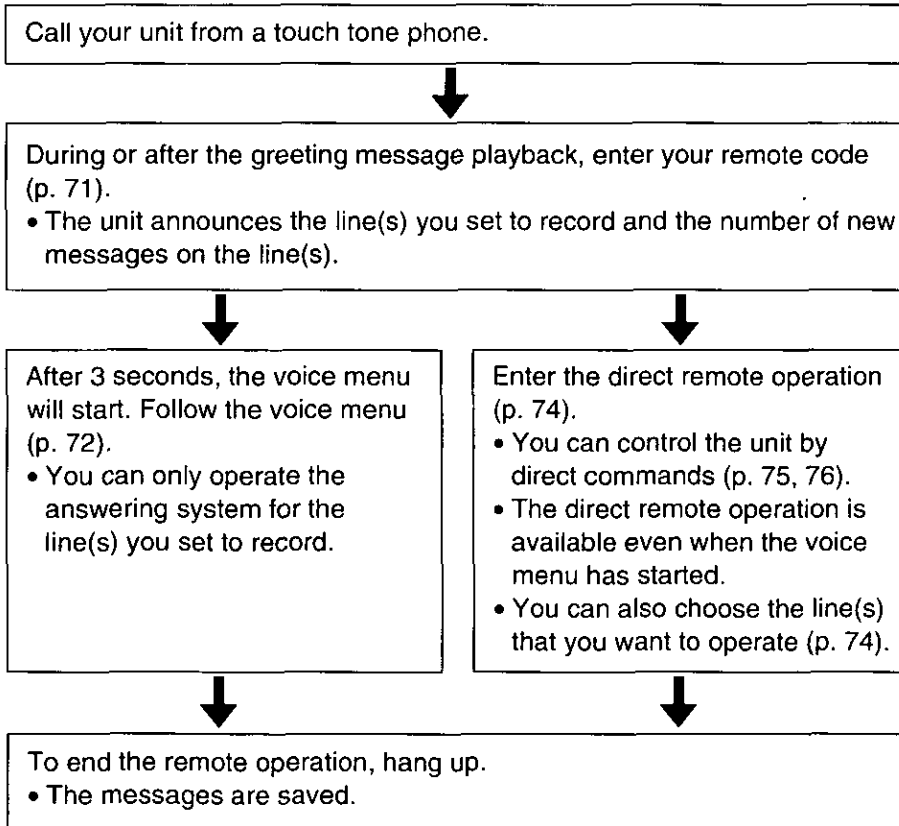



Setting the Remote Code

The remote code prevents unauthorized people from accessing your unit and listening to your messages. Choose any **3-digit number (000–999)**. The factory preset remote code is “111”. If you do not program your own remote code, you can use “111”.

Be sure that the handset is on the cradle, the AC adaptor is connected and the DIGITAL SP-PHONE indicator light is off.

- 1 Press **FUNCTION/EDIT**.

```
→Date and time
Answer line
Greeting record
-Function list-
```

- 2 Rotate **JOG DIAL** until “Remote code” is selected.

- The arrow points to “Remote code”.

```
Number of rings
Recording time
→Remote code
-Function list-
```

- 3 Press **SEND/SET**.

- The current remote code is displayed.

```
Remote code :111
SET=Save
```

- 4 Enter a remote code by using a **3-digit number (000–999)**.

- If you enter a wrong number, press **CLEAR**, then enter the correct number.

```
Remote code :123]
SET=Save
```

- 5 Press **SEND/SET** (Save key).

- A long beep sounds and the code is saved.
- The display will return to the function list.
To return to the stand-by mode, press **EXIT** or wait for 60 seconds.

```
Remote code :123
```

To clear the remote code

If you clear the code, the remote operation feature will not be available.

1. Press **FUNCTION/EDIT**.
2. Rotate **JOG DIAL** until “Remote code” is selected.
3. Press **SEND/SET**.
4. Press **CLEAR**.
 - “---” is displayed.
5. Press **SEND/SET** (SAVE key).

➔ Remote Operation from a Touch Tone Phone

Voice Menu

You can operate the answering system only for the line(s) you set to record by following the voice menu. The shaded boxes are voice prompts.

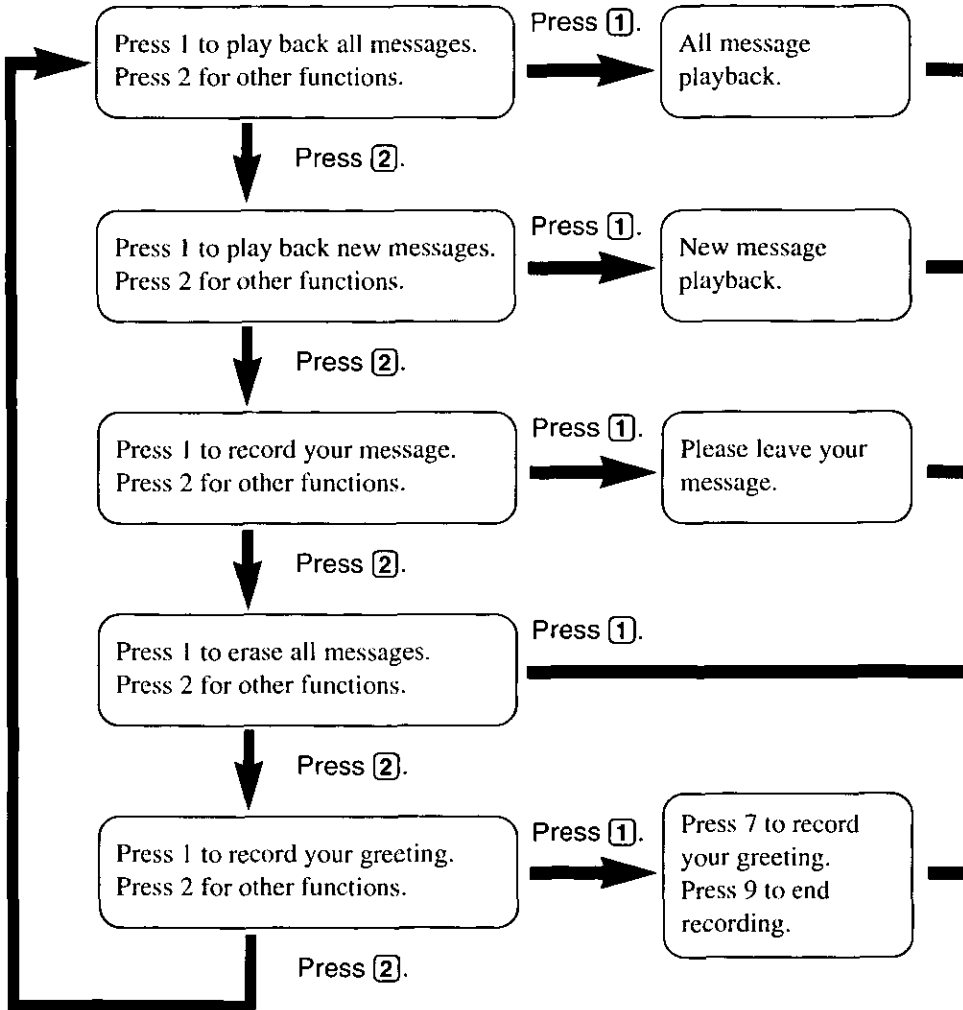



All Message Playback

All of the recorded messages on the line(s) you set to record are played back in chronological order.

At the end of the last message, the unit will announce "End of final message" and the remaining recording time if it is less than 5 minutes.

New Message Playback

Only new messages on the line(s) you set to record are played back in chronological order.

Recording a Memo Message

You can leave a personal message.

1. Talk after you hear "Please leave your message."
2. When you finish recording, hang up.

Erasing All Messages

All of the recorded messages on the line(s) you set to record are erased.

Recording a Greeting Message

You can re-record your greeting message for the line(s) you set to record.

1. Press **[7]**.
You hear a voice prompt followed by a long beep.
2. Talk after the long beep.
3. When you finish recording, press **[9]**.
4. Your greeting will be played back for confirmation.

- 3 seconds after playback, the voice menu will start from the beginning.
- If you hear "Memory is full" after playback, erase some or all of the messages (p. 75).

➔ Remote Operation from a Touch Tone Phone

Direct Remote Operation

Once you have entered the remote code, you can also control your unit by direct commands instead of using the voice menu. To end the remote operation, hang up anytime.

Summary of the direct remote operation

- 1 Select the desired line(s) after entering your remote code.
If you want to operate the answering system for the line(s) you set to record, skip to step 2.
Press **# 1** to select "LINE 1".
Press **# 2** to select "LINE 2".
Press **# 0** to select "LINE 1 and LINE 2".
 - The number of new messages on the selected line(s) is heard.



- 2 Enter the desired direct commands (p. 75, 76).
 - If you do not enter any commands, the voice menu will start (p. 72). You can also follow the voice menu to operate the answering system for the line(s) selected in step 1.
 - If you want to operate another line, repeat from step 1.



- 3 To end the remote operation, hang up.
 - The messages are saved.
 - The line(s) that can be answered by the answering system will not change even if you select another line in step 1.*

*If the answering system on for the line(s) programming was changed during the remote operation (p. 76), then the set line(s) will be turned on.

- Do not press **#** for a few seconds. Some long distance services use **#** for other purposes and these services may take priority over the remote operation.



Direct commands

NEW MESSAGE
PLAYBACK **4** • Only new messages on the selected line(s) are played back in chronological order.

ALL MESSAGE
PLAYBACK **5** • All of the messages on the selected line(s) are played back in chronological order.

REPEAT
(During playback) **1** • The current message is repeated.

SKIP
(During playback) **2** • The current message is skipped. The next message is played.

STOP
(During playback) **9** • Playback is stopped temporarily.
• To resume playback, press **9** again within 15 seconds, or the voice menu will start.

GREETING
MESSAGE
RECORDING You can re-record your greeting message for the selected line(s).

7

- A long beep sounds.



RECORD

- Talk immediately after the long beep.



9

- The recording is stopped.
- The recorded message is played.

ERASING A
SPECIFIC
MESSAGE
(During playback) *** 4** • The current message is erased.
• A short beep will sound and the next message is played.

ERASING ALL
MESSAGES *** 5** • All of the recorded messages on the selected line(s) are erased.
• A long beep and "Line 1, no messages" and/or "Line 2, no messages" are/is heard.

➔ Remote Operation from a Touch Tone Phone

ANSWERING
SYSTEM OFF

0

- “Answer off” is heard.
 - The answering system is turned off.
 - The voice menu will start. To end the remote operation, hang up. To operate the other line or both lines, select the line(s) (see below). Then enter the desired direct commands.
-

SELECTING
ANOTHER
LINE

1

- LINE 1 is selected and the number of new messages on LINE 1 is heard.

2

- LINE 2 is selected and the number of new messages on LINE 2 is heard.

0

- LINE 1 and LINE 2 are selected and the number of new messages on both lines is heard.
-

ANSWERING
SYSTEM ON
FOR THE
LINE(S)

1 8

- “Answer set line 1” is heard and the LINE 1 answering system is turned on.

2 8

- “Answer set line 2” is heard and the LINE 2 answering system is turned on.

0 8

- “Answer set line 1 and line 2” is heard and the answering system for both lines is turned on.

- If the LINE 1 (LINE 2) answering system is on and you also want to turn on the LINE 2 (LINE 1) answering system, press **# 0 8**.
-

Turning on the answering system

To turn on the answering system for the line(s) selected on pages 54 and 55, call your unit and wait for 15 rings.

- The unit will answer and the greeting message will be played.
- The answering system will turn on. Hang up or enter the remote code for other options.
- To turn on the answering system for the line which was not selected on pages 54 and 55, enter the remote code, then press **# 1 8**, **# 2 8** or **# 0 8** (p. 76).
- When turning on the answering system using a rotary or pulse service telephone, you cannot enter a remote code for other options.

Skipping the greeting message

After calling your unit, press ***** during the greeting message playback.

- The unit skips the rest of the greeting and callers can start recording their message after the long beep.

Remote Operation Card



OPERATION FROM A TOUCH TONE PHONE

Call your unit.

Enter your remote code _____

After 3 seconds, the voice menu will start.

Press **1** to use the voice feature.
OR
Press **2** to proceed with other functions.

To end the remote operation, hang up.

• When you press a button, press firmly.

Enter the direct remote operation.
1. To select LINE 1, press **#1**.
To select LINE 2, press **#2**.
To select LINE 1 and LINE 2, press **#0**.

2. Enter the desired direct commands (see the reverse side).

• If you want to operate another line, repeat from step 1.

To end the remote operation, hang up.

➔ Remote Operation Card

No.	Direct Command
1	Repeat the message
2	Skip the message
4	New message playback
5	All message playback
7	Record your greeting
9	Stop
0	Answer off
*	Greeting message skip
*4	Erase a specific message
*5	Erase all messages
#1	Select LINE 1
#2	Select LINE 2
#0	Select LINE 1 and LINE 2

No.	Direct Command
#18	Answer on for LINE 1
#28	Answer on for LINE 2
#08	Answer on for both lines

- **To turn on the answering system for the line(s) selected:**

Call your unit and wait for 15 rings.
The unit will answer, then hang up.

Wall Mounting

This unit can be mounted on a wall phone plate.

- 1 Pull down the handset hook until it locks, **so the tab holds the handset.**

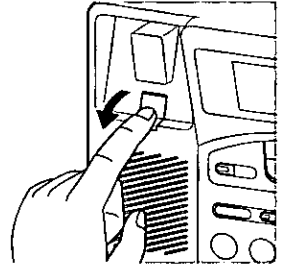

- 2 Connect the AC adaptor. Tuck the telephone line cord inside the wall mounting adaptor, then push it in the direction of the arrow.

- The word "UP" should face upward.

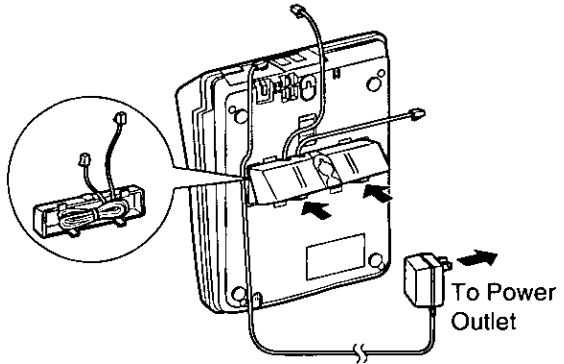

- 3 Connect the telephone line cord. Mount the unit, then slide down.

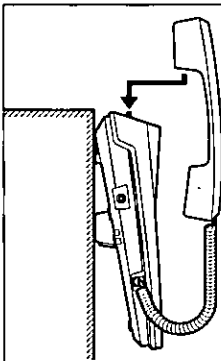
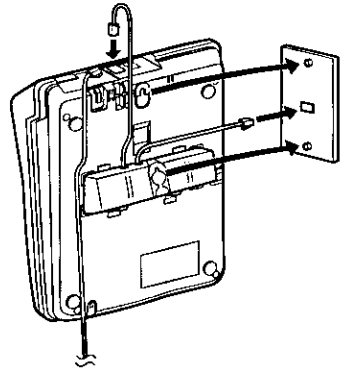

To temporarily set the handset down during a conversation, place it as shown here.

Using an Optional Headset

Plugging an optional headset into the unit provides a handsfree phone conversation.

Please use only a Panasonic KX-TCA80 or KX-TCA90 headset. To order, call 1-800-332-5368.

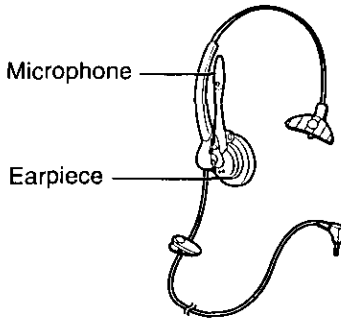

The headset illustration is a KX-TCA90.

Connecting an Optional Headset to the Unit

Connect an optional headset to the headset jack as shown below.

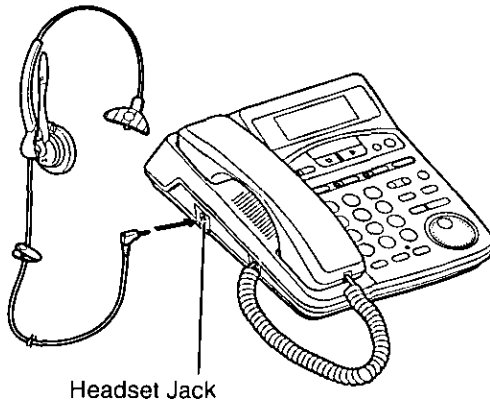

- During a power failure, you cannot use the optional headset.



Selecting the Headset/Speakerphone

When the optional headset is connected, you can select one of the following **DIGITAL SP-PHONE/HEADSET** button modes.

Each time you press **DIGITAL SP-PHONE/HEADSET**, you can switch to the optional headset or speakerphone (**SP key: SP/Head mode: factory preset**).

OR

If you do not want to use the speakerphone while the optional headset is connected, pressing **DIGITAL SP-PHONE/HEADSET** will make/answer a call or disconnect the line (**SP key: On/Off mode**).

If you want to change the mode, proceed as follows.

Be sure that the handset is on the cradle, the AC adaptor is connected and the DIGITAL SP-PHONE indicator light is off.

1. Press **FUNCTION/EDIT**.
2. Rotate **JOG DIAL** until "Headset select" is selected.
3. Press **SEND/SET**.
 - The current mode is displayed.
4. Rotate **JOG DIAL** until the desired mode is displayed.
5. Press **SEND/SET** (Save key).
 - A long beep sounds and the mode is saved.
 - The display will return to the function list. To return to the stand-by mode, press **EXIT** or wait for 60 seconds.

Headset select
SP key:SP/Head
SET=Save

Headset select
SP key:On/Off
SET=Save

How to Wear an Optional Headset

Place the headset on your head and adjust the microphone to a comfortable position.



- Place the microphone near your mouth.

➔ Using an Optional Headset

Making/Answering Calls

If you select “SP key: SP/Head mode” (p. 81)

- 1 Press **DIGITAL SP-PHONE/HEADSET** to make or answer a call.
 - The DIGITAL SP-PHONE/HEADSET indicator light flashes quickly.
 - You may also press the line button.
 - If you misdial when making a call, lift the handset and replace it back on the cradle to hang up. Then press **DIGITAL SP-PHONE/HEADSET** and dial again.

- 2 To hang up, lift the handset and replace it.

- While using the optional headset, you can switch to the speakerphone by pressing **DIGITAL SP-PHONE/HEADSET**. Each time you press the button, the call will switch to the optional headset or speakerphone.



If you select “SP key: On/Off mode” (p. 81)

- 1 Press **DIGITAL SP-PHONE/HEADSET** to make or answer a call.
 - The DIGITAL SP-PHONE/HEADSET indicator light flashes quickly.
 - You may also press the line button.
 - If you misdial when making a call, press **DIGITAL SP-PHONE/HEADSET** twice and dial again.

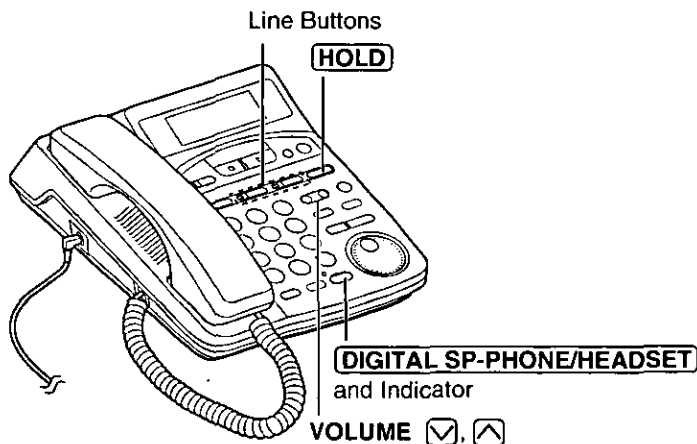
- 2 To hang up, press **DIGITAL SP-PHONE/HEADSET**.



To adjust the headset receiver volume (4 levels):

While using the headset, press **VOLUME**  or .

During a conversation with an optional headset:

- The DIGITAL SP-PHONE/HEADSET indicator light flashes quickly.
- You can switch a call to the handset by lifting it off the cradle.
- If you disconnect the optional headset, you can continue the conversation with the speakerphone.

Using the Other Line During a Conversation

- 1 Ex. If you are using LINE 1**
During a conversation, press **(HOLD)** to put the first call (LINE 1) on hold.
- 2** Press the other line button (LINE 2) to make or answer the second call.
- 3** To return to the first call, press the line button for the first call (LINE 1).

Before Requesting Help

Telephone

Problem	Remedy
The unit does not work.	<ul style="list-style-type: none">• Check the settings (p. 10–16).• Unplug the AC adaptor to reset. Plug in, then try again.
The unit does not ring.	<ul style="list-style-type: none">• The ringer volume is set to “Off” for the line(s). Set to “High” or “Low” (p. 15).• When the line is connected to a low voltage system such as a PBX, the unit will not ring. Set the line mode to “B” (p. 14).
The line indicators do not work properly.	<ul style="list-style-type: none">• Check the settings (p. 10–16).• The line mode selection is incorrect. See page 14.
The line red indicator(s) light never go(es) out.	<ul style="list-style-type: none">• Unplug the AC adaptor, then plug in.
You cannot dial by pressing DIGITAL SP-PHONE or a line button, and the DIGITAL SP-PHONE indicator light flashes quickly.	<ul style="list-style-type: none">• The telephone line cord(s) is disconnected. Check the connection(s) (p. 11–12).
You cannot program function items, such as the dialing mode.	<ul style="list-style-type: none">• Programming is not available when the handset is off the cradle or the DIGITAL SP-PHONE indicator lights.• Do not pause for over 60 seconds while programming.
When the answering system is recording a message on one line, you cannot make or answer a call with the speakerphone or the optional headset on the other line.	<ul style="list-style-type: none">• To make a call, lift the handset and press the line button whose indicator is off. To answer the call, lift the handset off the cradle.



Problem	Remedy
While a message is being recorded, you cannot answer the call by lifting the handset or pressing DIGITAL SP-PHONE .	<ul style="list-style-type: none">• To answer the call, press the line button whose indicator is flashing red.
Speech cuts occur during a conversation with the speakerphone.	<ul style="list-style-type: none">• If another call is received on the other line, the conversation will be cut off in order to receive the Caller ID information.
You cannot store a name and phone number in the directory.	<ul style="list-style-type: none">• Do not pause for over 60 seconds while storing.
You cannot search for directory items.	<ul style="list-style-type: none">• You cannot search when:<ul style="list-style-type: none">— the answering system is recording a message, or— you are recording a telephone conversation.
While programming or searching, the unit starts to ring and stops the program/search.	<ul style="list-style-type: none">• To answer the call, press the line button whose indicator is flashing red. Start from the beginning after hanging up.
During a conversation, the other line indicator flashes red and the display shows another caller's information.	<ul style="list-style-type: none">• Someone is calling you on the other line. To answer, press HOLD to put the current call on hold. Then press the line button whose indicator is flashing red (p. 30).
The unit does not display the caller name and/or phone number.	<ul style="list-style-type: none">• Other telephone equipment may be interfering with your phone. Disconnect them and try again.• Other electrical appliances connected to the same outlet may be interfering with the Caller ID information. Telephone line noise may be affecting the Caller ID information.

➔ Before Requesting Help

Telephone

Problem	Remedy
A caller called you, but the caller's information was not recorded in the Caller List.	<ul style="list-style-type: none">• If you receive two calls at the same time, only one of the Caller ID information can be recorded.• If more than one caller's information is received while;<ul style="list-style-type: none">— the answering system is recording a message on the other line, or— you are recording a conversation on the same or other line,only the last received call information can be recorded in the Caller List.
The display goes to the stand-by mode while viewing the Caller List or directory list items.	<ul style="list-style-type: none">• Do not pause for over 60 seconds while searching.
When a second call is received on the same line during a conversation, the unit does not display the new caller's name and/or phone number.	<ul style="list-style-type: none">• The line mode selection is incorrect. See page 14.
REDIAL/PAUSE does not function properly.	<ul style="list-style-type: none">• The button has a double function as either redial or pause. It will redial the last number dialed if pressed at the outset of a call (p. 28). If another number has been dialed first, it will operate as a pause button (p. 51).
You cannot have a conversation using the optional headset.	<ul style="list-style-type: none">• Make sure that the optional headset is connected properly (p. 80).• Press DIGITAL SP-PHONE/HEADSET to make or answer a call.• During a power failure, you cannot use the optional headset.



Answering system

Problem	Remedy
<p>The answering system is on, but incoming messages are not recorded.</p>	<ul style="list-style-type: none">• The recording time is set to "G.O.". Select "1min" or "Vox" (p. 21).• Memory is full. Erase some or all of the messages (p. 60).• If you receive two calls at the same time, only one of the messages can be recorded.• The line mode selection is incorrect. See page 14.
<p>"Message full" is displayed, the ANSWER ON button light flashes rapidly, and no new messages are recorded.</p>	<ul style="list-style-type: none">• Memory is full. Erase some or all of the messages (p. 60). If "Message full" is still displayed and the ANSWER ON button light flashes rapidly, erase your greeting message and re-record a shorter greeting (p. 18–20).
<p>Some incoming messages have not been recorded completely.</p>	<ul style="list-style-type: none">• Set the CPC function to "B" (p. 25).
<p>You cannot operate the answering system from a touch tone phone.</p>	<ul style="list-style-type: none">• Be sure to enter the correct remote code.• The answering system may not respond if the tones are too short to activate the unit. Press each button firmly.• The answering system is off. Turn it on (p. 77).
<p>While recording a greeting message, the unit starts to ring and stops recording.</p>	<ul style="list-style-type: none">• To answer the call, press the line button whose indicator is flashing red. The recording will be stopped halfway. Start from the beginning after hanging up.

➔ Before Requesting Help

Answering system

Problem	Remedy
During playback, the unit starts to ring and stops playback.	<ul style="list-style-type: none">• To answer the call, press the line button whose indicator is flashing red. To resume playback, press NEW MESSAGE after hanging up.
The unit does not display the caller's name and/or number whose message is being played.	<ul style="list-style-type: none">• If the caller is not stored in the caller list, the unit will not display the caller's information.
You cannot record your telephone conversation.	<ul style="list-style-type: none">• The conversation cannot be recorded when:<ul style="list-style-type: none">— using the speakerphone, or— the answering system is in use (recording a message, playing back a message, etc.).
The unit does not alert your pager.	<ul style="list-style-type: none">• The line mode selection is incorrect. See page 14.

If you cannot solve your problem, call our customer call center at 1-800-211-PANA(7262).

Important Safety Instructions



When using this unit, basic safety precautions should always be followed to reduce the risk of fire, electric shock, or personal injury.

1. Read and understand all instructions.
2. Follow all warnings and instructions marked on this unit.
3. Unplug this unit from AC outlets before cleaning. Do not use liquid or aerosol cleaners. Use a damp cloth for cleaning.
4. Do not use this unit near water, for example, near a bathtub, washbowl, kitchen sink, or the like.
5. Place this unit securely on a stable surface. Serious damage and/or injury may result if the unit falls.
6. Do not cover slots and openings on the unit. They are provided for ventilation and protection against overheating. Never place the unit near radiators, or in a place where proper ventilation is not provided.
7. Use only the power source marked on the unit. If you are not sure of the type of power supplied to your home, consult your dealer or local power company.
8. Do not place objects on the power cord. Install the unit where no one can step or trip on the cord.
9. Do not overload wall outlets and extension cords. This can result in the risk of fire or electric shock.
10. Never push any objects through slots in this unit. This may result in the risk of fire or electric shock. Never spill any liquid on the unit.
11. To reduce the risk of electric shock, do not disassemble this unit. Take the unit to an authorized servicer when service is required. Opening or removing covers may expose you to dangerous voltages or other risks. Incorrect reassembly can cause electric shock when the unit is subsequently used.
12. Unplug this unit from the wall outlet and refer servicing to an authorized servicer when the following conditions occur:
 - A. When the power supply cord or plug is damaged or frayed.
 - B. If liquid has been spilled into the unit.
 - C. If the unit has been exposed to rain or water.
 - D. If the unit does not work normally by following the operating instructions. Adjust only controls covered by the operating instructions. Improper adjustment may require extensive work by an authorized servicer.
 - E. If the unit has been dropped or physically damaged.
 - F. If the unit exhibits a distinct change in performance.

➡ Important Safety Instructions

13. During thunderstorms, avoid using telephones except cordless types.
There may be a remote risk of an electric shock from lightning.
14. Do not use this unit to report a gas leak, when in the vicinity of the leak.

SAVE THESE INSTRUCTIONS

WARNING:

TO PREVENT FIRE OR SHOCK HAZARD, DO NOT EXPOSE THIS PRODUCT TO RAIN OR ANY TYPE OF MOISTURE.

FCC and Other Information



If requested by the telephone company, inform them as follows:

FCC Registration No.(found on the bottom of the unit)

Ringer Equivalence1.0B

The particular telephone lines to which the equipment is connected.

This unit must not be connected to a coin operated line.

If you are on a party line, check with your local telephone company.

Ringer Equivalence No. (REN):

The REN is useful in determining the quantity of devices you may connect to your telephone line and still have all of those devices ring when your telephone number is called. In most, but not all areas, the sum of the REN's of all devices connected to one line should not exceed five (5.0). To be certain of the number of devices you may connect to your line, as determined by the REN, you should contact your local telephone company to determine the maximum REN for your calling area.

In the event terminal equipment causes harm to the telephone network, the telephone company should notify the customer, if possible, that service may be stopped.

However, where prior notice is impractical, the company may temporarily cease service providing that they:

- (a) Promptly notify the customer.
- (b) Give the customer an opportunity to correct the problem with their equipment.
- (c) Inform the customer of the right to bring a complaint to the Federal Communication Commission pursuant to procedures set out in FCC Rules and Regulations Subpart E of Part 68.

The Telephone Company may make changes in its communications facilities, equipment, operations or procedures, where such action is reasonably required in the operation of its business and is not inconsistent with the rules and regulations in FCC Part 68.

If such changes can be reasonably expected to render any customer terminal equipment incompatible with telephone company communications facilities, or require modification or alteration of such terminal equipment, or otherwise materially affect its use or performance, the customer shall be given adequate notice in writing, to allow the customer an opportunity to maintain uninterrupted service.

When programming emergency numbers and/or making test calls to emergency numbers:

1. Remain on the line and briefly explain to the dispatcher the reason for the call before hanging up.
2. Perform such activities in the off-peak hours, such as early morning hours or late evenings.

➡ FCC and Other Information

This device complies with Part 15 of the FCC Rules. Operation is subject to the following two conditions: (1) This device may not cause harmful interference, and (2) this device must accept any interference received, including interference that may cause undesired operation.

CAUTION:

Any changes or modifications not expressly approved by the party responsible for compliance could void the user's authority to operate this device.

Note:

This equipment has been tested and found to comply with the limits for a Class B digital device, pursuant to Part 15 of the FCC Rules. These limits are designed to provide reasonable protection against harmful interference in a residential installation. This equipment generates, uses, and can radiate radio frequency energy and, if not installed and used in accordance with the instructions, may cause harmful interference to radio communications. However, there is no guarantee that interference will not occur in a particular installation. If this equipment does cause harmful interference to radio or television reception, which can be determined by turning the equipment off and on, the user is encouraged to try to correct the interference by one or more of the following measures:

- Reorient or relocate the receiving antenna.
- Increase the separation between the equipment and receiver.
- Connect the equipment into an outlet on a circuit different from that to which the receiver is connected.
- Consult the dealer or an experienced radio/TV technician for help.

-
- **Environment** — do not place the unit in room where the temperature is less than 5°C (41°F) or greater than 40°C (104°F). Allow 10 cm (4") clearance around the unit for proper ventilation. Avoid excessive smoke, dust, mechanical vibration, shock, or direct sunlight.
 - **Routine care** — wipe the unit with a soft cloth. Do not use benzine, thinner, or any abrasive powder. When you leave the unit unused for a long period of time, unplug the AC adaptor from the outlet.
 - **If there is any trouble** — disconnect the unit from the telephone line and connect a known working phone. If the known working phone operates properly, have your unit repaired by one of the authorized Panasonic Factory Service Centers. If the known working phone does not operate properly, consult with your telephone company.

For product service

- Panasonic Servicenters are listed in the servicenter directory.
- Call 1-800-211-PANA(7262) for the location of an authorized servicenter.

When you ship the product

- Carefully pack your unit, preferably in the original carton.
- Attach a letter, detailing the symptom, to the outside of the carton.

Symptom

- Send the unit to an authorized servicenter, prepaid and adequately insured.
- Do not send your unit to the Panasonic Consumer Electronics Company listed on the back cover or to executive or regional sales offices. These locations do not repair consumer products.

**Panasonic Consumer Electronics Company,
Division of Matsushita Electric Corporation of America**
One Panasonic Way, Secaucus, New Jersey 07094

**Panasonic Sales Company,
Division of Matsushita Electric of Puerto Rico, Inc.**
Ave. 65 de Infantería, Km. 9.5, San Gabriel Industrial Park
Carolina, Puerto Rico 00985