

Panasonic

Integrated Telephone System

Operating Instructions

Model No. **KX-TS3282B**
KX-TS3282W

Pulse-or-tone dialing capability



INTERCOM

KX-TS3282W

2 LINE

Caller ID Compatible

PLEASE READ BEFORE USE AND SAVE.

Panasonic World Wide Web address: <http://www.panasonic.com>
for customers in the USA or Puerto Rico

Preparation

Basic Operation

Advanced Operation

Useful Information

Before Initial Use

Thank you for purchasing your new Panasonic integrated telephone.

Please read IMPORTANT SAFETY INSTRUCTIONS on page 67 before use. Read and understand all instructions.

Caller ID and Call Waiting Service, where available, are telephone company services. After subscribing to Caller ID, this phone will display a caller's name and phone number. Call Waiting Caller ID, which displays a second caller's name and phone number while the user is on the phone line with the first caller, requires a subscription to both Caller ID with Name and Call Waiting Service.

Attach your purchase receipt here.

For your future reference

Serial No. _____

(found on the bottom of the unit)

Date of purchase _____

Name and address of dealer _____

Accessories (included) For extra orders, call 1-800-332-5368.

- AC Adaptor (p. 10)
Order No. KX-TCA1-G

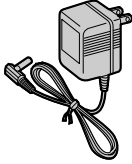

one

- AA (R6, UM-3) Batteries (p. 9)

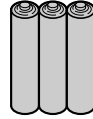

three

- Handset (p. 10)
Order No.
PQJXC0401Z (Black)
PQJXC0402Z (White)

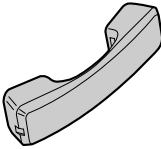

one

- Handset Cord (p. 10)
Order No.
PQJA212V (Black)
PQJA212M (White)

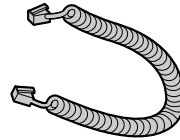

one

- 4-Wire Telephone Line Cord
with Green Plugs
(p. 11-13)
Order No. PQJA10088Z

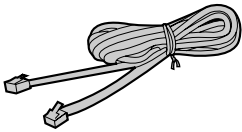

one

- 2-Wire Telephone Line Cord
with Transparent Plugs (p. 13, 14)
Order No. PQJA10075Z

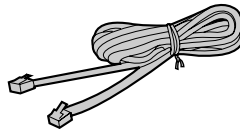

one

Contents

Preparation

| | |
|---|-----------|
| Location of Controls | 6 |
| Display | 8 |
| Installation | 9 |
| Installing the Batteries | 9 |
| Connecting the Handset and AC Adaptor | 10 |
| Connecting Telephone Line Cords | 11 |
| Connecting a Communication Device | 14 |
| Programmable Settings | 15 |
| Time and Date | 15 |
| Assigning the Extension Number | 17 |
| Programming Summary | 19 |
| Dialing Mode | 20 |
| LCD Contrast | 21 |
| Ringer Volume | 22 |
| Ringer Pattern | 23 |

Basic Operation

| | |
|---|-----------|
| Making Calls | 25 |
| Answering Calls | 28 |
| Caller ID Service | 29 |
| Using the Caller List | 30 |
| Viewing the Caller List | 30 |
| Calling Back from the Caller List | 32 |
| Editing the Caller's Phone Number | 33 |
| The Caller ID Number Auto Edit Feature | 34 |
| Storing Caller List Information in the Directory or in the One-Touch Dialer Memory | 36 |
| Erasing Caller List Information | 37 |

Advanced Operation

| | |
|---------------------------------|-----------|
| Directory | 38 |
| Storing Names and Numbers | 38 |
| Finding Stored Items | 40 |
| Dialing | 41 |

| | |
|--|-----------|
| Editing | 42 |
| Erasing | 43 |
| One-Touch Dialer | 44 |
| Storing Names and Numbers | 44 |
| Dialing a Stored Number | 45 |
| Intercom | 46 |
| Paging a Designated Extension | 46 |
| Paging All Extensions | 48 |
| Transferring an External Call to Another Extension | 48 |
| Room Monitor Feature | 49 |
| Making/Answering Another Call During a Conversation | 50 |
| Conference | 51 |
| Special Features | 52 |
| How to Use the PAUSE Button (For PBX Line/Long Distance Calls) | 52 |
| Muting Your Conversation | 52 |
| For Call Waiting Service Users | 52 |
| Temporary Tone Dialing (For Rotary or Pulse Service Users) | 53 |
| FLASH Button | 53 |
| Incoming Call Tone | 54 |
| Line Selection | 55 |
| Setting the Password | 56 |
| Dial Lock | 57 |
| Call Restriction | 58 |
| Call Privacy Feature | 60 |

Preparation

Basic Operation

Advanced Operation

Useful Information

| | |
|---|-----------|
| <i>Useful Information</i> | |
| Optional Headset | 61 |
| Connecting the Optional Headset to the Unit | 61 |
| Wall Mounting | 62 |
| Troubleshooting | 64 |
| Important Safety Instructions | 67 |
| FCC and Other Information | 69 |
| Index | 71 |
| Warranty | 73 |
| Specifications | 75 |

Location of Controls

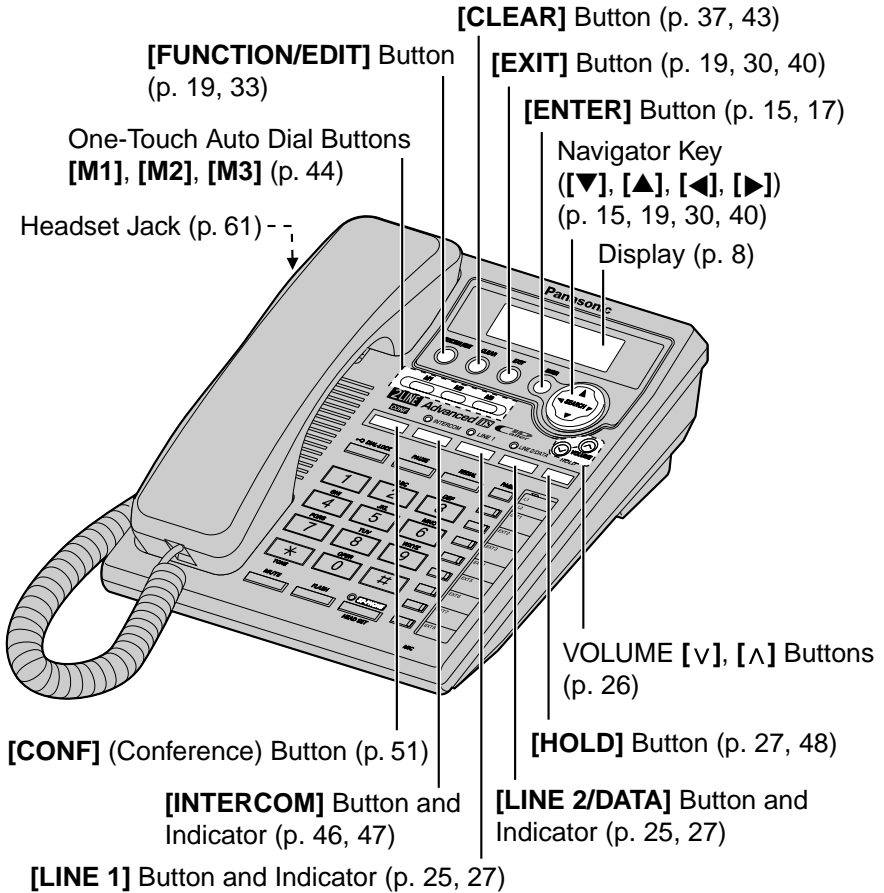

How to use the Navigator key

This key has four active areas that are indicated by arrows.



- Pressing the up and down arrows allows you to enter the Caller List and scroll through the Caller List, the directory list and the function menu.
- Pressing the right and left arrows allows you to enter the directory list and move the cursor when entering items.
- The right arrow is used to select your menu choices.

Throughout these Operating Instructions, the navigator key is indicated by the arrows [▼], [▲], [◀] or [▶].

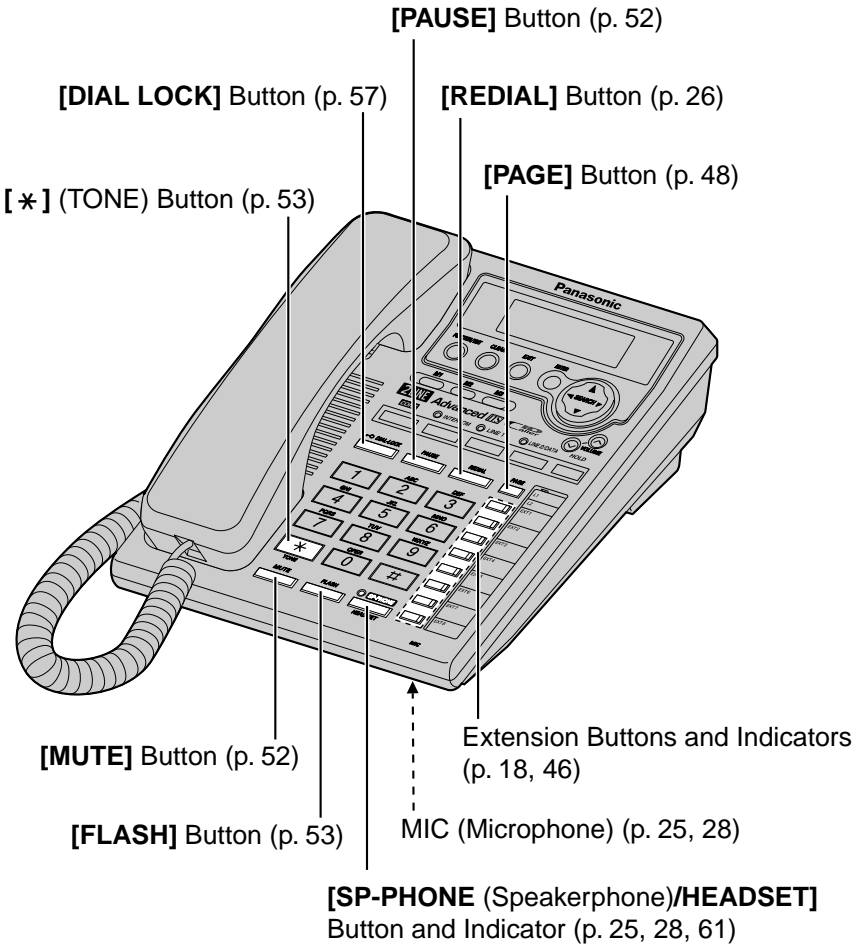

Display

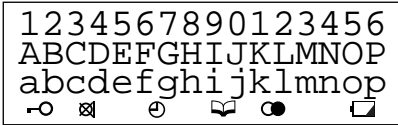

(This display shows all of the possible configurations.)

12:34AM 5/21[1]
10 new calls

When the handset is on the cradle, the AC adaptor is connected and the SP-PHONE/HEADSET indicator light is off, the display shows the current time and date, the extension number, and the number of new calls if you subscribed to a Caller ID service (p. 29).

12:00 1.1 [1]
Ⓢ

If “Ⓢ” flashes on the display, the clock needs adjusting (p. 15, 16).

12:34AM 5/21[1]
01-06-35

During a conversation, the display shows the length of the call (ex. 1 hour, 6 minutes and 35 seconds).

SMITH, JACK [1]
1-222-333-4444
11:20AM 1/10 x3

This is a display from the Caller List. The display shows:

- the caller's name,
- the called line,
- the caller's number,
- the time and date of the last call (ex. Jan. 10, 11:20 AM), and
- the number of times called (ex. 3 times).

⓪ : The dial lock mode is set (p. 57).

ⓧ : **[MUTE]** was pressed during a conversation (p. 52).

📖 : Displays when storing or viewing the directory items (p. 38, 40).

● : Displays while viewing the redial list (p. 26).

🔋 : The battery power is low or the batteries have not been installed. To replace or install the batteries, see page 9.

P : **[PAUSE]** was pressed while dialing or storing phone numbers.

F : **[FLASH]** was pressed while storing phone numbers.



Installing the Batteries

Install the three included batteries in the battery compartment. They work as emergency power during a power failure. The unit will work as a standard telephone, so that you can make or answer external calls with the handset. (You cannot use the intercom.)

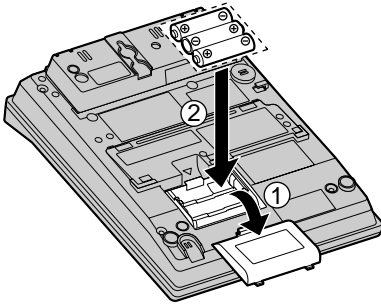

1. Press down the cover in the direction of the arrow and remove it.
2. Install the batteries in proper order as shown, matching the correct polarity.
3. Close the battery cover.

- Please refer to page 68 for correct battery usage.
- You can also install three “AA” size Alkaline (LR6) batteries.
- The battery operating time may depend on usage conditions and ambient temperature.
- The battery operating time during a power failure is about three weeks for the three included “AA” size Manganese (R6, UM-3) batteries. The battery operating time will be longer for three “AA” size Alkaline (LR6) batteries.
- During a power failure the batteries will retain the clock memory (p. 15) and the redial memory (p. 26). If you do not install the batteries, the data in memory will be lost during a power failure.

Battery replacement

If “” flashes, the battery power is low. Replace all of the batteries with new ones.

Disconnect the telephone line cord(s) before opening the battery cover.



- You do not need to disconnect the AC adaptor, otherwise the clock memory and the redial memory will be lost. If “” flashes on the display, adjust the clock (p. 15, 16).
- Please refer to page 68 for correct battery usage.

→ Installation

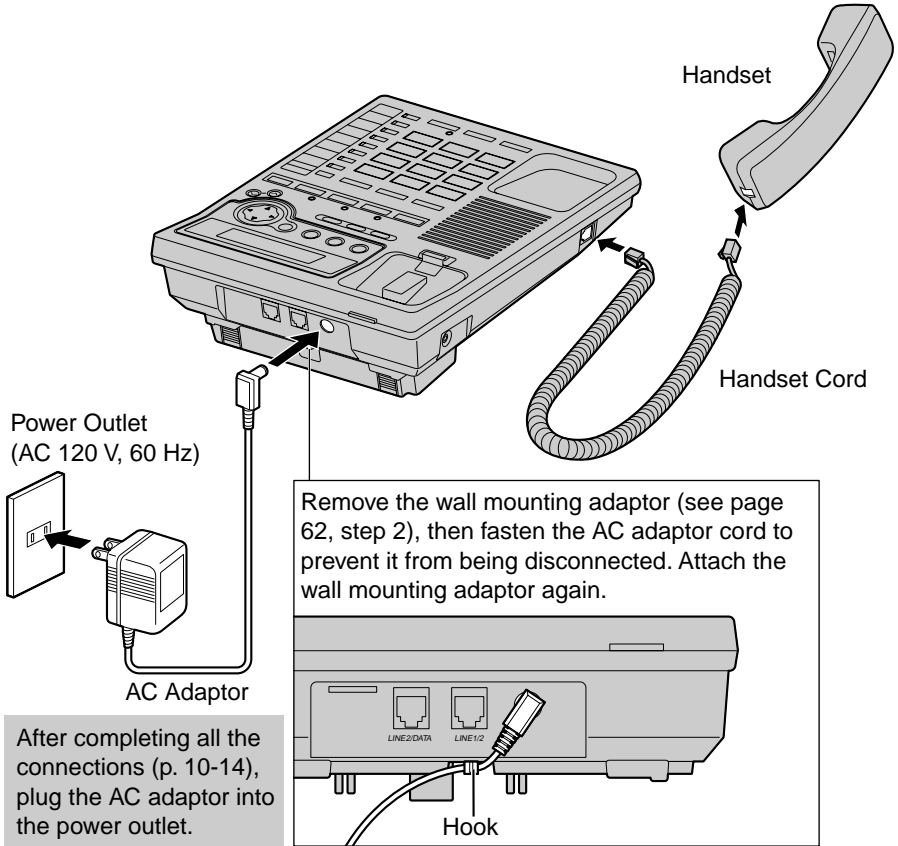
Connecting the Handset and AC Adaptor



- USE ONLY WITH Panasonic AC ADAPTOR KX-TCA1 (Order No. KX-TCA1-G).
- Use only a Panasonic Handset for the KX-TS3282B/KX-TS3282W.
- The AC adaptor must remain connected at all times. (It is normal for the adaptor to feel warm during use.)
- After you connect the AC adaptor;
 - the display shows “Set clock” (p. 15) for 60 seconds, and
 - all of the extension indicators flash until you assign the extension number of your unit (p. 17). Even if you do not use the intercom, assign the number. Otherwise all of the extension indicators will continue flashing.

If you plug the AC adaptor into the power outlet without installing batteries, “” flashes. After you install the batteries (p. 9), “” disappears. During a power failure, the batteries serve as the power source (p. 9). The unit will work as a standard telephone. You can make or answer an external call with the handset. (You cannot use the intercom.)



Connecting Telephone Line Cords

A maximum of eight KX-TS3282Bs/KX-TS3282Ws can be connected in parallel. You can also connect KX-T3281W.

To use the intercom, you must connect the telephone line cord to the LINE1/2 telephone jack of the unit.

To connect the units to individual two-line telephone jacks

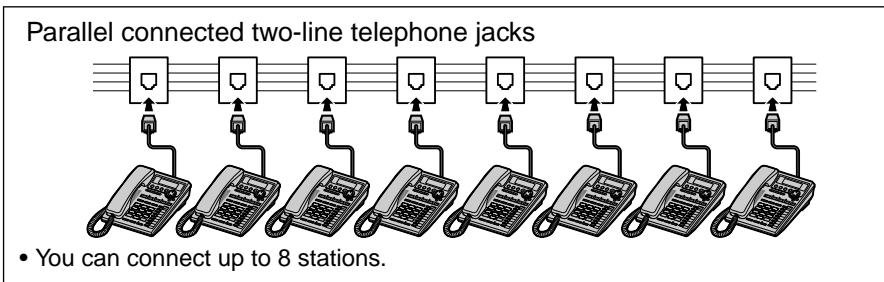
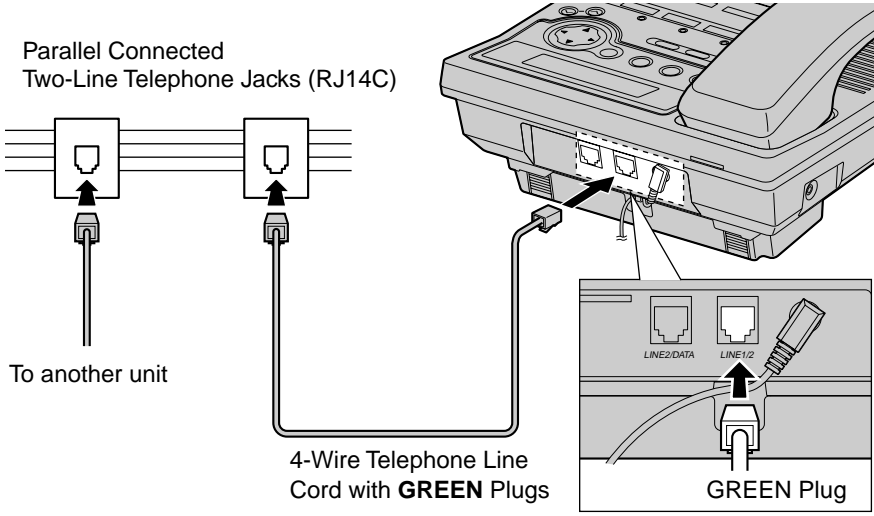

• If another model telephone is connected to the KX-TS3282B/KX-TS3282W except for KX-T3281W, the line indicators of this unit will not function for that telephone.

DSL Internet connection and KX-TS3282B/KX-TS3282W Intercom work at similar frequencies. Please contact Panasonic at 1-800-211-PANA(7262) for special wiring configurations.

For assistance, please call: 1-800-211-PANA(7262)

→ Installation

- If you re-connect the telephone line cord(s), confirm that all of the extension indicators light with the AC adaptor connected, then connect the telephone line cord(s). If all of the extension indicators do not flash, the extension number has been assigned to this unit and the number might be used for another unit on the same line. Erase the previously assigned number (p. 17), then connect the telephone line cord(s). Re-assign the number to the unit (p. 17).

To connect the units to a two-line telephone jack

If you provide only one two-line telephone jack for the units, continue to wire them using optional Panasonic T-adaptors KX-J66. To order, call the accessories telephone number on page 3.

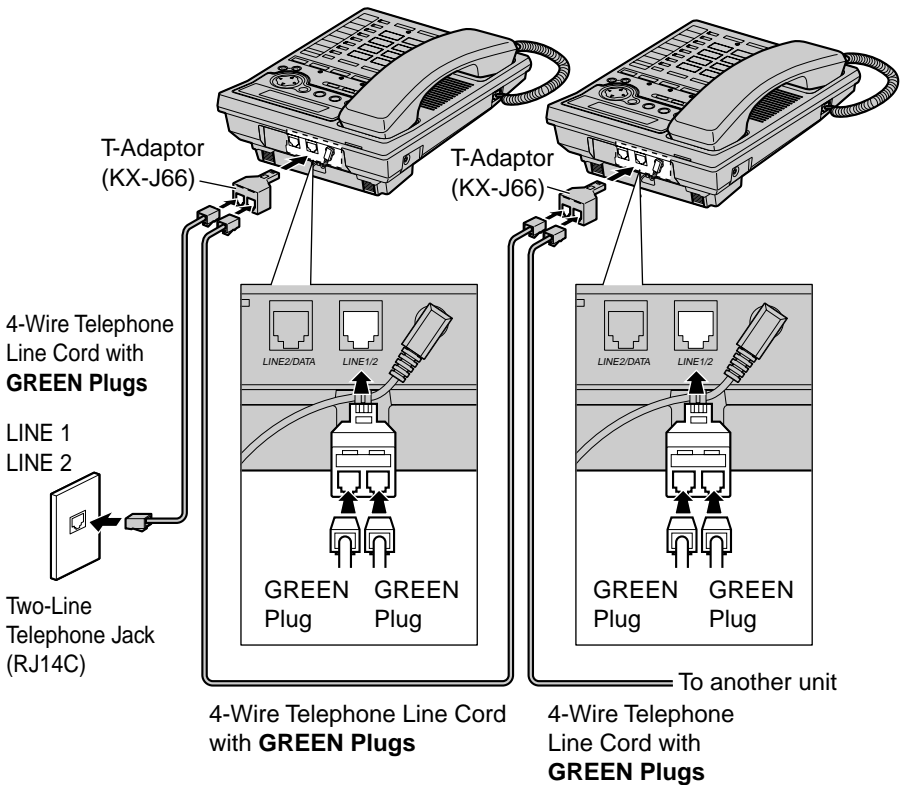

DSL Internet connection and KX-TS3282B/KX-TS3282W Intercom work at similar frequencies. Please contact Panasonic at 1-800-211-PANA(7262) for special wiring configurations.



To connect the units to two single-line telephone jacks

If you provide only two single-line telephone jacks for the units, continue to wire them using optional Panasonic T-adaptors KX-J66. To order, call the accessories telephone number on page 3.

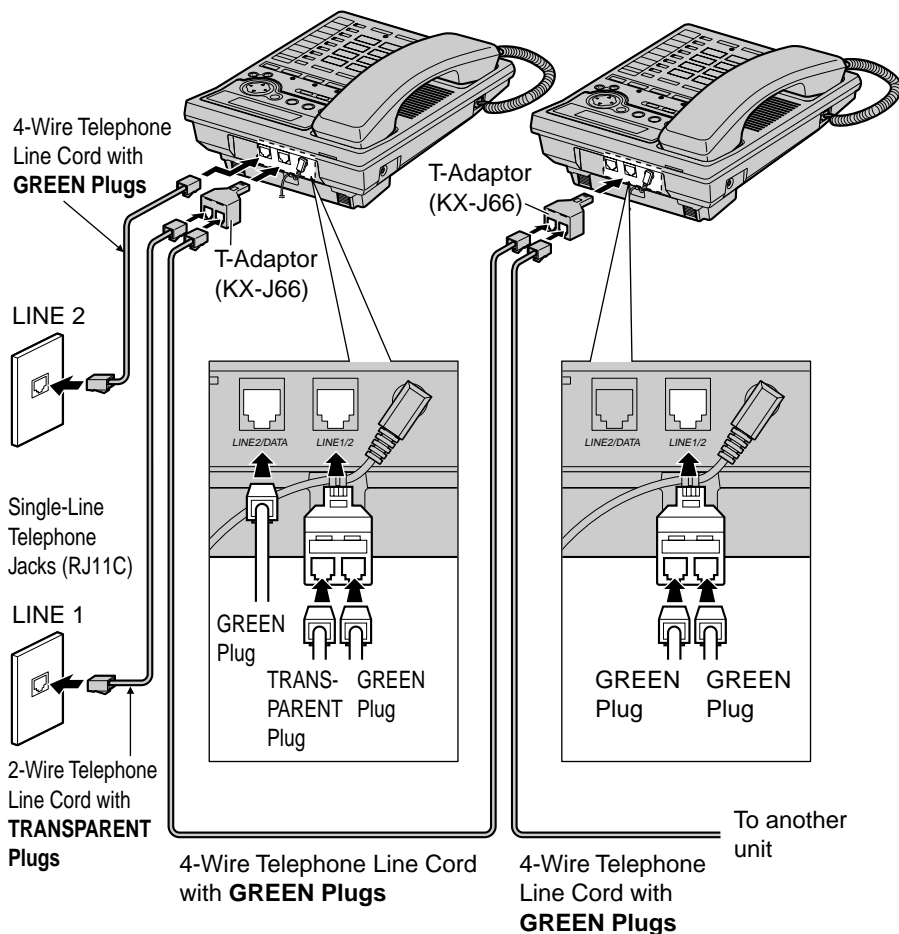

- If you do not connect other extensions, you do not need to use a T-adaptor. Connect a 2-wire telephone line cord to the LINE1/2 telephone jack of the unit directly.

DSL Internet connection and KX-TS3282B/KX-TS3282W Intercom work at similar frequencies. Please contact Panasonic at 1-800-211-PANA(7262) for special wiring configurations.

→ Installation

Connecting a Communication Device

After connecting the telephone line cord to a two-line telephone jack, you can connect a communication device (computer, modem, fax, answering machine, etc.) through this unit using the LINE2/DATA jack.

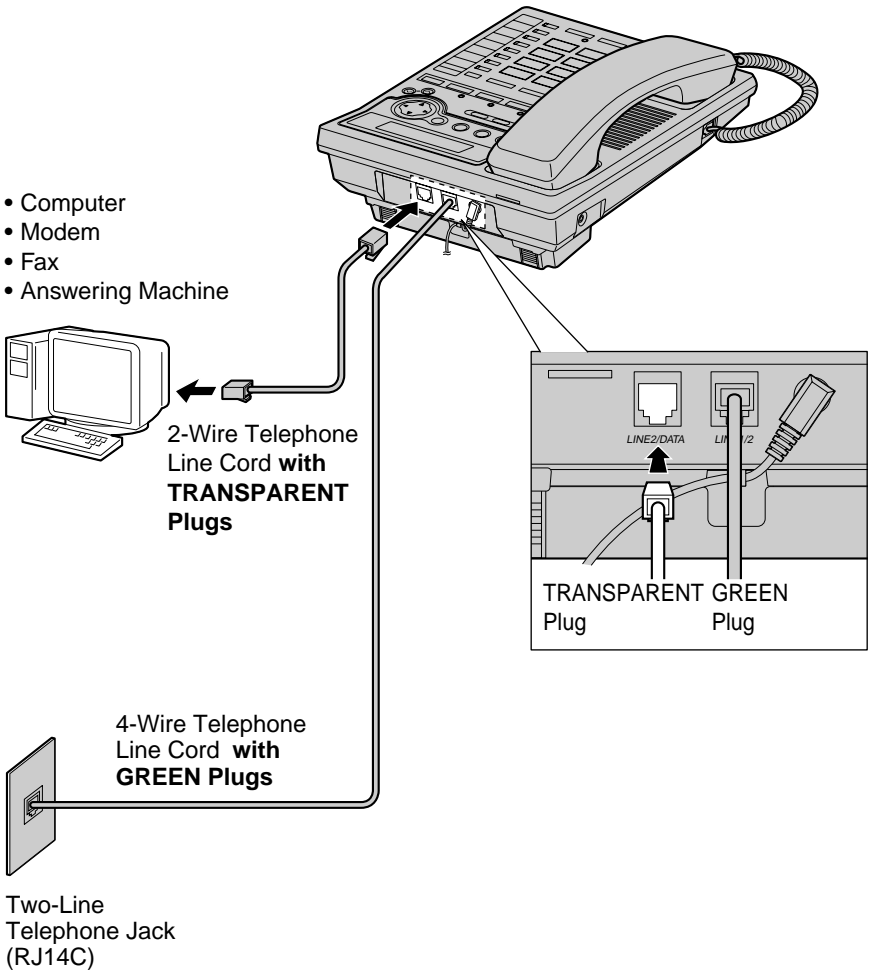

- If the communication device is in use, use LINE 1 to make or answer other calls. Otherwise the communication device may not operate properly.



Time and Date

You can select 12-hour clock (AM/PM) or 24-hour clock by programming.

Make sure that the handset is on the cradle, the AC adaptor is connected and the SP-PHONE/HEADSET indicator light is off.

After the AC adaptor is connected, the display will show "Set clock" for 60 seconds.

- If the display exits the set clock menu, press **[FUNCTION/EDIT]**, then scroll to "Set clock" by pressing **[▼]** or **[▲]**.



1 Press **[▶]** or **[ENTER]** (Yes key).

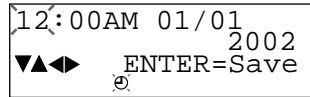

Ex. Time: 09:30

2 (1) Enter the time (hour and minute) using **[▼]**, **[▲]** and **[▶]**.

- You can scroll to the desired hour/minute by pressing **[▼]** or **[▲]**. To move forward, press **[▶]**. To move backward, press **[◀]**.
- For 12-hour clock, enter "0100" to "1259". For 24-hour clock, enter "0000" to "2359".
- If you entered "00" or between "13" and "23" for the hour, enter the minute and press **[▶]**, then go to step 3.
- You can also enter the time using the dialing buttons (**[0]** to **[9]**).

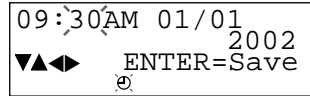

(2) For 12-hour clock, select "AM" or "PM" by pressing **[▼]** or **[▲]**, and press **[▶]**.

For 24-hour clock, if the hour is between 1 and 12, erase "AM" or "PM" by pressing **[▼]** or **[▲]**, and press **[▶]**.

- You can also select "AM" or "PM" or erase it by pressing **[*]**.

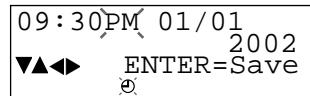

3 Enter the month and day using **[▼]**, **[▲]** and **[▶]**.

- You can scroll to the desired month/day by pressing **[▼]** or **[▲]**. To move forward, press **[▶]**. To move backward, press **[◀]**.
- You can also enter the month/day using the dialing buttons (**[0]** to **[9]**).

Ex. Dec. 27

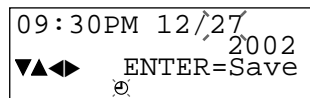

(Continued →)

→ Programmable Settings

- 4 Enter the year using [▼] and [▲].
- You can select the year between 2000 and 2099.
 - You can also select the year entering the last 2-digits using the dialing buttons ([0] to [9]).

```
09:30PM 12/27
                2002
▼▲◀          ENTER=Save
                ☺
```

- 5 Press [ENTER] (Save key).
- A beep sounds.
 - The clock starts working.
 - If 3 beeps are heard, the setting is not correct. Start again from step 2.
 - The display will go to the extension number assigning menu as shown on the right if you had started programming within 60 seconds after plugging in the AC adaptor. The menu will remain for 60 seconds. To assign a number, see page 17, from step 4.

```
Extension#
12345678 Erase
◀          ENTER=Save
```

- You can exit the programming mode any time by pressing [EXIT].

If a power failure occurs, the adjusted time/date will be retained by installing the batteries (p. 9). Readjust if “☺” flashing on the display.

To adjust the time and date

1. Press [FUNCTION/EDIT].
2. Scroll to “Set clock” by pressing [▼] or [▲], and press [▶].
3. Adjust the time and date, using [▼], [▲], [◀] or [▶].
4. Press [ENTER] (Save key).

```
Caller ID edit
▶Set clock
Assign EXT#
```

For Caller ID service users (p. 29)

- The Caller ID information will reset the clock after the first ring if the adjusted time is incorrect.
- If the clock has not previously been set, the Caller ID information will not adjust the clock.
- The Caller ID information will automatically adjust the clock for daylight saving time.



Assigning the Extension Number

Assign the extension number to the unit to use the intercom feature. Make sure that the unit has been connected to other units (KX-TS3282B, KX-TS3282W and/or KX-T3281W) in parallel (p. 11-13) before programming.

Make sure that the handset is on the cradle, the AC adaptor is connected and the SP-PHONE/HEADSET indicator light is off.

1 Press [FUNCTION/EDIT].

```
-----
▶ Save M1,M2,M3
  Save directory
```

2 Scroll to "Assign EXT#" by pressing [▼] or [▲].

```
Set clock
▶ Assign EXT#
-----
```

3 Press [▶].

- The numbers (1 to 8) that have already been assigned to other units are not displayed.

```
Extension#
12345678 Erase
◀ ENTER=Save
```

4 Press [▶] or [◀] to move the cursor to select the extension number (1 to 8).

5 Press [ENTER] (Save key).

- A beep sounds.

Ex. Extension number 1

```
Extension#
                                     1
```

- The extension number ([1] to [8]) is shown on the right.
- You can exit the programming mode any time by pressing [EXIT].
- To change the extension number, start from step 1. The previous memory will be erased.
- To exchange the extension numbers between two units, erase each number (see below), then re-assign the number to each unit.

After you connect the AC adaptor (p. 10), all of the extension indicators flash until you assign the extension number of your unit. Even if you do not use the intercom, assign the number. Otherwise all of the extension indicators will continue flashing.

To erase the extension number

Repeat steps 1 to 3, and select "Erase" by pressing [▶]. Press [ENTER] (Save key).

- "Extension# Not assign" is displayed.
- All extension indicators flash until you assign a number to the unit.

➔ Programmable Settings

What the extension indicators mean

| | |
|-----|------------------------------|
| Off | The extension is not in use. |
| On | The extension is in use. |

Memory card

Remove the memory card and use it as a name index for extensions.

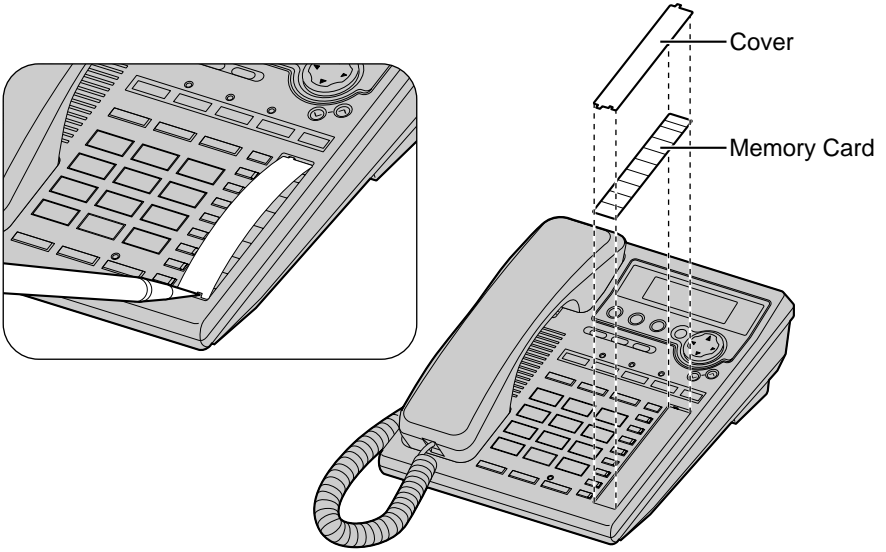



Programming Summary

You can program the following functions from the menu. After pressing [FUNCTION/EDIT], the main menu will be displayed first. If the main menu item has the sub-menu, it will be displayed. See the corresponding pages for function details.

Make sure that the handset is on the cradle, the AC adaptor is connected and the SP-PHONE/HEADSET indicator light is off.

Press [FUNCTION/EDIT].



<Main menu>

- Scroll to a desired item by pressing [▼] or [▲], and press [▶].

```

-----
▶ Save M1, M2, M3 . . . . . p. 44
  Save directory . . . . . p. 38
  LCD contrast . . . . . p. 21
  Ringer setting
-----
Change password . . . . . p. 56
Dial setting
-----
Line setting
Caller ID edit . . . . . p. 35
Set clock . . . . . p. 15
Assign EXT# . . . . . p. 17
-----

```

<Sub menu>

```

-----
▶ Ringer volume . . . . . p. 22
  Ringer pattern . . . . . p. 23
  Incoming call . . . . . p. 54
-----

```

```

-----
▶ Set dial mode . . . . . p. 20
  Set flash time . . . . . p. 53
  Call restrict . . . . . p. 58
-----

```

```

-----
▶ Line selection . . . . . p. 55
  Call barge in . . . . . p. 60
-----

```

During programming

- To select a desired function item, scroll through the menu by pressing [▼] or [▲]. Then press [▶] to go to the next step.
- “-----” indicates the beginning or end of the function menu.
- You can exit the programming mode any time by pressing [EXIT].
- If you do not press any buttons for 60 seconds, the unit will exit the programming mode.

→ Programmable Settings

Dialing Mode

If you have touch tone service, set to Tone. If rotary or pulse service is used, set to Pulse. Your phone comes from the factory set to Tone.

Make sure that the handset is on the cradle, the AC adaptor is connected and the SP-PHONE/HEADSET indicator light is off.

1 Press [FUNCTION/EDIT].

```
-----  
▶ Save M1,M2,M3  
  Save directory
```

2 Scroll to “Dial setting” by pressing [▼] or [▲].

```
Change password  
▶ Dial setting  
  Line setting
```

3 Press [▶].

```
-----  
▶ Set dial mode  
  Set flash time
```

4 Press [▶] at “Set dial mode”.
• The current setting is displayed.

```
Dial mode      :Tone  
▼▲             ENTER=Save
```

5 Select “Pulse” or “Tone” by pressing [▼] or [▲].

6 Press [ENTER] (Save key).

- A beep sounds.
- To exit the programming mode, press [EXIT].

- You can exit the programming mode any time by pressing [EXIT].



LCD Contrast

You can select the LCD contrast level from 1 to 4 by programming. To make the display clearer, set to high level. Your phone comes from the factory set to 3.

Make sure that the handset is on the cradle, the AC adaptor is connected and the SP-PHONE/HEADSET indicator light is off.

1 Press [FUNCTION/EDIT].

```
-----  
▶ Save M1,M2,M3  
Save directory
```

2 Scroll to "LCD contrast" by pressing [▼] or [▲].

```
Save directory  
▶ LCD contrast  
Ringer setting
```

3 Press [▶].

- The current setting is displayed.
- "■" shows one level.

```
Ex. Level 3  
LCD contrast  
Low ■■■■■■ High  
▼▲ ENTER=Save
```

4 Select the desired LCD contrast by pressing [▼] or [▲].

- Each time you press [▼] or [▲], the LCD contrast will change.

5 Press [ENTER] (Save key).

- A beep sounds.
- To exit the programming mode, press [EXIT].

- You can exit the programming mode any time by pressing [EXIT].

→ Programmable Settings

Ringer Volume

You can select the ringer volume for each external line and the intercom line individually. Set to HIGH, LOW, or OFF. If set to OFF for Line 1 and/or Line 2, the unit will not ring for the line(s). If the ringer for the intercom line is OFF, the unit will not ring for intercom calls. Your phone comes from the factory set to HIGH.

Make sure that the handset is on the cradle, the AC adaptor is connected and the SP-PHONE/HEADSET indicator light is off.

1 Press [FUNCTION/EDIT].

```
-----  
▶ Save M1,M2,M3  
  Save directory
```

2 Scroll to "Ringer setting" by pressing [▼] or [▲].

```
LCD contrast  
▶ Ringer setting  
  Change password
```

3 Press [▶].

```
-----  
▶ Ringer volume  
  Ringer pattern
```

4 Press [▶] at "Ringer volume".

5 Select each ringer volume:

(1) Select "L1", "L2" or "Intercom" by pressing [▶] or [◀].

Ex. Line 1 is selected.

```
HIGH Ringer volume  
      L1 L2 Intercom  
      Low ████████ High
```

(2) Select the desired volume by pressing [▼] or [▲].

```
LOW Ringer volume  
     L1 L2 Intercom  
     Low ████ High
```

- Each time you press [▼] or [▲], the volume will change and ring.
- **To turn the ringer OFF**, press [▼] repeatedly until "Ringer off" is displayed.

```
OFF Ringer volume  
    L1 L2 Intercom  
    Ringer off
```

6 Press [ENTER] (Save key).

- A beep sounds.
- To exit the programming mode, press [EXIT].

To turn the ringer ON:

Repeat steps 1 to 4, and select "L1", "L2" or "Intercom". Press [▲], and press [ENTER] (Save key).

- The ringer will sound at the LOW level for the line.



- You can exit the programming mode any time by pressing **[EXIT]**.
- If set to OFF, “Ringer off” with the line(s) (“**1**”, “**2**” and/or “INT”) is(are) displayed while the unit is not in use (standby mode).
- You can also change each ringer volume while the unit is just ringing for the external/intercom line, by pressing **VOLUME [^]** or **[V]**. To turn the ringer OFF, press and hold **VOLUME [v]**.
- You can change the ringer tone for Line 1, Line 2 and Intercom individually (see below).

Ringer Pattern

You can select one of eight ringer tones for Line 1, Line 2 and Intercom individually. For Intercom you can select another ringer pattern (Voice mode, Auto Answer mode or Room Monitor mode), instead of the ringer tone.

Line 1 is preset to “1”, Line 2 is preset to “2” and Intercom is preset to “3”.

| Ringer pattern | How the unit works when a call is being received. |
|--|---|
| Ringer tone (1 to 8) | The unit rings with the selected ringer tone. |
| Voice mode (for Intercom only) | Two short beeps sound, then you are paged with the caller's voice instead of the bell. To answer the page, press [SP-PHONE/HEADSET] or lift the handset. |
| Auto Answer mode (for Intercom only) | Two short beeps sound, then the speakerphone turns on automatically, in response to the page. Without pressing any button, 2-way intercom with the paging party is established automatically. |
| Room Monitor mode (for Intercom only) | Selecting the Room Monitor mode allows another extension user to monitor through your unit. Another extension can call your unit to monitor a room through it (p. 49). Your unit will not ring and the SP-PHONE/HEADSET indicator will light. If you want to prevent your unit from being monitored by other extensions, do not select this mode. |

- When a paging extension pages all extensions, this ringer pattern setting is not applicable (p. 48).

(Continued →)

→ Programmable Settings

Make sure that the handset is on the cradle, the AC adaptor is connected and the SP-PHONE/HEADSET indicator light is off.

1 Press [FUNCTION/EDIT].

```
-----  
▶ Save M1,M2,M3  
Save directory
```

2 Scroll to "Ringer setting" by pressing [▼] or [▲].

```
LCD contrast  
▶ Ringer setting  
Change password
```

3 Press [▶].

```
-----  
▶ Ringer volume  
Ringer pattern
```

4 Scroll to "Ringer pattern" by pressing [▼] or [▲].

```
Ringer volume  
▶ Ringer pattern  
Incoming call
```

5 Press [▶].
• The current settings are displayed.

```
Ringer pattern  
L1 L2 Intercom  
1 2 3
```

6 Select the desired ringer tone (1 to 8) by pressing [▼] or [▲] for each line. For Intercom you can select the ringer tone (1 to 8), "Voice", "Auto Ans." (Auto Answer) or "RoomMntr" (Room Monitor).

```
Ringer pattern  
L1 L2 Intercom  
1 2 Auto Ans
```

To move to another line, press [▶] or [◀].

- Each time you press [▼] or [▲], the ringer tone will change and ring. If the ringer volume has been set to OFF for the line, the unit will not ring (p. 22).

7 Press [ENTER] (Save key).

- A beep sounds.
- To exit the programming mode, press [EXIT].

- You can exit the programming mode any time by pressing [EXIT].

Making Calls



The unit will automatically select a free line when you lift the handset to make a call. (To change the line selection, see page 55.) To hang up, place the handset on the cradle.

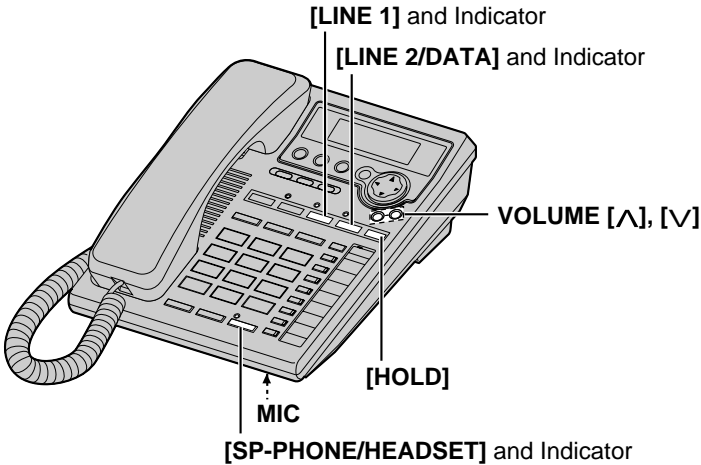

Using the speakerphone

- 1 Press **[SP-PHONE/HEADSET]**.
 - The SP-PHONE/HEADSET indicator lights.
 - A free line is automatically selected and the line indicator lights.
- 2 Dial a phone number.
 - The dialed number is displayed.
 - After a few seconds, the display will show the length of the call.
 - If you misdial, press **[SP-PHONE/HEADSET]** and start again from step 1.
- 3 When the other party answers, talk into the **MIC** (microphone).
- 4 To hang up, press **[SP-PHONE/HEADSET]**.
 - The SP-PHONE/HEADSET and the line indicator lights go out.
 - The length of the call will remain on the display for a few seconds.

```
12:34PM 11/24[1]
00-00-00
```

```
12:34PM 11/24[1]
1234567890
```

```
12:34PM 11/24[1]
00-00-12
```

```
12:35PM 11/24[1]
00-01-10
```

- In step 1, you can select a line by pressing a line button whose indicator is not lit, instead of pressing **[SP-PHONE/HEADSET]**.

→ Making Calls

During speakerphone operation

For best performance, please note the following:

- Talk alternately with the other party in a quiet room.
- If the other party has difficulty hearing you, press **VOLUME [v]** to decrease the speaker volume.
- You can switch to the handset by lifting it up. To switch back to the speakerphone, press **[SP-PHONE/HEADSET]**. You can place the handset on the cradle.

To adjust the handset volume (4 levels) or the speaker volume (8 levels) while talking

To increase, press **VOLUME [^]**. To decrease, press **VOLUME [v]**.

Ex. Handset volume level: 2



Ex. Speaker volume level: 3



"■■" shows one level.

"■" shows one level.

- The display shows the volume level for a few seconds.

To redial the last number dialed

Lift the handset or press **[SP-PHONE/HEADSET]** or a line button, and press **[REDIAL]**.

To redial using the redial list (Memory Redial)

The last 10 phone numbers dialed are stored in the redial list.

1. Press **[REDIAL]**.

- The last dialed number and "●" are displayed.
- When the number dialed has been stored in the directory or One-Touch Dialer, the name is also displayed.

A rectangular display box showing the phone number "234-5678" and a small filled circle icon "●" at the bottom right.

2. Scroll to the desired number by pressing **[▼]** or **[▲]**.

- You can also scroll down through the list by pressing **[REDIAL]**.
- When you scroll to the most recent item, two short beeps sound.
- To exit the list, press **[EXIT]**.

3. Lift the handset or press **[SP-PHONE/HEADSET]** or a line button.

- **To erase an item**, repeat steps 1 and 2, and press **[CLEAR]**.
- If "No items stored" is displayed, the list is empty.

To put a call on hold

Press **[HOLD]** during a conversation.

- The line indicator light flashes.
- If using the handset, you can place it on the cradle.
- To transfer the call to another extension, see page 48.

| |
|--|
| Hold Press EXT1~EXT8 to transfer |
|--|

To release the hold

Press the line button.

- The other extension users can release the hold by pressing the line button.
- If a phone other than KX-TS3282B, KX-TS3282W or KX-T3281W is connected on the same line, you can also release the hold by lifting the handset.

What the line indicators (LINE 1 and LINE 2) mean

| | |
|--------------------------------|--------------------------------------|
| Off | The line is free. |
| On | You are using the line. |
| Flashing twice every 2 seconds | Another extension is using the line. |
| Flashing | You place the call on hold. |
| Flashing quickly | A call is being received. |

Answering Calls

When a call is being received, the unit rings and the called line indicator flashes quickly. "Incoming call" and the line are displayed. You can answer a call by simply lifting the handset. (To change the line selection, see page 55.)

If you subscribe to a Caller ID service, the calling party's information will be displayed after the first ring (p. 29). In order to view the Caller ID information, please wait until the second ring to answer a call.

Using the speakerphone

- 1 Press **[SP-PHONE/HEADSET]**.
 - The SP-PHONE/HEADSET indicator lights.
 - The line indicator stops flashing and remains lit.
- 2 Talk into the **MIC** (microphone).
- 3 To hang up, press **[SP-PHONE/HEADSET]**.
 - The SP-PHONE/HEADSET indicator and the line indicator lights go out.

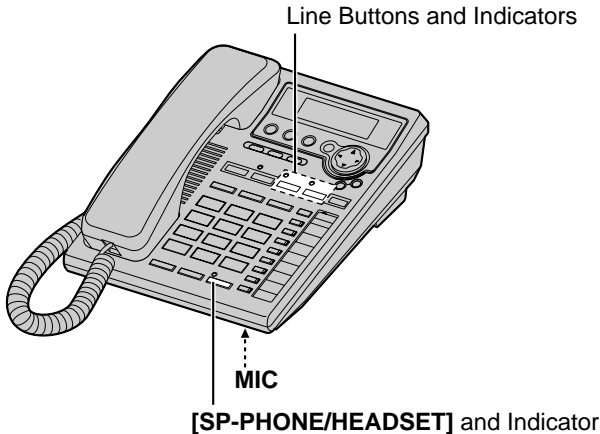

- You can answer a call by pressing the called line button, instead of pressing **[SP-PHONE/HEADSET]**.
- **To transfer the call to another extension, see page 48.**
- When the ringer volume for a selected line is set to OFF (p. 22), the unit will not ring when that line is called.

Caller ID Service

This unit is compatible with a Caller ID service offered by your telephone company. If you subscribe to a Caller ID service, the calling party's information will be displayed after the first ring.

The unit can record information of up to 50 different callers for both lines combined, including the time and date received, the called line, and the number of times called, in the Caller List. The Caller List information is sorted from the most recent to the oldest call. When the 51st call is received, the oldest call is deleted.

Using the list, you can automatically call back a caller. You can store the callers' names and numbers from the Caller List into the directory or the One-Touch Dialer memory.

If you subscribe to both Caller ID and Call Waiting services, when a second call is received on the same line while talking, the new caller's name and phone number will be displayed (p. 52).

How caller information is displayed when a call is received

The display shows the caller's name, phone number and the called line after the first ring.

- After you answer the call, the display will show the length of the call.

```
ROBINSON, TINA
1-000-222-3333
---- Line1 -----
```

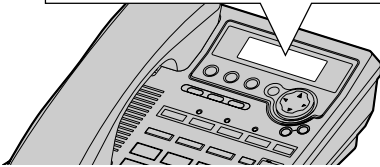

- If both lines receive calls at the same time, each caller's information will be displayed alternately.
- Caller information will not be displayed in the following cases:
 - If the caller dialed from an area which does not provide a Caller ID service, the display will show "Out of area".
 - If the caller has requested not to display his/her information, the display will show "Private caller".
 - If a long distance call is identified, and the caller's name and/or number cannot be received, the display will show "Long distance".
- The name display service may not be available in some areas. For further information, please contact your telephone company.
- If your unit is connected to a PBX which does not support Caller ID services, you cannot access those services.

Using the Caller List

If you have received new calls, the number of new calls will be displayed as shown on the right, while the unit is not in use (standby mode).

Ex. Received 10 new calls

```
12:34AM 5/21[1]
10 new calls
```

Viewing the Caller List

Make sure that the handset is on the cradle, the AC adaptor is connected and the SP-PHONE/HEADSET indicator light is off.

To check who has called, follow the steps below.

- 1 Press [▼] or [▲] to enter the Caller List.
 - For example, the display on the right will show.
 - You can go to the directory list by pressing [▶] (p. 40).

```
Caller list
10 new calls
▼▲ ▶=Directory
```

- 2 To search from the most recent call, press [▼].
 - To search from the oldest call, press [▲].
 - To scroll between callers, press [▼] or [▲].

- 3 To exit the Caller List, press [EXIT].

- If “No items stored” is displayed, the Caller List is empty.
- If more than one call is received from the same caller, the time and date of the most recent call will be recorded.
- If you do not press any buttons for 60 seconds, the unit will exit the Caller List.



Ex. When you search from the most recent call:

Press [▼] or [▲] to enter the Caller List.

Caller list
2 new calls
▼▲ ▶=Directory

Press [▼].

SMITH, JACK [1]
1-222-333-4444
11:50AM 11/24

Press [▼].

BROWN, NANCY [2]
222-3333
10:50AM 11/23 X4

Press [▼].

TURNER, CINDY [1]
1-234-456-7890 ✓
10:00AM 11/22 ✓

Press [▼].

Caller list
0 new call
▼▲ ▶=Directory

Press [▼].

- If there is no name information for a caller, the display will only show the phone number.

To return to the previous caller, press [▲].

To exit the Caller List, press [EXIT].

Display meaning:

x2-x9: The number of times the same caller called (up to 9). After checking, "x2" to "x9" will be replaced with "✓".

✓: You have checked this caller information, answered the call or called back the caller.

[1], [2]: Indication of which line the caller information was received

→ Using the Caller List

Calling Back from the Caller List

1 Press [▼] or [▲] to enter the Caller List.

```
Caller list
  3 new calls
▼▲ ▶=Directory
```

2 Scroll to the desired caller by pressing [▼] or [▲].

- To exit the Caller List, press [EXIT].

```
TURNER, CYNDY [1]
1-234-456-7890
10:50AM 11/23 X4
```

3 Lift the handset or press [SP-PHONE/HEADSET] or a line button.

- The displayed phone number is dialed automatically.
- After a few seconds, the display will show the length of the call.

```
12:34PM 11/25 [1]
1234567890
```

```
12:34PM 11/25 [1]
00-00-09
```

- In some cases, you may have to edit the number before dialing (p. 33–35). (Ex. You may have to delete “1” and the area code.)
- If a phone number is not displayed in the caller information, you cannot call back that caller.
- If the line selection is “Auto” (p. 55), the indicated line will be selected by lifting the handset off the cradle or pressing [SP-PHONE/HEADSET], in step 3. If the indicated line is already being used, select the other line by pressing the line button.



Editing the Caller's Phone Number

You can edit a phone number into one of 3 patterns [see below (a), (b) and (c) on this page] to call back or store it into the directory or the One-Touch Dialer memory (p. 36).

The Caller ID Number Auto Edit Feature (p. 34, 35)

This feature will allow the unit to edit a Caller ID number into one of 3 patterns you desired for you automatically in the Caller List. For details and activation please see pages 34 and 35.

- 1 Press [▼] or [▲] to enter the Caller List.

```
Caller list
  3 new calls
▼▲      ►=Directory
```

- 2 Scroll to the desired caller by pressing [▼] or [▲].

```
PARKER, FRED  [I]
1-234-321-5555
10:50AM 11/23 X4
```

- 3 Press [FUNCTION/EDIT] to select a pattern.

- Each time you press [FUNCTION/EDIT], the number is rearranged into one of 3 patterns.

(a) [Phone no.] (7 digit pattern)

(b) [Area code] - [Phone no.]
(10 digit pattern)

(c) 1- [Area code] - [Phone no.]
(11 digit pattern)

- The order in which patterns (a)–(c) are displayed depends on how the telephone number is displayed in step 2.

(a) 321-5555
ENTER=Save

(b) 234-321-5555
ENTER=Save

(c) 1-234-321-5555
ENTER=Save

- 4 After editing, you can continue with calling back or storing procedures.

To call back, lift the handset or press [SP-PHONE/HEADSET] or a line button (p. 32).

To store the number in the directory or One-Touch Dialer memory, press [ENTER]. Then follow the instructions on the display (see page 36, from step 4).

→ Using the Caller List

The Caller ID Number Auto Edit Feature

There are 3 patterns of phone number [(a), (b), and (c), p. 33]. This feature allows your phone to automatically edit an in-coming Caller ID number into one pattern you preferred, and display the Caller ID number with that pattern automatically.

After this feature is activated, Caller ID numbers coming from considered area codes (201, for example), from which the Caller ID numbers have been chosen to follow the desired pattern (7 digit pattern, for example), will be automatically edited from other patterns (11 digit pattern, for example) into the same pattern you have previously selected (which is 7 digit pattern, in the example).

Up to 4 area codes are allowed for this feature for pattern (a), (b) and (c) (p. 33).

To activate this feature, you must (1) set this feature to on, and (2) make an out-going call from Caller List (p. 33) with a number which has one of 3 patterns that you have edited with considered area code, and that you prefer to be followed by future Caller ID numbers, so that in the future all the Caller ID numbers coming from the same area code will be displayed in the same pattern.

The Caller ID number Auto Edit feature is preset to ON at factory.

- If you fail to reach your destination when making the call, the phone number you dialed might have an incorrect pattern, please edit the phone number with another pattern (p. 33).

For example, if you move to another area, you may need to turn this feature to OFF to erase previously edited area codes. Then, if still needed, you may activate this feature again.



Make sure that the handset is on the cradle, the AC adaptor is connected and the SP-PHONE/HEADSET indicator light is off.

1 Press [FUNCTION/EDIT].

```
-----  
▶ Save M1,M2,M3  
  Save directory
```

2 Scroll to “Caller ID edit” by pressing [▼] or [▲].

```
Line setting  
▶ Caller ID edit  
  Set clock
```

3 Press [▶].
• The current setting is displayed.

```
Auto edit  
▼▲      :On  
      ENTER=Save
```

4 Select “On” or “Off” by pressing [▼] or [▲].

5 Press [ENTER] (Save key).
• A beep sounds.
• To exit the programming mode, press [EXIT].

- You can exit the programming mode any time by pressing [EXIT].
- When the feature is set to OFF, the unit will still be able to display Caller ID, like regular Caller ID telephone, but the in-coming Caller ID number will not be edited by pattern and by area codes.

→ Using the Caller List

Storing Caller List Information in the Directory or in the One-Touch Dialer Memory

You can store names and numbers that are in the Caller List to the directory or the one-touch auto dial buttons ([M1], [M2] and [M3]).

Make sure that the handset is on the cradle, the AC adaptor is connected and the SP-PHONE/HEADSET indicator light is off.

1 Press [▼] or [▲] to enter the Caller List.

2 Scroll to the caller you want to store by pressing [▼] or [▲].

- If the number requires editing, see page 33.

```
TURNER, CYNDY 1
1-234-456-7890
10:50AM 11/23 X4
```

3 Press [ENTER] twice.

```
TURNER, CYNDY 1
1-234-456-7890
ENTER=Save
```

4 If required, edit the name using the dialing buttons ([0] to [9]), up to 15 characters (p. 39).

- To move the cursor, press [◀] or [▶].
- To erase a character, press [CLEAR].
- If you do not need to edit the name, press [▼] (Next key) and go to step 6.

```
Enter name
TURNER, CYNDY
◀ ▶ =Next
```

```
Enter name
CINDY TURNER
◀ ▶ =Next
```

5 Press [▼] (Next key).

```
Save to memory
M1, M2, M3 or
ENTER=Directory
```

6 To store the item in the directory, press [ENTER].

To store the item in one of the one-touch auto dial buttons, press [M1], [M2] or [M3].

```
CINDY TURNER
1-234-456-7890
```

- A beep sounds.
- To continue storing other items, repeat from step 2.
- To exit the Caller List, press [EXIT].
- You can exit the programming mode any time by pressing [EXIT].
- If 3 beeps are heard in step 6, the directory has already been full. Press [EXIT]. To erase other stored items from the directory, see page 43.
- You cannot store caller information if a phone number is not displayed. 3 beeps will be heard in step 3.
- When using the Dial Lock (p. 57) or Call Restriction feature (p. 58), you cannot store an item in the one-touch auto dial buttons ([M1] to [M3]). 3 beeps will be heard in step 6.

Erasing Caller List Information

After checking the Caller List, you can erase some or all of the entries. **Make sure that the handset is on the cradle, the AC adaptor is connected and the SP-PHONE/HEADSET indicator light is off.**

To erase a specific caller from the Caller List

- 1 Press [▼] or [▲] to enter the Caller List.

```
Caller list
  10 new calls
▼▲      ►=Directory
```

- 2 Scroll to the caller you want to erase from the Caller List by pressing [▼] or [▲].

```
REAGAN, TOM      1
1-888-777-6666
12:20AM  2/12
```

- 3 Press [CLEAR].
- A beep sounds and the information is erased.
 - To erase other items, repeat from step 2.
 - To exit the Caller List, press [EXIT].

```
Clear
```

To erase all entries in the Caller List

Before erasing all entries, make sure that “0 new call” is displayed at step 1.

- 1 Press [▼] or [▲] to enter the Caller List.

```
Caller list
  0 new call
▼▲      ►=Directory
```

- 2 Press [CLEAR].

```
►Exit
All clear
▼▲      ENTER=Yes
```

- 3 Scroll to “All clear” by pressing [▼] or [▲].

```
Exit
►All clear
▼▲      ENTER=Yes
```

- 4 Press [ENTER] (Yes key) or [CLEAR].
- A beep sounds and all entries are erased.

```
All clear
```

Directory

You can store up to 50 names and phone numbers in the directory. All directory items are sorted by the first word in alphabetical order. Using the directory, you can make a call by selecting a name on the display.

Make sure that the handset is on the cradle, the AC adaptor is connected and the SP-PHONE/HEADSET indicator light is off.

Storing Names and Numbers

- 1 Press **[FUNCTION/EDIT]**.
Scroll to "Save directory" by pressing **[▼]** or **[▲]**.

```
Save M1,M2,M3
▶Save directory
LCD contrast
```

- 2 Press **[▶]**.
• The display shows the number of stored items then "Enter name".

```
Directory=
  10 items
  B
```

```
Enter name
█
◀▶          ▼=Next
  B
```

- 3 Enter a name, up to 15 characters with the dialing buttons (**[0]** to **[9]**) (p. 39).
• To move the cursor, press **[◀]** or **[▶]**.
• If a name is not required, press **[▼]** (Next key) and go to step 5.

```
Enter name
Tom Jones█
◀▶          ▼=Next
  B
```

- 4 Press **[▼]** (Next key).

```
Enter phone no.
  B
```

- 5 Enter a phone number up to 22 digits.
• Each time you press **[CLEAR]**, a digit is erased. To erase all of the digits, press and hold **[CLEAR]**.

```
0987654321█
◀▶          ▼=Next
  B
```

- 6 Press **[▼]** (Next key).
• If you want to change the name or number, press **[▲]** to reach the desired display and change it.

```
Tom Jones
098-765-4321
ENTER=Save
  B
```

- 7 Press **[ENTER]** (Save key).

- A beep sounds.
- To continue storing other items, repeat from step 2. To exit the programming mode, press **[EXIT]**.

- You can exit the programming mode any time by pressing **[EXIT]**.
- If a pause is required for dialing, press **[PAUSE]** where needed. If required, you can also insert **[FLASH]** in a phone number. Pressing **[PAUSE]** or **[FLASH]** counts as one digit (p. 52, 53).
- If the display shows "Directory full" in step 2, press **[EXIT]**. To erase other stored items from the directory, see page 43.



Selecting characters to enter names

The dialing buttons ([0] to [9]) can be used to enter letters and symbols. Pressing each button selects a character as shown below.

| Keys | Number of times key is pressed | | | | | | | | | | |
|------|---|-------|---|-----|---|---|---|---|---|----|----|
| | 1 | 2 | 3 | 4 | 5 | 6 | 7 | 8 | 9 | 10 | 11 |
| [1] | # | & | ' | () | * | , | - | . | / | 1 | |
| [2] | a | b | c | A | B | C | 2 | | | | |
| [3] | d | e | f | D | E | F | 3 | | | | |
| [4] | g | h | i | G | H | I | 4 | | | | |
| [5] | j | k | l | J | K | L | 5 | | | | |
| [6] | m | n | o | M | N | O | 6 | | | | |
| [7] | p | q | r | s | P | Q | R | S | 7 | | |
| [8] | t | u | v | T | U | V | 8 | | | | |
| [9] | w | x | y | z | W | X | Y | Z | 9 | | |
| [0] | 0 | Space | | | | | | | | | |
| [◀] | Moves the cursor to the left. | | | | | | | | | | |
| [▶] | Moves the cursor to the right. (To enter another character using the same number key, move the cursor to the next space.) | | | | | | | | | | |

If you make a mistake while entering a name:

Use [◀] or [▶] to move the cursor to the incorrect character, press [CLEAR] to delete and enter the correct character. Each time you press [CLEAR], a character is erased.

To erase all characters, press and hold [CLEAR].

For example, to enter "Tom Jones":

1 Press [8] four times.

2 Press [6] three times, then press [▶].

3 Press [6] once, then press [▶] twice.

4 Press [5] four times, press [6] three times, then press [▶].

5 Press [6] twice, press [3] twice, then press [7] four times.

For assistance, please call: 1-800-211-PANA(7262)

→ Directory

Finding Stored Items

Make sure that the handset is on the cradle, the AC adaptor is connected and the SP-PHONE/HEADSET indicator light is off.

- 1 Press [◀] or [▶] to enter the directory list.
 - You can go to the Caller List by pressing [▶] (p. 30).

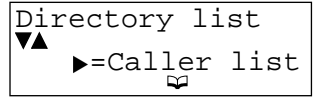

- 2 Scroll to the desired item by pressing [▼] or [▲].
 - All directory items are stored in the order shown on the right.

To search for a name by initial:

- (1) Press the dialing button for the first letter of the desired name until any name with the same initial is displayed (see the Index table below).
Ex. To find “Frank”, press [3] repeatedly until the first item under “F” is displayed.
- (2) Press [▼] repeatedly until the name is displayed.

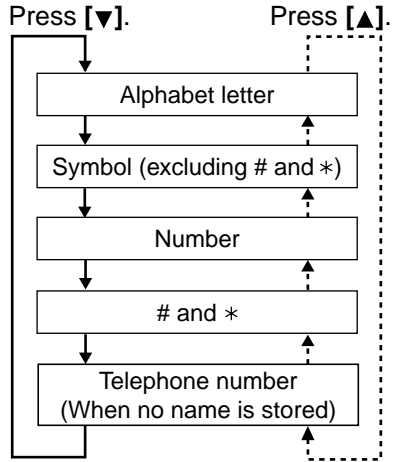

- You can exit the directory list any time by pressing [EXIT].
- If “No items stored” is displayed in step 1, the directory is empty. To exit the directory list, press [EXIT].
- If you do not press any buttons for 60 seconds, the unit will exit the directory list.

Index table

| Keys | Index | Keys | Index |
|------|-------------------------|------|---------------|
| [1] | Space, Other symbols, 1 | [6] | M, N, O, 6 |
| [2] | A, B, C, 2 | [7] | P, Q, R, S, 7 |
| [3] | D, E, F, 3 | [8] | T, U, V, 8 |
| [4] | G, H, I, 4 | [9] | W, X, Y, Z, 9 |
| [5] | J, K, L, 5 | [0] | 0 |



Dialing

- 1 Press [**◀**] or [**▶**] to enter the directory list.

```
Directory list
▼▲ ▶=Caller list
Ⓜ
```

- 2 Scroll to the desired item that you want to dial by pressing [**▼**] or [**▲**].

```
Frank
456-7890
Ⓜ
```

- To search for the item by initial, see page 40.
- To exit the directory list, press [**EXIT**].

- 3 Lift the handset or press [**SP-PHONE/HEADSET**] or a line button.

- The number is dialed automatically.

- 4 To hang up, place the handset on the cradle or press [**SP-PHONE/HEADSET**].

- You can also dial the stored number as follows:

1. Lift the handset or press [**SP-PHONE/HEADSET**] or a line button.
2. Find the desired item (follow steps 1 and 2 above).
3. Press [**ENTER**] (Send key).
 - The number is dialed automatically.

```
Frank
456-7890
ENTER=Send
Ⓜ
```

→ Directory

Editing

Make sure that the handset is on the cradle, the AC adaptor is connected and the SP-PHONE/HEADSET indicator light is off.

1 Press [**◀**] or [**▶**] to enter the directory list.

2 Scroll to the directory item you want to change by pressing [**▼**] or [**▲**].

- To search for the item by initial, see page 40.

```
Jane
456-7890
  
```

3 Press [**FUNCTION/EDIT**].

```
Enter name
Jane
◀▶          ▼=Next
  
```

4 Edit the name using the dialing buttons (**[0]** to **[9]**), up to 15 characters (p. 39).

- To move the cursor, press [**◀**] or [**▶**].
- If you do not need to change the name, press [**▼**] (Next key) and go to step 6.

```
Enter name
Jane Walker
  
```

5 Press [**▼**] (Next key).

```
4567890
◀▶          ▼=Next
  
```

6 Add a number to the current number.

- Each time you press [**CLEAR**], a digit is erased. To erase all of the digits, press and hold [**CLEAR**].
- To move the cursor, press [**◀**] or [**▶**].
- If you do not need to change the number, press [**▼**] (Next key) and go to step 8.

```
12344567890
◀▶          ▼=Next
  
```

7 Press [**▼**] (Next key).

- If you want to change the name or number, press [**▲**] to reach the desired display and change it.

```
Jane Walker
1-234-456-7890
          ENTER=Save
  
```

8 Press [**ENTER**] (Save key).

- A beep sounds.
- To continue editing other items, repeat from step 2.

- You can exit the edit mode any time by pressing [**EXIT**].

Erasing

Make sure that the handset is on the cradle, the AC adaptor is connected and the SP-PHONE/HEADSET indicator light is off.

1 Press [◀] or [▶] to enter the directory list.

2 Scroll to the directory item that you want to erase by pressing [▼] or [▲].

- To search for the item by initial, see page 40.

3 Press [CLEAR].

- To stop erasing, press [◀] (No key).



4 Press [ENTER] (Yes key) or [CLEAR].

- A beep sounds and the item is erased.
- To erase other items, repeat from step 2.
- To exit the directory list, press [EXIT].

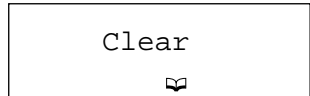

One-Touch Dialer

Storing Names and Numbers

You can store up to 3 names and phone numbers in the one-touch auto dial buttons.

Do not press any one-touch auto dial buttons before storing to prevent misoperation.

Make sure that the handset is on the cradle, the AC adaptor is connected and the SP-PHONE/HEADSET indicator light is off.

1 Press **[FUNCTION/EDIT]**.

```
-----  
▶ Save M1,M2,M3  
Save directory
```

2 Press **[▶]** at "Save M1,M2,M3".

```
Enter name  
█  
◀▶ ▶=Next
```

3 Enter a name, up to 15 characters with the dialing buttons (**[0]** to **[9]**) (p. 39).

- To move the cursor, press **[◀]** or **[▶]**.
- If a name is not required, press **[▼]** (Next key) and go to step 5.

```
Enter name  
John White  
◀▶ ▶=Next
```

4 Press **[▼]** (Next key).

```
Enter phone no.
```

5 Enter a phone number up to 22 digits.

- Each time you press **[CLEAR]**, a digit is erased. To erase all of the digits, press and hold **[CLEAR]**.

```
2345678901█  
◀▶ ▶=Next
```

6 Press **[▼]** (Next key).

- If you want to change the name or number, press **[▲]** to reach the desired display and change it.

```
John White  
234-567-8901  
M1,M2,M3=Save
```

7 Press one of the one-touch auto dial buttons (**[M1]**, **[M2]** or **[M3]**).

- A beep sounds.
- To continue storing an item to another one-touch auto dial button, repeat from step 2.
- To exit the programming mode, press **[EXIT]**.

```
John White  
234-567-8901
```

- When using the Dial Lock (p. 57) or Call Restriction feature (p. 58), you cannot store an item in a one-touch auto dial button ([M1] to [M3]). 3 beeps will be heard in step 2.
- You can exit the programming mode any time by pressing [EXIT].
- If a pause is required for dialing, press [PAUSE] where needed. If required, you can also insert [FLASH] in a phone number. Pressing [PAUSE] or [FLASH] counts as one digit (p. 52, 53).

To erase a stored number

1 Press the one-touch auto dial button ([M1], [M2] or [M3]) you want to erase.

- The stored item is displayed with the button number (#1 to #3).

| | |
|----------------------------|----|
| John White 234-567-8901 | #1 |
|----------------------------|----|

2 Press [CLEAR].

- To stop erasing, press [◀] (No key).

| |
|---------------------|
| Clear? |
| ◀=No ENTER=Yes |

3 Press [ENTER] (Yes key) or [CLEAR].

- A beep sounds, "Clear" is displayed and the information is erased.
- "Empty" is displayed.

Dialing a Stored Number

1 Lift the handset or press [SP-PHONE/HEADSET] or a line button.

2 Press the desired one-touch auto dial button ([M1], [M2] or [M3]).

- The stored number is displayed and dialed.

OR

1 Press the desired one-touch auto dial button ([M1], [M2] or [M3]).

- The stored number is displayed.

2 Lift the handset or press [SP-PHONE/HEADSET] or a line button.

- You can dial numbers stored in the one-touch auto dial buttons ([M1], [M2] and [M3]) even if the Dial Lock (p. 57) or Call Restriction feature (p. 58) is on.

Intercom

A 2-way intercom can be set up between two extensions.

Make sure that each extension has been assigned the number ([1] to [8]) (p. 17) and is connected to the LINE1/2 telephone jack of the unit (p. 11-13).

Paging a Designated Extension

1 Press **[INTERCOM]**.

- The INTERCOM indicator lights.
- The SP-PHONE/HEADSET indicator lights and the speakerphone turns on.
- To switch from the speakerphone to the handset, lift it off the cradle.

```
Intercom
Press EXT1~EXT8
      or PAGE
```

2 Press an extension button (**[EXT1]** to **[EXT8]**).

- A long beep is heard if the ringer pattern of the paged extension is a ringer tone (p. 23).*

Ex. Calling EXT. 2

```
Intercom
Calling [ 2 ]
```

3 After the paged extension answers, talk into the **MIC** (microphone) or handset.

- The display shows the length of the call.

Ex. Intercom with EXT. 2

```
Intercom [ 1 ]-[ 2 ]
00-00-00
```

4 To end the intercom, press **[SP-PHONE/HEADSET]** or place the handset on the cradle.

- The INTERCOM and SP-PHONE/HEADSET indicator lights go out.

* If 2 short beeps are heard in step 2, the ringer pattern of the paged extension is the Voice mode, the Auto Answer mode or the Room Monitor mode. Speak into the **MIC** or handset to page the extension for the Voice or Auto Answer mode.

- If the destination extension is the Auto Answer or Room Monitor mode, "Calling" with the extension number will not be displayed on your unit.

During an intercom call:

- To adjust the handset or speaker volume, press **VOLUME** [**^**] or [**v**] (p. 26).
- If the other extensions are busy with intercom or page, you will hear a busy tone and "Busy" will be displayed when you press **[INTERCOM]**. Wait until the INTERCOM indicator light goes out.
- You can place the intercom call on hold by pressing **[HOLD]**. To release the hold, press **[INTERCOM]**.
- If an incoming call is being received, you will hear two tones (incoming call tone, p. 54) and the line indicator will flash quickly. To answer the call, press the called line button.
- You can switch from the speakerphone to the handset by lifting it off the cradle. To switch back to the speakerphone, press **[SP-PHONE/HEADSET]**. You can place the handset on the cradle.



To answer a page

The INTERCOM indicator light flashes quickly (for the Ringer tone or Voice mode) and the paging extension is displayed. Depending on the ringer pattern setting (p. 23), your unit will function as follows:

Ringer tone (1 to 8): The selected tone rings.

Voice mode: The paging party's voice is heard through the speaker after 2 short beeps.

Auto Answer mode: After 2 short beeps, the speakerphone turns on automatically. You can then talk with the caller.

Lift the handset off the cradle or press **[SP-PHONE/HEADSET]** or **[INTERCOM]** to answer the page.

OR

If your unit is set to the Auto Answer mode, just speak into the **MIC**.

Ex. EXT. 2 calling

```
Intercom
Call from[2]
```

- If the ringer volume is set to OFF for Intercom, your unit will not ring.
- If the ringer pattern of your unit is the Voice, Auto Answer or Room Monitor mode, the unit will not ring.

To answer an intercom call directed to another extension

If the paged extension user is not available, you can answer the page with your extension.

Press **[INTERCOM]**, and press **[PAGE]**.

- If the paged extension is in the Auto Answer mode or the Room Monitor mode, you cannot answer that page.

What the INTERCOM indicator means

| | |
|--------------------------------|--|
| Off | Intercom is free. |
| On | You are using the intercom. |
| Flashing twice every 2 seconds | Other extension(s) is(are) using the intercom. |
| Flashing | You place the intercom call on hold. |
| Flashing quickly | An intercom call is being received. |

→ Intercom

Paging All Extensions

- 1 Press **[INTERCOM]**.
 - The INTERCOM indicator lights.
 - The SP-PHONE/HEADSET indicator lights and the speakerphone turns on.

```
Intercom
Press EXT1~EXT8
or PAGE
```

- 2 Press **[PAGE]**, and after 2 short beeps announce the page using the **MIC** or the handset.
 - The other extensions will hear your paging voice through the speaker after 2 short beeps.

```
Intercom
Paging [ALL]
```

- 3 After one of the paged extension answers, talk into the **MIC** or the handset.

- You can only talk with an extension who answers first.

Transferring an External Call to Another Extension

You can transfer an external call to another extension.

- 1 Press **[HOLD]** to place the call on hold.
 - The line indicator light flashes.

```
Hold
Press EXT1~EXT8
to transfer
```

- 2 Press an extension button (**[EXT1]** to **[EXT8]**) to page.
 - If the paged extension does not answer, press the relevant line button.

Ex. Calling EXT. 2

```
Intercom
Calling [2]
```

- 3 If required, wait for the paged extension to answer, and you can announce the transfer. If not required, go to step 4.

- 4 To complete the transfer, place the handset on the cradle or press **[SP-PHONE/HEADSET]** to hang up.

- Any extensions can take a transferred call by pressing the relevant line button.
- **To page all extensions**, in step 2, press **[INTERCOM]** then **[PAGE]**. Speak into the **MIC** or handset. After one of the extensions answers, hang up to complete the transfer.

Room Monitor Feature

This feature allows you to monitor a room through an extension using the intercom feature. For example you can monitor a baby from different areas of the house. You can call the destination extension, to monitor the room.

Turn the Room Monitor mode ON with the destination extension (p. 23, 24).

Make sure that the destination unit must not be used and the handset is on the cradle and the AC adaptor is connected.

- 1 Press **[INTERCOM]**.
 - The INTERCOM indicator lights.
 - The SP-PHONE/HEADSET indicator lights and the speakerphone turns on.

```
Intercom
Press EXT1~EXT8
or PAGE
```

- 2 Press an extension button (**[EXT1]** to **[EXT8]**).
 - The destination extension does not ring and the SP-PHONE/HEADSET indicator lights.
 - Your unit starts to monitor the room through the extension.
 - To monitor from the handset, lift it off the cradle. To switch back to the speaker, press **[SP-PHONE/HEADSET]**.

Monitoring EXT. display
Ex. EXT. 1 monitors EXT. 2

```
Intercom [1]-[2]
00-00-00
```

- 3 To end monitoring, press **[SP-PHONE/HEADSET]** or place the handset on the cradle.

Monitored EXT. display
Ex. Monitored by EXT. 1

```
Intercom
Call from [1]
```

- The monitored extension user can stop being monitored by pressing **[SP-PHONE/HEADSET]**.

Making/Answering Another Call During a Conversation

You can handle two external calls, or an external call and an intercom call simultaneously.

Making/answering another external call during a conversation

If you hear **two tones** during a conversation and another line indicator light flashes quickly, an incoming call is being received. You can answer the second call while holding the first call. If you subscribe to a Caller ID service, the second caller's information will be displayed when a call is being received on the other line (p. 29).

You can delete the **two tones** (incoming call tone). See page 54.

Ex. If you are using LINE1

- 1 Press **[HOLD]** to put the first call (LINE 1) on hold.
 - The LINE 1 indicator light flashes.
 - 2 Press the other line button (**[LINE 2/DATA]**) to make or answer a second call.
 - The LINE 2 indicator lights.
 - 3 To return to the first call (LINE 1), press the line button for the first call (**[LINE 1]**).
 - The second call is terminated.
- To hold the second call in step 3, press **[HOLD]** before pressing the line button for the first call.

Making an intercom call during a conversation

- 1 Press **[HOLD]** to put the external call on hold.
 - The line indicator light flashes.
 - 2 Press an extension button (**[EXT1]** to **[EXT8]**).
 - To page all extensions, press **[INTERCOM]** then **[PAGE]**.
 - 3 After the paged extension answers, talk into the **MIC** or handset.
 - 4 To return to the external call, press the line button.
 - The line indicator stops flashing and remains lit. The intercom call is terminated.
- To hold the intercom call in step 4, press **[HOLD]** then the line button.

| |
|--|
| Hold Press EXT1~EXT8 to transfer |
|--|

Conference

Conference with two external calls

While having a conversation on one line, you can make or answer a second call on the other line and then combine the calls to make a conference call.

- 1 During a call, press **[HOLD]** to put the first call on hold.
- 2 Press the other line button to make or answer a second call.
- 3 When the second call is connected, press **[CONF]** to make a conference call.
 - **To hang up both lines**, place the handset on the cradle or press **[SP-PHONE/HEADSET]**.
 - **To hang up only one line**, press the line button for the party with which you want to continue talking.
 - **To put both lines on hold**, press **[HOLD]**. To talk with only one caller, press the relevant line button. To resume both lines press **[CONF]**.

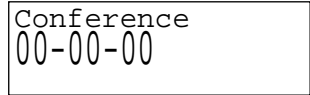

Conference
00-00-00

- You cannot call another extension to make a conference call.

Conference with an external call and an internal call

While you are talking with an outside caller, you can call another extension to make a conference call.

- 1 During a call, press **[HOLD]**.
 - The call is put on hold.
- 2 To page another extension, press an extension button (**[EXT1]** to **[EXT8]**).
- 3 When the paged party answers, press **[CONF]** on your unit to make a conference call.
 - **To hang up both the external and internal calls**, place the handset on the cradle or press **[SP-PHONE/HEADSET]**.
 - **To hang up only the intercom call**, press the line button.
 - **To hang up only the external call**, press **[INTERCOM]**.

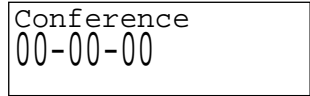

Conference
00-00-00

- You can place the conference call on hold in step 3. Press **[HOLD]**. To resume the conference call, press **[CONF]** on your unit.

For assistance, please call: 1-800-211-PANA(7262)

Special Features

How to Use the PAUSE Button (For PBX Line/Long Distance Calls)

We recommend you press **[PAUSE]** if a pause is required for dialing with a PBX or to make a long distance call.

Ex. Line access number **[9]** (PBX)

[9] → **[PAUSE]** →

- Pressing **[PAUSE]** once creates a 3.5 second pause. This prevents misdialing when you redial or dial a stored number.
- Pressing **[PAUSE]** more than once increases the length of the pause between numbers.

Muting Your Conversation

Press **[MUTE]** while talking.

- “” and “[Mute]” are displayed.
- The other party cannot hear you but you can hear them.
- To release the mute, press **[MUTE]** again.
- When you switch between the handset and speaker, the mute will be released.

| | |
|---|---------|
| 12:34AM | 5/21[1] |
| 00-01-30 | [Mute] |
|  | |

For Call Waiting Service Users

If another call is received on the same line while talking, you will hear a call-waiting tone. Press **[FLASH]** to answer the second call.

- The first call is put on hold.
- To return to the first caller, press **[FLASH]** again.
- The call waiting service cannot be used when:
 - the first call on the same line is put on hold,
 - you are having a conference call on both lines (p. 51),
 - another extension is joining your conversation, or
 - a parallel connected telephone other than KX-TS3282B, KX-TS3282W or KX-T3281W is in use.
- If this function does not operate properly, consult your telephone company for details.

Call Waiting Caller ID Feature

Call Waiting Caller ID Feature allows the unit to display the second caller's information. After you hear a call-waiting tone while talking, the display will show the caller's name, the phone number, the called line and “Waiting”.

| |
|------------------|
| BROWN, NANCY |
| 1-555-666-7777 |
| -- L1 Waiting -- |

- Please contact your telephone company for details and availability in your area.



Temporary Tone Dialing (For Rotary or Pulse Service Users)

Press [*****] (TONE) before entering access numbers which require tone dialing.

- The dialing mode changes to tone. You can enter numbers to access an answering service, electronic banking service, etc. When you hang up, the mode will return to pulse.

FLASH Button

Pressing [**FLASH**] allows you to use special features of your host PBX such as transferring an extension call or accessing special telephone services (optional) such as call waiting.

- Pressing [**FLASH**] causes to disable the Temporary Tone Dialing mode or the mute (p. 52).

Selecting the flash time

The flash time depends on your telephone exchange or host PBX. You can select the following flash times: “80, 90, 100, 110, 200, 250, 300, 400, 600, 700 ms (milliseconds)”. Your phone comes from the factory set to “600 ms”.

Make sure that the handset is on the cradle, the AC adaptor is connected and the SP-PHONE/HEADSET indicator light is off.

1 Press [**FUNCTION/EDIT**].

| |
|-------------------|
| ----- |
| ▶ Save M1, M2, M3 |
| Save directory |

2 Scroll to “Dial setting” by pressing [**▼**] or [**▲**], and press [**▶**].

| |
|-----------------|
| Change password |
| ▶ Dial setting |
| Line setting |

3 Scroll to “Set flash time” by pressing [**▼**] or [**▲**].

| |
|------------------|
| Set dial mode |
| ▶ Set flash time |
| Call restrict |

4 Press [**▶**].

- The current settings are displayed.

| |
|--------------------|
| Flash time |
| <u>Line1</u> Line2 |
| <u>600ms</u> 600ms |

5 Select the desired time by pressing [**▼**] or [**▲**] for each line.

To move to the other line, press [**▶**] or [**◀**].

6 Press [**ENTER**].

- A beep sounds.
- To exit the programming mode, press [**EXIT**].

- You can exit the programming mode any time by pressing [**EXIT**].
- If the unit is connected via a PBX, PBX functions (transferring a call etc.) might not work correctly. Consult your PBX supplier for the correct setting.

→ Special Features

Incoming Call Tone

During a conversation, you can be informed if another call arrives on another line (Line 1 or 2 or Intercom line). If you set to ON, this incoming call tone will be heard for as long as the external or internal line rings. To delete the incoming call tone, set to OFF. To set the incoming call tone to sound twice, set to "2". Your phone comes from the factory set to "2".

Make sure that the handset is on the cradle, the AC adaptor is connected and the SP-PHONE/HEADSET indicator light is off.

1 Press [FUNCTION/EDIT].

```
-----  
▶ Save M1,M2,M3  
Save directory
```

2 Scroll to "Ringer setting" by pressing [▼] or [▲].

```
LCD contrast  
▶ Ringer setting  
Change password
```

3 Press [▶].

```
-----  
▶ Ringer volume  
Ringer pattern
```

4 Scroll to "Incoming call" by pressing [▼] or [▲].

```
Ringer pattern  
▶ Incoming call  
-----
```

5 Press [▶].

• The current setting is displayed.

```
Incoming call  
tone:2  
▼▲ ENTER=Save
```

6 Select "On", "Off" or "2" by pressing [▼] or [▲].

7 Press [ENTER] (Save key).

- A beep sounds.
- To exit the programming mode, press [EXIT].

• You can exit the programming mode any time by pressing [EXIT].



Line Selection

The unit will automatically select a free external line when you make a call by lifting the handset or pressing **[SP-PHONE/HEADSET]**. The unit will also select the in-coming called line when you answer the in-coming call. You can change the line selection. There are four options as following:

Line 1: Line 1 will be selected.

Line 2: Line 2 will be selected.

Intercom: Intercom line will be selected.

Auto (factory preset): A free external line will be selected (Line1 has priority) when making a call by lifting the handset or pressing **[SP-PHONE/HEADSET]**. However, when you call back from the Caller List (p. 32), the line that is indicated will be selected. You can also select any line by pressing a line button. When a call is being received, the called line is selected when you lift the handset or press **[SP-PHONE/HEADSET]**.

Make sure that the handset is on the cradle, the AC adaptor is connected and the SP-PHONE/HEADSET indicator light is off.

1 Press **[FUNCTION/EDIT]**.

```
-----
▶ Save M1,M2,M3
  Save directory
```

2 Scroll to "Line setting" by pressing **[▼]** or **[▲]**.

```
Dial setting
▶ Line setting
  Caller ID edit
```

3 Press **[▶]**.

```
-----
▶ Line selection
  Call barge in
```

4 Press **[▶]** at "Line selection".
• The current setting is displayed.

```
Line selection
:Auto
▼▲ ENTER=Save
```

5 Select the desired line selection, "Line1", "Line2", "Intercom" or "Auto" by pressing **[▼]** or **[▲]**.

6 Press **[ENTER]** (Save key).
• A beep sounds.
• To exit the programming mode, press **[EXIT]**.

• You can exit the programming mode any time by pressing **[EXIT]**.

→ Special Features

Setting the Password

You can change the password for the dial lock (p. 57) and call restriction (p. 58).

The factory preset password is "1111".

To set the password

Make sure that the handset is on the cradle, the AC adaptor is connected and the SP-PHONE/HEADSET indicator light is off.

1 Press **[FUNCTION/EDIT]**.

```
-----  
▶ Save M1,M2,M3  
Save directory
```

2 Scroll to "Change password" by pressing **[▼]** or **[▲]**.

```
Ringer setting  
▶ Change password  
Dial setting
```

3 Press **[▶]**.

```
Current password  
:-----  
▼=Next
```

4 Enter the current password.
• The factory preset is "1111".

```
Current password  
:0000  
▼=Next
```

5 Press **[▼]** (Next key).
• If 3 beeps are heard, you entered a wrong password. Enter the correct one.

```
Enter password  
:-----  
ENTER=Save
```

6 Enter a new password using a 4-digit number. (Ex. "1234" is entered.)

```
Enter password  
:1234  
ENTER=Save
```

7 Press **[ENTER]** (Save key).
• A beep sounds.
• To exit the programming mode, press **[EXIT]**.

• You can exit the programming mode any time by pressing **[EXIT]**.

Once you have set a PIN code, you cannot confirm it. If you forget your PIN code, please call: 1-800-211-PANA(7262).



Dial Lock

Except for the numbers stored in the one-touch auto dial buttons (p. 44), you can prevent others from making a call to any number. Only incoming calls are accepted until the dial lock is canceled.

Before using this feature, we recommend storing emergency numbers in the memory of one-touch auto dial buttons (p. 44). Even if the dialing buttons are locked, the numbers stored in these buttons can be dialed.

To set the dial lock

- 1 Press **[DIAL LOCK]**.
 - “” flashes on the display.

```

Enter password
:-----
ENTER=Save



```

- 2 Enter the password (p. 56).

```

Enter password
:oooo
ENTER=Save

```

- 3 Press **[ENTER]** (Save key).
 - A beep sounds and “” stops flashing and remains on the display.
 - If 3 beeps are heard, you entered a wrong password. Enter the correct one.

- You can exit the programming mode any time by pressing **[EXIT]**.

“” is displayed when the mode is on. If the dial buttons are pressed after lifting the handset or pressing **[SP-PHONE/HEADSET]** or a line button, “DIAL LOCKED” will be displayed for a few seconds.

- While the dialing buttons are locked, you cannot store phone numbers in the memory of one-touch auto dial buttons.

To cancel the dial lock

- Repeat steps 1 to 3 above.
- “” will disappear on the display.

→ Special Features

Call Restriction

You can prevent the unit from dialing phone numbers beginning with specified digit(s) (1 digit or 2 digits). Except for the numbers stored in the memory of one-touch auto dial buttons (p. 44), phone numbers with the restricted leading digits cannot be dialed out.

Before using this feature, we recommend storing emergency numbers in the memory of one-touch auto dial buttons (p. 44). Even if the phone numbers are restricted, the numbers stored in these buttons can be dialed.

To set the call restriction

Make sure that the handset is on the cradle, the AC adaptor is connected and the SP-PHONE/HEADSET indicator light is off.

1 Press [FUNCTION/EDIT].

```
-----  
▶ Save M1, M2, M3  
  Save directory
```

2 Scroll to “Dial setting” by pressing [▼] or [▲].

```
Change password  
▶ Dial setting  
  Line setting
```

3 Press [▶].

```
-----  
▶ Set dial mode  
  Set flash time
```

4 Scroll to “Call restrict” by pressing [▼] or [▲].

```
Set flash time  
▶ Call restrict  
-----
```

5 Press [▶].

```
Restrict no.  
:--  
ENTER=Save
```

If you changed the password from “1111” (factory preset) to another one, “Enter password” is displayed. Enter the password (p. 56), and press [▼] (Next key).

```
Enter password  
:----  
▼=Next
```

• If 3 beeps are heard, you entered a wrong password. Enter the correct one.

```
Enter password  
:oooo  
▼=Next
```



6 Enter the first number(s) (1 digit or 2 digits) you want to restrict (**[0]** to **[9]**).

- If you enter a wrong number, press **[CLEAR]** and enter the correct one.

Ex. "9" is entered.

```
Restrict no.
           : -9
           ENTER=Save
```

7 Press **[ENTER]** (Save key).

- A beep sounds.
- To exit the programming mode, press **[EXIT]**.
- You can exit the programming mode any time by pressing **[EXIT]**.
- While you restrict phone numbers beginning with specified digit(s), you cannot store phone numbers in the memory of one-touch auto dial buttons.

When dialing a phone number with the restricted leading digit(s), "CALL RESTRICTED" is displayed.

To cancel the call restriction

Repeat steps 1 to 5 on page 58. Then press **[CLEAR]** to clear the restricted digits, and press **[ENTER]** (Save key).

→ Special Features

Call Privacy Feature

The Call Privacy feature allows you to prevent other extensions from joining your conversation with an outside party. If you allow other extensions to join your conversation (Call Barge In feature), select “Accept”.

Your phone comes from the factory set to “Reject”.

Make sure that the handset is on the cradle, the AC adaptor is connected and the SP-PHONE/HEADSET indicator light is off.

1 Press [FUNCTION/EDIT].

```
-----  
▶ Save M1,M2,M3  
Save directory
```

2 Scroll to “Line setting” by pressing [▼] or [▲].

```
Dial setting  
▶ Line setting  
Caller ID edit
```

3 Press [▶].

```
-----  
▶ Line selection  
Call barge in
```

4 Scroll to “Call barge in” by pressing [▼] or [▲].

```
Line selection  
▶ Call barge in  
-----
```

5 Press [▶].

• The current setting is displayed.

```
Call barge in  
:Reject  
▼▲ ENTER=Save
```

6 Select “Accept” or “Reject” by pressing [▼] or [▲].

7 Press [ENTER] (Save key).

- A beep sounds.
- To exit the programming mode, press [EXIT].

• You can exit the programming mode any time by pressing [EXIT].

To join a conversation (Call Barge In)

If your unit is set to “Accept”, other extensions can join your conversation with an outside party. The other extension users can press the relevant line button to join you.

- The intercom feature may not work when more than three extensions join another extension’s conversation.
- You cannot join a conversation between the other extensions and an outside party unless all conversing extensions are set to “Accept”. When you tried to join the conversation, “Busy” is displayed.

Optional Headset

Plugging an optional headset into the unit allows a hands-free phone conversation. Please use only a Panasonic KX-TCA60, KX-TCA86, KX-TCA88, KX-TCA91 or KX-TCA92 headset. To order, call the accessories telephone number on page 3.

Connecting the Optional Headset to the Unit

Connect the optional headset to the headset jack as shown below.

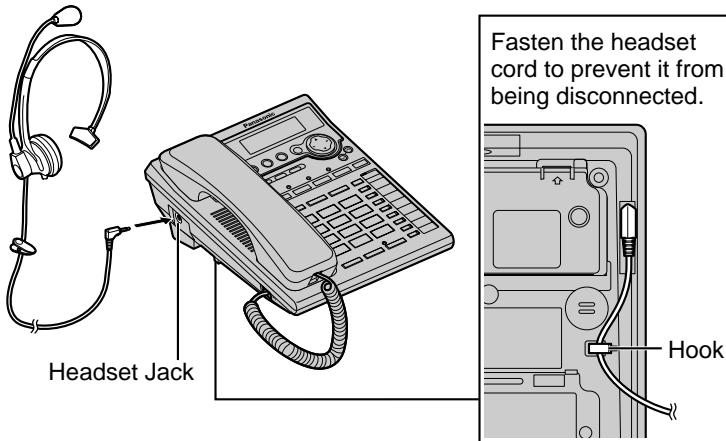

- The illustration of the headset is KX-TCA88.

If you want to have a normal conversation, disconnect the headset.

Making/Answering Calls

- 1 Press **[SP-PHONE/HEADSET]** to make or answer a call.
 - If you misdial when making a call, press **[SP-PHONE/HEADSET]** twice and dial again.
 - You can press the line button, instead of pressing **[SP-PHONE/HEADSET]**.
- 2 To hang up, press **[SP-PHONE/HEADSET]**.

To adjust the headset receiver volume (4 levels):

While using the headset, press **VOLUME [^]** or **[v]**.

- "■ ■ ■" shows one level.
- During a conversation using the headset, you cannot switch the call to the handset by lifting it off the cradle.
- If you disconnect the optional headset during a conversation with the handset on the cradle, the call will be switched to the speakerphone.
- During a conversation using the speakerphone, you can switch the call to the headset by connecting the headset.

For assistance, please call: 1-800-211-PANA(7262)

Wall Mounting

This unit can be mounted on a wall phone plate.

- 1 Pull down the handset hook until it locks, **so the tab holds the handset.**

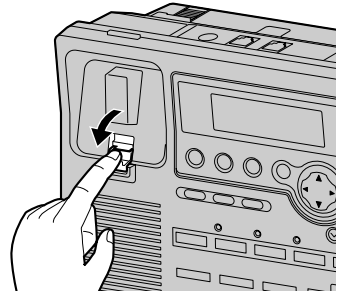

- 2 Press the tabs in the direction of the arrows (①), then remove the wall mounting adaptor (②).

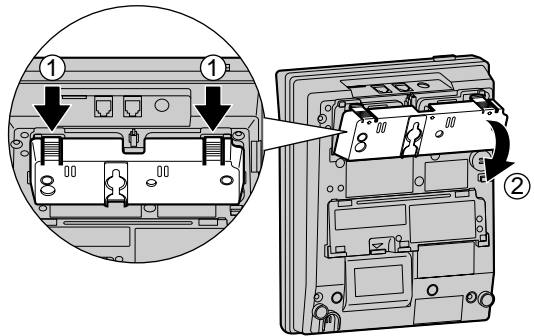

- 3 Connect the AC adaptor. Tuck the telephone line cord inside the wall mounting adaptor, then push it in the direction of the arrows (① and ②).

- The word "UP" should face upward.

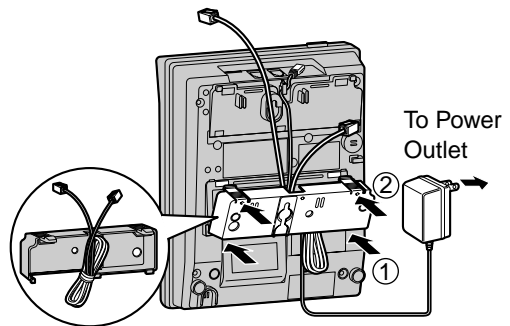

-
- 4 Connect the telephone line cord.
Mount the unit, then slide down.

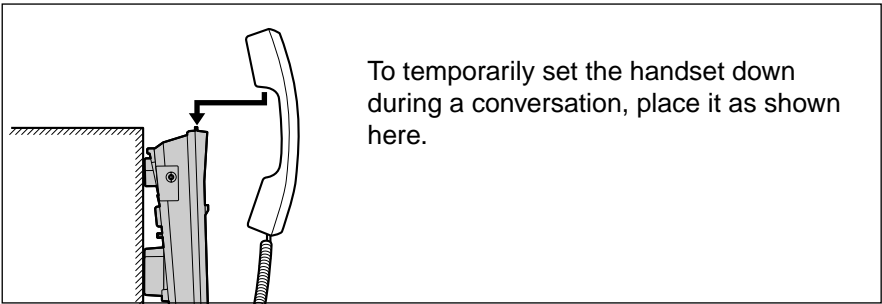
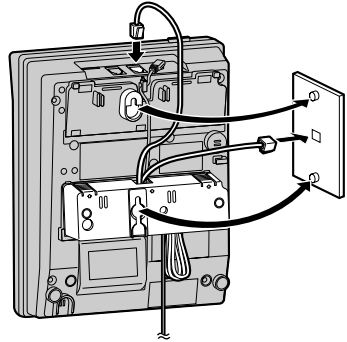

To temporarily set the handset down during a conversation, place it as shown here.

Troubleshooting

| Problem | Cause and Remedy | |
|--|---|--|
| The unit does not work. | <ul style="list-style-type: none">• Check the settings (p. 9–14).• Unplug the AC adaptor and remove the batteries to reset. Plug in and re-install the batteries, and try again.• Other communication devices connected on the same line may be interfering with your unit.• Telephone line noise may be interfering with your unit. Consult your telephone company. | |
| The unit does not ring. | <ul style="list-style-type: none">• The ringer volume is set to OFF for the line. Set to HIGH or LOW (p. 22). | |
| You cannot dial. | <ul style="list-style-type: none">• Check whether the dialing mode selection is correct (p. 20).• Dial lock mode is set. To cancel the mode, see page 57.• The dialed number is restricted. To cancel, see page 59. | |
| The line indicators do not work properly. | <ul style="list-style-type: none">• Check the settings (p. 9-14). | |
| The other party suddenly cannot hear your voice during a conversation. | <ul style="list-style-type: none">• [MUTE] may have been pressed during the conversation. If “You cannot program function items. | <ul style="list-style-type: none">• Programming is not possible when the handset is off the cradle, the SP-PHONE/ HEADSET indicator lights, or when searching the Caller List or the directory list.• Do not pause for over 60 seconds while programming. |



| Problem | Cause and Remedy |
|--|--|
| You cannot store a name and phone number in memory. | <ul style="list-style-type: none">• Programming is not possible when the handset is off the cradle or the SP-PHONE/ HEADSET indicator lights.• Do not pause for over 60 seconds while storing.• Do not enter a phone number more than 22 digits long.• When using the Dial Lock (p. 57) or Call Restriction feature (p. 58), you cannot store a phone number in the one-touch auto dial buttons ([M1] to [M3]).• If "Directory full" is displayed, erase other stored items from the directory (p. 43). |
| While programming or searching, the unit starts to ring and stops the program/ search. | <ul style="list-style-type: none">• To answer the call, lift the handset or press [SP-PHONE/HEADSET]. Start again from the beginning after hanging up. |
| The unit does not display the caller's name and/or phone number. | <ul style="list-style-type: none">• You need to subscribe to a Caller ID service.• Other telephone equipment may be interfering with your phone. Disconnect it and try again.• Other electrical appliances connected to the same outlet may be interfering with the Caller ID information.• Telephone line noise may be interfering with the Caller ID information. Consult your telephone company.• The caller requested not to send his/her information. See page 29.• If a call is being transferred to you, the caller information will not be displayed. |
| The display exits the Caller List. | <ul style="list-style-type: none">• Do not pause for over 60 seconds while searching. |
| You cannot redial by pressing [REDIAL]. | <ul style="list-style-type: none">• If the last number dialed was more than 32 digits long, the number will not be redialed correctly. |

→ Troubleshooting

| Problem | Cause and Remedy |
|--|---|
| When you press [INTERCOM] , a busy tone sounds and you cannot page another extension. | <ul style="list-style-type: none">• The intercom line is being used. Wait until the INTERCOM indicator light goes out. |
| You cannot call a designated extension. | <ul style="list-style-type: none">• The called extension may have been set to the room monitor mode. To talk to the extension, select another ringer pattern on that extension (p. 23, 24). |
| The intercom does not work. | <ul style="list-style-type: none">• DSL Internet connection and KX-TS3282B/ KX-TS3282W Intercom work at similar frequencies. Please contact Panasonic at 1-800-211-PANA(7262) for special wiring configurations. |
| You cannot have a conversation using an optional headset. | <ul style="list-style-type: none">• Make sure that the headset is connected properly (p. 61).• During a power failure, you cannot use the headset. |
| During a power failure, you cannot make or answer a call. | <ul style="list-style-type: none">• Make sure that batteries have been installed properly (p. 9).• The batteries may have been discharged. In that case replace all of the batteries with new ones. |
| If you cannot solve your problem | <ul style="list-style-type: none">• Call our customer call center at 1-800-211-PANA(7262).• Panasonic's e-mail address for customer inquiries: consumerproducts@panasonic.com for customers in the USA or Puerto Rico ONLY |

Important Safety Instructions



When using this unit, basic safety precautions should always be followed to reduce the risk of fire, electric shock, or personal injury.

1. Read and understand all instructions.
2. Follow all warnings and instructions marked on this unit.
3. Unplug this unit from AC outlets before cleaning. Do not use liquid or aerosol cleaners. Use a damp cloth for cleaning.
4. Do not use this unit near water, for example, near a bathtub, washbowl, kitchen sink, or the like.
5. Place this unit securely on a stable surface. Serious damage and/or injury may result if the unit falls.
6. Do not cover slots and openings on the unit. They are provided for ventilation and protection against overheating. Never place the unit near radiators, or in a place where proper ventilation is not provided.
7. Use only the power source marked on the unit. If you are not sure of the type of power supplied to your home, consult your dealer or local power company.
8. Do not place objects on the power cord. Install the unit where no one can step or trip on the cord.
9. Do not overload wall outlets and extension cords. This can result in the risk of fire or electric shock.
10. Never push any objects through slots in this unit. This may result in the risk of fire or electric shock. Never spill any liquid on the unit.
11. To reduce the risk of electric shock, do not disassemble this unit. Take the unit to an authorized servicenter when service is required. Opening or removing covers may expose you to dangerous voltages or other risks. Incorrect reassembly can cause electric shock when the unit is subsequently used.
12. Unplug this unit from the wall outlet and refer servicing to an authorized servicenter when the following conditions occur:
 - A. When the power supply cord or plug is damaged or frayed.
 - B. If liquid has been spilled into the unit.
 - C. If the unit has been exposed to rain or water.
 - D. If the unit does not work normally by following the operating instructions. Adjust only controls covered by the operating instructions. Improper adjustment may require extensive work by an authorized servicenter.
 - E. If the unit has been dropped or physically damaged.
 - F. If the unit exhibits a distinct change in performance.
13. During thunderstorms, avoid using telephones except cordless types. There may be a remote risk of an electric shock from lightning.
14. Do not use this unit to report a gas leak, when in the vicinity of the leak.

SAVE THESE INSTRUCTIONS

For assistance, please call: 1-800-211-PANA(7262)

→ Important Safety Instructions

WARNING:

TO PREVENT FIRE OR SHOCK HAZARD, DO NOT EXPOSE THIS PRODUCT TO RAIN OR ANY TYPE OF MOISTURE.

- The AC adaptor is used as the main disconnect device, ensure that the AC outlet is located/installed near the unit and is easily accessible.

CAUTION:

To reduce the risk of fire or injury to persons, read and follow these instructions.

1. Use only the battery(ies) specified.
2. Do not dispose of the battery(ies) in a fire. It (they) may explode. Check with local waste management codes for special disposal instructions.
3. Do not open or mutilate the battery(ies). Released electrolyte is corrosive and may cause burns or injury to the eyes or skin. The electrolyte may be toxic if swallowed.
4. Exercise care in handling the battery(ies) in order not to short the battery(ies) to conductive materials such as rings, bracelets, and keys. The battery(ies) and/or conductor may overheat and cause burns.
5. Do not recharge the battery(ies) provided with or identified for use with this product. The battery(ies) may leak corrosive electrolyte or explode.
6. Do not attempt to rejuvenate the battery(ies) provided with or identified for use with this product by heating. Sudden release of battery electrolyte may occur causing burns or irritation to the eyes or skin.
7. Replace all batteries at the same time. Mixing fresh and discharged batteries could increase internal cell pressure and rupture the discharged batteries. (Applies to products employing more than one separately replaceable primary battery.)
8. When installing batteries observe the proper polarity or direction. Incorrect installation can cause charging, and may result in leakage or explosion. (Applies to products employing more than one separately replaceable primary battery.)
9. Remove the battery(ies) from this product if the product will not be used for a long period of time (several months or more). During this time the battery(ies) could leak in the product.
10. Discard the “dead” battery(ies) as soon as possible. The “dead” battery(ies) may leak in the product.
11. Do not store this product, or the battery(ies) provided with or identified for use with this product, in high temperature areas. Batteries that are stored in a freezer or refrigerator for the purpose of extending shelf life should be protected from condensation during storage and defrosting. Batteries should be stabilized at room temperature prior to use after cold storage.

FCC and Other Information



This equipment complies with Part 68 of the FCC rules and the requirements adopted by the ACTA. On the bottom of this equipment is a label that contains, among other information, a product identifier in the format US:ACJ-----.

If requested, this number must be provided to the telephone company.

Registration No. (found on the bottom of the unit)

Ringer Equivalence No. (REN)0.2B

A plug and jack used to connect this equipment to the premises wiring and telephone network must comply with the applicable FCC Part 68 rules and requirements adopted by the ACTA. A compliant telephone cord and modular plug is provided with this product. It is designed to be connected to a compatible modular jack that is also compliant.

The REN is used to determine the number of devices that may be connected to a telephone line. Excessive RENs on a telephone line may result in the devices not ringing in response to an incoming call. In most but not all areas, the sum of RENs should not exceed five (5.0). To be certain of the number of devices that may be connected to a line, as determined by the total RENs, contact the local telephone company. For products approved after July 23, 2001, the REN for this product is part of the product identifier that has the format US:AAAEQ##TXXXX. The digits represented by ## are the REN without a decimal point (e.g., 03 is a REN of 0.3).

If this equipment causes harm to the telephone network, the telephone company will notify you in advance that temporary discontinuance of service may be required. But if advance notice isn't practical, the telephone company will notify the customer as soon as possible. Also, you will be advised of your right to file a complaint with the FCC if you believe it is necessary.

The telephone company may make changes in its facilities, equipment, operations or procedures that could affect the operation of the equipment. If this happens the telephone company will provide advance notice in order for you to make necessary modifications to maintain uninterrupted service.

If trouble is experienced with this equipment, for repair or warranty information, please contact a Factory Servicenter or other Authorized Servicer. If the equipment is causing harm to the telephone network, the telephone company may request that you disconnect the equipment until the problem is resolved.

Connection to party line service is subject to state tariffs. Contact the state public utility commission, public service commission or corporation commission for information.

If your home has specially wired alarm equipment connected to the telephone line, ensure the installation of this equipment does not disable your alarm equipment. If you have questions about what will disable alarm equipment, consult your telephone company or a qualified installer.

→ FCC and Other Information

WHEN PROGRAMMING EMERGENCY NUMBERS AND/OR MAKING TEST CALLS TO EMERGENCY NUMBERS:

- 1) Remain on the line and briefly explain to the dispatcher the reason for the call.
- 2) Perform such activities in the off-peak hours, such as early morning or late evenings.

This device complies with Part 15 of the FCC Rules. Operation is subject to the following two conditions: (1) This device may not cause harmful interference, and (2) this device must accept any interference received, including interference that may cause undesired operation.

CAUTION:

Any changes or modifications not expressly approved by the party responsible for compliance could void the user's authority to operate this device.

Note:

This equipment has been tested and found to comply with the limits for a Class B digital device, pursuant to Part 15 of the FCC Rules. These limits are designed to provide reasonable protection against harmful interference in a residential installation. This equipment generates, uses, and can radiate radio frequency energy and, if not installed and used in accordance with the instructions, may cause harmful interference to radio communications. However, there is no guarantee that interference will not occur in a particular installation. If this equipment does cause harmful interference to radio or television reception, which can be determined by turning the equipment off and on, the user is encouraged to try to correct the interference by one or more of the following measures:

- Reorient or relocate the receiving antenna.
- Increase the separation between the equipment and receiver.
- Connect the equipment into an outlet on a circuit different from that to which the receiver is connected.
- Consult the dealer or an experienced radio/TV technician for help.

This equipment is hearing aid compatible as defined by the FCC in 47 CFR Section 68.316.

- **Environment** — do not place the unit in a room where the temperature is less than 5°C (41°F) or greater than 40°C (104°F). Allow 10 cm (4") clearance around the unit for proper ventilation. Avoid excessive smoke, dust, mechanical vibration, shock, or direct sunlight.
- **Routine care** — wipe the unit with a soft cloth. Do not use benzine, thinner, or any abrasive powder. When you leave the unit unused for a long period of time, unplug the AC adaptor from the outlet.
- **If there is any trouble** — disconnect the unit from the telephone line and connect a known working phone. If the known working phone operates properly, have your unit repaired by a Factory Servicer or other Authorized Servicer. If the known working phone does not operate properly, consult your telephone company.



| | |
|---|------------|
| A | |
| Accessories | 3 |
| Answering Calls | 28 |
| Assigning the extension number | 17 |
| Auto Answer mode..... | 23, 47 |
| B | |
| Battery installation | 9 |
| Battery replacement | 9 |
| C | |
| Call Barge In | 60 |
| Call on hold..... | 27, 46, 50 |
| Call Privacy..... | 60 |
| Call Restriction | 58 |
| Call Waiting Caller ID..... | 52 |
| Call Waiting Tone | 52 |
| Caller ID Number Auto Edit feature..... | 33-35 |
| Caller ID service | 16, 28, 29 |
| Caller List, editing | 33 |
| Caller List, erasing..... | 37 |
| Caller List, storing..... | 36 |
| Caller List, viewing..... | 30 |
| Calling Back from the Caller List | 32 |
| Conference call..... | 51 |
| D | |
| Data Port..... | 14 |
| DIAL LOCK..... | 57 |
| Dialing Mode..... | 20 |
| Directory | 38 |
| Directory, dialing | 41 |
| Directory, editing | 42 |
| Directory, erasing..... | 43 |
| Directory, names and symbols | 39 |
| Directory, searching | 40 |
| Directory, storing..... | 38 |
| Display | 8 |
| E | |
| Extension buttons..... | 46 |
| Extension indicators | 18 |
| F | |
| FCC and Other Information..... | 69 |
| FLASH Button | 53 |
| Flash time..... | 53 |
| Function Menu | 19 |
| H | |
| Headset, optional | 61 |
| I | |
| Incoming Call Tone..... | 54 |
| Installation, AC adaptor | 10 |
| Installation, Telephone Line Cord | 11-14 |
| Intercom call..... | 46-48 |
| Intercom paging | 46-48 |
| L | |
| LCD contrast | 21 |
| LINE Buttons | 25 |
| LINE indicators..... | 27 |
| Line Selection..... | 55 |
| Location of controls | 6, 7 |
| M | |
| Making Calls..... | 25 |
| Memory card | 18 |
| Microphone | 25, 28 |
| MUTE | 52 |
| N | |
| Navigator key | 6 |
| O | |
| One-touch auto dial buttons | 44 |
| One-Touch Dialer | 44 |
| P | |
| Page all | 48 |
| Password..... | 56 |
| PAUSE..... | 52 |
| Power failure..... | 9, 10, 16 |
| Privacy Feature | 60 |
| Pulse service..... | 53 |

→ Index

R

| | |
|------------------------------------|--------|
| Redial | 26 |
| Redial list..... | 26 |
| Ringer Off | 22 |
| Ringer pattern | 23 |
| Ringer tone..... | 23 |
| Ringer Volume | 22 |
| Room Monitor..... | 23, 49 |
| Rotary service, Tone dialing | 53 |

S

| | |
|--|----|
| Safety Instructions..... | 67 |
| Shipping product for service Back cover | |
| Specifications | 75 |
| SP-PHONE | 25 |

T

| | |
|---------------------------|-------|
| Time and date | 15 |
| Transferring a call | 48 |
| Troubleshooting | 64-66 |

V

| | |
|---------------------|--------|
| Voice mode..... | 23, 47 |
| Volume control..... | 26, 61 |

W

| | |
|--------------------|----|
| Wall Mounting..... | 62 |
| Warranty..... | 73 |

PANASONIC CONSUMER
ELECTRONICS COMPANY, DIVISION
OF MATSUSHITA ELECTRIC
CORPORATION OF AMERICA
One Panasonic Way
Secaucus, New Jersey 07094

PANASONIC SALES COMPANY,
DIVISION OF MATSUSHITA
ELECTRIC OF PUERTO RICO, INC.,
Ave. 65 de Infanteria, Km. 9.5
San Gabriel Industrial Park
Carolina, Puerto Rico 00985

Panasonic Telephone Products Limited Warranty

Limited Warranty Coverage

If your product does not work properly because of a defect in materials or workmanship, Panasonic Consumer Electronics Company or Panasonic Sales Company (collectively referred to as "the warrantor") will, for the length of the period indicated on the chart below, which starts with the date of original purchase ("warranty period"), at its option either (a) repair your product with new or refurbished parts, or (b) replace it with a new or a refurbished product. The decision to repair or replace will be made by the warrantor.

| Parts | Labor |
|--------------|--------------|
| One (1) Year | One (1) Year |

During the "Labor" warranty period there will be no charge for labor. During the "Parts" warranty period, there will be no charge for parts. You must mail-in your product during the warranty period. This Limited Warranty excludes both parts and labor for batteries, antennas, and cosmetic parts (cabinet). This warranty only applies to products purchased and serviced in the United States or Puerto Rico. This warranty is extended only to the original purchaser of a new product which was not sold "as is".

Mail-In Service

For assistance in the continental U.S.A. in obtaining repairs please ship the product to:

**Panasonic Services Company
Customer Servicenter
Suite B
4900 George McVay Drive
McAllen, TX 78503**

For assistance in Puerto Rico call Panasonic Sales Company (787)-750-4300 or fax (787)-768-2910.

When shipping the unit carefully pack and send it prepaid, adequately insured and preferably in the original carton. Include a letter detailing the complaint and provide a day time phone number where you can be reached.

IF REPAIR IS NEEDED DURING THE WARRANTY PERIOD THE PURCHASER WILL BE REQUIRED TO FURNISH A SALES RECEIPT/PROOF OF PURCHASE INDICATING DATE OF PURCHASE, AMOUNT PAID AND PLACE OF PURCHASE. CUSTOMER WILL BE CHARGED FOR THE REPAIR OF ANY UNIT RECEIVED WITHOUT SUCH PROOF OF PURCHASE.

Limited Warranty Limits And Exclusions

This warranty ONLY COVERS failures due to defects in materials or workmanship, and DOES NOT COVER normal wear and tear or cosmetic damage. The warranty ALSO DOES NOT COVER damages which occurred in shipment, or failures which are caused by products not supplied by the warrantor, or failures which result from accidents, misuse, abuse, neglect, mishandling, misapplication, alteration, faulty installation, set-up adjustments, misadjustment of consumer controls, improper maintenance, power line surge, lightning damage, modification, introduction of sand, humidity or liquids, commercial use such as hotel, office, restaurant, or other business or rental use of the product, or service by anyone other than a Factory Servicenter or other Authorized Servicer, or damage that is attributable to acts of God.

THERE ARE NO EXPRESS WARRANTIES EXCEPT AS LISTED UNDER "LIMITED WARRANTY COVERAGE". THE WARRANTOR IS NOT LIABLE FOR INCIDENTAL OR CONSEQUENTIAL DAMAGES RESULTING FROM THE USE OF THIS PRODUCT, OR ARISING OUT OF ANY BREACH OF THIS WARRANTY. (As examples, this excludes damages for lost time, lost calls or messages, cost of having someone remove or re-install an installed unit if applicable, travel to and from the servicer. The items listed are not exclusive, but are for illustration only.) ALL EXPRESS AND IMPLIED WARRANTIES, INCLUDING THE WARRANTY OF MERCHANTABILITY, ARE LIMITED TO THE PERIOD OF THE LIMITED WARRANTY.

Some states do not allow the exclusion or limitation of incidental or consequential damages, or limitations on how long an implied warranty lasts, so the exclusions may not apply to you.

This warranty gives you specific legal rights and you may also have other rights which vary from state to state. If a problem with this product develops during or after the warranty period, you may contact your dealer or Servicenter. If the problem is not handled to your satisfaction, then write to the warrantor's Consumer Affairs Department at the addresses listed for the warrantor.

PARTS AND SERVICE, WHICH ARE NOT COVERED BY THIS LIMITED WARRANTY, ARE YOUR RESPONSIBILITY.

Customer Services Directory

***For Product Information, Operating Assistance, Literature Request, Dealer Locations, and all Customer Service inquiries please contact: 1-800-211-PANA (7262), Monday-Friday 9 am-9 pm; Saturday-Sunday 9 am-7 pm, EST.
or send e-mail :
consumerproducts@panasonic.com
For hearing or speech impaired TTY users, TTY : 1-877-833-8855***

***Web Site: <http://www.panasonic.com>
You can purchase parts, accessories or locate your nearest servicenter by visiting our Web Site.***

Accessory Purchases:

**1-800-332-5368 (Customer Orders Only)
For hearing or speech impaired TTY users, TTY : 1-866-605-1277
Panasonic Services Company 20421 84th Avenue South, Kent, WA 98032
(6 am to 5 pm Monday - Friday; 6 am to 10:30 am Saturday; PST)
(Visa, MasterCard, Discover Card, American Express, Check)**

***Service in Puerto Rico
Matsushita Electric of Puerto Rico, Inc. Panasonic Sales Company/
Factory Servicenter:
Ave. 65 de Infantería, Km. 9.5, San Gabriel Industrial Park,
Carolina, Puerto Rico 00985
Phone (787)750-4300 Fax (787)768-2910***

Specifications

| | |
|--------------------------------|--|
| Power Supply: | AC adaptor (120 V AC, 60 Hz) Three "AA" size Manganese (R6, UM-3) batteries (for a power failure, p. 9) |
| Power Consumption: | Standby: Approx. 1 W Maximum: Approx. 1.5 W |
| Dimensions (H x W x D): | Approx. 96 mm x 186 mm x 231 mm ($3^{25}/32$ " x $7^5/16$ " x $9^1/16$ ") |
| Mass (Weight): | Approx. 890 g (1.94 lb.) |
| Dialing Mode: | Tone (DTMF)/Pulse |
| Operating Environment: | 5 °C–40 °C (41 °F–104 °F) |

Specifications are subject to change without notice.

For product service

- Call 1-800-211-PANA(7262) for the location of an authorized servicer.
- Panasonic's e-mail address for customer inquiries:
consumerproducts@panasonic.com
for customers in the USA or Puerto Rico ONLY

When you ship the product

- Carefully pack your unit, preferably in the original carton.
- Attach a letter, detailing the symptom, to the outside of the carton.

Symptom

- Send the unit to an authorized servicer, prepaid and adequately insured.
- Do not send your unit to the Panasonic Consumer Electronics Company listed below or to executive or regional sales offices. These locations do not repair consumer products.

**If you need assistance with the set-up or operation,
please call 1-800-211-PANA(7262)**

**Panasonic Consumer Electronics Company,
Division of Matsushita Electric Corporation of America**
One Panasonic Way, Secaucus, New Jersey 07094

**Panasonic Sales Company,
Division of Matsushita Electric of Puerto Rico, Inc.**
Ave. 65 de Infantería, Km. 9.5, San Gabriel Industrial Park
Carolina, Puerto Rico 00985