

Panasonic

Integrated Telephone System

Pulse-or-tone dialing capability

4 LINE

Model No. **KX-TS401W**

Operating Instructions

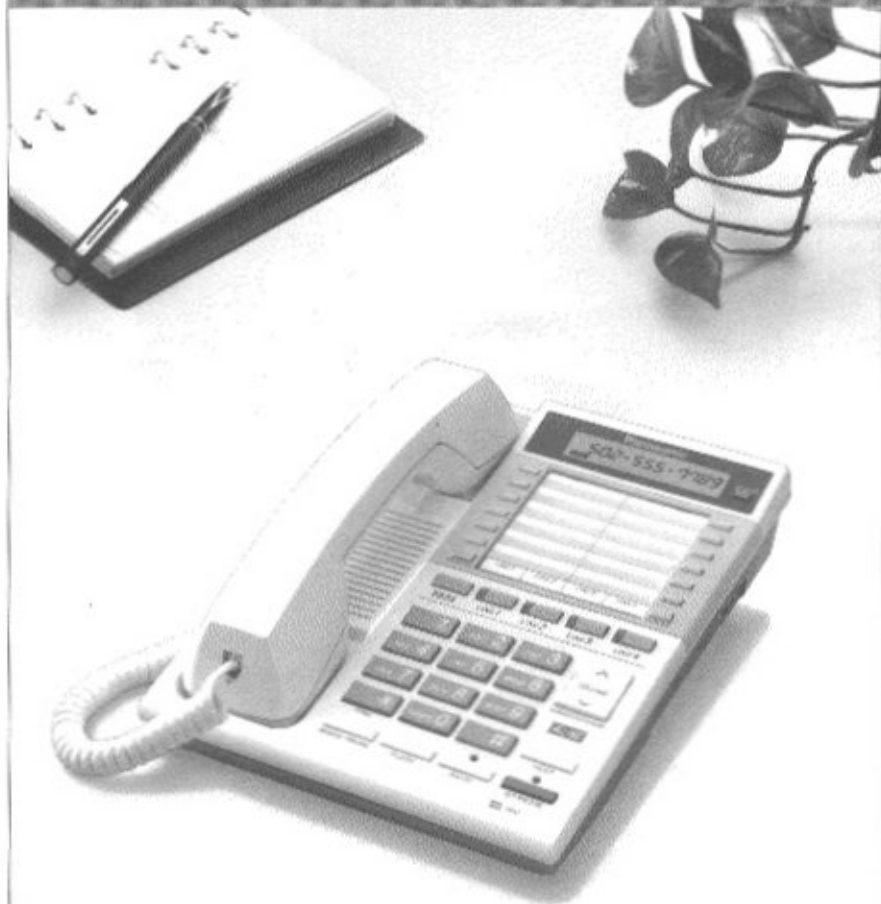

PLEASE READ BEFORE USE AND SAVE.

Getting Started

Basic Operation

Advanced Operation

Useful Information

Before Initial Use

Please read **IMPORTANT SAFETY INSTRUCTIONS** on page 29 before use. Read and understand all instructions.

Thank you for purchasing the Panasonic integrated telephone system.

Attach your purchase receipt here.

For your future reference

Serial No. _____

Date of purchase _____

(found on the bottom of the unit)

Name and address of dealer _____

Accessories

AC Adaptor (p. 7)

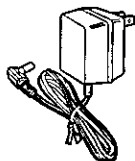

one

4-Wired Telephone Line Cord (p. 8, 9)

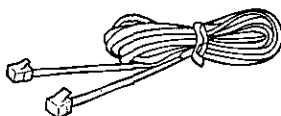

two

Handset (p. 7)

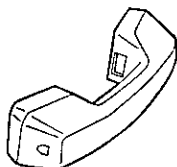

one

Handset Cord (p. 7)

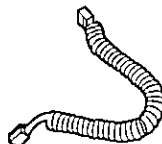

one

* To order accessories, call 1-800-332-5368.

Contents

Getting Started

Location of Controls	4
Display	6
Setting Up	7
Connecting the Handset/AC Adaptor	7
Connecting the Telephone Line Cords	8
Setting Selectors	10
Setting Time	11

Basic Operation

Making Calls	12
Answering Calls	15

Advanced Operation

Using Another Line(s) during a Conversation	16
Conference	17
Full One-Touch Automatic Dialing	18
Storing Phone Numbers in Memory	18
Dialing a Stored Number	22
Special Features	23
For Call Waiting Service Users	23
Temporary Tone Dialing (For Rotary Service Users)	23
Using the REDIAL/PAUSE Button	23
Muting Your Conversation	23
Programmable Functions	24
Line Selection Programming	24
Line Indicator Programming	25
Incoming Call Tone Programming	25

Useful Information

Wall Mounting	26
Before Requesting Help	27
Important Safety Instructions	29
FCC and Other Information	30

Location of Controls

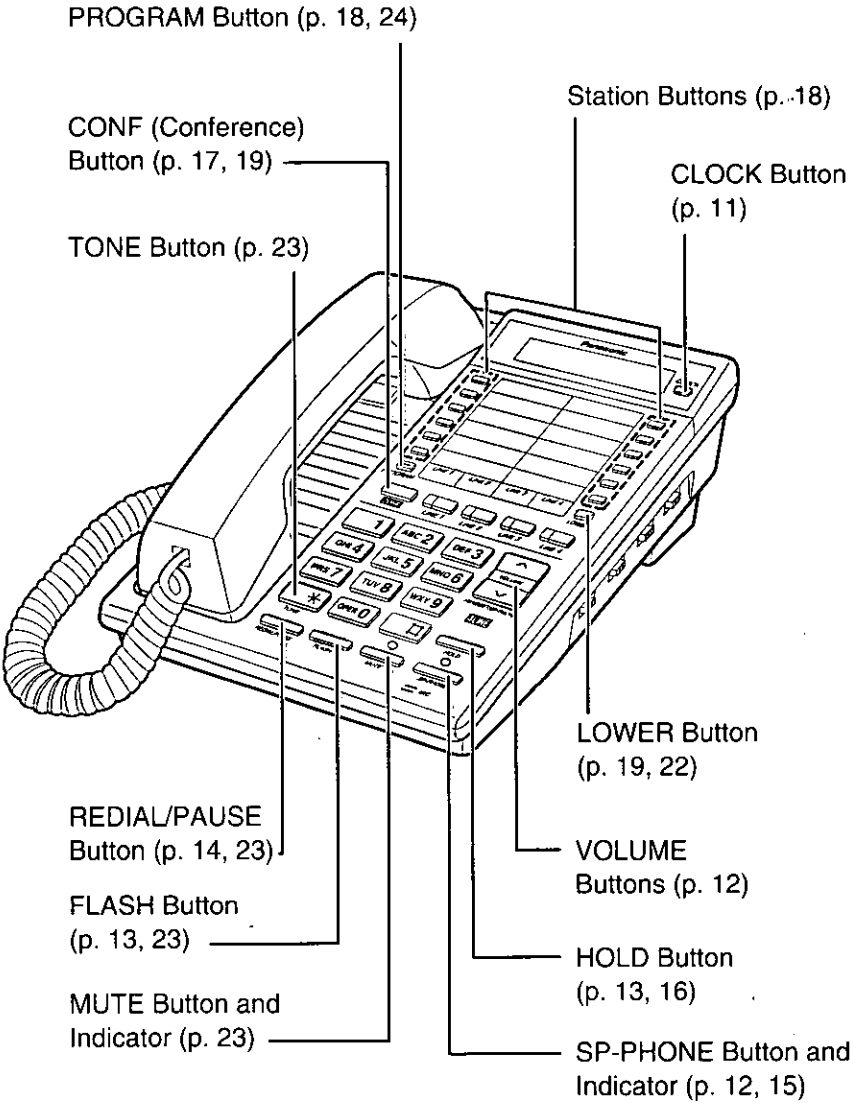

LINE 4 Button and Indicator (p. 13, 16)

LINE 3 Button and Indicator (p. 13, 16)

LINE 2 Button and Indicator (p. 13, 16)

LINE 1 Button and Indicator (p. 13, 16)

Display (p. 6)

RINGER Selectors (p. 10)

MIC (Microphone) (p. 12)

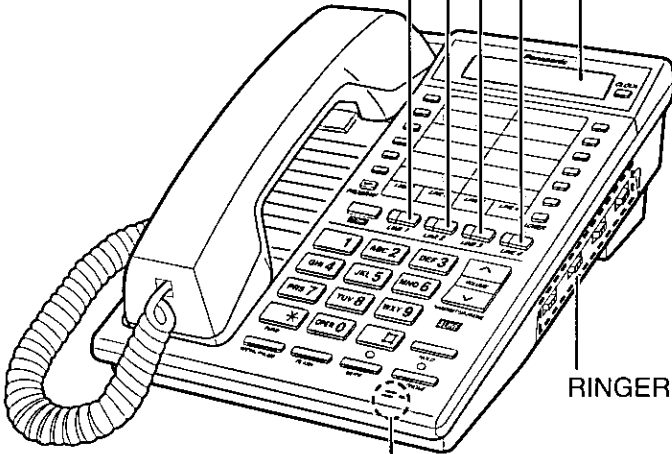

DIALING MODE Selector (p. 10)

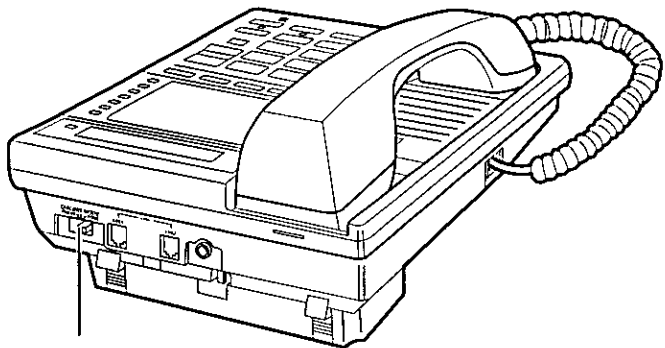

Display



(This display shows all of the possible configurations.)

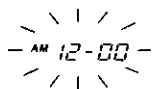

The clock needs adjusting (p. 11).



During a conversation, the call duration is displayed. (Example: 15 minutes 30 seconds, current time is 11:45 AM.)

TIME SET → ☒ → CLOCK

Follow the time setting procedure steps (p. 11).

PROGRAM

The unit is in the programming mode (p. 18).

PHONE NO. → STATION

Follow the storing procedure steps (p. 18).

REDIAL

The unit is redialing (p. 14).

LOWER

A lower memory station is selected (p. 19).



The FLASH button is pressed while storing numbers.



The PAUSE button is pressed.



You pressed "*" when dialing in the TONE mode.



You pressed "#" when dialing in the TONE mode.

VOL

You are adjusting the sound volume (p. 12).

"" shows the volume level.

- When using the handset: 3 levels
- When using the speakerphone: 12 levels

Setting Up



Connecting the Handset/AC Adaptor

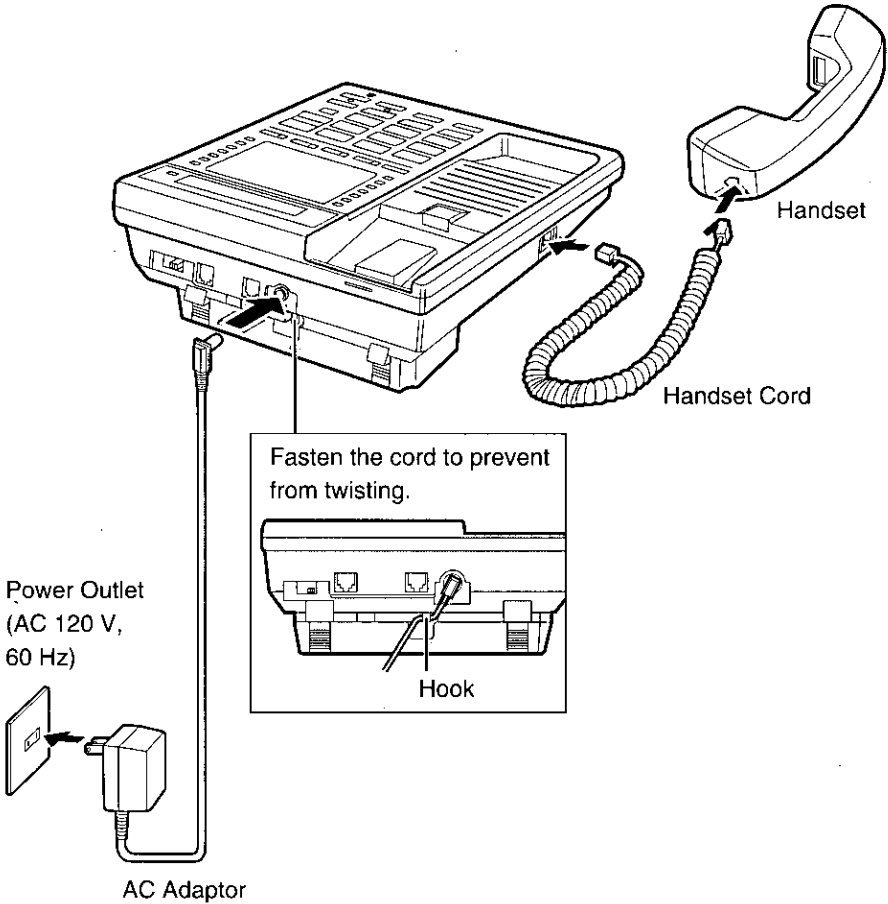

- **USE ONLY** Panasonic AC ADAPTOR KX-A09. The adaptor must remain connected at all times. (It may feel warm during use. This is normal.)
- Use only a Panasonic Handset for the KX-TS401W.
- During a power failure the unit will work as a single-line telephone, but the line indicators will not light and the RINGER selectors will not function.
- KX-TS401W is not designed to be used with a PBX.

Connecting the Telephone Line Cords

Connect the telephone line cords to the unit as follows.

To connect two two-line telephone jacks

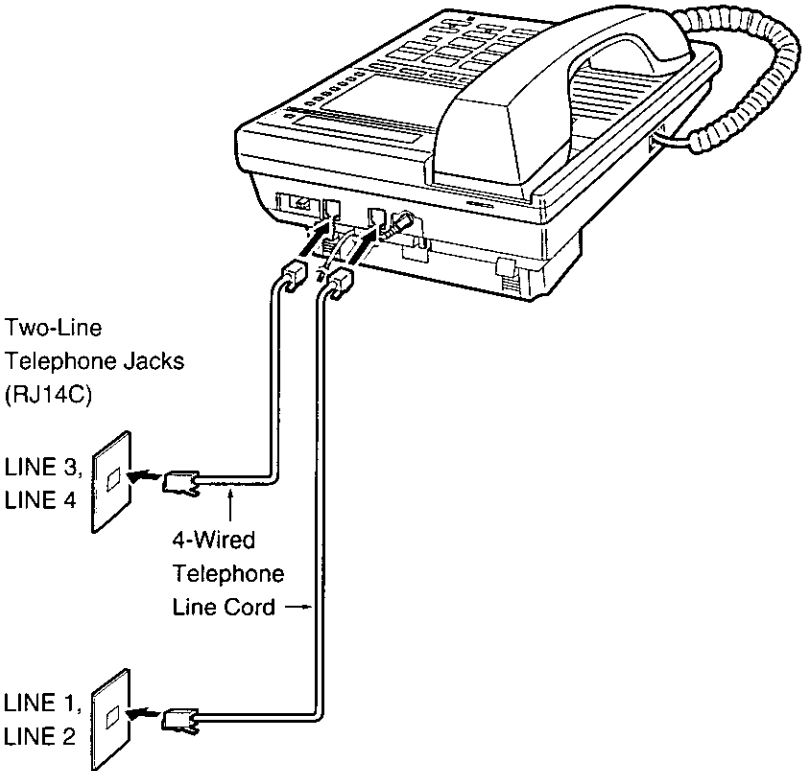



To connect four single-line telephone jacks

For this connection, please purchase two Panasonic T-adaptors KX-J24. Two 2-wired telephone line cords are also necessary.

Single-Line Telephone Jacks (RJ11C)

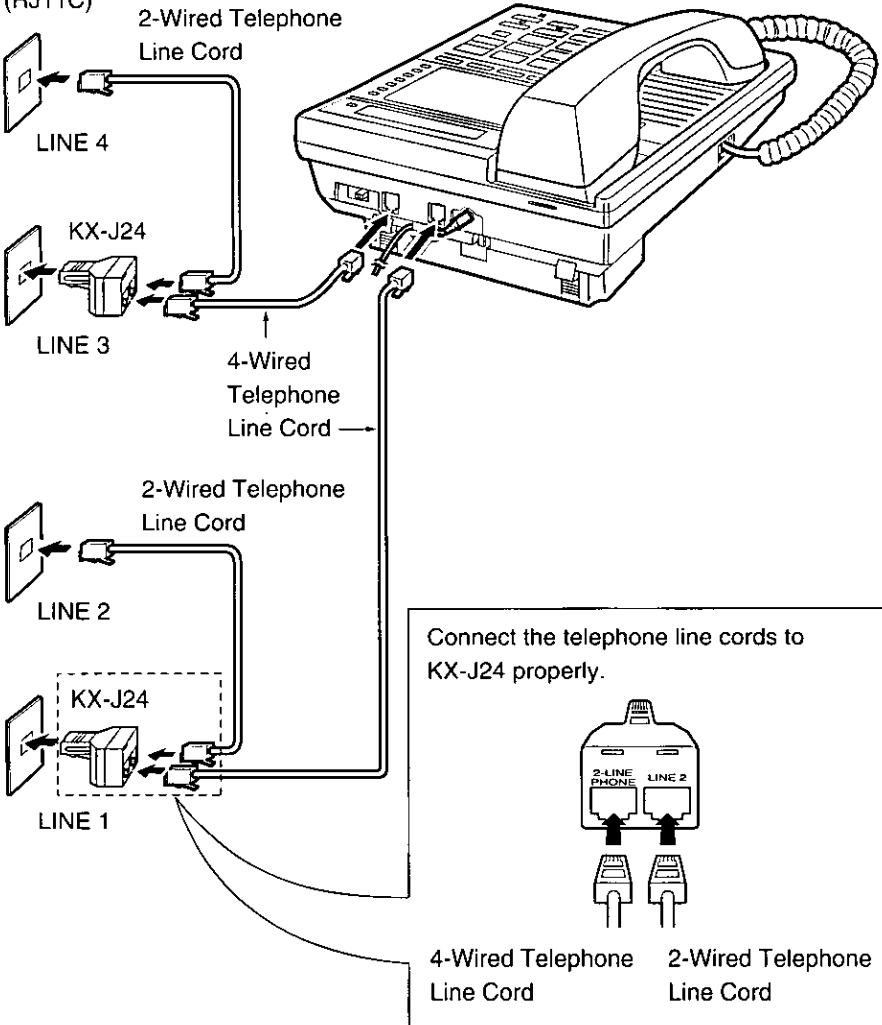

Setting Selectors

DIALING MODE Selector

Set to TONE when all of the telephone lines have touch tone service. If more than one has rotary service, set to PULSE.

DIALING MODE
PULSE or TONE

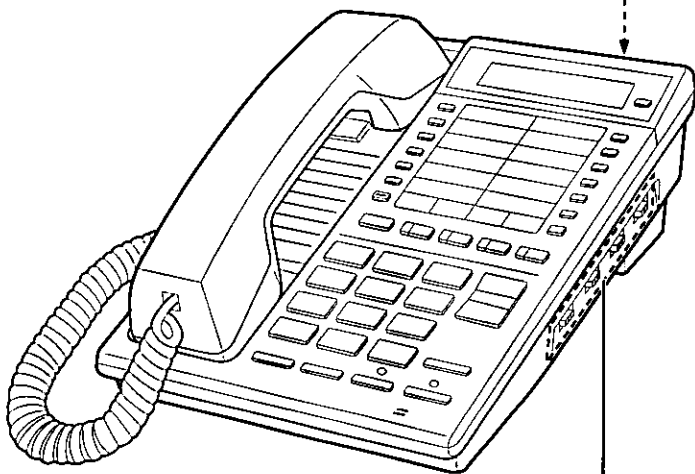

RINGER Selectors

Used to set the ringer volume of each line. Set to HIGH or LOW. When set to OFF, the bell will not ring.

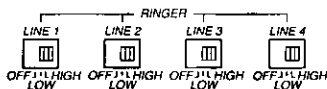

Setting Time

Make sure that the handset is on the cradle, the AC adaptor is connected and the SP-PHONE indicator light goes out.

- 1 Press **CLOCK**.
 - **TIME SET → * → CLOCK** is displayed.
- 2 Enter the current time, hour (up to 12) and minute by using a 3 or 4 digit number.
 - The entered number is displayed one digit at a time.
- 3 Press ***** to select AM or PM.
- 4 When finished, press **CLOCK**.
 - The clock starts working.

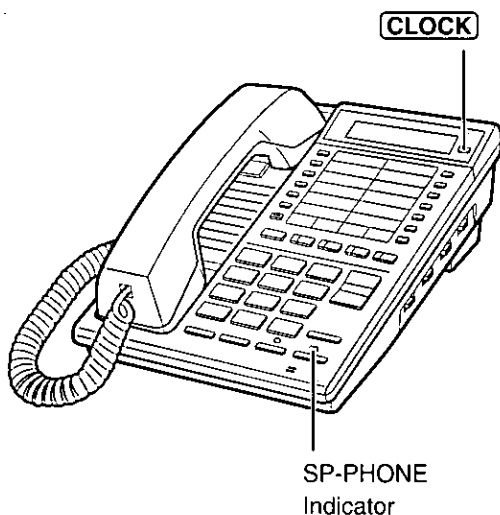

Example: To set "13:05", press as follows:

CLOCK → **1** **0** **5** → ***** (until "PM" is displayed) → **CLOCK**

- If "12:00" on the display still flashes in step 4, it means you have entered a wrong number. Restart from step 1.
- During a power failure, the retention time for the clock is approximately 15 minutes.
- The accuracy of the clock is approximately ± 45 seconds a month at room temperature.

Making Calls

You can make a call by simply lifting the handset. To hang up, place the handset on the cradle.

Using the Speakerphone

- 1 Press **SP-PHONE**.
 - The indicator lights.
 - The selected line indicator lights green.
- 2 Dial a telephone number.
 - The dialed number is displayed.
- 3 When the other party answers, speak into the **MIC** (microphone).
- 4 To hang up, press **SP-PHONE**.
 - The indicator lights go out.

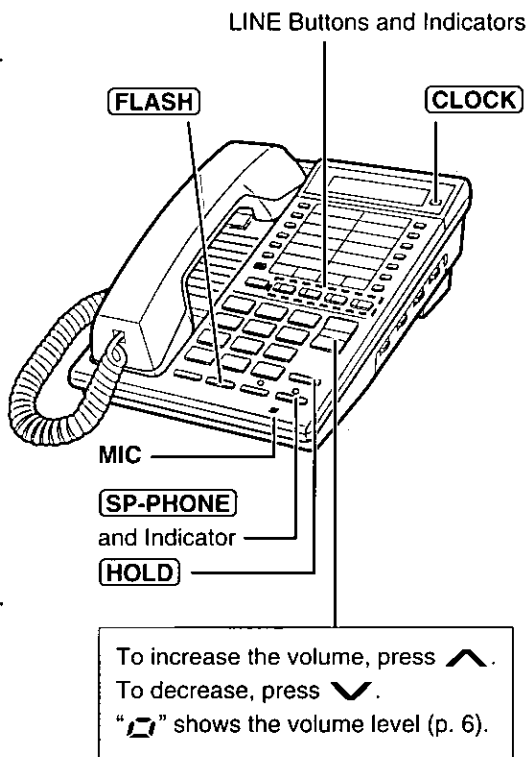

Helpful hints for the speakerphone operation:

- For best performance, speak alternately with the caller in a quiet room.
- You may switch to the handset by lifting up. To place the handset on the cradle again during a call, press **SP-PHONE**.
- If the other party has difficulty hearing you, press **▼** to decrease the speaker volume.



Helpful Information for Making Calls

- The unit will automatically select a free line which is not being used by a parallel connected telephone when you make a call. (To change the line selection, see page 24.)
- You may select a line manually by directly pressing the line button. (If the unit is programmed to select no line, this is indispensable. See page 24.)
- Pressing **(CLOCK)** during a conversation changes the display from the call duration to the number dialed alternately.

If you misdial

Press **(FLASH)** firmly. → Dial again.

Putting a call on hold

Press **(HOLD)** during a conversation. The line indicator flashes green.

- If you are using the handset, you may place it on the cradle.
- To release the hold, press the line button.

You may make or answer a second call on another line while keeping the present call on hold. See page 16.

What the line indicator means

Light off	The line is free.
Light on (Green)	The line is selected.
Light on (Red)	The line is being used by a parallel connected telephone.
Flashing (Green)	The call is on hold.
Flashing (Red)	Receiving a call on the line (p. 15).

Redialing the last number

- 1 Lift the handset or press **SP-PHONE**.
 - The selected line indicator lights green.
- 2 Press **REDIAL/PAUSE**.
 - “**REDIAL**” is displayed.
 - The unit redials the last dialed number once.

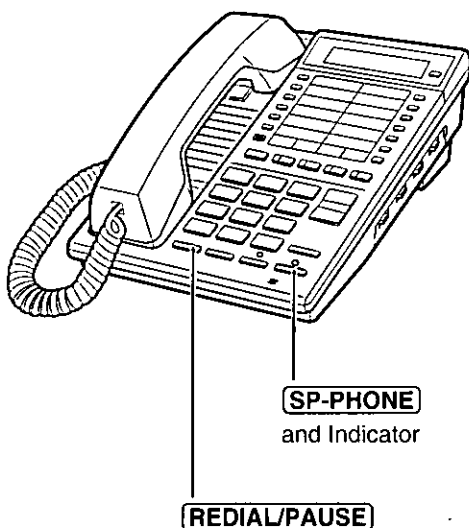

- To cancel the automatic redial, press **FLASH** or **SP-PHONE** during redialing or lift the handset.

Answering Calls

When a call is being received, the bell rings and the called line indicator flashes red. You can answer it by simply lifting the handset. The called line is automatically selected.

Using the speakerphone

- 1 Press **SP-PHONE**.
 - The indicator lights.
 - The called line indicator lights green.

- 2 Speak into the **MIC** (microphone).

- 3 To hang up, press **SP-PHONE**.
 - The indicator lights go out.

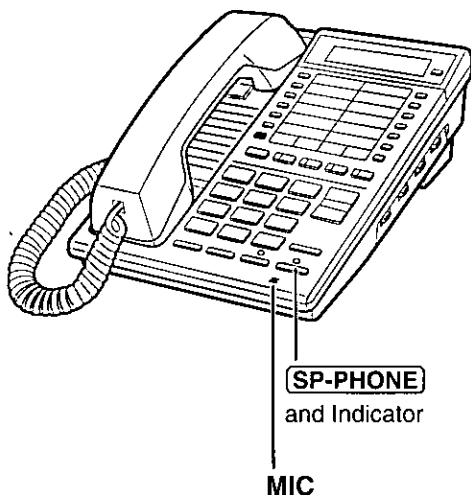

- For helpful hints on the speakerphone operation, see page 12.
- If the unit is programmed to select no line, you need to press the line button whose indicator is flashing to answer the call. See page 24.
- When the RINGER selector(s) is set to OFF, the bell will not ring.

Using Another Line(s) during a Conversation

During a conversation, if another line indicator(s) flashes red, it means an incoming call is being received on the line. You can answer the second call while keeping the first call.

You can also make a call without terminating the first call.

1 Example: If you are using LINE 1

Press **HOLD** to put the first call (LINE 1) on hold.

- The LINE 1 indicator flashes.

2 Press the other line button (LINE 2, 3 or 4) to make or answer the second call.

- The line indicator lights green.

3 To return to the first call (LINE 1), press the line button of the first call (LINE 1).

- The second call is terminated.

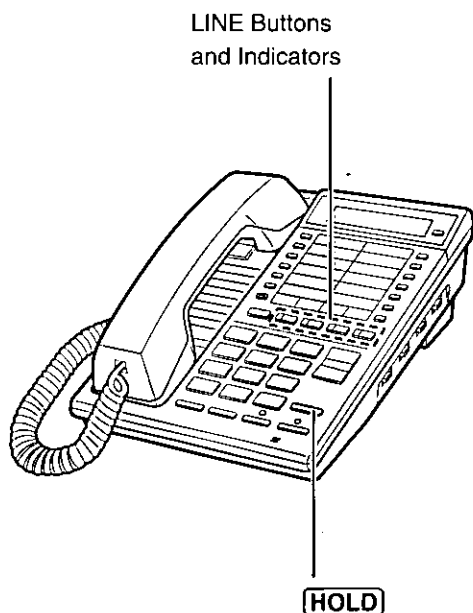

- To keep the second call in step 3, press **HOLD** before pressing the line button of the first call. Then you can also make/answer another call by pressing one of the other two line buttons.
- You can know if another call arrives on the other line during a conversation by hearing **two tones** (incoming call tone). To set this, see page 25.

Conference

While having a conversation on one line, you can make or answer a second call on another line, then combine both lines together to establish a 3-way conference call.

1 Example: If you are using LINE 1

Press **(HOLD)** to put the first call (LINE 1) on hold.

- The LINE 1 indicator flashes.

2 Press the other line button (LINE 2, 3 or 4) to make or answer the second call.

- The line indicator lights green.

3 When the second call is connected, press **(CONF)** to establish a conference call.

- Both line indicators light.

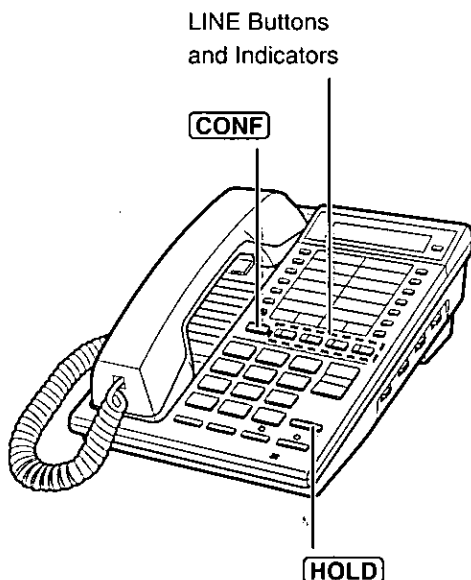

During a conference call:

- To hang up both lines, place the handset on the cradle or press **(SP-PHONE)**.
- To hang up only one line, press the line button you want to continue.
- To put both lines on hold, press **(HOLD)**.
To talk with only one caller, press the corresponding line button.
To resume both lines, press **(CONF)**.

Full One-Touch Automatic Dialing

The unit can store 24 phone numbers you dial often, in memory. (12 numbers in upper memory locations, 12 numbers in lower memory locations.) The stored number is dialed automatically by pressing one of the station buttons (p. 22).

Storing Phone Numbers in Memory

A 16-digit phone number can be stored in each memory station.

- Please do not press any station button before storing to prevent misoperation.
- Make sure that the handset is on the cradle, the SP-PHONE indicator light goes out and the AC adaptor is connected.

Storing in the UPPER memory location

- 1 Press **PROGRAM**.
 - “**PROGRAM**” and “**PHONE NO. → STATION**” are displayed.
- 2 Enter a phone number up to 16 digits.
 - The entered number is displayed.
 - If you misdial, press **PROGRAM** to end storing then restart from step 1.
- 3 Press one of station buttons.
 - A confirmation tone sounds (see page 20).
 - To store other numbers, repeat steps 1 through 3.

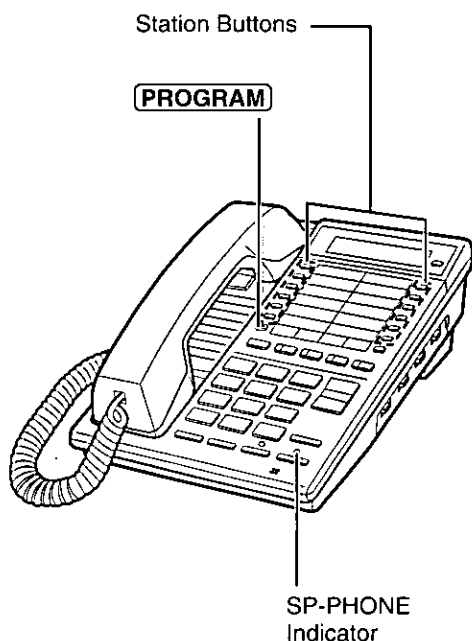

Note:

- If the AC adaptor is disconnected more than 30 minutes, the stored numbers should be confirmed again before dialing.



Storing in the LOWER memory location

- 1 Press **PROGRAM**.
 - “**PROGRAM**” and “**PHONE NO. → STATION**” are displayed.
- 2 Enter a phone number up to 16 digits.
 - The entered number is displayed.
 - If you misdial, press **PROGRAM** to end storing then restart from step 1.
- 3 Press **LOWER** to select a lower memory location.
 - “**LOWER**” is displayed.
- 4 Press one of the station buttons.
 - A confirmation tone sounds (see page 20).
 - To store other numbers, repeat steps 1 through 4.

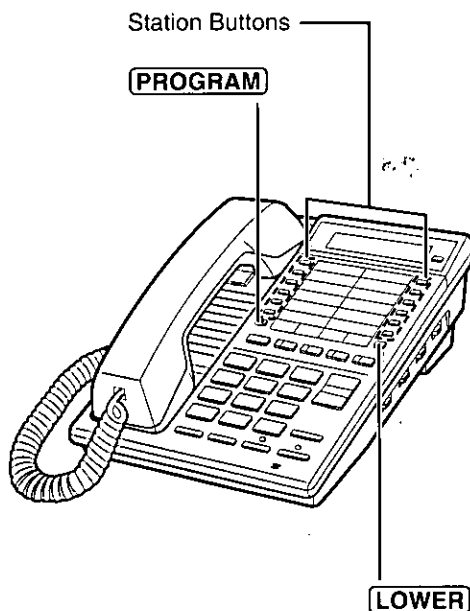

Helpful hints while storing:

- To insert a hyphen in a phone number, press **CONF**. A hyphen counts as one digit.
- Pressing “*” or “#” once counts as two digits.
- You can keep the stored numbers confidential. See page 21.

➔ Full One-Touch Automatic Dialing

What the confirmation tone means

1 beep: The new number is stored.

2 beeps: The number is the same as a previously stored one.

To erase a stored number

- If the phone number is in the UPPER memory location:
Press **PROGRAM** ➔ the station button (for the phone number to be erased).
- If the phone number is in the LOWER memory location:
Press **PROGRAM** ➔ **LOWER** ➔ the station button (for the phone number to be erased).

Memory card

Pull out the memory card and write down the names or phone numbers associated with "full one-touch automatic dialing".

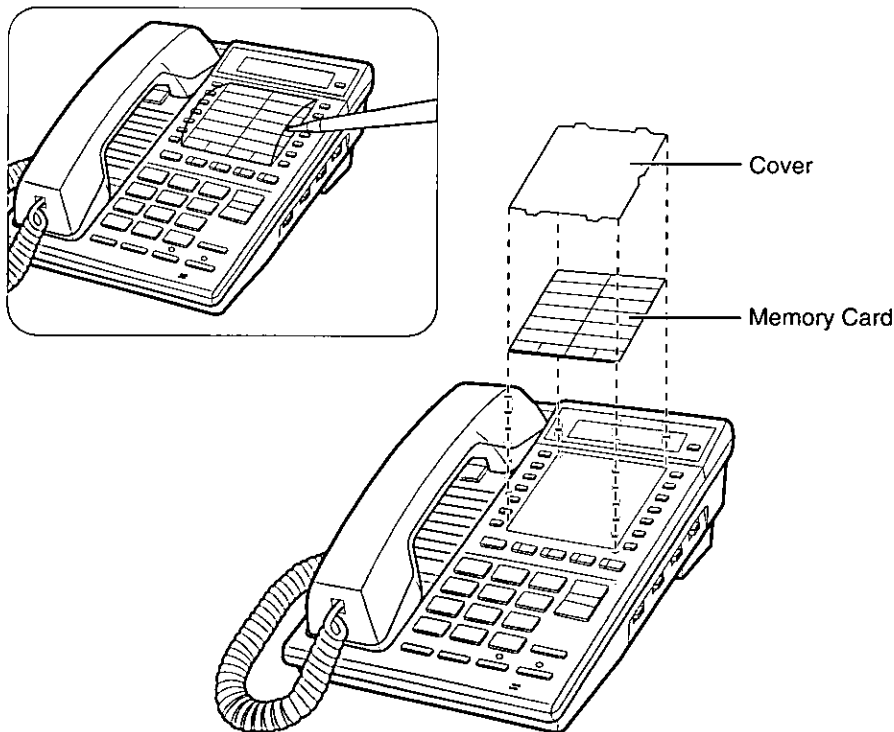



To store confidential numbers (Secret button feature)

The confidential numbers stored by using this feature is not be displayed when dialing. The **MUTE** button functions as the secret button when storing.

To make all digits of a phone number secret

Example: To hide all digits of the phone number "1234567"

Press **PROGRAM** → **MUTE** → **1234567** → **MUTE** → **(LOWER)** → station button .

When storing, the display shows "[1234567]".

When dialing, the display shows "[0000000]".

To make part of a phone number secret

Example: To hide "4567" of the phone number "1234567"

Press **PROGRAM** → **123** → **MUTE** → **4567** → **MUTE** → **(LOWER)** → station button .

When storing, the display shows "123[4567]".

When dialing, the display shows "123[0000]".

- Pressing **MUTE** once counts as one digit.

Dialing a Stored Number

Using the UPPER memory

location:

Press the desired station button you want to dial.

- The speakerphone is turned on.
- The stored number is displayed and dialed.

OR

Using the LOWER memory

location:

Press **LOWER**, then press the desired station button you want to dial.

- The speakerphone is turned on.
- The stored number is displayed and dialed.

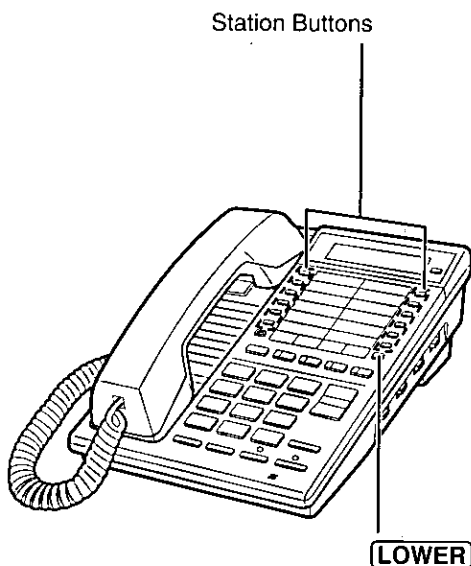

- If the unit is programmed to select no line (p. 24), press a line button first.
- You may lift the handset before/after pressing a station button to have a handset conversation.
- You can deactivate this "Full One-Touch Automatic Dialing" feature. Press **PROGRAM** → **HOLD** → **MUTE** → **2** (OFF). (The speakerphone will not turn on automatically when you press a station button. You must press **SP-PHONE** or lift the handset, then press a station button to dial a stored number.) To activate the feature again, press **1** (ON) instead of **2** (OFF).

Special Features

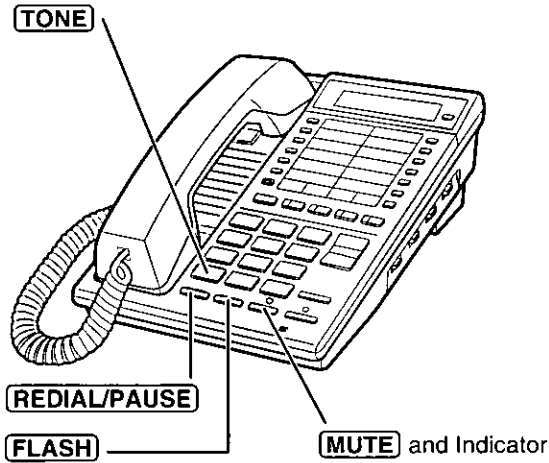

For Call Waiting Service Users

Press **FLASH** lightly if you hear a call-waiting tone while speaking.

- The first call is put on hold and you can answer the second call.
- To return to the first caller, press **FLASH** again.

Temporary Tone Dialing (For Rotary Service Users)

Press **TONE** before dialing.

- The dialing mode changes to tone. You can enter numbers to access an answering system, electronic banking services, etc. When you hang up, the mode returns to pulse.

Using the REDIAL/PAUSE Button

The REDIAL/PAUSE button has a double function. It will redial the last number if pressed at the outset of a call (p. 14). It will create a dialing delay if another number has been dialed first. If a number you want to store requires a delay, press **REDIAL/PAUSE** where needed.

Muting Your Conversation

When you press **MUTE**, the other party cannot hear your voice but you can hear theirs. The MUTE indicator lights. To resume the conversation, press **MUTE** again.

Programmable Functions

You can program the following functions. Be sure that the handset is on the cradle and the SP-PHONE indicator light is off.

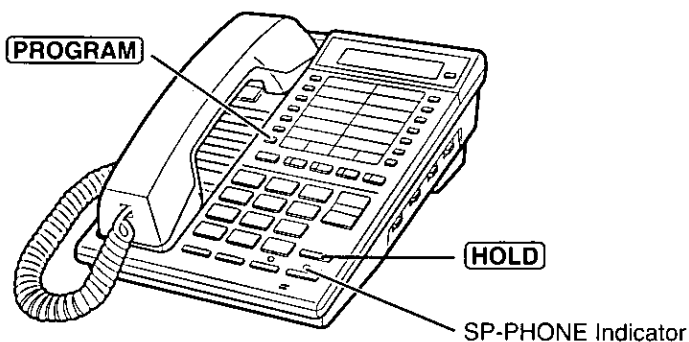

Line Selection Programming

The unit will automatically select a free line which is not being used by a parallel connected telephone, when you press **SP-PHONE** or lift the handset to make a call. Also the unit will select the called line when you answer a call. To change the line selection, program as follows.

1. Press **PROGRAM** to start programming.
 2. Press **HOLD**.
 3. Press **#**.
 - The current setting is displayed.
 4. Press **1**, **2**, **3**, **4**, **5** or **0** to select the desired line selection.
 - 1: Line 1 will be selected first. ("L1" is displayed).
 - 2: Line 2 will be selected first. ("L2").
 - 3: Line 3 will be selected first. ("L3").
 - 4: Line 4 will be selected first. ("L4").
 - 5: A free line will be selected (Line 1 has priority) when making a call. The called line will be selected when answering a call. ("AUTO"—this is the factory preset.)
 - 0: No line will be selected automatically. ("OFF"—you should press the line button to select the line when making/answering a call.)
- Any line can be selected manually in any mode (0 to 5) by pressing the line button directly.

Line Indicator Programming

All of the line indicators are preset to ON. If there is (are) a line(s) not connected, the line's indicator will remain red. To turn off the indicator, program as follows.

1. Press **PROGRAM** to start programming.
2. Press **HOLD**, then press *****.
 - "COL" is displayed.
3. Press **1**, **2**, **3** or **4** to select the line indicator.
 - 1: Line 1 ("L1")
 - 2: Line 2 ("L2")
 - 3: Line 3 ("L3")
 - 4: Line 4 ("L4")
 - Current setting "ON" (or "OFF") is displayed.
4. Press **2** (OFF) to deactivate the indicator.
 - To activate the line indicator again, press **1** (ON).

Incoming Call Tone Programming

When you are using one line, you can know if another call arrives on the other line by hearing a series of two tones every 15 seconds. This incoming call tone can be set/eliminated by programming. Factory preset is OFF.

1. Press **PROGRAM** to start programming.
 2. Press **HOLD**, then press **0**.
 3. Press **1** or **2**.
 - 1: Incoming call tone will sound as long as the other line rings. (ON)
 - 2: Incoming call tone will not sound. (OFF)
- When the RINGER selector(s) is set to OFF, the incoming call tone will not sound.

Wall Mounting

This unit can be mounted on a wall phone plate.

Be sure to reverse the handset hook in the cradle **so the tab holds the handset**.

- ① Push to remove.
- ② Rotate 180°.
- ③ Replace it with the tab upward.

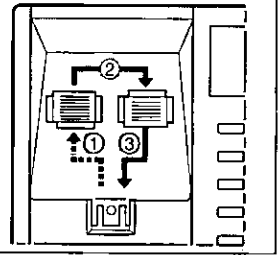

- 1 Remove the wall mounting adaptor from the bottom of the unit.

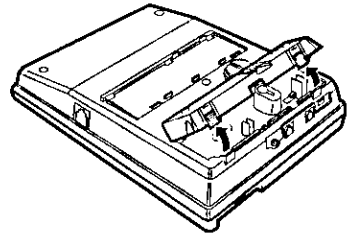

- 2 Connect the AC adaptor and a telephone line cord.

- For proper line connection, see pages 8 and 9.

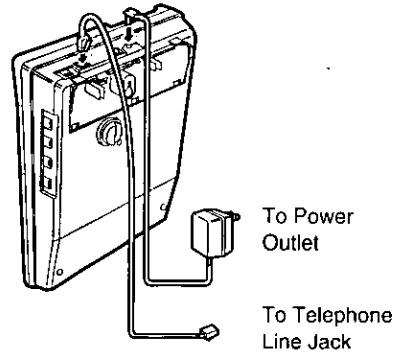

- 3 Tuck the telephone line cord inside the wall mounting adaptor, then push the wall mounting adaptor in the direction of the arrow.

- The word "UP" on the adaptor should face upward.

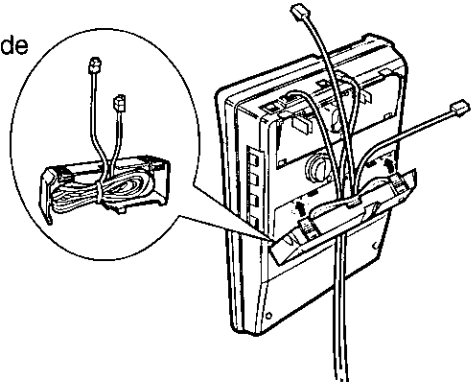

4 Connect the telephone line cord. Mount the unit, then slide down.

- For proper line connection, see pages 8 and 9.

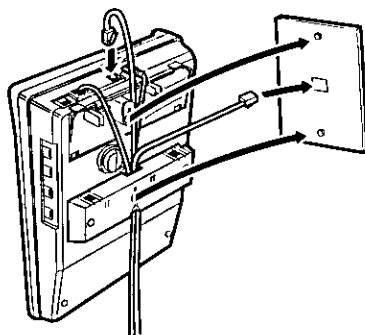

- To temporarily place the handset down during a conversation, place on the hook as shown.

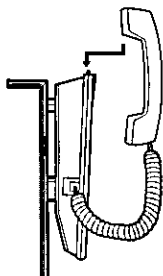

Before Requesting Help



Problem	Remedy
The unit does not ring	<ul style="list-style-type: none"> • The RINGER selectors are set to OFF. Set to HIGH or LOW (p. 10). • When another call is received during a call, the bell does not ring. You can set the incoming call tone instead (p. 25).
The unit does not work.	<ul style="list-style-type: none"> • Check the setting up (p. 7-11). • Plug in the AC adaptor.
You cannot store a phone number in memory.	<ul style="list-style-type: none"> • You cannot store the number during a conversation. • Do not pause for over 60 seconds while storing. • Plug in the AC adaptor.

➔ Before Requesting Help

Problem	Remedy
While storing a phone number, the unit starts to ring.	<ul style="list-style-type: none">• To answer the call, press (SP-PHONE) or lift the handset. The program is canceled; store the number again.
While operating the unit, the AC adaptor feels warm.	<ul style="list-style-type: none">• This is normal.
You can have a handset conversation, but the other features do not work. Display is blank.	<ul style="list-style-type: none">• A power failure has occurred.• Make sure that the AC adaptor is connected.
The line indicators do not work properly.	<ul style="list-style-type: none">• Check the connection (p. 8, 9).• See page 25 for proper operation of line indicators.• Plug in the AC adaptor.• If your unit is connected to a PBX, the line indicators may not work.
During a conversation, another line indicator flashes red.	<ul style="list-style-type: none">• An incoming call is arriving on another line. To answer, press (HOLD) to put the current call on hold, then press the line button whose indicator is flashing red. To return to the first call, press the line button of the first call (p. 16).
The unit stops working during operation.	<ul style="list-style-type: none">• Disconnect the AC adaptor to reset. Reconnect it and try again.
If you cannot solve your problem	<ul style="list-style-type: none">• Call our customer satisfaction center at 1-800-211-PANA(7262).

Important Safety Instructions

When using this unit, basic safety precautions as below should always be followed to reduce the risk of fire, electric shock, or personal injury.

1. Read and understand all instructions.
2. Follow all warnings and instructions marked on this unit.
3. Unplug this unit from wall outlets before cleaning. Do not use liquid or aerosol cleaners. Use a damp cloth for cleaning.
4. Do not use this unit near water, for example, near a bath tub, wash bowl, kitchen sink, or the like.
5. Install this unit securely on a stable surface. Serious damage may result if the unit falls.
6. Do not cover slots and openings of the unit, for they are provided for ventilation and protection against overheating. Never place the unit near radiators, in/or a place where proper ventilation is not provided.
7. Use only the power source as marked on the unit. If you are not sure of the type of the power supply to your home, consult your dealer or local power company.
8. Do not place objects on the power cord. Install the unit where no one can step on the cord.
9. Do not overload wall outlets and extension cords as this can result in the risk of fire or electric shock.
10. Never push any objects into this unit through slots as they may result in risk of fire or electric shock. Never spill any liquid on the unit.
11. To reduce the risk of electric shock, do not disassemble this unit, but take it to a qualified serviceman when some service or repair work is required. Opening or removing covers may expose you to dangerous voltages or other risks. Incorrect reassembly can cause electric shock when the appliance is subsequently used.
12. Unplug this unit from the wall outlet and refer servicing to qualified service personnel under the following conditions:
 - A. When the power supply cord or plug is damaged or frayed.
 - B. If liquid has been spilled into the unit.
 - C. If the unit has been exposed to rain or water.
 - D. If the unit does not work normally by following the operating instructions. Adjust only controls covered by the operating instructions, for improper adjustment may require extensive work by a qualified technician.
 - E. If the unit has been dropped or damaged.
 - F. If the unit exhibits a distinct change in performance.
13. During thunderstorms, avoid using telephones except cordless types. There may be a remote risk of electric shock from lightning.
14. Do not use this unit to report a gas leak in the vicinity of it.

SAVE THESE INSTRUCTIONS

FCC and Other Information

If requested by the telephone company, inform them as follows:

- FCC Registration No. (found on the bottom of the unit)
- Facility Interface Code 02LS2
- Service Order Code 9.0F
- Required Network Interface Jack RJ11, RJ14
- Ringer Equivalence. 0.2B
- Ringer Equivalence (Under a power failure) 1.0B
- The particular telephone lines to which the equipment is connected.

This unit must not be connected to a coin operated line.

If you are on a party line, check with your local telephone company.

Ringer Equivalence No. (REN):

The REN is useful in determining the quantity of devices you may connect to your telephone line and still have all of those devices ring when your telephone number is called. In most, but not all areas, the sum of the REN's of all devices connected to one line should not exceed five (5.0). To be certain of the number of devices you may connect to your line, as determined by the REN, you should contact your local telephone company to determine the maximum REN for your calling area.

In the event terminal equipment causes harm to the telephone network, the telephone company should notify the customer, if possible, that service may be stopped.

However, where prior notice is impractical, the company may temporarily cease service providing that they:

- (a) Promptly notify the customer.
- (b) Give the customer an opportunity to correct the problem with their equipment.
- (c) Inform the customer of the right to bring a complaint to the Federal Communication Commission pursuant to procedures set out in FCC Rules and Regulations Subpart E of Part 68.

The Telephone Company may make changes in its communications facilities, equipment, operations or procedures, where such action is reasonably required in the operation of its business and is not inconsistent with the rules and regulations in FCC Part 68.

If such changes can be reasonably expected to render any customer terminal equipment incompatible with telephone company communications facilities, or require modification or alteration of such terminal equipment, or otherwise materially affect its use or performance, the customer shall be given adequate notice in writing, to allow the customer an opportunity to maintain uninterrupted service.

CAUTION:

Any changes or modifications not expressly approved by the party responsible for compliance could void the user's authority to operate this device.

Note:

This equipment has been tested and found to comply with the limits for a Class B digital device, pursuant to Part 15 of the FCC Rules. These limits are designed to provide reasonable protection against harmful interference in a residential installation. This equipment generates, uses, and can radiate radio frequency energy and, if not installed and used in accordance with the instructions, may cause harmful interference to radio communications. However, there is no guarantee that interference will not occur in a particular installation. If this equipment does cause harmful interference to radio or television reception, which can be determined by turning the equipment off and on, the user is encouraged to try to correct the interference by one or more of the following measures:

- Reorient or relocate the receiving antenna.
- Increase the separation between the equipment and receiver.
- Connect the equipment into an outlet on a circuit different from that to which the receiver is connected.
- Consult the dealer or an experienced radio/TV technician for help.

When programming emergency numbers and/or making test calls to emergency numbers:

- 1) Remain on the line and briefly explain to the dispatcher the reason for the call before hanging up.
- 2) Perform such activities in the off-peak hours, such as early morning hours or late evenings.

- **Environment** — do not place the unit in rooms where the temperature is less than 5°C (41°F) or greater than 40°C (104°F). Allow 10 cm (4") clearance around the unit for proper ventilation. Avoid excessive smoke, dust, mechanical vibration, shock, or direct sunlight.
- **Routine care** — wipe the unit with a soft cloth. Do not use benzine, thinner, or any abrasive powder. When you left the unit unused for long time, unplug the AC adaptor from the outlet.
- **If there is any trouble** — disconnect the unit from the telephone line and connect a known working phone. If the known working phone operates properly, have your unit repaired by one of the authorized Panasonic Factory Service Centers. If the known working phone does not operate properly, consult with your telephone company.

WARNING:

TO PREVENT FIRE OR SHOCK HAZARD, DO NOT EXPOSE THIS PRODUCT TO RAIN OR ANY TYPE OF MOISTURE.

For product service

- Panasonic Servicenters are listed in the servicenter directory.
- Call 1-800-211-PANA(7262) for the location of an authorized servicenter.

When you ship the product

- Carefully pack your unit, preferably in the original carton.
- Attach a letter, detailing the symptom, to the outside of the carton.

Symptom

- Send the unit to an authorized servicenter, prepaid and adequately insured.
- Do not send your unit to the Panasonic Consumer Electronics Company listed below or to executive or regional sales offices. These locations do not repair consumer products.

Panasonic Consumer Electronics Company,
Division of Matsushita Electric Corporation of America
One Panasonic Way, Secaucus, New Jersey 07094

Panasonic Sales Company,
Division of Matsushita Electric of Puerto Rico, Inc.
Ave. 65 de Infantería, Km. 9.5, San Gabriel Industrial Park
Carolina, Puerto Rico 00985