

Panasonic

Network Camera

Operating Instructions

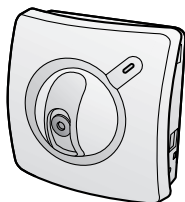

Model No. **KX-HCM10**



Please read this manual before using and save this manual for future reference.

Panasonic Network Camera Site: <http://www.panasonic.com/netcam>
for customers in the USA or Puerto Rico

Introduction

Thank you for purchasing a Panasonic Network Camera.

Check the following items when unpacking.

Network Camera	— 1 pc.
Operating Instructions	— 1 pc.
Getting Started	— 1 pc.
AC Adaptor	— 1 pc.
Camera Stand	— 1 pc.
Setup CD-ROM	— 1 pc.
Screws	— 2 pcs.
Washers	— 2 pcs.

For operation assistance:

- Call **1-800-272-7033**
- Refer to the Panasonic Network Camera Site
<http://www.panasonic.com/netcam>

Trademarks

- Netscape and Netscape Navigator are either registered trademarks or trademarks of Netscape Communications Corporation in the U.S. and other countries.
- Adobe and Acrobat are either registered trademarks or trademarks of Adobe Systems Incorporated in the United States and/or other countries.
- Ethernet is either a registered trademark or a trademark of Xerox Corporation in the United States and/or other countries.
- Microsoft, Windows, Windows NT, MS-DOS, Hotmail and ActiveX are either registered trademarks or trademarks of Microsoft Corporation in the United States and/or other countries.
- Pentium is a trademark or registered trademark of Intel Corporation or its subsidiaries in the United States and other countries.
- Screen shots reprinted with permission from Microsoft Corporation.

All other trademarks identified herein are the property of their respective owners.

Network Camera Memo

Attach your purchase receipt here.

For your future reference

Date of purchase _____

Serial Number _____

(Found on the rear side of the main unit)

MAC Address _____

Name and address of dealer _____

IMPORTANT SAFETY INSTRUCTIONS

When using this unit, basic safety precautions should always be followed to reduce the risk of fire, electric shock, or personal injury.

- 1.** Read and understand all instructions.
- 2.** Keep these instructions.
- 3.** Heed all warnings.
- 4.** Follow all instructions.
- 5.** After taking away the dust on the Fixed Focus Lens, wipe the Fixed Focus Lens with lens cleaning paper.
- 6.** Do not install near any heat sources such as radiators, heat registers, stoves, or other devices (including amplifiers) that produce heat.
- 7.** Protect the AC adaptor cord from being walked on or pinched particularly at plugs, convenience receptacles, and the point where they exit from the unit.
- 8.** Only use attachments/accessories such as stands, tripods, and brackets specified by the manufacturer.
- 9.** Do not touch the unit or the AC adaptor during lightning storms.
- 10.** Unplug the unit when unused for long periods of time.
- 11.** Refer all servicing to qualified service personnel. Servicing is required when the unit has been damaged in any way, such as AC adaptor cord or plug is damaged, the unit does not operate normally, or has been dropped.

SAVE THESE INSTRUCTIONS

Table of Contents

1	Product Introduction.....	7
1.1	Getting to Know Network Camera	8
1.1.1	Main Features	8
1.1.2	System Requirements	10
1.1.3	Authentication—System Security Feature	11
1.2	Included Accessories.....	12
1.3	Camera Feature Locations	14
1.3.1	Front View.....	14
1.3.2	Rear View	15
1.3.3	Bottom View.....	15
2	Network Camera Setup.....	16
2.1	Installation Procedure	17
2.2	Network Camera Configuration Type	18
2.3	How to turn on Network Camera for Installation	20
2.4	Network Parameters	21
2.4.1	Preparing the Network Parameters for Network Camera	21
2.4.2	Setting IP Address of the PC in [Type 4] Configuration Type	24
2.5	Proxy Server Setting.....	26
2.6	Simple Installation using the Setup CD-ROM.....	28
2.7	Network Camera Access from the Internet.....	32
3	Network Camera Screen and Setup Window.....	35
3.1	Network Camera Flow Chart	36
3.2	Top Page	37
3.3	Single Camera Screen	40
3.3.1	Using Operation Bar	42
3.3.2	Using Pan/Tilt Operation.....	43
3.3.3	Setting Preset Positioning and Home Positioning	44
3.3.4	Viewing Buffered Image Screen	46
3.4	Multi-Camera Screen.....	48
3.5	Setup Page.....	49
3.5.1	Go to Top Page	53
3.5.2	Network.....	54
3.5.3	Name/Time	58

- 3.5.4 Security: Administrator60
- 3.5.5 Security: General User62
- 3.5.6 Top View Image64
- 3.5.7 Image Transfer66
- 3.5.8 Camera Setup78
- 3.5.9 Multi-Camera81
- 3.5.10 External Output Control83
- 3.5.11 Indicator Control84
- 3.5.12 Status85
- 3.5.13 Restart86
- 3.5.14 Update Firmware87
- 3.5.15 Reset to Factory Default90

- 4 Technical Guides 91**
- 4.1 Mounting 92
- 4.2 Interfacing to the External I/O 94
- 4.3 ASCII and ISO-8859-1 Character Table 96
- 4.4 Maintenance 98

- 5 Specifications and Troubleshooting..... 99**
- 5.1 Network Camera Reset Procedure—Default Settings 100
- 5.2 Default Settings List 101
- 5.3 Specifications 107
- 5.4 Troubleshooting 109
- 5.5 Confirmation of Network Camera Operation 115
- 5.6 FCC and Other Information 117

- Index 119**

Section 1

Product Introduction

1.1 Getting to Know Network Camera

1.1.1 Main Features

Easy installation

Setup CD-ROM simplifies the installation. Insert the Setup CD-ROM and autorun program should start the application automatically. This program automatically finds Network Camera on the network.

High-Speed Motion JPEG

Network Camera has an integrated web server. Motion JPEG displays up to 15 frames per second, if the network provides enough bandwidth. To conserve bandwidth, **JPEG - Regularly Refresh** can be selected from Top Page. Image Resolution, Image Quality, Refresh interval, **Limit time of Continuous Motion JPEG** and **On the Air time** features can control the image field.

Remote Pan/Tilt Operation

Pan/Tilt operation can move the lens 120° horizontally and 45° vertically. This movable lens allows you to see the situation widely where the object is. Operation bar has **Preset Positioning** and **Home Positioning** features to register fixed positions. Clicking the preset buttons moves the lens to the preset positions you want to view. Single Camera screen has **Click to Center** feature too. The object on Single Camera screen can be centered by clicking on the image directly.

Multi-Camera Screen

Using **Multi-Camera screen** you can simultaneously view up to four Network Cameras at various locations. Clicking on each Camera Name switches to the Single Camera screen from the Multi-Camera screen.

Multi-Client Access

Network Camera allows up to 10 users to view Motion JPEG image simultaneously. Users can access the Top View Image screen (Single Camera/ Multi-Camera screen) from their own locations. Note that as the number of users simultaneously connected to Network Camera increases, the overall motion performance will decrease.

External I/O (Input/Output)

The external sensors/devices such as a door sensor can be connected via the **External Sensor Input**. The external sensors/devices are customer provided. The alarm/timer trigger can activate the Image Transfer feature, which can send the images via e-mail or FTP (File Transfer Protocol).

External Device Control Output can send a signal to activate the external devices such as a light around Network Camera.

Update Firmware

If new firmware is released, you can download the latest program from Network Camera Technical Support Site. Installation is easy and fast. Refer to page 87 for details.

Authentication

Authentication window requires you to enter the administrator/general user ID and password. Password security can prevent unregistered users/intruders from accessing your image from their web browsers. Refer to Section 1.1.3 Authentication—System Security Feature for details.

Multi-Language Display

Top Page, Single Camera screen and Multi-Camera screen can be displayed in English (US), English (UK), French, German, Italian, Spanish or Japanese. All Setup windows are also changed when selecting English (US), English (UK) or Japanese.

1.1.2 System Requirements

The PC (Personal Computer) and the network must meet the following technical specifications for Network Camera to work properly.

Item	Description
Operating System	Microsoft® Windows® 95, Microsoft Windows 98/SE Microsoft Windows 2000, Microsoft Windows Me Microsoft Windows NT® 4.0, Microsoft Windows XP
Network Protocol	TCP/IP network protocol installed. (HTTP, TCP, UDP, IP, DNS, ARP, ICMP)
Interface	10/100 Mbps Ethernet® card for your network connection
Web browser*¹	Internet Explorer 5.0 or later/Netscape Navigator® 4.7x. (Not included on the Setup CD-ROM).

*¹ Network Camera image is not displayed correctly in the Netscape® v6.x.
Use Netscape Navigator v4.7x.

Refer to Panasonic Network Camera Site

<http://www.panasonic.com/netcam> for the latest information on web browsers.

Note

Pentium® II 300 MHz or greater CPU is recommended to prevent performance degradation.

1.1.3 Authentication—System Security Feature

Authentication window requires you to enter the administrator/general user ID and password for security. Password security can prevent unregistered users/intruders from accessing your image from their web browsers. Authentication windows are not displayed in the default. Refer to page 60 for setting up Authentication window, the administrator ID and the password. Refer to page 62 for setting up the general user ID and the password.

Authentication window

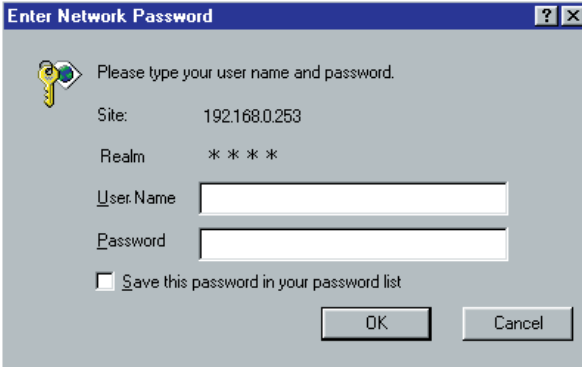

Enter Network Password [?] [X]

 Please type your user name and password.

Site: 192.168.0.253

Realm * * * *

User Name



Password

Save this password in your password list

OK Cancel

1.2 Included Accessories

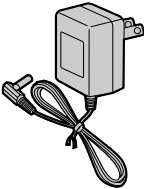
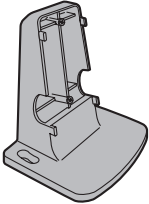
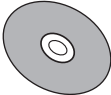
The following items are provided with Network Camera. Additional pieces can be ordered by calling **1-800-332-5368**.

<p>AC Adaptor — 1 pc. Order No. PQLV10Y</p>  An AC adaptor with a power cord and a camera-specific connector.	<p>Camera Stand — 1 pc. Order No. PSKLHCM10M</p>  A camera stand with a base and a vertical support for the camera.
<p>Setup CD-ROM — 1 pc. Order No. PSQX2904ZCD</p>  A CD-ROM disc.	<p>Screws — 2 pcs. Order No. PQHE5004Z</p> <p>Washers — 2 pcs. Order No. XWG35FY</p>  Two screws and two washers.

Notes

- If any items are missing, contact the dealer immediately.
- The order numbers listed above are subject to change without notice.
- Save the original carton and packing materials for future shipping and transportation of the unit.

Setup CD-ROM

The setup program simplifies Network Camera installation. Adobe® Acrobat® Reader 4.05 or later enables you to see the Operating Instructions on the Setup CD-ROM. If Adobe Acrobat Reader is not installed on the PC, double-click "ar405eng.exe". Refer to "ReadmeEng.txt" for the directory and file structure of the Setup CD-ROM.

Notes

- Do not scratch, smudge, write or label either surfaces of the Setup CD-ROM. Setup CD-ROM may have a scratch on the surface.
- Do not leave the Setup CD-ROM in direct sunlight, near a heat source or in a hot automobile as the Setup CD-ROM may become unreadable.
- Do not use chemicals or cleanser to clean the Setup CD-ROM as the Setup CD-ROM may become unreadable.

1.3 Camera Feature Locations

1.3.1 Front View

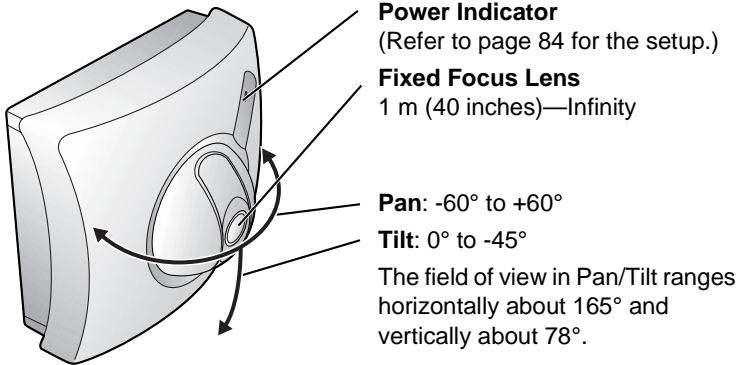

Power Indicator

Power Indicator can be controlled on **Indicator Control window** on page 84. Power Indicator blinks in the following situations.

- During the lens center positioning after turning on the power.
- During the Update Firmware.
- During initializing after pushing CLEAR SETTING button.
- During getting the IP address from the DHCP server.
- Because of the internal failure of Network Camera. Refer to page 111.

Fixed Focus Lens and Pan/Tilt operation

Fixed Focus Lens can move in the Pan/Tilt operation. Operation bar on the Single Camera screen can operate the Pan/Tilt. The Pan/Tilt moves the lens horizontally 120° and downward 45°. Refer to page 43 for the Pan/Tilt operation.

Notes

- Do not forcedly move the lens part around the Fixed Focus Lens. Touching it may damage the Pan/Tilt motor.
- Do not touch the Fixed Focus Lens. Touching it may leave a fingerprint and can cause the image to be out of focus. This can also take away the protective coating on the Fixed Focus Lens.

1.3.2 Rear View

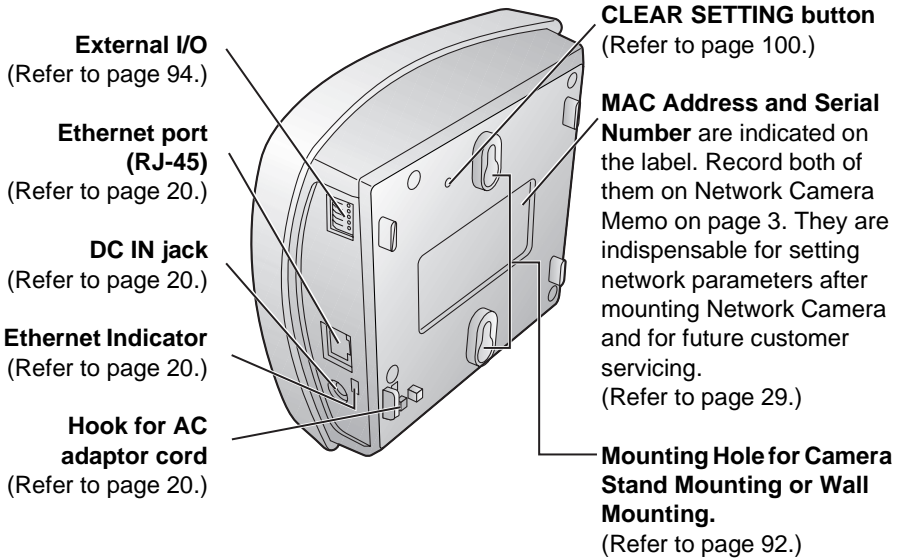

Ethernet Indicator

Ethernet Indicator turns on when the network is active. It flickers when Network Camera is sending and receiving the data.

1.3.3 Bottom View

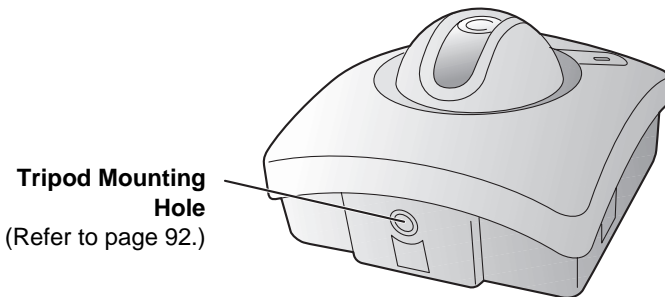

Section 2

Network Camera Setup

2.1 Installation Procedure

Select the Network Camera configuration type. (Page 18—Page 19)



Connect Network Camera for installation. (Page 20)



Prepare the network parameters for Network Camera. (Page 21—Page 22)



Check the proxy server setting. (Page 26—Page 27)



Set up Network Camera with Setup CD-ROM. (Page 28—Page 31)



Confirm the Network Camera Access from the Internet. (Page 32—Page 33)



Mount Network Camera. (Page 92—Page 93)

2.2 Network Camera Configuration Type

Network Camera can be connected over the LAN/Intranet and the Internet. Select from the four Network Camera configuration types. Network parameters differ depending on the Network Camera configuration type.

[Type 1]—LAN/Intranet Connection with an Ethernet Switching Hub

Network Camera can be installed on the LAN/Intranet.

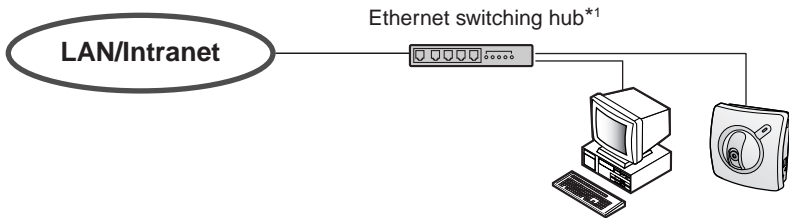

*1 Network traffic can be improved by using the Ethernet switching hub.

[Type 2]—Internet Connection with a Broadband Router

Network Camera can be accessed from the Internet. The broadband router needs Port Forwarding (IP Masquerade) feature on page 32.

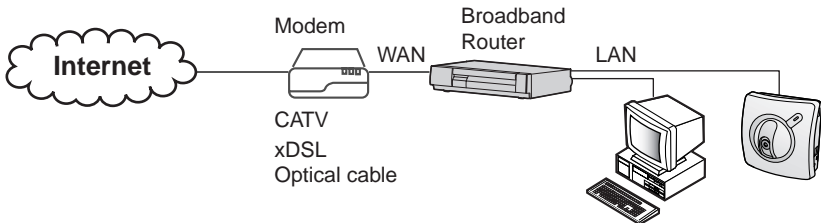

[Type 3]—Internet Direct Connection with a Modem

Network Camera can be installed alone without PC on the network. When you set up Network Camera in [Type 3], connect Network Camera temporarily in [Type 1], [Type 2] or [Type 4].

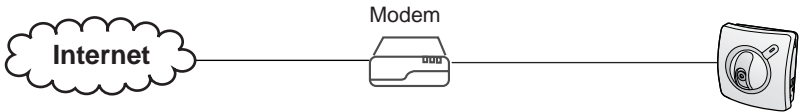

Note

Some xDSL services use PPPoE. Network Camera does not support PPPoE. If the Internet connection requires PPPoE, connect with the broadband router supporting PPPoE like [Type 2].

[Type 4]—Direct Connection with a PC

Network Camera can be connected to a PC directly.

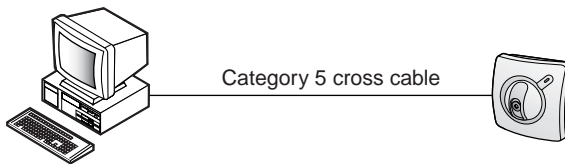

Note

Use a category 5 cross cable when connecting directly with the cable to the PC.

2.3 How to turn on Network Camera for Installation

Connect the DC plug of the AC adaptor to the DC IN jack and a category 5 straight/cross cable to the Ethernet port. Connect the AC plug of the AC adaptor to the power outlet to turn on Network Camera. Pan/Tilt moves to the center position. Ethernet Indicator turns on when the network is active.

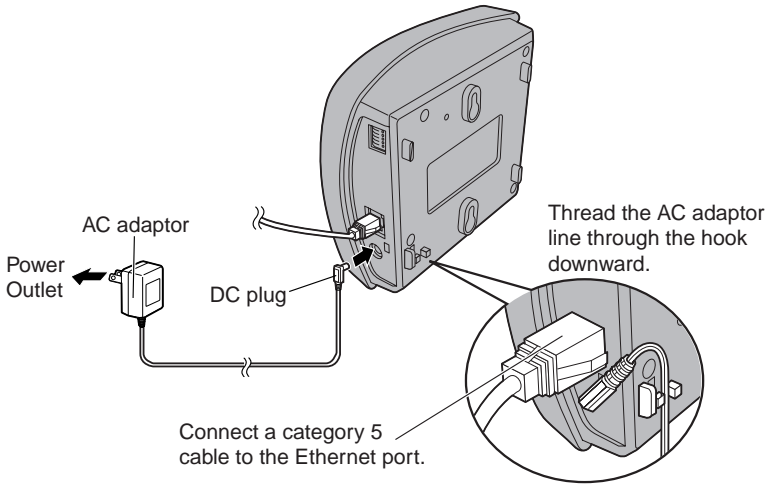

Notes

- AC adaptor is used as the main disconnect device, so ensure that the power outlet is located/installed near the equipment and is easily accessible.
- Use only the specified Panasonic AC adaptor PQLV10 (Order No. PQLV10Y).
- When you set up Network Camera in **[Type 3]**, connect it temporarily in **[Type 1]**, **[Type 2]** or **[Type 4]**.
- When Ethernet Indicator is off, confirm that the Ethernet cable is properly connected, or PC, Ethernet hub or broadband router is properly working.
- Thread the AC adaptor line through the hook upward if it is convenient.

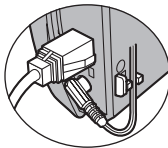

2.4 Network Parameters

2.4.1 Preparing the Network Parameters for Network Camera

Before starting to set up the network parameters of Network Camera, make note of corresponding network parameters.

- [Type 1]** Ask your network administrator for the network parameters.
- [Type 2]** Refer to the broadband router's manual for the network parameters.
- [Type 3]** Ask your ISP (Internet Service Provider) for the network parameters.
- [Type 4]** Install Network Camera in the default condition. Set the PC "192.168.0.250" (IP address) and "255.255.255.0" (Subnet Mask). Refer to page 24.

Refer to page 22 and page 23 for network parameters.

Network parameters memo for Network Camera

The devices on the network may not be assigned the same IP address. Each device must have its own IP address. Overlapped IP addresses can cause other network devices to stop working and may result in widespread network problems.

🖱 IP Address . . .	🖱 Subnet Mask . . .
🖱 Default Gateway . . .	🖱 DNS Server 1 . . .
🖱 DNS Server 2 . . .	

Network Parameters Table

Parameters	Network Camera Configuration Type			
	[Type 1]	[Type 2]	[Type 3]	[Type 4]
Port No.	80 (default)	80 (default) ^{*2}	80 (default) ^{*1}	80 (default)
IP address	Check [Static], and set the static private IP address.	Check [Static], and set the static private IP address. ^{*3}	Check [Static], and set the static global IP address. ^{*4}	192.168.0.253 (default)
Subnet Mask	Set the Subnet Mask fitted to your network.			255.255.255.0 (default)
Default Gateway	Set Default Gateway address.	Set the private IP address of the broadband router (on your network), not of the gateway of your ISP. ^{*3}	Set Default Gateway address. ^{*4}	You do not need to set up.
DNS Server 1, 2	Set DNS server address.		Set DNS server address. ^{*4}	
DDNS	You do not need to set up.	^{*5}	^{*5}	You do not need to set up.
Max. Bandwidth Usage	It can restrict the transmit bandwidth. Select from 0.1 to Unlimited Mbit/s.			

- ^{*1} Many ISP's intentionally block port number 80 to guard against network viruses. If your ISP blocks port number 80, substitute it to another unused port number.
- ^{*2} When you use more than one Network Camera with a broadband router, each Network Camera needs its own port number. The broadband router needs the Port Forwarding feature. Refer to page 32.
- ^{*3} Refer to the broadband router's manual for the Port Forwarding feature.
- ^{*4} When you use Network Camera in DHCP feature, check [DHCP] and enter the Host Name if your ISP requires. If you automatically get the address of Default Gateway and DNS server from DHCP server, you do not need to set up.
- ^{*5} Verify that your ISP supports DDNS. If your ISP supports DDNS, or if you assign a domain name to Network Camera, you need to contract and register for DDNS service. Refer to the included leaflet for DDNS service. If you set static global IP address to Network Camera and the broadband router, you do not need to register DDNS service.

How to refer the network parameters from the PC

If you cannot get the network parameters, you can refer to the network parameters except for IP address from the PC on the same network in the following procedure.

- **When using Windows 95, Windows 98 or Windows Me**

1. Click **[Start]** → **[Run...]**. **Run window** appears.

These steps are slightly different depending on the operating system.

2. Enter **"winipcfg"** and click **[OK]**. **IP configuration window** appears.

3. Select the proper Ethernet adaptor and click **[More Info]**.

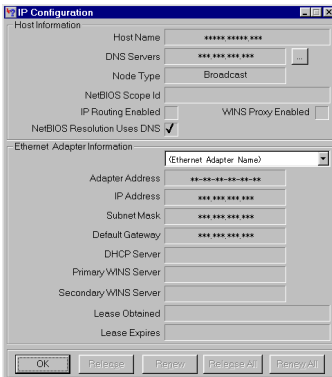

4. Click **[OK]** to close IP Configuration window.

- **When using Windows NT, Windows 2000 or Windows XP**

1. Click **[Start]** → **[Program]** (→ **[Accessories]**) → **[MS-DOS® (Command) Prompt]**. **MS-DOS Prompt window** opens. These steps are slightly different depending on the operating system.

2. Enter **"ipconfig /all"** and press **[Enter]**.

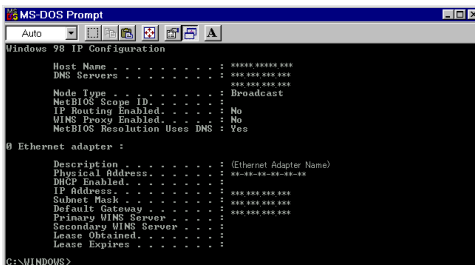

3. Enter **"exit"** and press **[Enter]** to close the window.

2.4.2 Setting IP Address of the PC in [Type 4] Configuration Type

Your PC needs to have a static private IP address to access Network Camera in [Type 4] configuration.

1. Follow the steps below, appropriate for your operating system to open **TCP/IP Properties window** on the PC.

TCP/IP Properties Table

Operating System	Steps
Windows 95 Windows 98 Windows Me	[Start] → [Settings] → [Control Panel] → [Network] → Select [TCP/IP] with adaptor in use → [Properties] → [Specify an IP address]
Windows NT	[Start] → [Settings] → [Control Panel] → [Network] → [Protocols] tab → [TCP/IP Protocol] → [Properties] → Select [Adaptor] in use → [Specify an IP address]
Windows 2000	[Start] → [Settings] → [Control Panel] → [Network and Dial-up Connections] → [Local Area Connection Icon] in use → [Properties] → Select Internet Protocol [TCP/IP] → [Properties] → [Use the following IP address]
Windows XP	[Start] (→ [Settings]) → [Control Panel] → [Network and Internet Connections] → [Network Connections] → [Local Area Connection Icon] in use → [Properties] → Select Internet Protocol [TCP/IP] → [Properties] → [Use the following IP address]

Note

When using Windows NT, Windows 2000 and Windows XP, log on as an administrator ID to access **TCP/IP Properties window**.

- 2. TCP/IP Properties window** appears. Set "192.168.0.250" in the IP address data field and "255.255.255.0" in the Subnet Mask data field.

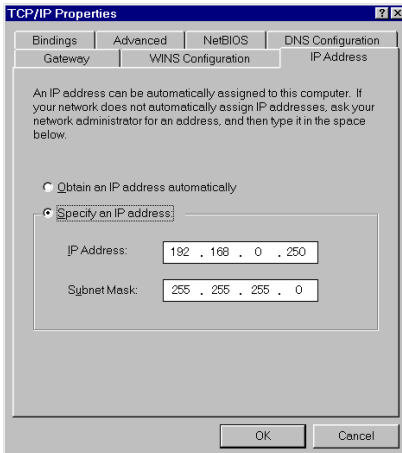

- 3. Click [OK].**

Private IP address

Private IP address is the network ID that is not used on the Internet. They are classified into Class A, Class B and Class C, as shown in the next table. Set the IP address in the range of the number specified in the class meeting to your local network scale.

Class	Subnet Mask	Private IP address (It can be set freely within the range in your group.)
Class A	255. 0. 0. 0	10. 0. 0. 1 — 10. 255. 255. 254
Class B	255. 255. 0. 0	172. 16. 0. 1 — 172. 31. 255. 254
Class C	255. 255. 255. 0	192. 168. 0. 1 — 192. 168. 255. 254

2.5 Proxy Server Setting

A proxy server may prevent you from connecting directly to Network Camera in some corporate environments. The web browser can set up the IP address communication without using a proxy server. Consult your ISP or network administrator.

Note

A proxy server is generally used to maintain security on a network that offers an Internet connection. The network of Network Camera with the proxy server may cause some problems to the image quality such as taking much time in refresh interval. Consult your ISP or network administrator for details.

1. Start up the Internet Explorer. (The window is Internet Explorer 5.50.)
2. Select **[Tools]** → **[Internet Options...]** → **[Connections]** tab and click **[LAN Settings]**. See if the **Use a proxy server** check box is checked or not in the next window. When checked, click **[Advanced...]**.

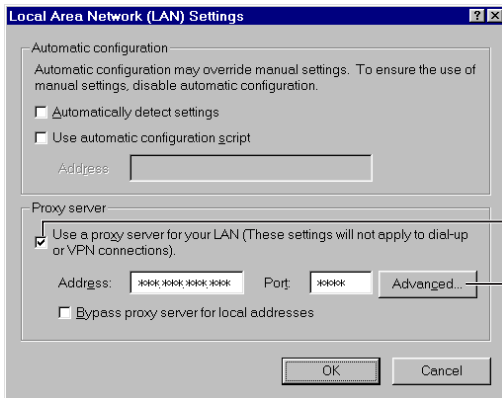

See if the check box is checked or not.
When checked, click **[Advanced...]**.

When not checked, click **[Cancel]**. Your proxy settings are causing no problems.

3. Enter the IP address of Network Camera assigned from your ISP or network administrator into the **Do not use proxy server for addresses beginning with data field**.

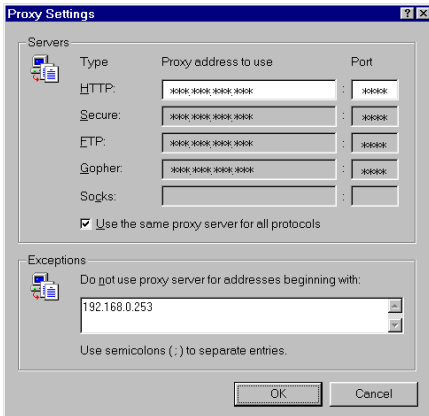

4. Click **[OK]** on all of the opening windows.

2.6 Simple Installation using the Setup CD-ROM

After finishing cabling, turn on Network Camera and insert the Setup CD-ROM in the CD-ROM drive of the PC. Setup CD-ROM should start the application automatically. This program automatically finds Network Cameras on the network.

1. Turn on Network Camera.
2. Insert the Setup CD-ROM in the CD-ROM drive of the PC.
(If **Network Camera Setup window** does not appear, click "setup.exe" on the Setup CD-ROM.)

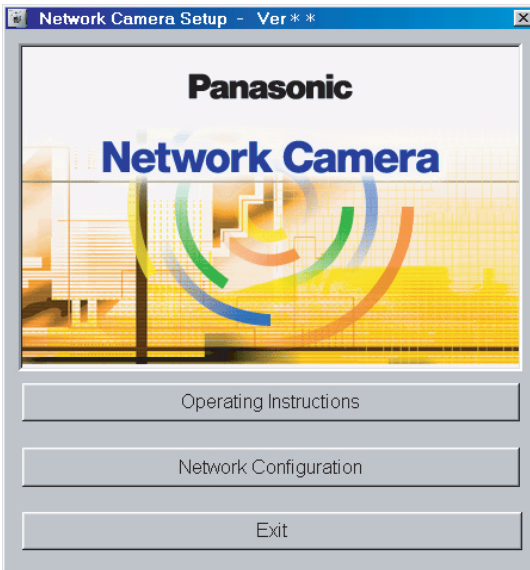

3. Click **[Network Configuration]**. **Network Camera List window** appears. Setup program finds all Network Cameras connected on your local network. It lists all of MAC addresses and IP addresses of Network Cameras. Network Cameras that are isolated by the use of a home gateway or broadband router will not be detected. Record MAC address on the Network Camera Memo on page 3. It is useful for customer servicing.

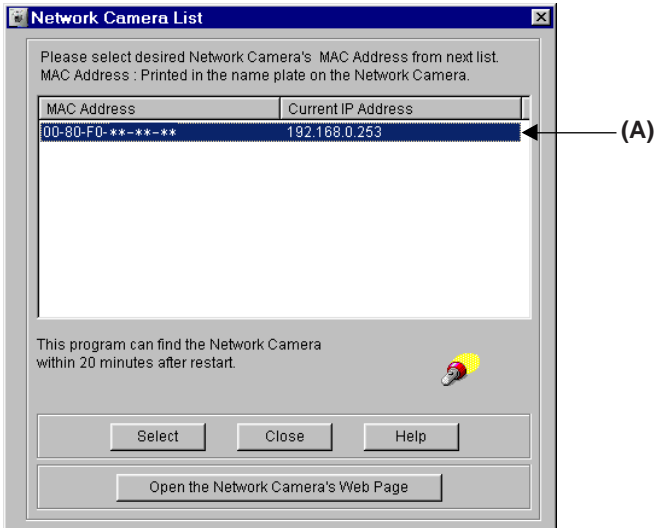

Notes

- The setup program finds and identifies Network Camera by listening for data, which Network Camera sends out for the first 20 minutes after powering up. If the installation is not completed within 20 minutes, disconnect temporarily the AC adaptor to restart this operation.
- Each Network Camera has a unique MAC address labeled on the back. Refer to page 15.
- Network Cameras that are isolated by the use of a home gateway or broadband router will not be detected.

4. Select your target Network Camera from the list as shown in example (A) on **Network Camera List window** on page 29 and click **[Select]**. **Configuration window** appears. Refer to page 21 and page 22 and enter the correct network parameters. Refer to page 55 for details of each parameter.

The screenshot shows a configuration window titled "Configuration : MAC ADDRESS 00-80-F0-**-**-**". It contains several sections for network settings:

- Static IP Configuration:** Port No. (80), IP Address (192.168.0.253), Subnet Mask (255.255.255.0).
- DHCP Configuration:** Host Name (empty), Current IP Address (192.168.0.253), Current Subnet Mask (255.255.255.0).
- Default Gateway:** 0.0.0.0
- DNS Servers:** DNS Server1 (0.0.0.0), DNS Server2 (0.0.0.0).
- DDNS Section:** Includes checkboxes for "DDNS Enable", "Your E-Mail Address", "Personal (Camera) URL", and "Your Account Link".
- Bandwidth Usage:** Max Bandwidth Usage set to "Unlimited" Mbits.

Buttons for "Save" and "Cancel" are located at the bottom.

5. Click **[Save]** when finished. The "Successful!" message box appears.



Notes

- Network Camera automatically restarts after saving the network configuration.
- Overlapped IP address displays the next box. If you cannot set up, ask your ISP or the administrator.

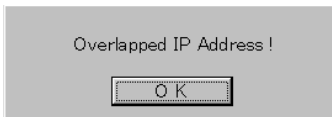

6. Click [OK].

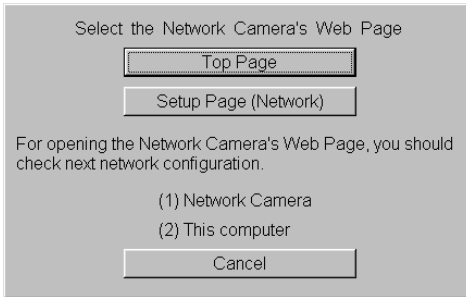

Refer to page 54 for **Setup Page (Network window)**.

7. Click [Top Page]. Top Page appears.



Click the language to change the display.

Refer to page 37 for **Top Page**.

Notes

- When viewing images for the first time in the Internet Explorer, a pop-up **Security Warning window** may appear. The window requests your permission to download ActiveX® Controls (OCX file) used to display Motion JPEG. Refer to page 39.
- If you are configuring in **[Type 3]**, Top Page may not appear at this point. After Network Camera is directly connected with the modem, confirm the Network Camera Access from the Internet on page 32.

2.7 Network Camera Access from the Internet

[Type 2] and [Type 3] of the Network Camera configuration type allow Network Camera to be accessed from the Internet.

Port Forwarding (IP Masquerade) feature

Set up the Port Forwarding feature to the broadband router if the [Type 2]—**Internet Connection with the Broadband Router** on page 18 is configured. Port Forwarding feature translates a global IP address to a private IP address and assign a unique port number for each Network Camera. Refer to the broadband router's manual for details.

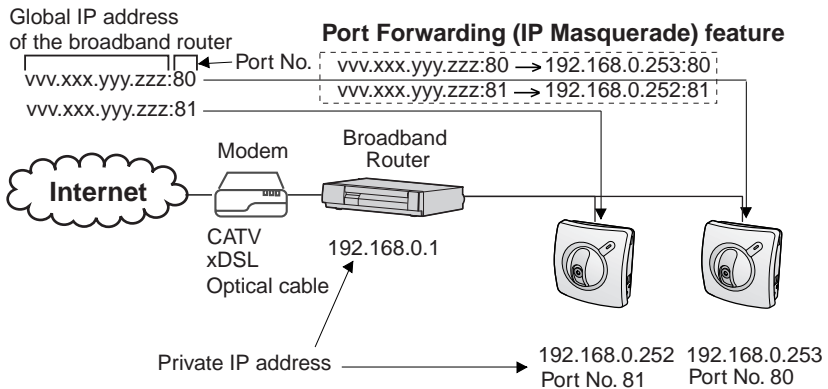

1. Start up the web browser of the PC on the Internet side.
2. Enter "**http://IP address:Port No.**" in the address field and press [Enter]. Top Page appears.
 - When port number is 80 (default), you do not need to enter port number.

[Type 2] Enter "**http://Global IP address of Broadband Router:Port No.**" in the address field.

[Type 3] Enter "**http://Global IP address of Network Camera:Port No.**" in the address field.

Top Page



Click the language to change the display.

Refer to page 37 for Top Page.

Note

When viewing images for the first time in the Internet Explorer, a pop-up **Security Warning window** may appear. The window requests your permission to download ActiveX Controls (OCX file) used to display Motion JPEG. Refer to page 39.

If Top Page does not appear

Confirm the network parameters and the connections of Network Camera through page 18—page 32.

Section 3

Network Camera Screen and Setup Window

3.1 Network Camera Flow Chart

Top Page enables you to access Top View Image screen (Single Camera/Multi-Camera screen). Authentication window can set password for the link at (A).

Enter "http://IP Address (or URL):Port No." on the web browser.
 When port number is 80 (default), you do not need to enter port number.

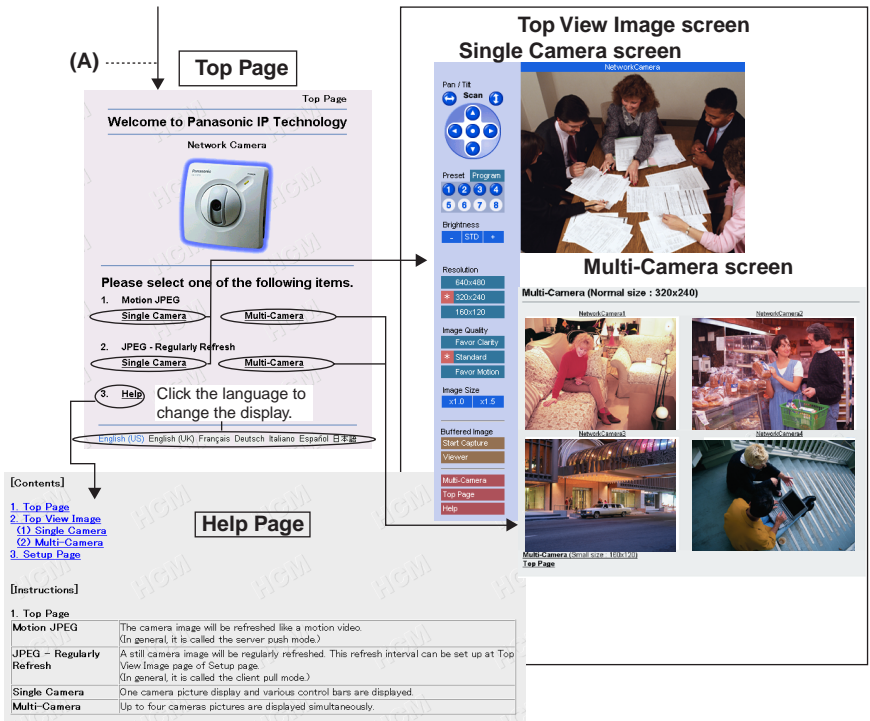

(A) Authentication window

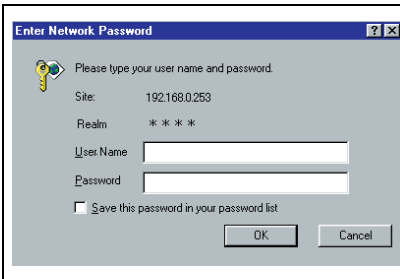

Authentication window can be set up for the security. The password can keep the security of your network. Authentication windows are not displayed in the default. Authentication window can be set on Administrator window. "User Name" and "Password" are case sensitive. Refer to page 60 for details.

3.2 Top Page

Top Page allows you to select the Single/Multi-Camera screen in Motion JPEG or JPEG - Regularly Refresh. Motion JPEG enables you to view the image like a motion video, and JPEG - Regularly Refresh can be set the refresh interval.

Enter "**http://IP Address (or URL):Port No.**" on the web browser.
When port number is 80 (default), you do not need to enter port number. Then Top Page appears.

Example

- Accessing Top Page using port number 80 (default)
http://192.168.0.253
- Accessing Top Page using port number 81
http://192.168.0.253:81
- Accessing Top Page with Global IP address from outside network in **Internet Connection** on page 18.
http://Global IP address of Broadband Router:PortNo.

Top Page



Top Page title and Network Camera picture can be changed and the link can be set on the picture. Refer to page 64.

Click the language to change the display. Top Page, Single Camera and Multi-Camera screens also display the selected language.

Note

The initial language displayed at the first access can be selected on Top View Image Setting window on page 64.

Notes

- If a port number is specified in the IP address, "**http://**" must precede the IP address, otherwise the port number will not be recognized.
- When viewing images for the first time in the Internet Explorer, a pop-up **Security Warning window** may appear. The window requests your permission to download ActiveX Controls (OCX file) used to display Motion JPEG. Refer to page 39.

Motion JPEG	The image refreshes continuously like a motion video.
JPEG - Regularly Refresh	The image refreshes periodically. The refresh interval can be set up at Top View Image Setting window on page 64. JPEG - Regularly Refresh is suggested when using dial-up Internet connections or network connections offering limited bandwidth.
Single Camera	Selecting this link in either Motion JPEG or JPEG - Regularly Refresh can display images of the individual Network Camera you are currently connecting to. Refer to page 40.
Multi-Camera	Selecting this link in either Motion JPEG or JPEG - Regularly Refresh can display images of four separate Network Cameras if configured. Information on this feature can be found on page 48 and page 81.
Help	Help page appears.

Note

Network Camera is designed to work with 10/100 Mbps networks, cable modems or xDSL Internet connections. 56K dial-up connection may prevent the Motion JPEG to view smoothly. On some networks the available bandwidth may be intentionally restricted to lock out streaming video services. JPEG - Regularly Refresh solves the problem in the restricted bandwidth.

ActiveX Controls

When viewing images for the first time in the Internet Explorer, a pop-up **Security Warning window** may appear. The window requests your permission to download ActiveX Controls (OCX file) used to display Motion JPEG. Allow the file to be installed. It is required and will not cause any problems with other applications on the PC. If **Security Warning window** appears, click **[Yes]**. When using Windows NT, Windows 2000 or Windows XP, log on with an appropriate account that is authorized to install applications.

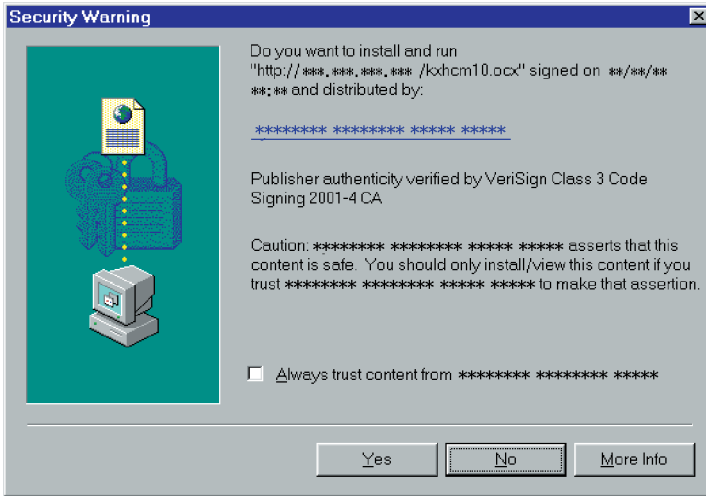

If you cannot download ActiveX Controls or you cannot see the image in the Internet Explorer

- Click **[Tools]** → **[Internet Options]** → **[Security]** tab and click **[Custom level]** on the window.
 - (1) Check "Prompt" in "Download signed ActiveX Controls".
 - (2) Check "Enable" in "Run ActiveX Controls and plug-ins".
- ActiveX Controls can be also installed from the Setup CD-ROM.
 - (1) Restart the PC.
 - (2) Confirm that Internet Explorer is closed.
 - (3) Double-click the "ocx\ActiveXInst.exe" on the Setup CD-ROM.

3.3 Single Camera Screen

Single Camera can move the lens by the **Pan/Tilt operation**, **Preset Positioning** and **Click to Center**. Single Camera screen can be set eight preset positions. **[Viewer]** links to the Buffered Image screen.

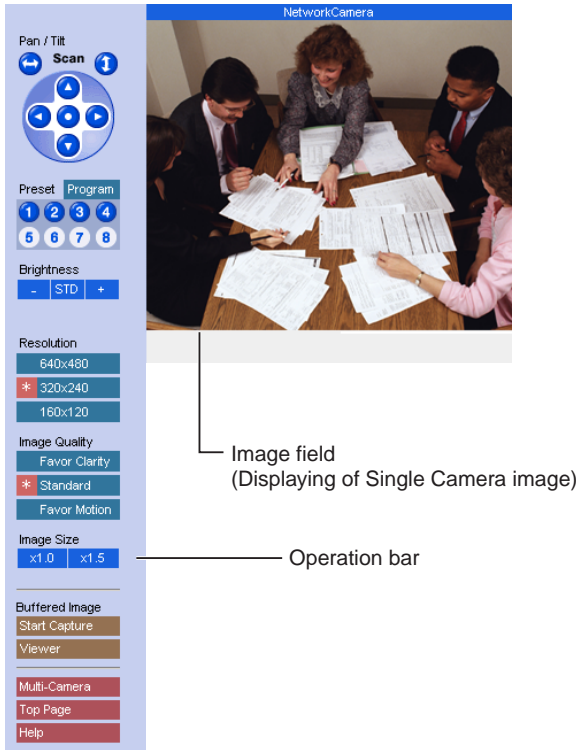

Notes

- The Screen Saver can prevent the PC monitor from burning in displaying the same image.
- Selecting a resolution of 640 x 480 will result in a slight loss of speed when viewing Motion JPEG. Selecting 320 x 240 offers the good compromise between speed and resolution.

Click to Center

When you click the certain point on the Single Camera screen, the point is centered on the image.

1. Put the cursor on the point which should be centered and click it.



2. The clicked point is centered.



Note

Click to Center does not move over the end of corner when the Pan/Tilt range reaches the end. The Pan/Tilt operation can be locked by Pan/Tilt control on page 78.

3.3.1 Using Operation Bar

Operation bar controls the general use of Network Camera. The following sections describe the general way of using it.

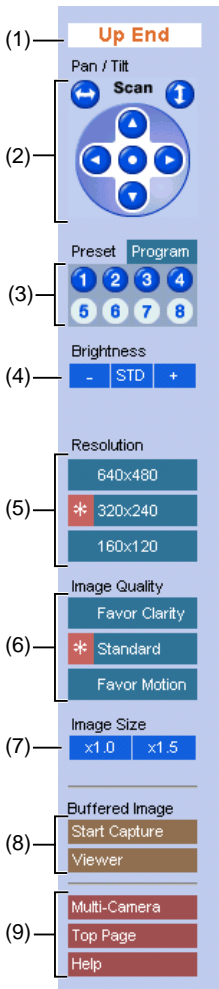

- (1) **End Display:** When Pan/Tilt operation has reached the end of corner, **Left End**, **Right End**, **Up End** or **Down End** appears.
Locked Display: Pan/Tilt/Preset, Brightness Control and Preset program can be locked. **Locked** appears when the operation bar is clicked.
Preset Display: Preset name appears when clicking Preset Button.
- (2) **Pan/Tilt Scan, Pan/Tilt and Home Position:** Refer to page 43.
- (3) **Preset Buttons:** Refer to page 44.
- (4) **Brightness:** Brightness control has nine steps including **[STD]** (Standard). Clicking **[-]** and **[+]** buttons changes the brightness of image. Brightness can be locked on Camera Setup window on page 78.
- (5) **Resolution:** **[640 x 480]**, **[320 x 240]** (default) or **[160 x 120]**
- (6) **Image Quality:** **[Favor Clarity]** optimizes the image for good clarity. **[Standard]** keeps the standard quality. **[Favor Motion]** optimizes the image for motion display.
- (7) **Image Size:** The default image size is x 1. **[x 1.5]** expands only the size. The resolution does not change.
- (8) **Buffered Image:** **[Start Capture]** starts buffering the image. **[Viewer]** links to the Buffered Image screen on page 46. Each button changes to **[Primary]** and **[Secondary]** button when using Image Transfer feature.
- (9) **Link Buttons:** Each buttons link to Multi-Camera screen, Top Page and Help Page.

3.3.2 Using Pan/Tilt Operation

Pan/Tilt scan buttons automatically move the lens horizontally from -60° to $+60^{\circ}$ and vertically from 0° to -45° , and the lens returns to the current position. Use Click to Center feature to stop scanning. Each surrounding arrow of Pan/Tilt moves the lens Up, Down, Right, Left, and the home position button moves it to Home Position.

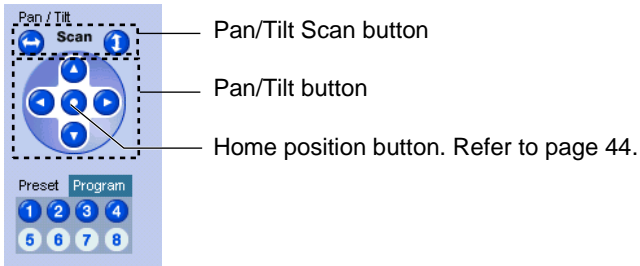

Note

Pan/Tilt operation can be locked on Camera Setup window on page 78.

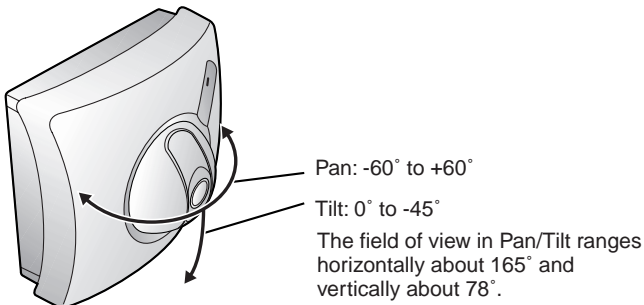

Notes

- Pan/Tilt Range can be selected on Camera Setup window on page 78.
- When the power is on, do not manually revolve the Pan/Tilt. Revolving it or moving it manually by some mistake may damage the Pan/Tilt operation, or change the registered Pan/Tilt positions from actual ones. Restart Network Camera when the latter case happens.
- Do not touch the lens. It may leave a fingerprint and can cause the image to be out of focus. This can also take away the protective coating on the lens.

3.3.3 Setting Preset Positioning and Home Positioning

Preset positioning and Home Positioning allow you to fix the lens on a specific point. This feature can memorize Brightness and White Balance settings. The preset buttons (1—4) are registered in the factory default.

(1: Upper Left, 2: Upper Right, 3: Lower Left, 4: Lower Right)

All eight preset buttons and home position button can be overridden. Lens moves to the preset/home position when clicking each registered button. Blue/White buttons mean Registered/Not registered. Camera Setup window on page 78 can lock the Preset/Home Positioning features.

Registering or modifying the preset buttons or home position button

- 1) Click **[Program]**. Red cancel button appears.
 - **[Cancel]** returns to the Single Camera screen.
- 2) Move the lens to a desired position using Pan/Tilt operation.
- 3) Select the preset number or home position button to register or modify.
 - After registering or modifying the home position button, "Success!" appears on the display. Go to step 7.
- 4) Enter the name of the preset button.
 - Max. 15 characters
 - Refer to unavailable character set 1 on page 96.
 - Refer to displayable character set on page 97.
- 5) Click **[Save]**.
 - **[Cancel]** returns to the Single Camera screen without saving.
- 6) Registered preset button turns blue.
 - Go back to step 2 to register or modify other preset buttons.
- 7) Click **[Cancel]** when finished.

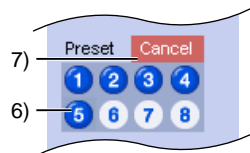
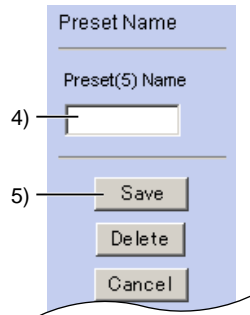
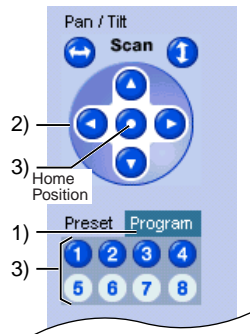

Deleting the preset buttons

- 1) Click **[Program]**. Red cancel button appears.
 - **[Cancel]** links to the Single Camera screen without deleting.
- 2) Select the preset number to delete.
- 3) Click **[Delete]**.
 - **[Cancel]** links to the Single Camera screen without deleting.
- 4) Deleted preset button turns white.
 - Go back to step 2 to delete other preset buttons.
- 5) Click **[Cancel!]** when finished.

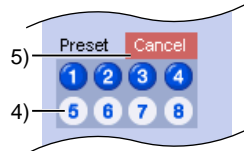
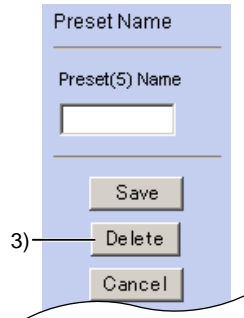
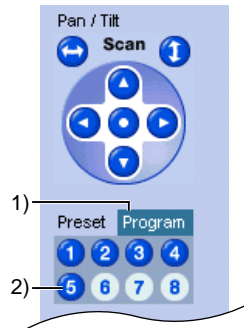

3.3.4 Viewing Buffered Image Screen

Buffered Image screen can be viewed by clicking **[Viewer]** on the operation bar. Buffered Image is saved in the internal memory of Network Camera by clicking **[Start Capture]**. Alarm/Timer mode in the Image Transfer on page 66 can also buffer the image. Buffered Image is erased by power off, restarting, Update Firmware, resetting to Factory Default and when Image Transfer or Name/Time window is saved and clicking **[Start Capture]**.

Buffered Image

1. Buffered Image Viewer

No. 1 Date: Jan. 1, 2003 12: 0:00.000 AM



The image number, date and time are displayed.
(The example shows 12h 0min 0s 000ms on January 1st, 2003)

[Play]
The buffered images are displayed continuously.

[<Prev] & [Next>]
The previous image or next image is displayed.

[<10] & [10>]
The 10th image before or after the image is displayed.

[<100] & [100>]
The 100th image before or after the image is displayed.

2. [Single Camera](#)

3. [Top Page](#)

4. [Help](#)

Operation bar of the Single Camera screen changes in the Image Transfer mode. **[Start Capture]** and **[Viewer]** are displayed in the Non Transfer mode. **[Primary]** and **[Secondary]** are displayed in the Alarm/Timer mode. Refer to page 66 about the Image Transfer feature.

Non Transfer mode	Alarm/Timer mode
<div style="border: 1px solid gray; padding: 5px; margin: 5px;"> <p>Buffered Image</p> <p>Start Capture</p> <p>Viewer</p> </div>	<div style="border: 1px solid gray; padding: 5px; margin: 5px;"> <p>Buffered Image</p> <p>Primary</p> <p>Secondary</p> </div>

- [Start Capture]** : **[Start Capture]** saves the individual images to the internal memory. Network traffic, PC performance, image quality and image resolution influence **[Play] mode** time and the refresh interval of the image. The resolution is the same as the current image settings. At a resolution of 320 x 240 in standard, Network Camera stores approximately 80 frames.
- [Viewer]** : **[Viewer]** enables you to view the buffered image by clicking **[Start Capture]**.
- [Primary]** : **[Primary]** enables you to view the buffered image in the primary time in the Alarm/Timer mode.
- [Secondary]** : **[Secondary]** enables you to view the buffered image in the secondary time in the Alarm/Timer mode.

Notes

- The refresh interval becomes longer as more clients access Network Camera.
- The image resolution, image quality and object situation affect the number of frames in the Buffered Image.
- If internal memory is filled after clicking **[Start Capture]**, the image buffering will stop automatically.

To save still images on your PC

The PC can save still images taken by JPEG - Regularly Refresh and Buffered Image. The refresh interval of JPEG - Regularly Refresh should be 30 seconds or more in saving the image.

To save the image, place the cursor on the image and click the right button of the mouse. Then select "Save Picture As...". Enter a picture name and save.

Note

The PC cannot save Motion JPEG and **[Play] mode** images of Buffered Image.

3.4 Multi-Camera Screen

Four separate Network Camera images can be displayed in both Motion JPEG and JPEG - Regularly Refresh. The Pan/Tilt operation cannot be operated on the Multi-Camera screen. You can jump to each individual Network Camera by clicking Camera Name. The Single Camera screen has the Pan/Tilt operation, which can reflect on the Multi-Camera screen.

Refer to page 81 for how to configure each Network Camera.

Multi-Camera (Normal size : 320x240)

Link to each Single Camera when clicking Camera Name.

Image Field (Displaying Multi-Camera Image)

Multi-Camera (Small size : 180x120)
[Top Page](#)

Changes the image size.

Notes

- On the Multi-Camera screen, the maximum image resolution is limited to 320 x 240.
- Motion JPEG stops on the Multi-Camera screen if Limit time of continuous Motion JPEG is set up at a Network Camera.
- When refreshing interval is slow, it can be improved by using an Ethernet switching hub instead of the repeater hub or restricting the Max. Bandwidth Usage on **Network window** on page 54. Refer to page 114 for other solutions.
- Multi-Camera screen can also display the images of Panasonic Network Cameras (KX-HCM series).

3.5 Setup Page

Setup Page controls all features of Network Camera. Authentication window protects the Network Camera security. It enables only administrator to access Setup Page by entering ID and Password.

Enter "**http://IP Address (or URL):Port No./config.html**" on the web browser and press **[Enter]**. When port number is 80 (default), you do not need to enter port number. Then Setup Page appears.

Example

- Accessing Setup Page using port number 80 (default)
http://192.168.0.253/config.html
- Accessing Setup Page using port number 81
http://192.168.0.253:81/config.html
- Accessing Setup Page with Global IP address from outside network in **Internet Connection** on page 18.
http://Global IP address of Broadband Router:Port No./config.html

Setup Page

Panasonic
Network Camera
NetworkCamera

(1) Go to Top Page

Basic

(2) Network

(3) Name/Time

(4) Security: Administrator

(5) Security: General User

(6) Top View Image

Transfer

(7) Image Transfer

Additional

(8) Camera Setup

(9) Multi-Camera

(10) External Output Control

(11) Indicator Control

Maintenance

(12) Status

(13) Restart

(14) Update Firmware

(15) Reset to Factory Default

(16) Help

Setup Page

Welcome to Panasonic IP Technology



Network Camera Version *** Version number

Please Select an item on the left.

Note

Firmware Version number indicated on Setup Page is important for your future support of Network Camera.

Item	Description
(1) Go to Top Page	Links to Top Page. You can access Single/Multi-Camera screen in Motion JPEG/JPEG - Regularly Refresh. Refer to page 53.
(2) Network	Configures the network setting (Static/DHCP, Default Gateway, Port Number, DNS, DDNS and Bandwidth). Refer to page 54.
(3) Name/Time	Sets the Camera Name on the Single Camera screen. Date and Time is used in the Alarm/Timer mode in the Image Transfer feature and On the Air time setting on Top View Image Setting window. NTP automatically adjusts the internal clock of Network Camera. Refer to page 58.
(4) Security: Administrator	Sets administrator ID and password. Authentication window can be enabled. Administrator should control Network Camera. Refer to page 60.
(5) Security: General User	Sets general user ID and password. General user is the registered user. Refer to page 62.
(6) Top View Image	Sets the initial language, Title, Image URL, Link URL, the image resolution, image quality, refresh interval and the Limit time of Continuous Motion and On the Air time. Top View Image screen consists of Single Camera and Multi-Camera screen. Refer to page 64.
(7) Image Transfer	Enables the Alarm/Timer mode in the Image Transfer feature. Network Camera can transfer the image via e-mail or FTP. The alarm/timer trigger can be set on Image Transfer window. Refer to page 66.
(8) Camera Setup	Sets White Balance and Power Line Frequency. You can lock the Brightness, Pan/Tilt/Presets and Preset Program Control features. You can also select Pan Range and Tilt Range. Refer to page 78.
(9) Multi-Camera	The Multi-Camera screen needs to set up these parameters. Enter the Camera Names and IP addresses of each Network Camera. The Multi-Camera can display up to four images in a window. Refer to page 81.

Item	Description
(10) External Output Control	Sets the External Device Control Output setting to attach external sensors/devices. (Open or Short to GND) Refer to page 83 and page 94.
(11) Indicator Control	Sets Power Indicator operation. Indicator will be turned on in the default. Refer to page 84.
(12) Status	Displays general information of Network Camera. Refer to page 85.
(13) Restart	Restarts Network Camera retaining any settings you entered. If any operational issues are changed, try this option first. Refer to page 86.
(14) Update Firmware	Updates the program to operate Network Camera on the latest version of the system. Refer to page 87.
(15) Reset to Factory Default	Initializes all the parameters to the factory default. Note that all customer-applied settings will be lost, requiring you to reconfigure Network Camera. Refer to page 90.
(16) Help	Provides you with detailed instructions of the terms and functions of Network Camera.

3.5.1 Go to Top Page

Click **[Go to Top Page]** on Setup Page. You can access the Single Camera and Multi-Camera screen in Motion JPEG/JPEG - Regularly Refresh.



Click the language to change the display.

3.5.2 Network

Network window configures network parameters. Restart Network Camera to make the parameters effective.

- You can set disable Configuration window from the Setup CD-ROM for the security by clearing the check.

1. Click [Network] on Setup Page.

1. Network Configuration from Setup Program Enable
 After setting network configuration, you must set disable for network security.

2. Internet Connection

Port No.

Static
 Enter the proper address (required)
 IP Address
 Enter the proper mask (required)
 Subnet Mask

DHCP
 Host Name
 Current IP Address 192.168.0.253
 Current Subnet Mask 255.255.255.0

3. Default Gateway
 In case of communication over the Gateway, you must enter the proper address.
 Gateway

4. DNS
 In case of Host Name in E-Mail, FTP or Multi-Camera, you must enter the proper address.
 DNS Server1
 DNS Server2

5. DDNS Enable
 By registering DDNS service, you can create a personalized web address at which your camera's live video can be found on the internet.
 Your E-Mail Address
 To register DDNS service, please enable "DDNS", fill "Default Gateway" and "DNS", set "your E-Mail Address" and click "Save". You will receive an introductory E-mail shortly. Please follow the instructions in the E-Mail to register.
 Personal (Camera) URL
Your Account Link

6. Max Bandwidth Usage Mbps

2. Enter each parameter in the proper data field. Click [**Save**] when finished.
 - Click [**Cancel**] to quit the current settings. The window returns to Setup Page without saving the parameters.

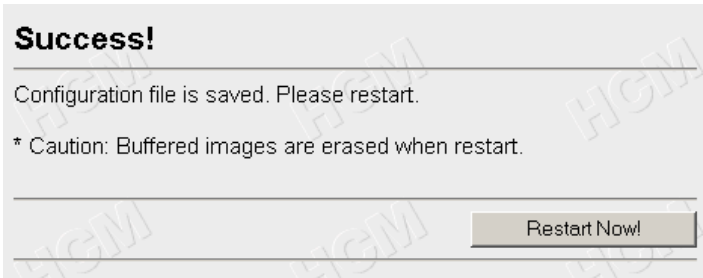

3. Click [**Restart Now!**] to restart to make the changed parameters effective.

Instructions for the data fields

Port No.	<ul style="list-style-type: none"> • You can set up the port number of Network Camera. (Default is 80.) If you use more than one Network Camera with a broadband router on the network, each Network Camera must be assigned its own port number. • Refer to Port Forwarding feature on page 32. • Many ISP's intentionally block port number 80 to guard against certain network viruses. If your ISP blocks port number 80, substitute another unused port number. • Enter only the number. (1—65535) <p>Note</p> <p>Certain port numbers assigned on the network devices, and the network protocol are not available e.g., FTP: 20, 21, Telnet: 23, SMTP: 25, DNS: 53, POP3: 110, HTTPS: 443, ICQ: 4000 and IRC: 6661—6667. The port numbers between 50000 and 59999 are recommended to use. To assign port numbers on a large network, consult and work with your ISP or administrator.</p>
----------	--

Instructions for the data fields

<p>Static</p> <ul style="list-style-type: none"> • IP Address • Subnet Mask 	<ul style="list-style-type: none"> • Check [Static], when having specified IP address assigned to Network Camera from your ISP or administrator. Enter the specified IP address and Subnet Mask. • If you use Network Camera on the LAN, set up in the same class as your PC is in. Refer to page 25 for the class. • Refer to page 96 for the IP addressing.
<p>DHCP</p> <ul style="list-style-type: none"> • Host Name 	<ul style="list-style-type: none"> • Check [DHCP] (Dynamic Host Configuration Protocol), when your ISP uses the DHCP server function which assigns an IP address to Network Camera automatically. Enter the Host name. Follow the instructions of your ISP or administrator for the Host name. • Refer to unavailable character set 1 in page 96 for the Host name.
<p>Default Gateway*^a</p>	<ul style="list-style-type: none"> • If you have the specified Default Gateway address from your ISP or administrator, enter it in this data field. • Refer to page 96 for the IP addressing.
<p>DNS Server*^a</p>	<ul style="list-style-type: none"> • Set DNS server address when you use Host Name to register Network Camera on Multi-Camera window on page 81. • If you have the specified DNS server address from your ISP or administrator, enter it in this data field. You can set up two DNS server addresses. • Refer to page 96 for the IP addressing.

Instructions for the data fields

<p>DDNS</p> <ul style="list-style-type: none"> • Your E-mail Address • Personal (Camera) URL • Your Account Link 	<ul style="list-style-type: none"> • If your ISP specified IP address of Cable/xDSL modem is not static, you need to contract to DDNS (Dynamic Domain Name System) service. Check DDNS Enable, enter Your E-Mail Address and refer to an attached leaflet for DDNS service. • By enabling DDNS service viewnetcam.com, you can create a personalized web address (for example, bob.viewnetcam.com) at which your camera's live video can always be found on the Internet. The E-Mail address you entered will be automatically informed to viewnetcam.com for managing and supporting your account, improving services, and for marketing and promotional purposes. • Refer to unavailable character set 2 in page 96 for the e-mail address.
<p>Max. Bandwidth Usage</p>	<ul style="list-style-type: none"> • It can restrict the transmit bandwidth. • Select the max bandwidth usage from 0.1 Mbit/s to Unlimited Mbit/s. • Refer to the next File size of the image.

*_a If you automatically get the address from DHCP server, you do not need to set up.

File size of the image

The internal memory, image resolution, image quality and object situation determine the maximum number of frames. File sizes change depending on the image quality and object situation. (Brightness, etc.)

For example, the image size per frame in the image resolution is as follows. (When the image quality is Standard)

160 x 120: about 2.7 Kbytes (22 Kbits)

320 x 240: about 10 Kbytes (80 Kbits)

640 x 480: about 18 Kbytes (144 Kbits)

3.5.3 Name/Time

Name/Time window is used to assign a name to each Network Camera. Date and Time entered on Name/Time window are used for the Alarm/Timer mode in the Image Transfer feature and on the Buffered Image screen. NTP automatically adjusts the internal clock of Network Camera.

1. Click **[Name/Time]** on Setup Page.

2. Enter the Camera Name and Date and Time. Click **[Save]** when finished.
 - Click **[Cancel]** to quit the current settings. The window returns to Setup Page without saving the parameters.

Instructions for the data fields

<p>Camera Name</p>	<p>The Camera Name appears on the Single Camera screen.</p> <ul style="list-style-type: none"> • Refer to unavailable character set 1 on page 96. • Refer to displayable character set on page 97.
<p>Date and Time</p>	<p>First click [AM/PM] or [24H]. The display changes in each time mode.</p> <p>Note Time setting will be affected by the temperature. Time setting may lose one minute per month in 25 °C (77 °F) condition. Use Auto Adjustment feature.</p>

Instructions for the data fields

Date and Time	<ul style="list-style-type: none"> • Time stamp on the Buffered Image screen can be changed [AM/PM] or [24H]. • Only 24 h time mode is used in the Alarm/Timer mode in the Image Transfer feature.
Auto Adjustment	<p>NTP (Network Time Protocol) Server synchronizes Network Camera internal clock. It adjusts automatically everyday. Check the box to enable NTP.</p> <ul style="list-style-type: none"> • NTP Server Address or Host Name Ask your ISP or the network administrator for the NTP Server. • Select your Time Zone. <p>Note Daylight-saving Time (Daylight Time) is not set automatically. Select it manually.</p>

Time Zone

GMT-10:00 Hawaii
 GMT-09:00 Alaska, Hawaii Daylight Time
 GMT-08:00 Pacific Time, Alaska Daylight Time
 GMT-07:00 Mountain Time, Pacific Daylight Time
 GMT-06:00 Central Time, Mountain Daylight Time
 GMT-05:00 Eastern Time, Central Daylight Time (**default**)
 GMT-04:00 Eastern Daylight Time
 GMT 00:00 Western Europe Time
 GMT+01:00 Central Europe Time, Middle Europe Time
 GMT+02:00 Eastern Europe Time, Middle Europe Daylight Time
 GMT+03:00 Baghdad
 GMT+08:00 China Time, Western Australia Time
 GMT+09:00 Japan Time
 GMT+09:30 Central Australia Time
 GMT+10:00 Eastern Australia Time
 GMT+10:30 Central Australia Daylight Time
 GMT+11:00 Eastern Australia Daylight Time

3.5.4 Security: Administrator

Security: Administrator window allows the administrator to limit or exclude access to the selected Network Camera. Individual levels of access can be defined for multiple users.

Notes

- If Network Camera is to be accessed via the Internet, use authentication window for security. It will prevent any unauthorized person from changing your Network Camera parameters.
- Refer to page 61 for details about authentication security.

1. Click [**Security: Administrator**] on Setup Page.

Security: Administrator

1. Authentication Enable

You should set up the Authentication Page for security.

None (Anyone can access all pages.)

Administrator Only (for Setup Page)

Administrator (for Setup Page) and General User (for Top Page)

2. Administrator Authentication

ID (4 to 15 Characters)

Password (4 to 15 Characters)

Retype Password

2. Enter each parameter in the proper data field. Click [**Save**] when finished.
 - Click [**Cancel**] to leave the current settings unchanged. The window returns to Setup Page without saving the parameters.
 - Restart to make **Security: Administrator window** settings effective to all Motion JPEG viewers.

Instructions for the data fields

<p>Authentication Enable</p>	<p>Authentication window can be set in the three patterns.</p> <p>None: No authentication window appears. Anyone can access all screens (Single Camera/Multi-Camera screen) and pages (Top Page and Setup Page).</p> <p>Administrator only: Authentication window appears when accessing Setup Page. Authentication window does not appear when accessing Top Page.</p> <table border="1" data-bbox="370 464 955 540"> <thead> <tr> <th></th> <th>Administrator</th> <th>General User</th> <th>Unregistered User</th> </tr> </thead> <tbody> <tr> <td>Top page</td> <td>✓</td> <td>✓</td> <td>✓</td> </tr> <tr> <td>Setup page</td> <td>✓</td> <td>—</td> <td>—</td> </tr> </tbody> </table> <p>✓ : Accessible — : Not accessible</p> <p>Administrator and General User: Authentication window appears when accessing Setup Page for the administrator and Top Page for the general user.</p> <table border="1" data-bbox="370 688 955 764"> <thead> <tr> <th></th> <th>Administrator</th> <th>General User</th> <th>Unregistered User</th> </tr> </thead> <tbody> <tr> <td>Top page</td> <td>✓</td> <td>✓</td> <td>—</td> </tr> <tr> <td>Setup page</td> <td>✓</td> <td>—</td> <td>—</td> </tr> </tbody> </table> <p>✓ : Accessible — : Not accessible</p>		Administrator	General User	Unregistered User	Top page	✓	✓	✓	Setup page	✓	—	—		Administrator	General User	Unregistered User	Top page	✓	✓	—	Setup page	✓	—	—
	Administrator	General User	Unregistered User																						
Top page	✓	✓	✓																						
Setup page	✓	—	—																						
	Administrator	General User	Unregistered User																						
Top page	✓	✓	—																						
Setup page	✓	—	—																						
<p>Administrator Authentication for Setup Page</p>	<p>ID: Enter the administrator ID. ID and Password are case sensitive.</p> <p>Password: Enter the administrator password. The password should be difficult to guess and confidential. Refer to unavailable character set 1 on page 96.</p> <p>Note Assign the ID and password to meet your specific security requirements. To maximize its effectiveness, keep the following contents.</p> <ul style="list-style-type: none"> • Be sure the ID and password are different. • Make the ID and password as long and random as possible. • Periodically change the password. <p>Retype: Reenter the password to confirm. Do not copy the text.</p>																								

3.5.5 Security: General User

Security: General User window allows the administrator to create the general user ID and password for the security level defined as general user. Up to 30 individual user names can be defined. The various security levels are explained on page 61.

1. Click [**Security: General User**] on Setup Page.

Security: General User

General User Authentication

(1) User ID List (30 Users MAX)

* Registered User *

Delete

Modify

(2) New User

ID (4 to 15 Characters)

Password (4 to 15 Characters)

Retype Password

Save Cancel

2. Enter each parameter in the proper data field. Click [**Save**] when finished.
 - Click [**Cancel**] to leave the current settings unchanged. The window returns to Setup Page without saving the parameters.
 - Restart to make **Security: General User window** settings effective to all Motion JPEG viewers.

Instructions for the data fields

General User Authentication	The General User can be up to 30. Each of them can have their own ID and password.
(1) User ID List	<ul style="list-style-type: none"> • User ID List displays the registered user name. • [Delete] and [Modify] deletes/modifies the general user in the list. Select the desired user and click [Delete] or [Modify].
(2) New User	<p>Enter the general user ID, password and reenter the password to confirm. The password should be difficult to guess and confidential. [Save] registers the new user in the User ID List. ID and Password are case sensitive. Refer to unavailable character set 1 on page 96.</p> <p>Note</p> <p>Assign the ID and password to meet your specific security requirements. To maximize its effectiveness, keep the following contents.</p> <ul style="list-style-type: none"> • Be sure the ID and password are different. • Make the ID and password as long and random as possible. • Periodically change the password.

3.5.6 Top View Image

Top View Image Setting window can change settings for Top Page, Single Camera and Multi-Camera screen such as the initial language, the image resolution, image quality, refresh interval as the initial setting, **Limit time of Continuous Motion JPEG** and **On the Air time**.

1. Click **[Top View Image]** on Setup Page.

2. Select the each parameter. Click **[Save]** when finished.

- Click **[Cancel]** to quit the current settings. The window returns to Setup Page without saving the parameters.
- Restart to make **Limit Time of Continuous Motion JPEG** settings effective to all Motion JPEG viewers.

Instructions for the data fields

<p>Language</p>	<p>Select the initial language from the list: English (US), English (UK), French, German, Italian, Spanish or Japanese. The selected language is displayed as the initial language on Top Page, Single Camera screen and Multi-Camera screen. All Setup windows are also changed when selecting English (US), English (UK) or Japanese. English (UK) is displayed on Setup windows when selecting French, German, Italian or Spanish.</p>
------------------------	---

Instructions for the data fields

Top Page	<ul style="list-style-type: none"> • Top Page title can be changed. Enter the new title. <ul style="list-style-type: none"> • Refer to unavailable character set 1 on page 96 but [space] is available. • Refer to displayable character set on page 97. • Network Camera picture on Top Page can be changed. Enter the URL (http://) to display the picture on the specified web site. <ul style="list-style-type: none"> • Only [space] and [""] are unavailable in the ASCII character table on page 96. • Network Camera picture on Top Page can be set the link to the specified web site. Enter the URL (http://). <ul style="list-style-type: none"> • Only [space] and [""] are unavailable in the ASCII character table on page 96.
Image Resolution	<ul style="list-style-type: none"> • 640 x 480 (cannot set on the Multi-Camera screen.) • 320 x 240 (default) • 160 x 120
Image Quality	<ul style="list-style-type: none"> • Favor Clarity: Image is optimized for good clarity. • Standard: Image quality is standard. (default) • Favor Motion: Image is optimized for enhanced motion display.
Refresh Interval	<p>The refresh interval of JPEG - Regularly Refresh can be selected. Select the desired interval.</p> <ul style="list-style-type: none"> • 10 seconds to 5 minutes
Limit time of Continuous Motion JPEG	<p>To make the network traffic smooth, select the duration time to display Motion JPEG. When the timer expires, the image changes to JPEG - Regularly Refresh.</p> <ul style="list-style-type: none"> • 10 seconds to Unlimited
On the Air time	<p>Specifies the timetable to allow users to access Top View Image screen. When you access the image except the specified time, blue screen appears.</p> <ul style="list-style-type: none"> • Always: Always allows users to access. • Operational between: Specifies the date and time to access the image.

3.5.7 Image Transfer

Image Transfer window can set the Image Transfer feature. Network Camera can buffer images and send the images via e-mail or FTP. The request to send the image is initiated by a contact closure from the external sensors/devices connected to the External I/O using the Alarm mode. The external sensors/devices are customer provided. The images can also be sent in the interval of time using the Timer mode. Make sure Date and Time has been configured. Refer to page 58 about Date and Time.

Note

When you use FTP or e-mail in transferring the image, you need to set Default Gateway and DNS Server address.

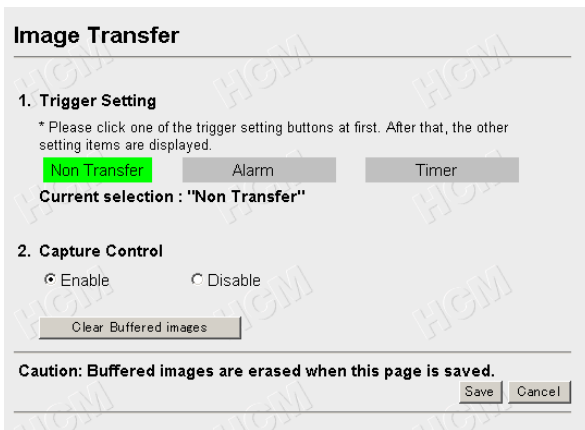

Non Transfer : Image Transfer feature is not in use.

Alarm mode : The alarm trigger activates transferring the image. Refer to page 68.

Timer mode : The timer trigger activates transferring the image. Refer to page 74.

Note

The Alarm and Timer mode cannot be set at the same time.

Non Transfer mode

Non Transfer mode enables **[Start Capture]** on the operation bar to buffer the image on the Single Camera screen. Refer to page 46. Capture Control can lock **[Start Capture]** on the operation bar to prevent the user from capturing the Buffered Image. Click **[Clear Buffered images]** to clear the buffered image. **[Clear Buffered images]** does not save the parameters.

1. Click **[Image Transfer]** on Setup Page.

Image Transfer

1. Trigger Setting
 * Please click one of the trigger setting buttons at first. After that, the other setting items are displayed.

Current selection : "Non Transfer"

2. Capture Control

Enable Disable

Caution: Buffered images are erased when this page is saved.

2. Select the each parameter. Click **[Save]** when finished.
 - Click **[Cancel]** to quit the current settings. The window returns to Setup Page without saving the parameters.

Transfer in the Alarm Mode

The Alarm mode can transfer an image via e-mail or FTP when the alarm trigger is active. To activate the alarm trigger, the External Sensor Input of External I/O must be connected with the external sensors/devices. The Alarm mode can send the e-mail without transferring the image. The Alarm mode uses the Network Camera internal clock. Make sure Date and Time has been configured. Refer to page 58 about Date and Time.

1. Click **[Alarm]** on **Image Transfer** window.

Image Transfer

1. Trigger Setting

* Please click one of the trigger setting buttons at first. After that, the other setting items are displayed.

a. Current selection: "Alarm"

b. **2. Active Time of Trigger**

(1) Primary Time

Always

Operational between

Start: h min s

Stop: h min s

Sun Mon Tue Wed Thu Fri Sat

Alarm enable condition

c. (2) Secondary Time Enable

* Secondary Time is only active outside of the time period established for Primary Time.

Alarm enable condition

d. **3. Image Setting**

(1) Image Resolution

(2) Image Quality

4. Image Buffer Frequency Setting

e. (1) Pre-alarm Image Buffer Enable

f. Image Frequency Images per

Maximum number of images per each trigger

(2) Post-alarm Image Buffer Enable

Image Frequency Images per

Maximum number of images per each trigger

Instructions for the data fields

- a.** External Sensor Input of External I/O activates the alarm trigger. Refer to page 94.
- b. Active Time of Trigger**
The active trigger time can be set in the primary time and the secondary time. The secondary time is the supplement of the primary time.
Always: always activates the alarm trigger.
Operational between: Sets the start and stop time of the primary time. The day of the week can be set by checking. Start and stop time is set only in 24 h time mode.
Alarm enable condition:
Select the [Rising] (GND to Open High) or [Falling] (Open High to GND) of External Sensor Input of the External I/O.
- c. Secondary time** is active trigger time except the primary time.
Alarm enable condition:
Select the [Rising] (GND to Open High) or [Falling] (Open High to GND) of External Sensor Input of the External I/O.
- d.** Sets the **image resolution** and **image quality**.
Image resolution: 640 x 480/320 x 240/160 x 120
Image quality: Favor Clarity/Standard/Favor Motion
- e.** The Pre or Post trigger or both can be set on the Buffered Image. Check the box.
- f. Image Frequency:** Sets the interval to send the image.
Maximum number of images per each trigger:
Selects the number of buffering frames from numbers 1 to 400.

a. — 5. Transfer Method

Non Transfer without Memory Over Write
 Non Transfer with Memory Over Write
 FTP

Server Address or Host Name
 Port No. (Usually Use 21)
 Login ID (0 to 63 Characters)
 Password (0 to 63 Characters)
 Login timing
 Upload File Name
 Over write setting
 Data transfer method

b. — Mail

SMTP Server Address or Host Name
 POP3 Server Address or Host Name
 Login ID (0 to 63 Characters)
 Password (0 to 63 Characters)
 From (Reply)
 To
 Subject
 Text

c. — 6. Notification to be sent when Alarm occurs

No Message
 Mail

SMTP Server Address or Host Name
 POP3 Server Address or Host Name
 Login ID (0 to 63 Characters)
 Password (0 to 63 Characters)
 From (Reply)
 To
 Subject
 Text

Clear Buffered images

Caution: Buffered images are erased when this page is saved.

Save Cancel

a. Selects Transfer Method.

Non Transfer without Memory Over Write:

Image buffering will stop when the internal memory is full.

Non Transfer with Memory Over Write:

Buffered image will overwrite the older image data when the internal memory is full.

FTP: Enters the server address*¹ or Host Name*², Port Number (1—65535), Login ID*² and password*² to access the FTP server and upload file name*² including full path. Time in 24 h mode is attached on the upload file name.

Login timing:

[Every Time] or [One Time] can be selected. When selecting [Every Time], Network Camera repeats logging in and out with each transfer of one image. When selecting [One Time], Network Camera stays logged in until the transfer of all images is completed. Select [One Time] when transferring many images in short duration time.

Over write setting:

Selects [Over Write...] to overwrite the transferred image or [Add time...] to save each transferred image.

Data transfer method:

Use [Passive Mode] normally. If FTP does not work properly, ask your ISP or network administrator about the transferring mode of FTP server. [Passive Mode] or [Active Mode] is available.

- b. Mail:** Sets the SMTP and POP3 server address*¹ or Host Name*², Login ID*² and Password*².
 From (Reply)*³: Enter the e-mail address of [Reply-to]. [To] can be the same address as From (Reply).
 To *³: Enter the e-mail address of receiver.
 Subject & Text *⁴: Sets the subject and text of the e-mail.
 Time in 24 h mode is attached on the subject.

Notes

- Set POP3 server address or Host Name, Login ID and Password if you need POP authentication to send the e-mail. Ask your ISP or administrator.
- Network Camera will only operate correctly with SMTP (Simple Mail Transfer Protocol) server. It is not available with Internet-accessed mail servers like "Hotmail®" or other mail accounts accessed via web browser.

- c.** Select [No Message] or [Mail]

Mail: Only the notification e-mail is sent when the alarm trigger is active. Refer to **b. Mail** for each parameter.

*¹ Refer to IP addressing on page 96.

*² Refer to unavailable character set 1 on page 96.

*³ Refer to unavailable character set 2 on page 96.

*⁴ Only ["] is unavailable in the ASCII character table on page 96 and refer to displayable character set on page 97.

- 2.** Select/Enter the each parameter. Click [**Save**] when finished.

- Click [**Cancel**] to quit the current settings. The window returns to Setup Page without saving the parameters.
- Click [**Clear Buffered images**] to clear the buffered image. [**Clear Buffered images**] does not save the parameters.

Setting Example

2. Active Time of Trigger

(1) Primary Time
 Always
 Operational between
 Start: h min s
 Stop: h min s
 Sun Mon Tue Wed Thu Fri Sat
 Alarm enable condition

a. —————

(2) Secondary Time Enable
 * Secondary Time is only active outside of the time period established for Primary Time.
 Alarm enable condition

b. —————

3. Image Setting

(1) Image Resolution
 (2) Image Quality

c. —————

4. Image Buffer Frequency Setting

(1) Pre-alarm Image Buffer Enable
 Image Frequency Images per
 Maximum number of images per each trigger

(2) Post-alarm Image Buffer Enable
 Image Frequency Images per
 Maximum number of images per each trigger

d. —————

5. Transfer Method

Non Transfer without Memory Over Write
 Non Transfer with Memory Over Write
 FTP

Server Address or Host Name
 Port No. (Usually Use 21)
 Login ID (0 to 63 Characters)
 Password (0 to 63 Characters)
 Login timing
 Upload File Name
 Over write setting
 Data transfer method

e. —————

Mail

SMTP Server Address or Host Name
 POP3 Server Address or Host Name
 Login ID (0 to 63 Characters)
 Password (0 to 63 Characters)
 From (Reply)
 To
 Subject
 Text

6. Notification to be sent when Alarm occurs

No Message
 Mail

SMTP Server Address or Host Name
 POP3 Server Address or Host Name
 Login ID (0 to 63 Characters)
 Password (0 to 63 Characters)
 From (Reply)
 To
 Subject
 Text

Setting explanation

- a.** The active time of trigger is set between 9:00 AM to 6:00 PM from Monday to Friday.
When the alarm occurs in the setting time, the images are transferred to FTP server, and the notification is sent to the specified user via e-mail.
The alarm trigger is on when the sensor signal is changed to the [Rising] (GND to Open High) of External Sensor Input of External I/O.
- b.** The secondary time is set inactive.
- c.** The transferring image size is 160 x 120, and the image quality is standard.
- d.** Enables the Pre-alarm and Post-alarm Image Buffering:
Network Camera will transfer Pre-alarm 10 images by one image per minute and Post-alarm 20 images by one image per second when detecting the alarm trigger.
- e.** Setting of FTP server:
IP Address — 192.168.0.20
Port No. — 21
Login ID — Panasonic
Password — *****
Login timing: Every Time
Upload File name — NetworkCamera
File name and time stamp is named to the file.
(Example: NetworkCamera20030101093000000.jpg)
Underlined numbers are "9 h 30 min 00 s 000 ms on January 1, 2003".
Data transfer method — Passive Mode
- f.** SMTP server address — xxx.xxx.com
POP3 server address — xxx.xxx.com
Login ID — Panasonic
Password — *****
Mail is sent to "NetworkCamera@xxx.xxx.com" from "Panasonic@xxx.xxx.com".
Subject is [Mail Transfer].
Text is [Alarm was generated].

Transfer in the Timer Mode

The timer mode can be activated by entering the active time, the image setting, frequency setting and the transfer method on **Image Transfer window**. Buffered Image can also be transferred via e-mail or FTP. The timer mode uses the Network Camera internal clock. Make sure Date and Time has been configured. Refer to page 58 about Date and Time.

1. Click **[Timer]** on Image Transfer window.

Image Transfer

1. Trigger Setting
 * Please click one of the trigger setting buttons at first. After that, the other setting items are displayed.

a. — **Current selection: "Timer"**

b. — **2. Active Time of Trigger**

(1) Primary Time

Always
 Operational between

Start: h min s
 Stop: h min s
 Sun Mon Tue Wed Thu Fri Sat

c. — (2) Secondary Time Enable
 * Secondary Time is only active outside of the time period established for Primary Time.

3. Image Setting

d. — (1) Image Resolution
 (2) Image Quality

4. Image Buffer Frequency Setting

e. — (1) Primary Image Buffer Frequency
 Images per
 (2) Secondary Image Buffer Frequency
 Images per

Instructions for the data fields

a. Buffers or transfers by the timer trigger.

b. Active Time of Trigger

Always: always activates the timer trigger. The timer trigger interval can be set in **e. Image Buffer Frequency Setting**.

Operational between: Sets the start and stop time of the primary time. The day of the week can be set by checking. If the setting time passes over midnight, check the check box of only the day of start time. Start and stop time is set only in 24 h time mode.

Note

The first image is buffered or transferred at the start time. The later images are buffered or transferred at the interval of the **e. Image Buffer Frequency Setting**.

c. Secondary time is active except the primary time.

The timer trigger interval in the secondary time can be set in **e. Image Buffer Frequency Setting**.

d. Sets the **image resolution** and **image quality**.

Image resolution: 640 x 480/320 x 240/160 x 120

Image quality: Favor Clarity/Standard/Favor Motion

e. Image Frequency: Sets the interval to send the image.

Note

Short interval of Image Buffer Frequency makes Network Camera transfer the older images. Set the interval long enough to transfer the images. Buffered Image screen enables you to check this setting.

a. — 5. Transfer Method

Non Transfer without Memory Over Write
 Non Transfer with Memory Over Write
 FTP

Server Address or Host Name
 Port No. (Usually Use 21)
 Login ID (0 to 63 Characters)
 Password (0 to 63 Characters)
 Login timing
 Upload File Name
 Over write setting
 Data transfer method

b. — Mail

SMTP Server Address or Host Name
 POP3 Server Address or Host Name
 Login ID (0 to 63 Characters)
 Password (0 to 63 Characters)
 From (Reply)
 To
 Subject
 Text

Caution: Buffered images are erased when this page is saved.

a. Selects Transfer Method.

Non Transfer without Memory Over Write:

Image buffering will stop when the internal memory is full.

Non Transfer with Memory Over Write:

Buffered image will overwrite the older image data when the internal memory is full.

[Primary] or **[Secondary]** on the operation bar can be displayed to view the Buffered Image screen in Non Transfer setting.

FTP: Enters the server address*¹ or Host Name*², Port Number (1—65535), Login ID*² and password*² to access the FTP server and upload file name*² including full path. Time in 24 h mode is attached on the upload file name.

Login timing:

[Every Time] or [One Time] can be selected. When selecting [Every Time], Network Camera repeats logging in and out with each transfer of one image. When selecting [One Time], Network Camera stays logged in until the transfer of all images is completed. Select [One Time] when transferring many images in short duration time.

Over write setting:

Selects [Over Write...] to overwrite the transferred image or [Add time...] to save each transferred image.

Data transfer method:

Use [Passive Mode] normally. If FTP does not work properly, ask your ISP or network administrator about the transferring mode of FTP server. [Passive Mode] or [Active Mode] is available.

- b. Mail:** Sets the SMTP and POP3 server address*¹ or Host Name*², Login ID*² and Password*².
 From (Reply)*³: Enter the e-mail address of [Reply-to]. [To] can be the same address as From (Reply).
 To *³: Enter the e-mail address of receiver.
 Subject & Text *⁴: Sets the subject and text of the e-mail.
 Time in 24 h mode is attached on the subject.

Notes

- Set POP3 server address or Host Name, Login ID and Password if you need POP authentication to send the e-mail. Ask your ISP or administrator.
- Network Camera will only operate correctly with SMTP (Simple Mail Transfer Protocol) server. It is not available with the Internet accessed mail server like "Hotmail" or others accessed via the web browser.

*¹ Refer to IP addressing on page 96.

*² Refer to unavailable character set 1 on page 96.

*³ Refer to unavailable character set 2 on page 96.

*⁴ Only ["] is unavailable in the ASCII character table on page 96 and refer to displayable character set on page 97.

2. Select/Enter the each parameter. Click [**Save**] when finished.

- Click [**Cancel**] to quit the current settings. The window returns to Setup Page without saving the parameters.
- Click [**Clear Buffered images**] to clear the buffered image. [**Clear Buffered images**] does not save the parameters.

Note

Refer to page 46 for the Buffered Image.

3.5.8 Camera Setup

Camera Setup window sets White Balance and Power Line Frequency. You can lock the Brightness, Pan/Tilt/Preset and Preset Program Control features. You can also select the Pan Range and Tilt Range.

1. Click **[Camera Setup]** on Setup Page.

Camera Setup

1. **White Balance**

2. **Power Line Frequency (for Fluorescent light)**
 60Hz 50Hz

3. **Brightness Control**
 Enable Disable

4. **Pan / Tilt / Preset Control**
 Enable Disable

5. **Preset Program Control**
 Enable Disable

6. **Pan Range**
 Minimum degree - Home Position degree - Maximum degree

7. **Tilt Range**
 Minimum degree - Home Position degree - Maximum degree

2. Select the each parameter in the proper data field. Click **[Save]** when finished.
- Click **[Cancel]** to quit the current settings. The window returns to Setup Page without saving the parameters.

Instructions for the data fields

White Balance	Auto (default)	—	Auto White Balance
	Fixed Indoor	—	Color Temperature: 2800K, Electric Bulb
	Fixed Fluorescent_1	—	Color Temperature: 3600K, Natural fluorescent light
	Fixed Fluorescent_2	—	Color Temperature: 4000K, Natural fluorescent light
	Fixed Outdoor	—	Color Temperature: 6000K, Solar light
	Hold	—	Holds the current White Balance

Instructions for the data fields

White Balance	<p>Notes</p> <ul style="list-style-type: none"> The wrong White Balance setting will cause Network Camera to display colors improperly. In most cases Auto is suggested. White Balance is also registered in preset programming.
Power Line Frequency	<p>It can select Flicker Correction by power line frequency.</p> <ul style="list-style-type: none"> 60 Hz (default) 50 Hz <p>Select 60 Hz in the United States.</p>
Brightness Control	<p>Brightness Control can be locked.</p> <p>Locked appears on the operation bar on page 42 when clicking.</p>
Pan/Tilt/Preset Control	<p>Pan/Tilt/Preset Control can be locked. Pan/Tilt/Preset Control also disables Click to Center operation.</p> <p>Locked appears on the operation bar on page 42 when clicking.</p>
Preset Program Control	<p>Preset Program Control can be locked.</p> <p>Program button disappears on the operation bar on page 42.</p>
Pan Range	<p>Pan Range can be selected. Refer to page 80 on specifying the Pan/Tilt range.</p> <p>Right/Left End appears on the operation bar on page 42 when having reached the selected end.</p>
Tilt Range	<p>Tilt Range can be selected. Refer to page 80 on specifying the Pan/Tilt range.</p> <p>Up/Down End appears on the operation bar on page 42 when having reached the selected end.</p>

Specifying the Pan/Tilt range

1. Start up the web browser and access the Single Camera screen.
2. Start up another web browser and access Camera Setup window.
3. Align the Single Camera screen and Camera Setup window from side to side.

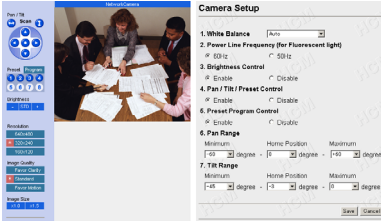

4. Adjust the Pan operation on the Single Camera screen and select **[Current]** in the minimum value data field of the Pan range on Camera Setup window. The data field refreshes to read the current value of the Pan range.
5. Specify the each home position/maximum value of the Pan range and each minimum/home position/maximum value of the Tilt range following the instruction shown in the step 4.

Note

Minimum value must be lower than maximum value. Home position value must be in the range between minimum and maximum values.

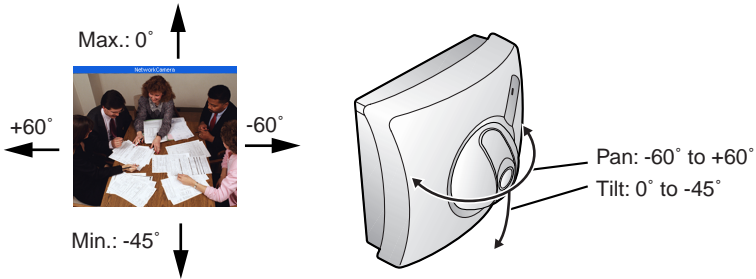

6. Click **[Save]** when finished.

3.5.9 Multi-Camera

Multi-Camera window enables the setting of Multi-Camera screen. Camera Name and IP address of each Network Camera must be entered to view the Multi-Camera screen. Registering IP addresses of the other Network Camera enables you to view on the Multi-Camera screen. Clicking Camera Name of Network Camera on the Multi-Camera screen accesses the Single Camera screen to control the image. First Network Camera is named on **Name/Time window** on page 58. 2nd to 4th Network Cameras are named on this **Multi-Camera window**.

Notes

- When using the Multi-Camera screen, all additional Network Cameras must be defined on each Multi-Camera window. This will allow all Network Cameras to be seen and selected from each Network Camera in the entire network.
- Global IP address is required to view the image over the Internet.

1. Click [Multi-Camera] on Setup Page.

Multi-Camera

Registration / Modification

1. 2nd Network Camera Enable

IP Address or Host Name

Camera Name (1 to 15 Characters)

2. 3rd Network Camera Enable

IP Address or Host Name

Camera Name (1 to 15 Characters)

3. 4th Network Camera Enable

IP Address or Host Name

Camera Name (1 to 15 Characters)

2. Select/Enter the each parameter. Click **[Save]** when finished.

- Click **[Cancel]** to quit the current settings. The window returns to Setup Page without saving the parameters.

Instructions for the data fields

Enable check box	The checked camera image can be seen on the Multi-Camera screen.
IP Address (or URL)*¹ or Host Name*²	Enter the desired IP address of Network Camera or Host Name and Port Number. (You do not need to enter port number 80 [default].)
Camera Name*³	Enter the desired Camera Name displayed only for the Multi-Camera screen.

*¹ Refer to IP addressing on page 96.

*² Refer to unavailable character set 1 on page 96 but [:] is available.

*³ Refer to unavailable character set 1 on page 96 and refer to displayable character set on page 97.

3.5.10 External Output Control

External Output Control window enables the External Device Control Output signal to activate the external sensors/devices. (Open or Short to GND) The network administrator should set up this setting.

Note

Refer to page 94 for Interfacing to the External I/O.

1. Click [**External Output Control**] on Setup Page.

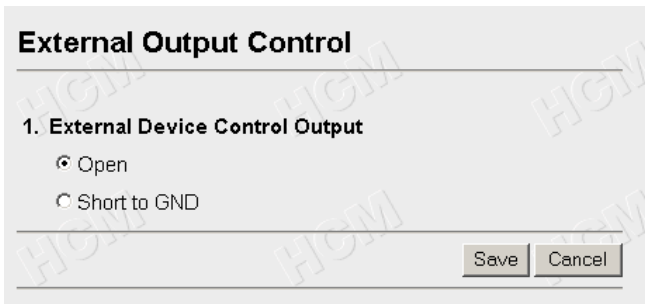

External Output Control

1. External Device Control Output

Open

Short to GND

Save Cancel

2. Check [**Open**] means the External Device Control Output becomes high impedance (open collector).
Check [**Short to GND**] means the External Device Control Output becomes low (0V).
3. Click [**Save**] to send the signal.
 - Click [**Cancel**] to quit the current settings. The window returns to Setup Page without saving the parameters.

3.5.11 Indicator Control

Indicator Control window allows you to select Power Indicator operation. Power Indicator operation has three patterns.

- Always on
- Turns on when accessing Network Camera
- Always off

Notes

- Power Indicator can be controlled in case the administrator does not want to draw attention to Network Camera. This may be desirable when used for security applications.
- Indicator Control window cannot control Ethernet Indicator on page 15.

1. Click **[Indicator Control]** on Setup Page.

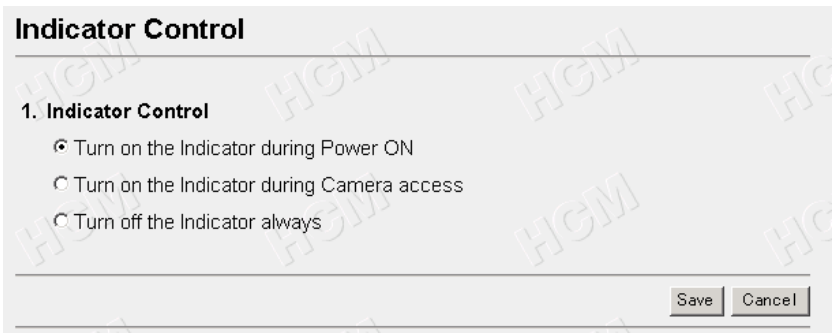

2. Select the Power Indicator on/off. Click **[Save]** when finished.

- Click **[Cancel]** to quit the current settings. The window returns to Setup Page without saving the parameters.

3.5.12 Status

Status displays general information about Network Camera.

1.Version	
Hardware	XXXXXXXXXXXX
Firmware(Boot)	*.*.*.*
Firmware(Application)	*.*.*.*

Note

When some trouble occurs, the information is useful.

3.5.13 Restart

Restart window restarts Network Camera with the parameters saved. Restarting is required when the network parameters are changed.

1. Click **[Restart]** on Setup Page.

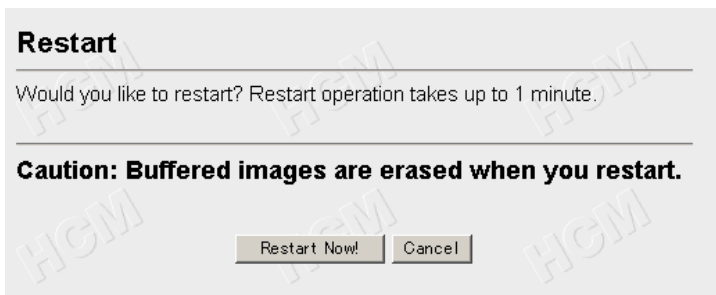

2. Click **[Restart Now!]**.
 - Click **[Cancel]** to quit. The window returns to Setup Page.

3.5.14 Update Firmware

Update Firmware window allows the user to install the latest version of the Network Camera internal operating system. In most cases, this will never be necessary. Changes may be necessary to accommodate new operating systems or new web browsers that are not shown on page 10. In those cases, Update Firmware would be available from the Network Camera Technical Support Site at <http://panasonic.co.jp/pcc/en/>. Check the current firmware version on Setup Page on page 50.

Notes

- Do not turn off the power during Update Firmware. If the operation of Update Firmware is stopped, refer to page 112.
 - Buffered Images are erased when performing Update Firmware.
1. Download the proper firmware from the Network Camera Technical Support Site mentioned above.
 2. If Network Camera is accessible from the Internet, temporarily disable access and connect Network Camera to the PC as the following figure. This will eliminate any interruption during the Update Firmware.

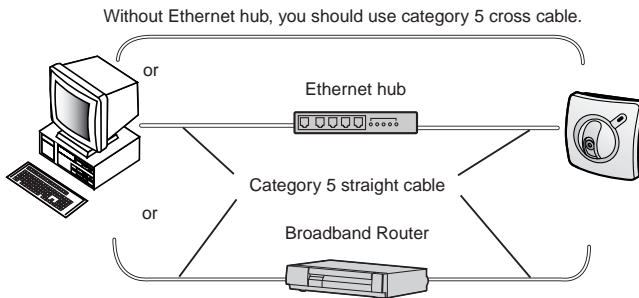

Note

When Network Camera uses the DHCP function, change the Internet connection from DHCP to Static in **Network window**. Refer to page 54 for the network parameters.

3. Access **Setup Page** by entering "[http://IP Address \(or URL\):Port No./config.html](http://IP Address (or URL):Port No./config.html)" on the web browser and press **[Enter]**.
 - When port number is 80 (default), you do not need to enter port number.

4. Click **[Update Firmware]** on Setup Page.

Update Firmware

With power applied to the camera, click on "Update Firmware" below. Depending on the speed of your system, the procedure can take up to 3 minutes.

Caution:

- (1) **Connect the camera with the local network during the update firmware process for security.**
- (2) **Buffered images are erased when you execute this page.**
- (3) **Never turn off the power during the update firmware process.**

5. Click **[Update Firmware]**.

Restarting now...

Restart operation takes up to 1 minute.

Please enter the proper IP address to URL when no response.

Wait about one minute.

Update Firmware

Please enter or browse the firmware file name for update.

File name

The update firmware process takes about 120 seconds via "File Upload", "Flash-ROM Writing", and "Restart", automatically.

Caution: Never turn off the power, during the update firmware process.

Note

If you click **[Update Firmware]**, operation cannot be canceled. If canceled, refer to page 112.

6. Click [**Browse...**] to select the firmware from the file selector.
 - A dialog box appears to choose the file.
7. Select a desired Firmware file (including the path information) and click [**Open**].
8. Make sure the desired firmware file name is selected correctly, and click [**Update Firmware**].

Proceeding the update firmware

Now Flash-ROM Writing...
Please wait about 100 seconds.

Caution: Never turn off the power, during the update firmware process.

Restarting window is displayed, and Network Camera restarts automatically.

Restarting now...

Restart operation takes up to 1 minute.

Please enter the proper IP address to URL when no response.

Restart operation takes about one minute.

Confirm that the Update Firmware Version number is the latest number on Setup Page.

3.5.15 Reset to Factory Default

Reset to Factory Default window initializes all the parameters including the ID, Password, IP address and Subnet Mask except Date and Time setting to the factory default. Reconfirm the settings before doing the Reset to Factory Default operation.

1. Click [**Reset to Factory Default**] on Setup Page.

Reset to Factory Default

Would you like to reset to Factory Default? Reset to Factory Default operation takes up to 1 minute.

Caution:

- (1) Buffered images are erased when you execute this page.
- (2) Never turn off the power during the Reset to Factory Default.
- (3) Please refer to "Getting Started" to open this Network Camera after execute this page. Because setting condition will be changed.

Especially,

IP Address : Change to	192.168.0.253
Subnet Mask : Change to	255.255.255.0

2. Click [**Execute**].
 - Click [**Cancel**] to quit. The window returns to Setup Page.

Notes

- Do not turn off the power during the Reset to Factory Default. It may interrupt the Network Camera operation.
- IP address and Subnet Mask should be set again after Resetting to Factory Default.
- CLEAR SETTING button can also reset Network Camera to the Factory Default. Refer to page 100.
- Internal clock will not be reset, however, time mode will return to **AM/PM mode** and **Auto adjustment** will be disabled.
- If Reset to Factory Default is used, all user settings will be lost, and you will have to reconfigure the entire Network Camera.

Section 4

Technical Guides

4.1 Mounting

Four ways of mounting are shown in the following figures. Confirm the top and bottom of Network Camera when mounting.

Camera Stand Mounting

Fix Network Camera to the Camera Stand.

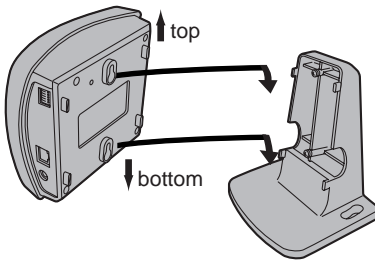

Tripod Mounting

Attach Network Camera to the tripod by using the tripod bolt.

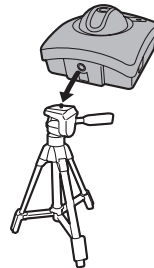

Wall Mounting

- a) Screw the two screws (accessories) into the wall. The distance of two screws should be 70 mm (2.75 inches).
- b) Fix Network Camera to the screws.

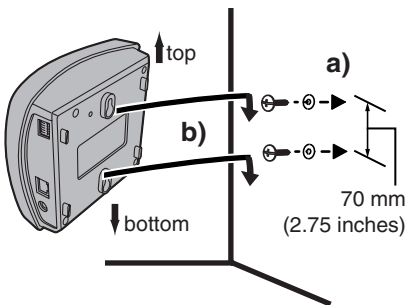

Ceiling Mounting

- a) Screw the two screws (accessories) into the ceiling. The distance of two screws should be 76 mm (2.99 inches).
- b) Fix Network Camera to the Camera Stand.
- c) Fix Camera Stand to the screws.

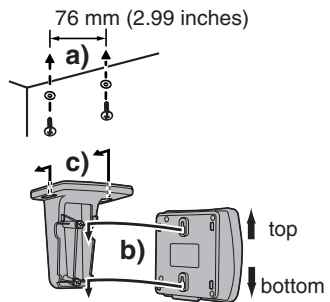

b), c): Fix the unit tightly by sliding it.

Notes

- Mounting and cabling instructions described in this Operating Instructions follow generally accepted guidelines suitable for residential installations. In some areas, commercial and industrial installations are regulated by local or state ordinances. For such installations, contact your local building department or building inspector for more details.
- Network Camera is intended for indoor use only. Prolonged exposure to direct sunlight or halogen light may damage the CMOS sensor.
- Make sure the Power Indicator is always in the upper right corner when you mount. The upside down mounting may cause Network Camera to slip off the Camera Stand and fall down.

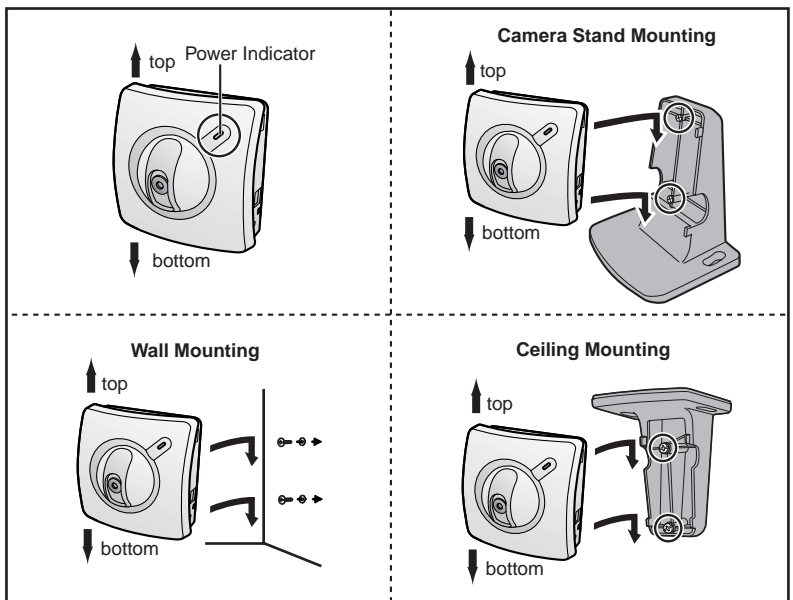

CAUTION

Drive mounting screws into the wall. Be careful to avoid touching any metalwork (metal/wire laths etc.), conduits or electrical cables buried in the wall.

4.2 Interfacing to the External I/O

The Alarm mode in the Image Transfer feature requires the external sensors/ devices to be connected to the External Sensor Input of the External I/O. Certain features of this Network Camera can be activated by an external sensor that senses physical changes in the area Network Camera is monitoring. These changes can include motion detection or a physical change in the monitored area. The external sensor can also be a door switch or an infrared motion detector. These devices are customer provided, and are available from dealers who carry surveillance and security products. Electrically, they must be able to provide a momentary contact closure.

Explanation of External I/O

Pin	Function
1	GND
2	DC Power Output Terminal <ul style="list-style-type: none"> • 8—12 V DC • Maximum of 50 mA load drive is possible.
3	External Sensor Input <ul style="list-style-type: none"> • External Sensor Input receives the signal produced by the alarm sensors, (e.g., door sensor, infrared ray sensor). Those signals can activate Image Transfer in the Alarm mode feature on page 68. • Use it by opening or GND short-circuit.
4	External Device Control Output <ul style="list-style-type: none"> • External Device Control Output sends the electric current to activate the external devices, (e.g., light, buzzer). • External Output Control window can set the External Device Control Output. Refer to page 83. • It is an open collector circuit, and the maximum drawing-in current is 50 mA. Prevent the maximum voltage from exceeding DC Power Output voltage of pin 2.

Circuit Diagram Example

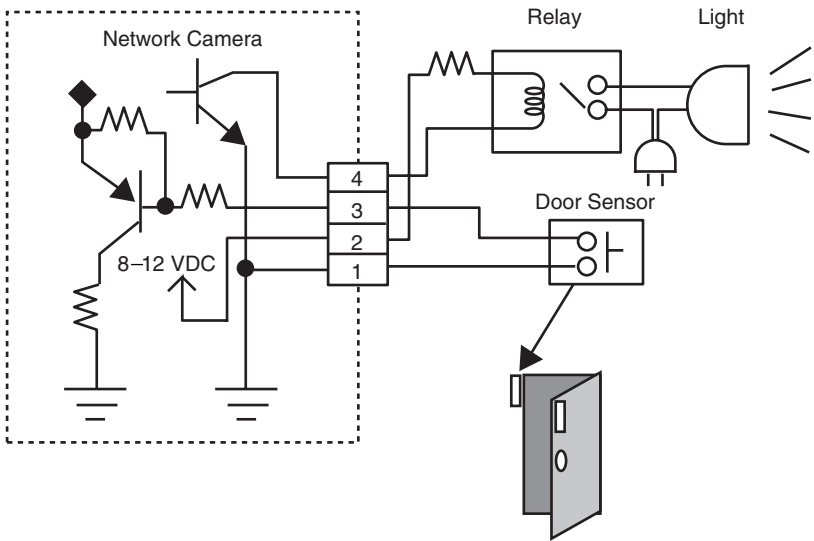

CAUTION

- THE EXTERNAL I/O IS NOT CAPABLE OF CONNECTING DIRECTLY TO DEVICES THAT REQUIRE LARGE AMOUNTS OF CURRENT. IN SOME CASES, A CUSTOM INTERFACE CIRCUIT (CUSTOMER PROVIDED) MAY HAVE TO BE USED. SERIOUS DAMAGE TO NETWORK CAMERA MAY RESULT IF A DEVICE IS CONNECTED TO THE EXTERNAL I/O THAT EXCEEDS ITS ELECTRICAL CAPABILITY.
- THE LOW VOLTAGE/CURRENT CIRCUITS AND HIGH VOLTAGE/CURRENT CIRCUITS ARE IN THE NETWORK CAMERA CIRCUIT. THE QUALIFIED ELECTRICIAN SHOULD DO THE WIRING NOT BY YOURSELF. INCORRECT WIRING COULD DAMAGE NETWORK CAMERA. YOU COULD RECEIVE THE FATAL ELECTRIC SHOCK.
- External I/O (Input/Output) are independent. Output terminal is controlled only by External Output Control window on page 83.

4.3 ASCII and ISO-8859-1 Character Table

The characters of the ASCII character table are available for use in the various setup windows.

IP addressing (Assignment of the IP address)

Address consists of one to four numbers (0—255). By far most common form is four decimal numbers, (e.g., 192.168.0.253).

("0.0.0.0" and "255.255.255.255" are not available.)

Unavailable character set 1

[Space], ["], ['], [#], [&], [%], [=], [+], [?], [<], [>] and [:] are not available.

Unavailable character set 2

[Space], ["], ['], [#], [&], [%], [=], [+], [?], [<], [>] and [:] are not available.

Character set is like [text] + [@] + [text] + [.] + [text].

(space)	0	@	P	`	p
!	1	A	Q	a	q
"	2	B	R	b	r
#	3	C	S	c	s
\$	4	D	T	d	t
%	5	E	U	e	u
&	6	F	V	f	v
'	7	G	W	g	w
(8	H	X	h	x
)	9	I	Y	i	y
*	:	J	Z	j	z
+	;	K	[k	{
,	<	L	\	l	
-	=	M]	m	}
.	>	N	^	n	~
/	?	O	_	o	

Displayable character set

Network Camera can display ISO-8859-1 character set for West European languages and the Shift-JIS character set for Japanese. Network Camera screen may display the unreadable characters if the operating system or the entered character set is different from the language selected on Top View Image Setting window.

ISO-8859-1 Character Table					
¡ ¢ £ ¤ ¥ ¦ § ¨ © ª « ¬ ® ¯	° ± ² ³ ´ µ ¶ · ¸ ¹ º » ¼ ½ ¾ ¿	À Á Â Ã Ä Å Æ Ç È É Ê Ë Ì Í Î Ï	Ð Ñ Ò Ó Ô Õ Ö × Ø Ù Ú Û Ü Ý Þ ß	à á â ã ä å æ ç è é ê ë ì í î ï	ð ñ ò ó ô õ ö ÷ ø ù ú û ü ý þ ÿ

4.4 Maintenance

To keep Network Camera functioning in good condition, maintenance plays an important part. Keep maintenance when using Network Camera. After removing dust from the Fixed Focus Lens, wipe the Fixed Focus Lens with lens cleaning paper.

Fixed Focus Lens

- Do not forcedly move the lens part around the Fixed Focus Lens. Touching it may damage the Pan/Tilt motor.
- Do not touch the Fixed Focus Lens. Touching it may leave a fingerprint and can cause the image to be out of focus, and may also remove the protective coating on the Fixed Focus Lens.
- Clean the Fixed Focus Lens with lens cleaning paper.

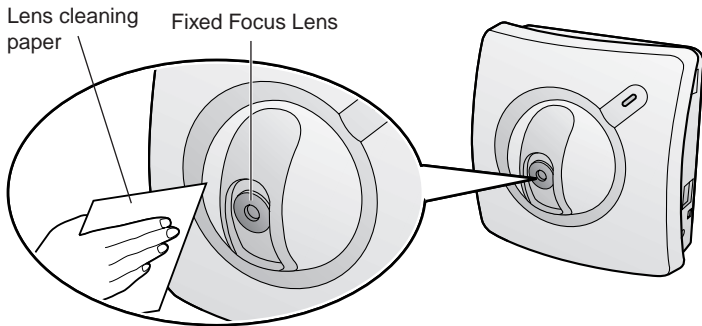

Section 5

Specifications and Troubleshooting

5.1 Network Camera Reset Procedure—Default Settings

If the user forgets settings or passwords, Network Camera can be easily reset to the default settings. The CLEAR SETTING button initializes all the parameters except Date and Time setting.

With power on, press the **CLEAR SETTING button** for about one second.

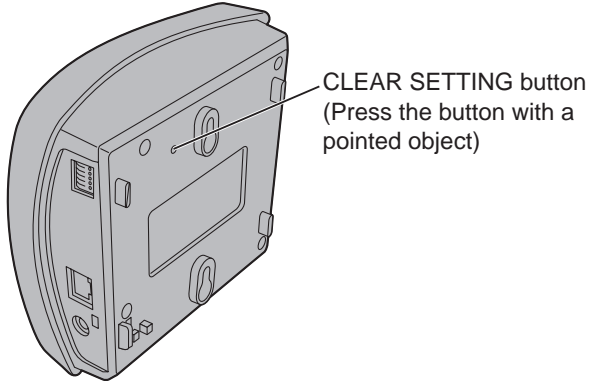

Note

When pressing the **CLEAR SETTING button**, all buffered images are cleared.

5.2 Default Settings List

No	Items	Factory Default value	Indispensable setting	Note	
1	Network	1. Network Configuration	Checked	-	-
		2. Port No.	80	-	1-65535
		Static : IP Address	192.168.0.253	If necessary	(*1)
		Static : Subnet Mask	255.255.255.0	If necessary	(*1)
		DHCP : Host Name	[Blank]	If necessary	(*3) 0 to 63 Characters
		3. Default Gateway	[Blank]	Required when using Gateway	(*1)
2	Name/Time	4. DNS Server1 & DNS server 2	[Blank]	Required when using DNS	(*1)
		5. DDNS	No check	-	-
		Your e-mail address	[Blank]	Required when using DDNS	(*4) 5 to 255 Characters
		6. Max Bandwidth usage (Mbps)	Unlimited	-	0.1, 0.2, 0.3, 0.5, 1.0, Unlimited
		1. Camera Name	NetworkCamera	-	(*3) and (*7) 1 to 15 Characters
		2. Date and Time (AM/PM, 24H)	AM/PM	-	-
3	Security: Administrator	2. Date and Time (Year/Month/Day/Hour/Minute)	No changing	-	-
		3. Auto Adjustment	No check	-	-
		NTP Server Address or Host Name	[Blank]	-	(*1) or (*3) 1 to 255 Characters
		Time Zone	GMT-05:00	-	-
		1. Authentication Enable	None	-	-
		2. ID	[Blank]	Required when setting Authentication	(*3) 4 to 15 Characters
4	Security: General User	Password	[Blank]	Required when setting Authentication	(*3) 4 to 15 Characters
		Retype Password	[Blank]	Required when setting Authentication	(*3) 4 to 15 Characters
		(1.) User ID List	No entry	-	-
		(2.) New User: ID	[Blank]	Required when setting General User	(*3) 4 to 15 Characters
5	Top View Image Setting	New User: Password	[Blank]	Required when setting General User	(*3) 4 to 15 Characters
		New User: Retype Password	[Blank]	Required when setting General User	(*3) 4 to 15 Characters
		1. Language	English (US)	-	French, German, Italian, Spanish, Japanese, etc.
		2. Top Page title	[Blank]	-	(*6) and (*7) 0 to 63 Characters
		Image URL	[Blank]	-	(*8) 0 to 127 Characters
	Link URL	[Blank]	-	(*8) 0 to 127 Characters	

No	Items	Factory Default value	Indispensable setting	Note
5	Top View Image Setting	3. Single Camera Image Resolution	320 x 240	160 x 120, 320 x 240, 640 x 480
		Image Quality	Standard	Favor Clarity, Standard, Favor Motion
		Refresh Interval	30 s	10, 15, 20, 25, 30, 45 s, 1, 2, 3, 5 min
		4. Multi-Camera Image Resolution	320 x 240	160 x 120, 320 x 240
		Image Quality	Standard	Favor Clarity, Standard, Favor Motion
		Refresh Interval	30 s	10, 15, 20, 25, 30, 45 s, 1, 2, 3, 5 min
		5. Limit time of Continuous Motion JPEG	Unlimited	10 s—Unlimited
		6. Always/Operational between Time 1—4	Always	-
		Day-of-the-week setting	0h 0min—0h 0min	-
		All checked	-	-
6	Image Transfer 1. Non transfer 1. Alarm	1. Trigger Setting	Non transfer	-
		2. Capture Control	Enable	-
		2. (1) Always/Operational between	Always	-
		Start time	00:00:00	-
		Stop time	23:59:59	-
		Day-of-the-week setting	All checked	-
		Alarm enable condition	Rising	-
		(2)Secondary Time	No check	-
		Alarm enable condition,	Rising	-
		3. (1) Image Resolution	320 x 240	160 x 120, 320 x 240, 640 x 480
		(2) Image Quality	Standard	Favor Clarity, Standard, Favor Motion
		4. (1)Pre-alarm Image Buffer	No check	-
		Image Frequency	1 Image/Hour	-
		Maximum number of image per each trigger	1	1—400
		(2)Post-alarm Image Buffer	Checked	-
		Image Frequency	1 Image/Hour	-
		Maximum number of image per each trigger	1	1—400

No	Items	Factory Default value	Indispensable setting	Note	
6	1. Alarm	5. Non Transfer without Memory Over Write	-	-	
		Non Transfer with Memory Over Write	-	-	
		FTP	Not-selected	-	-
		Server Address or Host Name	[Blank]	Required when using FTP	(*1) or (*3) 1 to 255 Characters
		Port No. (Usually Use 21)	21	Required when using FTP	1—65535
		Login ID	[Blank]	If necessary	(*3) 0 to 63 Characters
		Password	[Blank]	If necessary	(*3) 0 to 63 Characters
		Login timing	Every Time	-	Every Time, One Time
		Upload File Name	[Blank]	Required when using FTP	(*3) 1 to 234 Characters
		Over write setting	Over Write to Fixed Upload File Name	-	-
		Data transfer method	Passive Mode	-	Passive Mode, Active Mode
		Mail	Not-selected	-	-
		SMTP Server Address or Host Name	[Blank]	Required when using Mail	(*1) or (*3) 1 to 255 Characters
		POP3 Server Address or Host Name	[Blank]	Required when using POP authentication	(*1) or (*3) 1 to 255 Characters
		Login ID	[Blank]	Required when using POP authentication	(*3) 0 to 63 Characters
		Password	[Blank]	Required when using POP authentication	(*3) 0 to 63 Characters
		From (Reply)	[Blank]	Required when using Mail	(*4) 5 to 63 Characters
		To	[Blank]	Required when using Mail	(*4) 5 to 63 Characters
		Subject	[Blank]	-	(*2) and (*7) 0 to 44 Characters
		Text	[Blank]	-	(*2) and (*7) 0 to 63 Characters
6.	No Message	Selected	-	-	
		Not-selected	-	-	
		SMTP Server Address or Host Name	[Blank]	Required when using Mail	(*1) or (*3) 1 to 255 Characters
		POP3 Server Address or Host Name	[Blank]	Required when using POP authentication	(*1) or (*3) 1 to 255 Characters
		Login ID	[Blank]	Required when using POP authentication	(*3) 0 to 63 Characters
		Password	[Blank]	Required when using POP authentication	(*3) 0 to 63 Characters
		From (Reply)	[Blank]	Required when using Mail	(*4) 5 to 63 Characters
		To	[Blank]	Required when using Mail	(*4) 5 to 63 Characters
		Subject	[Blank]	-	(*2) and (*7) 0 to 63 Characters
		Text	[Blank]	-	(*2) and (*7) 0 to 63 Characters

No	Items	Factory Default value	Indispensable setting	Note
1. Timer	2. (1) Always/Operational between	Always	-	-
	Start time	00:00:00	-	-
	Stop time	23:59:59	-	-
	Day-of-the-week setting	All checked	-	-
	(2) Secondary Time	No check	-	-
	3. (1) Image Resolution	320 x 240	-	160 x 120, 320 x 240, 640 x 480
	(2) Image Quality	Standard	-	Favor Clarity, Standard, Favor Motion
	4. (1) Primary Image Buffer Frequency	1 Image/Hour	-	-
	(2) Secondary Image Buffer Frequency	1 Image/Hour	-	-
	5. Non Transfer without Memory Over Write	Selected	-	-
	Non Transfer with Memory Over Write	Not-selected	-	-
	FTP	Not-selected	-	-
	Server Address or Host Name	[Blank]	Required when using FTP	(*1) or (*3) 1 to 255 Characters
	Port No. (Usually Use 21)	21	Required when using FTP	1—65535
	Login ID	[Blank]	If necessary	(*3) 0 to 63 Characters
	Password	[Blank]	If necessary	(*3) 0 to 63 Characters
	Login timing	Every Time	-	Every Time, One Time
	Upload File Name	[Blank]	Required when using FTP	(*3) 1 to 234 Characters
	Over write setting	Over Write to Fixed Upload File Name	-	-
	Data transfer method	Passive Mode	-	Passive Mode, Active Mode
Mail	Not-selected	-	-	
SMTP Server Address or Host Name	[Blank]	Required when using Mail	(*1) or (*3) 1 to 255 Characters	
POP3 Server Address or Host Name	[Blank]	Required when using POP authentication	(*1) or (*3) 1 to 255 Characters	
Login ID	[Blank]	Required when using POP authentication	(*3) 0 to 63 Characters	
Password	[Blank]	Required when using POP authentication	(*3) 0 to 63 Characters	
From (Reply)	[Blank]	Required when using Mail	(*4) 5 to 63 Characters	
To	[Blank]	Required when using Mail	(*4) 5 to 63 Characters	
Subject	[Blank]	-	(*2) and (*7) 0 to 44 Characters	
Text	[Blank]	-	(*2) and (*7) 0 to 63 Characters	

No	Items	Factory Default value	Indispensable setting	Note	
7	Camera Setup	1. White Balance	Auto	Auto, Fixed (Indoor/Fluorescent_1/Fluorescent_2/Outdoor), Hold	
		2. Power Line Frequency	60 Hz	-	60 Hz, 50 Hz
		3. Brightness Control	Enable	-	-
		4. Pan/Tilt/Presets Control	Enable	-	-
		5. Preset Program Control	Enable	-	-
		6. Pan Range (Minimum) (Home Position)	-60 degree	-	-60 — +60 degree, current
		6. Pan Range (Maximum)	0 degree	-	-60 — +60 degree, current
8	Multi-Camera	7. Tilt Range (Minimum) (Home Position)	+60 degree	-	-60 — +60 degree, current
		7. Tilt Range (Maximum)	-45 degree	-	-45 — 0 degree, current
		1. 2nd Network Camera	-3 degree	-	-45 — 0 degree, current
		1. 2nd Network Camera	0 degree	-	-45 — 0 degree, current
		IP Address or Host Name	No check	-	-
		Camera Name	[Blank]	Required when using Multi-Camera	(*1) or (*5) 1 to 255 Characters
		Camera Name	[Blank]	Required when using Multi-Camera	(*3) and (*7) 1 to 15 Characters
9	External Output Control	2. 3rd Network Camera	No check	-	
		IP Address or Host Name	[Blank]	Required when using Multi-Camera	(*1) or (*5) 1 to 255 Characters
		Camera Name	[Blank]	Required when using Multi-Camera	(*3) and (*7) 1 to 15 Characters
		3. 4th Network Camera	No check	-	-
		IP Address or Host Name	[Blank]	Required when using Multi-Camera	(*1) or (*5) 1 to 255 Characters
		Camera Name	[Blank]	Required when using Multi-Camera	(*3) and (*7) 1 to 15 Characters
		1. Open/Short to GND	Open	-	-

No	Indicator Control	Items	Factory Default value	Indispensable setting	Note
10		1. Turn on the Indicator during Power ON 1. Turn on the Indicator during Camera access 1. Turn off the Indicator always	Selected Not-selected Not-selected	- - -	- - -
11	Update Firmware	File Name	[Blank]	Required when using Update Firmware	-
	Preset Buttons	① Preset Button	Upper Left	-	(*3) and (*7) 0 to 15 Characters
		② Preset Button	Upper Right	-	(*3) and (*7) 0 to 15 Characters
		③ Preset Button	Lower Left	-	(*3) and (*7) 0 to 15 Characters
		④ Preset Button	Lower Right	-	(*3) and (*7) 0 to 15 Characters

(*1): Address must be composed of four numeral characters (0 to 255) and divided with 3 dots, such as 192.168.0.253. (Cannot use "0.0.0.0" and "255.255.255.255")

(*2): Only [] is unavailable in the ASCII characters.

(*3): [Space], [], [#], [&], [%], [=], [+], [?], [<], [>], [<], [>] and [:] are not available in the ASCII characters.

(*4): [Space], [], [#], [&], [%], [=], [+], [?], [<], [>], [<], [>] and [:] are not available in the ASCII characters and the character set is like [text] + [@] + [text] + [] + [text]

(*5): [Space], [], [#], [&], [%], [=], [+], [?], [<], [>] and [:] are not available in the ASCII characters.

(*6): [], [#], [&], [%], [=], [+], [?], [<], [>] and [:] are not available in the ASCII characters.

(*7): ISO-8859-1 character set for West European language and Shift-JIS character set for Japanese are available.

(*8): Only [space] and [] are unavailable in the ASCII characters.

5.3 Specifications

Network Camera Specifications

Item	Description
Pan/Tilt Angle	Pan: -60° to +60°, Tilt: 0° to -45°
Sensor Type	1/3 inch CMOS
Number of Pixels	320,000 pixels (Effective Pixels)
Illumination	10—10,000 lx
White Balance	Auto/Manual/Hold
Adjustment	Brightness, White balance
Focus	Fixed 1 m (40 inches)—Infinity
Caliber Ratio (F No.)	F1.8
Horizontal Angle	45°
Exposure	Auto

Other Specification

Item	Description
Video Compression	JPEG/3 Levels
Video Resolution	640 x 480, 320 x 240 (default), 160 x 120
Buffered Image* ¹	About 80 frames (320 x 240) with time display
Magnification	100% or 150%
Frame rate (in 60 Hz)* ²	Max. 7.5 frames/second (640 x 480) Max. 15 frames/second (320 x 240) Max. 15 frames/second (160 x 120)
Supported Protocols	TCP, UDP, IP, HTTP, FTP, SMTP, POP3, DHCP, DNS, DDNS, ARP, ICMP, NTP
Message Transferring Condition	When detecting the alarm
Message Transferring Method	SMTP

Item	Description
Image Transferring Condition	Timer: Day of the Week/Hour/Minute/Second Alarm: External Sensor Input
Image Transferring Method	SMTP, FTP
Interface	10Base-T Ethernet RJ-45 connector x 1
External I/O* ³	External Sensor Input x 1 External Device Control Output x 1
Power Indicator Display	Power/Network Camera operation
Ethernet Indicator Display	Network Communication
Dimension (HWD)	116 mm (4.57 inches) x 115 mm (4.53 inches) x 72 mm (2.83 inches)
Weight	350 g (0.77 lb.) (Only the unit)
Power Supply	AC adaptor: Input 120 V AC Output 9 V DC Consumption: 8 W
Condition	Operation temperature: +5 °C to +40 °C (+41 °F to +104 °F) Storage temperature: 0 °C to +50 °C (+32 °F to +122 °F) Humidity: 20% to 80% (No Condensation)

- *¹ The maximum number of frames depends on the image quality and the object situation in Buffered Image.
- *² Frame rate varies with the network condition, the PC performance, the image quality and the object situation.
- *³ A sensor must be attached to Network Camera in order to utilize the alarm trigger.

5.4 Troubleshooting

About Network Camera Setup

Problem	Cause and Remedy
When Setup CD-ROM cannot find Network Camera.	<ul style="list-style-type: none"> • Reconnect the AC adaptor if installation is not completed within 20 minutes. • Do not connect Network Camera over a broadband router. Setup program cannot detect Network Camera. • If IP address is not assigned to the PC, setup program cannot find Network Camera. Confirm that IP address is assigned to the PC in the way shown on page 23. IP address of the PC can be assigned on TCP/IP Properties window to access through the steps in the TCP/IP Properties Table on page 24. • Confirm that the Network Configuration from setup program is enabled on Network window on page 54. • When you set up Network Camera in [Type 3], connect temporarily Network Camera in [Type 1], [Type 2] or [Type 4]. • Antivirus software on the PC may interfere with the setup program. Disable the firewall of the antivirus software only when setting up Network Camera.
When Setup program fails to save the network parameters.	<ul style="list-style-type: none"> • Reconnect the AC adaptor if installation is not completed within 20 minutes. • Network may have the trouble. Confirm the parameters and the connections of Network Camera through page 18—page 31.
Top Page does not appear in the Internet Connection.	<ul style="list-style-type: none"> • Confirm that Default Gateway address is correct on Network window on page 54. • The broadband router needs Port Forwarding (IP Masquerade) feature. Refer to the broadband router's manual for details. • Packet Filtering of the broadband router may prohibit access from an external network. Refer to broadband router's manual for details. • Access Network Camera from the Internet with the global IP address of the broadband router and port number of Network Camera. • Some broadband routers reject the global IP address to access Network Camera on the same LAN. Access with the private IP address of Network Camera.

About Network Camera Setup

Problem	Cause and Remedy
<p>When Top Page does not appear.</p>	<ul style="list-style-type: none"> • Enter the correct IP address in the web browser. • IP address and Subnet Mask of the PC and the Network Camera must be in the same class of the private IP address on the LAN. Refer to page 25. • The network congestion prevents Top Page from appearing quickly. Wait for a while. • A proxy server may prevent you from connecting directly to Network Camera, set up not to use the proxy server. Refer to page 26 for details. • When Top Page does not appear, port number 80 might not be available. Ask your ISP for the available port number. • When you use DDNS, you need to set Default Gateway and DNS server address. Refer to page 54 for Network window. • If Top Page does not appear in the above procedure, press the CLEAR SETTING button and set up with the Setup CD-ROM again. • The procedure on page 115 can be established if Network Camera has a defect.
<p>When forgetting the IP address of the Network Camera.</p>	<p>Check an IP address by using the Setup CD-ROM. Network Camera List window on page 29 can tell you the IP address of Network Camera.</p>
<p>When forgetting the password to access Setup Page.</p>	<p>Follow the steps below.</p> <ol style="list-style-type: none"> 1. Initialize Network Camera by pressing the CLEAR SETTING button. 2. Reconfigure Network Camera.
<p>Power Indicator does not light up.</p>	<ul style="list-style-type: none"> • Confirm that the standard AC adaptor PQLV10 (Order No. PQLV10Y) is used. • Confirm that the Indicator Control is disabled. Refer to page 84 for Indicator Control window.
<p>Ethernet Indicator does not light up.</p>	<ul style="list-style-type: none"> • Ethernet cable is not connected properly. • PC, Ethernet hub or broadband router is not working.

About Network Camera Setup

Problem	Cause and Remedy
Power Indicator continues blinking.	<ul style="list-style-type: none"> • Internal Failure of the server or the congestion on the network traffic when using DHCP may prevent Network Camera from getting the IP address. Ask the network administrator or your ISP. • Power Indicator blinks when updating firmware on page 87. When the Update Firmware failed, refer to page 112. • If you cannot access Network Camera, the Network Camera hardware may be defective. Call our customer call center.
Image Transfer on e-mail or FTP does not work.	<ul style="list-style-type: none"> • Default Gateway and DNS server address should be set up on Network window on page 54. • If FTP does not work properly, ask your ISP or network administrator about the transferring mode of FTP server. [Passive Mode] or [Active Mode] is available. • Select [One Time] for Login Timing when transferring images by FTP in short duration time.
Timer mode transfers older images.	Short interval of Image Buffer Frequency makes Network Camera transfer the older images. Set the interval long enough to transfer the images. Buffered Image screen enables you to check this setting.

About Network Camera Setup

Problem	Cause and Remedy
<p>Update Firmware has not finished.</p>	<p>When Update Firmware is interrupted by power off, or for network troubles and other problems, follow the procedure below.</p> <div style="text-align: center;"> <pre> graph TD A[Turn on Network Camera and the PC.] --> B[Enter the IP address on the web browser to access Network Camera.] B --> C{Top Page or Update Firmware window?} C -- Top Page --> D[Access Setup Page or Status window. Check the Firmware Version Number.] C -- Update Firmware window --> H[Update Firmware window] D --> E{Is the Version wished number?} E -- Yes --> F[Perform Update Firmware*1.] E -- No --> H F --> G[Update Firmware is completed.] H --> G </pre> </div> <div style="display: flex; align-items: center; margin-top: 10px;">  <div style="border: 1px solid black; padding: 2px; font-size: small;"> Network Camera Version ** </div> </div> <p style="margin-top: 20px;">*₁ Refer to page 87 for the Update Firmware.</p>

About Top View Image screen

Problem	Cause and Remedy
<p>The Top View Image screen (Single Camera/ Multi-Camera) does not appear.</p>	<ul style="list-style-type: none"> • If you are using Internet Explorer, the first time the PC connects to Network Camera, a pop-up Security Warning window will appear to download ActiveX Controls. When using Windows NT, Windows 2000 or Windows XP, log on with an appropriate account that is authorized to install applications. Refer to page 39 for ActiveX Controls. • On the Air time setting on page 64 may restrict the access to Top View Image screen. Blue screen appears. • Maximum 10 users can view the Motion JPEG simultaneously on the network. The 11th user views the blue screen on the Network Camera screen. Blue screen appears. • Network congestion may prevent the Top View Image screen from appearing quickly. Wait for a while. • The proxy server may prevent you from connecting directly to Network Camera, set up not to use the proxy server. Refer to page 26 for details.
<p>Pan/Tilt does not work. (including Click to Center and Preset Positioning)</p>	<ul style="list-style-type: none"> • Click [Refresh] on the web browser when the communication stops with Network Camera. The image will refresh. • Other clients may be operating Pan/Tilt. • Pan/Tilt operation has reached the end of corner. Confirm End Display appears on operation bar on page 42. • The Pan/Tilt operation may be locked. Refer to page 78 for Camera Setup window. • Pan/Tilt Range values may have been specified. Assign appropriate Pan/Tilt Range values. Refer to page 78 for Camera Setup window.
<p>Image is out of focus.</p>	<ul style="list-style-type: none"> • The lens is dirty or dust is attached. Clean the lens with a lens cleaner. • Network Camera cannot focus on an image within 1 m (40 inches). Keep the object more than 1 m (40 inches) off the lens.
<p>The color of the image is strange.</p>	<ul style="list-style-type: none"> • Adjust White Balance by Camera Setup window. Refer to page 78. • Confirm that the color setting of the PC is 16 bits or more.

About Top View Image screen

Problem	Cause and Remedy
Image flickers.	<ul style="list-style-type: none"> • If the object is dark, the image will flicker. Make the condition around Network Camera brighter. • Wrong power line frequency makes images flicker. Refer to page 78.
Refresh interval is longer than the setup.	<ul style="list-style-type: none"> • The traffic of the network, PC performance and the object of the image affect the refresh interval. The network congestion causes refresh interval slower than the set up. • When more than one client are viewing, the refresh interval becomes slower. • Ethernet switching hub can smooth the refresh interval especially in viewing on the Multi-Camera screen. • Restrict the Max. Bandwidth Usage to improve network traffic in viewing on the Multi-Camera screen. Refer to page 57.
Suddenly image changes to JPEG - Regularly Refresh.	The duration time to display Motion JPEG is limited on Top View Image Setting window on page 64.
Only half of the image is displayed.	If using Internet Explorer 4.0, use Internet Explorer 5.0 or later.
The unreadable characters are displayed.	<ul style="list-style-type: none"> • Use the operating system of the selected language. • Set the Encoding or the Character Set of the selected language on the web browser.

About Other Troubles

Problem	Cause and Remedy
When you cannot solve your problem	<ul style="list-style-type: none"> • Call our customer call center at 1-800-272-7033 • After the limited warranty, call our Continued Services Technical Support Line at 1-900-555-PANA (1-900-555-7262)

5.5 Confirmation of Network Camera Operation

This procedure checks the Network Camera operation. IP address of the PC has to be on the same network to be able to access Network Camera. If Top Page appears, Network Camera has no defect.

1. Push the **CLEAR SETTING button** as illustrated on page 100. All settings on Network Camera will be set to default.
2. Connect locally between the PC and Network Camera like **[Type 1]** or **[Type 4]** configuration type shown on page 18 and page 19.
3. Follow the next steps distinguished by the operating system in the next table to open **TCP/IP Properties window**.

TCP/IP Properties Table

Operating System	Steps
Windows 95 Windows 98 Windows Me	[Start] → [Settings] → [Control Panel] → [Network] → Select [TCP/IP] with adaptor in use → [Properties] → [Specify an IP address]
Windows NT	[Start] → [Settings] → [Control Panel] → [Network] → [Protocols] tab → [TCP/IP Protocol] → [Properties] → Select [Adaptor] in use → [Specify an IP address]
Windows 2000	[Start] → [Settings] → [Control Panel] → [Network and Dial-up Connections] → [Local Area Connection Icon] in use → [Properties] → Select Internet Protocol [TCP/IP] → [Properties] → [Use the following IP address]
Windows XP	[Start] (→ [Settings]) → [Control Panel] → [Network and Internet Connections] → [Network Connections] → [Local Area Connection Icon] in use → [Properties] → Select Internet Protocol [TCP/IP] → [Properties] → [Use the following IP address]

Note

When using Windows NT, Windows 2000 and Windows XP, log on as an administrator ID to access **TCP/IP Properties window**.

4. Record the current **TCP/IP properties** of the PC. They are important in the later procedure to set the TCP/IP properties of the PC back.
5. Enter "192.168.0.250" in the IP address field and "255.255.255.0" in the Subnet Mask field and click **[OK]**.
(Windows 95, Windows 98 and Windows Me must restart to activate the entered TCP/IP properties.)
 - Set up the unique IP address which does not overlap other IP addresses on the network. Overlapped IP addresses on the network cause the disorder of the network.
6. Start up the web browser. Enter "**http://192.168.0.253**" in the address field and press **[Enter]**. If Top Page appears, Network Camera has no defect.



Click the language to change the display.

Note

The proxy server may prevent you from connecting directly to Network Camera. Refer to page 26.

7. Set the TCP/IP properties of the PC back to the previous settings recorded in step 4.

5.6 FCC and Other Information

This equipment has been tested and found to comply with the limits for a Class B digital device, pursuant to Part 15 of the FCC Rules. These limits are designed to provide reasonable protection against harmful interference in a residential installation. This equipment generates, uses and can radiate radio frequency energy and, if not installed and used in accordance with the instructions, may cause harmful interference to radio communications. However, there is no guarantee that interference will not occur in a particular installation. If this equipment does cause harmful interference to radio or television reception, which can be determined by turning the equipment off and on, the user is encouraged to try to correct the interference by one or more of the following measures:

- Reorient or relocate the receiving antenna.
- Increase the separation between the equipment and receiver.
- Connect the equipment into an outlet on a circuit different from that to which the receiver is connected.
- Consult the dealer or an experienced radio/TV technician for help.

Environment: Do not install Network Camera where the temperature is less than +5 °C (+41 °F) or greater than +40 °C (+104 °F). Allow 10 cm (4 inches) clearance around the unit for proper ventilation. Avoid excessive smoke, dust, mechanical vibration, shock, or direct sunlight.

Routine care: Wipe the unit with a soft cloth. Do not use benzine, thinner, or any abrasive powder. When you leave the unit unused for a long period of time, unplug the AC adaptor from the outlet.

If there is any trouble: Consult an authorized Panasonic Factory Service Center.

CAUTION:

Any changes or modifications not expressly approved by the party responsible for compliance could void the user's authority to operate this device.

No responsibility will be taken by our company with respect to consequences resulting from the use or the damage or both of Network Camera.

Index

A

AC adaptor 12, 20, 108
ActiveX Controls 39
Administrator 60
Alarm Mode 68
Alarm trigger 68, 69
ASCII character table 96
Authentication 11, 36, 61, 63
Auto Adjustment 59

B

Brightness 79
Broadband Router 32
Buffered Image 46, 67, 69, 70, 73, 74, 76

C

Camera Name 58
Camera Setup 78
Camera Stand 12, 92
Category 5 cable 20
CATV/xDSL/Optical cable modem 18
Circuit diagram 95
CLEAR SETTING button 15, 100
Click to Center 41
Configuration window 30

D

Date and Time 58, 59
DC IN jack 15, 20
DC plug 20
DDNS (Dynamic Domain Name System)
57
Default Gateway 22, 56
Default Setting 90, 100, 101
DHCP (Dynamic Host Configuration Pro-
tocol) 56
DNS server address 22

E

E-mail 71, 73, 77
Ethernet 10
Ethernet Indicator 15, 20
Ethernet port 15, 20
Ethernet switching hub 18

External Device Control Output 83, 94
External I/O 15, 94
External Output Control 83
External sensor 94
External Sensor Input 94

F

FCC and Other Information 117
File size of the image 57
Fixed Focus Lens 14
FTP (File Transfer Protocol) 70, 73, 76

G

General User 62

H

Help 36, 42
Home Position Button 43, 44
Host Name 56

I

Image Quality 42
Image Size 42
Image Transfer 66
Important Safety Instruction 4
Indicator Control 84
Interface 10
Internet Connection 18
Internet Direct Connection 19
Internet Explorer 10
IP (Internet Protocol) address 22, 25, 56,
82

J

JPEG - Regularly Refresh 38, 47, 65

L

LAN/Intranet 18
Limit time of Continuous Motion JPEG 65

M

MAC address 15, 29
Max. Bandwidth Usage 22, 57
Motion JPEG 38
Mounting 92

MS-DOS Prompt 23
Multi Client Access 8
Multi-Camera 48, 81
Multi-Language 37, 64

N

Netscape Navigator 10
Network Protocol 10
Network window 54
Non Transfer mode 67
NTP (Network Time Protocol) 59

O

On the Air time 65
Operating System 10
Operation Bar 42

P

Pan Range 79
Pan/Tilt 14, 43, 79
Pan/Tilt Scan 43
Password 11, 36, 61, 63
Port Forwarding (IP Masquerade) 32
Port No. 22, 55
Power Indicator 14, 84
Power Line Frequency 79
Power Supply 108
PPPoE (Point-to-Point Protocol over Ethernet) 19
Preset Button 44, 45
Preset Positioning 44, 79
Primary time 69, 73, 75
Private IP address 25

R

Resolution 42, 65
Restart 86
RJ-45 connector 108

S

Screws and Washers 12, 92
Secondary time 69, 75
Security 11, 36, 60, 62
Serial Number 15

Setup CD-ROM 12, 13
Setup Page 49
Single Camera 40
Static 22, 56
Status 85
Subnet Mask 22, 25, 56

T

TCP/IP 10
TCP/IP Properties window 24, 25, 115
Tilt Range 79
Timer Mode 74
Timer trigger 75
Top Page 31, 33, 36, 37, 53, 116
Top View Image 36, 48, 64
Tripod Mounting 92
Tripod Mounting Hole 15

U

Update Firmware 87

W

Web browser 10
White Balance 78, 107
Windows 10, 24, 115

For product service

- Panasonic Servicers are listed in the servicer directory.
- Call 1-800-272-7033 for the location of an authorized servicer.
- After the limited warranty, please contact our Continued Services Technical Support Line at 1-900-555-PANA (1-900-555-7262). If you have difficulty reaching this number, it may be blocked by your phone company. Please contact your local phone company to correct this.
- This Network Camera is designed for use in the United States of America. Sale or use of this product in other countries/areas may violate local laws.

When you ship the product

- Carefully pack your unit, preferably in the original carton.
- Attach a letter, detailing the symptom, to the outside of the carton.

Symptom _____

- Send the unit to an authorized servicer, prepaid and adequately insured.
- Do not send your unit to the Panasonic Consumer Electronics Company listed below or to executive or regional sales offices. These locations do not repair consumer products.

Operating Instructions are subject to change without notice.

Panasonic Consumer Electronics Company, Division of Matsushita Electric Corporation of America

One Panasonic Way, Secaucus, New Jersey 07094

Panasonic Sales Company, Division of Matsushita Electric of Puerto Rico, Inc.

Ave. 65 de Infantería, Km. 9.5, San Gabriel Industrial Park
Carolina, Puerto Rico 00985

Copyright:

This manual is copyrighted by Panasonic Communications Co., Ltd. (PCC). Under the applicable copyright laws, this manual may not be reproduced in any form, in whole or part, without the prior written consent of PCC and its licensee.

© 2001 Panasonic Communications Co., Ltd. All Rights Reserved.