

# Panasonic

## Network Camera

### Operating Instructions

---

Model No. **KX-HCM270**

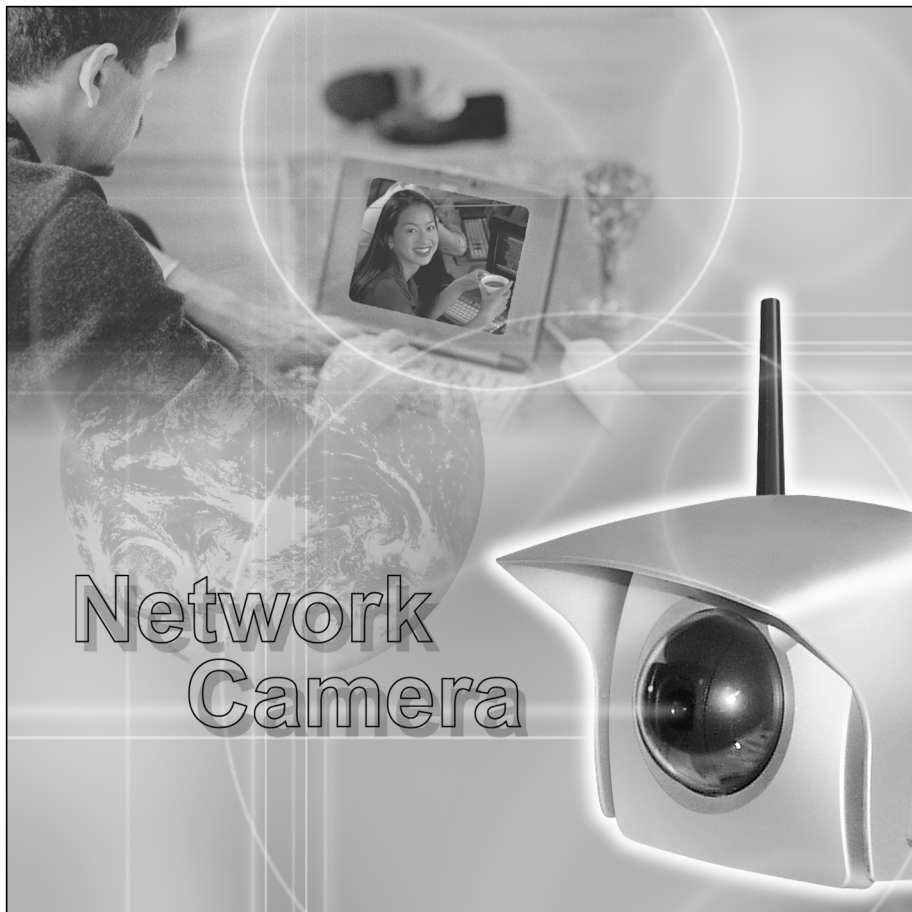

**Please read this manual before using and save this manual for future reference.**

**Panasonic Network Camera Site: <http://www.panasonic.com/netcam>**

for customers in the USA or Puerto Rico

# Introduction

**Thank you for purchasing a Panasonic Network Camera.**

**Check the following items when unpacking.**

Network Camera	— 1 pc.
Operating Instructions	— 1 pc.
Getting Started	— 1 pc.
AC Adaptor	— 1 pc.
Flexible Stand	— 1 pc.
Sunshade	— 1 pc.
Setup CD-ROM	— 1 pc.
Rubber Cap	— 1 pc.
Putties	— 1 set (4 pcs.)
Self Bonding tape	— 1 pc.
Connector Cover	— 1 pc.
Screws	— 5 pcs.
Screws for Flexible Stand	— 3 pcs.

**For operation assistance:**

- Call **1-800-272-7033**
- Refer to the Panasonic Network Camera Site  
**<http://www.panasonic.com/netcam>**

## Trademarks

- Netscape and Netscape Navigator are either registered trademarks or trademarks of Netscape Communications Corporation in the U.S. and other countries.
- Adobe and Acrobat are either registered trademarks or trademarks of Adobe Systems Incorporated in the United States and/or other countries.
- Ethernet is either a registered trademark or a trademark of Xerox Corporation in the United States and/or other countries.
- Microsoft, Windows, Windows NT, MS-DOS, Hotmail and ActiveX are either registered trademarks or trademarks of Microsoft Corporation in the United States and/or other countries.
- Pentium is a trademark or registered trademark of Intel Corporation or its subsidiaries in the United States and other countries.
- Screen shots reprinted with permission from Microsoft Corporation.

All other trademarks identified herein are the property of their respective owners.

## Network Camera Memo

**Attach your purchase receipt here.**

### For your future reference

Date of purchase \_\_\_\_\_

Serial Number \_\_\_\_\_

(Found on the rear side of the unit)

SSID (ESSID) \_\_\_\_\_

MAC address \_\_\_\_\_

Encryption Password \_\_\_\_\_

Name and address of dealer \_\_\_\_\_

## **IMPORTANT SAFETY INSTRUCTIONS**

When using this unit, basic safety precautions should always be followed to reduce the risk of fire, electric shock, or personal injury.

- 1.** Read and understand all instructions.
- 2.** Keep these instructions.
- 3.** Heed all warnings.
- 4.** Follow all instructions.
- 5.** After taking away the sand or the dust on the Lens Cover, wipe the Lens Cover with a dry cloth.
- 6.** Do not block any ventilation openings. Install in accordance with the manufacturer's instructions.
- 7.** Do not install near any heat sources such as radiators, heat registers, stoves, or other devices (including amplifiers) that produce heat.
- 8.** Protect the AC adaptor cord from being walked on or pinched particularly at plugs, convenience receptacles, and the point where they exit from the unit.
- 9.** Only use attachments/accessories such as stands, tripods, and brackets specified by the manufacturer.
- 10.** Do not touch the unit or the AC adaptor during lightning storms.
- 11.** Unplug the unit when unused for long periods of time.
- 12.** Refer all servicing to qualified service personnel. Servicing is required when the unit has been damaged in any way, such as AC adaptor cord or plug is damaged, the unit does not operate normally, or has been dropped.
- 13.** The attached AC adaptor is intended for indoor use only. Both AC adaptor and cord must be waterproofed for outside use.

## **SAVE THESE INSTRUCTIONS**

# Table of Contents

<b>1</b>	<b>Product Introduction</b>	<b>7</b>
1.1	Getting to Know Network Camera	8
1.1.1	Main Features	8
1.1.2	System Requirements	10
1.1.3	Authentication—System Security Feature	11
1.2	Included Accessories	12
1.3	Camera Feature Locations	14
1.3.1	Front View	14
1.3.2	Rear View	15
1.3.3	Bottom View	15
<b>2</b>	<b>Network Camera Setup</b>	<b>16</b>
2.1	Installation Procedure	17
2.2	Network Camera Configuration Type	18
2.3	How to turn on Network Camera for Installation	20
2.4	Network Parameters	21
2.4.1	Preparing the Network Parameters for Network Camera	21
2.4.2	Setting IP Address of the PC in [Type 4] Configuration Type	24
2.5	Proxy Server Setting	26
2.6	Simple Installation using the Setup CD-ROM	28
2.7	Wireless Setup	32
2.8	Network Camera Access from the Internet	37
<b>3</b>	<b>Network Camera Screen and Setup Window</b>	<b>39</b>
3.1	Network Camera Flow Chart	40
3.2	Top Page	41
3.3	Single Camera Screen	44
3.3.1	Using Operation Bar	46
3.3.2	Using Pan/Tilt Operation	47
3.3.3	Setting Preset Positioning and Home Positioning	48
3.3.4	Viewing Buffered Image Screen	50
3.4	Multi-Camera Screen	52
3.5	Setup Page	53
3.5.1	Go to Top Page	57
3.5.2	Network	58

- 3.5.3 Name/Time..... 62
- 3.5.4 Security: Administrator ..... 64
- 3.5.5 Security: General User ..... 66
- 3.5.6 Top View Image ..... 68
- 3.5.7 Image Transfer ..... 70
- 3.5.8 Camera Setup ..... 82
- 3.5.9 Multi-Camera..... 85
- 3.5.10 External Output Control..... 87
- 3.5.11 Indicator Control..... 88
- 3.5.12 Status ..... 89
- 3.5.13 Restart..... 90
- 3.5.14 Update Firmware..... 91
- 3.5.15 Reset to Factory Default..... 94

**4 Technical Guides ..... 95**

- 4.1 Network Camera Installation..... 96
  - 4.1.1 Network Camera Cabling ..... 98
  - 4.1.2 Network Camera Mounting..... 101
- 4.2 Interfacing to the External I/O ..... 106
- 4.3 ASCII and ISO-8859-1 Character Table ..... 108
- 4.4 Maintenance ..... 110

**5 Specifications and Troubleshooting ..... 111**

- 5.1 Network Camera Reset Procedure—Default Settings..... 112
- 5.2 Default Settings List..... 113
- 5.3 Specifications ..... 119
- 5.4 Troubleshooting ..... 121
- 5.5 Confirmation of Network Camera Operation ..... 127
- 5.6 FCC and Other Information ..... 129
- 5.7 Glossary ..... 131

**Index ..... 133**

# ***Section 1***

## **Product Introduction**

# 1.1 Getting to Know Network Camera

## 1.1.1 Main Features

### Wireless Communication

Network Camera corresponds to the wireless system based on IEEE 802.11b. Wireless installation will play an increasing role in flexible mounting. Communication via Ethernet® (10Base-T) cable is also available. Encryption establishes the security on the wireless network.

### Splash Resistant body

Network Camera has a splash resistant body. The splash resistant body allows Network Camera to be used indoors and outdoors. Note that the attached AC adaptor is intended for indoor use only. Refer to page 96 for Outdoor Cabling and Mounting.

### Easy installation

Setup CD-ROM simplifies the installation. Insert the Setup CD-ROM and autorun program should start the application automatically. This program automatically finds Network Camera on the network.

### High-Speed Motion JPEG

Network Camera has an integrated web server. Motion JPEG displays up to 15 frames per second, if the network provides enough bandwidth. To conserve bandwidth, **JPEG - Regularly Refresh** can be selected from Top Page. Image Resolution, Image Quality, Refresh interval, **Limit time of Continuous Motion JPEG** and **On the Air time** features can control the image field.

### Remote Pan/Tilt

**Pan/Tilt** operation can move the lens 120° horizontally and 45° vertically. This movable lens allows you to see the situation widely where the object is. Operation bar has **Preset Positioning** and **Home Positioning** features to register fixed positions. Clicking the preset buttons moves the lens to the preset positions you want to view. Single Camera screen has **Click to Center** feature too. The object on Single Camera screen can be centered by clicking on the image directly.



## Multi-Camera Screen

Using **Multi-Camera screen** you can simultaneously view up to four Network Cameras at various locations. Clicking on each Camera Name switches to the Single Camera screen from the Multi-Camera screen.

## Multi-Client Access

Network Camera allows up to 30 users to view Motion JPEG image simultaneously. Users can access the Top View Image screen (Single Camera/ Multi-Camera screen) from their own locations. Note that as the number of users simultaneously connected to Network Camera increases, the overall motion performance will decrease.

## External I/O (Input/Output)

The external sensors/devices such as a door sensor can be connected via the **External Sensor Input**. The external sensors/devices are customer provided. The alarm/timer trigger can activate the Image Transfer feature, which can send the images via e-mail or FTP (File Transfer Protocol).

**External Device Control Output** can send a signal to activate the external devices such as a light around Network Camera.

## Update Firmware

If new firmware is released, you can download the latest program from Network Camera Technical Support Site. Installation is easy and fast. Refer to page 91 for details.

## Authentication

**Authentication window** requires you to enter the administrator/general user ID and password. Password security can prevent unregistered users/intruders from accessing your image from their web browsers. Refer to Section 1.1.3 Authentication—System Security Feature for details.

## Multi-Language Display

Top Page, Single Camera screen and Multi-Camera screen can be displayed in English (US), English (UK), French, German, Italian, Spanish or Japanese. All Setup windows are also changed when selecting English (US), English (UK) or Japanese.

## 1.1.2 System Requirements

The PC (Personal Computer) and the network must meet the following technical specifications for Network Camera to work properly.

Item	Description
<b>Operating System</b>	Microsoft® Windows® 95, Microsoft Windows 98/SE Microsoft Windows 2000, Microsoft Windows Me Microsoft Windows NT® 4.0, Microsoft Windows XP
<b>Network Protocol</b>	TCP/IP network protocol installed. (HTTP, TCP, UDP, IP, DNS, ARP, ICMP)
<b>Wireless LAN Standard</b>	IEEE 802.11b
<b>Interface</b>	10/100 Mbps Ethernet card for your network connection
<b>Web browser*<sup>1</sup></b>	Internet Explorer 5.0 or later/Netscape Navigator® 4.7x. (Not included on the Setup CD-ROM).

\*<sup>1</sup> Network Camera image is not displayed correctly in the Netscape® v6.x.  
Use Netscape Navigator v4.7x.

Refer to Panasonic Network Camera Site

**<http://www.panasonic.com/netcam>** for the latest information on web browser.

### Note

Pentium® II 300 MHz or greater CPU is recommended to prevent performance degradation.

### 1.1.3 Authentication—System Security Feature

**Authentication window** requires you to enter the administrator/general user ID and password for security. Password security can prevent unregistered users/intruders from accessing your image from their web browsers. Authentication windows are not displayed in the default. Refer to page 64 for setting up Authentication window, the administrator ID and the password. Refer to page 66 for setting up the general user ID and the password.

#### Authentication window

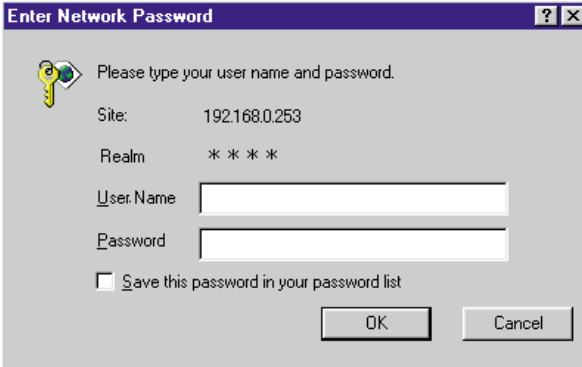

**Enter Network Password** [?] [X]

 Please type your user name and password.

Site: 192.168.0.253

Realm \* \* \* \*

User Name











Password

Save this password in your password list

OK Cancel

## 1.2 Included Accessories

The following items are provided with Network Camera. Additional pieces can be ordered by calling **1-800-332-5368**.

<p><b>AC Adaptor</b> — 1 pc. Order No. PSLP1233Z</p> 	<p><b>Flexible Stand</b> — 1 pc. Order No. PSKL1020Y</p> 	<p><b>Sunshade</b> — 1 pc. Order No. PSYC1HCM230M</p> 
<p><b>Setup CD-ROM</b> — 1 pc. Order No. PSQX2904ZCD</p> 	<p><b>Rubber Cap</b> — 1 pc. Order No. PSHG1236Z</p> 	<p><b>Putties</b> — 1 set (4 pcs.) Order No. PSHG1238Z</p> 
<p><b>Self Bonding tape</b> — 1 pc. Order No. PSHG1235Z</p> 	<p><b>Connector Cover</b> — 1 pc. Order No. PSYC2HCM230M</p> 	<p><b>Screws</b> — 5 pcs. Order No. XTW3+12PVW</p> 
<p><b>Screws for Flexible Stand</b> — 3 pcs. Order No. PQHE5004Z</p> 		

### Notes

- If any items are missing, contact the dealer immediately.
- The order numbers listed above are subject to change without notice.
- Save the original carton and packing materials for future shipping and transportation of the unit.
- Refer to page 98 and page 101 for Outdoor Cabling and Mounting.

## Setup CD-ROM

The setup program simplifies Network Camera installation. Adobe® Acrobat® Reader 4.05 or later enables you to see the Operating Instructions on the Setup CD-ROM. If Adobe Acrobat Reader is not installed on the PC, double-click "ar405eng.exe". Refer to "ReadmeEng.txt" for the directory and file structure of the Setup CD-ROM.

### Notes

- Do not scratch, smudge, write or label either surfaces of the Setup CD-ROM. Setup CD-ROM may have a scratch on the surface.
- Do not leave the Setup CD-ROM in direct sunlight, near a heat source or in a hot automobile as the Setup CD-ROM may become unreadable.
- Do not use chemicals or cleanser to clean the Setup CD-ROM as the Setup CD-ROM may become unreadable.

## 1.3 Camera Feature Locations

### 1.3.1 Front View

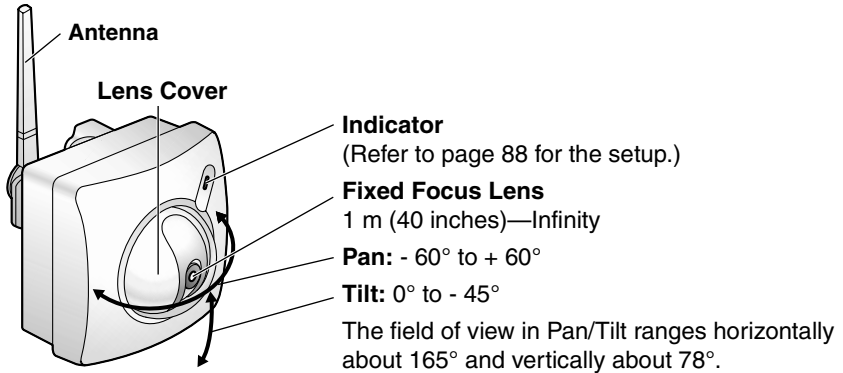

#### Indicator

Indicator can be controlled on **Indicator Control window** on page 88. Color indications are shown below.

Power on	Not on the LAN	Orange → Orange blinking* <sup>1</sup> → Orange
	On the LAN	Orange → Green blinking → Green
Normal Operation		Green
Using DHCP	Getting IP address	Green blinking
	Finish getting IP address	Green
Updating Firmware		Orange blinking
Pushing CLEAR SETTING button		Orange blinking twice
Internal Failure of Network Camera		Red blinking* <sup>2</sup>

\*<sup>1</sup> Orange indicator will continue blinking in the DHCP setting.

\*<sup>2</sup> Refer to page 123 for the red blinking.

#### Fixed Focus Lens and Pan/Tilt operation

Fixed Focus Lens can move in the Pan/Tilt operation. Operation Bar on the Single Camera screen can operate the Pan/Tilt. The Pan/Tilt moves the lens 120° horizontally and 45° vertically. Refer to page 46 for the operation bar.

#### Note

Do not touch the Lens Cover. Touching it may leave a fingerprint and can cause the image to be out of focus.

## 1.3.2 Rear View

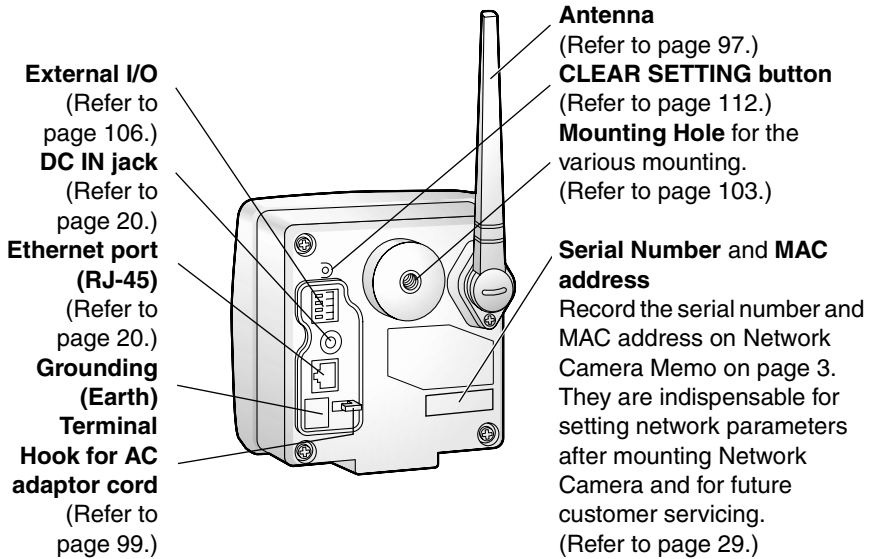

### Grounding (Earth) Terminal

Lightning may cause serious damage to Network Camera. It is recommended to connect the Ground for the protection from the lightning.

## 1.3.3 Bottom View

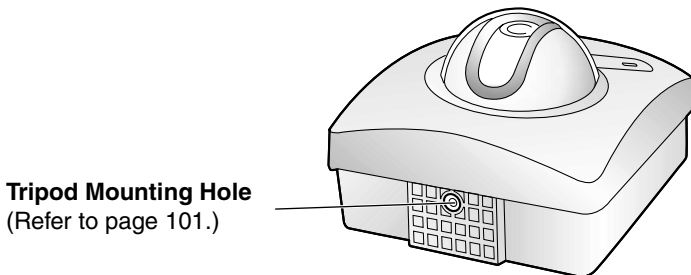

## ***Section 2***

# **Network Camera Setup**



## 2.1 Installation Procedure

**Select the Network Camera configuration type. (Page 18—Page 19)**



**Connect Network Camera for installation. (Page 20)**



**Prepare the network parameters for Network Camera. (Page 21—Page 22)**



**Check the proxy server setting. (Page 26—Page 27)**



**Set up Network Camera with Setup CD-ROM. (Page 28—Page 31)**



**Setting up wireless network parameters. (Page 32 — Page 36)**



**Confirm the Network Camera Access from the Internet. (Page 37—Page 38)**



**Install Network Camera outdoors. (Page 96—Page 105)**

## 2.2 Network Camera Configuration Type

Network Camera can be connected over the LAN/Intranet and the Internet. Select from the four Network Camera configuration types. Network parameters differ depending on the Network Camera configuration type.

### [Type 1]—LAN/Intranet Connection with an Ethernet Switching Hub

Network Camera can be installed on the LAN/Intranet.

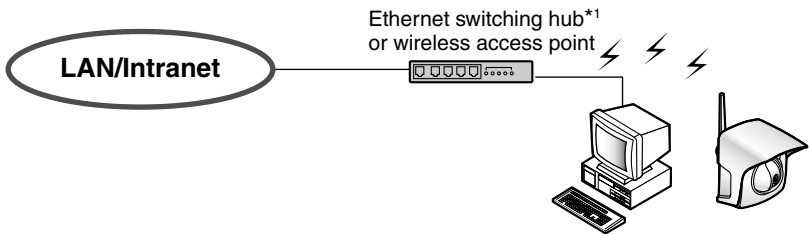

\*1 Network traffic can be improved by using the Ethernet switching hub.

### [Type 2]—Internet Connection with a Broadband Router

Network Camera can be accessed from the Internet. The broadband router needs Port Forwarding (IP Masquerade) feature on page 37.

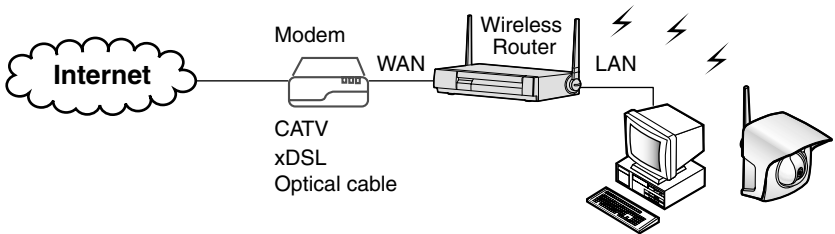

## [Type 3]—Internet Direct Connection with a Modem

Network Camera can be installed alone without PC on the network. When you set up Network Camera in [Type 3], connect Network Camera temporarily in [Type 1], [Type 2] or [Type 4].

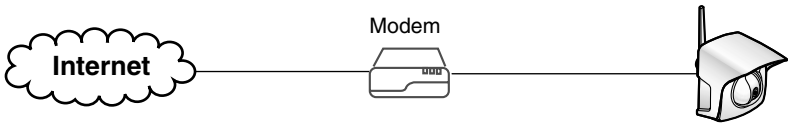

### Note

Some xDSL services use PPPoE. Network Camera does not support PPPoE. If the Internet connection requires PPPoE, connect with the broadband router supporting PPPoE like [Type 2].

## [Type 4]—Direct Connection with a PC

Network Camera can be connected to a PC directly.



### Notes

- Use a category 5 cross cable when connecting directly with the cable to the PC.
- Direct Connection with PC requires IEEE 802.11b wireless devices such as wireless LAN card and wireless USB adaptor.
- Change to AdHoc mode. (Default is Infrastructure mode.) Refer to page 32 for Infrastructure and AdHoc mode.

## 2.3 How to turn on Network Camera for Installation

Network Camera is powered up when connecting AC plug to the power outlet.

1. Connect Category 5 straight/cross cable to the Ethernet port of Network Camera to the hub or PC.
  - Connect Ethernet cable first to make Network Camera recognize the wired communication.
2. Connect the DC plug of the AC adaptor to the DC IN jack and the AC plug of the AC adaptor to the power outlet to turn on Network Camera. Indicator blinks and the Pan/Tilt moves to the center position.

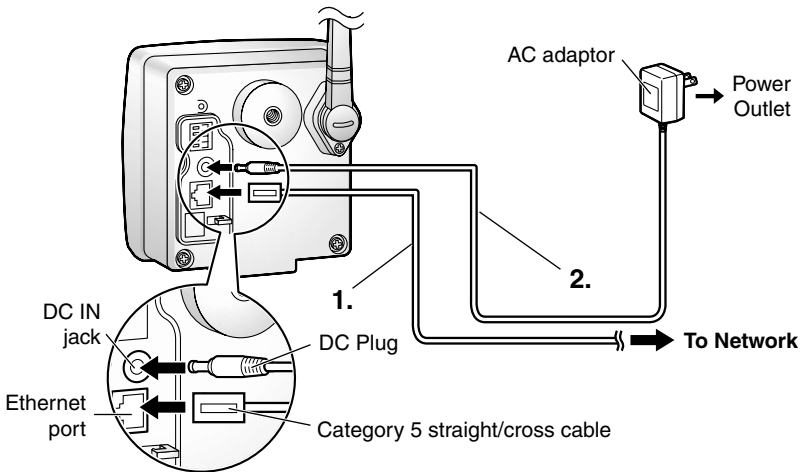

### Notes

- AC adaptor is used as the main disconnect device, so ensure that the power outlet is located/installed near the equipment and is easily accessible.
- Use only the specified Panasonic AC adaptor PSLP1233 (Order No. PSLP1233Z).
- When you set up Network Camera in **[Type 3]**, connect it temporarily in **[Type 1]**, **[Type 2]** or **[Type 4]**.
- When Indicator is orange, confirm that the Ethernet cable is properly connected, or PC, Ethernet hub or broadband router is properly working.

## 2.4 Network Parameters

### 2.4.1 Preparing the Network Parameters for Network Camera

Before starting to set up the network parameters of Network Camera, make note of corresponding network parameters.

- [Type 1] Ask your network administrator for the network parameters.
- [Type 2] Refer to the broadband router's manual for the network parameters.
- [Type 3] Ask your ISP (Internet Service Provider) for the network parameters.
- [Type 4] Install Network Camera in the default condition. Set the PC "192.168.0.250" (IP address) and "255.255.255.0" (Subnet Mask). Refer to page 24.

Refer to page 22 and page 23 for network parameters.

#### Network parameters memo for Network Camera

The devices on the network may not be assigned the same IP address. Each device must have its own IP address. Overlapped IP addresses can cause other network devices to stop working and may result in widespread network problems.

👉 IP Address	. . .	👉 Subnet Mask	. . .
👉 Default Gateway	. . .	👉 DNS Server 1	. . .
👉 DNS Server 2	. . .		

## Network Parameters Table

Parameters	Network Camera Configuration Type			
	[Type 1]	[Type 2]	[Type 3]	[Type 4]
<b>Port No.</b>	80 (default)	80 (default) <sup>*1</sup> <sub>*2</sub>	80 (default) <sup>*1</sup>	80 (default)
<b>IP address</b>	Check [Static], and set the static private IP address.	Check [Static], and set the static private IP address. <sup>*3</sup>	Check [Static], and set the static global IP address. <sup>*4</sup>	192.168.0.253 (default)
<b>Subnet Mask</b>	Set the Subnet Mask fitted to your network.			255.255.255.0 (default)
<b>Default Gateway</b>	Set Default Gateway address.	Set the private IP address of the broadband router (on your network), not of the gateway of your ISP. <sup>*3</sup>	Set Default Gateway address. <sup>*4</sup>	You do not need to set up.
<b>DNS Server 1, 2</b>	Set DNS server address.		Set DNS server address. <sup>*4</sup>	
<b>DDNS</b>	You do not need to setup.	*5	*5	You do not need to setup.
<b>Max. Bandwidth Usage</b>	It can restrict the transmit bandwidth. Select from 0.1 to Unlimited Mbit/s.			

- \*1 Many ISP's intentionally block port number 80 to guard against network viruses. If your ISP blocks port number 80, substitute it to another unused port number.
- \*2 When you use more than one Network Camera with a broadband router, each Network Camera needs its own port number. The broadband router needs the Port Forwarding feature. Refer to page 37.
- \*3 Refer to the broadband router's manual for the Port Forwarding feature.
- \*4 When you use Network Camera in DHCP feature, check [DHCP] and enter the Host Name if your ISP requires. If you automatically get the address of Default Gateway and DNS server from DHCP server, you do not need to set up.
- \*5 Verify that your ISP supports DDNS. If your ISP supports DDNS, or if you assign a domain name to Network Camera, you need to contract and register for DDNS service. Refer to the included leaflet for DDNS service. If you set static global IP address to Network Camera and the broadband router, you do not need to register DDNS service.

## How to refer the network parameters from the PC

If you cannot get the network parameters, you can refer to the network parameters except for IP address from the PC on the same network in the following procedure.

- **When using Windows 95, Windows 98 or Windows Me**

1. Click **[Start]** → **[Run...]**. **Run window** appears.  
These steps are slightly different depending on the operating system.
2. Enter **"winipcfg"** and click **[OK]**. **IP configuration window** appears.
3. Select the proper Ethernet adaptor and click **[More Info]**.

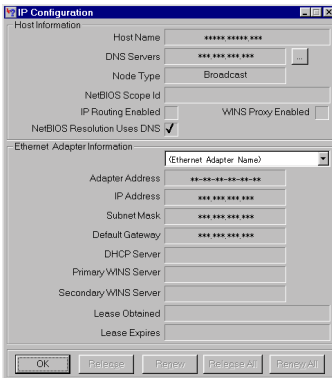

4. Click **[OK]** to close IP Configuration window.

- **When using Windows NT, Windows 2000 or Windows XP**

1. Click **[Start]** → **[Program]** (→ **[Accessories]**) → **[MS-DOS® (Command) Prompt]**. **MS-DOS Prompt window** opens. These steps are slightly different depending on the operating system.
2. Enter **"ipconfig /all"** and press **[Enter]**.

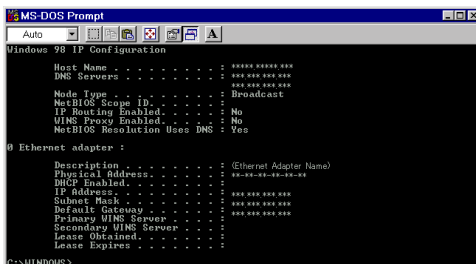

3. Enter **"exit"** and press **[Enter]** to close the window.

## 2.4.2 Setting IP Address of the PC in [Type 4] Configuration Type

Your PC needs to have a static private IP address to access Network Camera in [Type 4] configuration.

1. Follow the steps below, appropriate for your operating system to open **TCP/IP Properties window** on the PC.

**TCP/IP Properties Table**

Operating System	Steps
Windows 95 Windows 98 Windows Me	[Start] → [Settings] → [Control Panel] → [Network] → Select [TCP/IP] with adaptor in use → [Properties] → [Specify an IP address]
Windows NT	[Start] → [Settings] → [Control Panel] → [Network] → [Protocols] tab → [TCP/IP Protocol] → [Properties] → Select [Adaptor] in use → [Specify an IP address]
Windows 2000	[Start] → [Settings] → [Control Panel] → [Network and Dial-up Connections] → [Local Area Connection Icon] in use → [Properties] → Select Internet Protocol [TCP/IP] → [Properties] → [Use the following IP address]
Windows XP	[Start] (→ [Settings]) → [Control Panel] → [Network and Internet Connections] → [Network Connections] → [Local Area Connection Icon] in use → [Properties] → Select Internet Protocol [TCP/IP] → [Properties] → [Use the following IP address]

**Note**

When using Windows NT, Windows 2000 and Windows XP, log on as an administrator to access **TCP/IP Properties window**.



- 2. TCP/IP Properties window** appears. Set "192.168.0.250" in the IP address data field and "255.255.255.0" in the Subnet Mask data field.

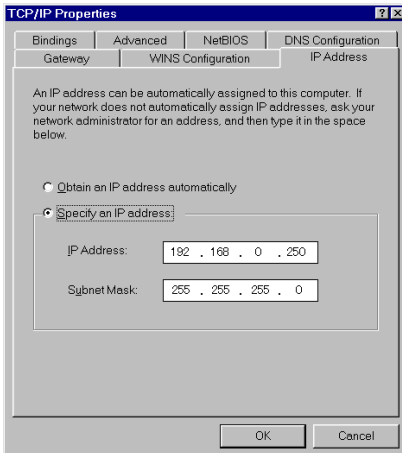

- 3. Click [OK].**

### Private IP address

Private IP address is the network ID that is not used on the Internet. They are classified into Class A, Class B and Class C, as shown in the next table. Set the IP address in the range of the number specified in the class meeting to your local network scale.

Class	Subnet Mask	Private IP address (It can be set freely within the range in your group.)
Class A	255. 0. 0. 0	10. 0. 0. 1 — 10. 255. 255. 254
Class B	255. 255. 0. 0	172. 16. 0. 1 — 172. 31. 255. 254
Class C	255. 255. 255. 0	192. 168. 0. 1 — 192. 168. 255. 254

## 2.5 Proxy Server Setting

A proxy server may prevent you from connecting directly to Network Camera in some corporate environments. The web browser can set up the IP address communication without using a proxy server. Consult your ISP or network administrator.

### Note

A proxy server is generally used to maintain security on a network that offers an Internet connection. The network of Network Camera with the proxy server may cause some problems to the image quality such as taking much time in refresh interval. Consult your ISP or network administrator for details.

1. Start up the Internet Explorer. (The window is Internet Explorer 5.50.)
2. Select [Tools] -> [Internet Options...] -> [Connections] tab and click [LAN Settings]. See if the **Use a proxy server** check box is checked or not in the next window. When checked, click [Advanced...].

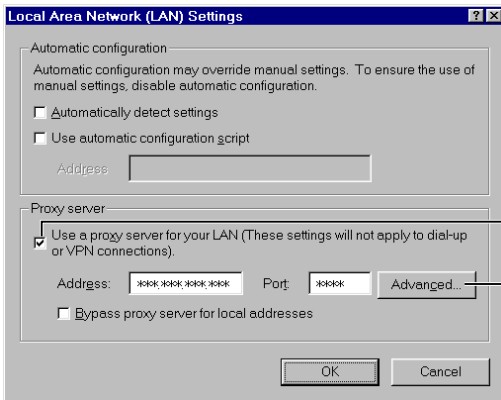

See if the check box is checked or not.  
When checked, click [Advanced...].

When not checked, click [Cancel]. Your proxy settings are causing no problems.

3. Enter the IP address of Network Camera assigned from your ISP or network administrator into the **Do not use proxy server for addresses beginning with data field.**

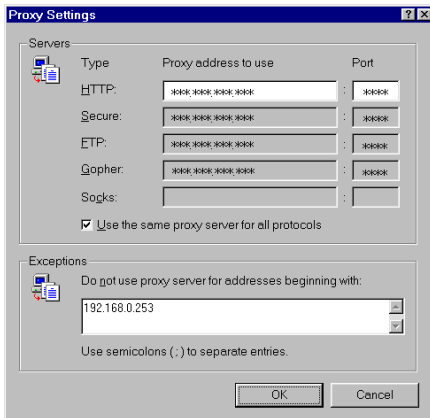

4. Click **[OK]** on all of the opening windows.

## 2.6 Simple Installation using the Setup CD-ROM

After finishing cabling, turn on Network Camera and insert the Setup CD-ROM in the CD-ROM drive of the PC. Setup CD-ROM should start the application automatically. This program automatically finds Network Cameras on the network.

1. Turn on Network Camera.
2. Insert the Setup CD-ROM in the CD-ROM drive of the PC.  
(If **Network Camera Setup window** does not appear, click "setup.exe" on the Setup CD-ROM.)

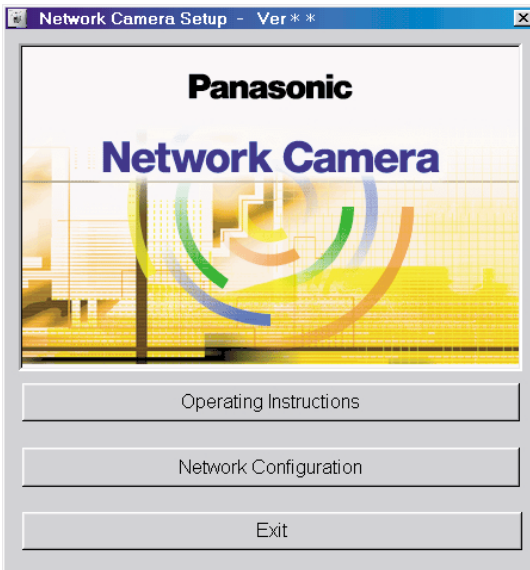

3. Click **[Network Configuration]**. **Network Camera List window** appears. Setup program finds all Network Cameras connected on your local network. It lists all of MAC addresses and IP addresses of Network Cameras. Network Cameras that are isolated by the use of a home gateway or broadband router will not be detected. Record MAC address on the Network Camera Memo on page 3. It is useful for customer servicing.

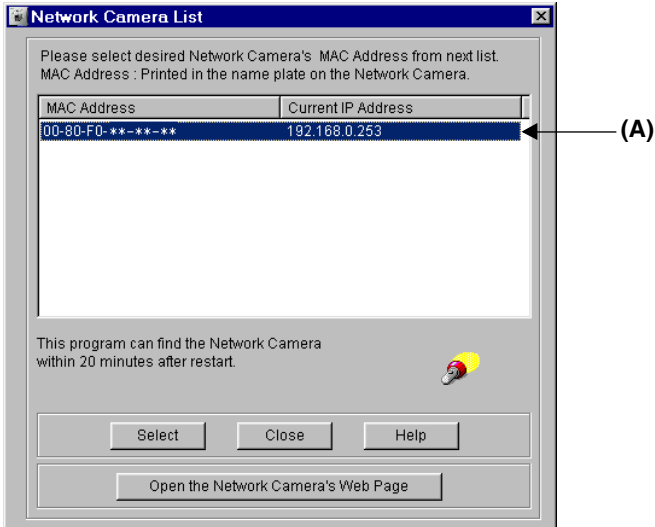

### Notes

- The setup program finds and identifies Network Camera by listening for data, which Network Camera sends out for the first 20 minutes after powering up. If the installation is not completed within 20 minutes, disconnect temporarily the AC adaptor to restart this operation.
- Each Network Camera has a unique MAC address labeled on the back. Refer to page 15.
- Network Cameras that are isolated by the use of a home gateway or broadband router will not be detected.

- Select your target Network Camera from the list as shown in example **(A)** on **Network Camera List window** on page 29 and click **[Select]**. **Configuration window** appears. Refer to page 21 and page 22 and enter the correct network parameters. Refer to page 59 for details of each parameter.

The screenshot shows a 'Configuration' window titled 'MAC ADDRESS 00-80-F0-\*\*-\*\*-\*\*'. It contains several sections for network configuration:

- Static/DHCP Selection:** A radio button for 'Static' is selected, and 'DHCP' is unselected.
- Port No.:** A text box containing the value '80'.
- IP Address:** A text box containing '192 . 168 . 0 . 253'.
- Subnet Mask:** A text box containing '255 . 255 . 255 . 0'.
- Host Name:** An empty text box.
- Current IP Address:** A text box containing '192.168.0.253'.
- Current Subnet Mask:** A text box containing '255.255.255.0'.
- Default Gateway:** A text box containing '0 . 0 . 0 . 0'.
- DNS Server1:** A text box containing '0 . 0 . 0 . 0'.
- DNS Server2:** A text box containing '0 . 0 . 0 . 0'.
- DDNS Enable:** An unchecked checkbox.
- Your E-Mail Address:** An empty text box.
- Personal (Camera) URL:** An empty text box.
- Your Account Link:** A button.
- Max Bandwidth Usage:** A dropdown menu set to 'Unlimited' and a unit selector set to 'Mbps'.

At the bottom of the window are two buttons: 'Save' and 'Cancel'.

- Click **[Save]** when finished. The "Successful!" message box appears.



**Notes**

- Network Camera automatically restarts after saving the network configuration.
- Overlapped IP address displays the next box. If you cannot set up, ask your ISP or the administrator.



## 6. Click [OK].

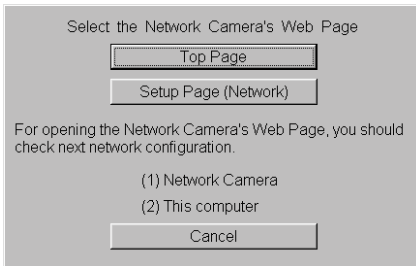

Refer to page 41 for **Top Page**.

Refer to page 32 for **Setup Page (Network Window)** to set up wireless network parameters.

## 7. Click [Top Page]. Top Page appears.

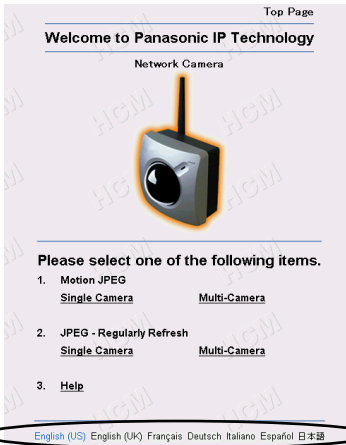

Click the language to change the display.

### Notes

- When viewing images for the first time in the Internet Explorer, a pop-up **Security Warning window** may appear. The window requests your permission to download ActiveX® Controls (OCX file) used to display Motion JPEG. Refer to page 43.
- If you are configuring in **[Type 3]**, Top Page may not appear at this point. After Network Camera is directly connected with the modem, confirm the Network Camera Access from the Internet on page 37.

## 2.7 Wireless Setup

### To access Network window

1. Enter "**http://IP Address (or URL) :Port No./config.html**" on the web browser and press **[Enter]**. **Setup Page** appears. Refer to page 54 for the detail of Setup Page.
  - When port number is 80 (default), you do not need to enter port number.
2. Click **[Network]** on Setup Page.

### To set up the wireless network parameters

Set **SSID (ESSID)** and **Encryption (WEP)** setting of the wireless router to Network Camera in Infrastructure mode and AdHoc mode. AdHoc mode requires you to set channel additionally. Ask the administrator for SSID and Encryption settings. Follow the steps on the next pages.

The screenshot shows the '2. Wireless' configuration section. It includes a 'Status' dropdown menu, a 'Mode' section with 'Infrastructure' and 'AdHoc' buttons, an empty 'SSID' text input field, a 'Speed' dropdown menu set to 'Auto', and an 'Encryption' section with 'None', '40 bit', and '128 bit' buttons. Numbered callouts 1 through 4 point to these specific elements.

- a) [Status]** displays the detail of the wireless network conditions on **Wireless window**. Those conditions are useful to decide where to install Network Camera. Wireless window refreshes every 10 seconds.

Wireless	
<b>BSSID</b>	00:00:00:00:00:00
<b>Channel</b>	0 ch
<b>Speed</b>	0 Mbit/s
<b>Connection</b>	-----
<b>Signal Strength</b>	-----
<b>Firmware</b>	v0.0.0.0

MAC address of wireless router is displayed in **Infrastructure mode**. **BSSID** is automatically generated from SSID in **AdHoc mode**.  
 Connected channel  
 Speed of the data communication  
 \*1 Status of the data communication between Network Camera and wireless router  
 \*1 Signal Strength condition between Network Camera and wireless router.  
 Wireless Software version no. It is different from Setup Page version no.

\*1 Refer to the next page for the connection and signal strength status.



## Connection and Signal Strength status

The intensity of the data communication and radio wave are shown in the levels of 18 asterisks. Install Network Camera in the highest level after confirming the data communication and signal strength status. At the lower levels, Network Camera may easily lose wireless communication.

### 1. Set **[Infrastructure]** (Default) or **[AdHoc]**.

**[Infrastructure]** enables Network Camera to communicate with the wireless router that control transmission paths on the network.

- **[Infrastructure]** automatically adjusts the channel.

**[AdHoc]** enables Network Camera to connect with the other wireless terminal in peer-to-peer communication. **[AdHoc]** requires IEEE 802.11b wireless devices such as wireless LAN card and wireless USB adaptor.

- Set the channel used in the wireless network. Channel can be selected 1—11. (Default is Channel 6.)

#### Channel

Many wireless devices on the same channel make the communicating speed slower. Set 5 channels apart to prevent the bandwidth from overlapping. If another wireless network use Channel 6, you may use Channel 1 or 11.

### 2. Set **SSID (ESSID)** of the wireless router or the wireless LAN card.

SSID is the wireless network name. SSID determines the communicable network group on the wireless network. Set the same SSID to the wireless devices on the wireless network. If SSID is different, Network Camera cannot be viewed on the wireless network.

- SSID is case sensitive.
- Max. 32 characters
- Refer to unavailable characters set 1 on page 108.

### 3. The wireless communication speed can be set. **[Auto]** setting optimizes the performance.

- Parameters are 1, 2, 5.5, 11 Mbps and Auto.

**4.** Set the same **Encryption (WEP)** setting of the wireless router or the wireless LAN card.

Encryption establish the security to prevent unauthorized users to access the wireless data communication. The same encryption is required to all the wireless devices including wireless LAN cards and wireless router in the wireless network. Encryption cipher can be selected **[40 bit] (64 bit)** or **[128 bit]**. **[Password]** generates encrypted cipher. **[Key]** enables you to set the cipher directly on the keyboard.

- **[None]**: Disables the encryption.
  - **[40 bit] (64 bit)**: Encrypts using four patterns of 40 bit cipher.
  - **[128 bit]**: Encrypts using 128 bit cipher.
- [Password]** generates encrypted cipher in 40 bit and 128 bit.  
Set the same password of the wireless router.

**Encryption Password window**

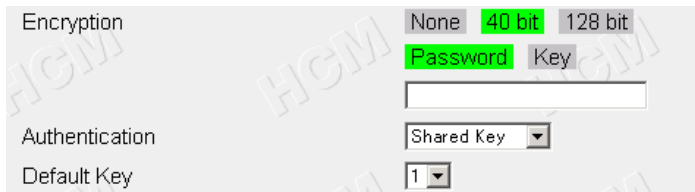

- Password is case sensitive.
- Max. 31 characters
- Refer to unavailable characters set 1 on page 108.

**[Key]** enables you to enter the cipher on the keyboard directly in 40 bit and 128 bit.

Set the same cipher of the wireless router on the keyboard. Numbers 0—9 and alphabets a—f are available.

**Encryption Key window**

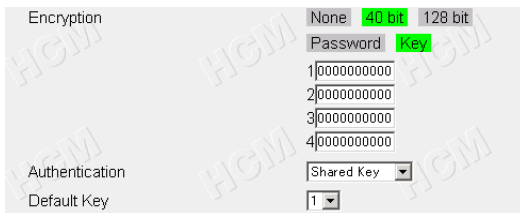

- Four patterns of 10 digits (0—9) or characters (a—f) (40 bit)
- 26 digits (0—9) or characters (a—f) (128 bit)

### **Authentication**

**[Shared Key]** (Default) and **[Open System]** are the encryption system. **[Shared Key]** is generally used on the wireless network. Some wireless routers of other manufacturers may employ **[Open System]** as the encryption system.

### **Default Key**

**Default Key (40 bit only)** is the pattern number to use one of four patterns of 40 bit cipher. Set the same Default Key of the wireless router.

### **Wireless Settings**

Save the wireless setup for the future reference, and record the wireless settings on the Network Camera Memo on page 3. Those information enables you to set up Network Camera again when installing Network Camera on the other network.

- 5.** Confirm if the network parameters and wireless network parameters are correct.
- 6.** Click **[Save]**.
- 7.** Click **[Restart Now!]** to restart to make the wireless network parameters effective.
- 8.** Draw out the Ethernet cable and reconnect the AC adaptor for Network Camera to recognize the **Wireless Communication mode**.

9. Start up the web browser.
10. Enter "**http://IP address (or URL):Port No.**" in the address field and press **[Enter]**. Top Page appears. (Default IP address is 192.168.0.253)
  - When port number is 80 (default), you do not need to enter port number.

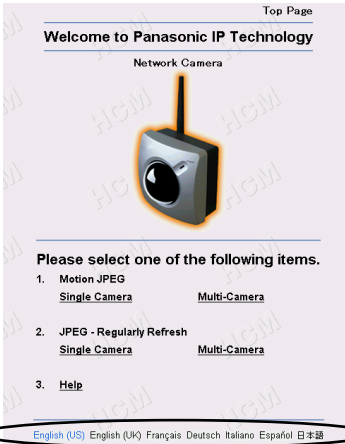

Click the language to change the display.

### Note

When viewing images for the first time in the Internet Explorer, a pop-up **Security Warning window** may appear. The window requests your permission to download ActiveX Controls (OCX file) used to display Motion JPEG. Refer to page 43.

### If Top Page does not appear

- Confirm if SSID and Encryption settings are correct.
- Change the encryption mode to **[Open system]**.

## 2.8 Network Camera Access from the Internet

[Type 2] and [Type 3] of the Network Camera configuration type allow Network Camera to be accessed from the Internet.

### Port Forwarding (IP Masquerade) feature

Set up the Port Forwarding feature to the broadband router if the [Type 2]—**Internet Connection with the Broadband Router** on page 18 is configured. Port Forwarding feature translates a global IP address to a private IP address and assign a unique port number for each Network Camera. Refer to the broadband router's manual for details.

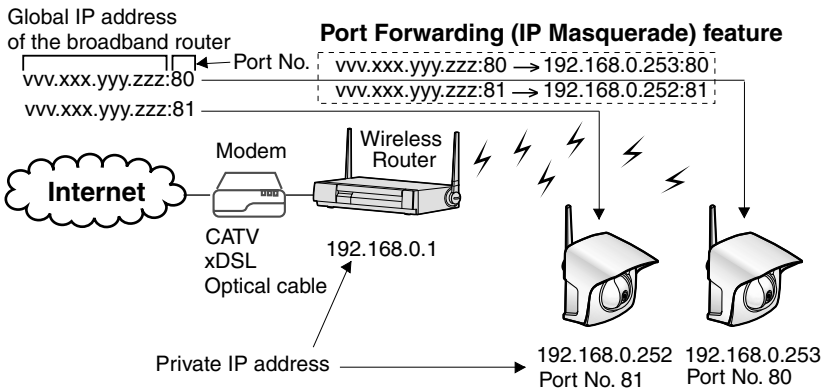

1. Start up the web browser of the PC on the Internet side.
2. Enter "**http://IP address:Port No.**" in the address field and press [Enter]. Top Page appears.
  - When port number is 80 (default), you do not need to enter port number.

[Type 2] Enter "**http://Global IP address of Broadband Router:Port No.**" in the address field.

[Type 3] Enter "**http://Global IP address of Network Camera:Port No.**" in the address field.

## Top Page

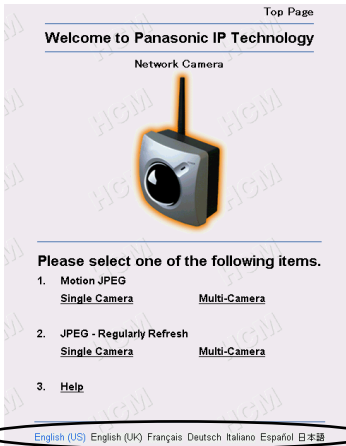

Click the language to change the display.

Refer to page 41 for Top Page.

### Note

When viewing images for the first time in the Internet Explorer, a pop-up **Security Warning window** may appear. The window requests your permission to download ActiveX Controls (OCX file) used to display Motion JPEG. Refer to page 43.

### If Top Page does not appear

Confirm the network parameters and the connections of Network Camera through page 18—page 37.

## ***Section 3***

# **Network Camera Screen and Setup Window**

### 3.1 Network Camera Flow Chart

Top Page enables you to access Top View Image screen (Single Camera/Multi-Camera screen). Authentication window can set password for the link at (A).

Enter "http://IP Address (or URL):Port No." on the web browser.  
 When port number is 80 (default), you do not need to enter port number.

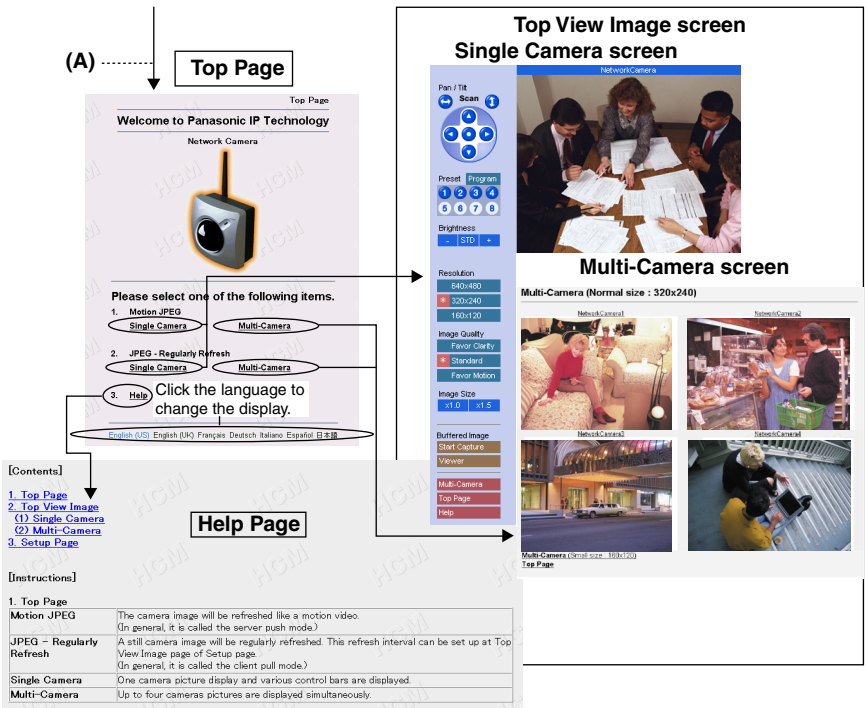

#### (A) Authentication window

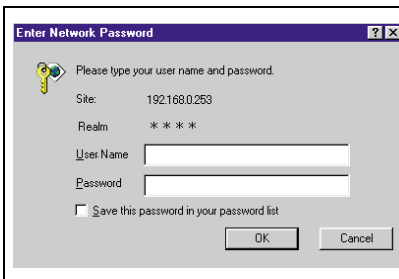

Authentication window can be set up for the security. The password can keep the security of your network. Authentication windows are not displayed in the default. Authentication window can be set on Administrator window. "User Name" and "Password" are case sensitive. Refer to page 64 for details.



## 3.2 Top Page

**Top Page** allows you to select the Single/Multi-Camera screen in Motion JPEG or JPEG - Regularly Refresh. Motion JPEG enables you to view the image like a motion video, and JPEG - Regularly Refresh can be set the refresh interval.

Enter "**http://IP Address (or URL):Port No.**" on the web browser.  
When port number is 80 (default), you do not need to enter port number. Then Top Page appears.

### Example

- Accessing Top Page using port number 80 (default)  
**http://192.168.0.253**
- Accessing Top Page using port number 81  
**http://192.168.0.253:81**
- Accessing Top Page with Global IP address from outside network in **Internet Connection** on page 18.  
**http://Global IP address of Broadband Router:PortNo.**

### Top Page

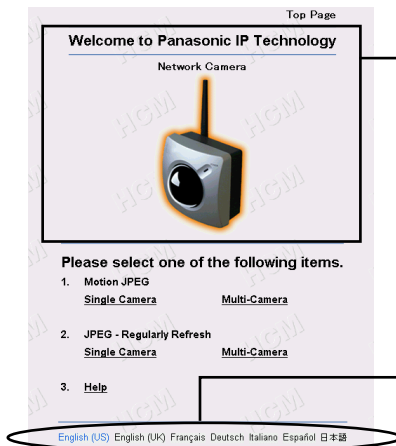

Top Page title and Network Camera picture can be changed and the link can be set on the picture. Refer to page 68.

Click the language to change the display. Top Page, Single Camera and Multi-Camera screens also display the selected language.

### Note

The initial language displayed at the first access can be selected on Top View Image Setting window on page 68.

**Notes**

- If a port number is specified in the IP address, "**http://**" must precede the IP address, otherwise the port number will not be recognized.
- When viewing images for the first time in the Internet Explorer, a pop-up **Security Warning window** may appear. The window requests your permission to download ActiveX Controls (OCX file) used to display Motion JPEG. Refer to page 43.

<b>Motion JPEG</b>	The image refreshes continuously (up to 15 frames per second) like a motion video.
<b>JPEG - Regularly Refresh</b>	The image refreshes periodically. The refresh interval can be set up at <b>Top View Image Setting window</b> on page 68. JPEG - Regularly Refresh is suggested when using dial-up Internet connections or network connections offering limited bandwidth.
<b>Single Camera</b>	Selecting this link in either Motion JPEG or JPEG - Regularly Refresh can display images of the individual Network Camera you are currently connecting to. Refer to page 44.
<b>Multi-Camera</b>	Selecting this link in either Motion JPEG or JPEG - Regularly Refresh can display images of four separate Network Cameras if configured. Information on this feature can be found on page 52 and page 85.
<b>Help</b>	Help page appears.

**Note**

Network Camera is designed to work with 10/100 Mbps networks, cable modems or xDSL Internet connections. 56K dial-up connection may prevent the Motion JPEG to view smoothly. On some networks the available bandwidth may be intentionally restricted to lock out streaming video services. JPEG - Regularly Refresh solves the problem in the restricted bandwidth.

## ActiveX Controls

When viewing images for the first time in the Internet Explorer, a pop-up **Security Warning window** may appear. The window requests your permission to download ActiveX Controls (OCX file) used to display Motion JPEG. Allow the file to be installed. It is required and will not cause any problems with other applications on the PC. If **Security Warning window** appears, click **[Yes]**. When using Windows NT, Windows 2000 or Windows XP, log on with an appropriate account that is authorized to install applications.

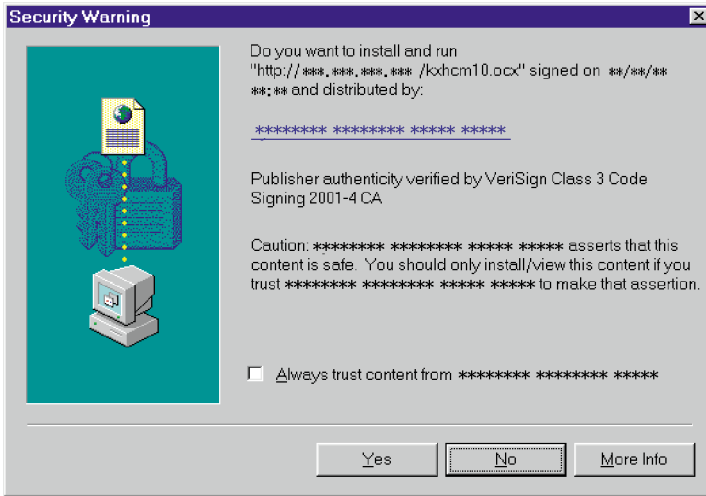

### If you cannot download ActiveX Controls or you cannot see the image in the Internet Explorer

- Click **[Tools]** → **[Internet Options]** → **[Security]** tab and click **[Custom level]** on the window.
  - (1) Check "Prompt" in "Download signed ActiveX Controls".
  - (2) Check "Enable" in "Run ActiveX Controls and plug-ins".
- ActiveX Controls can be also installed from the Setup CD-ROM.
  - (1) Restart the PC.
  - (2) Confirm that Internet Explorer is closed.
  - (3) Double-click the "ocx\ActiveXInst.exe" on the Setup CD-ROM.

### 3.3 Single Camera Screen

Single Camera can move the lens by the **Pan/Tilt operation**, **Preset Positioning** and **Click to Center**. Single Camera screen can be set eight preset positions. **[Viewer]** links to the Buffered Image screen.

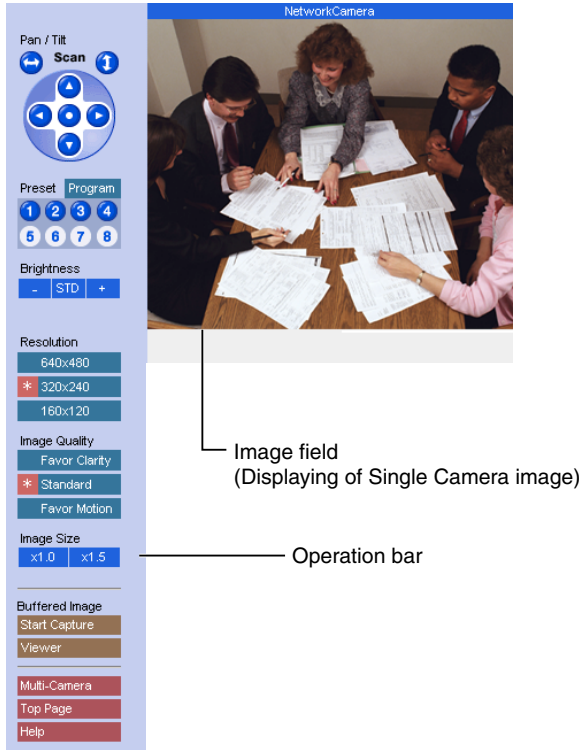

#### Notes

- The Screen Saver can prevent the PC monitor from burning in displaying the same image.
- Selecting a resolution of 640 x 480 will result in a slight loss of speed when viewing Motion JPEG. Selecting 320 x 240 offers the good compromise between speed and resolution.

## Click to Center

When you click the certain point on the Single Camera screen, the point is centered on the image.

1. Put the cursor on the point which should be centered and click it.



2. The clicked point is centered.



### Note

**Click to Center** does not move over the end of corner when the Pan/Tilt range reaches the end. The Pan/Tilt operation can be locked by Pan/Tilt control on page 82.

### 3.3.1 Using Operation Bar

Operation bar controls the general use of Network Camera. The following sections describe the general way of using it.



- (1) **End Display:** When Pan/Tilt operation has reached the end of corner, **Left End**, **Right End**, **Up End** or **Down End** appears.  
**Locked Display:** Pan/Tilt/Preset, Brightness Control and Preset program can be locked. **Locked** appears when the operation bar is clicked.  
**Preset Display:** Preset name appears when clicking Preset Button.
- (2) **Pan/Tilt Scan, Pan/Tilt and Home Position:** Refer to page 47.
- (3) **Preset Buttons:** Refer to page 48.
- (4) **Brightness:** Brightness control has nine steps including **[STD]** (Standard). Clicking **[-]** and **[+]** buttons changes the brightness of image. Brightness can be locked on Camera Setup window on page 82.
- (5) **Resolution:** **[640 x 480]**, **[320 x 240]** (default) or **[160 x 120]**
- (6) **Image Quality:** **[Favor Clarity]** optimizes the image for good clarity. **[Standard]** keeps the standard quality. **[Favor Motion]** optimizes the image for motion display.
- (7) **Image Size:** The default image size is x 1. **[x 1.5]** expands only the size. The resolution does not change.
- (8) **Buffered Image:** **[Start Capture]** starts buffering the image. **[Viewer]** links to the Buffered Image screen on page 50. Each button changes to **[Primary]** and **[Secondary]** button when using Image Transfer feature.
- (9) **Link Buttons:** Each buttons link to the Multi-Camera screen, Top Page and Help Page.

### 3.3.2 Using Pan/Tilt Operation

Pan/Tilt scan buttons automatically move the lens horizontally from  $-60^{\circ}$  to  $+60^{\circ}$  and vertically from  $0^{\circ}$  to  $-45^{\circ}$ , and the lens returns to the current position. Use Click to Center feature to stop scanning. Each surrounding arrow of Pan/Tilt moves the lens Up, Down, Right, Left, and the home position button moves it to Home Position.

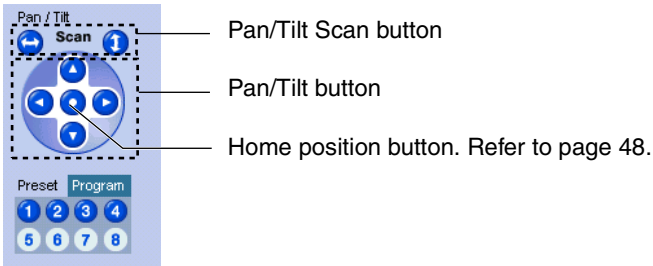

#### Note

Pan/Tilt operation can be locked on Camera Setup window on page 82.

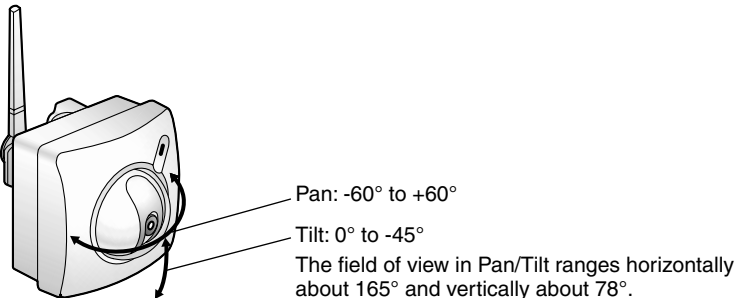

#### Notes

- Pan/Tilt Range can be selected on Camera Setup window on page 82.
- When the power is on, do not manually revolve the Pan/Tilt. Revolving it forcibly or moving it manually by some mistake may damage the Pan/Tilt operation, or change the registered Pan/Tilt positions from actual ones. Restart Network Camera when the latter case happens.
- Do not touch the Lens Cover. Touching it may leave a fingerprint and can cause the image to be out of focus.

### 3.3.3 Setting Preset Positioning and Home Positioning

**Preset positioning and Home Positioning** allow you to fix the lens on a specific point. This feature can memorize Brightness and White Balance settings. The preset buttons (1—4) are registered in the factory default.

**(1: Upper Left, 2: Upper Right, 3: Lower Left, 4: Lower Right)**

All eight preset buttons and home position button can be overridden. Lens moves to the preset/home position when clicking each registered button. Blue/White buttons mean Registered/Not registered. Camera Setup window on page 82 can lock the Preset/Home Positioning features.

#### Registering or modifying the preset buttons or home position button

- 1) Click **[Program]**. Red cancel button appears.
  - **[Cancel]** returns to the Single Camera screen.
- 2) Move the lens to a desired position using Pan/Tilt operation.
- 3) Select the preset number or home position button to register or modify.
  - After registering or modifying the home position button, "Success!" appears on the display. Go to step 7.
- 4) Enter the name of the preset button.
  - Max. 15 characters
  - Refer to unavailable character set 1 on page 108.
  - Refer to displayable character set on page 109.
- 5) Click **[Save]**.
  - **[Cancel]** returns to the Single Camera screen without saving.
- 6) Registered preset button turns blue.
  - Go back to step 2 to register or modify other preset buttons.
- 7) Click **[Cancel]** when finished.

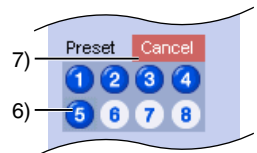
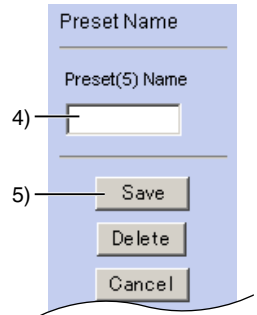
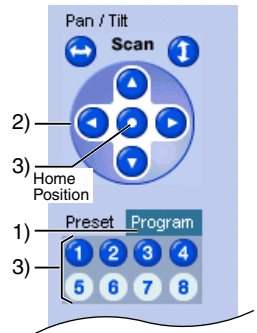



### Deleting the preset buttons

- 1) Click **[Program]**. Red cancel button appears.
  - **[Cancel]** links to the Single Camera screen without deleting.
- 2) Select the preset number to delete.
- 3) Click **[Delete]**.
  - **[Cancel]** links to the Single Camera screen without deleting.
- 4) Deleted preset button turns white.
  - Go back to step 2 to delete other preset buttons.
- 5) Click **[Cancel!]** when finished.

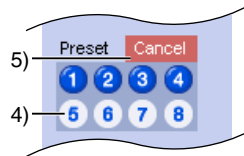
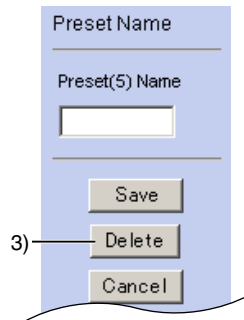
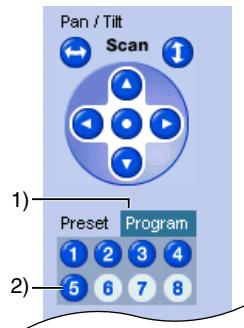

### 3.3.4 Viewing Buffered Image Screen

Buffered Image screen can be viewed by clicking **[Viewer]** on the operation bar. Buffered Image is saved in the internal memory of Network Camera by clicking **[Start Capture]**. Alarm/Timer mode in the Image Transfer on page 70 can also buffer the image. Buffered Image is erased by power off, restarting, Update Firmware, resetting to Factory Default and when Image Transfer or Name/Time window is saved and clicking **[Start Capture]**.

**Buffered Image**

---

1. **Buffered Image Viewer**

No. 1 Date:Jan. 1,2003 12: 0:00.000 AM



2. [Single Camera](#)

3. [Top Page](#)

4. [Help](#)

The image number, date and time are displayed.  
 (The example shows 12h 0min 0s 000ms on January 1st, 2003)

**[Play]**  
 The buffered images are displayed continuously.

**[<Prev] & [Next>]**  
 The previous image or next image is displayed.

**[<10] & [10>]**  
 The 10th image before or after the image is displayed.

**[<100] & [100>]**  
 The 100th image before or after the image is displayed.

Operation bar of the Single Camera screen changes in the Image Transfer mode. **[Start Capture]** and **[Viewer]** are displayed in the Non Transfer mode. **[Primary]** and **[Secondary]** are displayed in the Alarm/Timer mode. Refer to page 70 about the Image Transfer feature.

Non Transfer mode	Alarm/Timer mode
<div style="border: 1px solid gray; padding: 5px; margin: 5px;"> <p>Buffered Image</p> <p>Start Capture</p> <p>Viewer</p> </div>	<div style="border: 1px solid gray; padding: 5px; margin: 5px;"> <p>Buffered Image</p> <p>Primary</p> <p>Secondary</p> </div>

- [Start Capture]** : **[Start Capture]** saves the individual images to the internal memory. Network traffic, PC performance, image quality and image resolution influence **[Play] mode** time and the refresh interval of the image. The resolution is the same as the current image settings. At a resolution of 320 x 240 in standard, Network Camera stores approximately 560 frames.
- [Viewer]** : **[Viewer]** enables you to view the buffered image by clicking **[Start Capture]**.
- [Primary]** : **[Primary]** enables you to view the buffered image in the primary time in the Alarm/Timer mode.
- [Secondary]** : **[Secondary]** enables you to view the buffered image in the secondary time in the Alarm/Timer mode.

#### Notes

- The refresh interval becomes longer as more clients access Network Camera.
- The image resolution, image quality and object situation affect the number of frames in the Buffered Image.
- If internal memory is filled after clicking **[Start Capture]**, the image buffering will stop automatically.

#### To save still images on your PC

The PC can save still images taken by JPEG - Regularly Refresh and Buffered Image. The refresh interval of JPEG - Regularly Refresh should be 30 seconds or more in saving the image.

To save the image, place the cursor on the image and click the right button of the mouse. Then select "Save Picture As...". Enter a picture name and save.

#### Note

The PC cannot save Motion JPEG and **[Play] mode** images of Buffered Image.

### 3.4 Multi-Camera Screen

Four separate Network Camera images can be displayed in both Motion JPEG and JPEG - Regularly Refresh. The Pan/Tilt operation cannot be operated on the Multi-Camera screen. You can jump to each individual Network Camera by clicking Camera Name. The Single Camera screen has the Pan/Tilt operation, which can reflect on the Multi-Camera screen.

Refer to page 85 for how to configure each Network Camera.

**Multi-Camera (Normal size : 320x240)**

Link to each Single Camera when clicking Camera Name.

Image Field (Displaying Multi-Camera Image)

Changes the image size.

[Multi-Camera \(Small size : 180x120\)](#)  
[Top Page](#)

#### Notes

- On the Multi-Camera screen, the maximum image resolution is limited to 320 x 240.
- Motion JPEG stops on the Multi-Camera screen if Limit time of Continuous Motion JPEG is set up at a Network Camera.
- When refresh interval is slow, it can be improved by using an Ethernet switching hub instead of the repeater hub or restricting the Max. Bandwidth Usage on **Network window** on page 58. Refer to page 126 for other solutions.
- Multi-Camera screen can also display the images of Panasonic Network Cameras (KX-HCM series).

## 3.5 Setup Page

**Setup Page** controls all features of Network Camera. Authentication window protects the Network Camera security. It enables only administrator to access Setup Page by entering ID and Password.

Enter "**http://IP Address (or URL):Port No./config.html**" on the web browser and press **[Enter]**. When port number is 80 (default), you do not need to enter port number. Then Setup Page appears.

### Example

- Accessing Setup Page using port number 80 (default)  
**http://192.168.0.253/config.html**
- Accessing Setup Page using port number 81  
**http://192.168.0.253:81/config.html**
- Accessing Setup Page with Global IP address from outside network in **Internet Connection** on page 18.  
**http://Global IP address of Broadband Router:Port No./config.html**

## Setup Page

**Panasonic**  
Network Camera

**Setup Page**  
**Welcome to Panasonic IP Technology**

(1) Go to Top Page

**Basic**

(2) Network  
(3) Name/Time  
(4) Security: Administrator  
(5) Security: General User  
(6) Top View Image

**Transfer**

(7) Image Transfer

**Additional**

(8) Camera Setup  
(9) Multi-Camera  
(10) External Output Control  
(11) Indicator Control

**Maintenance**

(12) Status  
(13) Restart  
(14) Update Firmware  
(15) Reset to Factory Default  
(16) Help

Network Camera Version \*\*\*  
Version number

**Please Select an item on the left.**

### Note

Firmware Version number indicated on Setup Page is important for your future support of Network Camera.

Item	Description
<b>(1) Go to Top Page</b>	Links to Top Page. You can access Single/Multi-Camera screen in Motion JPEG/JPEG - Regularly Refresh. Refer to page 57.
<b>(2) Network</b>	Configures the network setting (Wireless network parameters, Static/DHCP, Default Gateway, Port Number, DNS, DDNS and Bandwidth). Refer to page 58.
<b>(3) Name/Time</b>	Sets the Camera Name on the Single Camera screen. Date and Time is used in the Alarm/Timer mode in the Image Transfer feature and On the Air time setting on Top View Image Setting window. NTP automatically adjusts the internal clock of Network Camera. Refer to page 62.
<b>(4) Security: Administrator</b>	Sets administrator ID and password. Authentication window can be enabled. Administrator should control Network Camera. Refer to page 64.
<b>(5) Security: General User</b>	Sets general user ID and password. General user is the registered user. Refer to page 66.
<b>(6) Top View Image</b>	Sets the initial language, Title, Image URL, Link URL, the image resolution, image quality, refresh interval and the Limit time of Continuous Motion and On the Air time. Top View Image screen consists of Single Camera and Multi-Camera screen. Refer to page 68.
<b>(7) Image Transfer</b>	Enables the Alarm/Timer mode in the Image Transfer feature. Network Camera can transfer the image via E-mail or FTP. The alarm/timer trigger can be set on Image Transfer window. Refer to page 70.
<b>(8) Camera Setup</b>	Sets White Balance and Power Line Frequency. You can lock the Brightness, Pan/Tilt/Preset and Preset Program Control features. You can also select Pan Range and Tilt Range. Refer to page 82.

Item	Description
<b>(9) Multi-Camera</b>	The Multi-Camera screen needs to set up these parameters. Enter the Camera Names and IP addresses of each Network Camera. The Multi-Camera can display up to four images in a window. Refer to page 85.
<b>(10) External Output Control</b>	Sets the External Device Control Output setting to attach external sensors/devices. (Open or Short to GND) Refer to page 87 and page 106.
<b>(11) Indicator Control</b>	Sets Indicator operation. Indicator will be turned on in the default. Refer to page 88.
<b>(12) Status</b>	Displays general information of Network Camera. Refer to page 89.
<b>(13) Restart</b>	Restarts Network Camera retaining any settings you entered. If any operational issues are changed, try this option first. Refer to page 90.
<b>(14) Update Firmware</b>	Updates the program to operate Network Camera on the latest version of the system. Refer to page 91.
<b>(15) Reset to Factory Default</b>	Initializes all the parameters to the factory default. Note that all customer-applied settings will be lost, requiring you to reconfigure Network Camera. Refer to page 94.
<b>(16) Help</b>	Provides you with detailed instructions of the terms and functions of Network Camera.



### 3.5.1 Go to Top Page

Click **[Go to Top Page]** on Setup Page. You can access the Single Camera and Multi-Camera screen in Motion JPEG/JPEG-Regularly Refresh.

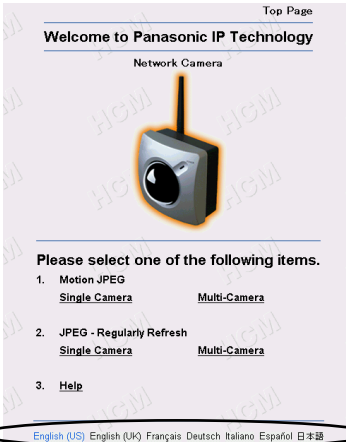

Click the language to change the display.

## 3.5.2 Network

**Network window** configures network parameters. Restart Network Camera to make the parameters effective.

- You can set disable Configuration window from the Setup CD-ROM for the security by clearing the check.

### 1. Click [Network] on Setup Page.

**1. Network Configuration from Setup Program**  Enable  
 After setting network configuration, you must set disable for network security.

**2. Wireless** [Status](#)  
 Mode: **Infrastructure** AdHoc  
 SSID:   
 Speed: Auto  
 Encryption: **None** 40 bit 128 bit

**3. Internet Connection**  
 Port No.: 80  
 Static  
 Enter the proper address (required)  
 IP Address: 192.168.0.253  
 Enter the proper mask (required)  
 Subnet Mask: 255.255.255.0  
 DHCP  
 Host Name:   
 Current IP Address: 192.168.0.253  
 Current Subnet Mask: 255.255.255.0

**4. Default Gateway**  
 In case of communication over the Gateway, you must enter the proper address.  
 Gateway:

**5. DNS**  
 In case of Host Name in E-Mail, FTP or Multi-Camera, you must enter the proper address.  
 DNS Server1:   
 DNS Server2:

**6. DDNS**  Enable  
 By registering DDNS service, you can create a personalized web address at which your camera's live video can be found on the internet.  
 Your E-Mail Address:   
 To register DDNS service, please enable "DDNS", fill "Default Gateway" and "DNS", set "your E-Mail Address" and click "Save". You will receive an introductory E-mail shortly. Please follow the instructions in the E-Mail to register.  
 Personal (Camera) URL:

**Your Account Link**

**7. Max Bandwidth Usage** Unlimited Mbps

Refer to page 32 for wireless network parameters.

2. Enter each parameter in the proper data field. Click [**Save**] when finished.
  - Click [**Cancel**] to quit the current settings. The window returns to Setup Page without saving the parameters.

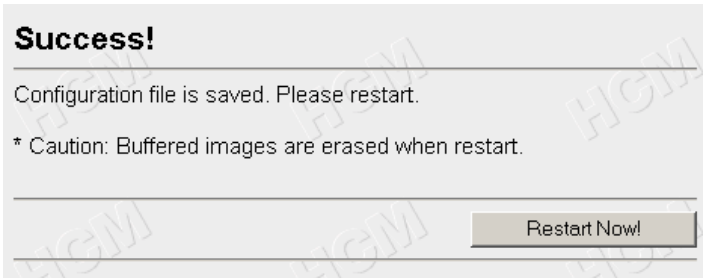

3. Click [**Restart Now!**] to restart to make the changed parameters effective.

#### Instructions for the data fields

Port No.	<ul style="list-style-type: none"> <li>• You can set up the port number of Network Camera. (Default is 80.) If you use more than one Network Camera with a broadband router on the network, each Network Camera must be assigned its own port number.</li> <li>• Refer to Port Forwarding feature on page 37.</li> <li>• Many ISP's intentionally block port number 80 to guard against certain network viruses. If your ISP blocks port number 80, substitute another unused port number.</li> <li>• Enter only the number. (1—65535)</li> </ul> <p><b>Note</b></p> <p>Certain port numbers assigned on the network devices, and the network protocol are not available e.g., FTP: 20, 21, Telnet: 23, SMTP: 25, DNS: 53, POP3: 110, HTTPS: 443, ICQ: 4000 and IRC: 6661—6667. The port numbers between 50000 and 59999 are recommended to use. To assign port numbers on a large network, consult and work with your ISP or administrator.</p>
----------	------------------------------------------------------------------------------------------------------------------------------------------------------------------------------------------------------------------------------------------------------------------------------------------------------------------------------------------------------------------------------------------------------------------------------------------------------------------------------------------------------------------------------------------------------------------------------------------------------------------------------------------------------------------------------------------------------------------------------------------------------------------------------------------------------------------------------------------------------------------------------------------------------------------------------------------------------

**Instructions for the data fields**

<p>Static</p> <ul style="list-style-type: none"> <li>• IP Address</li> <li>• Subnet Mask</li> </ul>	<ul style="list-style-type: none"> <li>• Check [Static], when having specified IP address assigned to Network Camera from your ISP or administrator. Enter the specified IP address and Subnet Mask.</li> <li>• If you use Network Camera on the LAN, set up in the same class as your PC is in. Refer to page 25 for the class.</li> <li>• Refer to page 108 for the IP addressing.</li> </ul>
<p>DHCP</p> <ul style="list-style-type: none"> <li>• Host Name</li> </ul>	<ul style="list-style-type: none"> <li>• Check [DHCP] (Dynamic Host Configuration Protocol), when your ISP uses the DHCP server function which assigns an IP address to Network Camera automatically. Enter the Host name. Follow the instructions of your ISP or administrator for the Host name.</li> <li>• Refer to unavailable character set 1 in page 108 for the Host name.</li> </ul>
<p>Default Gateway*<sup>a</sup></p>	<ul style="list-style-type: none"> <li>• If you have the specified Default Gateway address from your ISP or administrator, enter it in this data field.</li> <li>• Refer to page 108 for the IP addressing.</li> </ul>
<p>DNS Server*<sup>a</sup></p>	<ul style="list-style-type: none"> <li>• Set DNS server address when you use Host Name to register Network Camera on Multi-Camera window on page 85.</li> <li>• If you have the specified DNS server address from your ISP or administrator, enter it in this data field. You can set up two DNS server addresses.</li> <li>• Refer to page 108 for the IP addressing.</li> </ul>

### Instructions for the data fields

<p>DDNS</p> <ul style="list-style-type: none"> <li>• Your E-mail Address</li> <li>• Personal (Camera) URL</li> <li>• Your Account Link</li> </ul>	<ul style="list-style-type: none"> <li>• If your ISP specified IP address of Cable/xDSL modem is not static, you need to contract to DDNS (Dynamic Domain Name System) service. Check DDNS Enable, enter Your E-Mail Address and refer to an attached leaflet for DDNS service.</li> <li>• By enabling DDNS service <b>viewnetcam.com</b>, you can create a personalized web address (for example, bob.viewnetcam.com) at which your camera's live video can always be found on the Internet. The E-Mail address you entered will be automatically informed to <b>viewnetcam.com</b> for managing and supporting your account, improving services, and for marketing and promotional purposes.</li> <li>• Refer to unavailable character set 2 in page 108 for the e-mail address.</li> </ul>
<p>Max. Bandwidth Usage</p>	<ul style="list-style-type: none"> <li>• It can restrict the transmit bandwidth.</li> <li>• Select the max bandwidth usage from 0.1 Mbit/s to Unlimited Mbit/s.</li> <li>• Refer to the next File size of the image.</li> </ul>

\*<sub>a</sub> If you automatically get the address from DHCP server, you do not need to set up.

### File size of the image

The internal memory, image resolution, image quality and object situation determine the maximum number of frames. File sizes change depending on the image quality and object situation. (Brightness, etc.)

For example, the image size per frame in the image resolution is as follows. (When the image quality is Standard)

160 x 120: about 2.7 Kbytes (22 Kbits)

320 x 240: about 10 Kbytes (80 Kbits)

640 x 480: about 18 Kbytes (144 Kbits)

### 3.5.3 Name/Time

**Name/Time window** is used to assign a name to each Network Camera. Date and Time entered on Name/Time window are used for the Alarm/Timer mode in the Image Transfer feature and on the Buffered Image screen. NTP automatically adjusts the internal clock of Network Camera.

1. Click [**Name/Time**] on Setup Page.

2. Enter the Camera Name and Date and Time. Click [**Save**] when finished.
  - Click [**Cancel**] to quit the current settings. The window returns to Setup Page without saving the parameters.

#### Instructions for the data fields

<p><b>Camera Name</b></p>	<p>The Camera Name appears on the Single Camera screen.</p> <ul style="list-style-type: none"> <li>• Refer to unavailable character set 1 on page 108.</li> <li>• Refer to displayable character set on page 109.</li> </ul>
<p><b>Date and Time</b></p>	<p>First click [<b>AM/PM</b>] or [<b>24H</b>]. The display changes in each time mode.</p> <p><b>Note</b> Time setting will be affected by the temperature. Time setting may lose one minute per month in 25 °C (77 °F) condition. It may lose five minutes in a colder or hotter condition. Please use <b>Auto Adjustment</b> feature when Network Camera is installed where the temperature changes hugely in daytime and night-time.</p>

### Instructions for the data fields

<b>Date and Time</b>	<ul style="list-style-type: none"> <li>• Time stamp on the Buffered Image screen can be changed [<b>AM/PM</b>] or [<b>24H</b>].</li> <li>• Only 24 h time mode is used in the Alarm/Timer mode in the Image Transfer feature.</li> </ul>
<b>Auto Adjustment</b>	<p>NTP (Network Time Protocol) Server synchronizes Network Camera internal clock. It adjusts automatically everyday. Check the box to enable NTP.</p> <ul style="list-style-type: none"> <li>• NTP Server Address or Host Name Ask your ISP or the network administrator for the NTP Server.</li> <li>• Select your Time Zone.</li> </ul> <p><b>Note</b> Daylight-saving Time (Daylight Time) is not set automatically. Select it manually.</p>

### Time Zone

GMT-10:00 Hawaii  
 GMT-09:00 Alaska, Hawaii Daylight Time  
 GMT-08:00 Pacific Time, Alaska Daylight Time  
 GMT-07:00 Mountain Time, Pacific Daylight Time  
 GMT-06:00 Central Time, Mountain Daylight Time  
 GMT-05:00 Eastern Time, Central Daylight Time (**default**)  
 GMT-04:00 Eastern Daylight Time  
 GMT 00:00 Western Europe Time  
 GMT+01:00 Central Europe Time, Middle Europe Time  
 GMT+02:00 Eastern Europe Time, Middle Europe Daylight Time  
 GMT+03:00 Baghdad  
 GMT+08:00 China Time, Western Australia Time  
 GMT+09:00 Japan Time  
 GMT+09:30 Central Australia Time  
 GMT+10:00 Eastern Australia Time  
 GMT+10:30 Central Australia Daylight Time  
 GMT+11:00 Eastern Australia Daylight Time

## 3.5.4 Security: Administrator

**Security: Administrator window** allows the administrator to limit or exclude access to the selected Network Camera. Individual levels of access can be defined for multiple users.

### Notes

- If Network Camera is to be accessed via the Internet, use authentication window for security. It will prevent your unauthorized person from changing any Network Camera parameters.
- Refer to page 65 for details about authentication security.

1. Click [**Security: Administrator**] on Setup Page.

### Security: Administrator

---

**1. Authentication Enable**

You should set up the Authentication Page for security.

None (Anyone can access all pages.)  
 Administrator Only (for Setup Page)  
 Administrator (for Setup Page) and General User (for Top Page)

**2. Administrator Authentication**

ID (4 to 15 Characters)

Password (4 to 15 Characters)

Retype Password

---

2. Enter each parameter in the proper data field. Click [**Save**] when finished.
  - Click [**Cancel**] to leave the current settings unchanged. The window returns to Setup Page without saving the parameters.
  - Restart to make **Security: Administrator window** settings effective to all Motion JPEG viewers.



**Instructions for the data fields**

<p><b>Authentication Enable</b></p>	<p>Authentication window can be set in the three patterns.</p> <p><b>None:</b> No authentication window appears. Anyone can access all screens (Single Camera/Multi-Camera screen) and pages (Top Page and Setup Page).</p> <p><b>Administrator only:</b> Authentication window appears when accessing Setup Page. Authentication window does not appear when accessing Top Page.</p> <table border="1" data-bbox="370 464 953 540"> <thead> <tr> <th></th> <th>Administrator</th> <th>General User</th> <th>Unregistered User</th> </tr> </thead> <tbody> <tr> <td>Top Page</td> <td>✓</td> <td>✓</td> <td>✓</td> </tr> <tr> <td>Setup Page</td> <td>✓</td> <td>—</td> <td>—</td> </tr> </tbody> </table> <p>✓ : Accessible — : Not accessible</p> <p><b>Administrator and General User:</b> Authentication window appears when accessing Setup Page for the administrator and Top Page for the general user.</p> <table border="1" data-bbox="370 688 953 764"> <thead> <tr> <th></th> <th>Administrator</th> <th>General User</th> <th>Unregistered User</th> </tr> </thead> <tbody> <tr> <td>Top Page</td> <td>✓</td> <td>✓</td> <td>—</td> </tr> <tr> <td>Setup Page</td> <td>✓</td> <td>—</td> <td>—</td> </tr> </tbody> </table> <p>✓ : Accessible — : Not accessible</p>		Administrator	General User	Unregistered User	Top Page	✓	✓	✓	Setup Page	✓	—	—		Administrator	General User	Unregistered User	Top Page	✓	✓	—	Setup Page	✓	—	—
	Administrator	General User	Unregistered User																						
Top Page	✓	✓	✓																						
Setup Page	✓	—	—																						
	Administrator	General User	Unregistered User																						
Top Page	✓	✓	—																						
Setup Page	✓	—	—																						
<p><b>Administrator Authentication for Setup Page</b></p>	<p><b>ID:</b> Enter the administrator ID. ID and Password are case sensitive.</p> <p><b>Password:</b> Enter the administrator password. The password should be difficult to guess and confidential. Refer to unavailable character set 1 on page 108.</p> <p><b>Note</b> Assign the ID and password to meet your specific security requirements. To maximize its effectiveness, keep the following contents.</p> <ul style="list-style-type: none"> <li>• Be sure the ID and password are different.</li> <li>• Make the ID and password as long and random as possible.</li> <li>• Periodically change the password.</li> </ul> <p><b>Retype:</b> Reenter the password to confirm. Do not copy the text.</p>																								

### 3.5.5 Security: General User

**Security: General User window** allows the administrator to create the general user ID and password for the security level defined as general user. Up to 30 individual user names can be defined. The various security levels are explained on page 65.

1. Click [**Security: General User**] on Setup Page.

The screenshot shows a window titled "Security: General User". Inside, there is a section for "General User Authentication". Underneath, it says "(1) User ID List (30 Users MAX)". There is a list box containing the text "\* Registered User \*". To the right of the list box are two buttons: "Delete" and "Modify". Below this is a section for "(2) New User". It contains three input fields: "ID (4 to 15 Characters)", "Password (4 to 15 Characters)", and "Retype Password". At the bottom right of the window are two buttons: "Save" and "Cancel".

2. Enter each parameter in the proper data field. Click [**Save**] when finished.
  - Click [**Cancel**] to leave the current settings unchanged. The window returns to Setup Page without saving the parameters.
  - Restart to make **Security: General User window** settings effective to all Motion JPEG viewers.

### Instructions for the data fields

<b>General User Authentication</b>	The General User can be up to 30. Each of them can have their own ID and password.
<b>(1) User ID List</b>	<ul style="list-style-type: none"> <li>• User ID List displays the registered user name.</li> <li>• <b>[Delete]</b> and <b>[Modify]</b> deletes/modifies the general user in the list. Select the desired user and click <b>[Delete]</b> or <b>[Modify]</b>.</li> </ul>
<b>(2) New User</b>	<p>Enter the general user ID, password and reenter the password to confirm. The password should be difficult to guess and confidential. <b>[Save]</b> registers the new user in the User ID List. ID and Password are case sensitive. Refer to unavailable character set 1 on page 108.</p> <p><b>Note</b></p> <p>Assign the ID and password to meet your specific security requirements. To maximize its effectiveness, keep the following contents.</p> <ul style="list-style-type: none"> <li>• Be sure the ID and password are different.</li> <li>• Make the ID and password as long and random as possible.</li> <li>• Periodically change the password.</li> </ul>

### 3.5.6 Top View Image

**Top View Image Setting window** can change settings for Top Page, Single Camera and Multi-Camera screen such as the initial language, the image resolution, image quality, refresh interval as the initial setting, **Limit time of Continuous Motion JPEG** and **On the Air time**.

1. Click **[Top View Image]** on Setup Page.

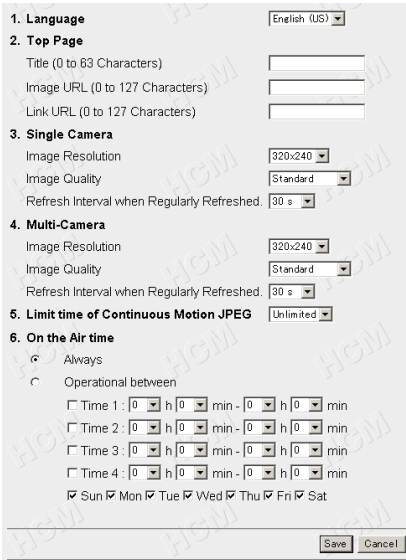

2. Select the each parameter. Click **[Save]** when finished.

- Click **[Cancel]** to quit the current settings. The window returns to Setup Page without saving the parameters.
- Restart to make **Limit Time of Continuous Motion JPEG** settings effective to all Motion JPEG viewers.

#### Instructions for the data fields

<b>Language</b>	Select the initial language from the list: English (US), English (UK), French, German, Italian, Spanish or Japanese. The selected language is displayed as the initial language on Top Page, Single Camera screen and Multi-Camera screen. All Setup windows are also changed when selecting English (US), English (UK) or Japanese. English (UK) is displayed on Setup windows when selecting French, German, Italian or Spanish.
-----------------	------------------------------------------------------------------------------------------------------------------------------------------------------------------------------------------------------------------------------------------------------------------------------------------------------------------------------------------------------------------------------------------------------------------------------------

### Instructions for the data fields

<b>Top Page</b>	<ul style="list-style-type: none"> <li>• Top Page title can be changed. Enter the new title. <ul style="list-style-type: none"> <li>• Refer to unavailable character set 1 on page 108 but [space] is available.</li> <li>• Refer to displayable character set on page 109.</li> </ul> </li> <li>• Network Camera picture on Top Page can be changed. Enter the URL (http://) to display the picture on the specified web site. <ul style="list-style-type: none"> <li>• Only [space] and [""] are unavailable in the ASCII character table on page 108.</li> </ul> </li> <li>• Network Camera picture on Top Page can be set the link to the specified web site. Enter the URL (http://). <ul style="list-style-type: none"> <li>• Only [space] and [""] are unavailable in the ASCII character table on page 108.</li> </ul> </li> </ul>
<b>Image Resolution</b>	<ul style="list-style-type: none"> <li>• <b>640 x 480</b> (cannot set on the Multi-Camera screen.)</li> <li>• <b>320 x 240</b> (default)</li> <li>• <b>160 x 120</b></li> </ul>
<b>Image Quality</b>	<ul style="list-style-type: none"> <li>• <b>Favor Clarity:</b> Image is optimized for good clarity.</li> <li>• <b>Standard:</b> Image quality is standard. (default)</li> <li>• <b>Favor Motion:</b> Image is optimized for enhanced motion display.</li> </ul>
<b>Refresh Interval</b>	<p>The refresh interval of JPEG - Regularly Refresh can be selected. Select the desired interval.</p> <ul style="list-style-type: none"> <li>• 10 seconds to 5 minutes</li> </ul>
<b>Limit time of Continuous Motion JPEG</b>	<p>To make the network traffic smooth, select the duration time to display Motion JPEG. When the timer expires, the image changes to JPEG - Regularly Refresh.</p> <ul style="list-style-type: none"> <li>• 10 seconds to Unlimited</li> </ul>
<b>On the Air time</b>	<p>Specifies the timetable to allow users to access Top View Image screen. When you access the image except the specified time, blue screen appears.</p> <ul style="list-style-type: none"> <li>• <b>Always:</b> Always allows users to access.</li> <li>• <b>Operational between:</b> Specifies the date and time to access the image.</li> </ul>

### 3.5.7 Image Transfer

**Image Transfer window** can set the Image Transfer feature. Network Camera can buffer images and send the images via e-mail or FTP. The request to send the image is initiated by a contact closure from the external sensors/devices connected to the External I/O using the Alarm mode. The external sensors/devices are customer provided. The images can also be sent in the interval of time using the Timer mode. Make sure Date and Time has been configured. Refer to page 62 about Date and Time.

**Note**

When you use FTP or e-mail in transferring the image, you need to set Default Gateway and DNS Server address.

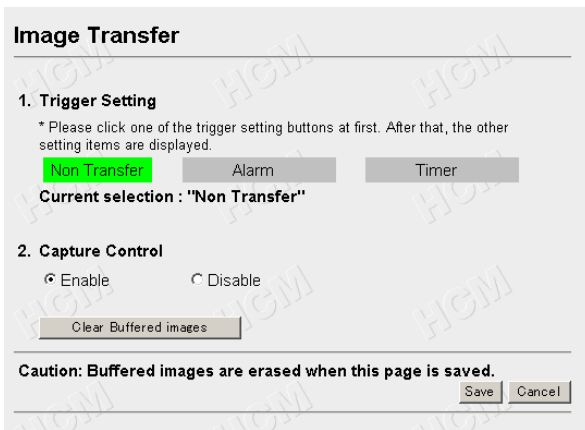

**Non Transfer** : Image Transfer feature is not in use.

**Alarm mode** : The alarm trigger activates transferring the image. Refer to page 72.

**Timer mode** : The timer trigger activates transferring the image. Refer to page 78.

**Note**

The Alarm and Timer mode cannot be set at the same time.

## Non Transfer mode

Non Transfer mode enables **[Start Capture]** on the operation bar to buffer the image on the Single Camera screen. Refer to page 50. Capture Control can lock **[Start Capture]** on the operation bar to prevent the user from capturing the Buffered Image. Click **[Clear Buffered images]** to clear the buffered image. **[Clear Buffered images]** does not save the parameters.

1. Click **[Image Transfer]** on Setup Page.

**Image Transfer**

---

**1. Trigger Setting**

\* Please click one of the trigger setting buttons at first. After that, the other setting items are displayed.

**Non Transfer**    Alarm    Timer

Current selection : "Non Transfer"

**2. Capture Control**

Enable     Disable

Clear Buffered images

---

Caution: Buffered images are erased when this page is saved.

Save    Cancel

2. Select the each parameter. Click **[Save]** when finished.
  - Click **[Cancel]** to quit the current settings. The window returns to Setup Page without saving the parameters.

## Transfer in the Alarm Mode

The Alarm mode can transfer an image via e-mail or FTP when the alarm trigger is active. To activate the alarm trigger, the External Sensor Input of External I/O must be connected with the external sensors/devices. The Alarm mode can send the e-mail without transferring the image. The Alarm mode uses the Network Camera internal clock. Make sure Date and Time has been configured. Refer to page 62 about Date and Time.

1. Click [Alarm] on Image Transfer window.

### Image Transfer

---

**1. Trigger Setting**

\* Please click one of the trigger setting buttons at first. After that, the other setting items are displayed.

**a.** — Current selection: "Alarm"

**b.** — **2. Active Time of Trigger**

(1) Primary Time

Always

Operational between

Start:  h  min  s

Stop:  h  min  s

Sun  Mon  Tue  Wed  Thu  Fri  Sat

Alarm enable condition  ▼

**c.** — (2) Secondary Time  Enable

\* Secondary Time is only active outside of the time period established for Primary Time.

Alarm enable condition  ▼

**d.** — **3. Image Setting**

(1) Image Resolution  ▼

(2) Image Quality  ▼

**4. Image Buffer Frequency Setting**

**e.** — (1) Pre-alarm Image Buffer  Enable

**f.** — Image Frequency  Images per  ▼

Maximum number of images per each trigger  ▼

(2) Post-alarm Image Buffer  Enable

Image Frequency  Images per  ▼

Maximum number of images per each trigger  ▼



**Instructions for the data fields**

- a.** External Sensor Input of External I/O activates the alarm trigger. Refer to page 106.
- b. Active Time of Trigger**  
The active trigger time can be set in the primary time and the secondary time. The secondary time is the supplement of the primary time.  
**Always:** always activates the alarm trigger.  
**Operational between:** Sets the start and stop time of the primary time. The day of the week can be set by checking. Start and stop time is set only in 24 h time mode.  
**Alarm enable condition:**  
Select the [Rising] (GND to Open High) or [Falling] (Open High to GND) of External Sensor Input of the External I/O.
- c. Secondary time** is active trigger time except the primary time.  
**Alarm enable condition:**  
Select the [Rising] (GND to Open High) or [Falling] (Open High to GND) of External Sensor Input of the External I/O.
- d.** Sets the **image resolution** and **image quality**.  
Image resolution: 640 x 480/320 x 240/160 x 120  
Image quality: Favor Clarity/Standard/Favor Motion
- e.** The Pre or Post trigger or both can be set on the Buffered Image. Check the box.
- f. Image Frequency:** Sets the interval to send the image.  
**Maximum number of images per each trigger:**  
Selects the number of buffering frames from numbers 1 to 3000.

**a. — 5. Transfer Method**

Non Transfer without Memory Over Write  
 Non Transfer with Memory Over Write  
 FTP

Server Address or Host Name   
 Port No. (Usually Use 21)   
 Login ID (0 to 63 Characters)   
 Password (0 to 63 Characters)   
 Login timing   
 Upload File Name   
 Over write setting   
 Data transfer method

**b. —**  Mail

SMTP Server Address or Host Name   
 POP3 Server Address or Host Name   
 Login ID (0 to 63 Characters)   
 Password (0 to 63 Characters)   
 From (Reply)   
 To   
 Subject   
 Text

**c. — 6. Notification to be sent when Alarm occurs**

No Message  
 Mail

SMTP Server Address or Host Name   
 POP3 Server Address or Host Name   
 Login ID (0 to 63 Characters)   
 Password (0 to 63 Characters)   
 From (Reply)   
 To   
 Subject   
 Text

Clear Buffered images

Caution: Buffered images are erased when this page is saved.

Save Cancel

**a. Selects Transfer Method.**

**Non Transfer without Memory Over Write:**

Image buffering will stop when the internal memory is full.

**Non Transfer with Memory Over Write:**

Buffered image will overwrite the older image data when the internal memory is full.

**FTP:** Enters the server address\*<sup>1</sup> or Host Name\*<sup>2</sup>, Port Number (1—65535), Login ID\*<sup>2</sup> and password\*<sup>2</sup> to access the FTP server and upload file name\*<sup>2</sup> including full path. Time in 24 h mode is attached on the upload file name.

**Login timing:**

[Every Time] or [One Time] can be selected. When selecting [Every Time], Network Camera repeats logging in and out with each transfer of one image. When selecting [One Time], Network Camera stays logged in until the transfer of all images is completed. Select [One Time] when transferring many images in short duration time.

**Over write setting:**

Selects [Over Write...] to overwrite the transferred image or [Add time...] to save each transferred image.

**Data transfer method:**

Use [Passive Mode] normally. If FTP does not work properly, ask your ISP or network administrator about the transferring mode of FTP server. [Passive Mode] or [Active Mode] is available.

- b. Mail:** Sets the SMTP and POP3 server address\*<sup>1</sup> or Host Name\*<sup>2</sup>, Login ID\*<sup>2</sup> and Password\*<sup>2</sup>.  
 From (Reply)\*<sup>3</sup>: Enter the e-mail address of [Reply-to]. [To] can be the same address as From (Reply).  
 To \*<sup>3</sup>: Enter the e-mail address of receiver.  
 Subject & Text \*<sup>4</sup>: Sets the subject and text of the e-mail.  
 Time in 24 h mode is attached on the subject.

**Notes**

- Set POP3 server address or Host Name, Login ID and Password if you need POP authentication to send the e-mail. Ask your ISP or administrator.
- Network Camera will only operate correctly with SMTP (Simple Mail Transfer Protocol) server. It is not available with Internet-accessed mail servers like "Hotmail®" or other mail accounts accessed via web browser.

- c.** Select [No Message] or [Mail]

**Mail:** Only the notification e-mail is sent when the alarm trigger is active. Refer to **b. Mail** for each parameter.

\*<sup>1</sup> Refer to IP addressing on page 108.

\*<sup>2</sup> Refer to unavailable character set 1 on page 108.

\*<sup>3</sup> Refer to unavailable character set 2 on page 108.

\*<sup>4</sup> Only ["] is unavailable in the ASCII character table on page 108 and refer to displayable character set on page 109.

- 2.** Select/Enter the each parameter. Click [**Save**] when finished.

- Click [**Cancel**] to quit the current settings. The window returns to Setup Page without saving the parameters.
- Click [**Clear Buffered images**] to clear the buffered image. [**Clear Buffered images**] does not save the parameters.

## Setting Example

**2. Active Time of Trigger**

(1) Primary Time  
 Always  
 Operational between  
 Start:  h  min  s  
 Stop:  h  min  s  
 Sun  Mon  Tue  Wed  Thu  Fri  Sat  
 Alarm enable condition

**a.** —————

(2) Secondary Time  Enable  
 \* Secondary Time is only active outside of the time period established for Primary Time.  
 Alarm enable condition

**b.** —————

**3. Image Setting**

(1) Image Resolution   
 (2) Image Quality

**c.** —————

**4. Image Buffer Frequency Setting**

(1) Pre-alarm Image Buffer  Enable  
 Image Frequency  Images per   
 Maximum number of images per each trigger

(2) Post-alarm Image Buffer  Enable  
 Image Frequency  Images per   
 Maximum number of images per each trigger

**d.** —————

**5. Transfer Method**

Non Transfer without Memory Over Write  
 Non Transfer with Memory Over Write  
 FTP

**e.** —————

Server Address or Host Name   
 Port No. (Usually Use 21)   
 Login ID (0 to 63 Characters)   
 Password (0 to 63 Characters)   
 Login timing   
 Upload File Name   
 Over write setting   
 Data transfer method

Mail

SMTP Server Address or Host Name   
 POP3 Server Address or Host Name   
 Login ID (0 to 63 Characters)   
 Password (0 to 63 Characters)   
 From (Reply)   
 To   
 Subject   
 Text

**6. Notification to be sent when Alarm occurs**

**f.** —————

No Message  
 Mail

SMTP Server Address or Host Name   
 POP3 Server Address or Host Name   
 Login ID (0 to 63 Characters)   
 Password (0 to 63 Characters)   
 From (Reply)   
 To   
 Subject   
 Text

**Setting explanation**

- a.** The active time of trigger is set between 9:00 AM to 6:00 PM from Monday to Friday.  
When the alarm occurs in the setting time, the images are transferred to FTP server, and the notification is sent to the specified user via e-mail.  
The alarm trigger is on when the sensor signal is changed to the [Rising] (GND to Open High) of External Sensor Input of External I/O.
- b.** The secondary time is set inactive.
- c.** The transferring image size is 160 x 120, and the image quality is standard.
- d.** Enables the Pre-alarm and Post-alarm Image Buffering:  
Network Camera will transfer Pre-alarm 10 images by one image per minute and Post-alarm 20 images by one image per second when detecting the alarm trigger.
- e.** Setting of FTP server:  
IP Address — 192.168.0.20  
Port No. — 21  
Login ID — Panasonic  
Password — \*\*\*\*\*  
Login timing: Every Time  
Upload File name — NetworkCamera  
File name and time stamp is named to the file.  
(Example: NetworkCamera20030101093000000.jpg)  
Underlined numbers are "9 h 30 min 00 s 000 ms on January 1, 2003".  
Data transfer method — Passive Mode
- f.** SMTP server address — xxx.xxx.com  
POP3 server address — xxx.xxx.com  
Login ID — Panasonic  
Password — \*\*\*\*\*  
Mail is sent to "NetworkCamera@xxx.xxx.com" from "Panasonic@xxx.xxx.com".  
Subject is [Mail Transfer].  
Text is [Alarm was generated].

## Transfer in the Timer Mode

The timer mode can be activated by entering the active time, the image setting, frequency setting and the transfer method on **Image Transfer window**. Buffered Image can also be transferred via e-mail or FTP. The timer mode uses the Network Camera internal clock. Make sure Date and Time has been configured. Refer to page 62 about Date and Time.

1. Click **[Timer]** on Image Transfer window.

**Image Transfer**

**1. Trigger Setting**  
 \* Please click one of the trigger setting buttons at first. After that, the other setting items are displayed.

**a. —** Current selection: "Timer"

**b. — 2. Active Time of Trigger**

(1) Primary Time

- Always
- Operational between
  - Start:  h  min  s
  - Stop:  h  min  s
  - Sun  Mon  Tue  Wed  Thu  Fri  Sat

**c. —** (2) Secondary Time  Enable  
 \* Secondary Time is only active outside of the time period established for Primary Time.

**3. Image Setting**

**d. —** (1) Image Resolution

(2) Image Quality

**4. Image Buffer Frequency Setting**

**e. —** (1) Primary Image Buffer Frequency  
 Images per

(2) Secondary Image Buffer Frequency  
 Images per

**Instructions for the data fields**

**a.** Buffers or transfers by the timer trigger.

**b. Active Time of Trigger**

**Always:** always activates the timer trigger. The timer trigger interval can be set in **e. Image Buffer Frequency Setting**.

**Operational between:** Sets the start and stop time of the primary time. The day of the week can be set by checking. If the setting time passes over midnight, check the check box of only the day of start time. Start and stop time is set only in 24 h time mode.

**Note**

The first image is buffered or transferred at the start time. The later images are buffered or transferred at the interval of the **e. Image Buffer Frequency Setting**.

**c. Secondary time** is active except the primary time.

The timer trigger interval in the secondary time can be set in **e. Image Buffer Frequency Setting**.

**d.** Sets the **image resolution** and **image quality**.

Image resolution: 640 x 480/320 x 240/160 x 120

Image quality: Favor Clarity/Standard/Favor Motion

**e. Image Frequency:** Sets the interval to send the image.

**Note**

Short interval of Image Buffer Frequency makes Network Camera transfer the older images. Set the interval long enough to transfer the images. Buffered Image screen enables you to check this setting.

**a. — 5. Transfer Method**

Non Transfer without Memory Over Write  
 Non Transfer with Memory Over Write  
 FTP

Server Address or Host Name   
 Port No. (Usually Use 21)   
 Login ID (0 to 63 Characters)   
 Password (0 to 63 Characters)   
 Login timing   
 Upload File Name   
 Over write setting   
 Data transfer method

**b. —  Mail**

SMTP Server Address or Host Name   
 POP3 Server Address or Host Name   
 Login ID (0 to 63 Characters)   
 Password (0 to 63 Characters)   
 From (Reply)   
 To   
 Subject   
 Text

**Caution: Buffered images are erased when this page is saved.**

**a. Selects Transfer Method.**

**Non Transfer without Memory Over Write:**

Image buffering will stop when the internal memory is full.

**Non Transfer with Memory Over Write:**

Buffered image will overwrite the older image data when the internal memory is full.

**[Primary]** or **[Secondary]** on the operation bar can be displayed to view the Buffered Image screen in Non Transfer setting.

**FTP:** Enters the server address\*<sup>1</sup> or Host Name\*<sup>2</sup>, Port Number (1—65535), Login ID\*<sup>2</sup> and password\*<sup>2</sup> to access the FTP server and upload file name\*<sup>2</sup> including full path. Time in 24 h mode is attached on the upload file name.

**Login timing:**

[Every Time] or [One Time] can be selected. When selecting [Every Time], Network Camera repeats logging in and out with each transfer of one image. When selecting [One Time], Network Camera stays logged in until the transfer of all images is completed. Select [One Time] when transferring many images in short duration time.



**Over write setting:**

Selects [Over Write...] to overwrite the transferred image or [Add time...] to save each transferred image.

**Data transfer method:**

Use [Passive Mode] normally. If FTP does not work properly, ask your ISP or network administrator about the transferring mode of FTP server. [Passive Mode] or [Active Mode] is available.

- b. Mail:** Sets the SMTP and POP3 server address\*<sup>1</sup> or Host Name\*<sup>2</sup>, Login ID\*<sup>2</sup> and Password\*<sup>2</sup>.  
 From (Reply)\*<sup>3</sup>: Enter the e-mail address of [Reply-to]. [To] can be the same address as From (Reply).  
 To \*<sup>3</sup>: Enter the e-mail address of receiver.  
 Subject & Text \*<sup>4</sup>: Sets the subject and text of the e-mail.  
 Time in 24 h mode is attached on the subject.

**Notes**

- Set POP3 server address or Host Name, Login ID and Password if you need POP authentication to send the e-mail. ask your ISP or administrator.
- Network Camera will only operate correctly with SMTP (Simple Mail Transfer Protocol) server. It is not available with the Internet accessed mail servers like "Hotmail" or others accessed via the web browser.

\*<sup>1</sup> Refer to IP addressing on page 108.

\*<sup>2</sup> Refer to unavailable character set 1 on page 108.

\*<sup>3</sup> Refer to unavailable character set 2 on page 108.

\*<sup>4</sup> Only ["] is unavailable in the ASCII character table on page 108 and refer to displayable character set on page 109.

**2.** Select/Enter the each parameter. Click [**Save**] when finished.

- Click [**Cancel**] to quit the current settings. The window returns to Setup Page without saving the parameters.
- Click [**Clear Buffered images**] to clear the buffered image. [**Clear Buffered images**] does not save the parameters.

**Note**

Refer to page 50 for the Buffered Image.

### 3.5.8 Camera Setup

**Camera Setup window** sets White Balance and Power Line Frequency. You can lock the Brightness, Pan/Tilt/Preset and Preset Program features. You can also select the Pan Range and Tilt Range.

1. Click [**Camera Setup**] on Setup Page.

**Camera Setup**

1. **White Balance**

2. **Power Line Frequency (for Fluorescent light)**  
 60Hz  50Hz

3. **Brightness Control**  
 Enable  Disable

4. **Pan / Tilt / Preset Control**  
 Enable  Disable

5. **Preset Program Control**  
 Enable  Disable

6. **Pan Range**  
 Minimum:  degree - Home Position:  degree - Maximum:  degree

7. **Tilt Range**  
 Minimum:  degree - Home Position:  degree - Maximum:  degree

2. Select the each parameter in the proper data field. Click [**Save**] when finished.

- The lens moves to the home position you have registered.
- Click [**Cancel**] to quit the current settings. The window returns to Setup Page without saving the parameters.

#### Instructions for the data fields

<b>White Balance</b>	<b>Auto</b> (default)	—	Auto White Balance
	<b>Fixed Indoor</b>	—	Color Temperature: 2800K, Electric Bulb
	<b>Fixed Fluorescent_1</b>	—	Color Temperature: 3600K, Natural fluorescent light
	<b>Fixed Fluorescent_2</b>	—	Color Temperature: 4000K, Natural fluorescent light
	<b>Fixed Outdoor</b>	—	Color Temperature: 6000K, Solar light
	<b>Hold</b>	—	Holds the current White Balance

### Instructions for the data fields

<b>White Balance</b>	<p><b>Notes</b></p> <ul style="list-style-type: none"> <li>The wrong White Balance setting will cause Network Camera to display colors improperly. In most cases <b>Auto</b> is suggested.</li> <li>White Balance is also registered in preset programming.</li> </ul>
<b>Power Line Frequency</b>	<p>It can select Flicker Correction by power line frequency.</p> <ul style="list-style-type: none"> <li>60 Hz (default)</li> <li>50 Hz</li> </ul> <p>Select 60 Hz in the United States.</p>
<b>Brightness Control</b>	<p>Brightness Control can be locked.</p> <p><b>Locked</b> appears on the operation bar on page 46 when clicking.</p>
<b>Pan/Tilt/Preset Control</b>	<p>Pan/Tilt/Preset Control can be locked. <b>Pan/Tilt/Preset Control</b> also disables <b>Click to Center</b> operation.</p> <p><b>Locked</b> appears on the operation bar on page 46 when clicking.</p>
<b>Preset Program Control</b>	<p>Preset Program Control can be locked.</p> <p><b>Program button</b> disappears on the operation bar on page 46.</p>
<b>Pan Range</b>	<p>Pan Range can be selected. Refer to page 84 on specifying the Pan/Tilt range.</p> <p><b>Right/Left End</b> appears on the operation bar on page 46 when having reached the selected end.</p>
<b>Tilt Range</b>	<p>Tilt Range can be selected. Refer to page 84 on specifying the Pan/Tilt range.</p> <p><b>Up/Down End</b> appears on the operation bar on page 46 when having reached the selected end.</p>

## Specifying the Pan/Tilt range

1. Start up the web browser and access the Single Camera screen.
2. Start up another web browser and access Camera Setup window.
3. Align the Single Camera screen and Camera Setup window from side to side.

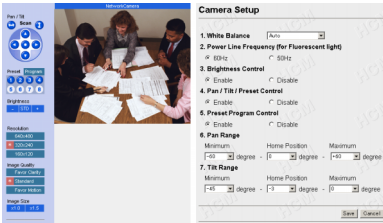

4. Adjust the Pan operation on the Single Camera screen and select **[Current]** in the minimum value data field of the Pan range on Camera Setup window. The data field refreshes to read the current value of the Pan range.
5. Specify the each home position/maximum value of the Pan range and each minimum/home position/maximum value of the Tilt range following the instruction shown in the step 4.

### Note

Minimum value must be lower than maximum value. Home position value must be in the range between minimum and maximum values.

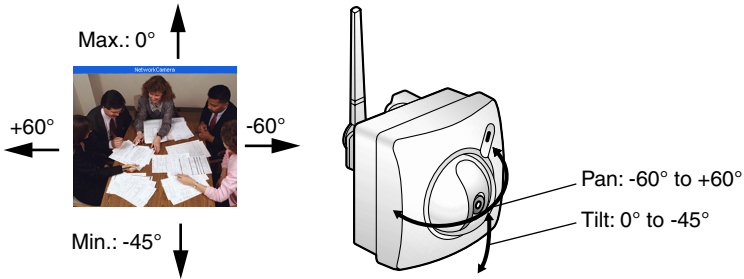

6. Click **[Save]** when finished.

## 3.5.9 Multi-Camera

**Multi-Camera window** enables the setting of Multi-Camera screen. Camera Name and IP address of each Network Camera must be entered to view the Multi-Camera screen. Registering IP addresses of the other Network Camera enables you to view on the Multi-Camera screen. Clicking Camera Name of Network Camera on the Multi-Camera screen accesses the Single Camera screen to control the image. First Network Camera is named on **Name/Time window** on page 62. 2nd to 4th Network Cameras are named on this **Multi-Camera window**.

### Notes

- When using the Multi-Camera screen, all additional Network Cameras must be defined on each Multi-Camera window. This will allow all Network Cameras to be seen and selected from each Network Camera in the entire network.
- Global IP address is required to view the image over the Internet.

### 1. Click [Multi-Camera] on Setup Page.

**Multi-Camera**

**Registration / Modification**

**1. 2nd Network Camera**  Enable

IP Address or Host Name

Camera Name (1 to 15 Characters)

**2. 3rd Network Camera**  Enable

IP Address or Host Name

Camera Name (1 to 15 Characters)

**3. 4th Network Camera**  Enable

IP Address or Host Name

Camera Name (1 to 15 Characters)

**2.** Select/Enter the each parameter. Click **[Save]** when finished.

- Click **[Cancel]** to quit the current settings. The window returns to Setup Page without saving the parameters.

**Instructions for the data fields**

<b>Enable check box</b>	The checked camera image can be seen on the Multi-Camera screen.
<b>IP Address (or URL)*<sup>1</sup> or Host Name*<sup>2</sup></b>	Enter the desired IP address of Network Camera or Host Name and Port Number. (You do not need to enter port number 80 [default].)
<b>Camera Name*<sup>3</sup></b>	Enter the desired Camera Name displayed only for the Multi-Camera screen.

\*<sup>1</sup> Refer to IP addressing on page 108.

\*<sup>2</sup> Refer to unavailable character set 1 on page 108 but [:] is available.

\*<sup>3</sup> Refer to unavailable character set 1 on page 108 and refer to displayable character set on page 109.

## 3.5.10 External Output Control

**External Output Control window** enables the External Device Control Output signal to activate the external sensors/devices. (Open or Short to GND) The network administrator should set up this setting.

### Note

Refer to page 106 for Interfacing to the External I/O.

1. Click [**External Output Control**] on Setup Page.

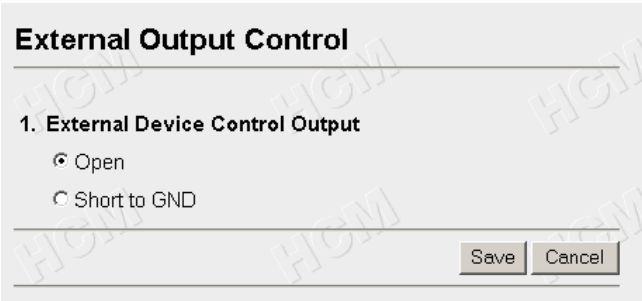

**External Output Control**

---

1. External Device Control Output

Open

Short to GND

---

Save Cancel

2. Check [**Open**] means the External Device Control Output becomes high impedance (open collector).  
Check [**Short to GND**] means the External Device Control Output becomes low (0V).
3. Click [**Save**] to send the signal.
  - Click [**Cancel**] to quit the current settings. The window returns to Setup Page without saving the parameters.

### 3.5.11 Indicator Control

**Indicator Control window** allows you to select Indicator operation. Indicator operation has three patterns.

- Always on
- Turns on when accessing Network Camera
- Always off

**Notes**

- Indicator can be controlled in case the administrator does not want to draw attention to Network Camera. This may be desirable when used for security applications.
- Refer to page 14 for the Indicator color indication.

1. Click **[Indicator Control]** on Setup Page.

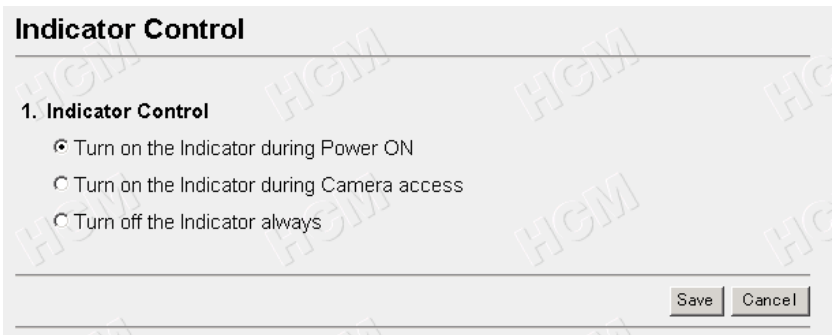

2. Select the Indicator on/off. Click **[Save]** when finished.

- Click **[Cancel]** to quit the current settings. The window returns to Setup Page without saving the parameters.



## 3.5.12 Status

**Status window** displays general information about Network Camera.

1.Version	
Hardware	XXXXXXXXXXXX
Firmware(Boot)	*.*.*
Firmware(Application)	*.*.*.*

### Note

When some trouble occurs, the information is useful.

### 3.5.13 Restart

**Restart window** restarts Network Camera with the parameters saved. Restarting is required when the network parameters are changed.

1. Click **[Restart]** on Setup Page.

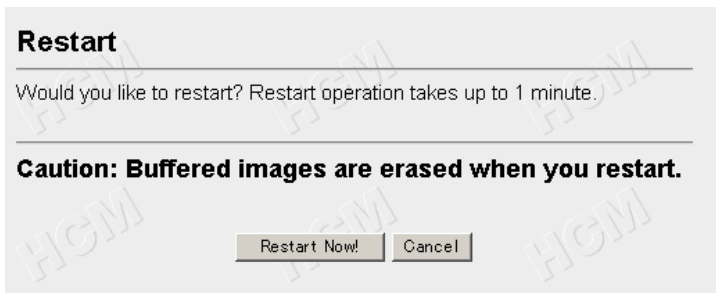

2. Click **[Restart Now!]**.
  - Click **[Cancel]** to quit. The window returns to Setup Page.

### 3.5.14 Update Firmware

**Update Firmware window** allows the user to install the latest version of the Network Camera internal operating system. In most cases, this will never be necessary. Changes may be necessary to accommodate new operating systems or new web browsers that are not shown on page 10. In those cases, Update Firmware would be available from the Network Camera Technical Support Site at <http://panasonic.co.jp/pcc/en/>. Check the current firmware version on Setup Page on page 54.

#### Notes

- Do not turn off the power during Update Firmware. If the operation of Update Firmware is stopped, refer to page 124.
  - Buffered Images are erased when performing Update Firmware.
1. Download the proper firmware from the Network Camera Technical Support Site mentioned above.
  2. If Network Camera is accessible from the Internet, temporarily disable access and connect Network Camera to the PC as the following figure. This will eliminate any interruption during the Update Firmware.

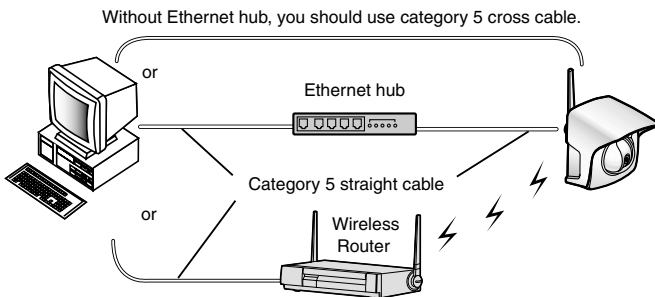

#### Note

When Network Camera uses the DHCP function, change the Internet connection from DHCP to Static in **Network window**. Refer to page 58 for the network parameters.

3. Access **Setup Page** by entering "[http://IP Address \(or URL\):Port No./config.html](http://IP Address (or URL):Port No./config.html)" on the web browser and press **[Enter]**.
  - When port number is 80 (default), you do not need to enter port number.

4. Click **[Update Firmware]** on Setup Page.

### Update Firmware

With power applied to the camera, click on "Update Firmware" below. Depending on the speed of your system, the procedure can take up to 3 minutes.

**Caution:**

- (1) **Connect the camera with the local network during the update firmware process for security.**
- (2) **Buffered images are erased when you execute this page.**
- (3) **Never turn off the power during the update firmware process.**

5. Click **[Update Firmware]**.

### Restarting now...

Restart operation takes up to 1 minute.

Please enter the proper IP address to URL when no response.

Wait about one minute.

### Update Firmware

Please enter or browse the firmware file name for update.

File name

The update firmware process takes about 120 seconds via "File Upload", "Flash-ROM Writing", and "Restart", automatically.

**Caution: Never turn off the power, during the update firmware process.**

**Note**

If you click **[Update Firmware]**, operation cannot be canceled. If canceled, refer to page 124.

6. Click [**Browse...**] to select the firmware from the file selector.
  - A dialog box appears to choose the file.
7. Select a desired Firmware file (including the path information) and click [**Open**].
8. Make sure the desired firmware file name is selected correctly, and click [**Update Firmware**].

### Proceeding the update firmware

---

Now Flash-ROM Writing...  
Please wait about 100 seconds.

---

**Caution: Never turn off the power, during the update firmware process.**

Restarting window is displayed, and Network Camera restarts automatically.

### Restarting now...

---

Restart operation takes up to 1 minute.

Please enter the proper IP address to URL when no response.

Restart operation takes about one minute.

Confirm that the Update Firmware Version number is the latest number on Setup Page.

## 3.5.15 Reset to Factory Default

**Reset to Factory Default window** initializes all the parameters including the ID, Password, IP address and Subnet Mask except Date and Time setting to the factory default. Reconfirm the settings before doing the Reset to Factory Default operation.

1. Click [**Reset to Factory Default**] on Setup Page.



2. Click [**Execute**].
  - Indicator changes such as **Orange blinking twice** → **Turning off about 15 seconds**. Initializing takes about one minute.
  - Click [**Cancel**] to quit. The window returns to Setup Page.

### Notes

- Do not turn off the power during the Reset to Factory Default. It may interrupt the Network Camera operation.
- IP address and Subnet Mask should be set again after Resetting to Factory Default.
- CLEAR SETTING button can also reset Network Camera to the Factory Default. Refer to page 112.
- Internal clock will not be reset, however, time mode will return to **AM/PM mode** and **Auto adjustment** will be disabled.
- If Reset to Factory Default is used, all user settings will be lost, and you will have to reconfigure the entire Network Camera.

# ***Section 4***

## **Technical Guides**

## 4.1 Network Camera Installation

### Outdoor Installation

Network Camera has a splash resistant body. The splash resistant body allows Network Camera to be used indoors and outdoors. Waterproof cabling is necessary for outdoor mounting. Check Network Camera operation before installing (cabling and mounting) Network Camera.

#### Notes

- Install Network Camera under eaves to protect it from direct sunlight. Prolonged exposure to direct sunlight or halogen light may damage the CMOS sensor.
- Use the Sunshade in any conditions.
- Do not install Network Camera in the location where sea breezes may hit the unit directly.
- Avoid laying Ethernet cable underground or stringing it in the air. Lightning may cause serious damage to Network Camera or the connected devices.
- AC adaptor is not waterproofed. Put the AC adaptor inside the outdoor power equipment near Network Camera and protect the AC adaptor from the rain. Ask the authorized electric wiring dealer.
- AC adaptor cord and Ethernet cable should be waterproofed. Do the waterproof electric wiring work.
- Do not expose the AC adaptor to the temperatures below -20 °C (-4 °F) or above +50 °C (122 °F). AC adaptor cannot be operated under these circumstances.
- Lightning can cause serious permanent damage to Network Camera. Be sure that Network Camera is grounded in accordance with local electrical codes for your specific application.
- If Network Camera is used outdoors, the Rubber Cap must be installed in the CLEAR SETTING button hole. It protects Network Camera's internal components from moisture damage. Carefully insert the Rubber Cap into the hole, gently pressing it into place using the end of the long tool. In order for it to work properly the cap must be seated correctly and fit snug.
- If Network Camera is positioned facing direct sunlight it is possible that a faint "rainbow" lens flare may be visible on the image. Sunshade acts similar to a lens shade on a 35-mm camera. In most cases the Sunshade will minimize the rainbow lens flare. Repositioning Network Camera so it does not face directly in the direction of the sun can further improve the image quality.



## High performance for wireless communication

Radio waves from the antenna of Network Camera transmit images. The performance of wireless communication will change under the condition where you install Network Camera and wireless router. **Wireless window** on page 32 displays the data communication and signal strength status of the wireless network.

### Notes

- Install Network Camera away from electrical appliances such as TVs or cordless telephones.
- Metal or steel framework, such as refrigerators, can hinder radio communications. Open areas offer better performance.
- Microwave ovens and some cordless telephones may interfere with wireless frequencies this Network Camera uses. For better results, install as far away from these devices as possible.
- Many wireless devices on the same channel reduce the speed of communications. Set 5 channels apart to prevent the bandwidth from overlapping. If another wireless network use Channel 6, you may use Channel 1 or 11.
- For maximum wireless performance, the distance between Network Camera and wireless router should be 0.5—120 m (about 2—400 feet). These distances may be reduced depending on the capability of the wireless router or the wireless network conditions.
- Do not put excessive weight or pressure on the antenna as it can be damaged.

## 4.1.1 Network Camera Cabling

Check the location where Network Camera should be installed. Select the proper cable suited to Network Camera location. Consult an authorized wiring electrician for cabling.

1. Raise the antenna vertically (1.), and put the cables through the Connector Cover (2.). Connect the DC plug of the AC adaptor to the DC IN jack (3.). Connect the AC plug of the AC adaptor to the power outlet (4.).

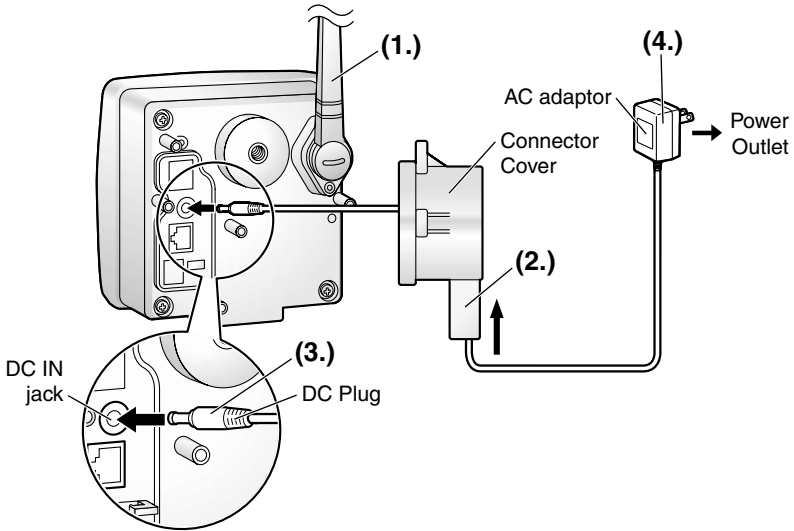

### Notes

- Mounting and cabling instructions described in this Operating Instructions follow generally accepted guidelines suitable for residential installations. In some areas, commercial and industrial installations are regulated by local or state ordinances. For such installations, contact your local building department or building inspector for more details.
- Ethernet cable, External I/O and Ground should be connected and threaded through Connector Cover. Once you putty the cables, External I/O and Ground cannot be connected until you take the putty off.
- Check the location of Network Camera, the type and the length of the Ethernet cable (Max. 100 m [330 feet]). Use an Ethernet cable as short as possible for outdoor use. Lightning may cause serious damage to Network Camera or the connected devices.
- Use a category 5 cross cable (if necessary) when connecting directly to a PC.

- Thread the AC adaptor cord through the hook. Put the Rubber Cap and the Connector Cover by fastening the three screws in numerical order. The remaining screw hole on the Connector Cover is used for attaching Sunshade.

**Note**

Be sure to thread the AC adaptor cord through the hook.

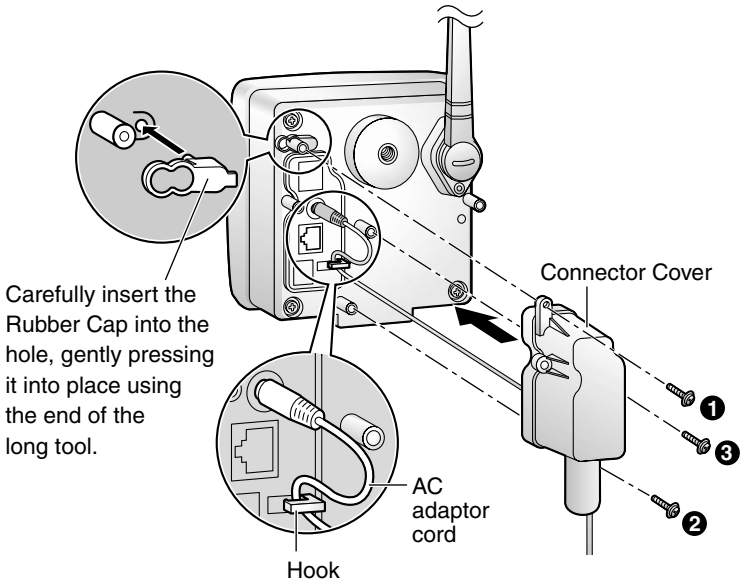

- Attach the Sunshade by fastening the two screws.

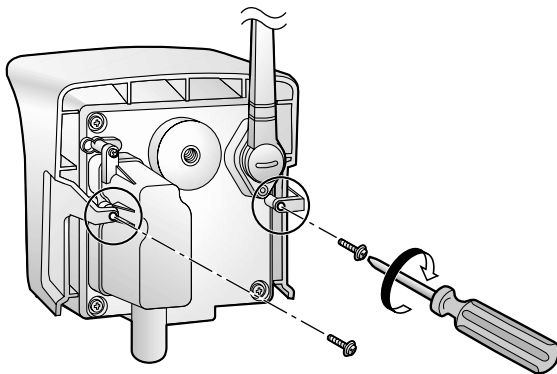

- Roll up three putties around the cables and fit them into the holes to prevent water from getting inside Network Camera. Use last putty to fix the spot.

**Notes**

- Confirm Network Camera is functioning before puttying the cables. Putties and Self Bonding tape cannot be used twice.
- Check the length and the type of the Ethernet cable before fixing with putty.

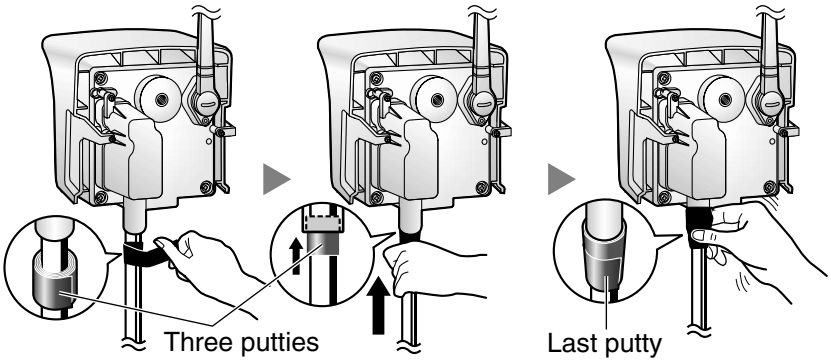

- Cover the putties by rolling.

- Self Bonding tape is used to mount Network Camera on a wall or ceiling, so leave half the Self Bonding tape.

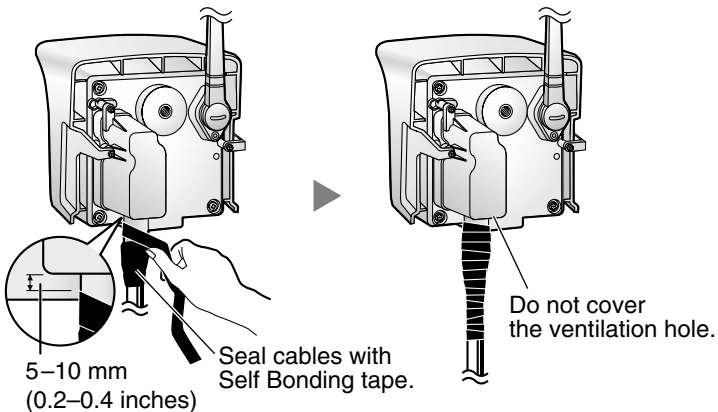

## 4.1.2 Network Camera Mounting

Four mounting methods are shown in the following figures. Confirm the top and bottom of Network Camera when mounting. Ask the authorized dealer for mounting. Confirm wireless communication status on **Wireless window** on page 32 before mounting Network Camera.

### Note

Mounting and cabling instructions described in this Operating Instructions follow generally accepted guidelines suitable for residential installations. In some areas, commercial and industrial installations are regulated by local or state ordinances. For such installations, contact your local building department or building inspector for more details.

### Flexible Stand Mounting

- 1) Attach Network Camera by screwing the threaded mount into the tripod mounting hole.
- 2) Turn the grip to fix the Flexible Stand firmly.

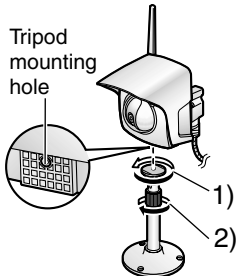

### Tripod Mounting

Attach Network Camera to the tripod using the tripod bolt.

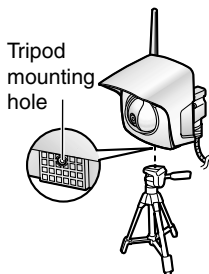

## Wall Mounting

- 1) Mount the Flexible Stand firmly to a wall or beam using the three screws (accessories). Set the Flexible Stand 240 mm (9.5 inches) away from the ceiling.
  - Use appropriate screws suited for the material of the wall.
- 2) Attach Network Camera by screwing the threaded mount into the tripod mounting hole. A mounting hole on the rear side is also available.
- 3) Adjust the position of Network Camera and secure the Flexible Stand firmly.
- 4) Roll up the cables and Flexible Stand with the Self Bonding tape (accessories). Refer to page 96 for waterproofing the cables.

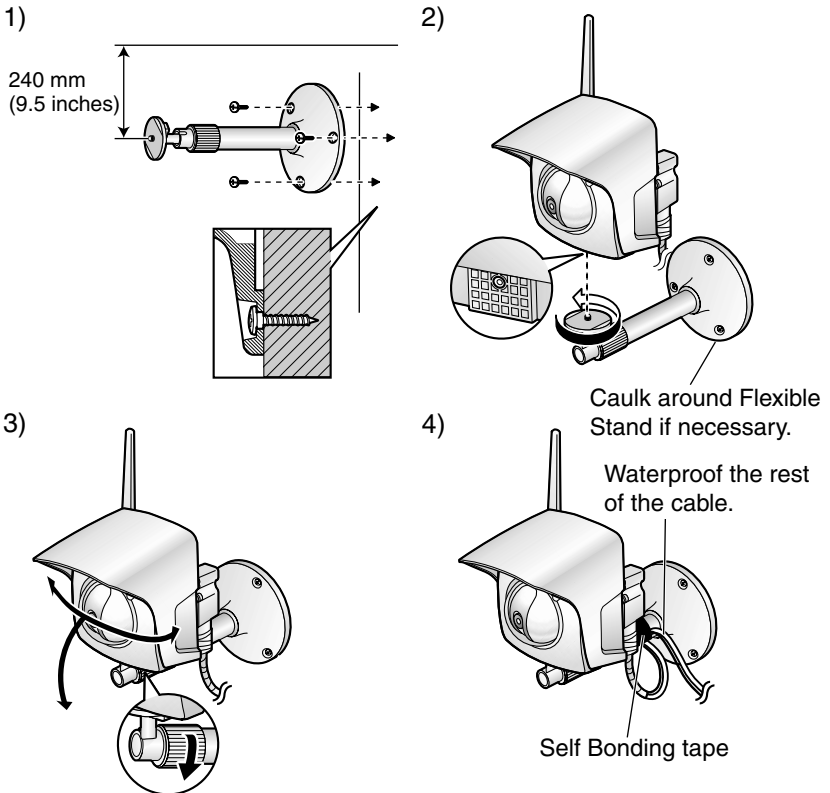

## Ceiling Mounting

- 1) Mount the Flexible Stand firmly to the ceiling or beam using the three screws (accessories).
  - Use appropriate screws suited for the material of the ceiling.
- 2) Attach Network Camera by screwing the threaded mount into the tripod mounting hole.
- 3) Adjust the position of Network Camera and secure the Flexible Stand firmly.
- 4) Roll up the cables and Flexible Stand with the Self Bonding tape (accessories). Refer to page 96 for waterproofing the cables.

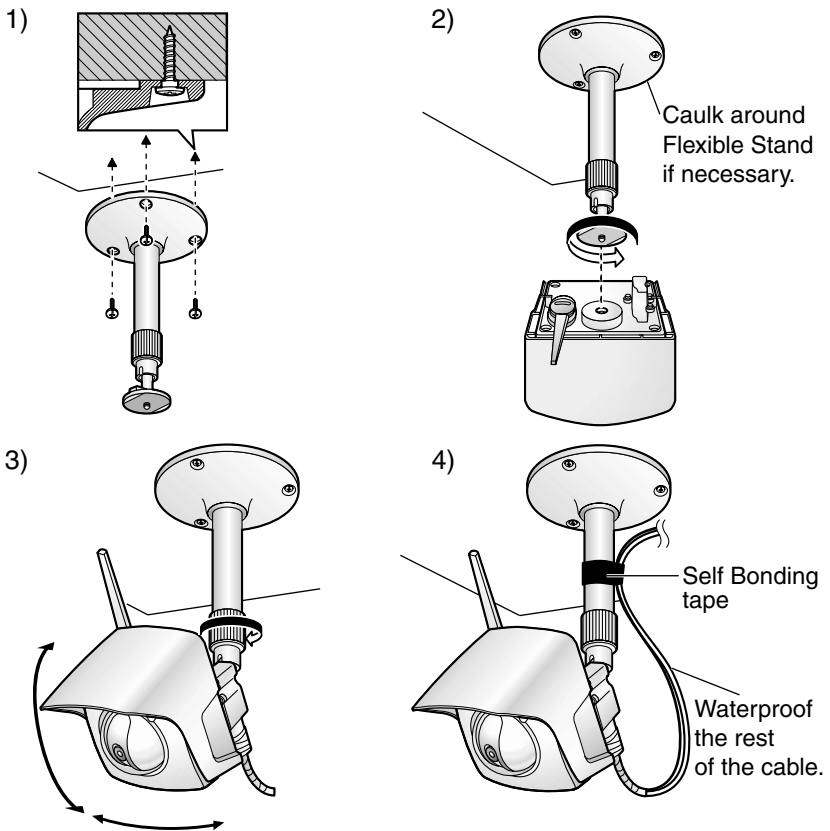

**Note**

Make sure the Indicator is always in the upper right corner when you mount Network Camera.

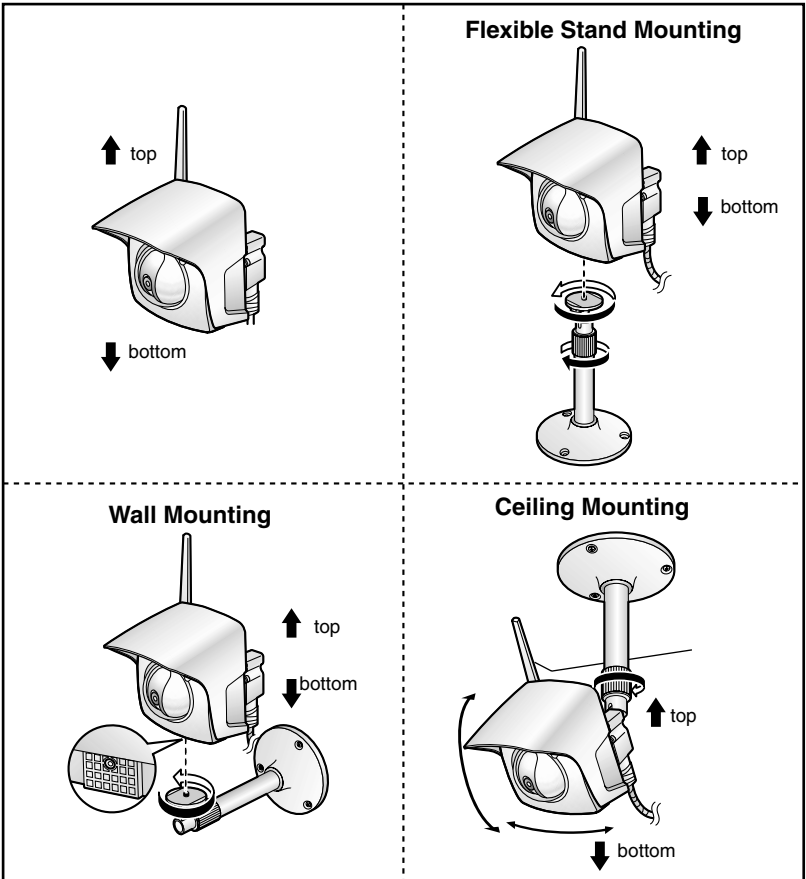

**CAUTION**

Drive mounting screws into the wall. Be careful to avoid touching any metalwork (metal/wire laths etc.), conduits or electrical cables buried in the wall.



## Making holes on mortar wall

1. Put Flexible Stand on the wall where you plan to install Network Camera and mark the points where you are going to make holes.
2. Make holes with an electric drill. Insert plastic plugs (customer provided) into the holes and push them inside the holes with the hammer.

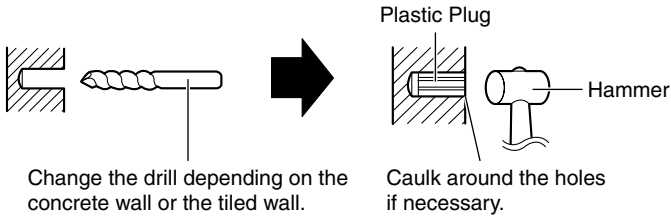

### Note

Mortar wall is easy to come off in drilling.

3. Mount the Flexible Stand by using the screws (accessories).

## 4.2 Interfacing to the External I/O

The Alarm mode in the Image Transfer feature requires the external sensors/ devices to be connected to the External Sensor Input of the External I/O. Certain features of this Network Camera can be activated by an external sensor that senses physical changes in the area Network Camera is monitoring. These changes can include motion detection or a physical change in the monitored area. The external sensor can also be a door switch or an infrared motion detector. These devices are customer provided, and are available from dealers who carry surveillance and security products. Electrically, they must be able to provide a momentary contact closure.

### Explanation of External I/O

Pin	Function
1	GND
2	DC Power Output Terminal <ul style="list-style-type: none"> <li>• 12—16 V DC</li> <li>• Maximum of 100 mA load drive is possible.</li> </ul>
3	<b>External Sensor Input</b> <ul style="list-style-type: none"> <li>• External Sensor Input receives the signal produced by the alarm sensors, (e.g., door sensor, infrared ray sensor). Those signals can activate Image Transfer in the Alarm mode feature on page 72.</li> <li>• Use it by opening or GND short-circuit.</li> </ul>
4	<b>External Device Control Output</b> <ul style="list-style-type: none"> <li>• External Device Control Output sends the electric current to activate the external devices, (e.g., light, buzzer).</li> <li>• <b>External Output Control window</b> can set the External Device Control Output. Refer to page 87.</li> <li>• It is an open collector circuit, and the maximum drawing-in current is 100 mA. Prevent the maximum voltage from exceeding DC Power Output voltage of pin 2.</li> </ul>

## Circuit Diagram Example

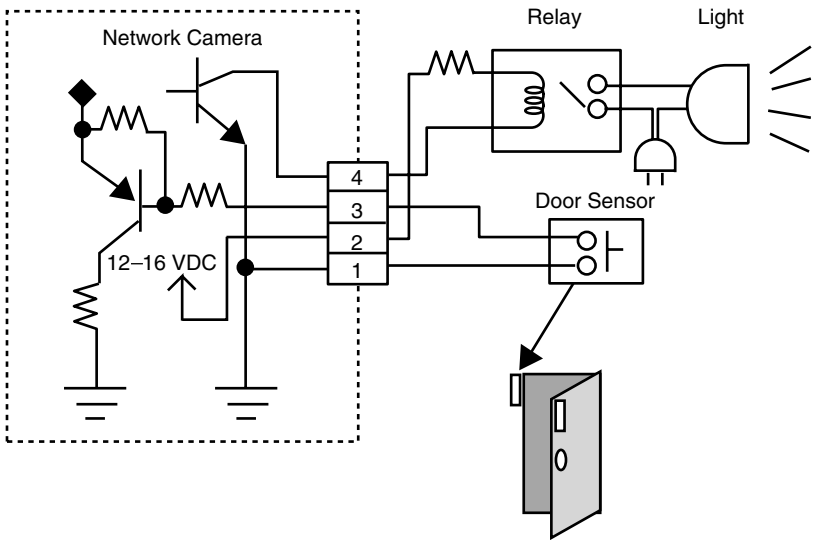

### CAUTION

- THE EXTERNAL I/O IS NOT CAPABLE OF CONNECTING DIRECTLY TO DEVICES THAT REQUIRE LARGE AMOUNTS OF CURRENT. IN SOME CASES, A CUSTOM INTERFACE CIRCUIT (CUSTOMER PROVIDED) MAY HAVE TO BE USED. SERIOUS DAMAGE TO NETWORK CAMERA MAY RESULT IF A DEVICE IS CONNECTED TO THE EXTERNAL I/O THAT EXCEEDS ITS ELECTRICAL CAPABILITY.
- THE LOW VOLTAGE/CURRENT CIRCUITS AND HIGH VOLTAGE/CURRENT CIRCUITS ARE IN THE NETWORK CAMERA CIRCUIT. THE QUALIFIED ELECTRICIAN SHOULD DO THE WIRING NOT BY YOURSELF. INCORRECT WIRING COULD DAMAGE NETWORK CAMERA. YOU COULD RECEIVE THE FATAL ELECTRIC SHOCK.
- External I/O (Input/Output) are independent. Output terminal is controlled only by External Output Control window on page 87.

## 4.3 ASCII and ISO-8859-1 Character Table

The characters of the ASCII character table are available for use in the various setup windows.

### IP addressing (Assignment of the IP address)

Address consists of one to four numbers (0—255). By far most common form is four decimal numbers, (e.g., 192.168.0.253).

("0.0.0.0" and "255.255.255.255" are not available.)

### Unavailable character set 1

[Space], ["], ['], [#], [&], [%], [=], [+], [?], [<], [>] and [:] are not available.

### Unavailable character set 2

[Space], ["], ['], [#], [&], [%], [=], [+], [?], [<], [>] and [:] are not available.

Character set is like [text] + [@] + [text] + [.] + [text].

(space)	0	@	P	`	p
!	1	A	Q	a	q
"	2	B	R	b	r
#	3	C	S	c	s
\$	4	D	T	d	t
%	5	E	U	e	u
&	6	F	V	f	v
'	7	G	W	g	w
(	8	H	X	h	x
)	9	I	Y	i	y
*	:	J	Z	j	z
+	;	K	[	k	{
,	<	L	\	l	
-	=	M	]	m	}
.	>	N	^	n	~
/	?	O	_	o	

**Displayable character set**

Network Camera can display ISO-8859-1 character set for West European languages and the Shift-JIS character set for Japanese. Network Camera screen may display the unreadable characters if the operating system or the entered character set is different from the language selected on Top View Image Setting window.

ISO-8859-1 Character Table					
¡ ¢ £ ¤ ¥ ¦ § ¨ © ª « ¬ ® ¯	° ± ² ³ ´ µ ¶ · ¸ ¹ º » ¼ ½ ¾ ¿	À Á Â Ã Ä Å Æ Ç È É Ê Ë Ì Í Î Ï	Ð Ñ Ò Ó Ô Õ Ö × Ø Ù Ú Û Ü Ý Þ ß	à á â ã ä å æ ç è é ê ë ì í î ï	ñ ò ó ô õ ö ÷ ø ù ú û ü ý þ ÿ

## 4.4 Maintenance

To keep Network Camera functioning in good condition, maintenance plays an important part. Keep maintenance when using Network Camera. After removing the sand or dust from the Lens Cover, wipe the Lens Cover with a dry cloth.

### Fixed Focus Lens

- Do not touch the Lens Cover. Touching it may leave a fingerprint and can cause the image to be out of focus.
- Do not pour the water to wash the unit or the Lens Cover of Network Camera.
- Clean the Lens Cover with lens cleaning paper. Do not use the chemical matters like alcohol, soap, benzine, thinner, wax, petroleum, hot water, insecticide spray, glass cleaner and so on. They may bend the Connector Cover and the body of Network Camera.

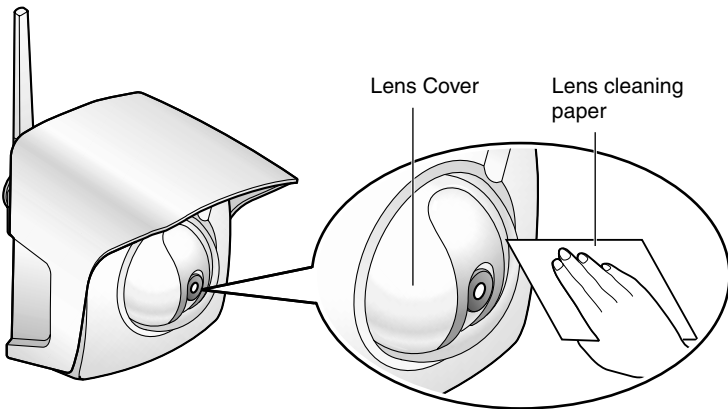

## ***Section 5***

# **Specifications and Troubleshooting**

## 5.1 Network Camera Reset Procedure—Default Settings

If the user forgets settings or passwords, Network Camera can be easily reset to the default settings. The CLEAR SETTING button initializes all the parameters except Date and Time setting.

With power on, press the **CLEAR SETTING button** for about one second. Indicator changes such as **Orange blinking twice** → **Turning off about 15 seconds**. Initializing takes about one minutes. Pan/Tilt motors will set to the home position.

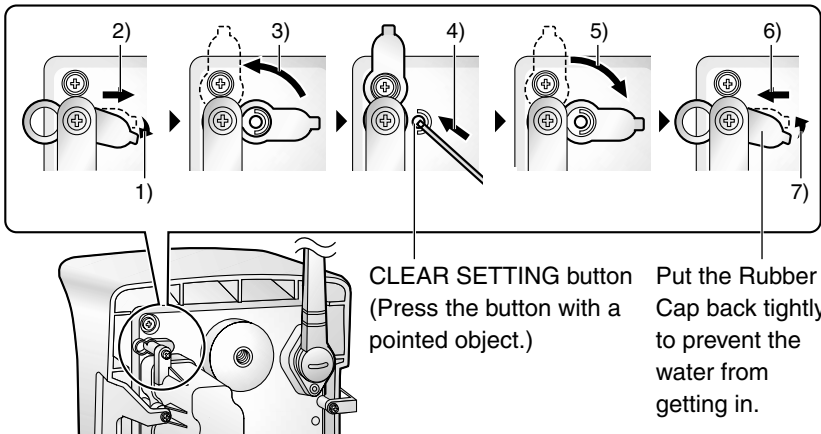

### Notes

- Wireless network parameters, IP address and Subnet Mask will be also set to factory default. Wireless network parameters must be reconfigured.
- When pressing the **CLEAR SETTING button**, all buffered images are cleared.
- Rubber Cap must be installed in the CLEAR SETTING button hole. It protects the Network Camera's internal components from moisture damage.

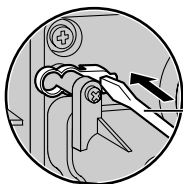

Carefully insert the Rubber Cap into the hole, gently pressing it into place using the end of the long tool.



## 5.2 Default Settings List

No	Items	Factory Default value	Indispensable setting	Note	
1	Network	1. Network Configuration	Checked	-	-
		2. Wireless Mode	Infrastructure	Required when using wireless mode	Infrastructure, Ad-hoc
	Channel	6	Required when using Ad-hoc mode	1-11	
	SSID	[Blank]	-	-	
	Speed	Auto	-	Auto, 1, 2, 5.5, 11 Mbps	
	Encryption	None	-	None, 40, 128 bit	
	Authentication	Shared Key	-	Shared Key, Open System	
	Default Key	1	-	1, 2, 3, 4	
	3. Port No.	80	-	1-65535	
	Static : IP Address	192.168.0.253	If necessary	(*1)	
	Static : Subnet Mask	255.255.255.0	If necessary	(*1)	
	DHCP : Host Name	[Blank]	If necessary	(*3) 0 to 63 Characters	
	4. Default Gateway	[Blank]	Required when using Gateway	(*1)	
	5. DNS Server1 & DNS server 2	[Blank]	Required when using DNS	(*1)	
	6. DDNS	No check	-	-	
	Your e-mail address	[Blank]	Required when using DDNS	(*4) 5 to 255 Characters	
	7. Max Bandwidth usage (Mbps)	Unlimited	-	0.1, 0.2, 0.3, 0.5, 1.0, Unlimited	
2	Name/Time	1. Camera Name	NetworkCamera	-	(*3) and (*7) 1 to 15 Characters
		2. Date and Time (AM/PM, 24H)	AM/PM	-	-
		2. Date and Time (Year/Month/Day/Hour/Minute)	No changing	-	-
		3. Auto Adjustment	No check	-	-
		NTP Server Address or Host Name	[Blank]	-	(*1) or (*3) 1 to 255 Characters
		Time Zone	GMT-05:00	-	-
		1. Authentication Enable	None	-	-
3	Security: Administrator	2. ID	[Blank]	Required when setting Authentication	(*3) 4 to 15 Characters
		Password	[Blank]	Required when setting Authentication	(*3) 4 to 15 Characters
		Retype Password	[Blank]	Required when setting Authentication	(*3) 4 to 15 Characters

No	Items	Factory Default value	Indispensable setting	Note
4	<b>Security: General User</b>	(1.) User ID List	No entry	-
		(2.) New User: ID	[Blank]	Required when setting General User
		New User: Password	[Blank]	Required when setting General User
		New User: Retype Password	[Blank]	Required when setting General User
5	<b>Top View Image Setting</b>	1. Language	English (US)	(*3) 4 to 15 Characters French, German, Italian, Spanish, Japanese, etc.
		2. Top Page title	[Blank]	(*6) and (*7) 0 to 63 Characters
		Image URL	[Blank]	(*8) 0 to 127 Characters
		Link URL	[Blank]	(*8) 0 to 127 Characters
		3. Single Camera Image Resolution	320 x 240	160 x 120, 320 x 240, 640 x 480
		Image Quality	Standard	Favor Clarity, Standard, Favor Motion
		Refresh Interval	30 s	10, 15, 20, 25, 30, 45 s, 1, 2, 3, 5 min
		4. Multi-Camera Image Resolution	320 x 240	160 x 120, 320 x 240
		Image Quality	Standard	Favor Clarity, Standard, Favor Motion
		Refresh Interval	30 s	10, 15, 20, 25, 30, 45 s, 1, 2, 3, 5 min
6	<b>Image Transfer</b>	5. Limit time of Continuous Motion JPEG	Unlimited	-
		6. Always/Operational between	Always	-
		Time 1 — 4	0h 0min — 0h 0min	-
		Day-of-the-week setting	All checked	-
		1. Trigger Setting	Non transfer	-
		2. Capture Control	Enable	-
		2. (1) Always/Operational between	Always	-
		Start time	00:00:00	-
		Stop time	23:59:59	-
		Day-of-the-week setting	All checked	-
		Alarm enable condition	Rising	-
		(2)Secondary Time	No check	-
		Alarm enable condition,	Rising	-

No	Items	Factory Default value	Indispensable setting	Note	
6	1. Alarm	3. (1) Image Resolution	-	160 x 120, 320 x 240, 640 x 480	
		(2) Image Quality	-	Favor Clarity, Standard, Favor Motion	
		4. (1) Pre-alarm Image Buffer	No check	-	-
		Image Frequency	1 Image/Hour	-	1—15
		Maximum number of image per each trigger	1	-	1—3000
		(2) Post-alarm Image Buffer	Checked	-	-
		Image Frequency	1 Image/Hour	-	1—15
		Maximum number of image per each trigger	1	-	1—3000
		5. Non Transfer without Memory Over Write	Selected	-	-
		Non Transfer with Memory Over Write	Not-selected	-	-
		FTP	Not-selected	-	-
		Server Address or Host Name	[Blank]	Required when using FTP	(*1) or (*3) 1 to 255 Characters
		Port No. (Usually Use 21)	21	Required when using FTP	1—65535
		Login ID	[Blank]	If necessary	(*3) 0 to 63 Characters
		Password	[Blank]	If necessary	(*3) 0 to 63 Characters
		Login timing	Every Time	-	Every Time, One Time
		Upload File Name	[Blank]	Required when using FTP	(*3) 1 to 234 Characters
		Over write setting	Over Write to Fixed Upload File Name	-	-
		Data transfer method	Passive Mode	-	Passive Mode, Active Mode
		Mail	Not-selected	-	-
SMTP Server Address or Host Name	[Blank]	Required when using Mail	(*1) or (*3) 1 to 255 Characters		
POP3 Server Address or Host Name	[Blank]	Required when using POP authentication	(*1) or (*3) 1 to 255 Characters		
Login ID	[Blank]	Required when using POP authentication	(*3) 0 to 63 Characters		
Password	[Blank]	Required when using POP authentication	(*3) 0 to 63 Characters		
From (Reply)	[Blank]	Required when using Mail	(*4) 5 to 63 Characters		
To	[Blank]	Required when using Mail	(*4) 5 to 63 Characters		
Subject	[Blank]	Required when using Mail	(*4) 5 to 63 Characters		
Text	[Blank]	-	(*2) and (*7) 0 to 44 Characters		
		[Blank]	-	(*2) and (*7) 0 to 63 Characters	

No	Items	Factory Default value	Indispensable setting	Note	
6	1. Alarm	6. No Message	-	-	
		Mail	Not-selected	-	
		SMTP Server Address or Host Name	[Blank]	Required when using Mail	(*1) or (*3) 1 to 255 Characters
		POP3 Server Address or Host Name	[Blank]	Required when using POP authentication	(*1) or (*3) 1 to 255 Characters
		Login ID	[Blank]	Required when using POP authentication	(*3) 0 to 63 Characters
		Password	[Blank]	Required when using POP authentication	(*3) 0 to 63 Characters
		From (Reply)	[Blank]	Required when using Mail	(*4) 5 to 63 Characters
		To	[Blank]	Required when using Mail	(*4) 5 to 63 Characters
		Subject	[Blank]	-	(*2) and (*7) 0 to 63 Characters
		Text	[Blank]	-	(*2) and (*7) 0 to 63 Characters
1. Timer	2. (1) Always/Operational between	Start time	Always	-	
		Stop time	00:00:00	-	
		Day-of-the-week setting	23:59:59	-	
		(2) Secondary Time	All checked	-	
		(1) Image Resolution	No check	-	
		(2) Image Quality	320 x 240	-	
		(1) Primary Image Buffer Frequency	Standard	-	
		(2) Secondary Image Buffer Frequency	1 Image/Hour	-	
		Non Transfer without Memory Over Write	1 Image/Hour	-	
		Non Transfer with Memory Over Write	Selected	-	
		FTP	Not-selected	-	
		Server Address or Host Name	Not-selected	-	
		Port No. (Usually Use 21)	[Blank]	Required when using FTP	(*1) or (*3) 1 to 255 Characters
		Login ID	21	Required when using FTP	1—65535
		Password	[Blank]	If necessary	(*3) 0 to 63 Characters
		Login timing	[Blank]	If necessary	(*3) 0 to 63 Characters
		Upload File Name	Every Time	-	Every Time, One Time
		Over write setting	[Blank]	Required when using FTP	(*3) 1 to 234 Characters
		Data transfer method	Over Write to Fixed Upload File Name	-	-
			Passive Mode	-	Passive Mode, Active Mode

No	Items	Factory Default value	Indispensable setting	Note	
1. Timer	Mail	Not-selected	-	-	
	SMTP Server Address or Host Name	[Blank]	Required when using Mail	(*1) or (*3) 1 to 255 Characters	
	POP3 Server Address or Host Name	[Blank]	Required when using POP authentication	(*1) or (*3) 1 to 255 Characters	
	Login ID	[Blank]	Required when using POP authentication	(*3) 0 to 63 Characters	
	Password	[Blank]	Required when using POP authentication	(*3) 0 to 63 Characters	
	From (Reply)	[Blank]	Required when using Mail	(*4) 5 to 63 Characters	
	To	[Blank]	Required when using Mail	(*4) 5 to 63 Characters	
	Subject	[Blank]	Required when using Mail	(*2) and (*7) 0 to 44 Characters	
	Text	[Blank]	-	(*2) and (*7) 0 to 63 Characters	
	7 Camera Setup	1. White Balance	Auto	-	Auto, Fixed (Indoor/Fluorescent_1/Fluorescent_2/Outdoor), Hold
		2. Power Line Frequency	60 Hz	-	60 Hz, 50 Hz
		3. Brightness Control	Enable	-	-
		4. Pan/Tilt/Preset Control	Enable	-	-
5. Preset Program Control		Enable	-	-	
6. Pan Range (Minimum)		-60 degree	-	-60 — +60 degree, current	
(Home Position)		0 degree	-	-60 — +60 degree, current	
(Maximum)	+60 degree	-	-60 — +60 degree, current		
7. Tilt Range (Minimum)	-45 degree	-	-45 — 0 degree, current		
(Home Position)	-3 degree	-	-45 — 0 degree, current		
(Maximum)	0 degree	-	-45 — 0 degree, current		

No	Items	Factory Default value	Indispensable setting	Note
8	<b>Multi-Camera</b>	1. 2nd Network Camera	No check	-
		IP Address or Host Name	[Blank]	Required when using Multi-Camera
		Camera Name	[Blank]	Required when using Multi-Camera
		2. 3rd Network Camera	No check	-
		IP Address or Host Name	[Blank]	Required when using Multi-Camera
		Camera Name	[Blank]	Required when using Multi-Camera
9	<b>External Output Control</b>	3. 4th Network Camera	No check	-
		IP Address or Host Name	[Blank]	Required when using Multi-Camera
		Camera Name	[Blank]	Required when using Multi-Camera
		1. Open/Short to GND	Open	-
		1. Turn on the Indicator during Power ON	Selected	-
		1. Turn on the Indicator during Camera access	Not-selected	-
10	<b>Indicator Control</b>	1. Turn off the Indicator always	Not-selected	-
		File Name	[Blank]	Required when using Update Firmware
		① Preset Button	Upper Left	(*3) and (*7) 1 to 15 Characters
11	<b>Update Firmware</b>	② Preset Button	Upper Right	(*3) and (*7) 1 to 15 Characters
		③ Preset Button	Lower Left	(*3) and (*7) 1 to 15 Characters
		④ Preset Button	Lower Right	(*3) and (*7) 1 to 15 Characters
		④ Preset Button	Lower Right	(*3) and (*7) 1 to 15 Characters

(\*1): Address must be composed of four numeral characters (0 to 255) and divided with 3 dots, such as 192.168.0.253. (Cannot use "0.0.0.0" and "255.255.255.255")

(\*2): Only [ ] is unavailable in the ASCII characters.

(\*3): [Space], [ ], [ # ], [ & ], [ % ], [ = ], [ + ], [ ? ], [ < ], [ > ] and [ ] are not available in the ASCII characters.

(\*4): [Space], [ ], [ # ], [ & ], [ % ], [ = ], [ + ], [ ? ], [ < ], [ > ] and [ ] are not available in the ASCII characters and the character set is like [text] + [ @ ] + [text] + [ ] + [text]

(\*5): [Space], [ ], [ # ], [ & ], [ % ], [ = ], [ + ], [ ? ], [ < ], [ > ] and [ ] are not available in the ASCII characters.

(\*6): [ ], [ # ], [ & ], [ % ], [ = ], [ + ], [ ? ], [ < ], [ > ] and [ ] are not available in the ASCII characters.

(\*7): ISO-8859-1 character set for West European language and Shift-JIS character set for Japanese are available.

(\*8): Only [space] and [ ] are unavailable in the ASCII characters.

## 5.3 Specifications

### Network Camera Specifications

Item	Description
Pan/Tilt Angle	Pan: -60° to +60°, Tilt: 0° to -45°
Sensor Type	1/3 inch CMOS
Number of Pixels	320,000 pixels (Effective Pixels)
Illumination	10—10,000 lx
White Balance	Auto/Manual/Hold
Adjustment	Brightness, White balance
Focus	Fixed 1 m (40 inches)—Infinity
Caliber Ratio (F No.)	F1.8
Horizontal Angle	45°
Exposure	Auto

### Other Specification

Item	Description
Splash Resistant Standard	IPX4
Video Compression	JPEG/3 Levels
Video Resolution	640 x 480, 320 x 240 (default), 160 x 120
Buffered Image* <sup>1</sup>	About 560 frames (320 x 240) with time display
Magnification	100% or 150%
Frame rate (in 60 Hz)* <sup>2</sup>	Max. 7.5 frames/second (640 x 480) Max. 15 frames/second (320 x 240) Max. 15 frames/second (160 x 120)
Supported Protocols	TCP, UDP, IP, HTTP, FTP, SMTP, POP3, DHCP, DNS, DDNS, ARP, ICMP, NTP
Message Transferring Condition	When detecting the alarm

Item	Description
Message Transferring Method	SMTP
Image Transferring Condition	Timer: Day of the Week/Hour/Minute/Second Alarm: External Sensor Input
Image Transferring Method	SMTP, FTP
LAN Interface	10Base-T Ethernet RJ-45 connector x 1
Wireless LAN Interface	Protocol: IEEE 802.11b Antenna: Diversity Antenna Frequency: 2400—2483.5 MHz (11 channels) Modulation: Direct Sequence Spread Spectrum Media Access Protocol: CSMA/CA+ACK
External I/O* <sup>3</sup>	External Sensor Input x 1 External Device Control Output x 1
Indicator Display	Power/Network Communication/ Network Camera operation
Dimension (HWD)	116 mm (4.57 inches) x 116 mm (4.57 inches) x 88 mm (3.46 inches) Excluding the antenna and protruding objects
Weight	570 g (1.26 lb.) (Only the unit)
Power	AC adaptor: Input 120 V AC, 60 Hz Output 12 V DC, 780 mA Consumption: 6.5 W (8 W in Pan/Tilt Scan)
Condition	Operation temperature: -20 °C to +50 °C (-4 °F to +122 °F) Storage temperature: -25 °C to +60 °C (-13 °F to +140 °F) Humidity: 20% to 90% (No Condensation)

\*<sup>1</sup> The maximum number of frames depends on the image quality and the object situation in Buffered Image.

\*<sup>2</sup> Frame rate varies with the network condition, the PC performance, the image quality and the object situation.

\*<sup>3</sup> A sensor must be attached to Network Camera in order to utilize the alarm trigger.



## 5.4 Troubleshooting

### About Network Camera Setup

Problem	Cause and Remedy
When Setup CD-ROM cannot find Network Camera.	<ul style="list-style-type: none"> <li>• Reconnect the AC adaptor if installation is not completed within 20 minutes.</li> <li>• Do not connect Network Camera over a broadband router. Setup program cannot detect Network Camera.</li> <li>• If IP address is not assigned to the PC, setup program cannot find Network Camera. Confirm that IP address is assigned to the PC in the way shown on page 23. IP address of the PC can be assigned on <b>TCP/IP Properties window</b> to access through the steps in the <b>TCP/IP Properties Table</b> on page 127.</li> <li>• Confirm that the Network Configuration from setup program is enabled on <b>Network window</b> on page 58.</li> <li>• When you set up Network Camera in <b>[Type 3]</b>, connect temporarily Network Camera in <b>[Type 1]</b>, <b>[Type 2]</b> or <b>[Type 4]</b>.</li> <li>• Antivirus software on the PC may interfere with the setup program. Disable the firewall of the antivirus software only when setting up Network Camera.</li> </ul>
When Setup program fails to save the network parameters.	<ul style="list-style-type: none"> <li>• Reconnect the AC adaptor if installation is not completed within 20 minutes.</li> <li>• Network may have the trouble. Confirm the parameters and the connections of Network Camera through page 18—page 31.</li> </ul>

### About Network Camera Setup

Problem	Cause and Remedy
<p>When Top Page does not appear.</p>	<ul style="list-style-type: none"> <li>• Enter the correct IP address in the web browser.</li> <li>• IP address and Subnet Mask of the PC and Network Camera must be in the same class of the private IP address on the LAN. Refer to page 25.</li> <li>• The network congestion prevents Top Page from appearing quickly. Wait for a while.</li> <li>• A proxy server may prevent you from connecting directly to Network Camera, set up not to use the proxy server. Refer to page 26 for details.</li> <li>• When Top Page does not appear, port number 80 might not be available. Ask your ISP for the available port number.</li> <li>• When you use DDNS, you need to set Default Gateway and DNS server address. Refer to page 58 for <b>Network window</b>.</li> <li>• If Top Page does not appear in the above procedure, press the CLEAR SETTING button and set up with the Setup CD-ROM again.</li> <li>• The procedure on page 127 can be established if Network Camera has a defect.</li> </ul>
<p>Top Page does not appear in the Internet Connection.</p>	<ul style="list-style-type: none"> <li>• Confirm that Default Gateway address is correct on <b>Network window</b> on page 58.</li> <li>• The broadband router needs Port Forwarding (IP Masquerade) feature. Refer to the broadband router's manual for details.</li> <li>• Packet Filtering of the broadband router may prohibit access from an external network. Refer to broadband router's manual for details.</li> <li>• Access Network Camera from the Internet with the global IP address of the broadband router and port number of Network Camera.</li> <li>• Some broadband routers reject the global IP address to access Network Camera on the same LAN. Access with the private IP address of Network Camera.</li> </ul>
<p>When forgetting the IP address of Network Camera.</p>	<p>Check an IP address by using the Setup CD-ROM. <b>Network Camera List window</b> on page 29 can tell you the IP address of Network Camera.</p>

### About Network Camera Setup

Problem	Cause and Remedy
When forgetting the password to access Setup Page.	<p>Follow the steps below.</p> <ol style="list-style-type: none"> <li>1. Initialize Network Camera by pressing the CLEAR SETTING button.</li> <li>2. Reconfigure Network Camera.</li> </ol>
Indicator does not light up.	<ul style="list-style-type: none"> <li>• Confirm that the standard AC adaptor PSLP1233 (Order No. PSLP1233Z) is used.</li> <li>• Confirm that the Indicator Control is disabled. Refer to page 88 for <b>Indicator Control window</b>.</li> </ul>
Indicator is orange.	<ul style="list-style-type: none"> <li>• Ethernet cable is not connected properly.</li> <li>• PC, Ethernet hub or broadband router is not working.</li> </ul>
Green indicator continues blinking.	Internal Failure of the server or the congestion on the network traffic when using DHCP may prevent Network Camera from getting the IP address. Ask the network administrator or your ISP.
Orange indicator continues blinking.	Orange indicator blinks when updating firmware on page 91. When the Update Firmware failed, refer to page 124.
Red indicator continues blinking.	If you cannot access Network Camera, the Network Camera hardware may be defective. Call our customer call center.
Image Transfer on e-mail or FTP does not work.	<ul style="list-style-type: none"> <li>• Default Gateway and DNS server address should be set up on <b>Network window</b> on page 58.</li> <li>• If FTP does not work properly, ask your ISP or network administrator about the transferring mode of FTP server. [Passive Mode] or [Active Mode] is available.</li> <li>• Select [One Time] for Login Timing when transferring images by FTP in short duration time.</li> </ul>
Timer mode transfers older images.	Short interval of Image Buffer Frequency makes Network Camera transfer the older images. Set the interval long enough to transfer the images. Buffered Image screen enables you to check this setting.

### About Network Camera Setup

Problem	Cause and Remedy
Wireless communication does not work.	<ul style="list-style-type: none"> <li>• Signal strength is weak. Change the location of Network Camera or remove the obstacles around Network Camera.</li> <li>• SSID and Encryption setting of Network Camera are different from those of the wireless router or the wireless LAN card of PC. SSID and Encryption setting must be identical for Network Camera and wireless router.</li> <li>• Remove the Ethernet cable and reconnect the AC adaptor for Network Camera to recognize the Wireless Communication mode.</li> </ul>
Wired communication does not work.	Reconnect AC adaptor for Network Camera to recognize the change from wireless to wired communication or vice versa.
Update Firmware has not finished.	<p>When Update Firmware is interrupted by power off, or for network troubles and other problems, follow the procedure below.</p> <div style="text-align: center;"> <pre>                     graph TD                         A[Turn on Network Camera and the PC.] --&gt; B[Enter the IP address on the web browser to access Network Camera.]                         B --&gt; C{Top Page or Update Firmware window?}                         C -- Top Page --&gt; D[Access Setup Page or Status window. Check the Firmware Version Number.]                         C -- Update Firmware window --&gt; H[Perform Update Firmware*1.]                         D --&gt; E{Is the Version wished number?}                         E -- Yes --&gt; H                         E -- No --&gt; H                         H --&gt; F[Update Firmware is completed.]                     </pre> </div> <div style="display: flex; align-items: center; margin-top: 10px;">  <div> <p>Network Camera Version ***</p> </div> </div> <p style="text-align: center; margin-top: 10px;">*<sub>1</sub> Refer to page 91 for the Update Firmware.</p>

### About Top View Image screen

Problem	Cause and Remedy
<p>The Top View Image screen (Single Camera/ Multi-Camera) does not appear.</p>	<ul style="list-style-type: none"> <li>• If you are using Internet Explorer, the first time the PC connects to Network Camera, a pop-up <b>Security Warning window</b> will appear to download ActiveX Controls. When using Windows NT, Windows 2000 or Windows XP, log on with an appropriate account that is authorized to install applications. Refer to page 43 for ActiveX Controls.</li> <li>• On the Air time setting on page 68 may restrict the access to Top View Image screen. Blue screen appears.</li> <li>• Maximum 30 users can view the Motion JPEG simultaneously on the network. The 31st user views the blue screen on the Network Camera screen. Blue screen appears.</li> <li>• Network congestion may prevent the Top View Image screen from appearing quickly. Wait for a while.</li> <li>• The proxy server may prevent you from connecting directly to Network Camera, set up not to use the proxy server. Refer to page 26 for details.</li> </ul>
<p>Pan/Tilt does not work. (including Click to Center and Preset Positioning)</p>	<ul style="list-style-type: none"> <li>• Click <b>[Refresh]</b> on the web browser when the communication stops with Network Camera. The image will refresh.</li> <li>• Other clients may be operating Pan/Tilt.</li> <li>• Pan/Tilt operation has reached the end of corner. Confirm End Display appears on operation bar on page 46.</li> <li>• The Pan/Tilt operation may be locked. Refer to page 82 for <b>Camera Setup window</b>.</li> <li>• Pan/Tilt Range values may have been specified. Assign appropriate Pan/Tilt Range values. Refer to page 82 for Camera Setup window.</li> </ul>
<p>Image is out of focus.</p>	<ul style="list-style-type: none"> <li>• The Lens Cover is dirty or dust is attached. Clean the Lens Cover with lens cleaner.</li> <li>• Network Camera cannot focus on an image within 1 m (40 inches). Keep the object more than 1 m (40 inches) off the lens.</li> </ul>
<p>The color of the image is strange.</p>	<ul style="list-style-type: none"> <li>• Adjust White Balance by <b>Camera Setup window</b>. Refer to page 82.</li> <li>• Confirm that the color setting of the PC is 16 bits or more.</li> </ul>

**About Top View Image screen**

<b>Problem</b>	<b>Cause and Remedy</b>
Image flickers.	<ul style="list-style-type: none"> <li>• If the object is dark, the image will flicker. Make the condition around Network Camera brighter.</li> <li>• Wrong power line frequency makes images flicker. Refer to page 82.</li> </ul>
Refresh interval is longer than the setup.	<ul style="list-style-type: none"> <li>• The traffic of the network, PC performance and the object of the image affect the refresh interval. The network congestion causes refresh interval slower than the set up.</li> <li>• When more than one client are viewing, the refresh interval becomes slower.</li> <li>• Ethernet switching hub can smooth the refresh interval especially in viewing on the Multi-Camera screen.</li> <li>• Restrict the Max. Bandwidth Usage to improve network traffic in viewing on the Multi-Camera screen. Refer to page 61.</li> </ul>
Suddenly image changes to JPEG - Regularly Refresh.	The duration time to display Motion JPEG is limited on <b>Top View Image Setting window</b> on page 68.
Only half of the image is displayed.	If using Internet Explorer 4.0, use Internet Explorer 5.0 or later.
The unreadable characters are displayed.	<ul style="list-style-type: none"> <li>• Use the operating system of the selected language.</li> <li>• Set the Encoding or the Character Set of the selected language on the web browser.</li> </ul>

**About Other Troubles**

<b>Problem</b>	<b>Cause and Remedy</b>
When you cannot solve your problem	<ul style="list-style-type: none"> <li>• Call our customer call center at 1-800-272-7033.</li> <li>• After the limited warranty, call our Continued Services Technical Support Line at 1-900-555-PANA (1-900-555-7262).</li> </ul>

## 5.5 Confirmation of Network Camera Operation

This procedure checks the Network Camera operation. IP address of the PC has to be on the same network to be able to access Network Camera. If Top Page appears, Network Camera has no defect.

1. Push the **CLEAR SETTING** button as illustrated on page 112. All settings on Network Camera will be set to default.
2. Connect locally between the PC and Network Camera like [Type 1] or [Type 4] configuration type shown on page 18 and page 19.
3. Follow the next steps distinguished by the operating system in the next table to open **TCP/IP Properties window**.

**TCP/IP Properties Table**

<b>Operating System</b>	<b>Steps</b>
Windows 95 Windows 98 Windows Me	[Start] → [Settings] → [Control Panel] → [Network] → Select [TCP/IP] with adaptor in use → [Properties] → [Specify an IP address]
Windows NT	[Start] → [Settings] → [Control Panel] → [Network] → [Protocols] tab → [TCP/IP Protocol] → [Properties] → Select [Adaptor] in use → [Specify an IP address]
Windows 2000	[Start] → [Settings] → [Control Panel] → [Network and Dial-up Connections] → [Local Area Connection Icon] in use → [Properties] → Select Internet Protocol [TCP/IP] → [Properties] → [Use the following IP address]
Windows XP	[Start] (→ [Settings]) → [Control Panel] → [Network and Internet Connections] → [Network Connections] → [Local Area Connection Icon] in use → [Properties] → Select Internet Protocol [TCP/IP] → [Properties] → [Use the following IP address]

### **Note**

When using Windows NT, Windows 2000 and Windows XP, log on as an administrator to access **TCP/IP Properties window**.

4. Record the current **TCP/IP properties** of the PC. They are important in the later procedure to set the TCP/IP properties of the PC back.
5. Enter "192.168.0.250" in the IP address field and "255.255.255.0" in the Subnet Mask field and click **[OK]**.  
(Windows 95, Windows 98 and Windows Me must restart to activate the entered TCP/IP properties.)
  - Set up the unique IP address which does not overlap other IP addresses on the network. Overlapped IP addresses on the network cause the disorder of the network.
6. Start up the web browser. Enter "**http://192.168.0.253**" in the address field and press **[Enter]**. If Top Page appears, Network Camera has no defect.



Click the language to change the display.

### Note

The proxy server may prevent you from connecting directly to Network Camera. Refer to page 26.

7. Set the TCP/IP properties of the PC back to the previous settings recorded in step 4.



## 5.6 FCC and Other Information

This equipment has been tested and found to comply with the limits for a Class B digital device, pursuant to Part 15 of the FCC Rules. These limits are designed to provide reasonable protection against harmful interference in a residential installation. This equipment generates, uses, and can radiate radio frequency energy and, if not installed and used in accordance with the instructions, may cause harmful interference to radio communications. However, there is no guarantee that interference will not occur in a particular installation. If this equipment does cause harmful interference to radio or television reception, which can be determined by turning the equipment off and on, the user is encouraged to try to correct the interference by one or more of the following measures:

- Reorient or relocate the receiving antenna.
- Increase the separation between the equipment and receiver.
- Connect the equipment into an outlet on a circuit different from that to which the receiver is connected.
- Consult the dealer or an experienced radio/TV technician for help.

Some wireless Network Cameras operate at frequencies that may cause interference to nearby TVs and VCRs. To minimize or prevent such interference, the base of the wireless Network Camera should not be placed near or on top of a TV or VCR. If interference is experienced, move the wireless Network Camera further away from the TV or VCR. This will often reduce or eliminate, interference. Operating near 2.4 GHz electrical appliances may cause interference. Move away from the electrical appliances.

**Environment:** Do not install Network Camera where the temperature is less than -20 °C (-4 °F) or greater than 50 °C (122 °F). Allow 10 cm (4 inches) clearance around the unit for proper ventilation. Avoid excessive smoke, dust, mechanical vibration, shock, or direct sunlight.

**Routine care:** Wipe the unit with a soft cloth. Do not use benzene, thinner, or any abrasive powder. When you leave the unit unused for a long period of time, unplug the AC adaptor from the outlet.

**If there is any trouble:** Consult an authorized Panasonic Factory Service Center.

## CAUTION

- To comply with FCC RF exposure requirements in uncontrolled environment:
  - This equipment must be installed and operated in accordance with provided instructions and a minimum 20 cm (8 inches) spacing must be provided between antenna and all person's body (excluding extremities of hands, wrist and feet) during wireless modes of operation.
  - This transmitter must not be co-located or operated in conjunction with any other antenna or transmitter.
- **Medical**

Consult the manufacturer of any personal medical devices, such as pacemakers, to determine if they are adequately shielded from external RF (radio frequency) energy. (The unit operates in the frequency range of 2400 MHz to 2483.5 MHz, and the power output level is 0.1 watts.) Do not use the unit in health care facilities if any regulations posted in the area instruct you not to do so. Hospitals or health care facilities may be using equipment that could be sensitive to external RF (radio frequency) energy.
- Any changes or modifications not expressly approved by the party responsible for compliance could void the user's authority to operate this device.

No responsibility will be taken by our company with respect to consequences resulting from the use or the damage or both of Network Camera.

## 5.7 Glossary

### AdHoc

AdHoc mode is a wireless network system in which devices communicate directly with each other, without the use of a wireless router.

### CSMA/CA

Short for **C**arrier **S**ense **M**ultiple **A**ccess/**C**ollision **A**voidance. CSMA/CA is a network collision detection and resolution technique on a wireless network.

### DS-SS

Short for **D**irect **S**equence **S**pread **S**pectrum. DS-SS is one of the modulation on the wireless communication.

### Encryption (WEP)

Short for **W**ired **E**quivalent **P**rivacy. WEP is a security protocol for wireless network defined in the IEEE 802.11b standard. WEP aims to provide security by encrypting data over radio waves so that it is protected as it is transmitted from one end point to another.

### IEEE 802.11b

IEEE 802.11b refers to the specifications developed by the IEEE for wireless network technology. It provides 11 Mbps transmission in the 2.4 GHz band using only DS-SS. It allows the wireless communication without complicated cabling.

### Infrastructure

Infrastructure mode is one of the wireless network system in which devices communicate with each other by first going through the wireless router. In infrastructure mode, wireless devices can communicate with each other or can communicate with a wired network.

### SSID (ESSID)

Short for **S**ervice **S**et **I**dentifier. SSID acts as a password when a wireless devices tries to connect on the wireless network. All wireless devices must use the same SSID. SSID is also called as ESSID.



# Index

## A

AC adaptor 12, 20, 98, 120  
ActiveX Controls 43  
AdHoc mode 33, 131  
Administrator 64  
Alarm Mode 72  
Alarm trigger 72, 73  
ASCII character table 108  
Authentication 11, 40, 65, 67  
Auto Adjustment 63

## B

Brightness 83  
Buffered Image 50, 71, 73, 74, 77, 78, 80

## C

Cabling 98  
Camera Name 62  
Camera Setup 82  
Category 5 cable 98  
CATV/xDSL/Optical cable modem 18  
Channel 33  
Circuit diagram 107  
CLEAR SETTING button 15, 112  
Click to Center 45  
Configuration window 30  
Connector Cover 98  
CSMA/CA 120, 131

## D

Date and Time 62, 63  
DC IN jack 15, 20, 98  
DC plug 20, 98  
DDNS (Dynamic Domain Name System)  
61  
Default Gateway 22, 60  
Default Key 35  
Default Setting 94, 112, 113  
DHCP (Dynamic Host Configuration Protocol) 60  
DNS server address 22  
DS-SS (Direct Sequence Spread Spectrum) 120, 131

## E

E-mail 75, 77, 81  
Encryption (WEP) 34, 131  
Ethernet 10  
Ethernet port 15, 20, 98  
Ethernet switching hub 18  
External Device Control Output 87, 106  
External I/O 15, 106  
External Output Control 87  
External sensor 106  
External Sensor Input 106

## F

FCC and Other Information 129  
File size of the image 61  
Fixed Focus Lens 14  
Flexible Stand 101, 102, 103  
FTP (File Transfer Protocol) 74, 77, 80

## G

General User 66  
Grounding (Earth) Terminal 15

## H

Help 40, 46  
Home Position Button 47, 48  
Host Name 60

## I

IEEE 802.11b 8, 10, 120, 131  
Image Quality 46  
Image Size 46  
Image Transfer 70  
Important Safety Instructions 4  
Indicator 14, 88  
Indicator Control 88  
Infrastructure mode 33, 131  
Interface 10  
Internet Connection 18  
Internet Direct Connection 19  
Internet Explorer 10  
IP (Internet Protocol) address 22, 25, 60, 86

**J**

JPEG - Regularly Refresh 42, 51, 69

**L**

LAN/Intranet 18

Limit time of Continuous Motion JPEG 69

**M**

MAC address 15, 29

Max. Bandwidth Usage 22, 61

Motion JPEG 42

Mounting 101

MS-DOS Prompt 23

Multi Client Access 9

Multi-Camera 52, 85

Multi-Language 41, 68

**N**

Netscape Navigator 10

Network Protocol 10

Network window 58

Non Transfer mode 71

NTP (Network Time Protocol) 63

**O**

On the Air time 69

Operating System 10

Operation Bar 46

**P**

Pan Range 83

Pan/Tilt 14, 47, 83

Pan/Tilt Scan 47

Password 11, 40, 65, 67

Port Forwarding (IP Masquerade) 37

Port No. 22, 59

Power 120

Power Line Frequency 83

PPPoE (Point-to-Point Protocol over Ethernet) 19

Preset Button 48, 49

Preset Positioning 48, 83

Primary time 73, 77, 79

Private IP address 25

Putty 100

**R**

Resolution 46, 69

Restart 90

RJ-45 connector 120

**S**

Screws 12, 99

Screws for Flexible Stand 12, 102, 103

Secondary time 73, 79

Security 11, 40, 64, 66

Self Bonding tape 100, 102, 103

Serial Number 15

Setup CD-ROM 12, 13

Setup Page 53

Single Camera 44

Splash Resistant body 8, 96

SSID (ESSID) 33, 131

Static 22, 60

Status 89

Subnet Mask 22, 25, 60

Sunshade 99

**T**

TCP/IP 10

TCP/IP Properties window 24, 25, 127

Tilt Range 83

Timer Mode 78

Timer trigger 79

Top Page 31, 36, 38, 40, 41, 57, 128

Top View Image 40, 68

Tripod Mounting Hole 15

**U**

Update Firmware 91

**W**

Web browser 10

White Balance 82, 119

Windows 10, 24, 127

Wireless Authentication 35

Wireless Communication Speed 33

Wireless network parameters 32

Wireless Router 37  
Wireless window 32





### For product service

- Panasonic Servicers are listed in the servicer directory.
- Call 1-800-272-7033 for the location of an authorized servicer.
- After the limited warranty, please contact our Continued Services Technical Support Line at 1-900-555-PANA (1-900-555-7262). If you have difficulty reaching this number, it may be blocked by your phone company. Please contact your local phone company to correct this.
- This Network Camera is designed for use in the United States of America. Sale or use of this product in other countries/areas may violate local laws.

### When you ship the product

- Carefully pack your unit, preferably in the original carton.
- Attach a letter, detailing the symptom, to the outside of the carton.

Symptom \_\_\_\_\_

- Send the unit to an authorized servicer, prepaid and adequately insured.
- Do not send your unit to the Panasonic Consumer Electronics Company listed below or to executive or regional sales offices. These locations do not repair consumer products.

Operating Instructions are subject to change without notice.

#### **Panasonic Consumer Electronics Company, Division of Matsushita Electric Corporation of America**

One Panasonic Way, Secaucus, New Jersey 07094

#### **Panasonic Sales Company, Division of Matsushita Electric of Puerto Rico, Inc.**

Ave. 65 de Infantería, Km. 9.5, San Gabriel Industrial Park  
Carolina, Puerto Rico 00985

#### **Copyright:**

This manual is copyrighted by Panasonic Communications Co., Ltd. (PCC). Under the applicable copyright laws, this manual may not be reproduced in any form, in whole or part, without the prior written consent of PCC and its licensee.

© 2002 Panasonic Communications Co., Ltd. All Rights Reserved.