

Panasonic

Cordless Phone

Model No. **KX-TC162-B**

Pulse-or-tone dialing capability

Operating Instructions



SOUND CHARGER PLUS

24 Channel

Contents by Section

- 1 Getting Started
- 2 Making/Answering Calls
- 3 Speed Dialer
- 4 Special Features
- 5 Things You Should Know
- 6 Referencia rápida (Spanish)

**PLEASE READ BEFORE USE
AND SAVE.**

**Charge the battery for about
10 hours before initial use.**

Attach your purchase receipt here.

For your future reference

Serial No. _____

Date of purchase _____

(found on the bottom of the unit)

Name and address of dealer _____

For product service

- Panasonic Servicenters are listed in the servicenter directory.
- Call 1-800-211-PANA(7262) for the location of an authorized servicenter.

When you ship the product

- Carefully pack your unit, preferably in the original carton.
- Attach a letter, detailing the symptom, to the outside of the carton.

Symptom _____

- Send the unit to an authorized servicenter, prepaid and adequately insured.
- Do not send your unit to the Panasonic Consumer Electronics Company listed below or to executive or regional sales offices. These locations do not repair consumer products.

**Panasonic Consumer Electronics Company,
Division of Matsushita Electric Corporation of America**
One Panasonic Way, Secaucus, New Jersey 07094

**Panasonic Sales Company,
Division of Matsushita Electric of Puerto Rico, Inc.**
Ave. 65 de Infantería, Km. 9.5, San Gabriel Industrial Park,
Carolina, Puerto Rico 00985

1-A Accessories

☐ AC Adaptor : KX-TCA51-SS

.....one

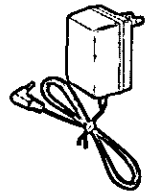

☐ Telephone Line Cord

.....one

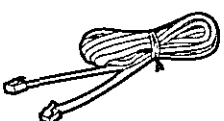

• To order accessories, call 1-800-332-5368.

1-B Location of Controls

Handset

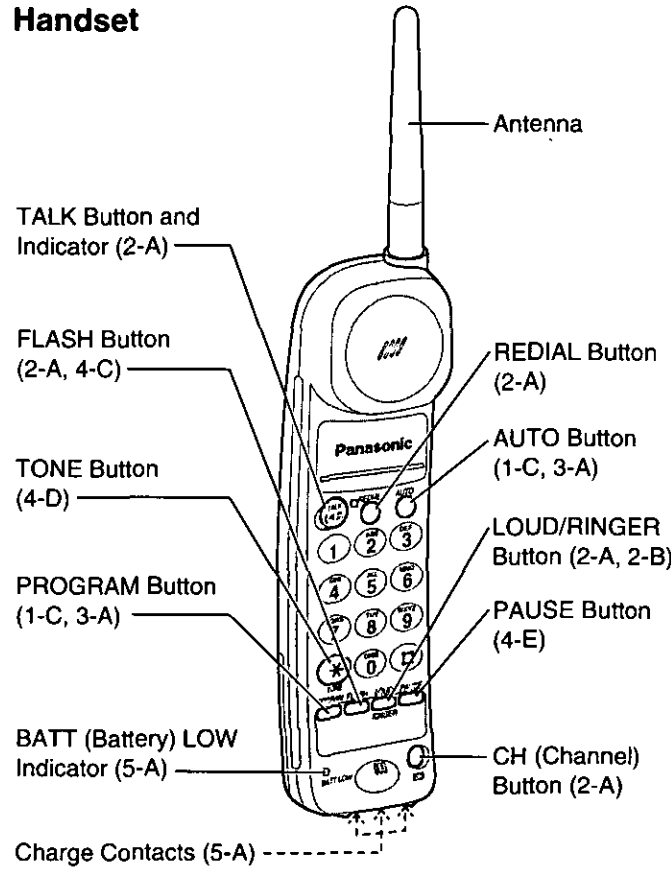

Base Unit

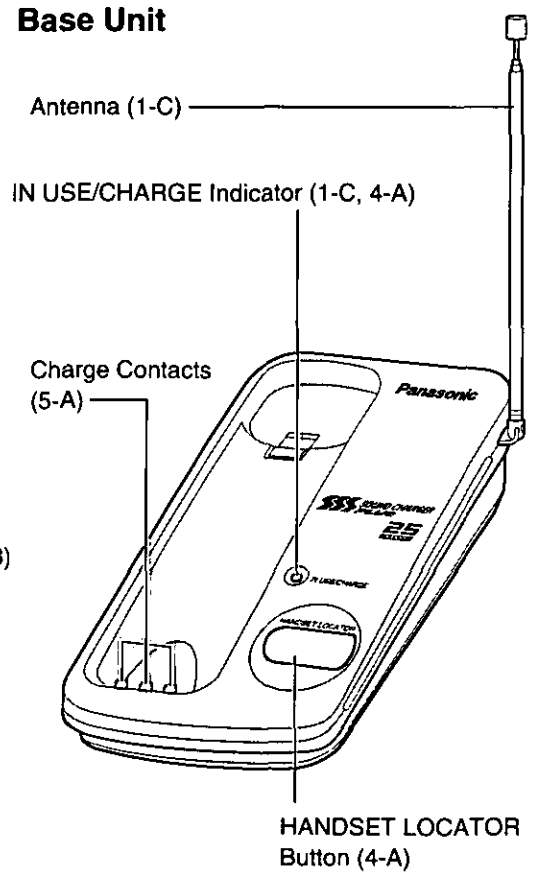

1-C Setting Up

1 Connect as shown.

2 Extend the antenna fully.

STOP 3 Charge the battery for about 10 hours.

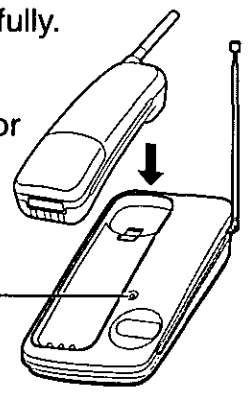
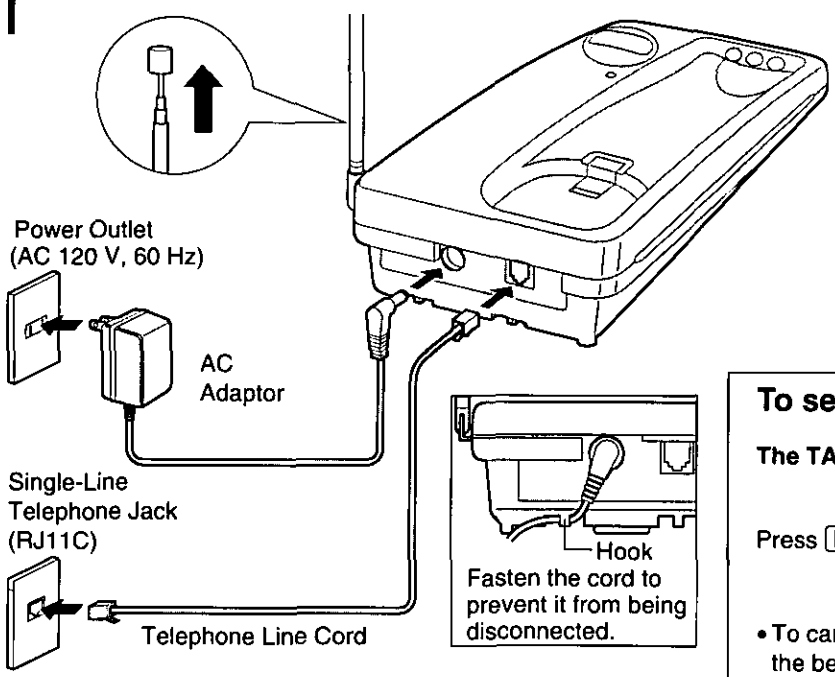

• See section 5-A for more details.
• The IN USE/CHARGE indicator lights.

- USE ONLY WITH Panasonic AC ADAPTOR KX-TCA51-SS
- The AC adaptor must remain connected at all times. (It is normal for the adaptor to feel warm during use.)
- To connect a standard telephone on the same line, see section 5-F.

To select the dialing mode TONE (preset) or PULSE

The TALK indicator light must be off before programming.

Press **PROGRAM** → **#** twice (PULSE) OR **PROGRAM** → ***** twice (TONE)

- To cancel during programming, press **PROGRAM**, then restart from the beginning.
- If 3 beeps sound during programming, a wrong key was pressed. Restart from the beginning.

*A confirmation tone sounds as follows:
1 beep: The mode is different from the previously selected one.
2 beeps: The mode is the same as the previously selected one.

2-A Making Calls

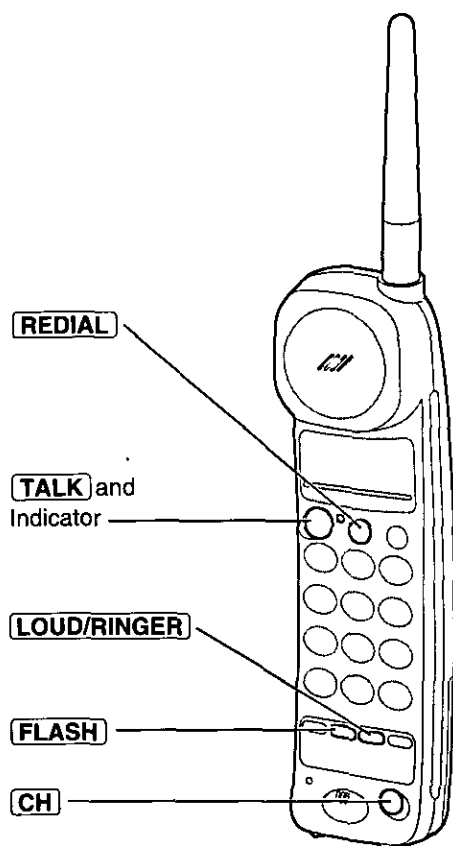

- 1 Press **TALK** .
 - The indicator lights.
 - If an alarm tone sounds, see 5-E.
- 2 Dial a telephone number.
- 3 To hang up, press **TALK** or place the handset on the base unit.
 - The TALK indicator light goes out.

OPERATING DISTANCE

To maximize the distance of the handset from the base unit, see section 5-C.

If you misdial

Press **FLASH** firmly. ➔ Dial again.

To redial the last number dialed

Press **TALK** ➔ **REDIAL** .

To select the receiver volume

Press **LOUD/RINGER** while talking.

- Each time you press the button, the volume level will change from MEDIUM (preset) to HIGH to LOW.

If noise interferes with the conversation

Press **CH** to select a clear channel or move closer to the base unit.

2-B Answering Calls

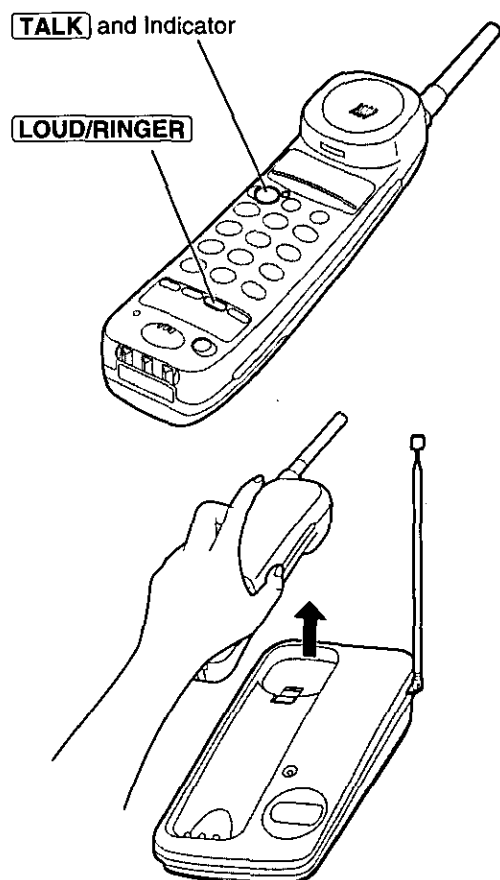

If the handset is off the base unit, press **TALK** .

- You can also answer a call by pressing any dialing button 0 to 9, *, or # (- Any Key Talk).

OR

If on the base unit, just lift up.

Adjusting the ringer volume

The TALK indicator light must be off.

- To select **HIGH** (preset) or **LOW**, press **LOUD/RINGER** briefly. (Each time you press the button briefly, the selected volume will ring and the ringer volume will change.)
- To turn the ringer **OFF**, press and hold **LOUD/RINGER** until 2 beeps sound.
- To turn the ringer **ON**, press **LOUD/RINGER** briefly. The ringer will sound at the HIGH level.



3-A Storing Phone Numbers in Memory

You can store up to 10 phone numbers. The dialing buttons (0 to 9) function as memory stations.

The TALK indicator light must be off before programming.

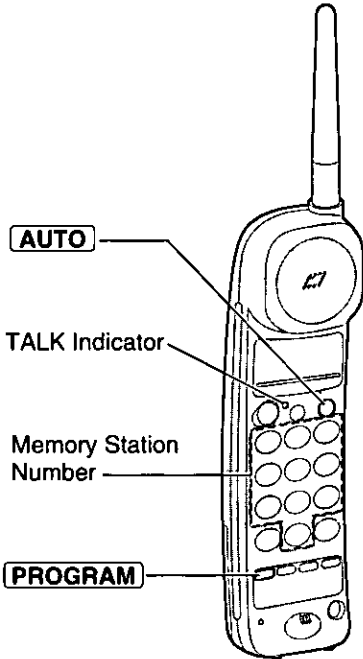

- 1 Press **PROGRAM**.
 - The TALK indicator flashes.
- 2 Enter a phone number up to 16 digits.
- 3 Press **AUTO**.
- 4 Press a memory station number (0 to 9).
 - A confirmation tone sounds. (See right side.)
 - The TALK indicator light goes out.
 - To store other numbers, repeat steps 1 through 4.
 - If a pause is required for dialing, **PAUSE** can be stored in a phone number counting as one digit (4-E).

If you misdial

Press **PROGRAM** to end storing.

➔ Restart from step 1.

To erase a stored number

Press **PROGRAM** ➔ **AUTO** ➔

the memory station number (0 to 9) for the phone number to be erased.

• A beep sounds.

What the confirmation tone means

1 beep: The new number is stored.

2 beeps: The number is the same as the previously stored one.

3-B Dialing a Stored Number

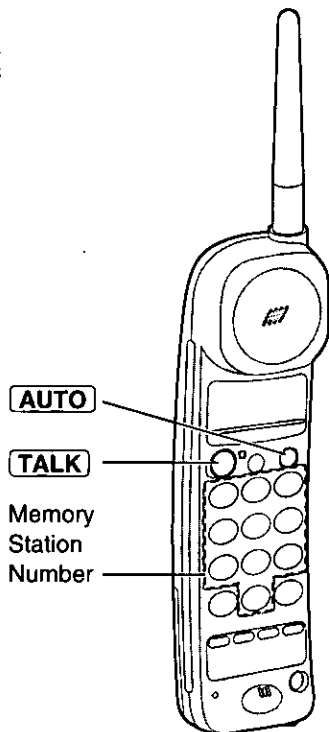

- 1 Press **TALK**.
- 2 Press **AUTO**.
- 3 Press the memory station number (0 to 9).
 - The stored number is dialed.

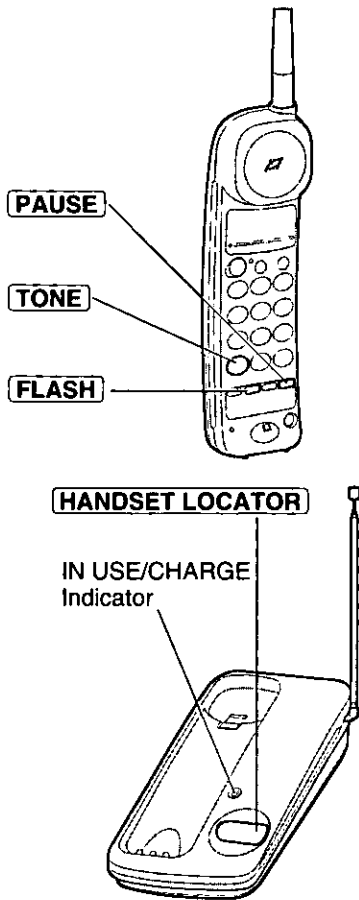

4-A Handset Locator

You can locate the handset or page the handset user with beep tones.

- 1 Press **HANDSET LOCATOR** on the base unit.
 - The IN USE/CHARGE indicator flashes and the handset beeps for 1 minute.
- 2 To stop paging, press **HANDSET LOCATOR** again or press **TALK** twice on the handset.

4-B Automatic Security Code Setting

Whenever you place the handset on the base unit, the unit automatically selects one of 65,000 security codes. These codes help prevent the unauthorized use of your telephone line by another cordless telephone.

4-C For Call Waiting Service Users

Press **FLASH** briefly if you hear a call-waiting tone while talking.

- The first call is put on hold and you can answer the second call.
- To return to the first caller, press **FLASH** again.

4-D Temporary Tone Dialing (For Rotary or pulse Service Users)

Press **TONE** before entering access numbers which require tone dialing.

- The dialing mode changes to tone. You can enter numbers to access answering service, electronic banking service, etc. When you hang up, the mode will return to pulse.

4-E How to Use the PAUSE Button (For Analog PBX Line/Long Distance Service Users)

We recommend you press **PAUSE** if a pause required for dialing with a PBX or to access a long distance service.

Ex: Line access number **9** (PBX)

9 ➔ **PAUSE** ➔ Phone number

- Pressing **PAUSE** once creates a 3.5 second pause. This prevents misdialing when you redial or dial a stored number.
- Pressing **PAUSE** more than once increase the length of the pause between numbers.

5-A Battery

Recharge

When the BATT LOW indicator flashes or the unit beeps intermittently, place the handset on the base unit to recharge the battery for about 10 hours.

- If you **DO NOT** recharge the handset battery for more than 30 minutes, the BATT LOW indicator will continue to flash.

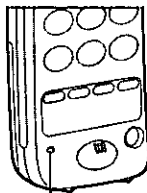

BATT LOW Indicator

Battery information

If your Panasonic battery is fully charged;

Operation	Approx. battery life
While in use (TALK)	Up to about 8 hours
While not in use (Stand-By)	Up to about 30 days

- Battery life may vary depending on usage conditions and ambient temperature.
- The battery cannot be overcharged.
- **Clean the handset and the base unit charge contacts with a soft dry cloth once a month. Clean more often if the unit is subject to grease, dust or humidity.** If not, the battery may not charge properly.
- After your Panasonic battery is fully charged, you do not have to place the handset on the base unit until the BATT LOW indicator flashes. This will maximize the battery life.

5-C Base Unit Location

Calls are transmitted between the base unit and the handset using wireless radio waves. **For maximum distance and noise free operation**, the recommended base unit location is:

Away from electrical appliances such as a TV, radio, or personal computer.

In a **HIGH** and **CENTRAL** location with no obstructions such as walls.

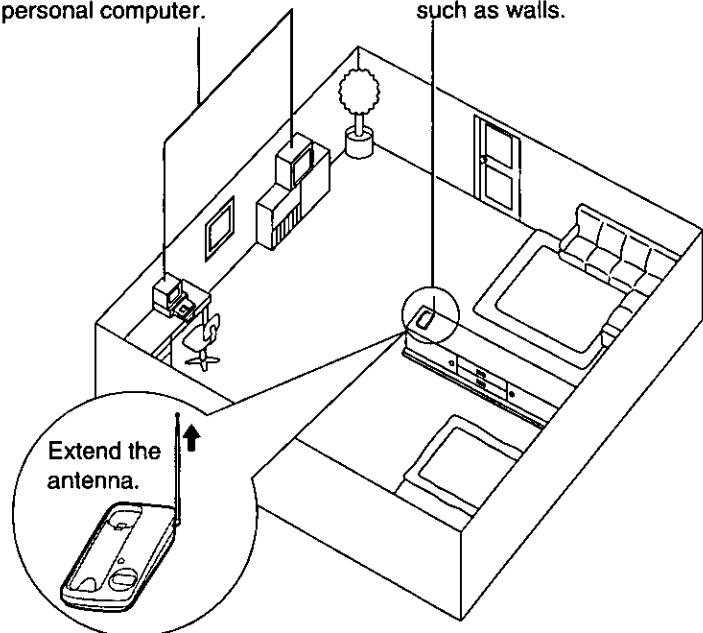

5-B Battery Replacement

If the BATT LOW indicator flashes after being fully charged, replace the battery with a new Panasonic P-P301 (KX-A36A) battery. To order, call 1-800-332-5368. To prevent memory loss, replace within 5 minutes.

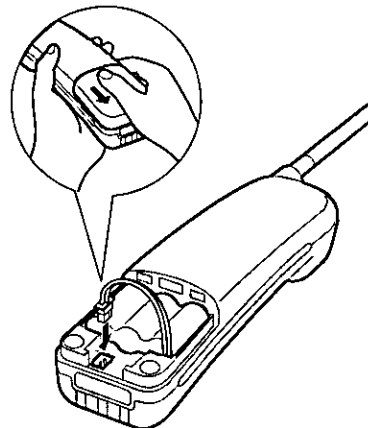

- 1 Remove the cover by sliding it while pressing the arrow.
- 2 Replace the battery, then close the cover.
- 3 Be sure to charge the new battery for about 10 hours.

Attention:

—The product you have purchased is powered by a nickel cadmium battery which is recyclable. At the end of its useful life, under various state and local laws, it is illegal to dispose of this battery into your municipal waste stream. Please call 1-800-8-BATTERY for information on how to recycle this battery.



5-D Wall Mounting

This unit can be mounted on a wall phone plate.

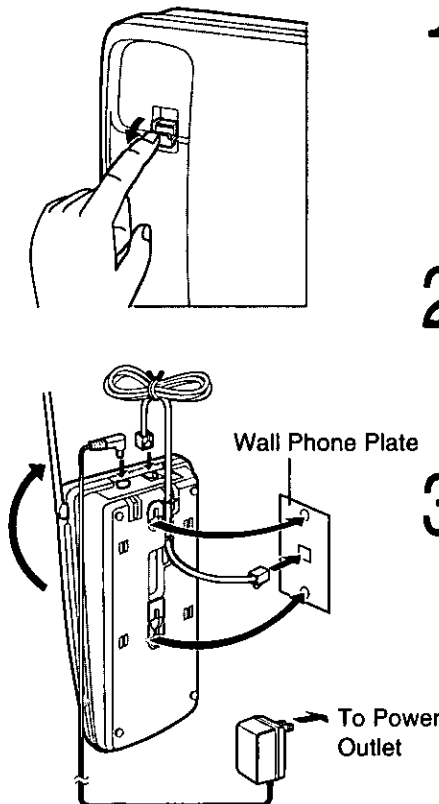

- 1 Pull down the handset hook until it locks, **so the tab holds the handset.**
- 2 Connect the AC adaptor and telephone line cord.
- 3 Mount the unit then slide down.
 - Extend the antenna fully.

5-E Before Requesting Help

Problem	Remedy
The unit does not work.	<ul style="list-style-type: none"> • Check the settings (1-C). • Charge the battery fully (5-A). • Clean the charge contacts and charge again (5-A). • Install the battery properly (5-B). • Place the handset on the base unit and unplug the AC adaptor to reset. Plug in, then try again. • Re-insert the handset battery within 5 minutes to avoid memory loss and place the handset on the base unit. Then try again.
An alarm tone sounds when you press TALK .	<ul style="list-style-type: none"> • You are too far from the base unit. Move closer and try again. • Place the handset on the base unit and try again. • Plug in the AC adaptor. • Extend the base unit antenna fully.
Static, sound cuts in/out, fades. Interference from other electrical units.	<ul style="list-style-type: none"> • Locate the handset and the base unit away from other electrical appliances (5-C). • Move closer to the base unit. • Extend the base unit antenna fully. • Press CH to select a clearer channel.

Problem	Remedy
The unit does not ring.	<ul style="list-style-type: none"> • The ringer volume is OFF. Press LOUD/RINGER briefly while the TALK indicator light is off.
You cannot store a phone number in memory.	<ul style="list-style-type: none"> • You cannot store a number while the unit is in the talk mode. • Do not pause for over 30 seconds while storing.
While storing a phone number, the unit starts to ring.	<ul style="list-style-type: none"> • To answer the call, press TALK. The program will be canceled. Store the number again.
HANDSET LOCATOR does not function.	<ul style="list-style-type: none"> • The handset is too far from the base unit or is engaged in an outside call.
The BATT LOW indicator flashes or the unit beeps intermittently.	<ul style="list-style-type: none"> • Charge the battery fully (5-A).
You charged the battery fully, but the BATT LOW indicator flashes.	<ul style="list-style-type: none"> • Clean the charge contacts and charge again (5-A). • Install a new battery (5-B).
If you cannot solve your problem.	<ul style="list-style-type: none"> • Call our customer call center at 1-800-211-PANA(7262).

5-F Adding Another Phone

This unit will not function during a power failure. To connect a standard telephone on the same line, use the Panasonic T-adaptor KX-J66. To order, call 1-800-332-5368.

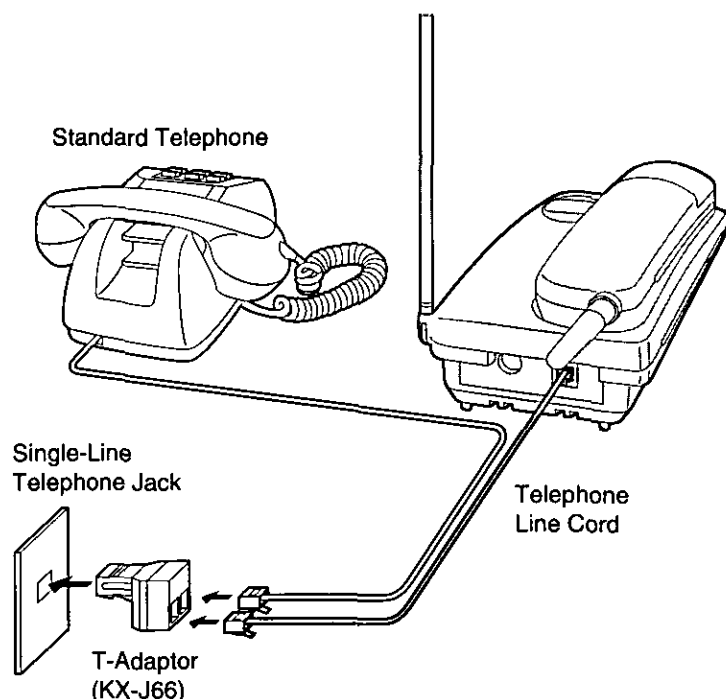

5-G Helpful Information

- **Environment**—do not place the unit in room where the temperature is less than 5°C (41°F) or greater than 40°C (104°F). Allow 10 cm (4") clearance around the unit for proper ventilation. Avoid excessive smoke, dust, mechanical vibration, shock, or direct sunlight.
- **Routine care**—wipe the unit with a soft cloth. Do not use benzine, thinner, or any abrasive powder. When you leave the unit unused for a long period of time, unplug the AC adaptor from the outlet.
- **If there is any trouble**—disconnect the unit from the telephone line and connect a known working phone. If the known working phone operates properly, have your unit repaired by one of the authorized Panasonic Factory Service Centers. If the known working phone does not operate properly, consult with your telephone company.

- This cordless telephone is designed for use in the United States of America. Sale or use of this product in other countries may violate local laws.
- Ce téléphone sans fil est conçu pour être utilisé aux États-Unis d'Amérique. La vente ou l'emploi de cet appareil dans certains autres pays peut constituer une infraction à la législation locale.
- Este teléfono sin cordón fue elaborado para uso en los Estados Unidos de América. La venta o el empleo de este producto en ciertos países puede constituir violación de la legislación local.
- このコードレス電話機は、日本国外での使用を目的として設計されており、日本国内での使用は法律違反となります。従って、当社では日本国内においては原則として修理などのサービスは致しかねます。

6-A Preparación

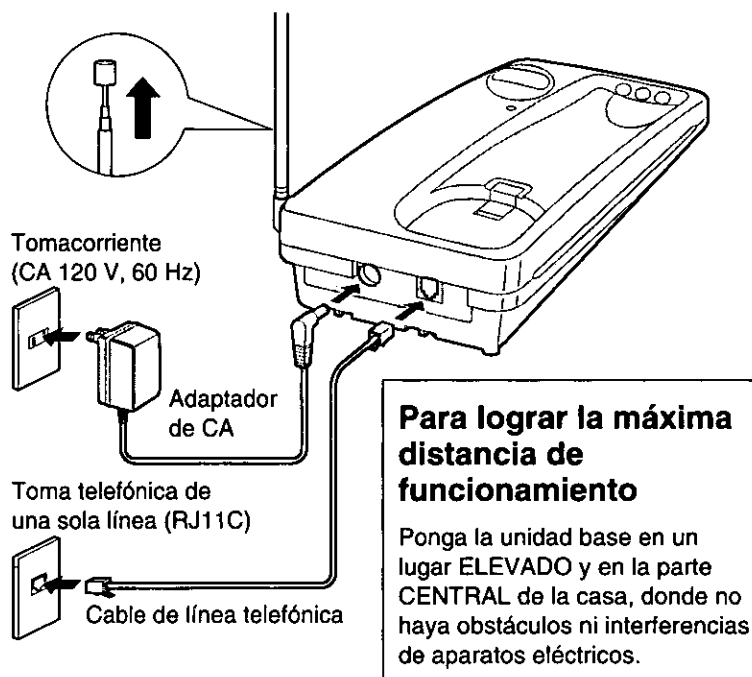

- 1 Conecte como se muestra.
- 2 Extienda completamente la antena.
- 3 Cargue la batería durante unas 10 horas.

• El indicador IN USE/CHARGE se encenderá.

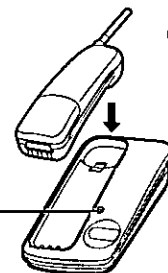

Selección del modo de marcación TONO (preajustado) o PULSO

Presione **PROGRAM** ➔ **AUTO** ➔ **0** ➔ **PROGRAM**

dos veces (PULSO)
 ✕ dos veces (TONE)

6-B Funcionamiento

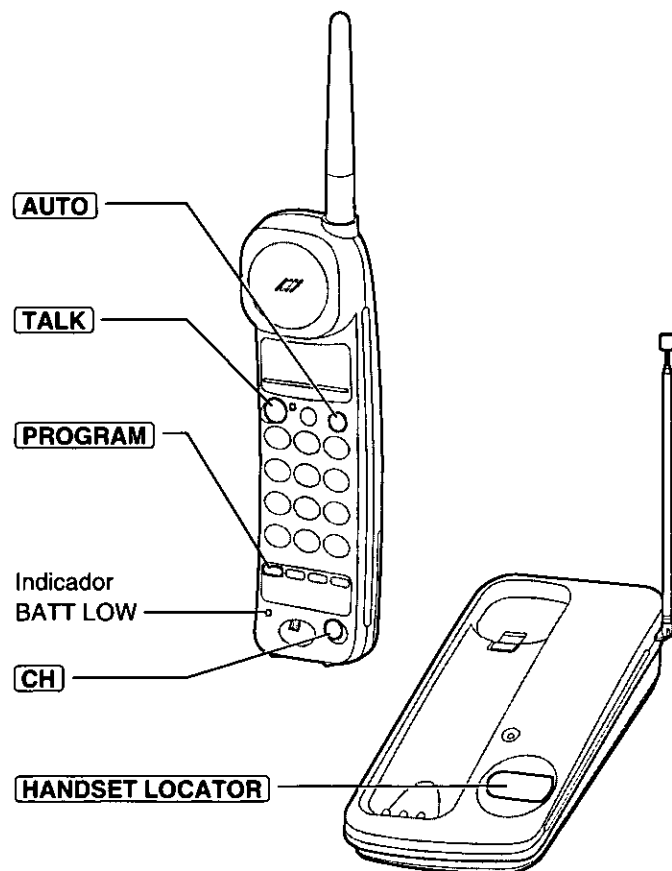

Para hacer llamadas

Presione **TALK** ➔ Marque un número de teléfono. ➔ Cuando termine, presione **TALK** o ponga la unidad portátil en la unidad base.

- Si el ruido interfiere en la conversación, presione **CH** para seleccionar un canal libre o acérquese a la unidad base.

Contestación de llamadas

Si la unidad portátil no está en la unidad base, presione **TALK** o cualquier tecla de marcación (0 a 9, ✕ ó #).

Si la unidad portátil está en la unidad base, simplemente levántela.

Almacenamiento de un número de teléfono en la memoria

Usted puede almacenar hasta 10 números telefónicos. Los botones de marcación (0 a 9) funcionan como estaciones de memoria.

Presione **PROGRAM** ➔ (Número telefónico de hasta 16 dígitos) ➔ **AUTO** ➔ (Número de estación).

Marcación de un número almacenado

Presione **TALK** ➔ **AUTO** ➔ (Número de estación).

Localización de la unidad portátil

Presione **HANDSET LOCATOR**.

- La unidad portátil emite pitidos durante 1 minuto.
- Para detener los pitidos sin haber terminado éstos, presione de nuevo el botón.

- Cuando el indicador BATT LOW parpadee o la unidad emita pitidos intermitentemente, cargue la batería.