

Panasonic

900MHz Cordless Phone

Model No. **KX-TC1720B**

Pulse-or-tone dialing capability

Operating Instructions



2 LINE

DEC 14 1999

**PLEASE READ BEFORE USE
AND SAVE.**

Caller ID Compatible

Charge the battery for about 4 hours before initial use.

Preparation

Basic Operation

Advanced Operation

Useful Information

Before Initial Use

Please read **IMPORTANT SAFETY INSTRUCTIONS** on page 54 before use.
Read and understand all instructions.

Thank you for purchasing your new Panasonic cordless telephone.

Caller ID and Visual Call Waiting (Call Waiting ID), where available, are telephone company services. After subscribing to Caller ID, this phone will display the caller's name and phone number. An added service, Visual Call Waiting, will display the second caller's name and phone number during call waiting.

Attach your purchase receipt here.

For your future reference

Serial No. _____

Date of purchase _____

(found on the bottom of the unit)

Name and address of dealer _____

Accessories (included) For extra orders, call 1-800-332-5368.

- AC Adaptor (p. 11)
Order No. PQLV1Z

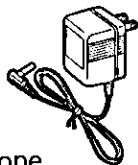

one

- 4-Wire Telephone
Line Cord with
Green Plugs
(p. 12, 13)

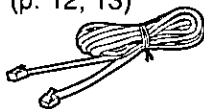

one

- 2-Wire Telephone
Line Cord with
Transparent Plugs
(p. 13)

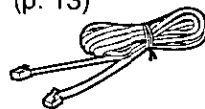

one

For Best Performance

Battery Charge

A rechargeable Ni-Cd battery powers the handset. Charge the battery for about **4 hours** before initial use (p. 14).

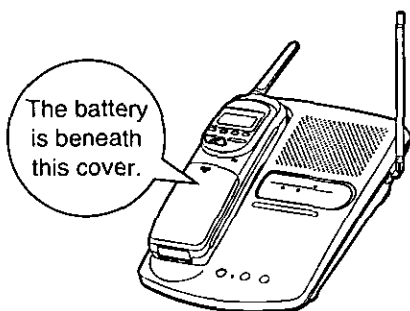

Base Unit Location

Calls are transmitted between the base unit and the handset using wireless radio waves. **For maximum distance and noise-free operation**, the recommended base unit location is:

Away from electrical appliances such as a TV, radio or personal computer.

In a **HIGH and CENTRAL** location with no obstructions such as walls.

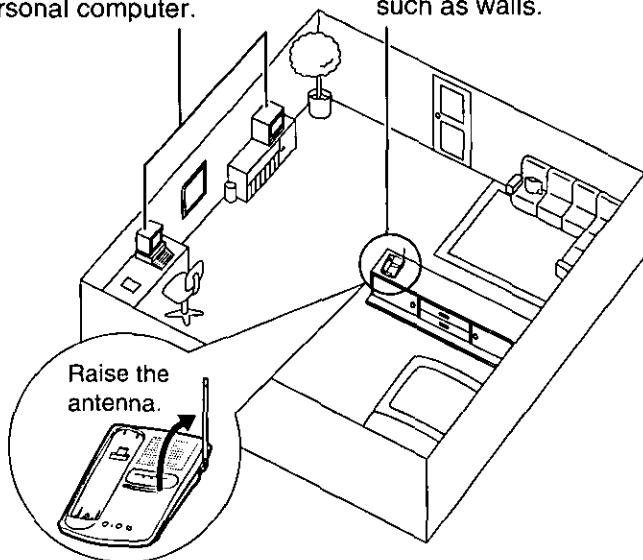

Contents

Preparation

Location of Controls	6
Handset Display	9
Settings	11
Connecting the AC Adaptor	11
Connecting the Telephone Line Cord	12
Battery Charge	14
Selecting the Dialing Mode	16
Selecting the Line Mode	17
Storing Your Area Code	18
Storing a Second Area Code	19
Setting the Auto Talk Feature	20
Selecting the Ringer Volume	21

Basic Operation

Making Calls	22
Answering Calls	25
Speed Dialer	26
Storing Phone Numbers in Memory	26
Dialing a Stored Number	27

Advanced Operation

Caller ID Service	28
Using the Caller List	30
Viewing the Caller List	30
Calling Back from the Caller List	32
Editing the Caller's Phone Number	33
Storing Caller List Information in the Speed Dialer Memory	34
Erasing Caller List Information	35

Voice Mail Service	36
Storing a Voice Mail Access Number	37
Setting the Voice Mail Tone.....	38
Listening to Voice Mail Messages	39
Using the Other Line During a Conversation	40
Conference Call	41
Special Features	42
Handset Locator	42
FLASH Button.....	42
Automatic Security Code Setting.....	43
Temporary Tone Dialing (For Rotary or Pulse Service Users)	43
For Call Waiting Service Users.....	44
How to Use the PAUSE Button (For Analog PBX Line/Long Distance Service Users)	44
Line Selection	45
Incoming Call Tone.....	46

Useful Information

Battery Replacement	47
Wall Mounting	48
Adding Another Phone	49
Before Requesting Help	50
Important Safety Instructions	54
FCC and Other Information	56

Location of Controls

Handset (Front)

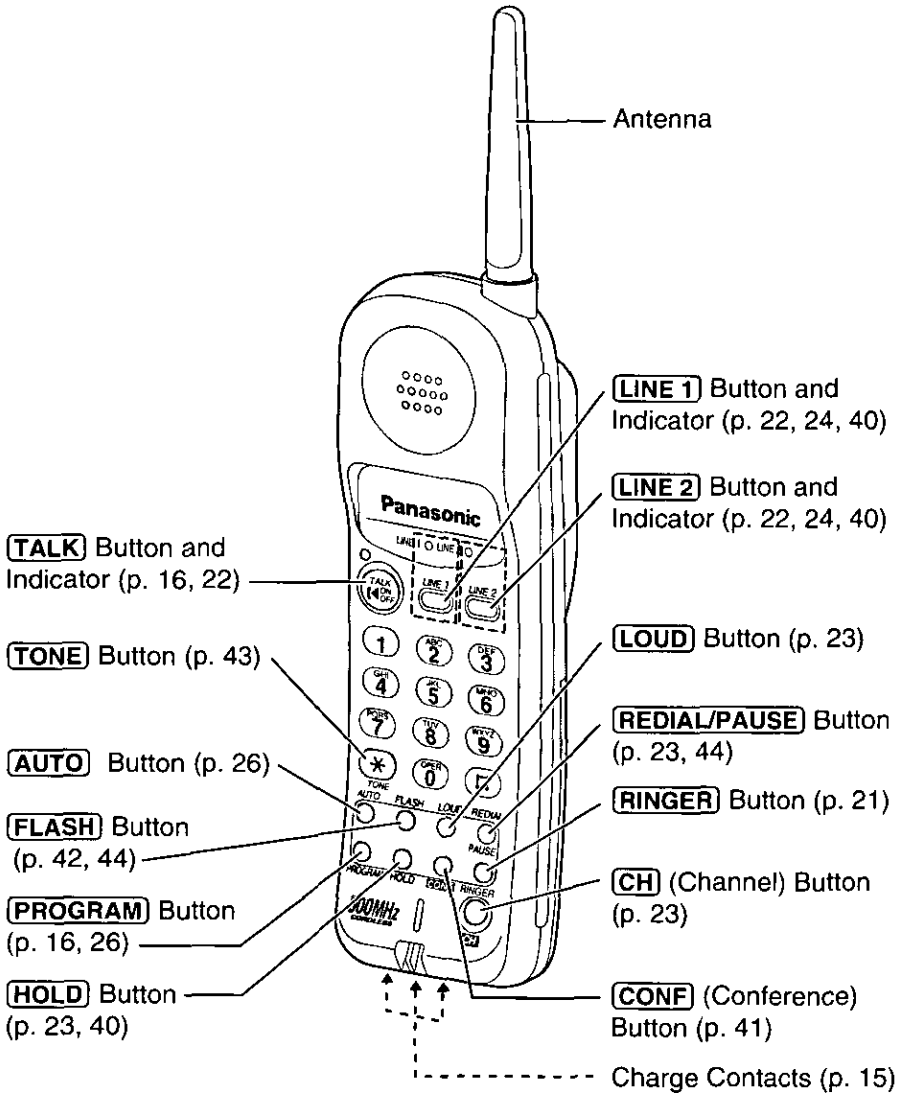



Handset (Back)

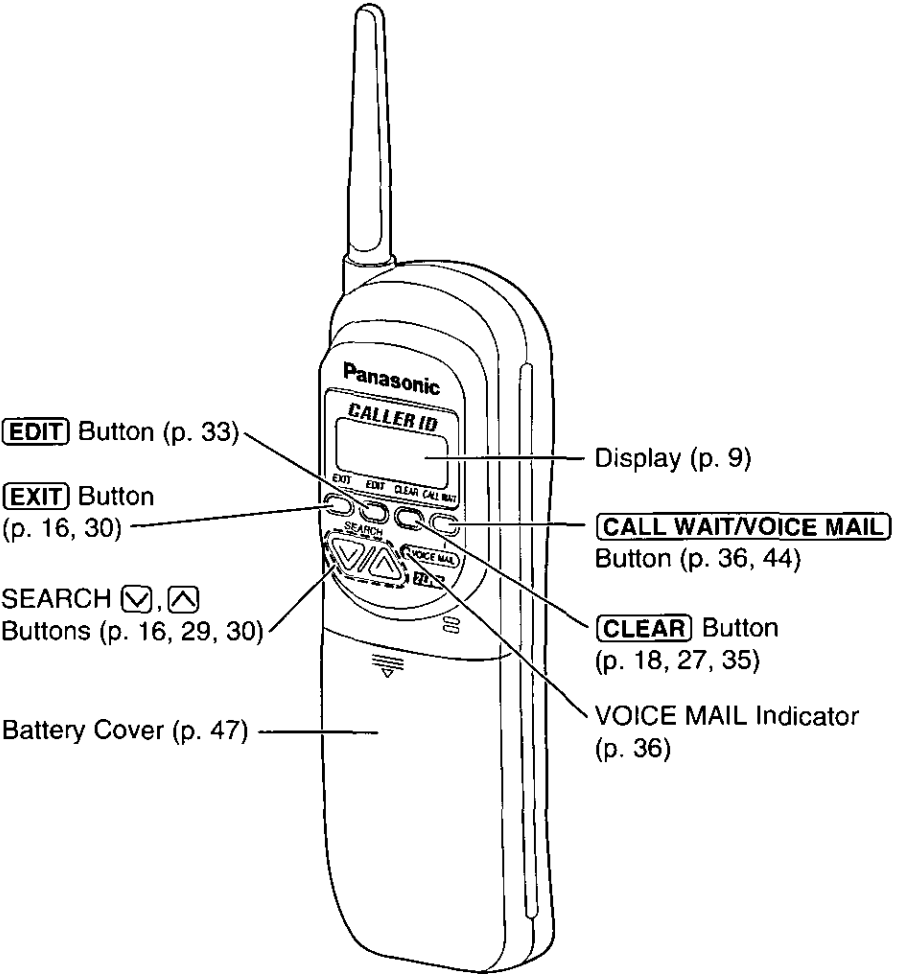

➔ Location of Controls

Base unit

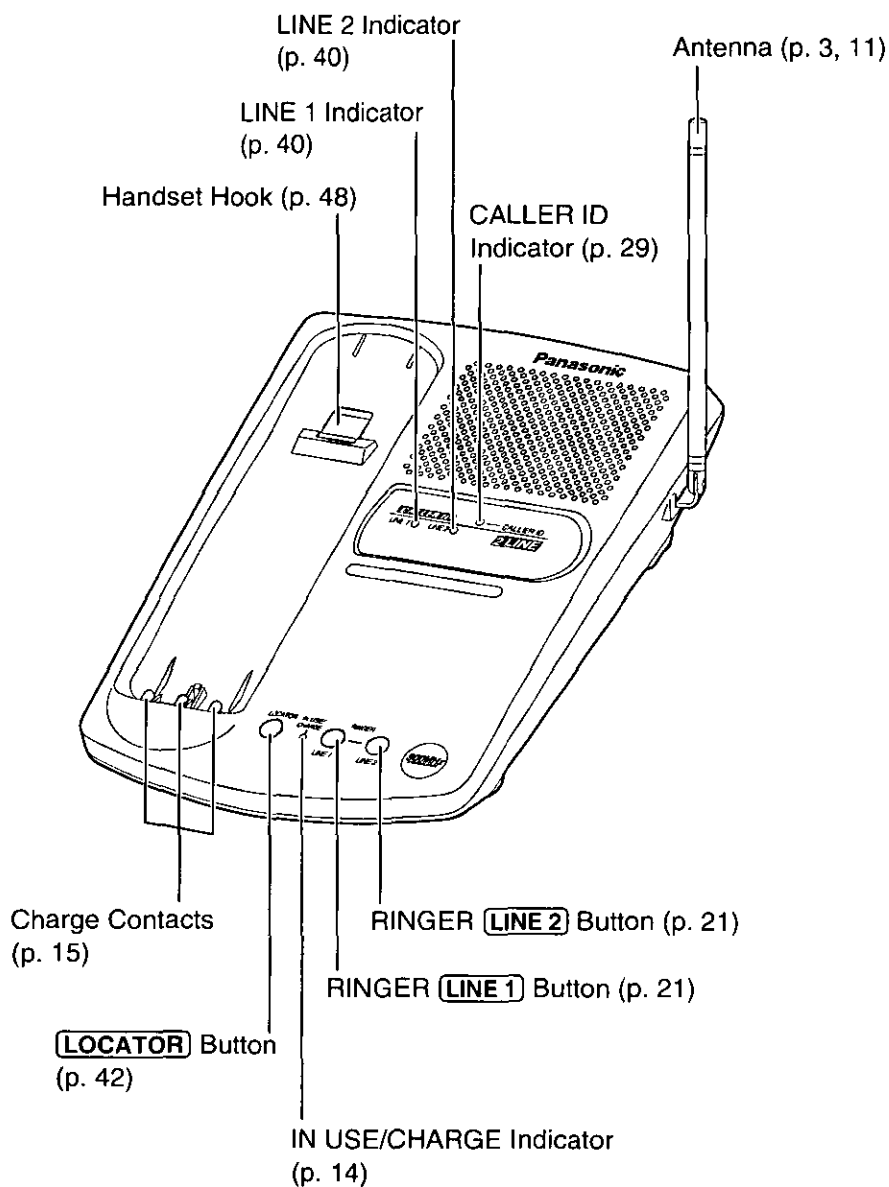

Handset Display



The handset shows you information and instructions on the display. These display prompts are shown below.

No items stored

The Caller List for both lines is empty.

Recharge 



The battery needs to be charged. Place the handset on the base unit to charge the battery (p. 14).



12 new calls



The display shows the number of new calls for both lines and the battery strength (p. 14) while the handset is on the base unit.

12 new calls
v=New ^=Old

This display will be shown when:

- you lift the handset off the base unit, or
- **SEARCH**  or  is pressed when the handset is off the base unit.

To search from the most recent call, press **SEARCH**  (New key). To search from the oldest call, press **SEARCH**  (old key) (p. 30).

 Ringer off 

When the handset ringer volume is set to OFF for both lines (p. 21), "Ringer off" will flash for about 45 seconds before the handset returns to the stand-by mode (p. 15).

Talk
01-06-35 

During a conversation, the display shows the length of the call (ex. 1 hour, 6 minutes and 35 seconds). The battery strength is also displayed.

Out of range

The handset has lost communication with the base unit. Move closer to the base unit.

Save error

While programming, the handset lost communication with the base unit. Move closer to the base unit.

TINA ROBINSON
1-000-222-3333 

When a call is received, the display shows the caller's name, number and the called line after the first ring.

➔ Handset Display

JACK SMITH
111-2222 **1**
11:20A JAN12 x3

This is a name from the Caller List.

The display shows:

- the caller's name,
- the caller's number and the called line,
- the time and date of the last call (ex. Jan. 12, 11:20 AM), and
- the number of times called (ex. 3 times).

Paging

The base unit is paging the handset (p. 42).

Hold
00-01-12 [■■■]

An outside call has been put on hold by the handset user. To release the hold, press the line button whose indicator is flashing (p. 23).

NANCY BROWN
1-000-222-3333**1**
----Waiting----

A second call is received during a conversation (p. 44).

Please lift up
and try again

SEARCH or was pressed while the handset was on the base unit. Lift the handset and press **SEARCH** or again.



Connecting the AC Adaptor

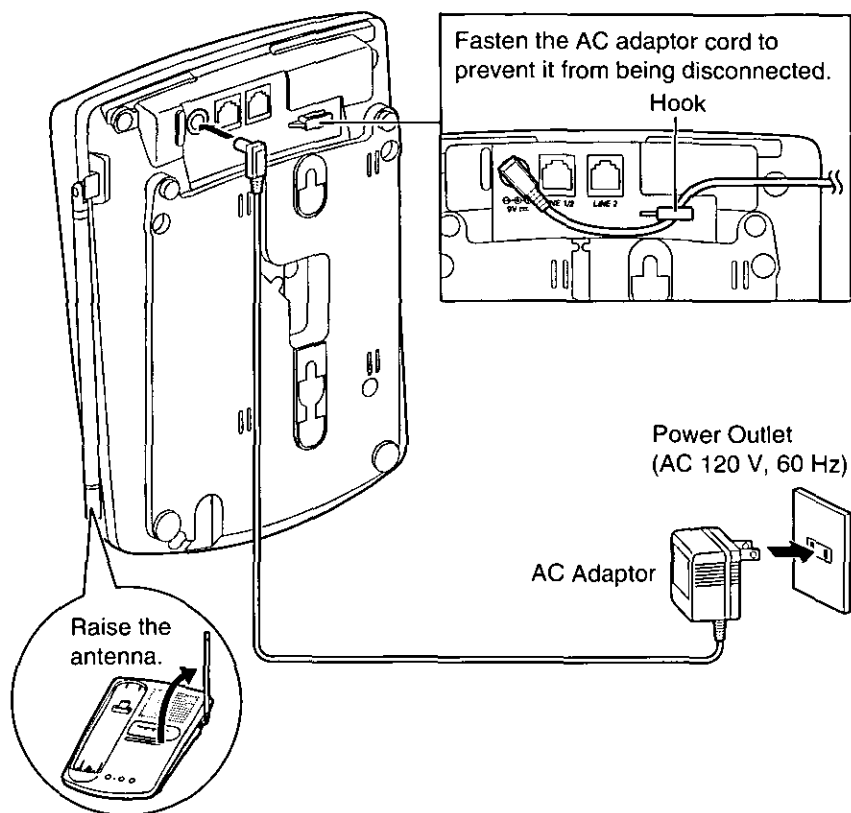

- USE ONLY WITH Panasonic AC ADAPTOR PQLV1 (Order No. PQLV1Z).
- The AC adaptor must remain connected at all times. (It is normal for the adaptor to feel warm during use.)
- To connect a standard telephone on the same line, see page 49.
- If your unit is connected to a PBX which does not support Caller ID and voice mail services, you cannot access those services.

Connecting the Telephone Line Cord

Connect the telephone line cord(s) to the unit as follows.

To connect a two-line telephone jack

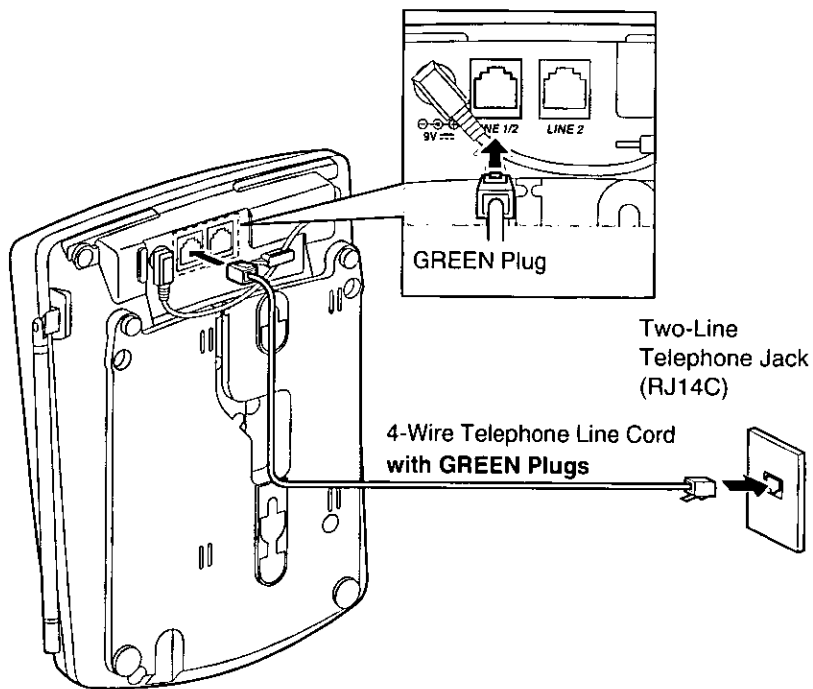



To connect two single-line telephone jacks

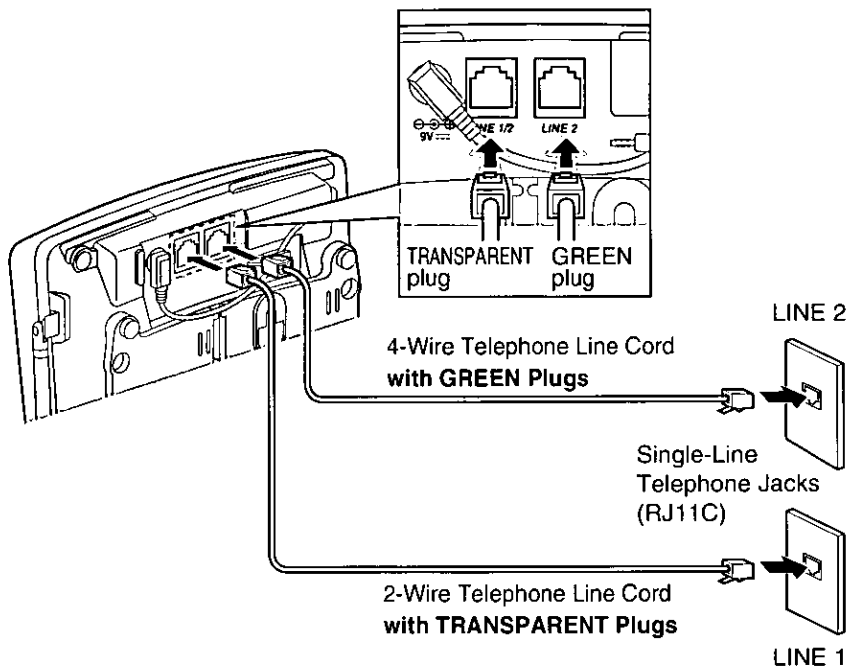

If you use the unit as a single-line telephone only

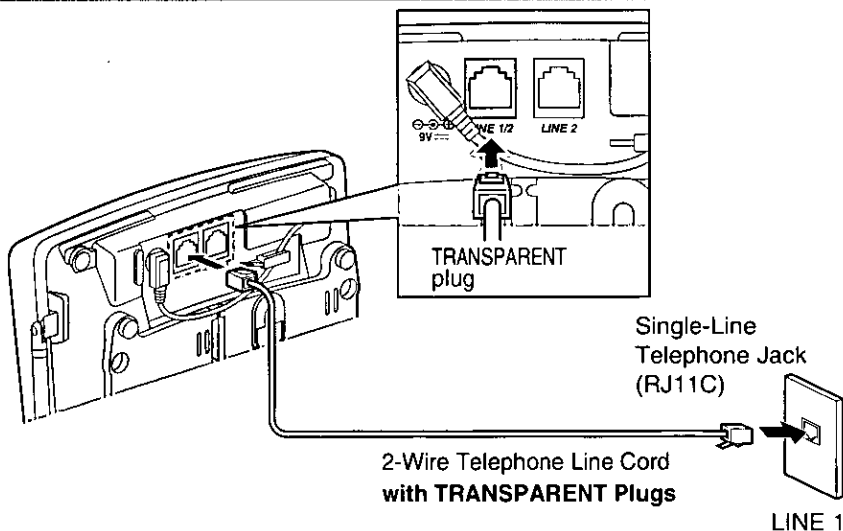

- You can only use LINE 1 with this connection.

Battery Charge

Place the handset on the base unit and charge for about **4 hours** before initial use.

- The IN USE/CHARGE indicator lights.

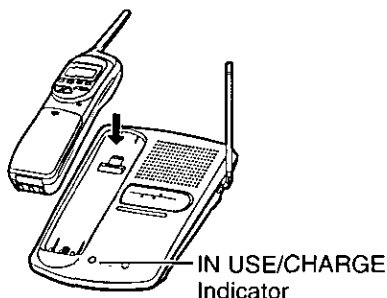

Battery strength

You can check the battery strength on the display while the handset is on the base unit, while it is in use (making/answering a call etc.), or after viewing the Caller List, programming, etc.

The battery strength will remain for 5 seconds after using the handset, then the display will return to the stand-by mode (see next page).

The battery strength is shown as in the chart below.

Display prompt	Battery strength
{ ■■■■ }	Fully charged
{ ■■■ }	Medium
{ ■■ }	Low
⚡{ ■■ }⚡ (flashing)	Needs to be recharged.

Recharge

Recharge the battery when:

- “Recharge” is displayed,
- “{ ■■ }” flashes on the display, or
- the handset beeps intermittently while it is in use.

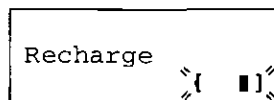

- If you DO NOT recharge the handset battery for more than 15 minutes, the display will keep indicating “Recharge” and/or “{ ■■ }” will continue to flash.



Battery information

After your Panasonic battery is fully charged (p. 14):

Operation	Approx. battery life
While in use (TALK)	Up to about 8 hours
While not in use (Stand-By)	Up to about 21 days

- Battery life may be shortened depending on usage conditions, such as viewing the Caller ID Caller List, and ambient temperature.
- **Clean the handset and the base unit charge contacts with a soft, dry cloth once a month. Clean more often if the unit is subject to grease, dust or high humidity.** Otherwise the battery may not charge properly.
- If the battery is fully charged, you do not have to place the handset on the base unit until "Recharge" is displayed and/or "[■]" flashes. This will maximize the battery life.
- The battery cannot be overcharged.

Stand-by mode (The handset is off the base unit.)

The handset goes into the stand-by mode after you finish using the handset (making/answering a call, viewing the Caller List, etc.).

The display is blank, but the handset can receive calls.

The battery life is conserved in this mode.

Selecting the Dialing Mode

You can program the dialing mode **using the handset near the base unit**. If you have touch tone service, set to "Tone". If rotary or pulse service is used, set to "Pulse". Your phone comes from the factory set to "Tone". **The TALK indicator light must be off before programming.**

1 Press **PROGRAM**.

- The TALK indicator flashes.

```
Save AUTO# ?
v=Next      ^=Yes
```

2 Press **SEARCH** (Next key) repeatedly until "Set dial mode ?" is displayed.

```
Set dial mode ?
v=Next      ^=Yes
```

3 Press **SEARCH** (Yes key).

```
Dial mode
v=Tone      ^=Pulse
```

4 To select "Pulse", press **SEARCH** .
OR

To select "Tone", press **SEARCH** .

- A beep sounds.
- The display will return to step 2.
To return to the stand-by mode, press **EXIT** or wait for 60 seconds.

```
Dial mode
Pulse
```

```
Dial mode
Tone
```

- To cancel during programming, press **EXIT** or **PROGRAM**. Start again from step 1.
- If 3 beeps sound and the display shows "Save error", move closer to the base unit and try again. If "Save error" is still displayed, place the handset on the base unit. Start again from step 1.
- If either line has rotary or pulse service, set to "Pulse". When making a call using a line which has touch tone service, press ***** first and then dial the number.

If a power failure occurs, the mode will return to the factory preset (Tone). Reprogram if necessary.



Selecting the Line Mode

If the line is connected to a low voltage system such as a PBX, set to "B". Otherwise, the line indicator may not operate properly, the Visual Call Waiting (Call Waiting ID) Service may not be accessible (p. 44) and you may not hear the incoming call tone (p. 46). Both lines are preset to "A". **The TALK indicator light must be off before programming.**

1 Press **PROGRAM**.

- The TALK indicator flashes.

```
Save AUTO# ?
v=Next      ^=Yes
```

2 Press **SEARCH** (Next key) repeatedly until "Set line mode ?" is displayed.

```
Set line mode ?
v=Next      ^=Yes
```

3 Press **SEARCH** (Yes key).

```
Set line mode
v=Line1    ^=Line2
```

4 Press **SEARCH** (Line1) or **SEARCH** (Line2) to select the desired line.

```
Line mode
v=A        ^=B
```

5 To select "B", press **SEARCH** .

OR

To select "A", press **SEARCH** .

```
Line mode
A
```

- A beep sounds.
- The display will return to step 2. To program the other line, start again from step 3.
- To return to the stand-by mode, press **EXIT** or wait for 60 seconds.

- To cancel during programming, press **EXIT** or **PROGRAM**. Start again from step 1.
- If 3 beeps sound and the display shows "Save error", move closer to the base unit and try again. If "Save error" is still displayed, place the handset on the base unit. Start again from step 1.

If a power failure occurs, the mode will return to the factory preset (A). Reprogram if necessary.

Storing Your Area Code

We recommend that you first program your area code before using the Caller ID feature (p. 28). Incoming calls from the same area code will then be recorded in the Caller List without the area code. You do not have to remove the area code before calling back or storing. When incoming calls from a different area code are received, "1" will automatically be added before the area code.

The TALK indicator light must be off before programming.

1 Press **PROGRAM**.

- The TALK indicator flashes.

```
Save AUTO# ?
v=Next      ^=Yes
```

2 Press **SEARCH** (Next key) repeatedly until "Area code ?" is displayed.

```
Area code ?
v=Next      ^=Yes
```

3 Press **SEARCH** (Yes key).

- The current setting is displayed.
If no area code has been programmed, "----" will be displayed.

```
Area code
: ---
Enter area code
```

4 Enter your area code.

- If you enter a wrong number, press **CLEAR**, and enter the correct number.

```
Area code
: 123
PROGRAM=Save
```

5 Press **PROGRAM** (Save key).

- A beep sounds.
- The display will return to step 2.
To return to the stand-by mode, press **EXIT** or wait for 60 seconds.

```
Area code
: 123
```

- To cancel during programming, press **EXIT**. Start again from step 1.

To erase the area code

Press **PROGRAM** ➡ **SEARCH** (Next key) twice ➡

➡ **SEARCH** (Yes key) ➡ **CLEAR** ➡ **PROGRAM** (Save key).

- If a "2nd area code" has been stored (p. 19), it will also be erased automatically.



Storing a Second Area Code

You can program a second local area code. This area code does not require a "1" before it when dialing. After storing this area code, the display will show the 10 digits (3-digit area code plus 7-digit phone number) after a call is received from that area code. Calls will be recorded in the Caller List without "1". You cannot store a second area code unless your area code is stored first (p. 18).

The TALK indicator light must be off before programming.

1 Press **PROGRAM**.

- The TALK indicator flashes.

Save AUTO# ?

∨=Next ∧=Yes

2 Press **SEARCH** (Next key) repeatedly until "2nd area code ?" is displayed.

2nd area code ?

∨=Next ∧=Yes

3 Press **SEARCH** (Yes key).

- The current setting is displayed. If no second area code has been programmed, "---" will be displayed.
- If 3 beeps sound, your area code has not been stored. Store the code first (p. 18), and start again from step 1.

2nd area code

:---

Enter area code

4 Enter a second area code.

- If you enter a wrong number, press **CLEAR** and enter the correct number.

2nd area code

:124

PROGRAM=Save

5 Press **PROGRAM** (Save key).

- A beep sounds.
- The display will return to step 2. To return to the stand-by mode, press **EXIT** or wait for 60 seconds.

2nd area code

:124

- To cancel during programming, press **EXIT**. Start again from step 1.

To erase the second area code

Press **PROGRAM** \Rightarrow **SEARCH** (Next key) 3 times \Rightarrow

\Rightarrow **SEARCH** (Yes key) \Rightarrow **CLEAR** \Rightarrow **PROGRAM** (Save key).

Setting the Auto Talk Feature

The Auto Talk feature allows you to answer a call by lifting the handset off the base unit without pressing **TALK**. If you want to view caller's information on the display after lifting the handset, turn this feature OFF by programming. Your phone comes from the factory set to ON.

The TALK indicator light must be off before programming.

1 Press **PROGRAM**.

- The TALK indicator flashes.

Save AUTO# ?
v=Next ^=Yes

2 Press **SEARCH** (Next key) repeatedly until "Talk switching?" is displayed.

Talk switching?
v=Next ^=Yes

3 Press **SEARCH** (Yes key).

Auto talk
v=On ^=Off

4 To select OFF, press **SEARCH** .

OR
To select ON, press **SEARCH** .

- A beep sounds.
- The display will return to step 2.
To return to the stand-by mode, press **EXIT** or wait for 60 seconds.

Auto talk
Off

Auto talk
On

- To cancel during programming, press **EXIT** or **PROGRAM**. Start again from step 1.
- To answer a call when the Auto Talk feature is OFF, lift the handset off the base unit and press **TALK**.

Selecting the Ringer Volume

With the handset

The TALK indicator light must be off.

- To select **HIGH** (preset) or **LOW**,

1 Press **RINGER**.

- Line 1 and Line 2 indicator lights will flash.

2 Press **LINE1** or **LINE2** to select the desired line.

- Each time you press the line button, the ringer volume for the selected line will change and the selected volume will ring.

- To turn the ringer **OFF**,

Press **RINGER**. Press and hold **LINE1** or **LINE2** until 2 beeps sound. "Ringer off" will be displayed for about 5 seconds.

When the ringer volume is set to OFF for both lines, "Ringer off" will flash for about 45 seconds before the handset returns to the stand-by mode.

- To turn the ringer **ON**,

Press **RINGER** and then **LINE1** or **LINE2**. The ringer for the selected line will sound at the HIGH level.

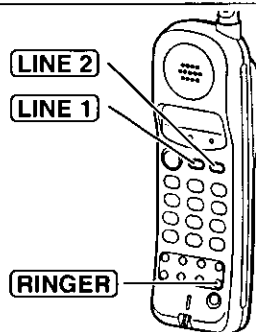
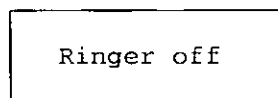
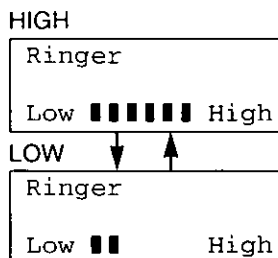

With the base unit

- To select **HIGH** (preset) or **LOW**,

Press **RINGER** **LINE1** or **LINE2** to select the desired line.

- Each time you press the button, the ringer volume for the selected line will change and the selected volume will ring.

- To turn the ringer **OFF**,

Press and hold **RINGER** **LINE1** or **LINE2** until 2 beeps sound.

- To turn the ringer **ON**,

Press **RINGER** **LINE1** or **LINE2**.

The ringer for the selected line will sound at the HIGH level.

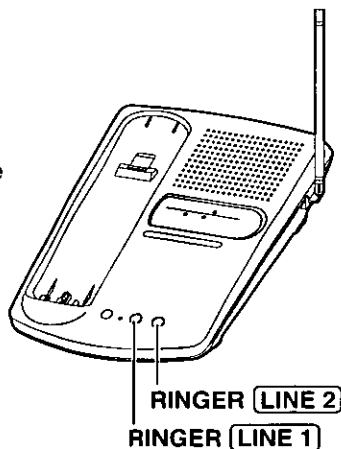

Making Calls

The unit will automatically select a free line, which is not being used by a parallel connected telephone, when you lift the handset to make a call. (To change the line selection, see page 45.)

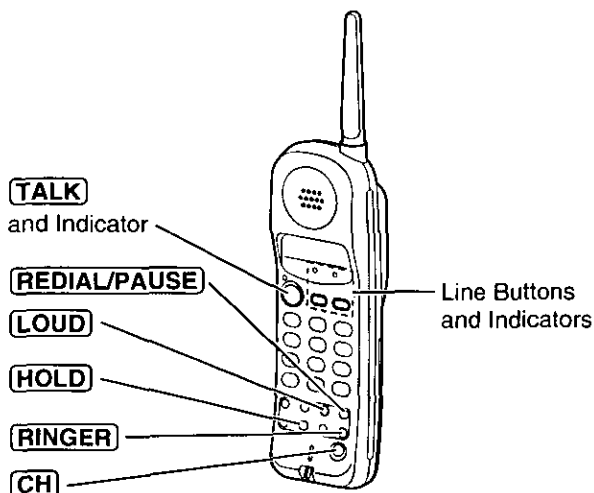

1 Press **TALK**.

- The TALK indicator lights.
- A free line is automatically selected and the line indicator lights.
- The selected channel number is displayed.

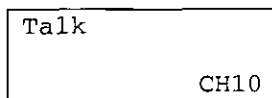

2 Dial a phone number.

- The dialed number is displayed.
- After a few seconds, the display will show the length of the call and the battery strength.

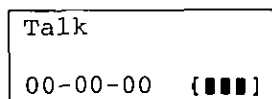
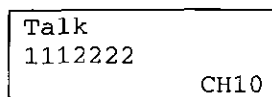

3 To hang up, press **TALK** or place the handset on the base unit.

- The indicator lights go out.
- The display will return to the stand-by mode.

- If "Out of range" is displayed and an alarm tone sounds in step 1, move closer to the base unit or place the handset on the base unit and try again.
- In step 1, you may select a line manually by pressing the line button instead of **TALK**.



To redial the last number dialed on the handset

Press **TALK** → **REDIAL/PAUSE**.

To select the receiver volume

Press **LOUD** while talking.

- Each time you press the button, the volume level will change from MEDIUM (preset) to HIGH to LOW.
- The display will return to the length of the call.

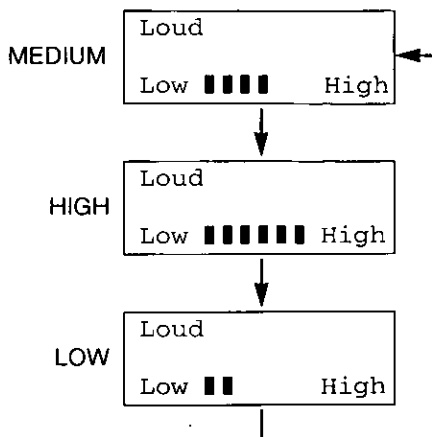

If noise interferes with the conversation

Press **CH** to select a clearer channel or move closer to the base unit.

- The selected channel number is displayed.

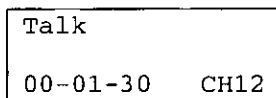

To put a call on hold

Press **HOLD**.

- The TALK indicator light goes out and the line indicator flashes.

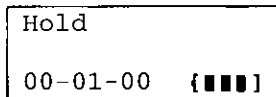

To release the hold

Press the line button on the handset or base unit whose indicator is flashing.

- If another phone is connected on the same line (p. 49), you can also release the hold by lifting its handset.

➔ Making Calls

What the line indicator means

Off	The line is free.
On	You are using the line on the handset.
Flashing twice every 2 seconds	Someone else is using the line on the handset or parallel connected telephone.
Flashing	A call is on hold.
Flashing quickly	A call is being received.

Lighted handset keypad

The handset dialing buttons will light when you press a button or lift the handset off the base unit, and flash when a call is received. The lights will go out about 10 seconds after pressing a button, lifting the handset or answering a call.

Backlit LCD display

The lighted display will stay on for about 10 seconds after pressing a handset button or lifting the handset off the base unit.

Answering Calls

When a call is being received, the unit rings and the called line indicator flashes quickly. The line is automatically selected when you answer the call. (To change the line selection, see page 45.)

If you subscribe to a Caller ID service, the calling party information will be displayed after the first ring (p. 28). In order to view the CALLER ID information, please wait until the second ring to answer a call.

If the handset is off the base unit, press

TALK.

- The TALK and the called line indicators light.
- You can also answer a call by pressing any dialing button **0** to **9**, ***** or **#** (— **Any Key Talk**).

OR

If on the base unit, just lift up.

(This is not possible when the Auto Talk feature is set to OFF. See page 20.)

Line Buttons and Indicators



- You may answer a call by pressing the line button instead of **TALK**.
- When the ringer volume is set to "Off", the selected line(s) will not ring (p. 21).

Speed Dialer

Storing Phone Numbers in Memory

You can store up to 10 phone numbers in the handset. The dialing buttons (0 to 9) function as memory stations.

The **TALK** indicator light must be off before programming.

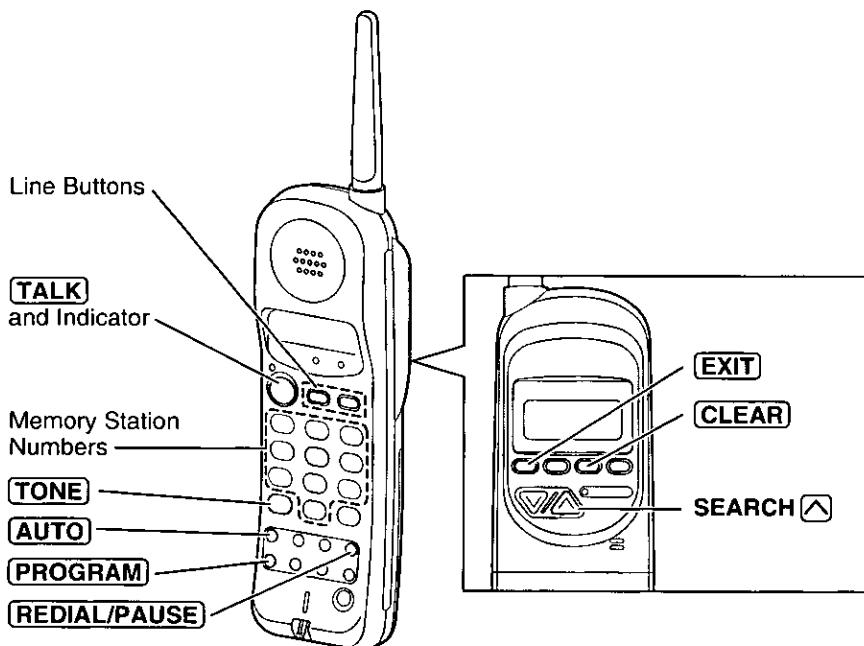

- 1 Press **PROGRAM**.
 - The TALK indicator flashes.
- 2 Press **SEARCH**  (Yes key).
- 3 Enter a phone number up to 22 digits.
 - If you misdial, press **CLEAR**. Digits are erased from the right.
- 4 Press **AUTO**.

Save AUTO# ?
v=Next ^=Yes

Enter phone no.

3334444

AUTO=Save

Select 0-9
to save in AUTO

5 Press a memory station number (**0** to **9**).

3334444

- A beep sounds.
- The display will return to step 1.
To store other numbers, repeat steps 2 through 5.
- To return to the stand-by mode, press **EXIT** or wait for 60 seconds.

Save in AUTO 1

- To cancel during programming, press **EXIT** or **PROGRAM**. Start again from step 1.
- If a pause is required for dialing, press **REDIAL/PAUSE** where needed. Pressing **REDIAL/PAUSE** counts as one digit (p. 44).

To erase a stored number

1 Press **PROGRAM**.

- The TALK indicator flashes.

Save AUTO# ?

v=Next ^=Yes

2 Press **SEARCH** Δ (Yes key).

Enter phone no.

3 Press **CLEAR**.

AUTO=Clear

4 Press **AUTO**.

Select 0-9 to
clear in AUTO

5 Press the memory station number (**0** to **9**) for the phone number to be erased.

Clear in AUTO 1

Dialing a Stored Number

1 Press **TALK**.

2 Press **AUTO**.

3 Press the memory station number (**0** to **9**).

- The stored number is dialed.

- In step 1, you may select a line manually by pressing the line button instead of **TALK**.
- If your line has rotary or pulse service, any access numbers stored after pressing **TONE** will not be dialed.

Caller ID Service

This unit is compatible with a Caller ID service offered by your telephone company. After subscribing to a Caller ID service, the calling party's information will be displayed after the first ring.

The unit can record information of up to 50 different callers for both lines combined, including the time and date the call was received, the number of times called and the called line, in the Caller List. The Caller List information is sorted from the most recent to the oldest call. When the 51st call is received, the oldest call is deleted.

Using the list, you can automatically call back a caller. You can store the callers' numbers from the Caller List in the Speed Dialer memory.

If you subscribe to a Visual Call Waiting (Call Waiting ID) service, when a second call is received while talking on the same line, the new caller's name and phone number will be displayed (p. 44).

How caller information is displayed when a call is received

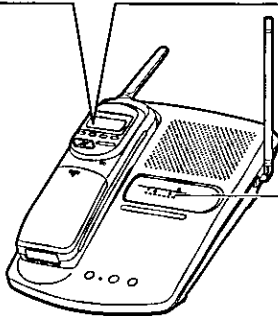
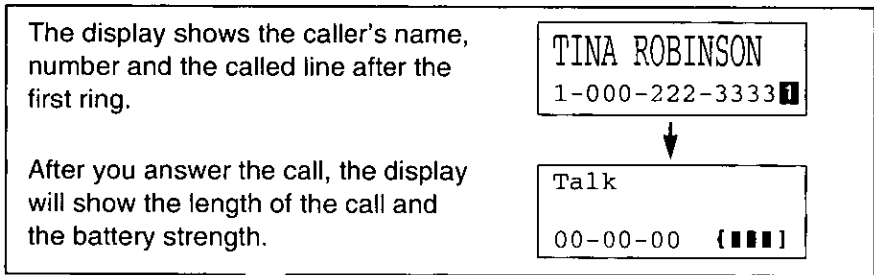

A line indicator will flash quickly when a call is being received.

- When both lines are receiving calls, each caller's information will be displayed alternately.
- Caller information cannot be displayed in the following cases:
 - If the caller dialed from an area which does not provide a Caller ID service, the display will show "Out of area".
 - If the caller has requested not to display his/her information, the display will show "Private caller".

- If your unit is connected to a PBX which does not support Caller ID services, you cannot access those services.
- The name display service may not be available in some calling areas. For further information, please contact your telephone company.

To check the number of new calls

When new calls have been received, the CALLER ID indicator flashes on the base unit.

While the handset is on the base unit:

If you have received 10 new calls, the display will show the following:

```

10 new calls
  [■■■■]
  
```

When you lift the handset, the display changes to the following:

```

10 new calls
v=New      ^=Old
  
```

- After 10 seconds, the display changes to the stand-by mode (p. 15).

CALLER ID Indicator

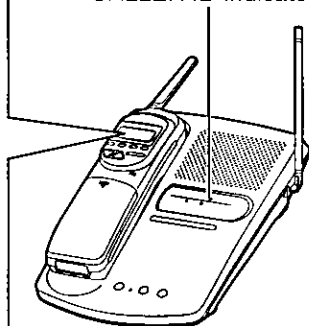

While the handset is off the base unit:

Press **SEARCH** or to turn the display on. If you have received 10 new calls, the display will show the following:

```

10 new calls
v=New      ^=Old
  
```

SEARCH

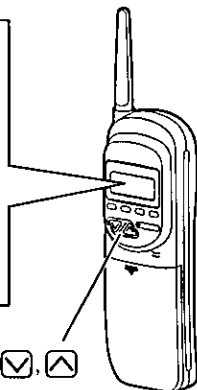

Using the Caller List

Viewing the Caller List

To check who has called, follow the steps below.

The **TALK** indicator light must be off.

- 1 Lift the handset off the base unit.
OR
If the handset is off the base unit,
press **SEARCH** or to enter the list.

- The display will show, for example, the following:

2 new calls	
v=New	^=Old

- 2 To search from the most recent call on both lines, press **SEARCH** (New key).
To search from the oldest call on both lines, press **SEARCH** (Old key).

- To scroll between callers, press **SEARCH** or .

- 3 To exit the list, press **EXIT**.

- The handset will return to the stand-by mode.

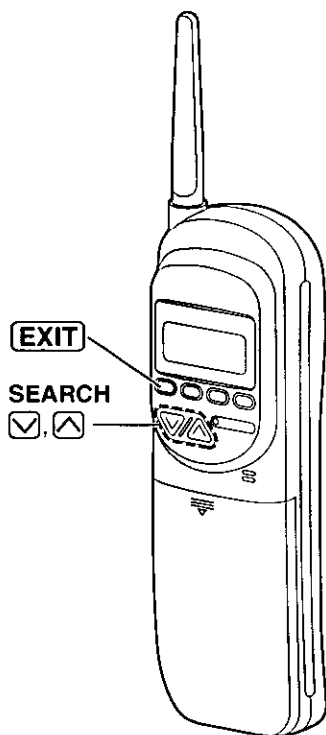

- Once new calls have been checked, "√" will be added.
- If "No items stored" is displayed in step 1, the Caller List is empty. Press **EXIT** to exit the list.
- If more than one call is received from the same caller, the date and time of the most recent call will be recorded. If the same caller calls again, the call entry with "√" will be deleted.



Ex. When you search from the most recent call on both lines:

Lift the handset off the base unit.

OR

If the handset is off the base unit, press **SEARCH** or .

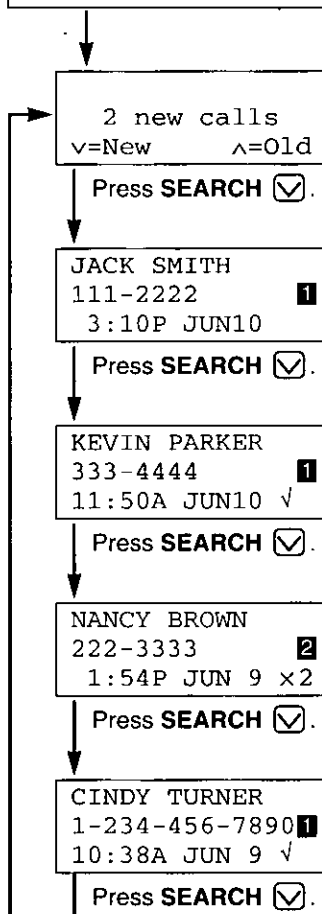

- If there is no name information for a caller, the display will only show the phone number.

To return to the previous caller, press **SEARCH** .

To exit the Caller List, press **EXIT**.

- The handset will return to the stand-by mode.

Display meaning:

✓ : You have checked this caller information, answered the call or called back the caller.

×2-×9 : The number of times the same caller called (up to 9).
After checking, "×2" - "×9" will be replaced with "✓".

1, 2 : Indication of the called line.

Calling Back from the Caller List

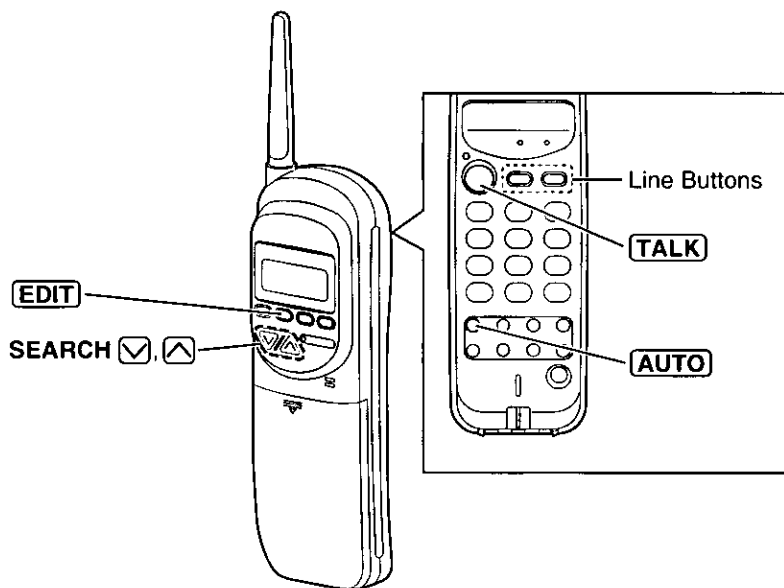

- 1** Lift the handset off the base unit.
OR
If the handset is off the base unit, press **SEARCH** or to enter the list.

3 new calls
v=New ^=Old

- 2** Press **SEARCH** or repeatedly to find the desired caller.

CINDY TURNER
1-234-456-7890 **1**
11:20A JAN12 x3

- 3** Press **TALK**.
- The displayed phone number is dialed automatically.
 - You can also press a line button instead of **TALK**.

Talk
12344567890
CH11

Talk
00-00-00 (■■■■)

- In some cases, you may have to edit the number before dialing (p. 33).
(Ex. You may have to add "1" for long distance calls.)
If you have not stored your area code (p. 18), the edited number will not be saved in the Caller List.
- If a phone number is not displayed in the caller information, you cannot call back that caller.



Editing the Caller's Phone Number

The unit can edit a phone number into one of 4 patterns.

The **TALK** indicator light must be off.

- 1 Lift the handset off the base unit.
OR
If the handset is off the base unit, press **SEARCH** or to enter the list.

5 new calls
v=New ^=Old

- 2 Press **SEARCH** or repeatedly to find the desired caller.

FRED PARKER
321-5555 1
11:20A JAN12 x3

- 3 Press **EDIT** to select a pattern.
Each time you press **EDIT**, the number is rearranged into one of 4 different patterns.

- Ⓐ 1 - Phone no.
- Ⓑ 1 - Area code - Phone no.
- Ⓒ Area code - Phone no.
- Ⓓ Phone no.

- The order in which patterns Ⓐ - Ⓓ are displayed depends on how the telephone number is displayed in step 2.

Ⓐ

FRED PARKER
1-321-5555 1
11:20A JAN12 x3

Ⓑ

FRED PARKER
1-234-321-5555 1
11:20A JAN12 x3

Ⓒ

FRED PARKER
234-321-5555 1
11:20A JAN12 x3

Ⓓ

FRED PARKER
321-5555 1
11:20A JAN12 x3

- 4 After editing the number, you can continue with calling back or storing procedures.
To call back, press **TALK** (p. 32).
To store the number in the Speed Dialer memory, press **AUTO**, then press a memory station number (0 to 9) (p. 34).

➔ Using the Caller List

Storing Caller List Information in the Speed Dialer Memory

You can store numbers that are in the Caller List into the Speed Dialer memory.

The TALK indicator light must be off.

- 1 Lift the handset off the base unit.
OR
If the handset is off the base unit, press **SEARCH** or to enter the list.

```
10 new calls
v=New      ^=Old
```

- 2 Press **SEARCH** or repeatedly to find the caller you want to store in memory.
- If the number requires editing, see page 33.

```
CINDY TURNER
1-234-456-7890 1
11:20A JAN12 x3
```

- 3 Press **AUTO**.

```
Save in AUTO
Select 0-9
```

- 4 Press a memory station number (**0** to **9**).
- A beep sounds.
 - The display will return to step 2. You can continue storing other items. To return to the stand-by mode, press **EXIT** or wait for 60 seconds.

```
12344567890
Save in AUTO 0
```

- To cancel during programming, press **EXIT**. Start again from step 1.
- You cannot store caller information in the Speed Dialer memory if a phone number is not displayed.

Erasing Caller List Information

After checking the Caller List, you can erase some or all of the entries. The **TALK** indicator light must be off.

To erase a specific caller from the Caller List

- 1 Lift the handset off the base unit.
OR
If the handset is off the base unit, press **SEARCH** or to enter the list.

10 new calls
v=New ^=Old

- 2 Press **SEARCH** or repeatedly to find the caller you want to erase from the Caller List.

TOM REAGAN
444-5555
12:20A JAN12 ✓ **1**

- 3 Press **CLEAR**.
 - A beep sounds and the information is erased.
 - After a few seconds, the display will show the previous caller information.
 - To return to the stand-by mode, press **EXIT** or wait for 60 seconds.

Clear

To erase all entries in the Caller List

- 1 Lift the handset off the base unit.
OR
If the handset is off the base unit, press **SEARCH** or to enter the list.

Make sure this display is shown.

0 new call
v=New ^=Old

- 2 Press **CLEAR**.

Press CLEAR for
all clear

- 3 Press **CLEAR** again.
 - A beep sounds and all entries are erased.
 - The handset will return to the stand-by mode.

All clear

Voice Mail Service

Voice mail service is an electronic on-line answering system offered by your telephone company. After subscribing, the voice mail system will answer calls automatically when your line is busy or if calls are not answered. Callers can leave messages by following the pre-recorded instructions. When voice mail messages are recorded, the VOICE MAIL indicator will flash. You can access the voice mail system quickly by pressing **CALL WAIT/VOICE MAIL**.

To use this feature, you must first store your access number for the line using the handset near the base unit.

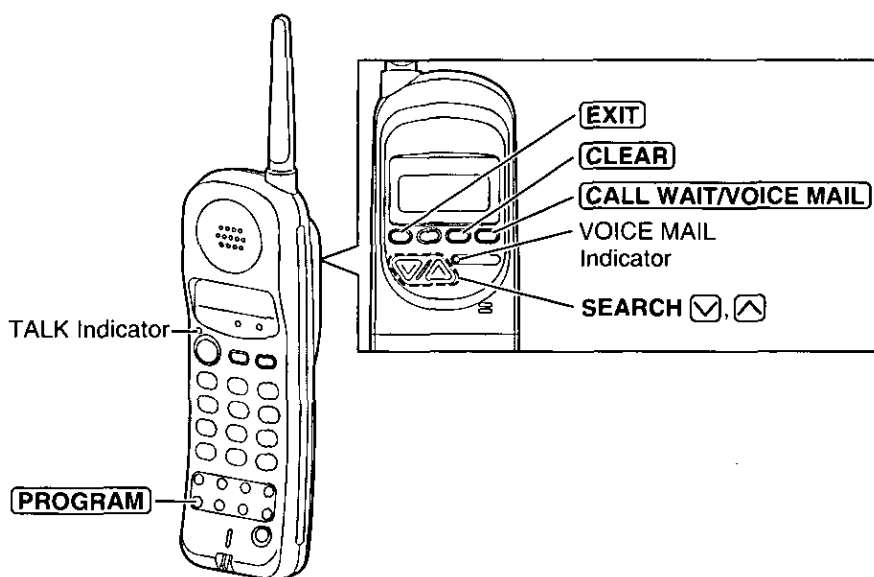



Storing a Voice Mail Access Number

The TALK indicator light must be off before programming.

- 1 Press **PROGRAM**.
 - The TALK indicator flashes.

Save AUTO# ?
v=Next ^=Yes

- 2 Press **SEARCH** (Next key) once. Make sure that "Save mailbox# ?" is displayed.

Save mailbox# ?
v=Next ^=Yes

- 3 Press **SEARCH** (Yes key).

Save mailbox#
v=Line1 ^=Line2

- 4 Press **SEARCH** (Line1) or **SEARCH** (Line2) to select the desired line.

Enter mailbox#

- 5 Enter your access number up to 32 digits.
 - If you enter a wrong number, press **CLEAR**. Digits are erased from the right.

1234567890
VOICEMAIL=Save

- 6 Press **CALL WAIT/VOICE MAIL** (Save key).
 - A beep sounds.
 - The display will return to step 2. To program the other line, start again from step 3.
 - To return to the stand-by mode, press **EXIT** or wait for 60 seconds.

1234567890
Save mailbox#

- To cancel during programming, press **EXIT** or **PROGRAM**. Start again from step 1.
- If 3 beeps sound and the display shows "Save error", move closer to the base unit and try again. If "Save error" is still displayed, place the handset on the base unit. Start again from step 1.

If a power failure occurs, the stored number will be erased.
--

To erase a stored number

- Press **PROGRAM** ⇒ **SEARCH** (Next key) ⇒ **SEARCH** (Yes key) ⇒ **SEARCH** (Line1) or (Line2) ⇒ **CLEAR** ⇒ **CALL WAIT/VOICE MAIL** (Clear key).

Setting the Voice Mail Tone

If your voice mail service sends a voice mail tone after a new message has finished recording, set to "On". The VOICE MAIL indicator will flash when a message is recorded in your mailbox. You will hear a series of voice mail tones followed by the dial tone after pressing **TALK**.

(Contact your service provider for more information.)

Set to "Off" if:

- you do not subscribe to a voice mail service,
- your voice mail service does not send a voice mail tone, or
- the unit is connected to a PBX.

Your phone comes from the factory set to "On".

The TALK indicator light must be off before programming.

1 Press **PROGRAM**.

- The TALK indicator flashes.

Save AUTO# ?

v=Next ^=Yes

2 Press **SEARCH** (Next key) repeatedly until "Voicemail tone?" is displayed.

Voicemail tone?

v=Next ^=Yes

3 Press **SEARCH** (Yes key).

Voicemail tone

v=Line1 ^=Line2

4 Press **SEARCH** (Line1) or **SEARCH** (Line2) to select the desired line.

Voicemail tone

v=On ^=Off

5 To select "Off", press **SEARCH** .
OR

Voicemail tone

Off

To select "On", press **SEARCH** .

- A beep sounds.
- The display will return to step 2. To program the other line, start again from step 3.
- To return to the stand-by mode, press **EXIT** or wait for 60 seconds.

Voicemail tone

On

- To cancel during programming, press **EXIT** or **PROGRAM**. Start again from step 1.
- If 3 beeps sound and the display shows "Save error", move closer to the base unit and try again. If "Save error" is still displayed, place the handset on the base unit. Start again from step 1.

If a power failure occurs, the setting will return to the factory preset (On). Reprogram if necessary.

Listening to Voice Mail Messages

After receiving a voice mail message, the VOICE MAIL indicator will flash. To listen to your voice mail, follow the steps below.

- 1 Press **CALL WAIT/VOICE MAIL**.
- The display shows whether there are voice mail messages recorded for LINE 1, and LINE 1's access number.

Ex. LINE 1 has voice mail message(s).

Voicemail:Yes 123456789 Line1

- 2 a) To listen to voice mail messages for LINE 1, go to step 3.

- b) To check voice mail messages for LINE 2, press

CALL WAIT/VOICE MAIL again.

Ex. LINE 2 has no voice mail messages.

Voicemail:None 112223333 Line2

- The display shows whether there are voice mail messages recorded for LINE 2, and LINE 2's access number.

- Each time you press **CALL WAIT/VOICE MAIL**, the line will change.

- To return to the stand-by mode, press **EXIT**.

- 3 Press **TALK**.

- The unit is connected to the telephone line and automatically dials the access number.
- You can also press a line button instead of **TALK**.

Talk 1234567890 CH10

- 4 Follow the pre-recorded instructions.

- 5 When finished, press **TALK**.

- The line which calls your voice mail service depends on the "Line Selection" (p. 45).
- If the VOICE MAIL indicator still flashes even after you have listened to your voice mail messages, press and release **PROGRAM**, then press and hold **CALL WAIT/VOICE MAIL** until the unit beeps. The indicator will turn off.
- If your voice mail service uses a voice mail tone and the recorded message is over 3 minutes long, the VOICE MAIL indicator may not flash.
- If your voice mail service uses a voice mail tone, the tone will be heard from any parallel connected phone on the same line. If you use another phone to retrieve messages, you have to dial your access number manually.

Using the Other Line During a Conversation

During a conversation, if **two tones** sound and the other line indicator flashes quickly, an incoming call is being received on that line. You can answer the second call while holding the first call. You can also make a call without terminating the first call. If you subscribe to a Caller ID service, the second caller's information will be displayed when a call is being received on the other line (p. 28).

You may delete the **two tones** (incoming call tone) by programming. See page 46.

Ex: If you are using LINE 1

- 1 Press **HOLD** to put the first call (LINE 1) on hold.
 - The LINE 1 indicator flashes.
- 2 Press the other line button (LINE 2) to make or answer a second call.
 - The LINE 2 indicator lights.
- 3 To return to the first call (LINE 1), press the line button for the first call (LINE 1).
 - The second call is terminated.

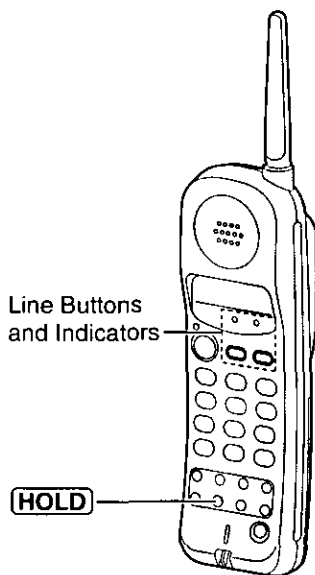

- To hold the second call in step 3, press **HOLD** before pressing the line button for the first call.

Conference Call

While having a conversation on one line, you can make or answer a second call on the other line and then combine the calls to make a conference call.

Ex: If you are using LINE 1

- 1 Press **HOLD** to put the first call (LINE 1) on hold.
 - The LINE 1 indicator flashes.
- 2 Press the other line button (LINE 2) to make or answer a second call.
 - The LINE 2 indicator lights.
- 3 When the second call is connected, press **CONF** to make a conference call.
 - Both line indicators light.



During a conference call:

- To hang up both lines, press **TALK**.
- To hang up only one line, press the line button for the party with which you want to continue talking.
- To put both lines on hold, press **HOLD**.
To talk with only one caller, press the corresponding line button.
To resume both lines, press **CONF**.

Special Features

Handset Locator

From the base unit, you can locate the handset or page the handset user with beep tones.

1. Press **LOCATOR**.

- The IN USE/CHARGE indicator flashes. The handset beeps for 1 minute and "Paging" is displayed.

2. To stop paging, press **LOCATOR** again or press a line button on the handset and **TALK**.

FLASH Button

Pressing **FLASH** allows you to use special features of your host PBX such as transferring an extension call or accessing special telephone services (optional) such as call waiting.

- You can press **CALL WAIT/VOICE MAIL** instead of **FLASH**.

Selecting the flash time (call waiting time)

The flash time (call waiting time) depends on your telephone exchange or host PBX. You can select the following flash times (call waiting times): "700, 600, 400, 300, 250, 110, 100 or 90 ms (milliseconds)", **using the handset near the base unit**. Your phone comes from the factory set to "700 ms".

The TALK indicator light must be off before programming.

1 Press **PROGRAM**.

- The TALK indicator flashes.

Save AUTO# ?

v=Next ^=Yes

2 Press **SEARCH** (Next key) repeatedly until "Set flash time?" is displayed.

Set flash time?

v=Next ^=Yes

3 Press **SEARCH** (Yes key).

Set flash time

v=Line1 ^=Line2

4 Press **SEARCH** (Line1) or **SEARCH** (Line2) to select the desired line.

Flash time

:700ms

v=Next ^=Save



5 Press **SEARCH**  (Next key) repeatedly until the desired time is displayed.

6 Press **SEARCH**  (Save key).

- A beep sounds.
 - The display will return to step 2. To program the other line, start again from step 3.
 - To return to the stand-by mode, press **EXIT** or wait for 60 seconds.
-
- To cancel during programming, press **EXIT** or **PROGRAM**. Start again from step 1.
 - If 3 beeps sound and the display shows "Save error", move closer to the base unit and try again. If "Save error" is still displayed, place the handset on the base unit. Start again from step 1.
 - If you are connected via a PBX, a longer flash time may be necessary to use PBX functions (transferring a call, etc.). Consult your PBX installer for the correct setting.

If a power failure occurs, the setting will return to the factory preset (700 ms). Reprogram if necessary.

Automatic Security Code Setting

Each time you place the handset on the base unit, the unit automatically selects one of a million security codes. These codes help prevent the unauthorized use of your telephone line by another cordless telephone user.

Temporary Tone Dialing (For Rotary or Pulse Service Users)

Press **TONE** before entering access numbers which require tone dialing.

- The dialing mode changes to tone. You can enter numbers to access an answering service, electronic banking service, etc. When you hang up, the mode will return to pulse.
- Access numbers entered after pressing **TONE** will not be included when redialing.

For Call Waiting Service Users

Press **CALL WAIT/VOICE MAIL** if you hear a call-waiting tone while talking.

- The first call is put on hold and you can answer the second call.
- To return to the first caller, press **CALL WAIT/VOICE MAIL** again.
- You can press **FLASH** instead of **CALL WAIT/VOICE MAIL**.
- The call waiting service is not available when:
 - you are having a conference call (p. 41), or
 - a parallel connected telephone on the same line is in use.
- If this function does not operate properly, the flash time (call waiting time) may not be set correctly. Consult your telephone company for details. See pages 42 and 43 for how to adjust the time.

Visual Call Waiting (Call Waiting ID) Service

Visual Call Waiting (Call Waiting ID) Service allows your handset to display a second caller's information. After you hear a call-waiting tone while talking, the handset will display the caller's name with the phone number and "----Waiting----".

NANCY BROWN 1-000-222-3333 1 ----Waiting----

- Please contact your telephone company for details and availability in your area.

How to Use the PAUSE Button

(For Analog PBX Line/Long Distance Service Users)

We recommend you press **REDIAL/PAUSE** if a pause is required for dialing with a PBX or to access a long distance service.

Ex. Line access number **9** (PBX)

9 ➔ **REDIAL/PAUSE** ➔ Phone number

- Pressing **REDIAL/PAUSE** once creates a 3.5 second pause. This prevents misdialing when you redial or dial a stored number.
- Pressing **REDIAL/PAUSE** more than once increases the length of the pause between numbers.



Line Selection

The unit will automatically select a free line which is not being used by a parallel connected telephone when you make a call. The unit will select the called line when you answer a call. To change the line selection, program as follows.

The Talk indicator light must be off before programming.

1 Press **PROGRAM**.

- The TALK indicator flashes.

Save AUTO# ?
v=Next ^=Yes

2 Press **SEARCH** (Next key) repeatedly until "Line selection?" is displayed.

Line selection?
v=Next ^=Yes

3 Press **SEARCH** (Yes key).

- The current selection is displayed.
Line 1: Line 1 will be selected.
Line 2: Line 2 will be selected.
Auto: A free line will be selected (LINE 1 has priority) when making a call. The called line is automatically selected when answering a call (factory preset).

Line selection
:Auto
v=Next ^=Save

4 Press **SEARCH** (Next key) repeatedly until the desired line selection is displayed.

Line selection
:Line2
v=Next ^=Save

5 Press **SEARCH** (Save key).

- A beep sounds.
- The display will return to step 2. To return to the stand-by mode, press **EXIT** or wait for 60 seconds.

Line selection?
:Line2

- To cancel during programming, press **EXIT** or **PROGRAM**. Start again from step 1.
- If 3 beeps sound and the display shows "Save error", move closer to the base unit and try again. If "Save error" is still displayed, place the handset on the base unit. Start again from step 1.
- Any line can be selected manually, regardless of the mode selected in step 4, by pressing the line button.

If a power failure occurs, the setting will return to the factory preset (Auto). Reprogram if necessary.
--

Incoming Call Tone

While one line is being used, you can be informed if another call has arrived on the other line by two tones. This incoming call tone can be set/deleted by programming. Your phone comes from the factory set to "2".

The Talk indicator light must be off before programming.

1 Press **PROGRAM**.

- The TALK indicator flashes.

```
Save AUTO# ?
v=Next    ^=Yes
```

2 Press **SEARCH** (Next key) repeatedly until "Incoming call.?" is displayed.

```
Incoming call.?
v=Next    ^=Yes
```

3 Press **SEARCH** (Yes key).

- The current setting is displayed.
On: The incoming call tone will be heard for as long as the other line rings.
2: The incoming call tone will only be heard 2 times (factory preset).
Off: The incoming call tone will not be heard, the line indicator on the handset will not flash and the caller ID information will not be displayed. The information will be recorded in the caller list (p. 30).

```
Incoming call
           tone:2
v=Next    ^=Save
```

4 Press **SEARCH** (Next key) repeatedly until the desired setting is displayed.

```
Incoming call
           tone:On
v=Next    ^=Save
```

5 Press **SEARCH** (Save key).

- A beep sounds.
- The display will return to step 2. To return to the stand-by mode, press **EXIT** or wait for 60 seconds.

```
Incoming call
           tone:On
```

- To cancel during programming, press **EXIT** or **PROGRAM**. Start again from step 1.
- If 3 beeps sound and the display shows "Save error", move closer to the base unit and try again. If "Save error" is still displayed, place the handset on the base unit. Start again from step 1.
- When the incoming call tone stops, the line indicator on the handset will go out and the caller ID information will disappear. To check the caller information, press **SEARCH** or after hanging up.

If a power failure occurs, the setting will return to the factory preset (2). Reprogram if necessary.

Battery Replacement

If "Recharge" is displayed and/or "(■)" flashes after being fully charged, replace the battery with a new Panasonic P-P501 (KX-A36) battery. To order, call the accessories telephone number on page 2. To avoid loss of memory, replace within 3 minutes.

- 1 Remove the cover by sliding while pressing the arrow.

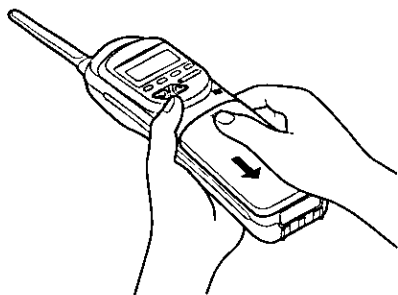

- 2 Replace the battery, and close the cover.



- 3 Be sure to charge the new battery for about 4 hours in order to display the battery strength prompt correctly (p. 14).

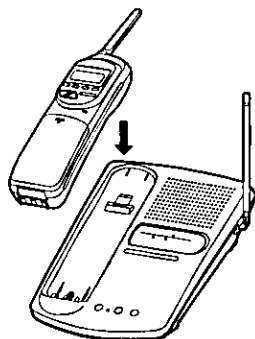

Attention:

The product you have purchased is powered by a nickel cadmium battery which is recyclable. At the end of its useful life, under various state and local laws, it is illegal to dispose of this battery into your municipal waste stream. Please call 1-800-8-BATTERY for information on how to recycle this battery.



Wall Mounting

This unit can be mounted on a wall phone plate.

- 1 Pull down the handset hook until it locks, so the tab holds the handset.

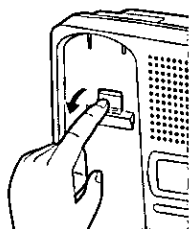

- 2 Connect the AC adaptor.

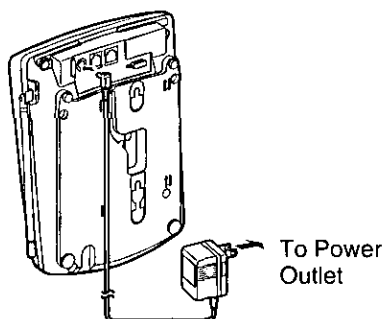

- 3 Connect the telephone line cord. Mount the unit, then slide down.

- Raise the antenna.

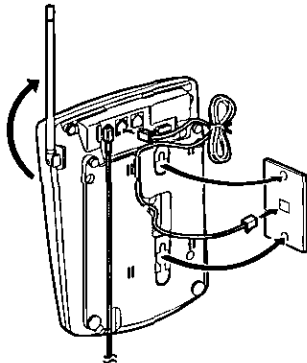

- 4 **To charge the battery:**
Place the handset on the handset hook as shown.

- The IN USE/CHARGE indicator lights.

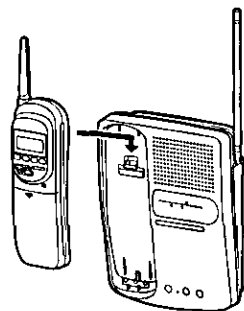

Adding Another Phone

This unit will not function during a power failure. To connect a standard telephone on the same line, use the Panasonic T-adaptor KX-J66. To order, call the accessories telephone number on page 2.

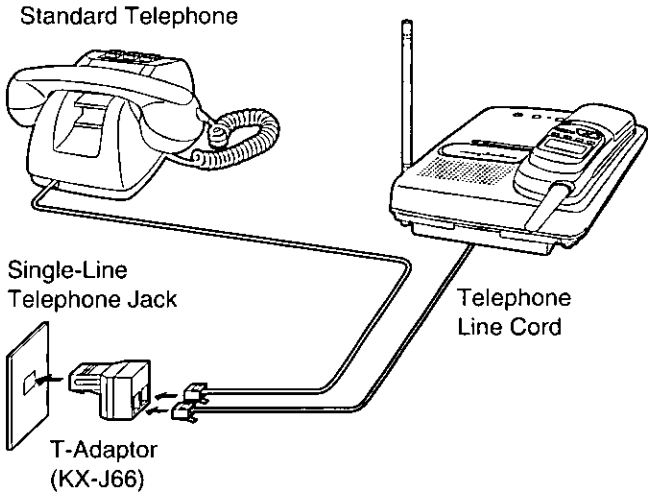

Before Requesting Help

Problem	Remedy
"Out of range" is displayed and an alarm tone sounds when you press TALK .	<ul style="list-style-type: none">• You are too far from the base unit. Move closer and try again.• Place the handset on the base unit and try again.• Plug in the AC adaptor.• Raise the base unit antenna.
The unit does not work.	<ul style="list-style-type: none">• Check the settings (p. 11–21).• Charge the battery fully (p. 14).• Clean the charge contacts and charge again (p. 15).• Install the battery properly (p. 47).• Place the handset on the base unit and unplug the AC adaptor to reset. Plug in and try again.• Re-install the handset battery within 3 minutes to avoid loss of memory and place the handset on the base unit. Try again.
Static, sound cuts in/out, fades. Interference from other electrical units.	<ul style="list-style-type: none">• Locate the handset and the base unit away from other electrical appliances (p. 3).• Move closer to the base unit.• Raise the base unit antenna.• Press CH to select a clearer channel.
The handset does not ring.	<ul style="list-style-type: none">• The ringer volume is set to OFF. Press RINGER then the line button while the TALK indicator light is off (p. 21).
The base unit does not ring.	<ul style="list-style-type: none">• The ringer volume is set to OFF. Press RINGER LINE 1 or LINE 2.



Problem	Remedy
The line indicators do not work properly.	<ul style="list-style-type: none">• Check the settings (p. 11–21).• The line mode selection is incorrect. See page 17.
The handset display is blank.	<ul style="list-style-type: none">• The handset is in the stand-by mode (p. 15). Press SEARCH <input checked="" type="checkbox"/> or <input checked="" type="checkbox"/> to turn the display on.
The handset display is still blank after pressing SEARCH <input checked="" type="checkbox"/> or <input checked="" type="checkbox"/> .	<ul style="list-style-type: none">• Charge the battery fully (p. 14).
You cannot program items, such as the dialing mode.	<ul style="list-style-type: none">• Programming is not possible while the unit is in the talk mode, or when viewing caller information.• Do not pause for over 60 seconds while programming.• Move closer to the base unit.• SEARCH <input checked="" type="checkbox"/> or <input checked="" type="checkbox"/> may have been pressed when you picked up the handset. Press (EXIT), and try again.
You cannot store a phone number in memory.	<ul style="list-style-type: none">• You cannot store a number while the unit is in the talk mode.• Do not pause for over 60 seconds while storing.
While programming or searching, the unit starts to ring and stops the program/search.	<ul style="list-style-type: none">• To answer the call, press the line button whose indicator is flashing quickly. Start again from the beginning after hanging up.

Before Requesting Help

Problem	Remedy
Previously programmed information is erased.	<ul style="list-style-type: none">• If a power failure occurs, programmed information may be erased. Reprogram if necessary.
During a conversation, two tones sound, the other line indicator flashes quickly and the display shows another caller's information.	<ul style="list-style-type: none">• Someone is calling you on the other line. To answer, press (HOLD) to put the current call on hold. Press the line button whose indicator is flashing quickly (p. 40).
The unit does not display the caller's name and/or phone number.	<ul style="list-style-type: none">• Other telephone equipment may be interfering with your phone. Disconnect it and try again.• Other electrical appliances connected to the same outlet may be interfering with the Caller ID information.• Telephone line noise may be affecting the Caller ID information.
A call was received, but the caller's information was not recorded in the Caller List.	<ul style="list-style-type: none">• If you receive two calls at the same time, only one of the caller's information can be recorded.
The display goes to the stand-by mode while viewing the Caller List.	<ul style="list-style-type: none">• Do not pause for over 60 seconds while searching.
When a second call is received during a conversation, the unit does not display the new caller's name and/or phone number.	<ul style="list-style-type: none">• The line mode selection is incorrect. See page 17.
(LOCATOR) does not function.	<ul style="list-style-type: none">• The handset is too far from the base unit.• The handset is engaged in an outside call. Wait until the IN USE/CHARGE indicator light goes out.

Problem	Remedy
<p>REDIAL/PAUSE does not function properly.</p>	<ul style="list-style-type: none"> • The button has a double function as either redial or pause. It will redial the last number dialed if pressed at the outset of a call (p. 23). If another number has been dialed first, it will operate as a pause button (p. 44).
<p>You cannot redial by pressing REDIAL/PAUSE.</p>	<ul style="list-style-type: none"> • Access numbers entered after pressing TONE will not be included when redialing (p. 43). • If the last number dialed was more than 32 digits long, the number will not be redialed.
<p>“Recharge” is displayed, “[■]” flashes or the unit beeps intermittently.</p>	<ul style="list-style-type: none"> • Charge the battery fully (p. 14).
<p>You charged the battery fully, but “Recharge” is still displayed and/or “[■]” continues to flash.</p>	<ul style="list-style-type: none"> • Clean the charge contacts and charge again (p. 15). • Install a new battery (p. 47).
<p>The IN USE/CHARGE indicator light does not go out while charging.</p>	<ul style="list-style-type: none"> • This is normal.
<p>If you cannot solve your problem</p>	<ul style="list-style-type: none"> • Call our customer call center at 1-800-211-PANA(7262).

Important Safety Instructions

When using this unit, basic safety precautions should always be followed to reduce the risk of fire, electric shock, or personal injury.

1. Read and understand all instructions.
2. Follow all warnings and instructions marked on this unit.
3. Unplug this unit from AC outlets before cleaning. Do not use liquid or aerosol cleaners. Use a damp cloth for cleaning.
4. Do not use this unit near water, for example, near a bathtub, washbowl, kitchen sink, or the like.
5. Place this unit securely on a stable surface. Serious damage and/or injury may result if the unit falls.
6. Do not cover slots and openings on the unit. They are provided for ventilation and protection against overheating. Never place the unit near radiators, or in a place where proper ventilation is not provided.
7. Use only the power source marked on the unit. If you are not sure of the type of power supplied to your home, consult your dealer or local power company.
8. Do not place objects on the power cord. Install the unit where no one can step or trip on the cord.
9. Do not overload wall outlets and extension cords. This can result in the risk of fire or electric shock.
10. Never push any objects through slots in this unit. This may result in the risk of fire or electric shock. Never spill any liquid on the unit.
11. To reduce the risk of electric shock, do not disassemble this unit. Take the unit to an authorized servicenter when service is required. Opening or removing covers may expose you to dangerous voltages or other risks. Incorrect reassembly can cause electric shock when the unit is subsequently used.
12. Unplug this unit from the wall outlet and refer servicing to an authorized servicenter when the following conditions occur:
 - A. When the power supply cord or plug is damaged or frayed.
 - B. If liquid has been spilled into the unit.
 - C. If the unit has been exposed to rain or water.
 - D. If the unit does not work normally by following the operating instructions. Adjust only controls covered by the operating instructions. Improper adjustment may require extensive work by an authorized servicenter.
 - E. If the unit has been dropped or physically damaged.
 - F. If the unit exhibits a distinct change in performance.
13. During thunderstorms, avoid using telephones except cordless types. There may be a remote risk of an electric shock from lightning.
14. Do not use this unit to report a gas leak, when in the vicinity of the leak.

SAVE THESE INSTRUCTIONS

CAUTION:

To reduce the risk of fire or injury to persons, read and follow these instructions.

1. Use only the battery(ies) specified.
2. Do not dispose of the battery(ies) in a fire. They may explode. Check with local waste management codes for special disposal instructions.
3. Do not open or mutilate the battery(ies). Released electrolyte is corrosive and may cause burns or injury to the eyes or skin. The electrolyte may be toxic if swallowed.
4. Exercise care in handling batteries in order not to short the battery to conductive materials such as rings, bracelets, and keys. The battery and/or conductor may overheat and cause burns.
5. Charge the battery(ies) provided with or identified for use with this product only in accordance with the instructions and limitations specified in this manual.

WARNING:

TO PREVENT FIRE OR SHOCK HAZARD, DO NOT EXPOSE THIS PRODUCT TO RAIN OR ANY TYPE OF MOISTURE.

FCC and Other Information

If requested by the telephone company, inform them as follows:

FCC Registration No.(found on the bottom of the unit)

Ringer Equivalence0.3B

The particular telephone lines to which the equipment is connected.

This unit must not be connected to a coin operated line.

If you are on a party line, check with your local telephone company.

Ringer Equivalence No. (REN):

The REN is useful in determining the quantity of devices you may connect to your telephone line and still have all of those devices ring when your telephone number is called. In most, but not all areas, the sum of the REN's of all devices connected to one line should not exceed five (5.0). To be certain of the number of devices you may connect to your line, as determined by the REN, you should contact your local telephone company to determine the maximum REN for your calling area.

In the event terminal equipment causes harm to the telephone network, the telephone company should notify the customer, if possible, that service may be stopped.

However, where prior notice is impractical, the company may temporarily cease service providing that they:

- (a) Promptly notify the customer.
- (b) Give the customer an opportunity to correct the problem with their equipment.
- (c) Inform the customer of the right to bring a complaint to the Federal Communication Commission pursuant to procedures set out in FCC Rules and Regulations Subpart E of Part 68.

The Telephone Company may make changes in its communications facilities, equipment, operations or procedures, where such action is reasonably required in the operation of its business and is not inconsistent with the rules and regulations in FCC Part 68.

If such changes can be reasonably expected to render any customer terminal equipment incompatible with telephone company communications facilities, or require modification or alteration of such terminal equipment, or otherwise materially affect its use or performance, the customer shall be given adequate notice in writing, to allow the customer an opportunity to maintain uninterrupted service.

When programming emergency numbers and/or making test calls to emergency numbers:

1. Remain on the line and briefly explain to the dispatcher the reason for the call before hanging up.
2. Perform such activities in the off-peak hours, such as early morning hours or late evenings.

This device complies with Part 15 of the FCC Rules. Operation is subject to the following two conditions: (1) This device may not cause harmful interference, and (2) this device must accept any interference received, including interference that may cause undesired operation.

Privacy of communications may not be ensured when using this phone.

CAUTION:

Any changes or modifications not expressly approved by the party responsible for compliance could void the user's authority to operate this device.

Note:

This equipment has been tested and found to comply with the limits for a Class B digital device, pursuant to Part 15 of the FCC Rules. These limits are designed to provide reasonable protection against harmful interference in a residential installation. This equipment generates, uses, and can radiate radio frequency energy and, if not installed and used in accordance with the instructions, may cause harmful interference to radio communications. However, there is no guarantee that interference will not occur in a particular installation. If this equipment does cause harmful interference to radio or television reception, which can be determined by turning the equipment off and on, the user is encouraged to try to correct the interference by one or more of the following measures:

- Reorient or relocate the receiving antenna.
- Increase the separation between the equipment and receiver.
- Connect the equipment into an outlet on a circuit different from that to which the receiver is connected.
- Consult the dealer or an experienced radio/TV technician for help.

Some cordless telephones operate at frequencies that may cause interference to nearby TVs and VCRs. To minimize or prevent such interference, the base of the cordless telephone should not be placed near, or on top of, a TV or VCR. If interference is experienced, move the cordless telephone farther away from the TV or VCR. This will often reduce, or eliminate, interference.

- **Environment** — do not place the unit in a room where the temperature is less than 5°C (41°F) or greater than 40°C (104°F). Allow 10 cm (4") clearance around the unit for proper ventilation. Avoid excessive smoke, dust, mechanical vibration, shock, or direct sunlight.
- **Routine care** — wipe the unit with a soft cloth. Do not use benzine, thinner, or any abrasive powder. When you leave the unit unused for a long period of time, unplug the AC adaptor from the outlet.
- **If there is any trouble** — disconnect the unit from the telephone line and connect a known working phone. If the known working phone operates properly, have your unit repaired by one of the authorized Panasonic Factory Service Centers. If the known working phone does not operate properly, consult your telephone company.

For product service

- Panasonic Servicenters are listed in the servicenter directory.
- Call 1-800-211-PANA(7262) for the location of an authorized servicenter.

When you ship the product

- Carefully pack your unit, preferably in the original carton.
- Attach a letter, detailing the symptom, to the outside of the carton.

Symptom

- Send the unit to an authorized servicenter, prepaid and adequately insured.
- Do not send your unit to the Panasonic Consumer Electronics Company listed on the back cover or to executive or regional sales offices. These locations do not repair consumer products.

- This cordless telephone is designed for use in the United States of America. Sale or use of this product in other countries may violate local laws.
- Ce téléphone sans fil est conçu pour être utilisé aux États-Unis d'Amérique. La vente ou l'emploi de cet appareil dans certains autres pays peut constituer une infraction à la législation locale.
- Este teléfono sin cordón fue elaborado para uso en los Estados Unidos de América. La venta o el empleo de este producto en ciertos países puede constituir violación de la legislación local.
- このコードレス電話機は、日本国外での使用を目的として設計されており、日本国内での使用は法律違反となります。従って、当社では日本国内においては原則として修理などのサービスは致しかねます。

Panasonic Consumer Electronics Company,
Division of Matsushita Electric Corporation of America
One Panasonic Way, Secaucus, New Jersey 07094

Panasonic Sales Company,
Division of Matsushita Electric of Puerto Rico, Inc.
Ave. 65 de Infantería, Km. 9.5, San Gabriel Industrial Park
Carolina, Puerto Rico 00985