

Panasonic

900MHz Cordless Answering System

Model No. **KX-TC1890B**

Pulse-or-tone dialing capability

Operating Instructions



Preparation

Cordless Telephone

Answering System

Useful Information

2 LINE

**PLEASE READ BEFORE USE
AND SAVE.**

Caller ID Compatible

Charge the battery for about 4 hours before initial use.

Before Initial Use

Please read **IMPORTANT SAFETY INSTRUCTIONS** on page 84 before use.
Read and understand all instructions.

Thank you for purchasing your new Panasonic cordless telephone.

Caller ID and Call Waiting Service, where available, are telephone company services. After subscribing to Caller ID, this phone will display a caller's name and phone number. Visual Call Waiting, which displays a second caller's name and phone number while the user is on another call, requires a subscription to both Caller ID and Call Waiting.

Attach your purchase receipt here.

For your future reference

Serial No. _____
(found on the bottom of the unit)

Date of purchase _____

Name and address of dealer _____

Accessories (included) For extra orders, call 1-800-332-5368.

- AC Adaptor (p. 13)
Order No. PQLV10Z

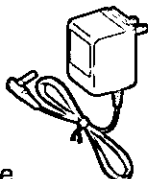

one

- 4-Wire Telephone
Line Cord with Green
Plugs (p. 14, 15)



one

- 2-Wire Telephone
Line Cord with
Transparent Plugs
(p. 15)



one

- Battery (p. 16, 77)
Order No.
P-P501 (KX-A36)



one

- Battery Cover (p. 16)
Order No.
PQKK10089Z1



one

- Belt Clip (p. 76)
Order No.
PQKE10083Z1

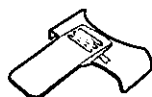

one

For Best Performance

Battery Charge

A rechargeable Ni-Cd battery powers the handset. Install the battery and charge it for about **4 hours** before initial use (p. 16).



Base Unit Location/Noise

Calls are transmitted between the base unit and the handset using wireless radio waves. **For maximum distance and noise-free operation**, the recommended base unit location is:

Away from electrical appliances such as a TV, personal computer or another cordless phone.

In a **HIGH** and **CENTRAL** location with no obstructions such as walls.

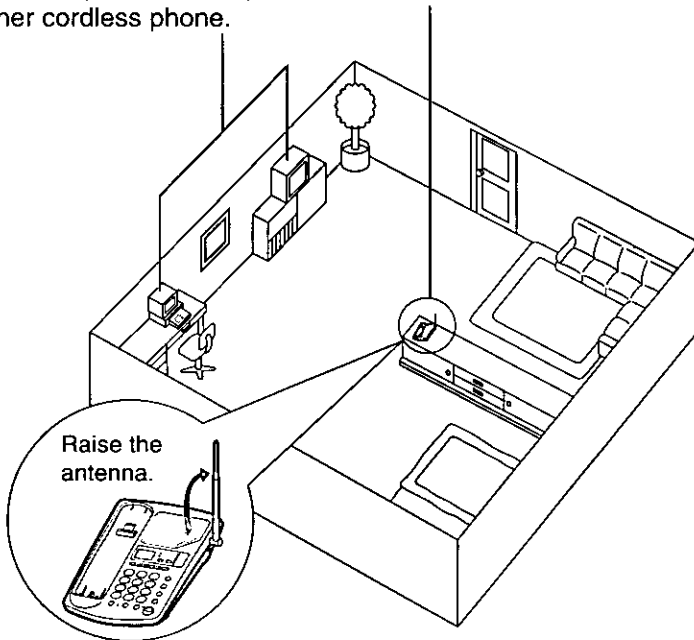

- If more than one cordless phone is being used and your handset is near another cordless phone's base unit, noise may be heard. Move away from the other cordless phone's base unit and closer to your base unit.

Contents

Preparation

Location of Controls	6
Displays	10
Settings	13
Connecting the AC Adaptor	13
Connecting the Telephone Line Cord	14
Installing the Battery in the Handset	16
Battery Charge	16
Stand-by Mode	17
Selecting the Dialing Mode	18
Selecting the Line Mode	19
Storing Your Area Code	20
Storing a Second Area Code	21
Setting the Auto Talk Feature	22
Selecting the Ringer Volume	23
Wall Mounting	24
Preparing the Answering System	25
Greeting Message	25
Programming Summary for the Answering System	27
Time and Day Adjustment	28
Selecting the Caller's Recording Time	29
Selecting the Number of Rings	29

Cordless Telephone

Making Calls	30
With the Handset	30
With the Base Unit (Digital Duplex Speakerphone)	32
Answering Calls	34
With the Handset	34
With the Base Unit	34
Speed Dialer	35
Storing Phone Numbers in Memory	35
Dialing a Stored Number	36
Caller ID Service	37
Using the Caller List	39
Viewing the Caller List	39
Calling Back from the Caller List	41
Editing the Caller's Phone Number	42
Storing Caller List Information in the Speed Dialer Memory	43
Erasing Caller List Information	44
Using the Other Line During a Conversation	45
While Someone Else is Using a Line (Simultaneous Base/Handset Calling)	45

While You are Using a Line	46
Conference Call	47
Intercom	48
Transferring a Call Using the Intercom	49
Special Features	50
For Call Waiting Service Users	50
Automatic Security Code Setting	51
Temporary Tone Dialing (For Rotary or Pulse Service Users)	51
How to Use the PAUSE Button (For Analog PBX Line/Long Distance Service Users)	51
FLASH Button	52
Line Selection	53
Incoming Call Tone	54
Line Indicator	55

Preparation

cordless Telephone

Answering System

Automatic Answering Operation	56
Setting the Unit to Answer Calls	56
Listening to Messages	57
From the Handset	59
Erasing Messages	60
Pager Call	61
Storing a Pager Number	61
Storing Your Home Telephone Number	63
Pager Mode Setting	64
Setting the Unit to Call a Pager	65
Remote Operation from a Touch Tone Phone	66
Setting the Remote Code	67
Voice Menu	68
Direct Remote Operation	70
Remote Operation with the Handset	73

Answering System

Useful Information

Using the Belt Clip	76
Using the Optional Headset	76
Battery Replacement	77
Adding Another Phone	77
Before Requesting Help	78
Important Safety Instructions	84
FCC and Other Information	86

Useful Information

Location of Controls

Handset (Front)

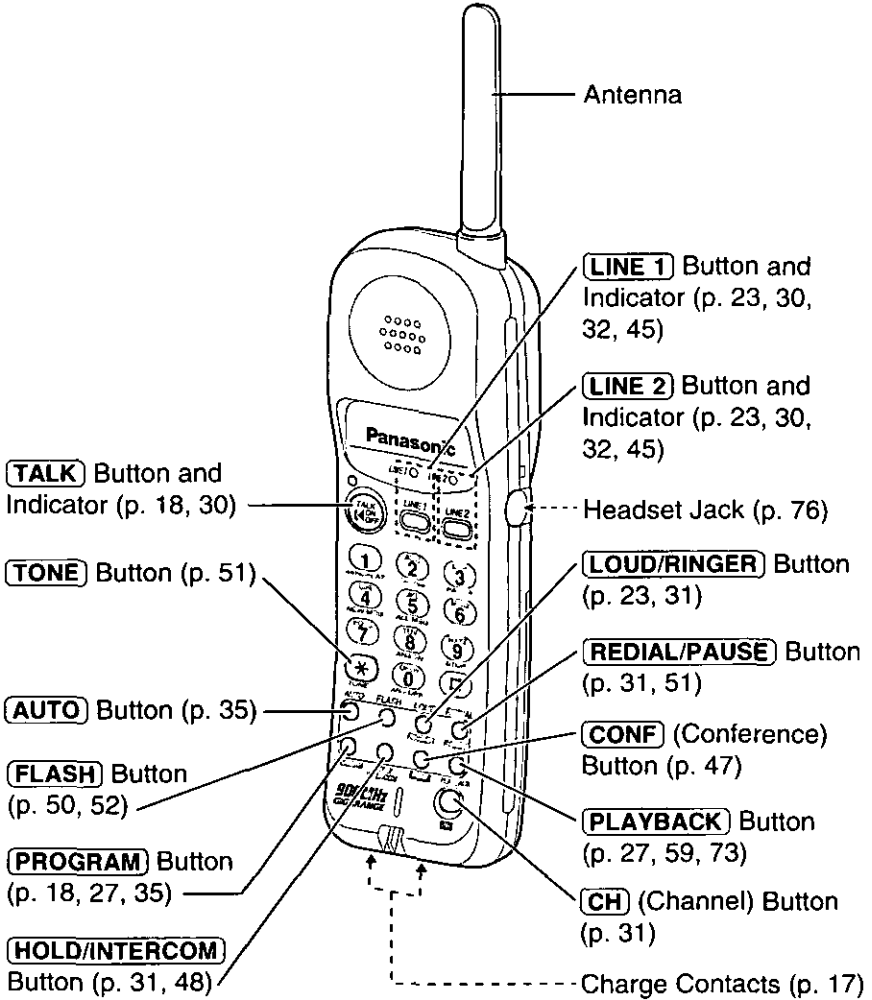



Handset (Back)

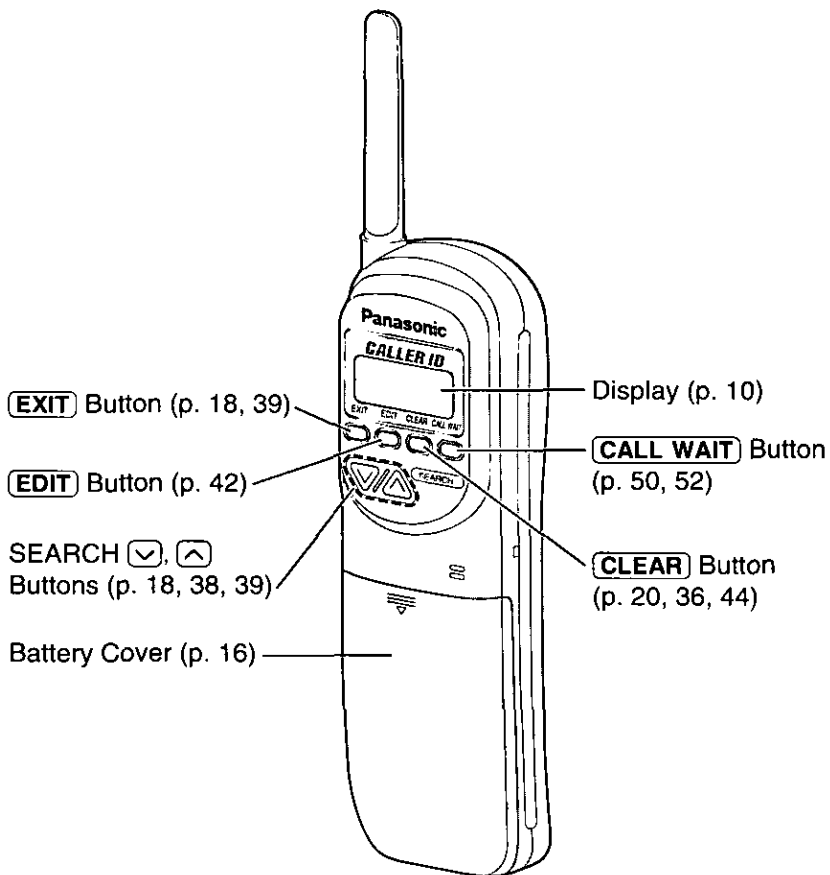

► Location of Controls

Base unit

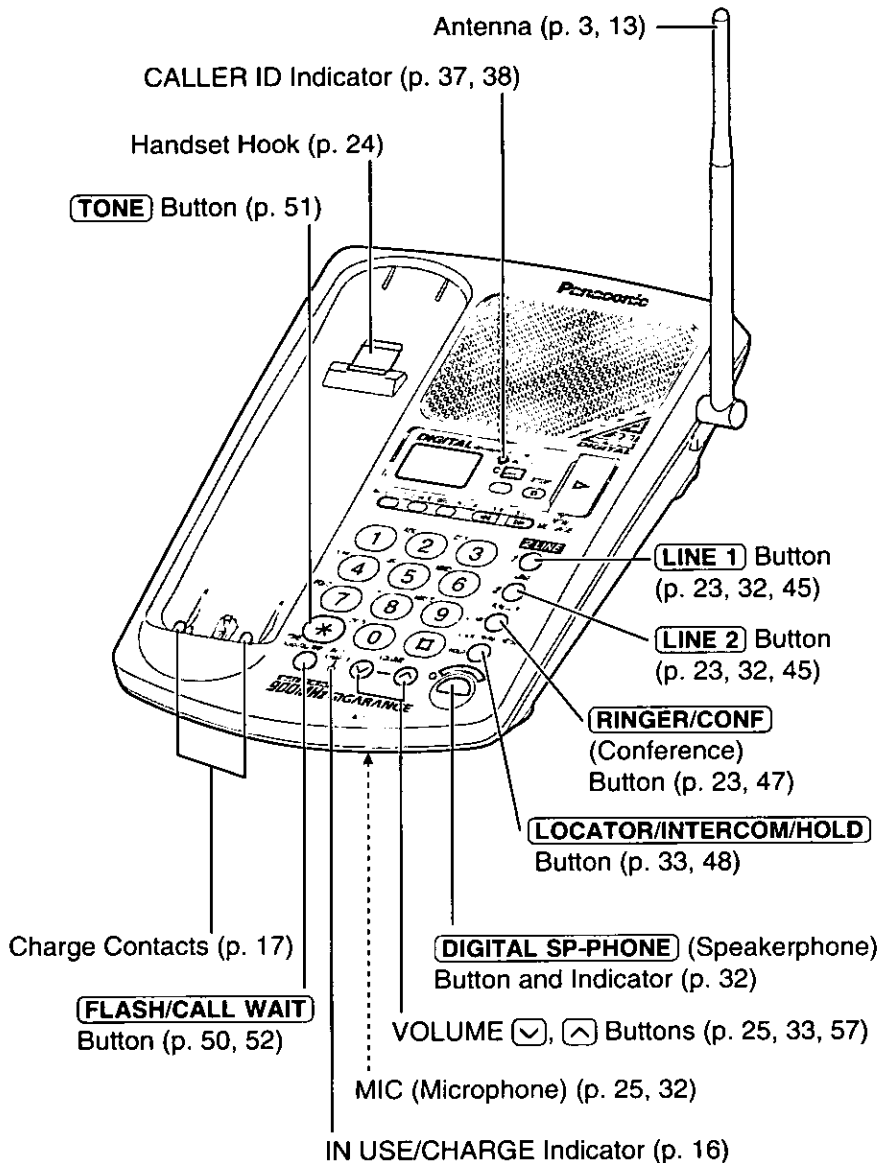

NEW MESSAGE Button (p. 57)

STOP Button (p. 25, 58)

ANSWER ON Button and Indicator (p. 56)

Display (p. 12)

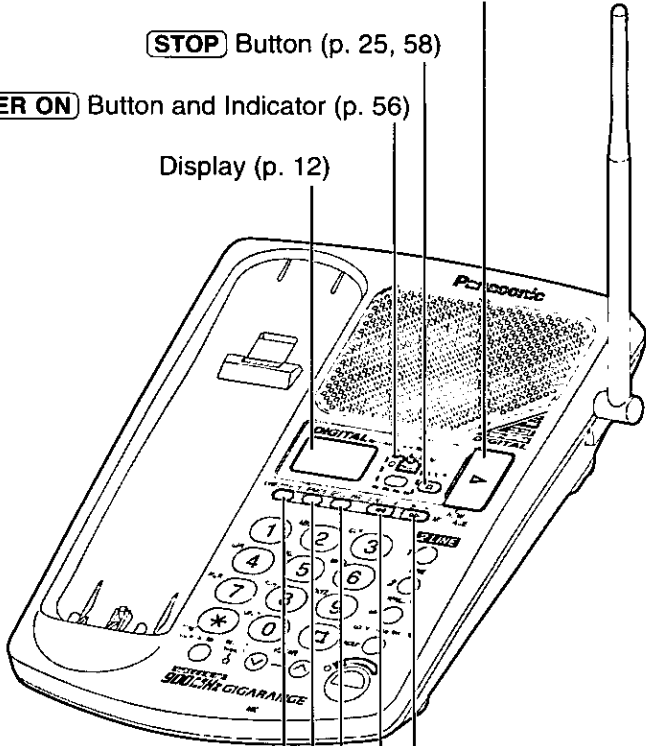

LINE SELECT Button (p. 25, 56, 57, 60)

ERASE Button (p. 26, 60)

GREETING Button (p. 25)

REPEAT/REW (Rewind) Button (p. 58)

SKIP/FF (Fast Forward) Button (p. 58)

Displays

Both the handset and the base unit show you instructions and information on their displays. These display prompts are shown below.

Handset display

No items stored

The Caller List for both lines is empty.



Recharge 



The battery needs to be charged. Place the handset on the base unit to charge the battery (p. 16).



12 new calls

The display shows the number of new calls and the battery strength (p. 16) while the handset is on the base unit.

12 new calls
v=New ^=Old

This display will be shown when **SEARCH**  or  is pressed while the handset is off the base unit.

To search from the most recent call, press **SEARCH**  (New key). To search from the oldest call, press **SEARCH**  (Old key) (p. 39).

 Ringer off 

When the handset ringer volume is set to OFF for both lines (p. 23), "Ringer off" will flash for about 45 seconds before the handset returns to the stand-by mode (p. 17).

Talk
01-06-35 

During a conversation, the display shows the length of the call (ex. 1 hour, 6 minutes and 35 seconds). The battery strength is also displayed (p. 16).

Out of range

The handset has lost communication with the base unit. Move closer to the base unit.

TINA ROBINSON
1-000-222-3333 

When a call is received, the display shows the caller's name, number and the called line after the first ring.



JACK SMITH
111-2222
11:20A JAN12 x3

This is a name from the Caller List.
The display shows:
—the caller's name,
—the caller's number and the called line,
—the time and date of the last call
(ex. Jan. 12, 11:20 AM), and
—the number of times called (ex. 3 times).

Paging
Press INTERCOM

The base unit is paging the handset (p. 48).

Intercom
00-00-07 {000}

The handset and the base unit are in the intercom mode (p. 48).

Intercom hold
00-01-12 {000}

An outside call has been put on hold by the handset user in the intercom mode (p. 49).

Hold
00-01-12 {000}

An outside call has been put on hold by the handset user (p. 31).

NANCY BROWN
1-000-222-3333
----Waiting----

A second call is received during a conversation (p. 50).

Please lift up
and try again

SEARCH or was pressed while the handset was on the base unit. Lift the handset and press **SEARCH** or again.

Not available

SEARCH or , **PLAYBACK** or **HOLD/INTERCOM** was pressed while the base unit was not in the stand-by mode.

Answering
system setting

The unit is in the answering system programming mode (p. 27).

Remote
operation
{000}

The handset is operating the answering system remotely (p. 73).

► Displays

Base unit display

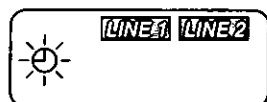

The clock needs adjusting (p. 28).

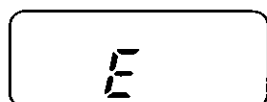

Your greeting message was not recorded correctly. Record it again (p. 25).

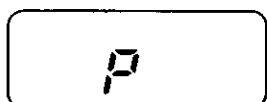

The unit is in the answering system programming mode.

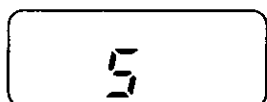

The speaker volume level is set to "5".
You can select:
—9 levels (0–8) while using the answering system (p. 25, 57).
—8 levels (1–8) while using the speakerphone (p. 33).

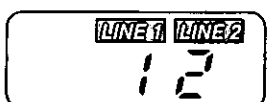

12 messages have been recorded.

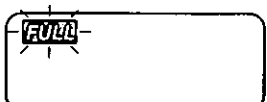

Memory is full. Erase some, or all, of the messages (p. 60).

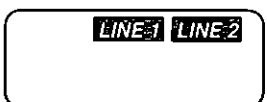

The recording time for both lines is set to "greeting only" (p. 29).



The pager call mode is set to ON (p. 65).

Connecting the AC Adaptor

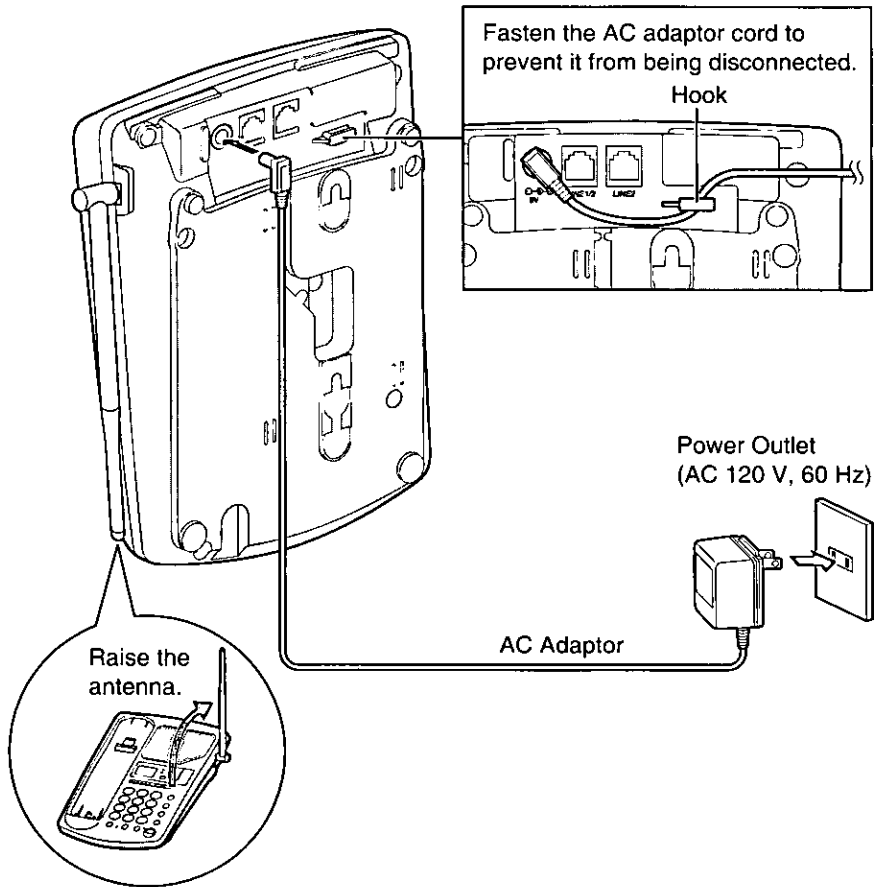

- USE ONLY WITH Panasonic AC ADAPTOR PQLV10 (Order No. PQLV10Z).
- The AC adaptor must remain connected at all times. (It is normal for the adaptor to feel warm during use.)
- To connect a standard telephone on the same line, see page 77.
- If your unit is connected to a PBX which does not support Caller ID services, you cannot access those services.

► Settings

Connecting the Telephone Line Cord

Connect the telephone line cord(s) to the unit as follows.

To connect a two-line telephone jack

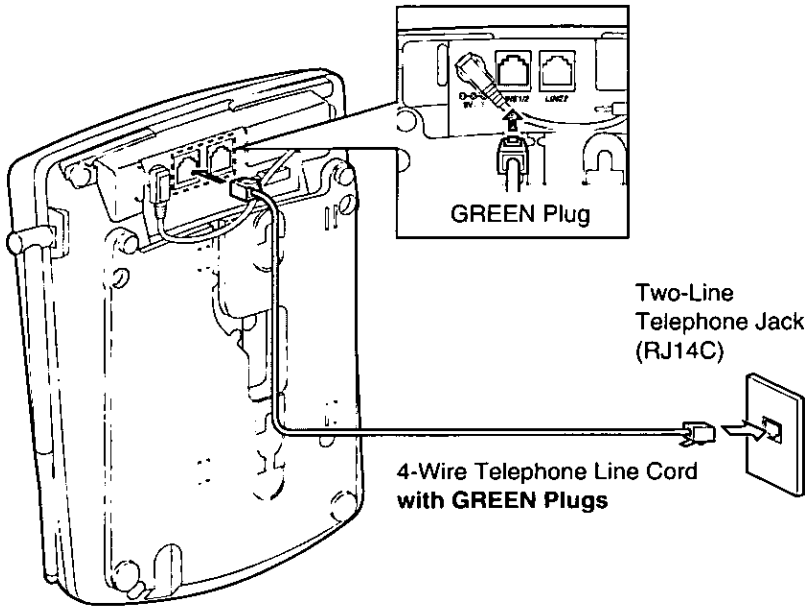



To connect two single-line telephone jacks

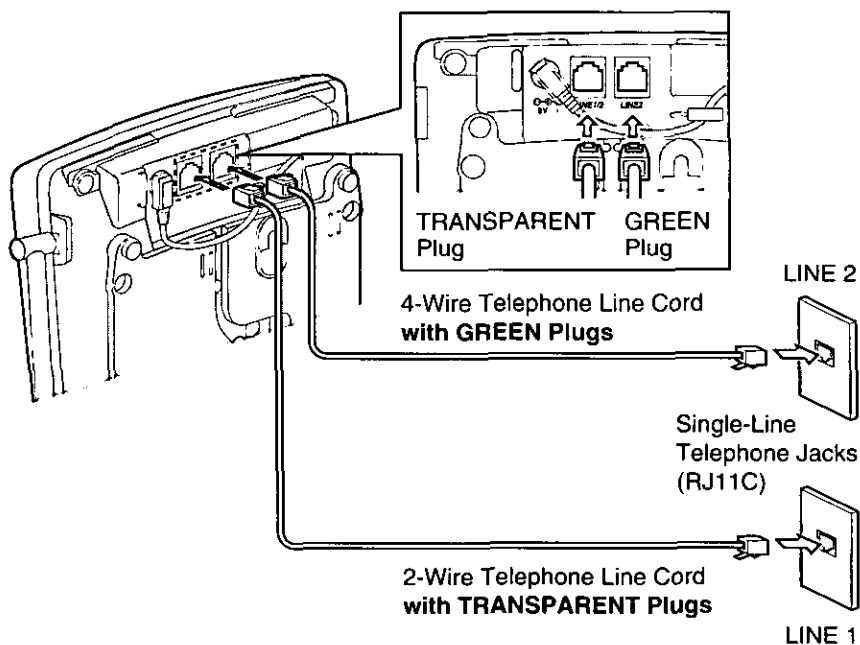

If you use the unit as a single-line telephone only

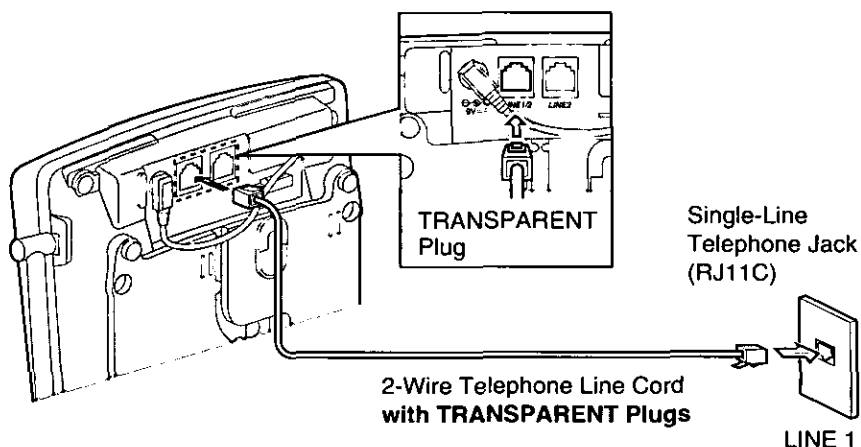

◦With this connection, you can only use LINE 1. The LINE 2 indicator on the handset and the LINE 2 button on the base unit will continue to flash. To turn the lights off, see page 55.

➡ Settings

Installing the Battery in the Handset

Install the battery and close the battery cover, locking it into place.

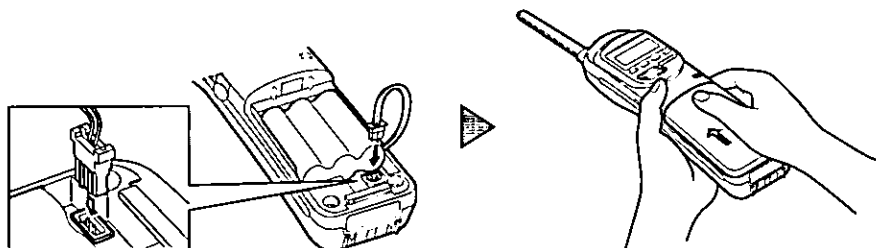

Battery Charge

Place the handset on the base unit and charge for about **4 hours** before initial use.

- The IN USE/CHARGE indicator lights.

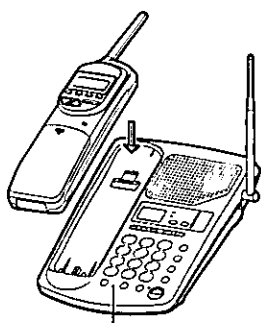

IN USE/CHARGE Indicator

Battery strength

You can check the battery strength on the display while the handset is on the base unit, while it is in use (making/answering a call etc.), or after viewing the Caller List, programming, etc.

The battery strength will remain on the display for 5 seconds after using the handset, then the display will return to the stand-by mode (see next page).

The battery strength is shown as in the chart below.

Display prompt	Battery strength
{ ■■■ }	Fully charged
{ ■■ }	Medium
{ ■ }	Low
⚡ { ■ } ⚡ (flashing)	Needs to be recharged.



Recharge

Recharge the battery when:

- “Recharge” is displayed on the handset,
- “[]” flashes on the handset display, or
- the handset beeps intermittently while it is in use.

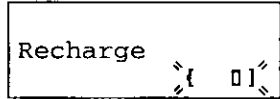

- If you DO NOT recharge the handset battery for more than 15 minutes, the display will keep indicating “Recharge” and/or “[]” will continue to flash.

Battery information

After your Panasonic battery is fully charged (p. 16):

Operation		Approx. battery life
While in use (TALK)	near the base unit*	Up to about 6 hours
	away from the base unit	Up to about 4 hours
While not in use (Stand-by)		Up to about 7 days

*Within about 10 feet (3 m)

- Battery life may be shortened depending on usage conditions, such as viewing the Caller ID Caller List, and ambient temperature.
- Clean the handset and the base unit charge contacts with a soft, dry cloth once a month. Clean more often if the unit is subject to grease, dust or high humidity.** Otherwise the battery may not charge properly.
- If the battery is fully charged, you do not have to place the handset on the base unit until “Recharge” is displayed and/or “[]” flashes. This will maximize the battery life.
- The battery cannot be overcharged.

Stand-by Mode

Handset (While off the base unit)

The handset goes into the stand-by mode after you finish using the handset (making/answering a call, viewing the Caller List etc.). The display is blank, but the handset can receive calls. The battery life is conserved in this mode.

Base unit

The base unit goes into the stand-by mode after you finish using the base unit (making/answering a call, using the intercom, using the answering system etc.). Programming and storing phone numbers are possible **only** when the base unit is in the stand-by mode.

► Settings

Selecting the Dialing Mode

If you have touch tone service, set to "Tone". If rotary or pulse service is used, set to "Pulse". Your phone comes from the factory set to "Tone". **The TALK indicator light must be off and the base unit must be in the stand-by mode before programming. Use the handset near the base unit.**

1 Press **PROGRAM**.

- The TALK indicator flashes.

Save AUTO# ?

v=Next ^=Yes

2 Press **SEARCH** (Next key) repeatedly until "Set dial mode ?" is displayed.

Set dial mode ?

v=Next ^=Yes

3 Press **SEARCH** (Yes key).

Dial mode

v=Tone ^=Pulse

4 To select "Pulse", press **SEARCH** .

OR

To select "Tone", press **SEARCH** .

Dial mode

Pulse

- A beep sounds.

- The display will return to the stand-by mode.

Dial mode

Tone

- To cancel during programming, press **EXIT** or **PROGRAM**. Start again from step 1.
- If 3 beeps sound and the display shows "Out of range", move closer to the base unit and try again. If "Out of range" is still displayed, place the handset on the base unit. Start again from step 1.
- If either line has rotary or pulse service, set to "Pulse". When making a call using a line which has touch tone service, press **TONE** first and then dial the number.



Selecting the Line Mode

If the line is connected to a low voltage system such as a PBX, set to "B". Otherwise the line indicators may not operate properly, the Visual Call Waiting (Call Waiting ID) Service may not be accessible (p. 50), you may not hear the incoming call tone (p. 54), and the unit may not alert your pager (p. 61). Both lines are preset to "A".

The TALK indicator light must be off and the base unit must be in the stand-by mode before programming. Use the handset near the base unit.

- 1 Press **PROGRAM**.
 - oThe TALK indicator flashes.

```

Save AUTO# ?
v=Next      ^=Yes
  
```

- 2 Press **SEARCH** (Next key) repeatedly until "Set line mode ?" is displayed.

```

Set line mode ?
v=Next      ^=Yes
  
```

- 3 Press **SEARCH** (Yes key).

```

Set line mode
v=Line1    ^=Line2
  
```

- 4 Press **SEARCH** (Line1) or **SEARCH** (Line2) to select the desired line.

```

Line mode
v=A        ^=B
  
```

- 5 To select "B", press **SEARCH** .

OR

 To select "A", press **SEARCH** .

 - oA beep sounds.
 - oThe display will return to the stand-by mode. To program the other line, start again from step 1.

```

Line mode
                                     A
  
```

```

Line mode
                                     B
  
```

- oTo cancel during programming, press **EXIT** or **PROGRAM**. Start again from step 1.
- oIf 3 beeps sound and the display shows "Out of range", move closer to the base unit and try again. If "Out of range" is still displayed, place the handset on the base unit. Start again from step 1.

➤ Settings

Storing Your Area Code

We recommend that you first program your area code before using the Caller ID feature (p. 37). Incoming calls with the same area code will then be recorded in the Caller List without the area code. You do not have to remove the area code before calling back or storing. When incoming calls with a different area code are received, "1" will automatically be added before the area code.

The TALK indicator light must be off and the base unit must be in the stand-by mode before programming. Use the handset near the base unit.

1 Press **PROGRAM**.

- The TALK indicator flashes.

```
Save AUTO# ?
v=Next      ^=Yes
```

2 Press **SEARCH** (Next key). Make sure that "Area code ?" is displayed.

```
Area code ?
v=Next      ^=Yes
```

3 Press **SEARCH** (Yes key).

- The current setting is displayed. If no area code has been programmed, "----" will be displayed.

```
Area code
: ---
Enter area code
```

4 Enter your area code.

- If you enter a wrong number, press **CLEAR** and enter the correct number.

```
Area code
: 123
PROGRAM=Save
```

5 Press **PROGRAM** (Save key).

- A beep sounds.
- The display will return to the stand-by mode.

```
Area code
: 123
```

•To cancel during programming, press **EXIT**. Start again from step 1.

•If 3 beeps sound and the display shows "Out of range", move closer to the base unit and try again. If "Out of range" is still displayed, place the handset on the base unit. Start again from step 1.

To erase the area code

Press **PROGRAM** ⇒ **SEARCH** (Next key) ⇒

⇒ **SEARCH** (Yes key) ⇒ **CLEAR** ⇒ **PROGRAM** (Save key).

•If a "2nd area code" has been stored (p. 21), it will also be erased automatically.



Storing a Second Area Code

You can program a second local area code. This area code does not require "1" before it when dialing. After storing this area code, the display will show the 10 digits (3-digit area code plus 7-digit phone number) after a call is received from that area. Calls will be recorded in the Caller List without "1". You cannot store a second area code unless your area code is stored first (p. 20).

The TALK indicator light must be off and the base unit must be in the stand-by mode before programming. Use the handset near the base unit.

1 Press **PROGRAM**.

◦The TALK indicator flashes.

Save AUTO# ?

v=Next ^=Yes

2 Press **SEARCH** (Next key) repeatedly until "2nd area code ?" is displayed.

2nd area code ?

v=Next ^=Yes

3 Press **SEARCH** (Yes key).

◦The current setting is displayed. If no second area code has been programmed, "---" will be displayed.

◦If 3 beeps sound, your area code has not been stored. Store the code first (p. 20), and start again from step 1.

2nd area code

:---

Enter area code

4 Enter a second area code.

◦If you enter a wrong number, press **CLEAR** and enter the correct number.

2nd area code

:124

PROGRAM=Save

5 Press **PROGRAM** (Save key).

◦A beep sounds.

◦The display will return to the stand-by mode.

2nd area code

:124

◦To cancel during programming, press **EXIT**. Start again from step 1.

◦If 3 beeps sound and the display shows "Out of range", move closer to the base unit and try again. If "Out of range" is still displayed, place the handset on the base unit. Start again from step 1.

To erase the second area code

Press **PROGRAM** ⇒ **SEARCH** (Next key) twice ⇒

⇒ **SEARCH** (Yes key) ⇒ **CLEAR** ⇒ **PROGRAM** (Save key).

Setting the Auto Talk Feature

The Auto Talk feature allows you to answer a call by lifting the handset off the base unit without pressing **TALK**. If you want to view caller's information on the display after lifting the handset, turn this feature OFF by programming. Your phone comes from the factory set to ON.

The TALK indicator light must be off and the base unit must be in the stand-by mode before programming. Use the handset near the base unit.

- 1 Press **PROGRAM**.
◦The TALK indicator flashes.

```
Save AUTO# ?
v=Next      ^=Yes
```

- 2 Press **SEARCH** (Next key) repeatedly until "Talk switching?" is displayed.

```
Talk switching?
v=Next      ^=Yes
```

- 3 Press **SEARCH** (Yes key).

```
Auto talk
v=On        ^=Off
```

- 4 To select OFF, press **SEARCH** (Yes key).
OR
To select ON, press **SEARCH** (Next key).
◦A beep sounds.
◦The display will return to the stand-by mode.

```
Auto talk
Off
```

```
Auto talk
On
```

- To cancel during programming, press **EXIT** or **PROGRAM**. Start again from step 1.
- If 3 beeps sound and the display shows "Out of range", move closer to the base unit and try again. If "Out of range" is still displayed, place the handset on the base unit. Start again from step 1.
- To answer a call when the Auto Talk feature is OFF, lift the handset off the base unit and press **TALK**.



Selecting the Ringer Volume

With the handset

The TALK indicator light must be off.

◦To select HIGH (preset) or LOW

1. Press **LOUD/RINGER**.
 - Both line indicators will flash.
2. Press **LINE 1** or **LINE 2** to select the desired line.
 - Each time you press the line button, the ringer volume for the selected line will change and the selected volume will ring.

HIGH

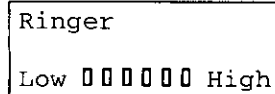

LOW

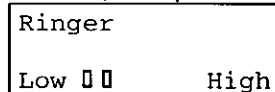

◦To turn the ringer OFF

1. Press **LOUD/RINGER**.
2. Press and hold **LINE 1** or **LINE 2** until 2 beeps sound.
 - "Ringer off" will flash for about 45 seconds before the handset returns to the stand-by mode.

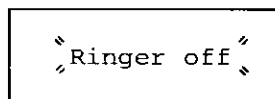

◦To turn the ringer ON

- Press **LOUD/RINGER** and then **LINE 1** or **LINE 2**.
- The ringer for the selected line will sound at the HIGH level.

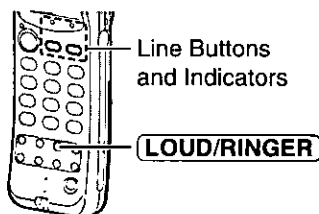

With the base unit

The handset and the base unit must be in the stand-by mode before programming.

◦To select HIGH (preset) or LOW

1. Press **RINGER/CONF**.
 - Both line buttons will flash.
2. Press **LINE 1** or **LINE 2** to select the desired line.
 - Each time you press the line button, the ringer volume for the selected line will change and the selected volume will ring.

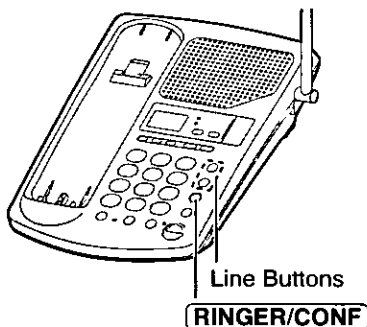

◦To turn the ringer OFF

1. Press **RINGER/CONF**.
2. Press and hold **LINE 1** or **LINE 2** until 2 beeps sound.

•To turn the ringer ON

- Press **RINGER/CONF** and then **LINE 1** or **LINE 2**.
- The ringer for the selected line will sound at the HIGH level.

➤ Settings

Wall Mounting

This unit can be mounted on a wall phone plate.

- 1 Pull down the handset hook until it locks, **so the tab holds the handset.**

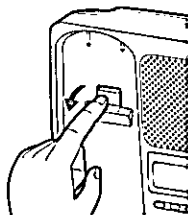

- 2 Connect the AC adaptor.

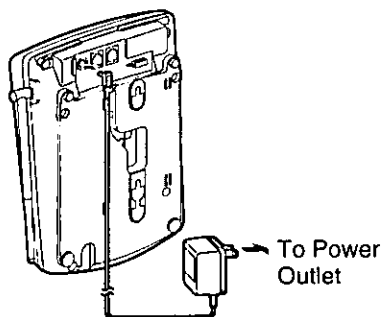

- 3 Connect the telephone line cord. Mount the unit, then slide down.
 - Raise the antenna.

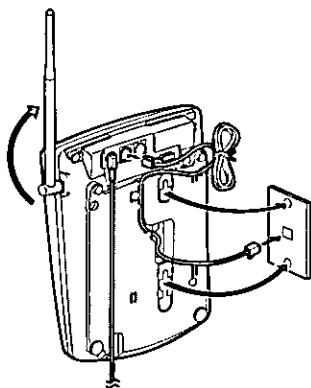

- 4 **To charge the battery:**
Place the handset on the handset hook as shown.
 - The IN USE/CHARGE indicator lights.

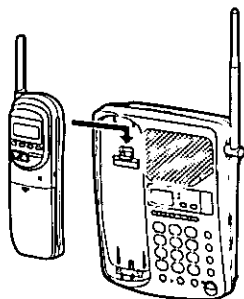

Preparing the Answering System

Greeting Message

You can record a personal greeting message of **up to 2 minutes** for each line or a common greeting message for both lines. If a greeting message is not recorded, one of two pre-recorded greetings will be played when a call is received (p. 26).

All messages (greeting, incoming, etc.) are stored in digital memory (p. 26). The **total recording time is about 15 minutes**.

We recommend you record a **brief greeting message** (see sample on next page) in order to leave more time for recording new messages.

To record a greeting message

- 1 a) To record a common greeting, press **LINE SELECT** repeatedly until "**LINE1 LINE2**" is displayed.
b) To record a greeting for each line, press **LINE SELECT** repeatedly until "**LINE1**" or "**LINE2**" is displayed.

- 2 Press and hold **GREETING** until "Record greeting after the beep" is announced.

- 3 After the long beep, talk clearly, about 8 inches (20 cm) away from the **MIC** (microphone).
 - The base unit display shows the elapsed recording time.
 - If you record for over 2 minutes, the unit will automatically stop recording.

- 4 When finished, press **STOP**.
 - To change the message, start again from step 1.

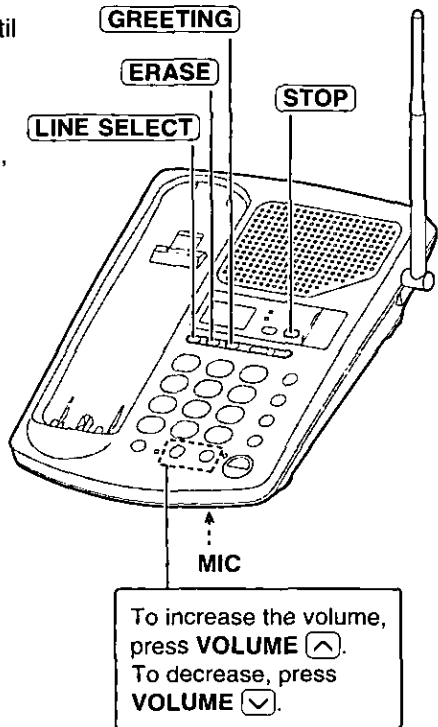

► Preparing the Answering System

Greeting message sample

“Hello, this is (your name and/or number). Sorry I cannot take your call. Please leave a message after the beep. Thank you.”

To check the greeting message(s)

Press **(LINE SELECT)** repeatedly to select the desired line(s), then press **(GREETING)** briefly.

- The selected greeting(s) is (are) played back.
- When both lines are selected, the LINE 1 greeting will be played first.

To erase the recorded greeting message

Repeat the checking procedure above, then press **(ERASE)** while the message is being played.

- The unit will answer a call with a pre-recorded greeting for the relevant line(s).
- If you record a greeting for each line, you cannot erase those greetings at one time, even if you select both lines when erasing. Only the greeting message which is being played can be erased.

Pre-recorded greeting message

If you do not record a greeting message (p. 25), one of two messages will be played when a call is received, depending on the caller's recording time (p. 29).

- When the recording time is set to “1 minute” or “3 minutes”:
“Hello, we are not available now. Please leave your name and phone number after the beep. We will return your call.”
- When the recording time is set to “greeting only”:
“Hello, we are not available now. Please call again. Thank you for your call.”

Flash Memory Message Backup

Messages are stored indefinitely on a “flash memory” IC chip and will not be affected by power failures. All messages are saved until you erase them.



Programming Summary for the Answering System

You can program the following functions **using the handset near the base unit**. See the page numbers below for details.

The TALK indicator light must be off and the base unit must be in the stand-by mode before programming.

Lift the handset, and press **(PROGRAM)**.



Press **(PLAYBACK)**.

◦ "Answering system setting" is displayed on the handset.



◦ If the handset displays "Out of range" and an alarm tone sounds, move closer to the base unit and try again.

To adjust **the time and day**, press **(0)**. (page 28)

To set **the remote code**, press **(1)**. (page 67)

To select **the number of rings**, press **(2)**. (page 29)

To select **the caller's recording time**, press **(5)**. (page 29)

To select **the pager mode setting**, press **(6)**. (page 64)

To store **your home telephone number**, press **(7)**. (page 63)

To store **a pager number**, press **(#)**. (pages 61, 62)

◦ The base unit display shows numbers or characters related to the adjustment or settings.



Press **(PROGRAM)**.

◦ A beep sounds.

◦ If 6 beeps sound, the setting is not correct. Start again from the beginning.

◦ To cancel during programming, press **(PROGRAM)**. Start again from the beginning.

◦ If 6 beeps sound during programming, a wrong key was pressed. Enter the correct number.

➤ Preparing the Answering System

Time and Day Adjustment

Voice Time/Day Stamp: During playback, a synthesized voice will announce the time and day that each message was recorded.

- 1 Press **PROGRAM**.
 - The TALK indicator flashes.
- 2 Press **PLAYBACK**.
 - "P" is displayed on the base unit.
- 3 Press **0**.
 - "Set time" is announced. If previously adjusted, the time/day will be heard.
- 4 Enter the current time (hour and minute) using a 4-digit number. (Ex. To set 9:30, enter "0930".)
 - The entered number is displayed on the base unit.
- 5 Press ***** to select "AM" or "PM".
Press **#** repeatedly to set the day.
- 6 Press **PROGRAM**.
 - The unit announces the time/day.
The clock starts working.

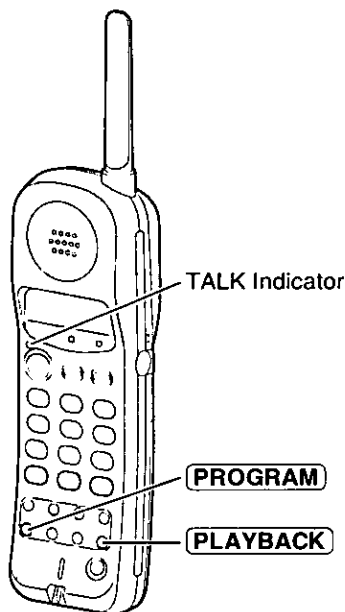

◦In step 4, you cannot enter numbers greater than 12. **Do not use military time.** (To set 13:00 hours, enter "0100" and select "PM" by pressing *****.)

If a power failure occurs, the adjusted time/day will be erased.
Reprogram the current time/day.

To check the time/day

Press **PROGRAM** ⇒ **PLAYBACK** ⇒ **0**.

◦The current time/day is heard. When finished, press **PROGRAM**.

For Caller ID service users (p. 37)

- The Caller ID information will re-set the clock after the first ring if the adjusted time is incorrect. However, if the time has not previously been set, the Caller ID information will not adjust the clock.
- The Caller ID information will automatically adjust the clock for daylight saving time.

Selecting the Caller's Recording Time

You can select "1 minute", "3 minutes" or "greeting only" for the caller's recording time. Your phone comes from the factory set to "3 minutes".

- 1 Press **PROGRAM**.
◦The TALK indicator flashes.
 - 2 Press **PLAYBACK**.
◦"P" is displayed on the base unit.
 - 3 Press **5**.
 - 4 To select LINE 1, press **1**.
To select LINE 2, press **2**.
◦The current setting of the selected line is displayed on the base unit.
 - 5 Press **1**, **2** or **3** to select the recording time.
1: 1 minute
2: 3 minutes (factory preset)
3: greeting only
 - 6 Press **PROGRAM**.
◦A beep sounds.
- If you select "greeting only", the unit will answer a call with the greeting message, and then hang up. The unit will not record any incoming messages.

Selecting the Number of Rings

You can select the number of times the unit rings before the answering system answers a call, from "2" to "7" or "AUTO" (for Toll Saver*). Your phone comes from the factory set to "AUTO".

- 1 Press **PROGRAM**.
◦The TALK indicator flashes.
- 2 Press **PLAYBACK**.
◦"P" is displayed on the base unit.
- 3 Press **2**.
- 4 To select LINE 1, press **1**.
To select LINE 2, press **2**.
◦The current setting of the selected line is displayed on the base unit.
- 5 Press **0**, or **2** to **7** to set the number of rings.
0: Selects "AUTO".
"A" is displayed.
2-7: The unit will answer after the selected number of rings.
- 6 Press **PROGRAM**.
◦A beep sounds.

*Toll Saver (When set to "AUTO")

When you call the unit from a touch tone telephone:

If the unit answers on the 2nd ring, there is at least one new message.

If the unit answers on the 4th ring, there are no new messages.

Hang up when you hear the 3rd ring. This will save you the toll charge for the call.

Making Calls

The unit will automatically select a free line, which is not being used by a parallel connected telephone, when you lift the handset to make a call. (To change the line selection, see page 53.)

With the Handset

To have a hands-free conversation, connect the optional headset to the handset (p. 76).

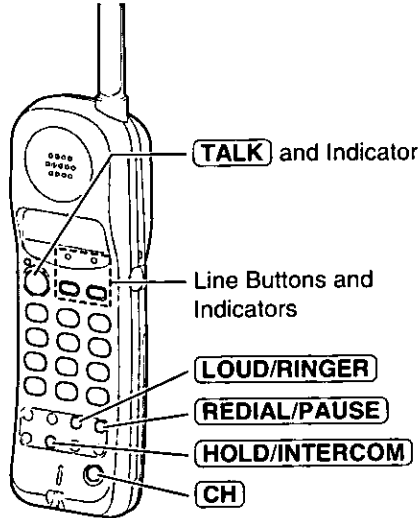

- 1** Press **TALK**.
- The TALK indicator lights.
 - A free line is automatically selected and the line indicator lights.

Talk
[■■■]

- 2** Dial a telephone number.
- The dialed number is displayed.
 - After a few seconds, the display will show the length of the call.

Talk
1112222
[■■■]

Talk
00-00-00
[■■■]

- 3** To hang up, press **TALK** or place the handset on the base unit.
- The indicator lights go out.
 - The display will return to the stand-by mode.

- If "Out of range" is displayed and an alarm tone sounds in step 1, move closer to the base unit or place the handset on the base unit, and try again.
- To switch a call from the handset to the speakerphone, see page 33.
- In step 1, you may select a line manually by pressing the line button instead of **TALK**.



To redial the last number dialed

Press **TALK** ⇒ **REDIAL/PAUSE**.

To select the handset receiver volume

Press **LOUD/RINGER** while talking.

- Each time you press the button, the volume level will change from MEDIUM (preset) to HIGH to LOW.
- The display will return to the length of the call.

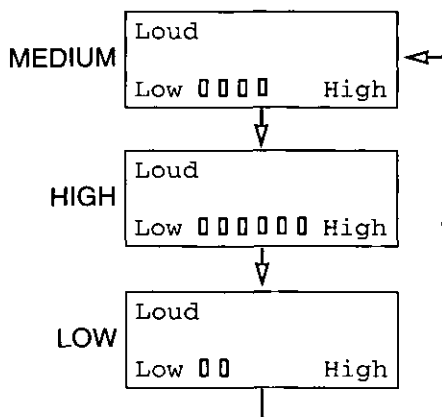

Cordless Telephone

If noise interferes with the conversation

Press **CH** to select a clearer channel or move closer to the base unit.

To put a call on hold

Press **HOLD/INTERCOM**.

- The TALK indicator light goes out and the line indicator flashes.

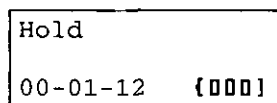

To release the hold

Press the line button on the handset whose indicator is flashing or the line button on the base unit which is flashing.

- If another phone is connected on the same line (p. 77), you can also release the hold by lifting its handset.

Lighted handset keypad

The handset dialing buttons will light when you press a button or lift the handset off the base unit, and flash when a call is received. The lights will go out about 10 seconds after pressing a button, lifting the handset or answering a call.

➤ Making Calls

Backlit LCD display

The lighted handset display will stay on for about 10 seconds after pressing a handset button.

What the line indicator means

Off	The line is free.
On	You are using the line on the handset or the base unit.
Flashing twice every 2 seconds	Someone else is using the line on the handset, base unit or parallel connected telephone.
Flashing	A call is on hold.
Flashing quickly	A call is being received.

With the Base Unit (Digital Duplex Speakerphone)

1 Press **DIGITAL SP-PHONE**.

- The DIGITAL SP-PHONE indicator lights.
- A free line is automatically selected and the line button lights.

2 Dial a telephone number.

3 When the other party answers, talk into the **MIC** (microphone).

4 To hang up, press **DIGITAL SP-PHONE**.

- The indicator and the line button lights go out.

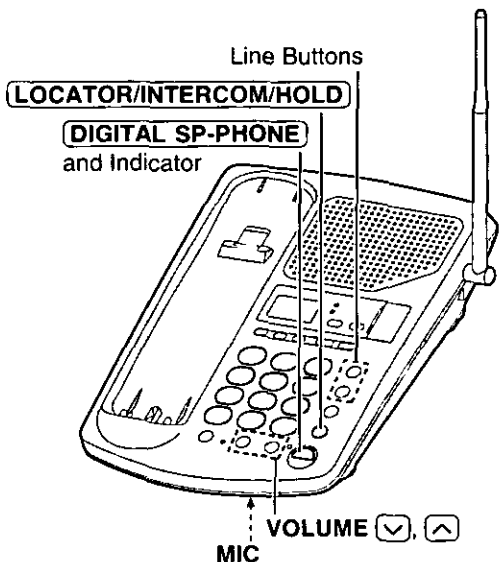

- To switch to the handset while using the speakerphone:
 - If the handset is off the base unit, press the line button whose indicator is flashing.
 - If on the base unit, just lift up.
- During a call using the handset, the call can be switched to the speakerphone by pressing the base unit's line button for the line which is being used on the handset.
- The line button shows the line status (see "What the line indicator means" on page 32).
- In step 1, you may select a line manually by pressing the line button instead of **DIGITAL SP-PHONE**.

Hands-free Digital Duplex Speakerphone

For best performance, please note the following:

- Talk alternately with the other party in a quiet room.
- If the other party has difficulty hearing you, press **VOLUME** to decrease the speaker volume.
- If the other party's voice from the speaker cuts in/out during a conversation, press **VOLUME** to decrease the speaker volume.

To adjust the speaker volume (8 levels) while talking

To increase, press **VOLUME** . To decrease, press **VOLUME** .

To put a call on hold

Press **LOCATOR/INTERCOM/HOLD**.

- The **DIGITAL SP-PHONE** indicator goes out and the line button flashes.

To release the hold

Press the line button on the base unit which is flashing or the line button on the handset whose indicator is flashing.

- If another phone is connected on the same line (p. 77), you can also release the hold by lifting its handset.

Answering Calls

When a call is received, the unit rings, and the called line indicator and button flash quickly. The line is automatically selected when you answer the call. (To change the line selection, see page 53.)

If you subscribe to a Caller ID service, the calling party information will be displayed on the handset after the first ring (p. 37). In order to view the caller's information, please wait until the second ring to answer a call.

With the Handset

If the handset is off the base unit, press

TALK.

- The TALK and the called line indicators light.
- You can also answer a call by pressing any dialing button (0) to (9), (*), or (#)
(—Any Key Talk).

Line Buttons and Indicators

TALK and Indicator

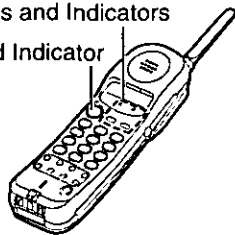

OR

If on the base unit, just lift up.

(This is not possible when the Auto Talk feature is set to OFF. See page 22.)

- You may answer a call by pressing the line button instead of **TALK**.
- When the ringer volume is set to "Off", the selected line(s) will not ring (p. 23).



When the optional headset is connected (p. 76), make sure to use the headset to talk with the caller. If you want to have a normal cordless phone conversation, disconnect the headset.

With the Base Unit

1 Press **DIGITAL SP-PHONE**.

- The DIGITAL SP-PHONE indicator and the called line button light.

2 Talk into the MIC.

3 To hang up, press **DIGITAL SP-PHONE**.

- You may answer a call by pressing the line button instead of **DIGITAL SP-PHONE**.
- When the ringer volume is set to "Off", the selected line(s) will not ring (p. 23).

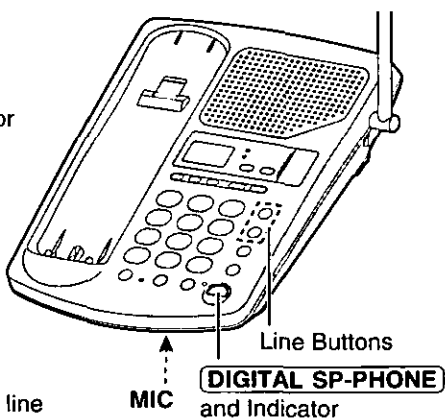



Storing Phone Numbers in Memory

You can store up to 10 phone numbers in the handset. The dialing buttons (0) to (9) function as memory stations.

The TALK indicator light must be off and the base unit must be in the stand-by mode before programming. Use the handset near the base unit.

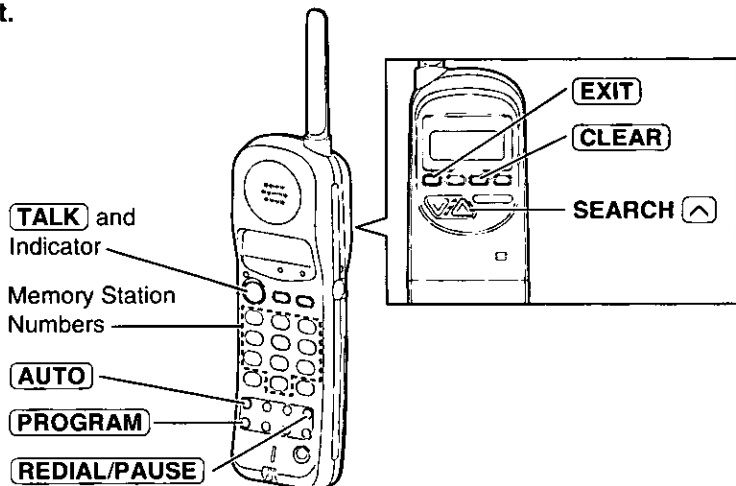

Cordless Telephone

- 1 Press **PROGRAM**.
 - The TALK indicator flashes.
- 2 Press **SEARCH** (Yes key).
- 3 Enter a phone number up to 22 digits.
 - If you enter a wrong number, press **CLEAR**. Digits are erased from the right.
- 4 Press **AUTO**.
- 5 Press a memory station number (0) to (9).
 - A beep sounds.
 - The display will return to the stand-by mode. To store other numbers, repeat steps 1 through 5.

Save AUTO# ?
v=Next ^=Yes

Enter phone no.

3334444

AUTO=Save

Select 0-9
to save in AUTO

3334444

Save in AUTO 1

➤ Speed Dialer

- To cancel during programming, press **(EXIT)** or **(PROGRAM)**. Start again from step 1.
- If 3 beeps sound and the display shows "Out of range", move closer to the base unit and try again. If "Out of range" is still displayed, place the handset on the base unit. Start again from step 1.
- If a pause is required for dialing, press **(REDIAL/PAUSE)** where needed. Pressing **(REDIAL/PAUSE)** counts as one digit (p. 51).

To erase a stored number

- 1 Press **(PROGRAM)**.
 - The TALK indicator flashes.
- 2 Press **SEARCH**  (Yes key).
- 3 Press **(CLEAR)**.
- 4 Press **(AUTO)**.
- 5 Press the memory station number (**(0)** to **(9)**) for the phone number to be erased.

Save AUTO# ?

v=Next ^=Yes

Enter phone no.

AUTO=Clear

Select 0-9 to
clear in AUTO

Clear in AUTO 1

Dialing a Stored Number

- 1 Press **(TALK)**.
- 2 Press **(AUTO)**.
- 3 Press the memory station number (**(0)** to **(9)**).
 - The stored number is dialed.

- In step 1, you may select a line manually by pressing the line button instead of **(TALK)**.
- If the line(s) has (have) rotary or pulse service, any access numbers stored after pressing **(TONE)** will not be dialed.

Caller ID Service



This unit is compatible with a Caller ID service offered by your telephone company. If you subscribe to a Caller ID service, the calling party's information will be displayed on the handset after the first ring.

The unit can record information of up to 50 different callers for both lines combined, including the time and date the call was received, the number of times called and the called line, in the Caller List. The Caller List information is sorted from the most recent to the oldest call. When the 51st call is received, the oldest call is deleted.

Using the list, you can automatically call back a caller. You can store the callers' numbers from the Caller List in the Speed Dialer memory.

If you subscribe to a Visual Call Waiting (Call Waiting ID) service, when a second call is received on the same line, the new caller's name and phone number will be displayed (p. 50).

How caller information is displayed when a call is received

The handset display shows the caller's name, number and the called line after the first ring.

TINA ROBINSON
1-000-222-3333

After you answer the call, the display will show the length of the call and the battery strength.

Talk
00-00-00 [0000]

◦ A line button will flash quickly and the CALLER ID indicator will flash when a call is being received.

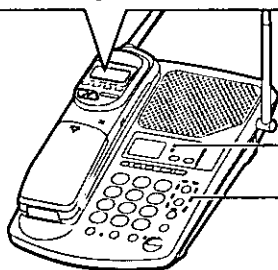

CALLER ID Indicator

Line Buttons

- When both lines are receiving calls, each caller's information will be displayed alternately.
- Caller information cannot be displayed in the following cases:
 - If the caller dialed from an area which does not provide a Caller ID service, the display will show "Out of area".
 - If the caller has requested not to display his/her information, the display will show "Private caller".

▶ Caller ID Service

- If your unit is connected to a PBX which does not support Caller ID services, you cannot access those services.
- The name display service may not be available in some areas. For further information, please contact your telephone company.

To check the number of new calls

When new calls have been received, the CALLER ID indicator flashes on the base unit.

While the handset is on the base unit:

If you have received 10 new calls, the display will show the following:

```
10 new calls
      {000}
```

CALLER ID Indicator

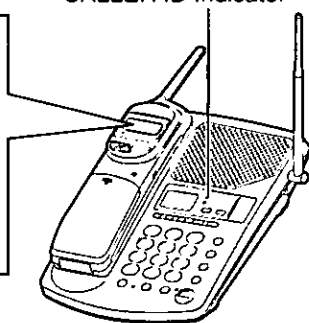

While the handset is off the base unit:

Press **SEARCH** or to turn the display on. If you have received 10 new calls, the display will show the following:

```
10 new calls
v=New      ^=Old
```

SEARCH ,

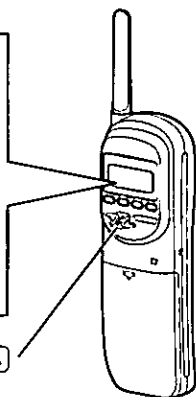





Viewing the Caller List

To check who has called, follow the steps below.

The TALK indicator light must be off and the base unit must be in the stand-by mode. Use the handset near the base unit.



- 1** Lift the handset off the base unit and press **SEARCH**  or  to enter the list.

- The display will show, for example, the following:

2 new calls	
v=New	^=Old

- 2** To search from the most recent call on both lines, press **SEARCH**  (New key).

To search from the oldest call on both lines, press **SEARCH**  (Old key).

- To scroll between callers, press **SEARCH**  or .

- 3** To exit the list, press **EXIT**.

- The handset will return to the stand-by mode.

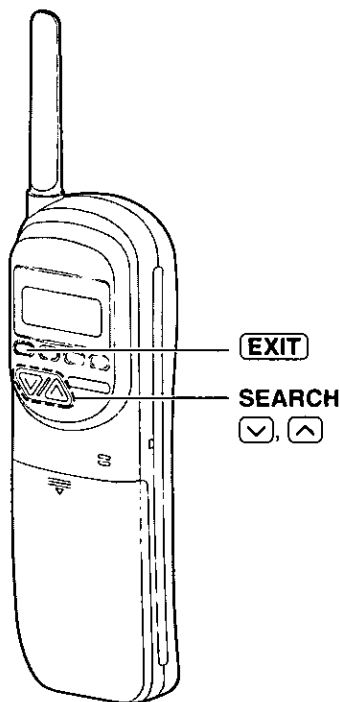

- Once new calls have been checked, "√" will be added.
- If "No items stored" is displayed in step 1, the Caller List is empty. Press **EXIT** to exit the list.
- If more than one call is received from the same caller, the date and time of the most recent call will be recorded. If the same caller calls again, the call entry with "√" will be deleted.

➔ Using the Caller List

Ex. When you search from the most recent call on both lines:

Lift the handset off the base unit and press **SEARCH** or .

2 new calls
v=New ^=Old
Press **SEARCH** .

JACK SMITH
111-2222 1
3:10P JUN10
Press **SEARCH** .

NANCY BROWN
222-3333 2
1:54P JUN 9 X2
Press **SEARCH** .

CINDY TURNER
1-234-456-7890 1
10:38A JUN 9 ✓
Press **SEARCH** .

0 new call
v=New ^=Old
Press **SEARCH** .

• If there is no name information for a caller, the display will only show the phone number.

To return to the previous caller, press **SEARCH** .

To exit the Caller List, press **EXIT**.

• The handset will return to the stand-by mode.

Display meaning:

- ✓ : You have checked this caller information, answered the call, called back the caller or played back the message.
- x2-x9 : The number of times the same caller called (up to 9). After checking, "x2"-"x9" will be replaced with "✓".
- 1, 2 : Indication of the called line.



Calling Back from the Caller List

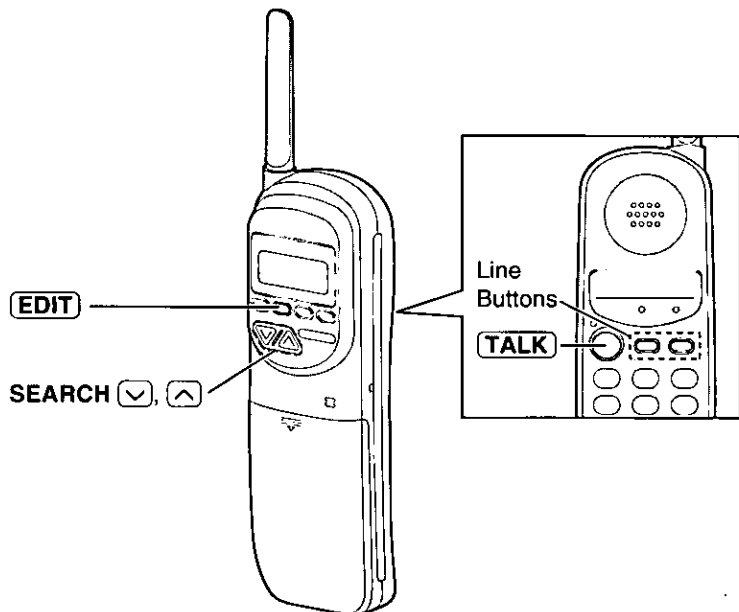

Cordless Telephone

- 1 Lift the handset off the base unit and press **SEARCH** (v) or (^) to enter the list.

3 new calls
v=New ^=Old

- 2 Press **SEARCH** (v) or (^) repeatedly to find the desired caller.

CINDY TURNER
1-234-456-7890 (v)
11:20A JAN12 X3

- 3 Press **TALK**.
- o The displayed phone number is dialed automatically.
 - o You can also press a line button instead of **TALK**.

Talk
12344567890
{000}

Talk
00-00-00 {000}

- o In some cases, you may have to edit the number before dialing (p. 42).
(Ex. You may have to add "1" for long distance calls.)
If you have not stored your area code (p. 20), the edited number will not be saved in the Caller List.
- o If a phone number is not displayed in the caller information, you cannot call back that caller.

➡ Using the Caller List

Editing the Caller's Phone Number

The unit can edit a phone number into one of 4 patterns.

The **TALK** indicator light must be off and the base unit must be in the stand-by mode. Use the handset near the base unit.

- 1 Lift the handset off the base unit and press **SEARCH** (✓) or (∧) to enter the list.

5 new calls
v=New ^=Old

- 2 Press **SEARCH** (✓) or (∧) repeatedly to find the desired caller.

FRED PARKER
321-5555 [1]
11:20A JAN12 ✓

- 3 Press **EDIT** to select a pattern. Each time you press **EDIT**, the number is rearranged into one of 4 different patterns.

- (a) 1 - [Phone no.]
(b) 1 - [Area code] - [Phone no.]
(c) [Area code] - [Phone no.]
(d) [Phone no.]

•The order in which patterns (a)–(d) are displayed depends on how the telephone number is displayed in step 2.

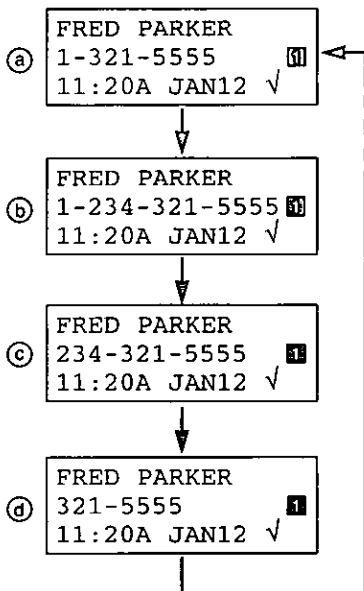

- 4 After editing the number, you can continue with calling back or storing procedures.

To call back, press **TALK** (p. 41).



To store the number in the Speed Dialer memory, press **AUTO**, then press a memory station number (0 to 9) (p. 43).



Storing Caller List Information in the Speed Dialer Memory

You can store numbers that are in the Caller List in the Speed Dialer memory.

The TALK indicator light must be off and the base unit must be in the stand-by mode. Use the handset near the base unit.

1 Lift the handset off the base unit and press **SEARCH**  or  to enter the list.

10 new calls
v=New ^=Old

2 Press **SEARCH**  or  repeatedly to find the caller you want to store in memory.

◦ If the number requires editing, see page 42.

CINDY TURNER
1-234-456-7890 
11:20A JAN12 X3

3 Press **AUTO**.

Save in AUTO
Select 0-9

4 Press a memory station number (**0** to **9**).

◦ A beep sounds.

◦ The display will return to step 2. You can continue storing other items. To return to the stand-by mode, press **EXIT** or wait for 60 seconds.

1-234-456-7890 
Save in AUTO 0

Cordless Telephone

- To cancel during programming, press **EXIT**. Start again from step 1.
- If 3 beeps sound and the display shows "Out of range", move closer to the base unit and try again. If "Out of range" is still displayed, place the handset on the base unit. Start again from step 1.
- You cannot store caller information in the Speed Dialer memory if a phone number is not displayed.

➔ Using the Caller List

Erasing Caller List Information

After checking the Caller List, you can erase some or all of the entries. The TALK indicator light must be off and the base unit must be in the stand-by mode. Use the handset near the base unit.

To erase a specific caller from the Caller List

- 1 Lift the handset off the base unit and press **SEARCH** (v) or (^) to enter the list.

10 new calls
v=New ^=Old

- 2 Press **SEARCH** (v) or (^) repeatedly to find the caller you want to erase from the Caller List.

TOM REAGAN
444-5555
12:20A JAN12 ✓

- 3 Press **CLEAR**.
- A beep sounds and the information is erased.
 - After a few seconds, the display will show the previous caller information.
 - To return to the stand-by mode, press **EXIT** or wait for 60 seconds.

Clear

To erase all entries in the Caller List

Before erasing all entries, make sure that "0 new call" is displayed.

- 1 Lift the handset off the base unit and press **SEARCH** (v) or (^) to enter the list.

0 new call
v=New ^=Old

- 2 Press **CLEAR**.

Press CLEAR for
all clear

- 3 Press **CLEAR** again.
- A beep sounds and all entries are erased.
 - The handset will return to the stand-by mode.

All clear

- If 3 beeps sound and the display shows "Out of range", move closer to the base unit and try again. If "Out of range" is still displayed, place the handset on the base unit. Start again from step 1.

Using the Other Line During a Conversation

While Someone Else is Using a Line (Simultaneous Base/Handset Calling)

The handset and base unit can be used at the same time on separate telephone lines.

To make a call with the handset

- 1** **EX: If the base unit is using LINE 1**
Press the other line button (LINE 2) on the handset.
 - The TALK and the LINE 2 indicators light.
- 2** Dial a telephone number.
- 3** To hang up, press **TALK** or place the handset on the base unit.

To answer a call with the handset

- 1** **EX: If the base unit is using LINE 1**
Press the other line button (LINE 2) on the handset.
- 2** To hang up, press **TALK** or place the handset on the base unit.

To make a call with the base unit

- 1** **EX: If the handset is using LINE 1**
Press the other line button (LINE 2) on the base unit.
 - The DIGITAL SP-PHONE indicator and the LINE 2 button light.
- 2** Dial a telephone number.
- 3** To hang up, press **DIGITAL SP-PHONE**.

To answer a call with the base unit

- 1** **EX: If the handset is using LINE 1**
Press the other line button (LINE 2) on the base unit.
- 2** To hang up, press **DIGITAL SP-PHONE**.

◦If another phone is connected on either line, you can also use it while the handset or base unit is using the other line.

► Using the Other Line During a Conversation

While You are Using a Line

During a conversation, if **two tones** sound and the other line indicator on the handset and the other line button on the base unit flash quickly, an incoming call is being received on that line. You can answer the second call while holding the first call. You can also make a call without terminating the first call. If you subscribe to a Caller ID service, the second caller's information will be displayed when a call is being received on the other line (p. 37).

You may delete the **two tones** (incoming call tone) by programming. See page 54.

With the handset

- 1** **EX: If you are using LINE 1**
Press **HOLD/INTERCOM** to put the first call (LINE 1) on hold.
 - The LINE 1 indicator flashes.
- 2** Press the other line button (LINE 2) to make or answer a second call.
 - The LINE 2 indicator lights.
- 3** To return to the first call (LINE 1), press the line button for the first call (LINE 1).
 - The second call is terminated.

•To hold the second call in step 3, press **LOCATOR/INTERCOM/HOLD** or **HOLD/INTERCOM** before pressing the line button for the first call.

With the base unit

- 1** **EX: If you are using LINE 1**
Press **LOCATOR/INTERCOM/HOLD** to put the first call (LINE 1) on hold.
 - The LINE 1 button flashes.
- 2** Press the other line button (LINE 2) to make or answer a second call.
 - The LINE 2 button lights.
- 3** To return to the first call (LINE 1), press the line button for the first call (LINE 1).
 - The second call is terminated.

Conference Call

While having a conversation on one line, you can make or answer a second call on the other line and then combine the calls to make a conference call.

With the handset

1 EX: If you are using LINE 1

Press **HOLD/INTERCOM** to put the first call (LINE 1) on hold.

- The LINE 1 indicator flashes.

2 Press the other line button (LINE 2) to make or answer a second call.

- The LINE 2 indicator lights.

3 When the second call is connected, press **CONF** to make a conference call.

- Both line indicators light.

With the base unit

1 EX: If you are using LINE 1

Press

LOCATOR/INTERCOM/HOLD

to put the first call (LINE 1) on hold.

- The LINE 1 button flashes.

2 Press the other line button (LINE 2) to make or answer a second call.

- The LINE 2 button lights.

3 When the second call is connected, press

RINGER/CONF to make a conference call.

- Both line buttons light.

Cordless Telephone

During a conference call using the handset:

- To hang up both lines, press **TALK**.
- To hang up only one line, press the line button for the party with which you want to continue talking.
- To put both lines on hold, press **HOLD/INTERCOM**.
To talk with only one caller, press the corresponding line button.
To resume both lines, press **CONF**.

During a conference call using the base unit:

- To hang up both lines, press **DIGITAL SP-PHONE**.
- To hang up only one line, press the line button for the party with which you want to continue talking.
- To put both lines on hold, press **LOCATOR/INTERCOM/HOLD**.
To talk with only one caller, press the corresponding line button.
To resume both lines, press **RINGER/CONF**.

Intercom

A 2-way intercom is possible between the handset and the base unit.

Paging the base unit from the handset

- 1 Handset:
Press **HOLD/INTERCOM**.
Talk to the paged party after the beeps.

- The TALK indicator flashes and "Intercom" is displayed.

- 2 Base unit:
When the other party's voice is heard, answer using the MIC.

- 3 Handset:
To end the intercom, press **HOLD/INTERCOM**.

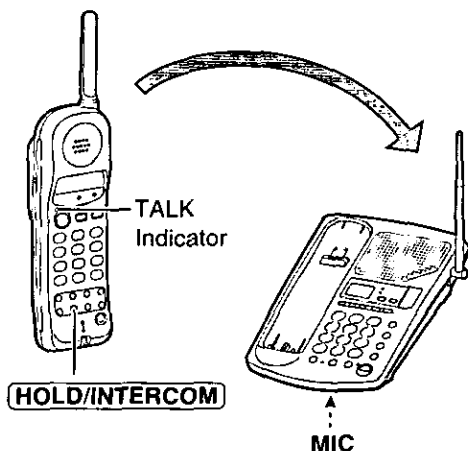

Paging the handset from the base unit (Handset locator)

Using this feature, you can locate a misplaced handset.

- 1 Base unit:
Press **LOCATOR/INTERCOM/HOLD**.
- The handset beeps for 1 minute and "Paging Press INTERCOM" is displayed.

- To stop paging, press **LOCATOR/INTERCOM/HOLD** again.

- 2 Handset:
Press **HOLD/INTERCOM** to answer.

- "Intercom" is displayed.

- 3 Base unit:
Talk into the MIC.

- 4 Handset:
To end the intercom, press **HOLD/INTERCOM**.

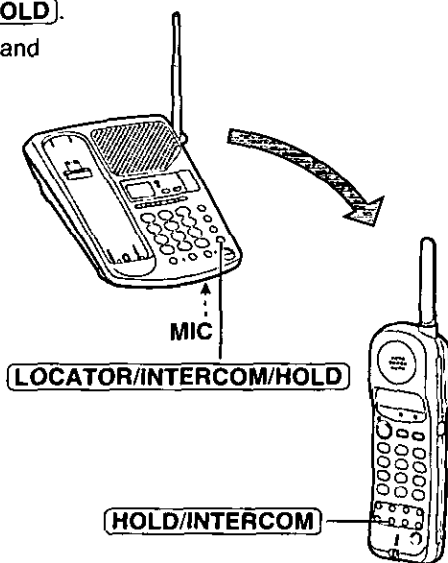

- You cannot page the handset while it is being used.

During an intercom call:

- Intercom calls can only be ended with the handset.
- If the handset user has difficulty hearing the base unit user, decrease the base unit speaker volume by pressing **VOLUME** .
- If an incoming call is received, the intercom call stops and the unit starts to ring. To answer, press **(TALK)**, **(DIGITAL SP-PHONE)** or the relevant line button.

Transferring a Call Using the Intercom

The intercom can be used during a call. This feature enables you to transfer a call between the handset and the base unit.

From the handset to the base unit

- 1** Handset:
During a call, press **(HOLD/INTERCOM)**.
 - The call is put on hold and "Hold" is displayed.
- 2** Handset:
Press **(HOLD/INTERCOM)** again. Talk to the paged party after the beeps.
 - "Intercom hold" is displayed.
 - If the base unit user does not answer, press the line button whose indicator is flashing.
- 3** Base unit:
When the paging party's voice is heard, answer using the **MIC**.
- 4** Base unit:
To answer the call, press the line button which is flashing.
 - The transfer is complete.

From the base unit to the handset

- 1** Base unit:
During a call, press **(LOCATOR/INTERCOM/HOLD)**.
 - The call is put on hold.
- 2** Base unit:
Press **(LOCATOR/INTERCOM/HOLD)** again. Talk to the paged party after the beeps.
 - "Paging Press INTERCOM" is displayed on the handset.
 - If the handset user does not answer, press the line button which is flashing.
- 3** Handset:
Press **(HOLD/INTERCOM)** to answer the page.
 - "Intercom hold" is displayed.
- 4** Handset:
To answer the call, press the line button whose indicator is flashing.
 - The transfer is complete.

Special Features

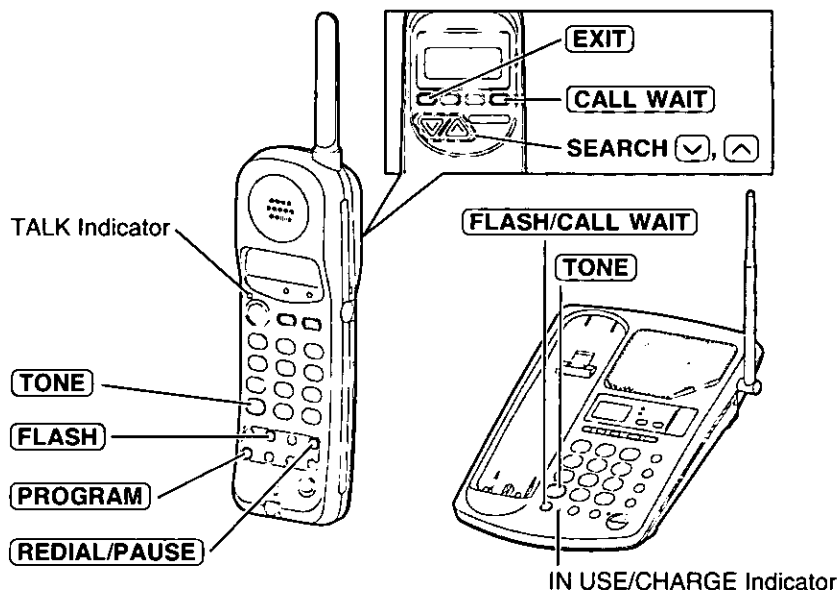

For Call Waiting Service Users

Press **FLASH/CALL WAIT** or **CALL WAIT** if you hear a call-waiting tone while talking.

- The first call is put on hold and you can answer the second call.
- To return to the first caller, press **FLASH/CALL WAIT** or **CALL WAIT** again.
- You can press **FLASH** instead of **CALL WAIT** on the handset.
- The call waiting service cannot be used when:
 - you are having a conference call (p. 47), or
 - the answering system is recording someone's message, or
 - a parallel connected telephone is in use.
- If this function does not operate properly, consult your telephone company for details.

Visual Call Waiting (Call Waiting ID) Service

Visual Call Waiting (Call Waiting ID) Service allows your handset to display a second caller's information. After you hear a call-waiting tone while talking, the handset will display the caller's name with the phone number and "----Waiting----".

NANCY BROWN 1-000-222-3333 ----Waiting----
--

- The second caller's information will not be displayed when you are having a conversation using the base unit while the handset is off the base unit.
- Please contact your telephone company for details and availability in your area.



Automatic Security Code Setting

Each time you place the handset on the base unit, the unit automatically selects one of more than a million security codes. These codes help prevent the unauthorized use of your telephone line by another cordless telephone user.

Temporary Tone Dialing (For Rotary or Pulse Service Users)

Press **TONE** before entering access numbers which require tone dialing.

- The dialing mode changes to tone. You can enter numbers to access an answering service, electronic banking service, etc. When you hang up, the mode will return to pulse.
- Access numbers entered after pressing **TONE** will not be included when redialing.

How to Use the PAUSE Button (For Analog PBX Line/Long Distance Service Users)

We recommend you press **REDIAL/PAUSE** if a pause is required for dialing with a PBX or to access a long distance service.

Ex. Line access number **9** (PBX)

9 ⇒ **REDIAL/PAUSE** ⇒ Phone number

- Pressing **REDIAL/PAUSE** once creates a 3.5 second pause. This prevents misdialing when you redial or dial a stored number.
- Pressing **REDIAL/PAUSE** more than once increases the length of the pause between numbers.

➤ Special Features

FLASH Button

Pressing **FLASH/CALL WAIT** or **FLASH** allows you to use special features of your host PBX such as transferring an extension call or accessing special telephone services (optional) such as call waiting. You can press **CALL WAIT** instead of **FLASH** on the handset.

Selecting the flash time

The flash time depends on your telephone exchange or host PBX. You can select the following flash times: "700, 600, 400, 300, 250, 110, 100, or 90 ms (milliseconds)", **using the handset near the base unit**. Your phone comes from the factory set to "700 ms".

The TALK indicator light must be off and the base unit must be in the stand-by mode before programming.

- 1 Press **PROGRAM**.
•The TALK indicator flashes.

Save AUTO# ?
v=Next ^=Yes

- 2 Press **SEARCH** (Next key) repeatedly until "Set flash time?" is displayed.

Set flash time?
v=Next ^=Yes

- 3 Press **SEARCH** (Yes key).

Set flash time
v=Line1 ^=Line2

- 4 Press **SEARCH** (Line1) or **SEARCH** (Line2) to select the desired line.

Flash time
: 700ms
v=Next ^=Save

- 5 Press **SEARCH** (Next key) repeatedly until the desired time is displayed.

- 6 Press **SEARCH** (Save key).
•A beep sounds.

•The display will return to the stand-by mode. To program the other line, start again from step 1.

- To cancel during programming, press **EXIT** or **PROGRAM**. Start again from step 1.
- If 3 beeps sound and the display shows "Out of range", move closer to the base unit and try again. If "Out of range" is still displayed, place the handset on the base unit. Start again from step 1.
- If you are connected via a PBX, a longer flash time may be necessary to use PBX functions (transferring a call, etc.). Consult your PBX installer for the correct setting.



Line Selection

The unit will automatically select a free line which is not being used by a parallel connected telephone when you make a call. The unit will select the called line when you answer a call. To change the line selection, program as follows.

The TALK indicator light must be off and the base unit must be in the stand-by mode before programming. Use the handset near the base unit.

- 1 Press **PROGRAM**.
- The TALK indicator flashes.

Save AUTO# ?
v=Next ^=Yes

- 2 Press **SEARCH** (Next key) repeatedly until "Line selection?" is displayed.

Line selection?
v=Next ^=Yes

- 3 Press **SEARCH** (Yes key).
- The current selection is displayed.

Line selection
:Auto
v=Next ^=Save

Line1: Line 1 will be selected.

Line2: Line 2 will be selected.

Auto: A free line will be selected (LINE 1 has priority) when making a call. The called line is automatically selected when answering a call (factory preset).

- 4 Press **SEARCH** (Next key) repeatedly until the desired line selection is displayed.

Line selection
:Line2
v=Next ^=Save

- 5 Press **SEARCH** (Save key).

- A beep sounds.

- The display will return to the stand-by mode.

Line selection
:Line2

- To cancel during programming, press **EXIT** or **PROGRAM**. Start again from step 1.

- If 3 beeps sound and the display shows "Out of range", move closer to the base unit and try again. If "Out of range" is still displayed, place the handset on the base unit. Start again from step 1.

- Any line can be selected manually, regardless of the mode selected in step 4, by pressing the line button.

Cordless Telephone

► Special Features

Incoming Call Tone

While one line is being used, you can be informed if another call arrives on the other line by two tones. This incoming call tone can be set/deleted by programming. Your phone comes from the factory set to "On".

The TALK indicator light must be off and the base unit must be in the stand-by mode before programming. Use the handset near the base unit.

- 1 Press **PROGRAM**.
◦The TALK indicator flashes.

```
Save AUTO# ?
v=Next    ^=Yes
```

- 2 Press **SEARCH** (Next key) repeatedly until "Incoming call.?" is displayed.

```
Incoming call.?
v=Next    ^=Yes
```

- 3 Press **SEARCH** (Yes key).
◦The current setting is displayed.
On: The incoming call tone will be heard for as long as the other line rings (factory preset).
2: The incoming call tone will only be heard 2 times.
Off: The incoming call tone will not be heard.

```
Incoming call
           tone:On
v=Next    ^=Save
```

- 4 Press **SEARCH** (Next key) repeatedly until the desired setting is displayed.

```
Incoming call
           tone:2
v=Next    ^=Save
```

- 5 Press **SEARCH** (Save key).
◦A beep sounds.
◦The display will return to the stand-by mode.

```
Incoming call
           tone:2
```

- To cancel during programming, press **EXIT** or **PROGRAM**. Start again from step 1.
- If 3 beeps sound and the display shows "Out of range", move closer to the base unit and try again. If "Out of range" is still displayed, place the handset on the base unit. Start again from step 1.

Line Indicator

If you use the unit as a single-line telephone, the indicator light on the handset and the button light on the base unit of the line which is not connected will continue to flash. To turn the lights off, set to OFF. Both line indicators and buttons are preset to ON.

The TALK indicator light must be off and the base unit must be in the stand-by mode before programming. Use the handset near the base unit.

- 1 Press **PROGRAM**.
◦The TALK indicator flashes.
- 2 Press **SEARCH** (Next key) repeatedly until "Line indicator?" is displayed.
- 3 Press **SEARCH** (Yes key).
- 4 Press **SEARCH** (Line1) or **SEARCH** (Line2) to select the desired line.
- 5 To select OFF, press **SEARCH** .
OR
To select ON, press **SEARCH** .
◦A beep sounds.
◦The display will return to the stand-by mode.

Save AUTO# ?
v=Next ^=Yes

Line indicator?
v=Next ^=Yes

Line indicator
v=Line1 ^=Line2

Line indicator
v=On ^=Off

Line indicator
Off

Line indicator
On

- To cancel during programming, press **EXIT** or **PROGRAM**. Start again from step 1.
- If 3 beeps sound and the display shows "Out of range", move closer to the base unit and try again. If "Out of range" is still displayed, place the handset on the base unit. Start again from step 1.

Automatic Answering Operation

When the unit answers a call, a greeting message is played and the caller's message is recorded. You cannot operate the answering system while using the handset for programming.

- The total recording time (including greeting message) is **about 15 minutes**. If messages are recorded in noisy rooms, the time may be shortened by up to 3 minutes.
- A maximum of 64 messages (including greeting message) can be recorded.

Setting the Unit to Answer Calls

- 1 a) To turn on the answering system **on both lines**, press **LINE SELECT** repeatedly until "**LINE1 LINE2**" is displayed.
b) To turn on the answering system **on either line**, press **LINE SELECT** repeatedly until "**LINE1**" or "**LINE2**" is displayed.
- 2 Press **ANSWER ON** to turn on the answering system.

- The indicator lights.
- "Answer set" and the selected line(s) will be announced.

- If another button is pressed between steps 1 and 2, the selected line(s) may not be turned on.
- The unit will announce the remaining recording time if it is less than 5 minutes.
- If you hear "Memory full", "**FULL**" is displayed on the base unit and the **ANSWER ON** indicator flashes rapidly, erase some, or all, of the messages (p. 60).
- You can also turn on the answering system remotely using any other phone (p. 72).

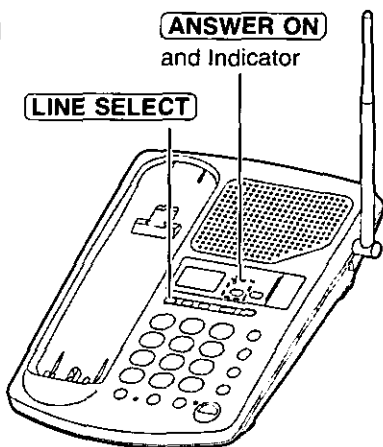

To turn off the answering system

Press **ANSWER ON**.

- The indicator light goes out and "Answer off" is heard.
- To turn off the answering system on either line when **both lines** are turned on, press **LINE SELECT** repeatedly until the line which you want to leave on is displayed, and press **ANSWER ON**.

Monitoring incoming calls

While a call is being recorded, you can monitor it through the speaker. To answer the call with the speakerphone, press the line button which is flashing on the base unit. For the handset, press the line button whose indicator is flashing twice every 2 seconds. The unit stops recording.

Listening to Messages



You can see the total number of recorded messages on the base unit display. If the ANSWER ON indicator flashes, new messages have been recorded.

Listening to only new messages

Press **NEW MESSAGE** briefly.

- The unit announces the number of new messages on the line(s) for which the answering system is on and plays them back.
- To listen to new messages on either or both line(s), press **LINE SELECT** repeatedly to select the desired line(s), then press **NEW MESSAGE** briefly.

Listening to all recorded messages

Press and hold **NEW MESSAGE** until playback starts.

- The unit announces the number of all recorded messages on the line(s) for which the answering system is on and plays them back.
- To listen to all recorded messages on either or both line(s), press **LINE SELECT** repeatedly to select the desired line(s), then press and hold **NEW MESSAGE** until playback starts.

At the end of the last message, "End of final message" is heard. The unit will announce the remaining recording time if it is less than 5 minutes.

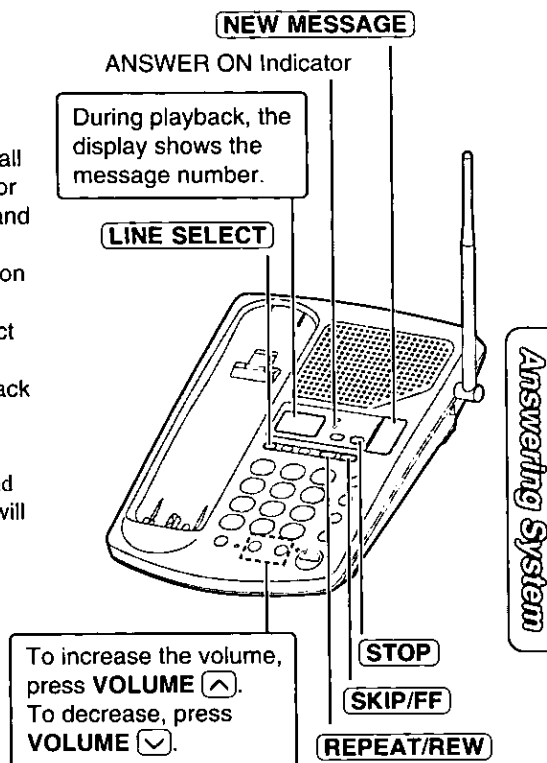

When the answering system for both lines is turned on:

- The messages are played back in chronological order.
- The corresponding line display will flash when a message on that line is being played.

► Listening to Messages

During playback

To repeat/
rewind
message

To repeat from the beginning of the message

Press **(REPEAT/REW)** briefly.

- If you press within 5 seconds of playback, the previous message will be played.

To rewind part of the message

Press and hold **(REPEAT/REW)** until you reach the desired place.

- At the beginning of the message, 3 beeps will sound.
-

To skip/cue
message

To skip to the next message

Press **(SKIP/FF)** briefly.

To cue to part of the message

Press and hold **(SKIP/FF)** until you reach the desired place.

- The message will be heard at twice the normal speed.
 - At the end of the message, 3 beeps will sound.
-

To stop
operation

Press **(STOP)**.

- To resume playback, press **(NEW MESSAGE)**.
 - If you do not press any button for 60 seconds or if you press **(STOP)** again, the unit will return to the stand-by mode.
-

For Caller ID service users (p. 37)

- During playback, when the handset is on the base unit, the handset display will show the name and/or number of the caller whose message is being played.

To call back the displayed number:

1. During playback, lift the handset.
2. Press **(TALK)** within 10 seconds.

—The unit stops playback and automatically dials the displayed phone number.

- After listening to new incoming messages, “✓” will be added to the call entries in the Caller List (p. 40).

From the Handset

If someone else is in the room and you want to listen to the recorded messages privately, you can use the handset.

- 1** Handset:
Press **PLAYBACK**.
- The number of new messages on the line(s) for which the answering system is on is heard on the handset.

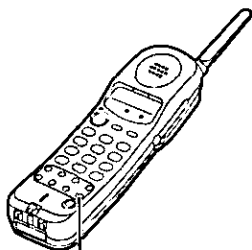

- 2** Base unit:
To listen to new messages, press **NEW MESSAGE** briefly.
To listen to all messages, press and hold **NEW MESSAGE** until playback starts.
- The messages will be heard on the handset.
 - **REPEAT/REW**, **SKIP/FF** and **STOP** can also be used during playback (p. 58).



- 3** When finished, press **PLAYBACK** or place the handset on the base unit.



◦ You can also listen to messages without using the base unit. See page 73.

Erasing Messages

The unit will announce the remaining recording time after playback, if it is less than 5 minutes. New messages cannot be recorded when:

- “Memory full” is heard.
- “**FULL**” is displayed on the base unit.
- the ANSWER ON indicator flashes rapidly.

Erase some, or all, of the messages. We recommend you erase unnecessary messages after each playback.

Erasing a specific message

Press **ERASE** while the message you want to erase is being played.

- The unit erases the message.
- A short beep will sound and the unit will continue to play the next message.

Erasing all messages

All recorded messages, except the greeting message(s), can be erased at one time.

- 1 a) To erase all messages **on both lines**, press **LINE SELECT** repeatedly until “**LINE1 LINE2**” is displayed.
b) To erase all messages **on either line**, press **LINE SELECT** repeatedly until “**LINE1**” or “**LINE2**” is displayed.

- 2 Press **ERASE**.
 - “Press ERASE again to erase all messages” is heard.

- 3 Within 5 seconds, press **ERASE** again.
 - A beep sounds, and the selected line and “No messages” are heard. The base unit display shows “0”.

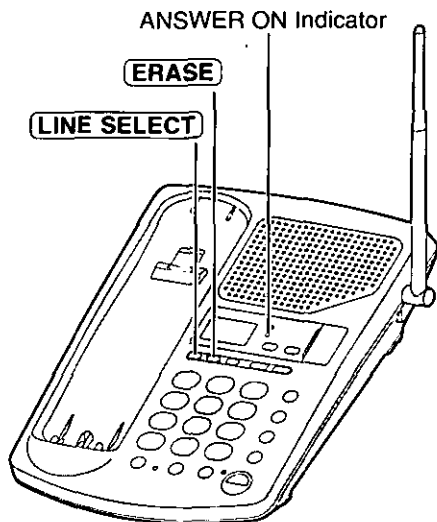

- The information in the Caller List will not be erased. To erase Caller List information, see page 44.

Pager Call



This feature allows you to alert your pager when the unit records an incoming message or receives a Caller ID call (p. 64). You can retrieve the message from a touch tone telephone (p. 66). If you subscribe to a Caller ID service, the caller's telephone number will be displayed on your pager. First program the following settings (p. 61–64), then set the unit to call the pager.

The TALK indicator light must be off and the base unit must be in the stand-by mode before programming. Use the handset near the base unit.

Storing a Pager Number

If you use a 1-800 pager number, see the next page for the storing procedure.

- 1 Press **PROGRAM**.
◦The TALK indicator flashes.
- 2 Press **PLAYBACK**.
◦“P” is displayed on the base unit.
- 3 Press **#**.
◦“-” is displayed on the base unit.
- 4 Enter your pager number, and press **REDIAL/PAUSE** twice.* Enter the access code, if required by your pager company, and press **REDIAL/PAUSE** twice again.*
◦The entered number is displayed on the base unit.
◦You can enter a total of 44 digits.
- 5 Press **PROGRAM**.
◦A beep sounds.

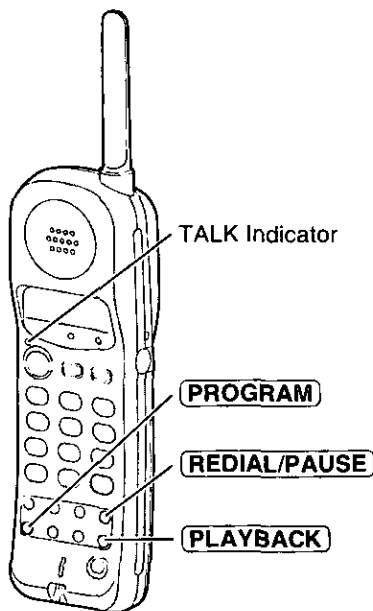

Answering System

* Pager companies require a delay after the pager number and/or the access code is dialed. Contact your pager company regarding the required pause time. Pressing **REDIAL/PAUSE** once creates a 3.5 second delay and counts as one digit.

- To cancel during programming, press **PROGRAM**. Start again from step 1.
- If the line(s) has (have) rotary or pulse service, press **TONE** between the pager number and **REDIAL/PAUSE** in step 4.

► Pager Call

Storing a 1-800 pager number

If you use a 1-800 pager number with a PIN code, store the pager number as follows.

- 1 Press **PROGRAM**.
 - The TALK indicator flashes.
- 2 Press **PLAYBACK**.
 - “P” is displayed on the base unit.
- 3 Press **#**.
 - “_” is displayed on the base unit.
- 4
 - ① Enter the 1-800 pager number, and press **REDIAL/PAUSE** 3 times.*
 - ② Enter the PIN code, and press **REDIAL/PAUSE** twice.*
 - The entered number is displayed on the base unit.
 - You can enter a total of 44 digits.
- 5 Press **PROGRAM**.
 - A beep sounds.

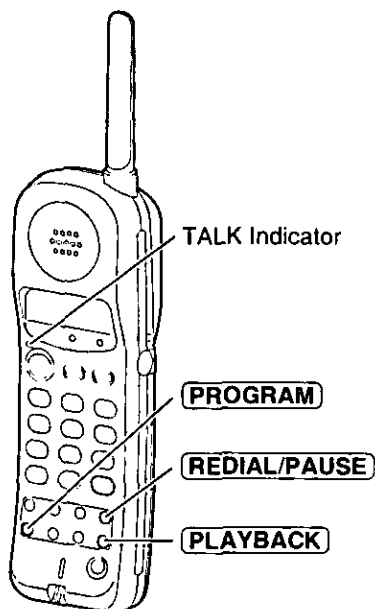

* Pager companies require a delay after the pager number and the PIN code are dialed. Contact your pager company regarding the required pause time. Pressing **REDIAL/PAUSE** once creates a 3.5 second delay and counts as one digit.

- To cancel during programming, press **PROGRAM**. Start again from step 1.
- If the line(s) has (have) rotary or pulse service, press **TONE** between the pager number and **REDIAL/PAUSE** in step 4.
- Alphanumeric voice dispatch pager services will not work with this function.



Storing Your Home Telephone Number

After storing your home telephone number, it will then be displayed on your pager when your family wants you to call home. (See useful information below.)

- 1 Press **PROGRAM**.
 - The TALK indicator flashes.
- 2 Press **PLAYBACK**.
 - “P” is displayed on the base unit.
- 3 Press **7**.
 - “-” is displayed on the base unit.
- 4 Enter your home telephone number up to 10 digits.
 - The entered number is displayed on the base unit.
- 5 Press **PROGRAM**.
 - A beep sounds.

- To cancel during programming, press **PROGRAM**. Start again from step 1.
- Your pager will also display your home number if the unit receives a call from an area which does not provide the Caller ID service or the caller requests not to show their information. Please call home to check who alerted your pager.

To confirm the stored pager and home numbers

1. Press **PROGRAM**.
2. Press **SEARCH** (✓) (Next key) repeatedly until “Calling pager ?” is displayed.
3. Press **SEARCH** (∧) (Yes key) .

Calling pager ?

v=Next ^=Yes

- The unit dials the stored pager number.
- The pager beeps, and displays your home number and “11”.
- If the pager does not beep or does not display your home number and “11”, store the pager and home numbers again (p. 61–63).

Useful Information

- Your family can let you know when they want you to call home by repeating the confirming procedure above.

* What “11” means

When your unit alerts your pager, “11” will be displayed after the caller’s telephone number. “11” will not be displayed when another phone alerts your pager.

Ex. When the unit records a caller’s message whose number is “2345678”:
“234567811” will be displayed on your pager. If you select pager mode “2” (p. 64) and a caller does not leave a message, “00” will be displayed instead of “11”.

Ex. When the caller whose number is “2345678” alerts your pager directly:
“2345678” will be displayed on your pager.

⇒ Pager Call

To erase the stored pager number

Press **PROGRAM** ⇒ **PLAYBACK** ⇒ **#** ⇒ **PROGRAM**.

◦The pager call mode will automatically return to OFF (p. 65).

To erase the stored home telephone number

Press **PROGRAM** ⇒ **PLAYBACK** ⇒ **7** ⇒ **PROGRAM**.

Pager Mode Setting

After subscribing to a Caller ID service (p. 37), you can select one of the following pager mode settings. The unit will alert your pager:

1. After the unit records an incoming message (factory preset),
OR
2. Each time the unit receives a Caller ID call, even if the caller does not leave a message.

If you want to change the mode, proceed as follows.

- 1 Press **PROGRAM**.
◦The TALK indicator flashes.
- 2 Press **PLAYBACK**.
◦“P” is displayed on the base unit.
- 3 Press **6**.
◦The current setting is displayed on the base unit.
- 4 To select “2”, press **2**.
OR
To select “1”, press **1**.
◦The entered number is displayed on the base unit.
- 5 Press **PROGRAM**.
◦A beep sounds.

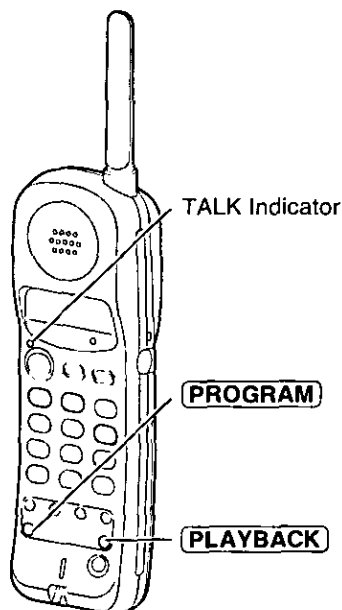

- To cancel during programming, press **PROGRAM**. Start again from step 1.
- If you select “2” and set the unit to call your pager (p. 65), the unit will alert your pager even if the answering system is not turned on.
- Even if you select “2”, the unit will not alert your pager when a Caller ID call which does not have a phone number is received.

Setting the Unit to Call a Pager

- 1 Press **PLAYBACK**.
 - The number of new messages on the line(s) you set to record is heard on the handset.
- 2 Press **3**.
 - “**PAGER**” is displayed on the base unit.
 - If “**PAGER**” is not displayed, the pager number has not been stored. Store the number (p. 61, 62), and try again.
- 3 Press **PLAYBACK**.

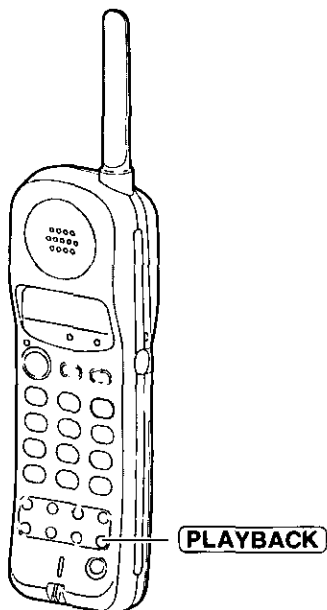

To turn off the pager call mode, repeat steps 1 through 3.

- “**PAGER**” will disappear.
- Each time you press **3** in step 2, the mode will turn on or off.

If you have not subscribed to a Caller ID service, the caller's telephone number will not be displayed on your pager.

- If another message (or Caller ID call) is received before the unit alerts your pager for a previous message (or Caller ID call), the previous caller information will not be sent to your pager. Only the last call received will be sent to your pager.
- If someone else makes or answers another call with the unit or a parallel connected phone before the unit alerts your pager for a previous message (or Caller ID call), the unit will stop alerting your pager for that message (or Caller ID call).
- If you receive a telephone number on your pager but cannot recognize the caller, you may have received a direct inward dial (DiD) call, such as from a PBX. Please call your unit to check the caller's message.

Remote Operation from a Touch Tone Phone

You can operate the answering system from any touch tone phone.

A synthesized voice menu will guide you on how to operate the unit (p. 68).

- To skip the voice menu and operate the unit directly, see page 70.

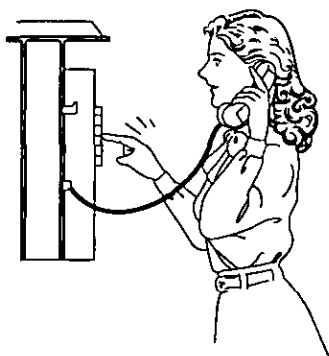

Summary of remote operation

Call your unit from a touch tone phone.



Enter your remote code (p. 67) during or after the greeting message.

- The unit announces the line(s) for which the answering system is on and the number of new messages on the line(s).



After 3 seconds, the voice menu will start. Follow the voice menu (p. 68).

- You can only use the line(s) for which the answering system is already on.

Enter the direct remote operation (p. 70).

- You can control the unit by direct commands (p. 70–72).
- The direct remote operation is available even when the voice menu has started.
- You can also choose the line(s) that you want to operate (p. 70).

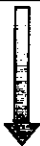

To end remote operation, hang up.

- The messages are saved.

- The unit will announce the remaining recording time after playback, if it is less than 5 minutes.



Setting the Remote Code

The remote code prevents unauthorized people from accessing your unit and listening to your messages. Choose any **2-digit number (00–99)**.

The factory preset remote code is "11". If you do not program your own remote code, you can use "11".

The TALK indicator light must be off and the base unit must be in the stand-by mode before programming. Use the handset near the base unit.

- 1** Press **PROGRAM**.
 - The TALK indicator flashes.
- 2** Press **PLAYBACK**.
 - "P" is displayed on the base unit.
- 3** Press **1**.
 - The current remote code is displayed on the base unit.
- 4** Enter a remote code using a **2-digit number (00–99)**.
 - The entered number is displayed on the base unit.
- 5** Press **PROGRAM**.
 - A beep sounds.

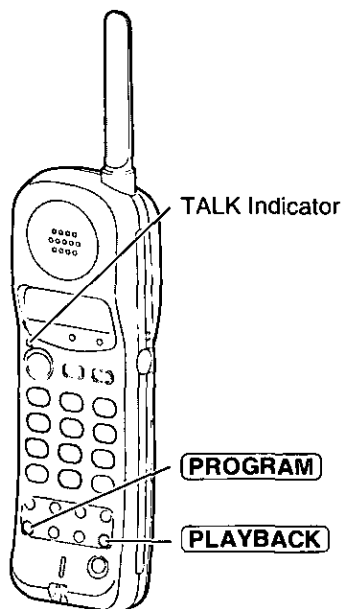

- To cancel during programming, press **PROGRAM**. Start again from step 1.
- If 6 beeps sound during programming, a wrong key was pressed. Enter the correct number.

To check the remote code

Press **PROGRAM** ⇒ **PLAYBACK** ⇒ **1**.

- The current remote code is displayed on the base unit. When finished, press **PROGRAM**.

➔ Remote Operation from a Touch Tone Phone

Voice Menu

You can operate the answering system only for the line(s) you set to record by following the voice menu. The shaded boxes are voice prompts.

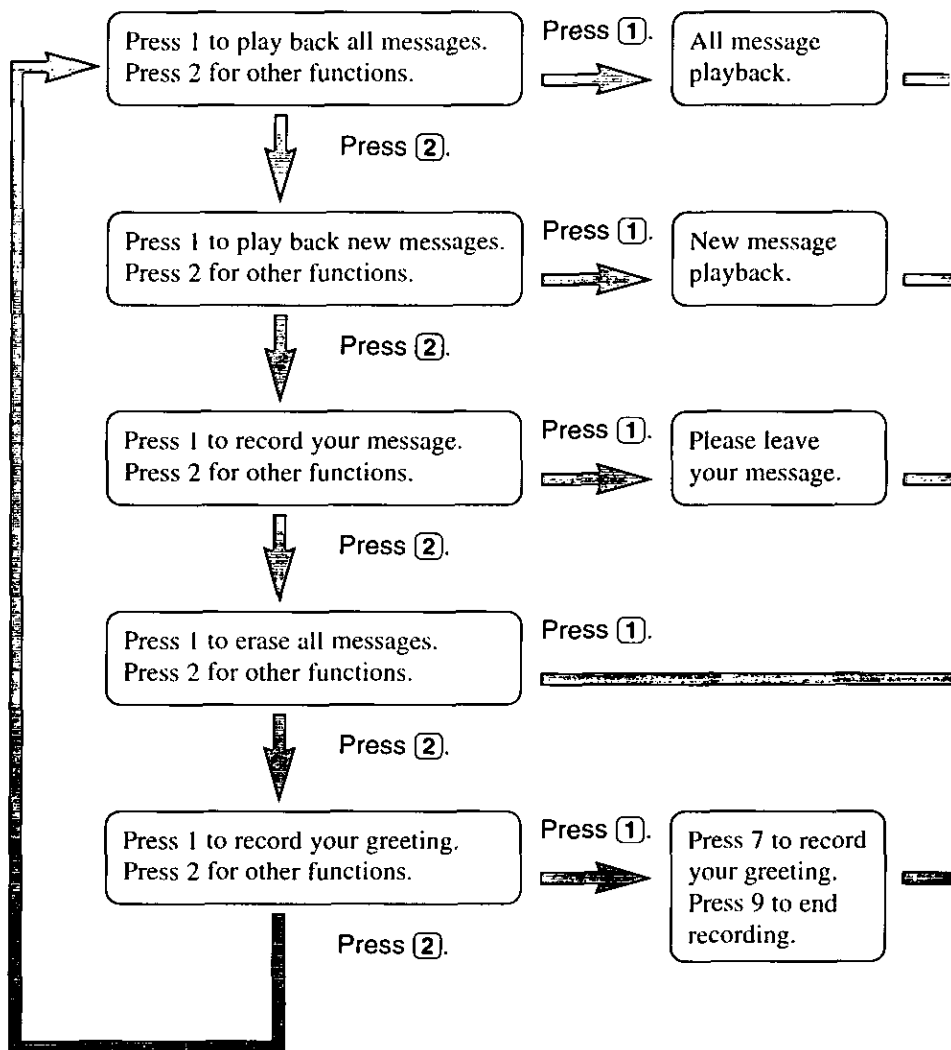



All Message Playback

All recorded messages on the line(s) you set to record are played back in chronological order. At the end of the last message, "End of final message" is heard. The unit will announce the remaining recording time if it is less than 5 minutes.

New Message Playback

Only new messages on the line(s) you set to record are played back in chronological order. At the end of the last message, "End of final message" is heard. The unit will announce the remaining recording time if it is less than 5 minutes.

Recording a Memo Message

You can leave a personal message.

1. Talk after you hear "Please leave your message".
2. When you finish recording, hang up.

Erasing All Messages

All recorded messages on the line(s) you set to record (except greeting message) are erased.

Recording a Greeting Message

You can re-record your greeting message on the line(s) for which the answering system is already on.

1. Press **7**.
You will hear a voice prompt followed by a long beep.
2. After the beep, talk for up to 2 minutes.
3. When you finish recording, press **9**.
4. Your greeting will be played back for confirmation.

- 3 seconds after playback, the voice menu will start again from the beginning.
- If you hear "Memory full" after playback, erase some, or all, of the messages (p. 71).

► Remote Operation from a Touch Tone Phone

Direct Remote Operation

Once you have entered the remote code, you can also control your unit by direct commands instead of using the voice menu. To end the remote operation, hang up anytime.

Summary of direct remote operation

- 1 Select the desired line(s) after entering your remote code.
To use the line(s) for which the answering system is already on, go to step 2.
Press **# 1** to select "LINE 1".
Press **# 2** to select "LINE 2".
Press **# 0** to select "LINE 1 and LINE 2".
◦The number of new messages on the selected line(s) is heard.



- 2 Enter the desired direct commands (p. 70–72).
◦If you do not enter any commands, the voice menu will start (p. 68).
You can also follow the voice menu to operate the answering system for the line(s) selected in step 1.
◦If you want to operate another line, repeat from step 1.



- 3 To end remote operation, hang up.
◦The messages are saved.
◦The line(s) that can be answered by the answering system will not change even if you select another line in step 1. To turn on the answering system for another line, see page 72.

- Do not press **#** for a few seconds. Some long distance services use **#** for other purposes and these services may take priority over the remote operation.

Direct commands

- | | | |
|-------------------------|----------|--|
| NEW MESSAGE
PLAYBACK | 4 | ◦Only new messages on the selected line(s) are played back in chronological order. |
| ALL MESSAGE
PLAYBACK | 5 | ◦All messages on the selected line(s) are played back in chronological order. |
-



REPEAT (During playback)	1	◦The current message is repeated.
SKIP (During playback)	2	◦The current message is skipped. The next message is played.
STOP	9	◦Operation is stopped temporarily. ◦To resume operation, enter a direct command within 15 seconds, or the voice menu will start:
GREETING MESSAGE RECORDING	You can re-record your greeting message for the selected line(s).	
	7	◦A long beep sounds.
	↓	
	RECORD	◦After the beep, talk immediately for up to 2 minutes.
	↓	
	9	◦The recording is stopped. ◦The recorded message is played.
ERASING A SPECIFIC MESSAGE (During playback)	* 4	◦The current message is erased. ◦A short beep will sound and the next message will be played.
ERASING ALL MESSAGES	* 5	◦All recorded messages on the selected line(s) are erased. ◦A long beep sounds and "Line 1, no messages" and/or "Line 2, no messages" is/are heard.
PAGER CALL ON/OFF	3	◦Each time you press 3 , "On/Off" is heard and the mode will turn on or off. ◦If you have not stored a pager number, 6 beeps will sound and the mode will not turn on.

➤ Remote Operation from a Touch Tone Phone

ANSWERING
SYSTEM OFF

0

- "Answer off" is heard.
 - The answering system for the selected line(s) is turned off.
 - The voice menu will start. To end the remote operation, hang up. To operate the other line or both lines, select the required line(s) (see below), and enter the desired direct commands.
-

SELECTING
ANOTHER
LINE

1

- LINE 1 is selected and the number of new messages on LINE 1 is heard.

2

- LINE 2 is selected and the number of new messages on LINE 2 is heard.

0

- LINE 1 and LINE 2 are selected and the number of new messages on both lines is heard.
-

ANSWERING
SYSTEM ON
FOR EACH
LINE

1 8

- "Answer set line 1" is heard and the LINE 1 answering system is turned on.

2 8

- "Answer set line 2" is heard and the LINE 2 answering system is turned on.

0 8

- "Answer set line 1 and line 2" is heard and the answering system for both lines is turned on.

◦ If the LINE 1 (LINE 2) answering system is on and you also want to turn on the LINE 2 (LINE 1) answering system, press **# 0 8**.

Turning on the answering system

Call your unit and wait for 15 rings.

- The unit will answer and the greeting message will be played.
- The answering system will turn on. Hang up or enter the remote code for other options.
- When turning on the answering system using a rotary or pulse service telephone, you cannot enter the remote code for other options.

Skipping the greeting message

After calling your unit, press ***** during the greeting message.

- The unit skips the rest of the greeting message and you can start recording your message after the long beep.

Remote Operation with the Handset ⇨

You can operate your answering system with the handset. The announcements and recorded messages can only be heard with the handset.

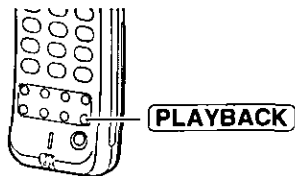

Summary of remote operation

Press **PLAYBACK**.

- The unit announces the line(s) for which the answering system is on and the number of new messages on the line(s).
- "Remote operation" is displayed on the handset.



1. Select the desired line(s). To use the line(s) for which the answering system is already on, go to step 2.

Press **# 1** to select "LINE 1".

Press **# 2** to select "LINE 2".

Press **# 0** to select "LINE 1 and LINE 2".

- The number of new messages on the selected line(s) is heard.

2. Enter the desired direct commands (p. 74, 75).

- If you want to operate another line, repeat from step 1.

◦ If you do not enter a command, the voice menu will start (see next page).

◦ After the voice menu, all message playback on the selected line(s) will start.



To end remote operation, press **PLAYBACK**.

◦ The messages are saved.

◦ The line(s) that can be answered by the answering system will not change even if you select another line in step 1. To turn on the answering system for another line, see page 75.

◦ The unit will announce the remaining recording time after playback, if it is less than 5 minutes.

◦ If you hear "Memory full" after playback, erase some, or all, of the messages (p. 74).

➡ Remote Operation with the Handset

Voice menu

If no commands are entered after you press **PLAYBACK**, the unit will start the following voice menu.

"Press 4 to play back new messages. Press 5 to play back all messages."

- You can operate the answering system for the selected line(s) by following the voice menu.
- You can enter direct commands even if the voice menu has started.

Direct commands

NEW MESSAGE
PLAYBACK

4

- Only new messages on the selected line(s) are played back in chronological order.
-

ALL MESSAGE
PLAYBACK

5

- All messages on the selected line(s) are played back in chronological order.
-

REPEAT
(During playback)

1

- The current message is repeated.
-

SKIP
(During playback)

2

- The current message is skipped.
The next message is played.
-

STOP

9

- Operation is stopped temporarily.
 - To resume operation, enter a direct command within 15 seconds, or the above voice menu will start.
-

ERASING A
SPECIFIC
MESSAGE
(During playback)

*** 4**

- The current message is erased.
 - A short beep will sound and the next message will be played.
-

ERASING ALL
MESSAGES

*** 5**

- All recorded messages on the selected line(s) are erased.
 - A long beep sounds and "Line 1, no messages" and/or "Line 2, no messages" is/are heard.
-

PAGER CALL
ON/OFF

3

- Each time you press **3**, the mode will turn on or off.
 - If you have not stored a pager number, "**PAGER**" will not be displayed on the base unit, and the mode will not turn on.
-

ANSWERING
SYSTEM ON

8

- The answering system for the selected line(s) is turned on.

ANSWERING
SYSTEM OFF

0

- “Answer off” is heard.
- The answering system for the selected line(s) is turned off.
- The voice menu will start. To end the remote operation, press **PLAYBACK**. To operate the other line or both lines, select the required line(s) (see below), and enter the desired direct commands.

SELECTING
ANOTHER
LINE

1

- LINE 1 is selected and the number of new messages on LINE 1 is heard.

2

- LINE 2 is selected and the number of new messages on LINE 2 is heard.

0

- LINE 1 and LINE 2 are selected and the number of new messages on both lines is heard.

ANSWERING
SYSTEM ON
FOR EACH
LINE

1 8

- “Answer set line 1” is heard and the LINE 1 answering system is turned on.

2 8

- “Answer set line 2” is heard and the LINE 2 answering system is turned on.

0 8

- “Answer set line 1 and line 2” is heard and the answering system for both lines is turned on.

◦If the LINE 1 (LINE 2) answering system is on and you also want to turn on the LINE 2 (LINE 1) answering system, press **# 0 8**.

Using the Belt Clip

You can hang the handset on your belt or pocket using the belt clip.

To attach the belt clip

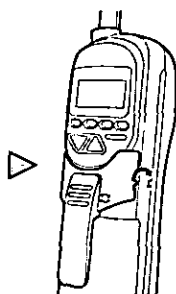
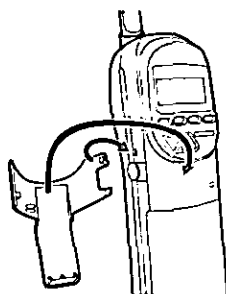

To remove the belt clip

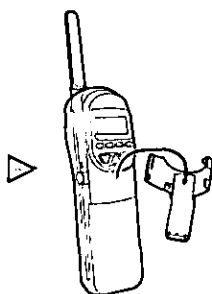

Using the Optional Headset

Plugging an optional headset into the handset allows a hands-free phone conversation. Please use only the Panasonic KX-TCA90 headset. To order, call the accessories telephone number on page 2.

Connecting the optional headset to the handset

Open the headset jack cover and connect the optional headset to the headset jack as shown.

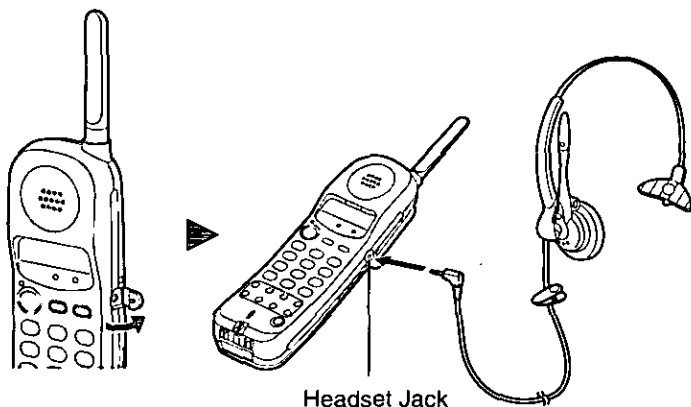

When the optional headset is connected, make sure to use the headset to talk with the caller. If you want to have a normal cordless phone conversation, disconnect the headset.

Battery Replacement

If "Recharge" is displayed and/or "[]" flashes after being fully charged, replace the battery with a new Panasonic P-P501 (KX-A36) battery. To order, call the accessories telephone number on page 2.

- 1 Remove the cover by sliding while pressing the arrow.
- 2 Replace the battery and close the cover.
- 3 Make sure you charge the new battery for about 4 hours in order to display the battery strength prompt correctly (p. 16).

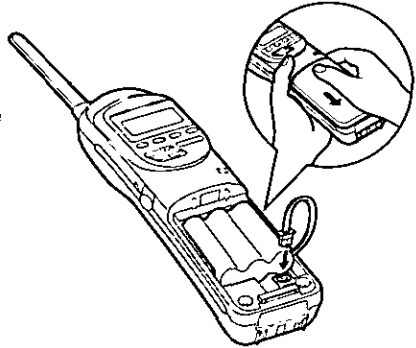

Attention:

The product you have purchased is powered by a nickel cadmium battery which is recyclable. At the end of its useful life, under various state and local laws, it is illegal to dispose of this battery into your municipal waste stream. Please call 1-800-8-BATTERY for information on how to recycle this battery.



Adding Another Phone

This unit will not function during a power failure. To connect a standard telephone on the same line, use the Panasonic T-adaptor KX-J66. To order, call the accessories telephone number on page 2.

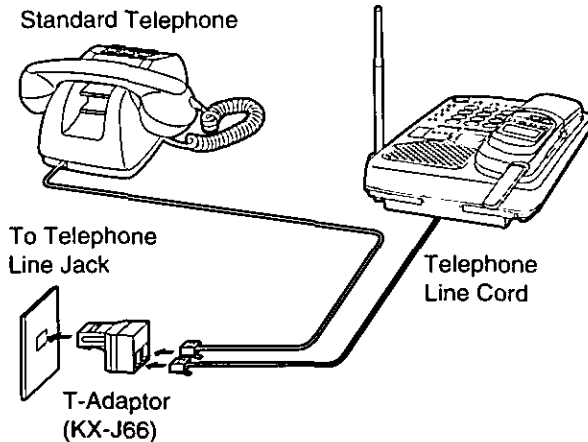



Before Requesting Help

Cordless Telephone

Problem	Remedy
"Out of range" is displayed and an alarm tone sounds when you press TALK , HOLD/INTERCOM , PLAYBACK , PROGRAM or SEARCH <input type="checkbox"/> or <input type="checkbox"/> .	<ul style="list-style-type: none">• You are too far from the base unit. Move closer and try again.• Place the handset on the base unit and try again.• Plug in the AC adaptor.• Raise the base unit antenna.
Static, sound cuts in/out, fades. Interference from other electrical units.	<ul style="list-style-type: none">• Locate the handset and the base unit away from other electrical appliances (p. 3).• Move closer to the base unit.• Raise the base unit antenna.• Press CH to select a clearer channel.
The handset does not ring.	<ul style="list-style-type: none">• The ringer volume is set to OFF. Press LOUD/RINGER then the line button while the TALK indicator light is off (p. 23).
The base unit does not ring.	<ul style="list-style-type: none">• The ringer volume is set to OFF. Press RINGER/CONF then the line button while the unit is in the stand-by mode (p. 23).
The line indicators do not work properly.	<ul style="list-style-type: none">• Check the settings (p. 13–24).• The line mode selection is incorrect. See page 19.
The handset display is blank.	<ul style="list-style-type: none">• The handset is in the stand-by mode (p. 17). Press SEARCH <input type="checkbox"/> or <input type="checkbox"/> to turn the display on.
The handset display is still blank after pressing SEARCH <input type="checkbox"/> or <input type="checkbox"/> .	<ul style="list-style-type: none">• Charge the battery fully (p. 16).
Speech is cut off in places during a conversation using the speakerphone.	<ul style="list-style-type: none">• If another call is received on the other line, the conversation will be interrupted in order to receive the Caller ID information.



Problem	Remedy
You cannot program items such as the dialing mode.	<ul style="list-style-type: none">◦ Programming is not possible while the unit is in the talk or speakerphone mode, when viewing the Caller List, or while the answering system is in use.◦ Do not pause for over 60 seconds while programming.◦ Move closer to the base unit.◦ SEARCH  or  may have been pressed when you picked up the handset. Press EXIT, and try again.
You cannot store a phone number in memory.	<ul style="list-style-type: none">◦ You cannot store a number while the unit is in the talk, speakerphone or intercom mode, or while the answering system is in use.◦ Do not pause for over 60 seconds while storing.
While programming or searching, the unit starts to ring and stops the program/search.	<ul style="list-style-type: none">◦ To answer the call, press TALK, DIGITAL SP-PHONE or the relevant line button. Start again from the beginning after hanging up.
During a conversation, the other line indicator/button flashes quickly and the handset display shows another caller's information.	<ul style="list-style-type: none">◦ Someone is calling you on the other line. To answer, press HOLD/INTERCOM or LOCATOR/INTERCOM/HOLD to put the current call on hold. Press the line button on the handset whose indicator is flashing quickly or the line button on the base unit which is flashing quickly (p. 46).
The handset does not display the caller's name and/or phone number.	<ul style="list-style-type: none">◦ Other telephone equipment may be interfering with your phone. Disconnect it and try again.◦ Other electrical appliances connected to the same outlet may be interfering with the Caller ID information.◦ Telephone line noise may be interfering with the Caller ID information.

◆ Before Requesting Help

Problem	Remedy
A call was received, but the caller's information was not stored in the Caller List.	◦ If you receive two calls at the same time, only one of the caller's information can be stored.
The handset display returns to the stand-by mode while viewing the Caller List.	◦ Do not pause for over 60 seconds while searching. ◦ DIGITAL SP-PHONE or a line button was pressed.
When a second call is received during a conversation, the unit does not display the new caller's name and/or phone number.	◦ The line mode selection is incorrect. See page 19.
LOCATOR/INTERCOM/HOLD does not function.	◦ The handset is too far from the base unit. ◦ The handset is in the programming mode, engaged in an outside call or viewing the Caller List. Wait until the IN USE/CHARGE indicator light goes out.
REDIAL/PAUSE does not function properly.	◦ The button has a double function as either redial or pause. It will redial the last number dialed if pressed at the outset of a call (p. 31). If another number has been dialed first, it will operate as a pause button (p. 51).
You cannot redial by pressing REDIAL/PAUSE .	◦ Access numbers entered after pressing PHONE will not be included when redialing (p. 51). ◦ If the last number dialed was more than 32 digits long, the number will not be redialed correctly.
You cannot have a conversation using the handset.	◦ When the optional headset is connected (p. 76), you must use the headset to talk with the caller. To have a normal cordless phone conversation, disconnect the headset.



Problem	Remedy
You cannot have a conversation using an optional headset.	◦Make sure that the optional headset is connected properly (p. 76).

Answering System

Problem	Remedy
The answering system is on, but incoming messages are not recorded.	◦The recording time is set to “greeting only”. Select “1 minute” or “3 minutes” (p. 29). ◦Memory is full. Erase some, or all, of the messages (p. 60). ◦You are answering the other line with the speakerphone, or the answering system is in use (recording a message, playing back a message, etc.). Hang up the first call or stop using the answering system.
You cannot listen to the recorded messages.	◦Make sure that the unit is in the stand-by mode (p. 17).
“ FULL ” is displayed and the ANSWER ON indicator flashes rapidly, and no new messages are recorded.	◦Memory is full. Erase some, or all, of the messages (p. 60).
You cannot operate the answering system at the base unit.	◦The handset user is operating the answering system, or the handset is in the programming mode. Wait until the IN USE/CHARGE indicator light goes out.
You cannot operate the answering system from a touch tone phone.	◦Make sure you enter the correct remote code. ◦The answering system may not respond if the tones are too short to activate the unit. Press each button firmly. ◦The answering system is off. Turn it on (p. 72).

➡ Before Requesting Help

Problem	Remedy
You cannot operate the answering system with the handset.	<ul style="list-style-type: none">◦ Someone is operating the answering system.◦ The base unit is in the speakerphone mode.◦ You are too far from the base unit. Move closer to the base unit.◦ The unit is recording a message. To answer the call, press the line button whose indicator is flashing twice every 2 seconds.
While recording a greeting message, the unit starts to ring and stops recording.	<ul style="list-style-type: none">◦ To answer the call, lift the handset off the base unit, or press DIGITAL SP-PHONE, TALK or the relevant line button. Start again from the beginning after hanging up.
During playback, the unit starts to ring and stops playback.	<ul style="list-style-type: none">◦ To answer the call, lift the handset off the base unit, or press DIGITAL SP-PHONE, TALK or the relevant line button. To resume playback, press NEW MESSAGE after hanging up.
The handset does not display the name and/or number of the caller whose message is being played.	<ul style="list-style-type: none">◦ Place the handset on the base unit correctly (p. 58).◦ If the caller is not stored in the Caller List, the handset will not display the caller's information.
The unit does not alert your pager.	<ul style="list-style-type: none">◦ The line mode selection is incorrect. See page 19.

General

Problem	Remedy
The unit does not work.	<ul style="list-style-type: none">◦ Check the settings (p. 13–24).◦ Charge the battery fully (p. 16).◦ Clean the charge contacts and charge again (p. 17).◦ Install the battery properly (p. 16, 77).◦ Place the handset on the base unit and unplug the AC adaptor to reset. Plug in and try again.◦ Re-insert the handset battery and place the handset on the base unit. Try again.
You cannot program items such as the time/day adjustment (p. 27).	<ul style="list-style-type: none">◦ Programming is not possible while the unit is in the talk, speakerphone or intercom mode, when viewing the Caller List, or while the answering system is in use.◦ Move closer to the base unit.
Previously programmed information is erased.	<ul style="list-style-type: none">◦ If a power failure occurs, programmed information may be erased. Reprogram if necessary.
“Recharge” is displayed, “[]” flashes or the unit beeps intermittently.	<ul style="list-style-type: none">◦ Charge the battery fully (p. 16).
You charged the battery fully, but “Recharge” is still displayed and/or “[]” continues to flash.	<ul style="list-style-type: none">◦ Clean the charge contacts and charge again (p. 17).◦ Install a new battery (p. 77).
The IN USE/CHARGE indicator light does not go out while charging.	<ul style="list-style-type: none">◦ This is normal.
If you cannot solve your problem	<ul style="list-style-type: none">◦ Call our customer call center at 1-800-211-PANA(7262).

Important Safety Instructions

When using this unit, basic safety precautions should always be followed to reduce the risk of fire, electric shock, or personal injury.

1. Read and understand all instructions.
2. Follow all warnings and instructions marked on this unit.
3. Unplug this unit from AC outlets before cleaning. Do not use liquid or aerosol cleaners. Use a damp cloth for cleaning.
4. Do not use this unit near water, for example, near a bathtub, washbowl, kitchen sink, or the like.
5. Place this unit securely on a stable surface. Serious damage and/or injury may result if the unit falls.
6. Do not cover slots and openings on the unit. They are provided for ventilation and protection against overheating. Never place the unit near radiators, or in a place where proper ventilation is not provided.
7. Use only the power source marked on the unit. If you are not sure of the type of power supplied to your home, consult your dealer or local power company.
8. Do not place objects on the power cord. Install the unit where no one can step or trip on the cord.
9. Do not overload wall outlets and extension cords. This can result in the risk of fire or electric shock.
10. Never push any objects through slots in this unit. This may result in the risk of fire or electric shock. Never spill any liquid on the unit.
11. To reduce the risk of electric shock, do not disassemble this unit. Take the unit to an authorized servicer when service is required. Opening or removing covers may expose you to dangerous voltages or other risks. Incorrect reassembly can cause electric shock when the unit is subsequently used.
12. Unplug this unit from the wall outlet and refer servicing to an authorized servicer when the following conditions occur:
 - A. When the power supply cord or plug is damaged or frayed.
 - B. If liquid has been spilled into the unit.
 - C. If the unit has been exposed to rain or water.
 - D. If the unit does not work normally by following the operating instructions. Adjust only controls covered by the operating instructions. Improper adjustment may require extensive work by an authorized servicer.
 - E. If the unit has been dropped or physically damaged.
 - F. If the unit exhibits a distinct change in performance.
13. During thunderstorms, avoid using telephones except cordless types. There may be a remote risk of an electric shock from lightning.
14. Do not use this unit to report a gas leak, when in the vicinity of the leak.

SAVE THESE INSTRUCTIONS

CAUTION:

To reduce the risk of fire or injury to persons, read and follow these instructions.

1. Use only the battery(ies) specified.
2. Do not dispose of the battery(ies) in a fire. They may explode. Check with local waste management codes for special disposal instructions.
3. Do not open or mutilate the battery(ies). Released electrolyte is corrosive and may cause burns or injury to the eyes or skin. The electrolyte may be toxic if swallowed.
4. Exercise care in handling batteries in order not to short the battery to conductive materials such as rings, bracelets, and keys. The battery and/or conductor may overheat and cause burns.
5. Charge the battery(ies) provided with or identified for use with this product only in accordance with the instructions and limitations specified in this manual.

WARNING:

TO PREVENT FIRE OR SHOCK HAZARD, DO NOT EXPOSE THIS PRODUCT TO RAIN OR ANY TYPE OF MOISTURE.

FCC and Other Information

If requested by the telephone company, inform them as follows:

FCC Registration No. (found on the bottom of the unit)
Ringer Equivalence. 0.2B
The particular telephone lines to which the equipment is connected.

This unit must not be connected to a coin operated line.

If you are on a party line, check with your local telephone company.

Ringer Equivalence No. (REN):

The REN is useful in determining the quantity of devices you may connect to your telephone line and still have all of those devices ring when your telephone number is called. In most, but not all areas, the sum of the REN's of all devices connected to one line should not exceed five (5.0). To be certain of the number of devices you may connect to your line, as determined by the REN, you should contact your local telephone company to determine the maximum REN for your calling area.

In the event terminal equipment causes harm to the telephone network, the telephone company should notify the customer, if possible, that service may be stopped.

However, where prior notice is impractical, the company may temporarily cease service providing that they:

- (a) Promptly notify the customer.
- (b) Give the customer an opportunity to correct the problem with their equipment.
- (c) Inform the customer of the right to bring a complaint to the Federal Communication Commission pursuant to procedures set out in FCC Rules and Regulations Subpart E of Part 68.

The Telephone Company may make changes in its communications facilities, equipment, operations or procedures, where such action is reasonably required in the operation of its business and is not inconsistent with the rules and regulations in FCC Part 68.

If such changes can be reasonably expected to render any customer terminal equipment incompatible with telephone company communications facilities, or require modification or alteration of such terminal equipment, or otherwise materially affect its use or performance, the customer shall be given adequate notice in writing, to allow the customer an opportunity to maintain uninterrupted service.

When programming emergency numbers and/or making test calls to emergency numbers:

1. Remain on the line and briefly explain to the dispatcher the reason for the call before hanging up.
2. Perform such activities in the off-peak hours, such as early morning hours or late evenings.

This device complies with Part 15 of the FCC Rules. Operation is subject to the following two conditions: (1) This device may not cause harmful interference, and (2) this device must accept any interference received, including interference that may cause undesired operation.

Privacy of communications may not be ensured when using this phone.

CAUTION:

Any changes or modifications not expressly approved by the party responsible for compliance could void the user's authority to operate this device.

Note:

This equipment has been tested and found to comply with the limits for a Class B digital device, pursuant to Part 15 of the FCC Rules. These limits are designed to provide reasonable protection against harmful interference in a residential installation. This equipment generates, uses, and can radiate radio frequency energy and, if not installed and used in accordance with the instructions, may cause harmful interference to radio communications. However, there is no guarantee that interference will not occur in a particular installation. If this equipment does cause harmful interference to radio or television reception, which can be determined by turning the equipment off and on, the user is encouraged to try to correct the interference by one or more of the following measures:

- Reorient or relocate the receiving antenna.
- Increase the separation between the equipment and receiver.
- Connect the equipment into an outlet on a circuit different from that to which the receiver is connected.
- Consult the dealer or an experienced radio/TV technician for help.

Some cordless telephones operate at frequencies that may cause interference to nearby TVs and VCRs. To minimize or prevent such interference, the base of the cordless telephone should not be placed near, or on top of a TV or VCR.

If interference is experienced, move the cordless telephone farther away from the TV or VCR. This will often reduce, or eliminate, interference.

- **Environment**—do not place the unit in a room where the temperature is less than 5°C (41°F) or greater than 40°C (104°F). Allow 10 cm (4") clearance around the unit for proper ventilation. Avoid excessive smoke, dust, mechanical vibration, shock, or direct sunlight.
- **Medical**—consult the manufacturer of any personal medical devices, such as pacemakers, to determine if they are adequately shielded from external RF (radio frequency) energy. (The unit operates in the frequency range of 905MHz to 926MHz and the power output level can range from 0.001 watts to 0.2 watts.) Do not use the unit in health care facilities if any regulations posted in the area instruct you not to do so. Hospitals or health care facilities may be using equipment that could be sensitive to external RF (radio frequency) energy.
- **Routine care**—wipe the unit with a soft cloth. Do not use benzine, thinner, or any abrasive powder. When you leave the unit unused for a long period of time, unplug the AC adaptor from the outlet.
- **If there is any trouble**—disconnect the unit from the telephone line and connect a known working phone. If the known working phone operates properly, have your unit repaired by one of the authorized Panasonic Factory Service Centers. If the known working phone does not operate properly, consult your telephone company.

For product service

- Panasonic Servicenters are listed in the servicenter directory.
- Call 1-800-211-PANA(7262) for the location of an authorized servicenter.

When you ship the product

- Carefully pack your unit, preferably in the original carton.
- Attach a letter, detailing the symptom, to the outside of the carton.

Symptom

- Send the unit to an authorized servicenter, prepaid and adequately insured.
- Do not send your unit to the Panasonic Consumer Electronics Company listed below or to executive or regional sales offices. These locations do not repair consumer products.

- This cordless telephone is designed for use in the United States of America. Sale or use of this product in other countries may violate local laws.
- Ce téléphone sans fil est conçu pour être utilisé aux États-Unis d'Amérique. La vente ou l'emploi de cet appareil dans certains autres pays peut constituer une infraction à la législation locale.
- Este teléfono sin cordón fue elaborado para uso en los Estados Unidos de América. La venta o el empleo de este producto en ciertos países puede constituir violación de la legislación local.
- このコードレス電話機は、日本国外での使用を目的として設計されており、日本国内での使用は法律違反となります。従って、当社では日本国内においては原則として修理などのサービスは致しかねます。

Panasonic Consumer Electronics Company,
Division of Matsushita Electric Corporation of America
One Panasonic Way, Secaucus, New Jersey 07094

Panasonic Sales Company,
Division of Matsushita Electric of Puerto Rico, Inc.
Ave. 65 de Infantería, Km. 9.5, San Gabriel Industrial Park
Carolina, Puerto Rico 00985