

Panasonic

Cordless Phone

Model No. **KX-TC905-W**

Pulse-or-tone dialing capability

Operating Instructions



PLEASE READ BEFORE USE AND SAVE.

Charge the battery for about 15 hours before initial use.

Getting Started

Basic Operation

Advanced Operation

Useful Information

Before Initial Use

Please read **IMPORTANT SAFETY INSTRUCTIONS** on pages 27-28 before use. Read and understand all instructions.

Thank you for purchasing the Panasonic cordless telephone.

Attach your purchase receipt here.

For your future reference



Serial No

Date of purchase

(found on the bottom of the unit)

Name and address of dealer

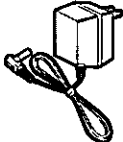
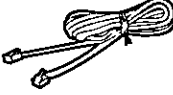
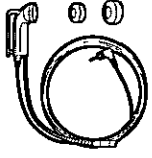
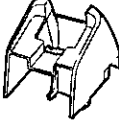
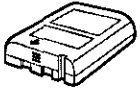
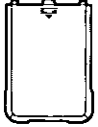
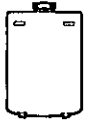
Accessories

<input type="checkbox"/> AC Adaptor (p 9)  one	<input type="checkbox"/> Telephone Line Cord (p 9)  one	<input type="checkbox"/> Headset and Pads (p 12)  one set	<input type="checkbox"/> Handset Rest (p 10)  one
<input type="checkbox"/> Battery (p 8)  one	<input type="checkbox"/> Handset Cover (p 8)  one	<input type="checkbox"/> Cradle Cover (p 8)  one	<input type="checkbox"/> Handset Clip (p 10)  one

• To order accessories, call 1-800-332-5368

For Best Performance

Battery Charge

To power the handset, install the battery (p. 8) and charge it for about 15 hours before initial use (p. 11).

Place the handset on the base unit.

Be sure to set the Handset Rest on the cradle (p. 10) for proper charge when the headset is connected to the handset.

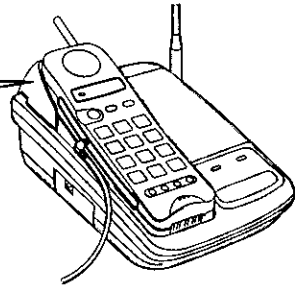

Operating Distance/Noise

Calls are transmitted between the base unit and the handset using wireless radio waves. For maximum distance and noise free operation, the recommended base unit location is:

Away from electrical appliances such as a TV, radio, or personal computer.

In a HIGH and CENTRAL location with no obstructions such as walls.

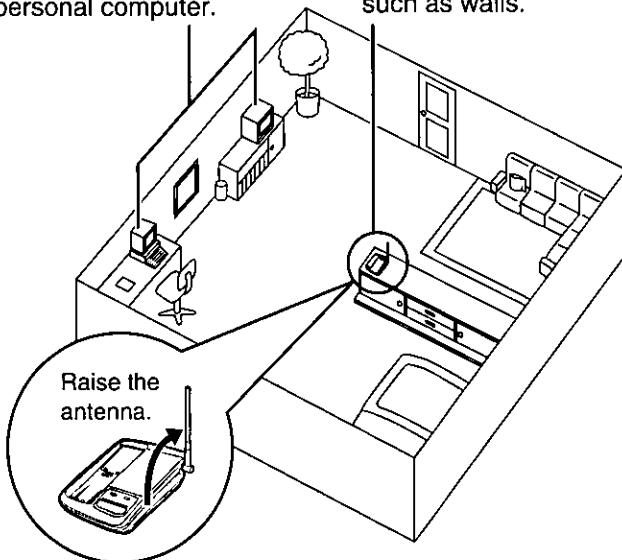

Contents

Getting Started

Location of Controls	6
Setting Up	8
Installing the Battery in the Handset	8
Installing the Cradle Cover on the Base Unit	8
Connection	9
Setting the Handset Rest	10
Installing the Handset Clip	10
Battery Charge	11
Using the Headset	12
Connecting the Headset to the Handset	12
How to Wear the Headset	13

Basic Operation

Making Calls	14
Answering Calls	15

Advanced Operation

Automatic Dialing	16
Storing Phone Numbers in Memory.....	16
Dialing a Stored Number	17
One-Touch Dialing	18
Storing Phone Numbers in Memory.....	18
Dialing a Stored Number	19

Special Features	20
Handset Locator	20
Automatic Security Code Setting	21
For Call Waiting Service Users	21
Temporary Tone Dialing (For Rotary Service Users)	21
If Your Unit is Connected to a PBX	21

<i>Useful Information</i>

Optional Spare Battery	22
Before Requesting Help	24
Adding Another Phone	26
Important Safety Instructions	27
FCC and Other Information	29

Location of Controls

Handset

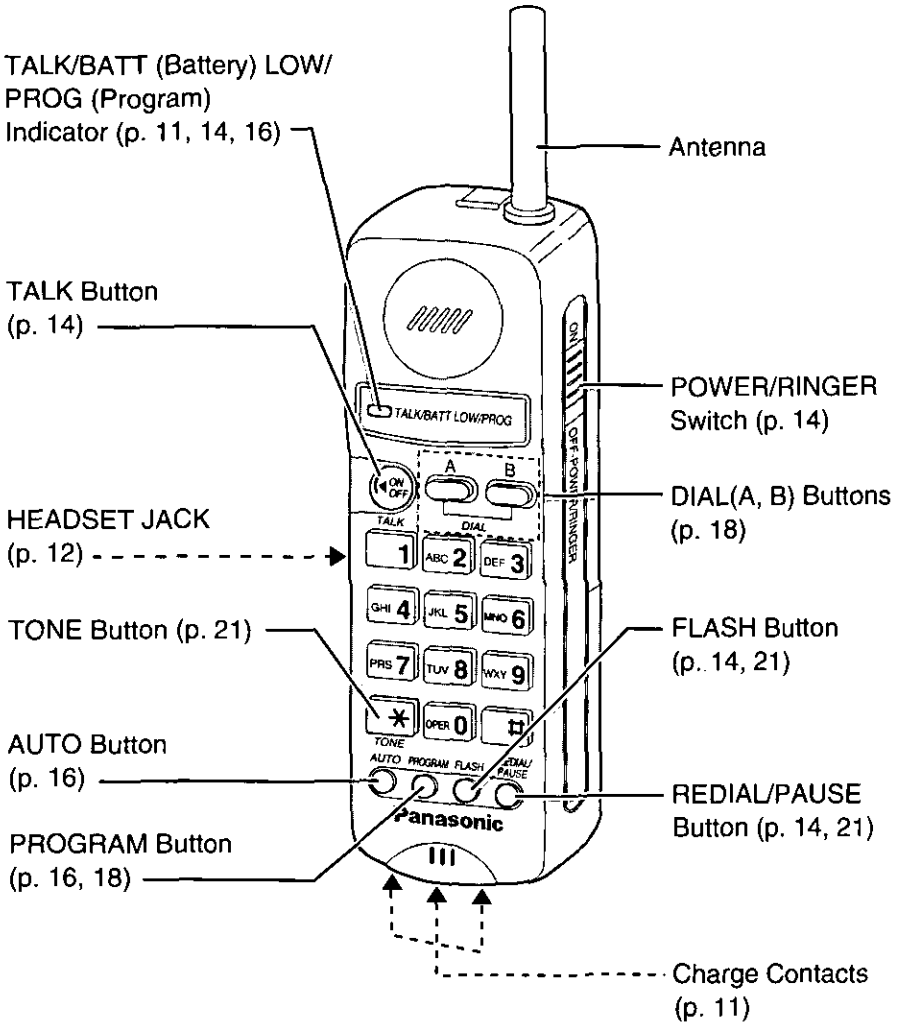

Base unit

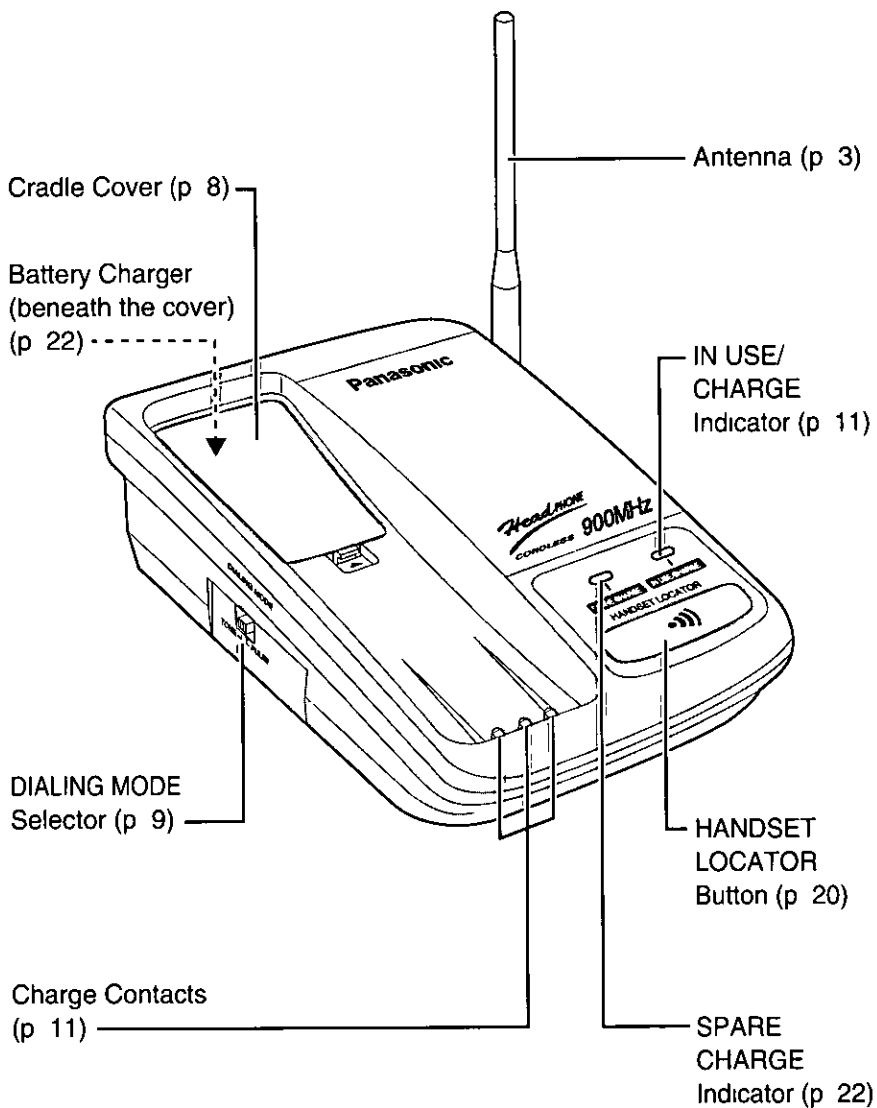

Setting Up

Installing the Battery in the Handset

Install the battery in the direction of the arrow on the battery. Then close the handset cover.

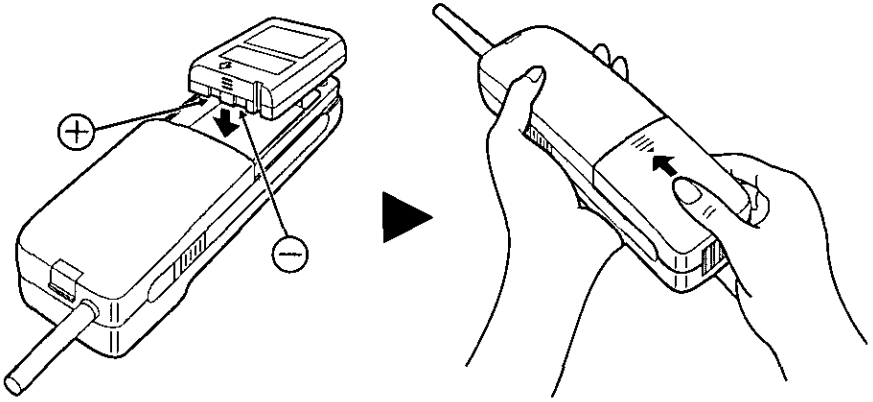

Installing the Cradle Cover on the Base Unit

Close the cradle cover as shown.

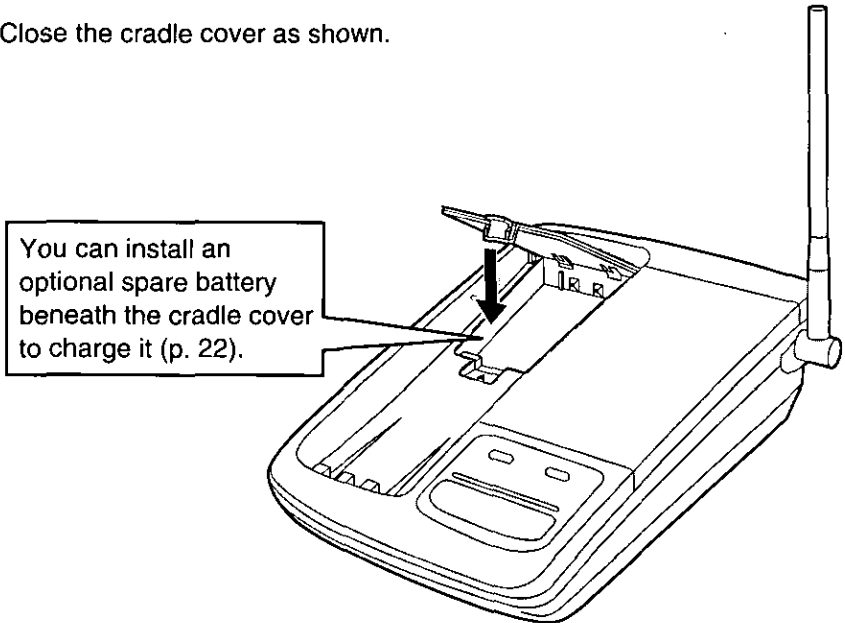

Connection

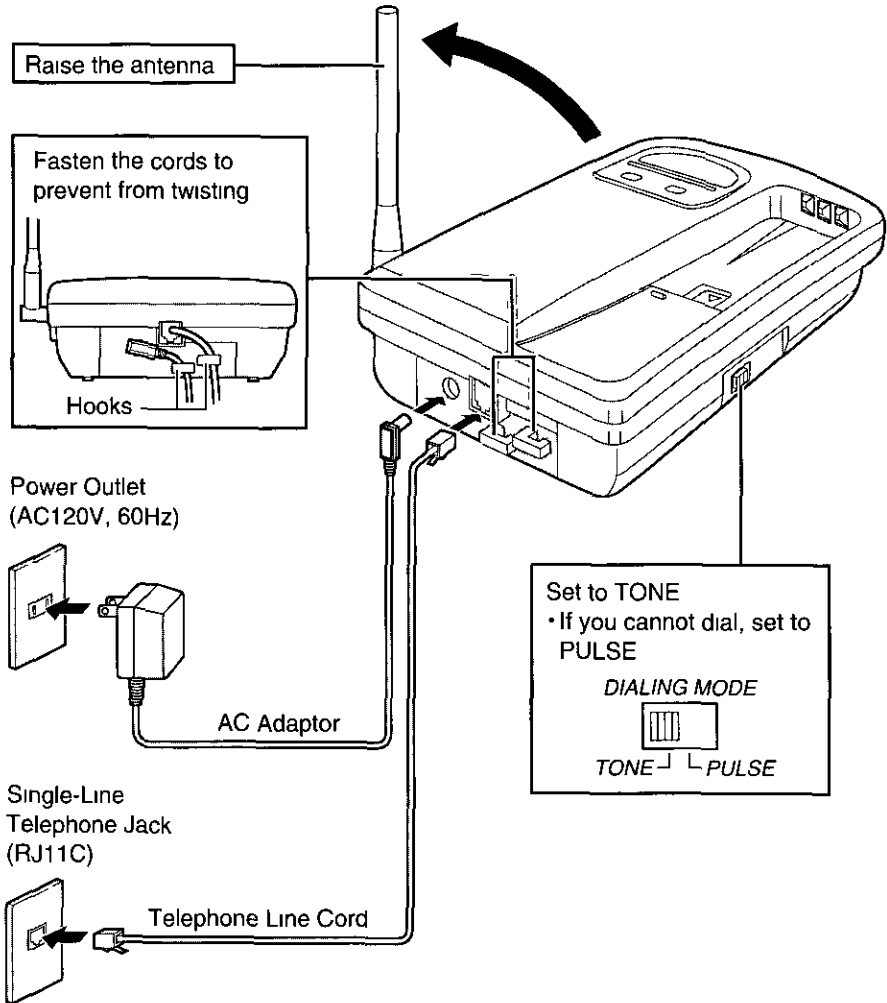

- USE ONLY Panasonic AC ADAPTOR KX-A11
- The AC adaptor must remain connected at all times (It may feel warm during use This is normal)
- If you connect a reserve telephone on the same line, see page 26

➔ Setting Up

Setting the Handset Rest

Be sure to set the Handset Rest on the cradle for proper battery charge when the headset is connected to the handset

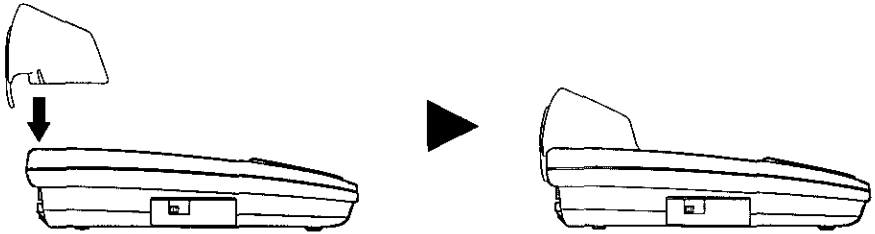

- If the headset is installed, but the Handset Rest is not, the battery may not charge properly

Installing the Handset Clip

You can hang the handset on your belt or pocket by attaching the handset clip. Slide the cover to remove it. Then insert the handset clip.



To remove the handset clip

Slide the handset clip in the direction of the arrow with a screwdriver or similar object

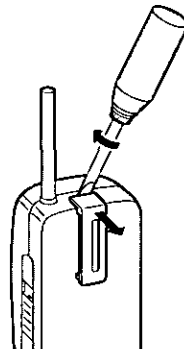

Battery Charge

Place the handset on the base unit for about 15 hours (Set the Handset Rest on the cradle for proper charge when the headset is connected to the handset)

- The IN USE/CHARGE indicator lights

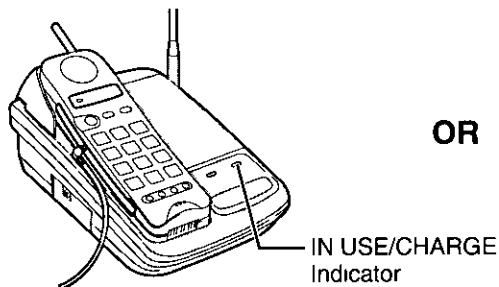

OR

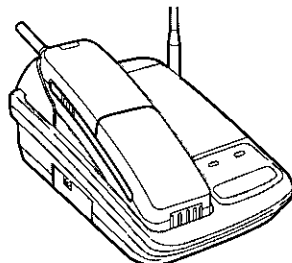

Recharge

When the TALK/BATT LOW/PROG indicator flashes slowly or beeps intermittently, recharge the handset battery

TALK/BATT LOW/
PROG Indicator

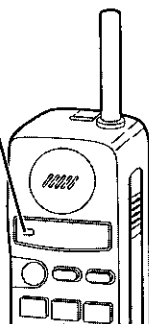

If you do not want to wait until the battery is fully recharged, we recommend you purchase an optional spare battery (page 22)

Standard battery life

If your Panasonic battery is fully charged,

While in use (TALK)	Up to about 4 5 hours
While not in use (Stand-By)	Up to about 7 days

- Battery life may vary depending on usage conditions and ambient temperature
- **Clean the charge contacts with a soft cloth once a month**, or the battery may not charge properly
- Once the battery is fully charged, you do not have to place the handset on the base unit until the TALK/BATT LOW/PROG indicator flashes slowly
- The battery cannot be overcharged

Using the Headset

When the headset is plugged into the handset, you can have a hands-free phone conversation by wearing the headset.

- The caller's voice is heard through the headset earpiece. When you talk, your voice is picked up by the headset microphone.
- Please use only the included headset. (To order, call 1-800-332-5368.)

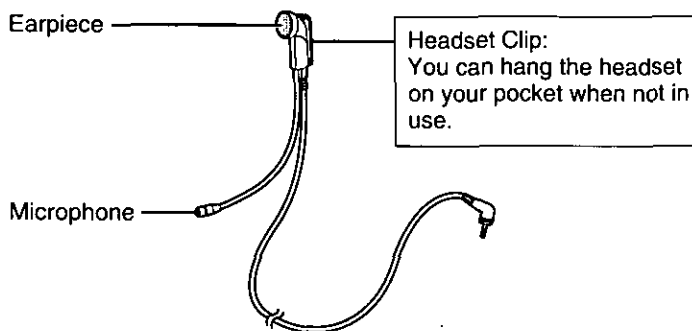

When the headset is connected to the handset, be sure to wear the headset in order to have a phone conversation. If you wish to have a normal cordless phone conversation, disconnect the headset.

Connecting the Headset to the Handset

Connect the headset to the jack of the handset as shown.

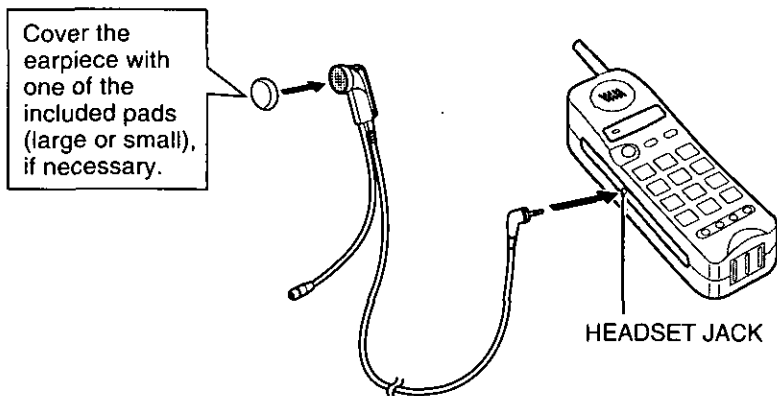

How to Wear the Headset

- 1 Place the earpiece in your ear

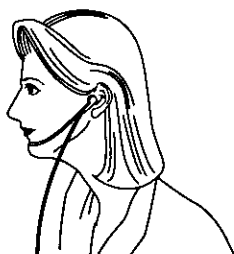

- 2 Adjust the microphone to a comfortable position

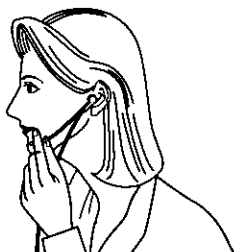

You can hang the handset on your belt or pocket using the handset clip. To install the handset clip, see page 10

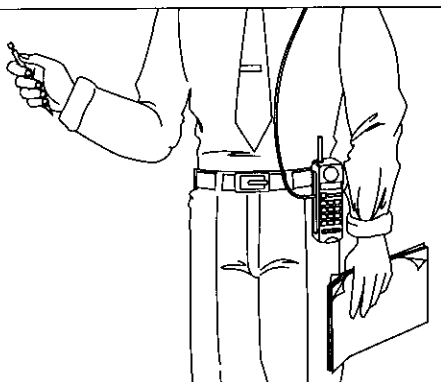

Making Calls

To have a hands-free conversation, connect the headset to the handset and wear it (p. 12, 13).

- 1 Lift the handset and press **TALK**.
 - The TALK/BATT LOW/PROG indicator lights.

- 2 Dial a telephone number.

- 3 To hang up, press **TALK** or place the handset on the base unit.
 - The indicator light goes out.

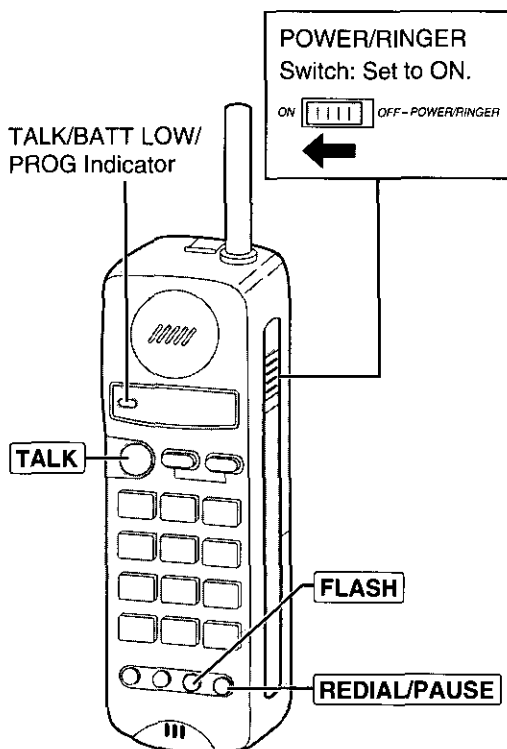

- If an alarm tone sounds in step 1, move toward the base unit or place the handset on the base unit. Then try again.

If you misdial

Press **FLASH** firmly. ➡ Dial again.

To redial the last number

Press **TALK** ➡ **REDIAL/PAUSE**.

Lighted keypad

The dialing buttons will light while you are dialing and will flash when a call comes in. The light will go out about 10 seconds after dialing or answering the call.

Answering Calls

Make sure that the POWER/RINGER switch is set to ON, or the handset will not ring

To have a hands-free conversation, connect the headset to the handset and wear it (p 12, 13)

If the handset is off the base unit, press **TALK**

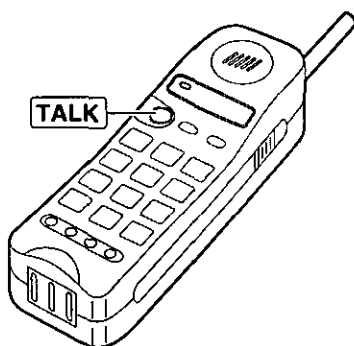

OR

If on the base unit, just lift it

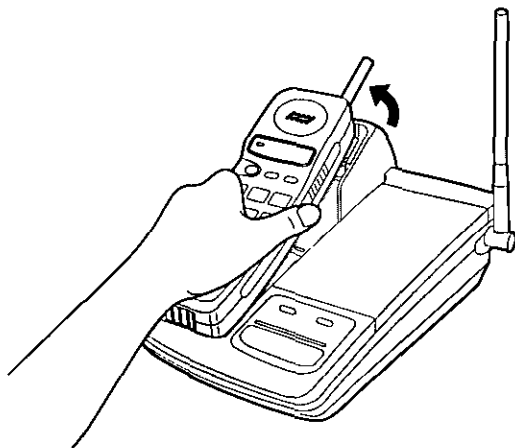

If the headset is connected to the handset, be sure to wear the headset (p 13) in order to have a phone conversation. If you wish to have a normal cordless phone conversation, disconnect the headset.

Automatic Dialing

Storing Phone Numbers in Memory

The dialing buttons (0 to 9) function as memory stations.
The TALK/BATT LOW/PROG indicator light must be off.

- 1 Press **PROGRAM**.
 - The TALK/BATT LOW/PROG indicator flashes.

- 2 Enter a phone number up to 20 digits.
 - If you misdial, press **PROGRAM** to end storing, then restart from step 1.

- 3 Press **AUTO**.

- 4 Press a memory station number (0 to 9).
 - A confirmation tone sounds. (See below.)
 - To store other numbers, repeat steps 1 through 4.

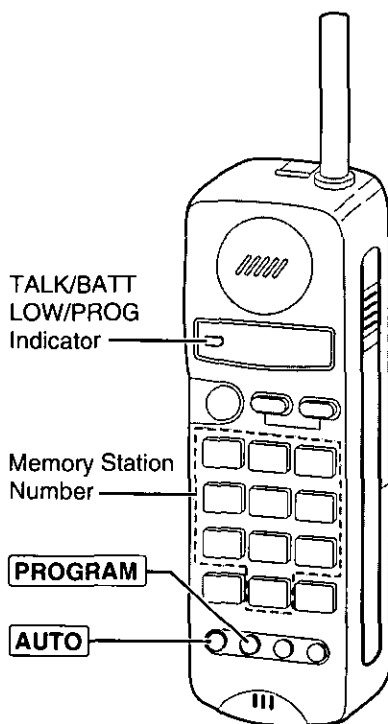

What the confirmation tone means

- 1 beep: The new number is stored.
- 2 beeps: The number is the same as a previously stored one.

To erase a stored number

Press **PROGRAM** ⇒ **AUTO** ⇒ the memory station number (for the phone number to be erased)

Memory Sticker

You may use the included memory sticker as a memorandum for automatic dialing or one-touch dialing (p 18) Write down the names or phone numbers, then attach it to the unit or at a convenient place

A	B
1	6
2	7
3	8
4	9
5	0

Dialing a Stored Number

- 1 Lift the handset and press **TALK**
- 2 Press **AUTO**
- 3 Press the memory station number (0 to 9)
 - The stored number is dialed

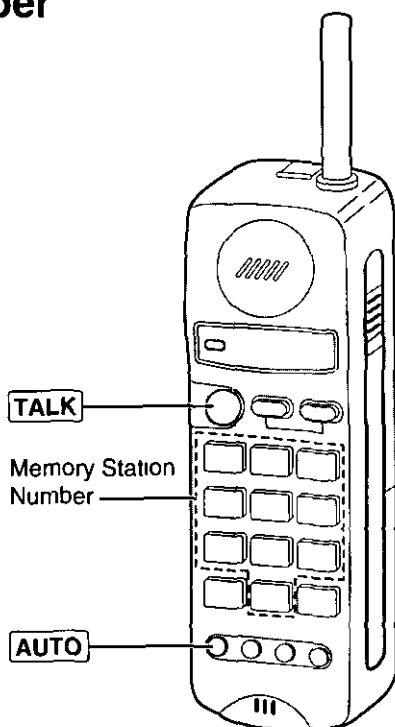

One-Touch Dialing

A 20-digit phone number can be stored in each of the DIAL (A, B) buttons. The stored number is dialed with a one-touch operation.

Storing Phone Numbers in Memory

The TALK/BATT LOW/PROG indicator light must be off.

- 1 Press **PROGRAM**.
 - The TALK/BATT LOW/PROG indicator flashes.

- 2 Enter a phone number up to 20 digits.
 - If you misdial, press **PROGRAM** to end storing, then restart from step 1.

- 3 Press **A** or **B**.
 - The phone number is stored in the button.
 - A confirmation tone sounds. (See below.)

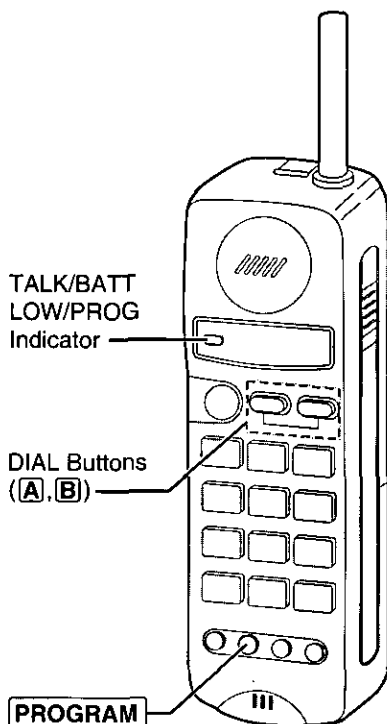

What the confirmation tone means

- 1 beep: The number is newly stored.
- 2 beeps: The number is the same as a previously stored one.

To erase a stored number

Press **PROGRAM** → **A** or **B** (for the phone number to be erased)

Memory sticker

You may use the included memory sticker as a memorandum for one-touch dialing or automatic dialing (p 16) Write down the names or phone numbers, then attach it to the unit or at a convenient place

A	B
1	6
2	7
3	8
4	9
5	0

Dialing a Stored Number

- 1 Lift the handset and press **TALK**
- 2 Press **A** or **B**
 - The stored number is dialed

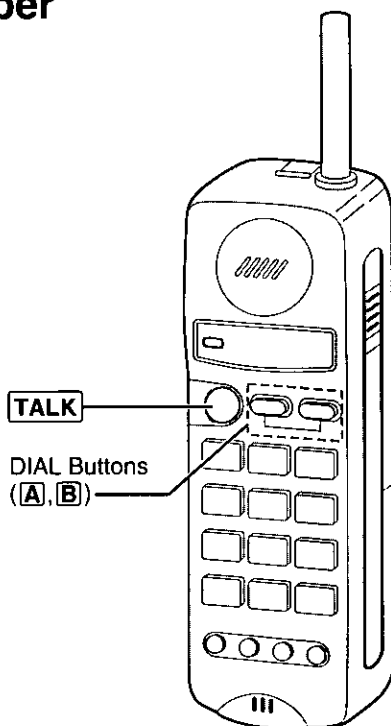

Special Features

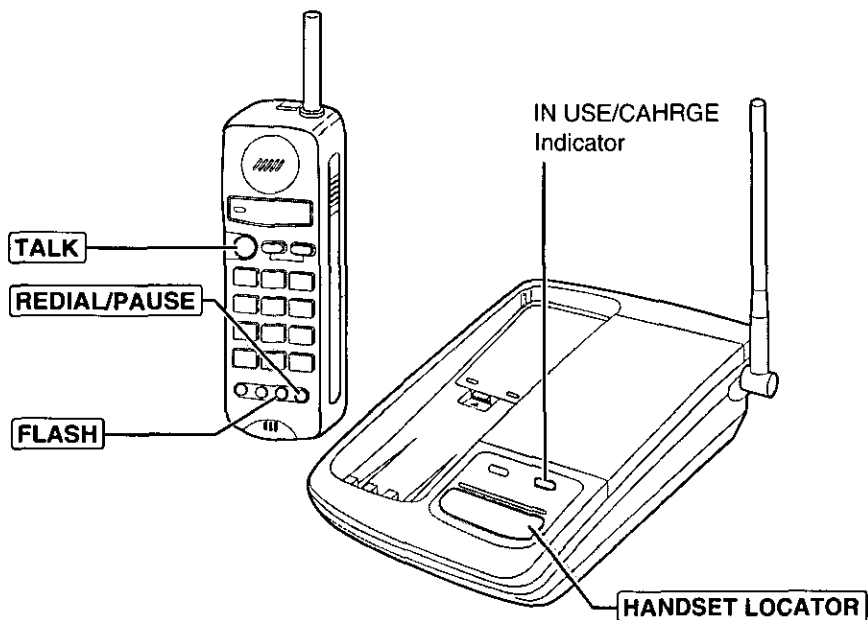

Handset Locator

From the base unit you can locate the handset or page a person at the handset with beep tones.

1 Press **HANDSET LOCATOR**.

- The IN USE/CHARGE indicator flashes and the handset beeps.

2 To stop paging, press **HANDSET LOCATOR** again or press **TALK** twice on the handset.

Automatic Security Code Setting

Whenever you place the handset on the base unit, the unit automatically selects one of a million security codes. These codes help to avoid unauthorized use of your telephone line by another cordless telephone.

For Call Waiting Service Users

Press **FLASH** lightly if you hear a call-waiting tone while speaking.

- The first call is put on hold and you can answer the second call.
- To return to the first caller, press **FLASH** again.

Temporary Tone Dialing (For Rotary Service Users)

Press **TONE** before dialing.

- The dialing mode changes to tone. You can enter numbers to access answering systems, electronic banking services, etc. When you hang up, the mode returns to pulse.

If Your Unit is Connected to a PBX

We recommend you press **REDIAL/PAUSE** between the access number for an outside line and the phone number.

- Pressing **REDIAL/PAUSE** once makes a 3 5-second pause. This prevents misdialing when you redial or dial a stored number.

Optional Spare Battery

When the handset battery needs charging, replace it with a fully charged optional spare battery. This eliminates having to wait for the handset battery to recharge. **Please purchase a Panasonic KX-A43 battery** and install it in the base unit to charge.

Installing the spare battery in the base unit

- 1 Open the cradle cover by pushing the tab and raising it. (If you have set the Handset Rest on the cradle, please remove it first.)

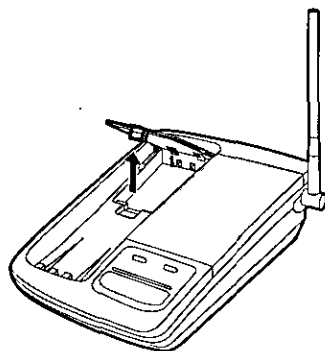

- 2 Install the spare battery in the direction of the arrow on the battery, then close the cradle cover. (Set the Handset Rest on the cradle.)

- The SPARE CHARGE indicator lights.

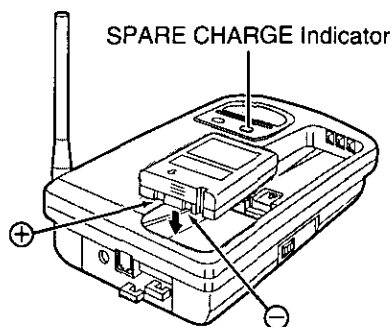

The spare battery is always being charged in the base unit while the AC adaptor is connected. The battery cannot be overcharged.

Attention:

The product that you have purchased contains a rechargeable battery. The battery is recyclable. At the end of its useful life, under various state and local laws, it may be illegal to dispose of this battery into the municipal waste stream. Check with your local solid waste officials for details in your area for recycling options or proper disposal.



Replacing the handset battery with the spare battery

To prevent memory loss, replace within 5 minutes.

- 1 Set the POWER/RINGER switch to OFF to prevent memory loss. Remove the handset cover, then remove the battery.

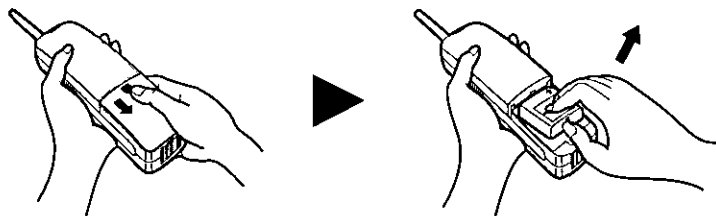

- 2 Replace the handset battery with the spare battery in the base unit.

- ① Remove the spare battery.
- ② Insert the handset battery in the base unit in the correct direction.

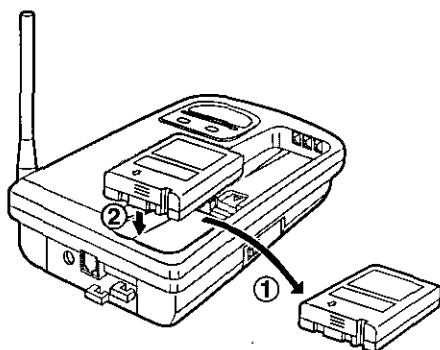

- 3 Install the spare battery in the handset in the correct direction.

- When you finish, close the handset cover and set the POWER/RINGER switch to ON.

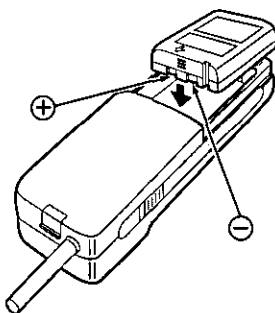

- If the TALK/BATT LOW/PROG indicator flashes slowly even when the handset battery has been fully charged, it is time to change the battery with a new one. Remember to fully charge the new battery after battery replacement.
- Please use only a Panasonic KX-A43 battery. For accessory order, call 1-800-332-5368.

Before Requesting Help

Problem	Remedy
An alarm tone sounds when you press TALK .	<ul style="list-style-type: none">• You are too far from the base unit. Move closer and try again.• Place the handset on the base unit and try again.• Plug in the AC adaptor.
An alarm tone sounds continuously while using the handset.	<ul style="list-style-type: none">• Move closer to the base unit quickly, or the call will be terminated within 60 seconds.• Make sure that the AC adaptor is connected.
The unit does not work.	<ul style="list-style-type: none">• Check the setting up (p. 8-13)• Charge the battery fully.• The security codes in the handset and the base unit are not the same. Place the handset on the base unit.• You cannot make a call if the handset is on the base unit. Be sure to lift the handset to make a call.
Static, sound cuts in/out, fades. Interference from other electrical units.	<ul style="list-style-type: none">• Set the handset and the base unit away from electrical appliances.• Move closer to the base unit.• Raise the base unit antenna.
The handset does not operate or ring. You cannot have a conversation using the handset.	<ul style="list-style-type: none">• The POWER/RINGER switch is set to OFF. Set to ON.• When the headset is plugged into the handset, you must wear the headset (p.13) in order to have a phone conversation. To have a normal cordless phone conversation, disconnect the headset.
You cannot have a conversation using the headset.	<ul style="list-style-type: none">• The POWER/RINGER switch is set to OFF. Set to ON.• Make sure that the headset is properly plugged into the jack of the handset (p.12).

Problem	Remedy
You cannot store a phone number in memory.	<ul style="list-style-type: none"> You cannot store a number while the unit is in the talk mode. Do not pause for over 30 seconds while storing.
While storing a phone number, the unit starts to ring.	<ul style="list-style-type: none"> To answer a call, press TALK. The program will be canceled; Store the number again.
HANDSET LOCATOR does not function.	<ul style="list-style-type: none"> The handset is too far from the base unit or is engaged in an outside call.
The TALK/BATT LOW/PROG indicator flashes slowly or beeps intermittently.	<ul style="list-style-type: none"> Charge the battery fully or replace with a fully charged optional spare battery (p. 11, 23).
You charged the battery fully, but the TALK/BATT LOW/PROG indicator flashes slowly.	<ul style="list-style-type: none"> Clean the charge contacts and charge again. It is time to change the battery. Please purchase a new battery (p. 23).
You place the handset on the base unit to charge, but the IN USE/CHARGE indicator does not light.	<ul style="list-style-type: none"> When the headset is connected to the handset, place the Handset Rest on the cradle and place the handset on it for proper battery charge.
The IN USE/CHARGE indicator and/or the SPARE CHARGE indicator light never goes out while charging.	<ul style="list-style-type: none"> This is normal.
The unit stops working during operation.	<ul style="list-style-type: none"> Unplug the AC adaptor and set the POWER/RINGER switch to OFF to reset. Reconnect the AC adaptor and set the switch to ON, then try again.
If you cannot solve your problem.	<ul style="list-style-type: none"> Call our customer satisfaction center at 201-348-9090.

Adding Another Phone

This unit will not function during a power failure. To connect a standard telephone on the same line, use Panasonic T-adaptor KX-J66 (To order, call 1-800-332-5368)

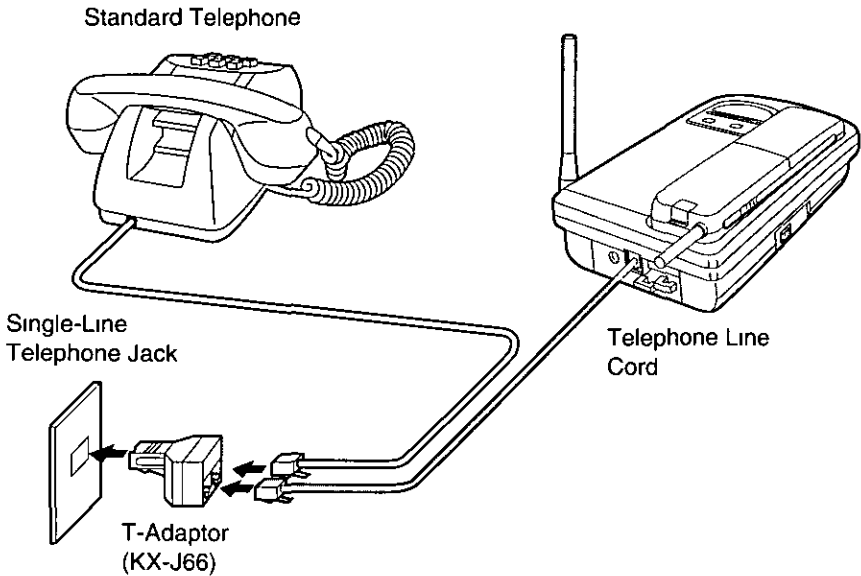

Important Safety Instructions



When using this unit, basic safety precautions as below should always be followed to reduce the risk of fire, electric shock, or personal injury.

1. Read and understand all instructions.
2. Follow all warnings and instructions marked on this unit.
3. Unplug this unit from wall outlets before cleaning. Do not use liquid or aerosol cleaners. Use a damp cloth for cleaning.
4. Do not use this unit near water, for example, near a bath tub, wash bowl, kitchen sink, or the like.
5. Install this unit securely on a stable surface. Serious damage may result if the unit falls.
6. Do not cover slots and openings of the unit, for they are provided for ventilation and protection against overheating. Never place the unit near radiators, in/or a place where proper ventilation is not provided.
7. Use only the power source as marked on the unit. If you are not sure of the type of the power supply to your home, consult your dealer or local power company.
8. Do not place objects on the power cord. Install the unit where no one can step on the cord.
9. Do not overload wall outlets and extension cords as this can result in the risk of fire or electric shock.
10. Never push any objects into this unit through slots as they may result in risk of fire or electric shock. Never spill any liquid on the unit.
11. To reduce the risk of electric shock, do not disassemble this unit, but take it to a qualified serviceman when some service or repair work is required. Opening or removing covers may expose you to dangerous voltages or other risks. Incorrect reassembly can cause electric shock when the appliance is subsequently used.
12. Unplug this unit from the wall outlet and refer servicing to qualified service personnel under the following conditions:
 - A. When the power supply cord or plug is damaged or frayed.
 - B. If liquid has been spilled into the unit.
 - C. If the unit has been exposed to rain or water.
 - D. If the unit does not work normally by following the operating instructions. Adjust only controls covered by the operating instructions, for improper adjustment may require extensive work by a qualified technician.
 - E. If the unit has been dropped or damaged.

Important Safety Instructions

- F If the unit exhibits a distinct change in performance
- 13 During thunderstorms, avoid using telephones except cordless types. There may be a remote risk of electric shock from lightning.
- 14 Do not use this unit to report a gas leak in the vicinity of it
- 5 Charge the battery(ies) provided with or identified for use with this product only in accordance with the instructions and limitations specified in this manual

WARNING:

TO PREVENT FIRE OR SHOCK HAZARD, DO NOT EXPOSE THIS PRODUCT TO RAIN OR ANY TYPE OF MOISTURE

SAVE THESE INSTRUCTIONS

CAUTION:

To reduce the risk of fire or injury to persons, read and follow these instructions

- 1 Use only the battery(ies) instructed
- 2 Do not dispose of the battery(ies) in a fire. The cell may explode. Check with local codes for possible special disposal instructions
- 3 Do not open or mutilate the battery(ies). Released electrolyte is corrosive and may cause damage to the eyes or skin. It may be toxic if swallowed
- 4 Exercise care in handling batteries in order not to short the battery with conducting materials such as rings, bracelets, and keys. The battery or conductor may overheat and cause burns

FCC and Other Information



If required by the telephone company, inform them as follows:

FCC Registration No.....
(found on the bottom of the unit)
Ringer Equivalence0.2B

The particular telephone line to which the equipment is connected.

This unit must not be connected to a coin operated line.

If you are on a party line, check with your local telephone company.

Ringer Equivalence No. (REN):

The REN is useful in determining the quantity of devices you may connect to your telephone line and still have all of those devices ring when your telephone number is called. In most, but not all areas, the sum of the REN's of all devices connected to one line should not exceed five (5.0). To be certain of the number of devices you may connect to your line, as determined by the REN, you should contact your local telephone company to determine the maximum REN for your calling area.

In the event terminal equipment causes harm to the telephone network, the telephone company should notify the customer, if possible, that service may be stopped.

However, where prior notice is impractical, the company may temporarily cease service providing that they:

- (a) Promptly notify the customer.
- (b) Give the customer an opportunity to correct the problem with their equipment.

- (c) Inform the customer of the right to bring a complaint to the Federal Communication Commission pursuant to procedures set out in FCC Rules and Regulations Subpart E of Part 68.

The Telephone Company may make changes in its communications facilities, equipment, operations or procedures, where such action is reasonably required in the operation of its business and is not inconsistent with the rules and regulations in FCC Part 68.

If such changes can be reasonably expected to render any customer terminal equipment incompatible with telephone company communications facilities, or require modification or alteration of such terminal equipment, or otherwise materially affect its use or performance, the customer shall be given adequate notice in writing, to allow the customer an opportunity to maintain uninterrupted service.

When programming emergency numbers and/or making test calls to emergency numbers:

1. Remain on the line and briefly explain to the dispatcher the reason for the call before hanging up.
2. Perform such activities in the off-peak hours, such as early morning hours or late evenings.

CAUTION:

Any changes or modifications not expressly approved by the party responsible for compliance could void the user's authority to operate this device.

➔ FCC and Other Information

This device complies with Part 15 of the FCC Rules. Operation is subject to the following two conditions: (1) This device may not cause harmful interference, and (2) this device must accept any interference received, including interference that may cause undesired operation.

Privacy of communications may not be ensured when using this phone.

Note:

This equipment has been tested and found to comply with the limits for a Class B digital device, pursuant to Part 15 of the FCC Rules. These limits are designed to provide reasonable protection against harmful interference in a residential installation. This equipment generates, uses, and can radiate radio frequency energy and, if not installed and used in accordance with the instructions, may cause harmful interference to radio communications. However, there is no guarantee that interference will not occur in a particular installation. If this equipment does cause harmful interference to radio or television reception, which can be determined by turning the equipment off and on, the user is encouraged to try to correct the interference by one or more of the following measures:

- Reorient or relocate the receiving antenna.
- Increase the separation between the equipment and receiver.
- Connect the equipment into an outlet on a circuit different from that to which the receiver is connected.
- Consult the dealer or an experienced radio/TV technician for help.

- **Environment** — do not place the unit in room where the temperature is less than 5°C (41°F) or greater than 40°C (104°F). Allow 10 cm (4") clearance around the unit for proper ventilation. Avoid excessive smoke, dust, mechanical vibration, shock, or direct sunlight.
- **Routine care** — wipe the unit with a soft cloth. Do not use benzine, thinner, or any abrasive powder. When you left the unit unused for long time, unplug the AC adaptor from the outlet.
- **If there is any trouble** — disconnect the unit from the telephone line and connect a known working phone. If the known working phone operates properly, have your unit repaired by one of the authorized Panasonic Factory Service Centers. If the known working phone does not operate properly, consult with your telephone company.

- This cordless telephone is designed for use in the United States of America. Sale or use of this product in other countries may violate local laws.
- Ce téléphone sans fil est conçu pour être utilisé aux États-Unis d'Amérique. La vente ou l'emploi de cet appareil dans certains autres pays peut constituer une infraction à la législation locale.
- Este teléfono sin cordón fue elaborado para uso en los Estados Unidos de América. La venta o el empleo de este producto en ciertos países puede constituir violación de la legislación local.
- このコードレス電話機は、日本国外での使用を目的として設計されており、日本国内での使用は法律違反となります。従って、当社では日本国内においては原則として修理などのサービスは致しかねます。

For product service

- Panasonic Servicenters are listed in the servicenter directory
- Call 1-800-545-2672 for the location of an authorized servicenter

When you ship the product

- Carefully pack your unit, preferably in the original carton
- Attach a letter, detailing the symptom, to the outside of the carton

Symptom

- Send the unit to an authorized servicenter, prepaid and adequately insured
- Do not send your unit to the Matsushita Consumer Electronics Company listed below or to executive or regional sales offices. These locations do not repair consumer products

**Matsushita Consumer Electronics Company,
Division of Matsushita Electric Corporation of America**
One Panasonic Way, Secaucus, New Jersey 07094

**Panasonic Sales Company ("PSC"),
Division of Matsushita Electric of Puerto Rico, Inc.**
Ave. 65 de Infantería, Km. 9.5, San Gabriel Industrial Park
Carolina, Puerto Rico 00985