

Panasonic

900MHz Cordless Phone

Model No. **KX-TC909-B**

Pulse-or-tone dialing capability

Operating Instructions



PLEASE READ BEFORE USE AND SAVE.

Charge the battery for about 15 hours before initial use.

Preparation

Basic Operation

Advanced Operation

Useful Information

Before Initial Use

Please read **IMPORTANT SAFETY INSTRUCTIONS** on pages 20-21 before use. Read and understand all instructions.

Thank you for purchasing the Panasonic cordless telephone.

Attach your purchase receipt here.

For your future reference

Serial No _____

Date of purchase _____

(found on the bottom of the unit)

Name and address of dealer _____

Accessories

AC Adaptor (p 7)

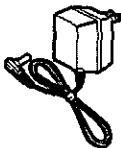

one

Telephone Line Cord (p 7)

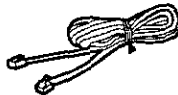

one

Wall Mounting Adaptor (p 9)

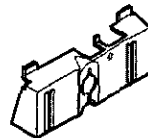

one

Battery (p 6)

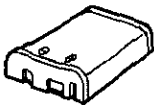

one

Handset Cover (p 6)



one

Cradle Cover (p 6)

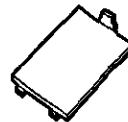

one

• To order accessories, call 1-800-332-5368

For Best Performance

Battery Charge

To power the handset, install the battery (p. 6) and charge it for about **15 hours** before initial use (p. 8).

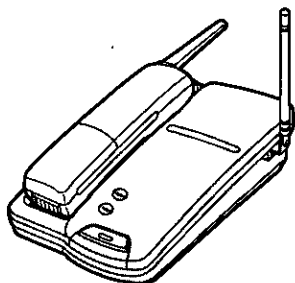

Operating Distance/Noise

Calls are transmitted between the base unit and the handset using wireless radio waves. **For maximum distance and noise free operation**, the recommended base unit location is:

Away from electrical appliances such as a TV, radio, or personal computer.

In a **HIGH and CENTRAL** location with no obstructions such as walls.

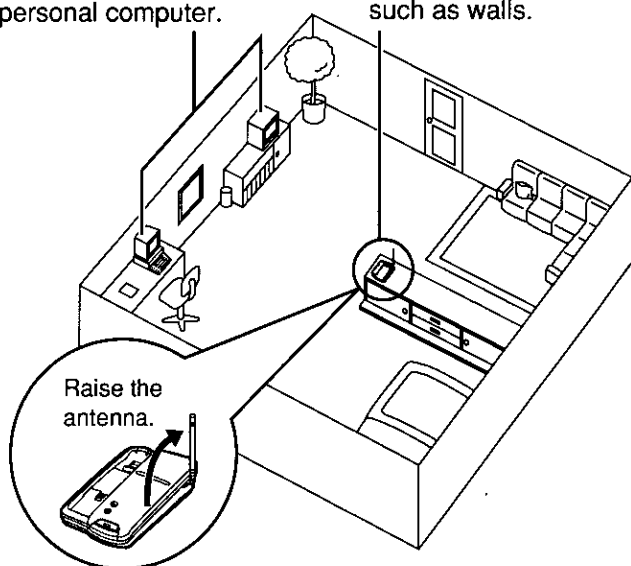

Contents

Preparation

Location of Controls	5
Setting Up	6
Installing the Battery in the Handset	6
Installing the Cradle Cover on the Base Unit	6
Connection	7
Battery Charge	8
Wall Mounting	9

Basic Operation

Making Calls	10
Answering Calls	11
Automatic Dialing	12
Storing Phone Numbers in Memory	12
Dialing a Stored Number	13

Advanced Operation

Special Features	14
One-Touch Dialing	14
Handset Locator	15
For Call Waiting Service Users	15
Automatic Security Code Setting	15
Temporary Tone Dialing (For Rotary Service Users)	15
If Your Unit is Connected to a PBX	15

Useful Information

Optional Spare Battery	16
Before Requesting Help	18
Adding Another Phone	19
Important Safety Instructions	20
FCC and Other Information	22

Location of Controls

Handset

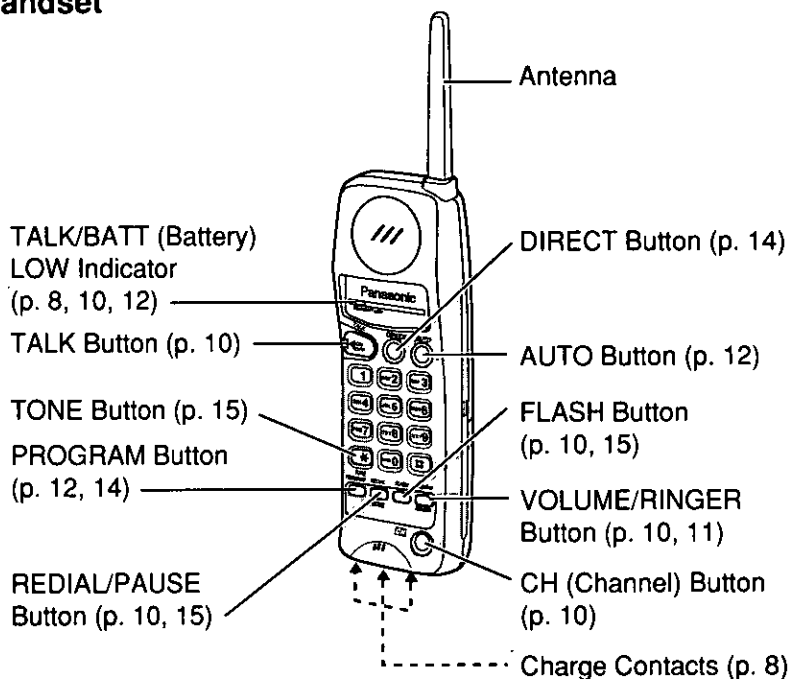

Base unit

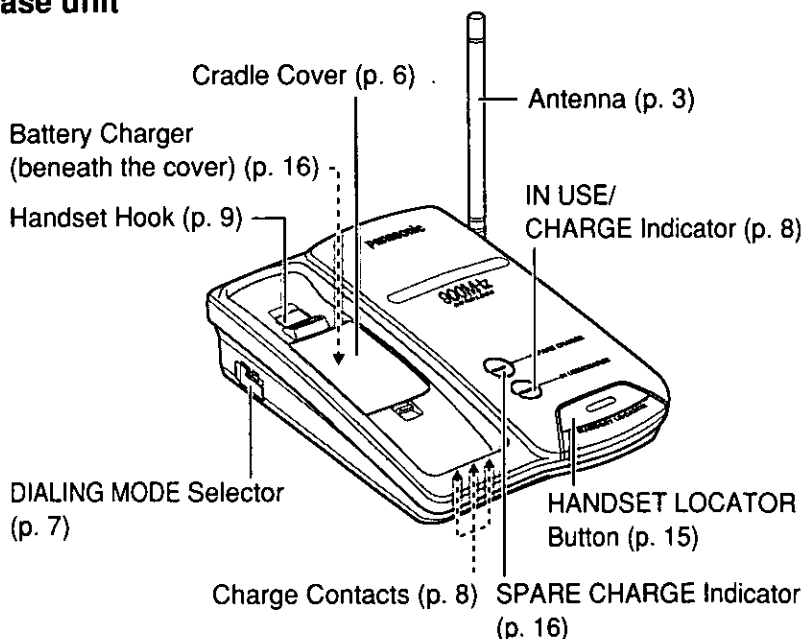

Setting Up

Installing the Battery in the Handset

Install the battery as shown observing the proper polarity. Then install the handset cover.

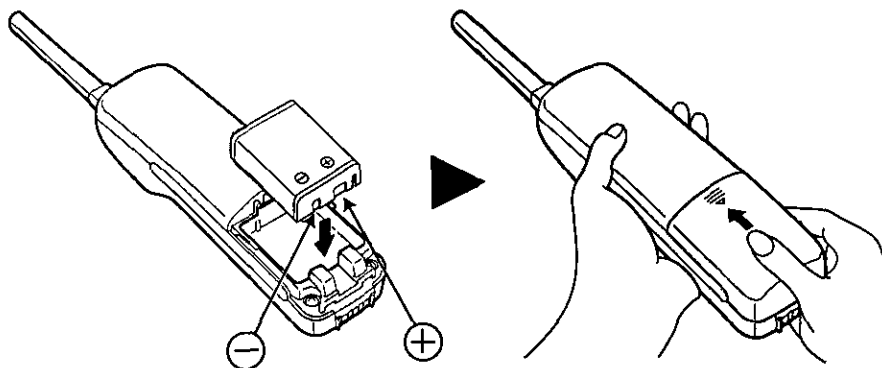

Installing the Cradle Cover on the Base Unit

Close the cradle cover as shown.

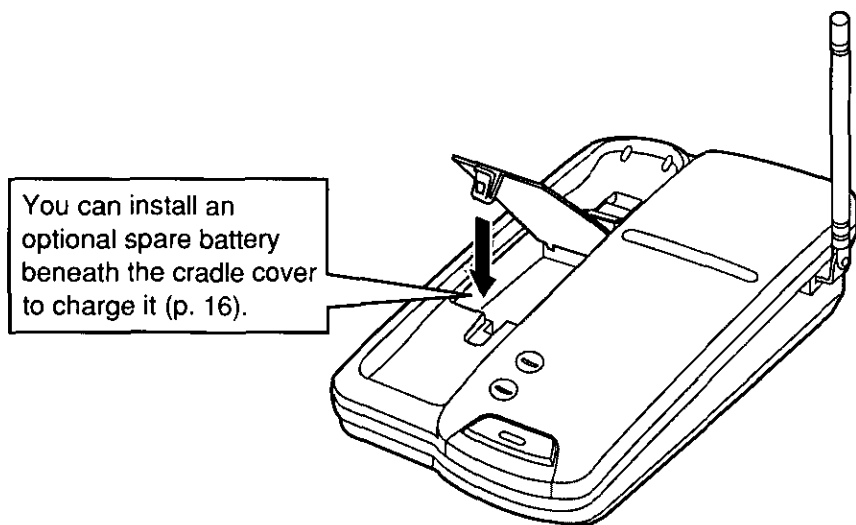

Connection

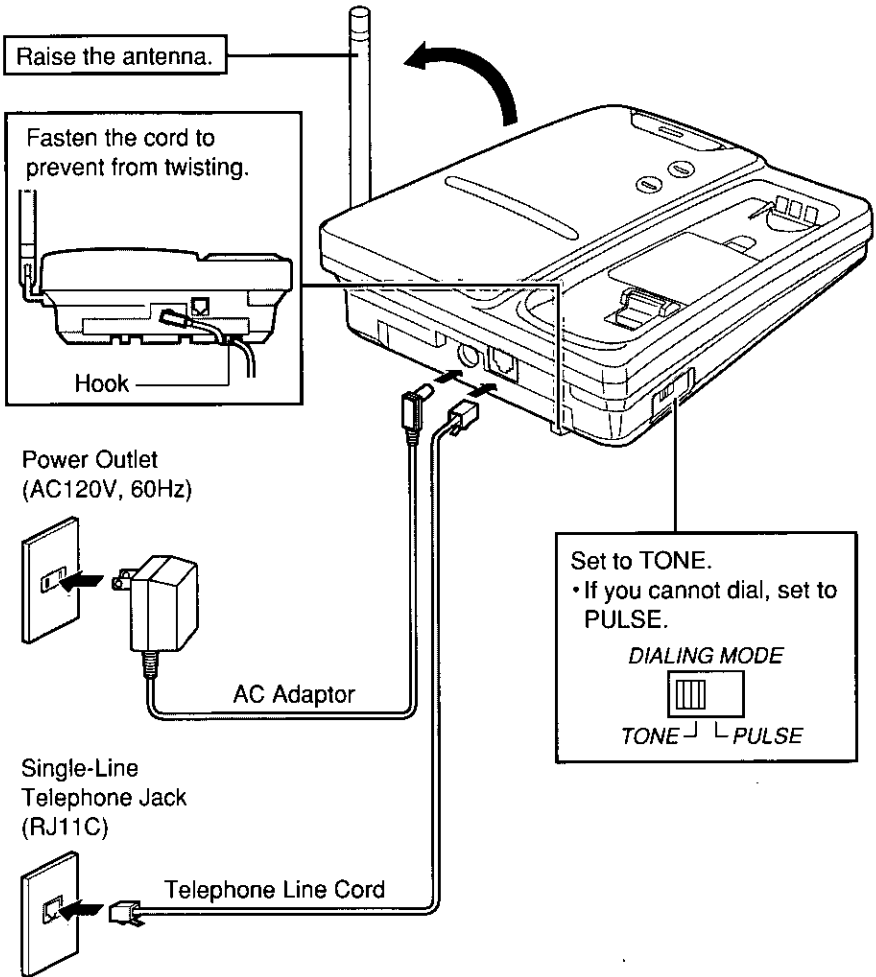

- USE ONLY Panasonic AC ADAPTOR KX-A09.
- The AC adaptor must remain connected at all times. (It may feel warm during use. This is normal.)
- If you connect a reserve telephone on the same line, see page 19.

➔ Setting Up

Battery Charge

Place the handset on the base unit for about **15 hours**.

- The IN USE/CHARGE indicator lights.

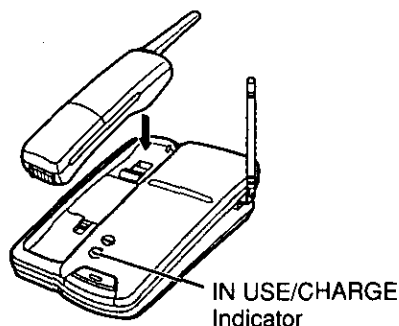

Recharge

When the TALK/BATT LOW indicator flashes slowly or the unit beeps intermittently, recharge the battery.

If you do not want to wait until the battery is fully recharged, we recommend you purchase an optional spare battery (page 16).

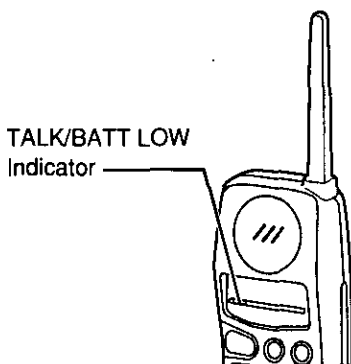

Standard battery life

If your Panasonic battery is fully charged;

While in use (TALK)	Up to about 4.5 hours
While not in use (Stand-By)	Up to about 14 days

- Battery life may vary depending on usage conditions and ambient temperature.
- **Clean the handset and the base unit charge contacts with a dry soft cloth once a month**, or the battery may not charge properly.
- Once the battery is fully charged, you do not have to place the handset on the base unit until the TALK/BATT LOW indicator flashes slowly.
- The battery cannot be overcharged.

Wall Mounting

This unit can be mounted on a wall phone plate.

- 1** Pull down the handset hook so the tab holds the handset.

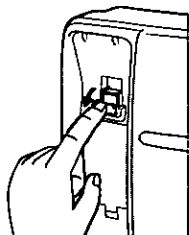

- 2** Connect the AC adaptor. Tuck the telephone line cord inside the wall mounting adaptor, then push it in the direction of the arrow.

- The word "UP" should face upward.

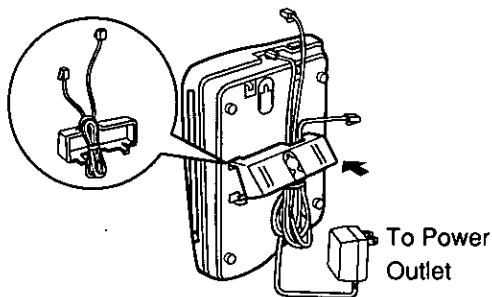

- 3** Connect the telephone line cord. Mount the unit, then slide down.

- Raise the antenna.

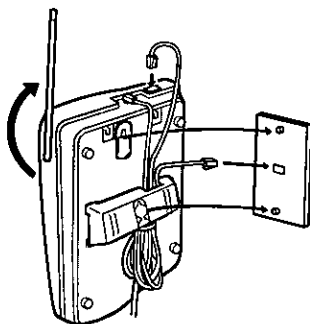

- 4** To charge the handset battery: Place the handset on the handset hook as shown.

- The IN USE/CHARGE indicator lights.

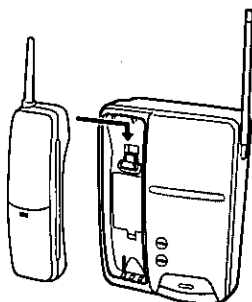

Making Calls

- 1 Press **TALK**
 - The TALK/BATT LOW indicator lights

- 2 Dial a telephone number
 - If you misdial, press **FLASH** firmly then dial again

- 3 To hang up, press **TALK** or place the handset on the base unit
 - The indicator light goes out

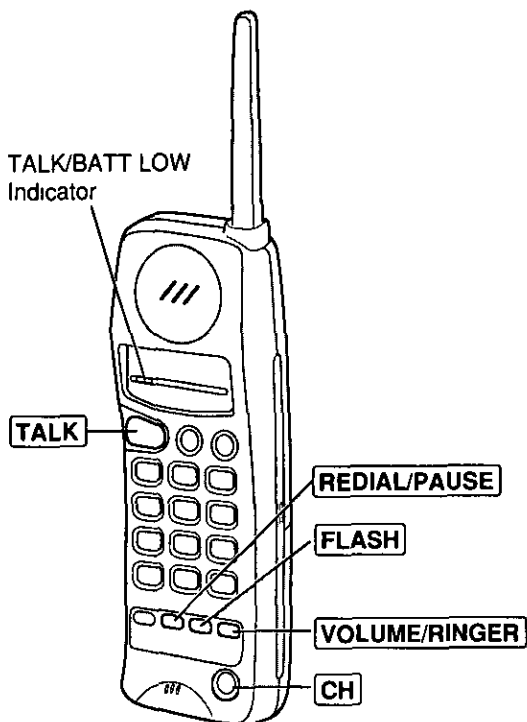

- If an alarm tone sounds in step 1, move toward the base unit or place the handset on the base unit Then try again

To redial the last number

Press **TALK** ➔ **REDIAL/PAUSE**

To select the receiver volume HIGH or NORMAL (preset)

Press **VOLUME/RINGER** while speaking

- Each time you press, the volume level will change

If noise interferes with the conversation

Press **CH** to select a clear channel or move closer to the base unit

Answering Calls

If the handset is off the base unit, press **TALK**.

- You can also answer a call by pressing any dialing button 0 to 9, *, or # (— **Any Key Talk**).

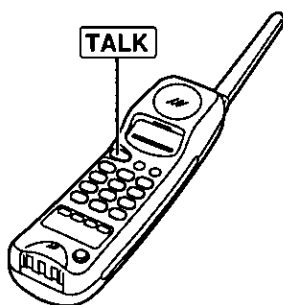

OR

If on the base unit, just lift it.

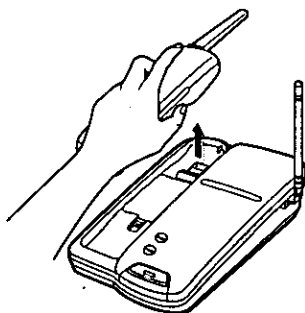

Adjusting the ringer volume

Be sure the TALK/BATT LOW indicator light is off.

- **To select HIGH (preset) or LOW**, press **VOLUME/RINGER**.
(Each time you press, the ringer volume will change.)
- **To turn the ringer OFF**, while pressing **VOLUME/RINGER**, press **0** until 2 beeps sound.
- **To turn the ringer ON**, press **VOLUME/RINGER**. The ringer sounds at the HIGH level.

Selecting the ringer tone (2 types)

When the TALK/BATT LOW indicator light is off, press **VOLUME/RINGER** then press ***** within 5 seconds. The selected ringer tone sounds.

Automatic Dialing

Storing Phone Numbers in Memory

You can store up to 10 phone numbers in memory stations of the handset. The dialing buttons (0 to 9) function as memory stations. The TALK/BATT LOW indicator light must be off.

- 1 Press **PROGRAM**
 - The TALK/BATT LOW indicator flashes
- 2 Enter a phone number up to 16 digits
 - If you misdial, press **PROGRAM** to end storing, then restart from step 1
- 3 Press **AUTO**
- 4 Press a memory station number (0 to 9)
 - A confirmation tone sounds (See below)
 - To store other numbers, repeat steps 1 through 4

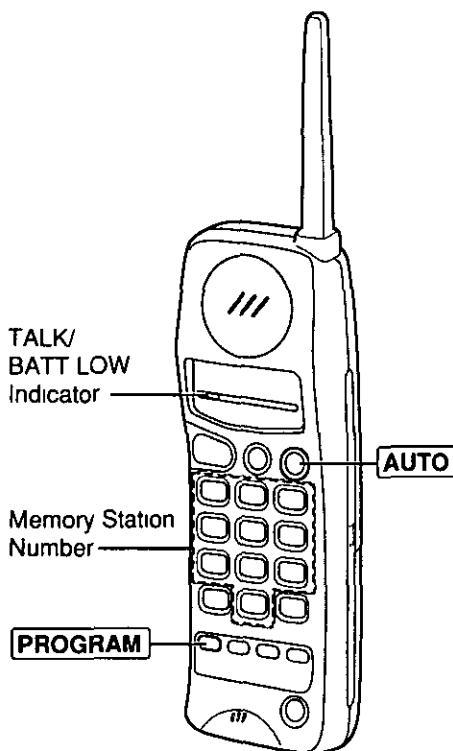

What the confirmation tone means

- 1 beep The new number is stored
- 2 beeps The number is the same as a previously stored one

To erase a stored number

Press **PROGRAM** ⇒ **AUTO** ⇒ the memory station number (for the phone number to be erased).

Memory sticker

Use the included memory sticker as a name or phone number index for automatic dialing. Attach the sticker to the unit or in a convenient place.

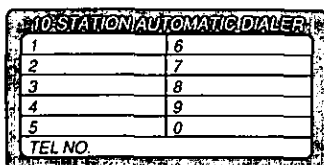

Dialing a Stored Number

- 1 Press **TALK**.
- 2 Press **AUTO**.
- 3 Press the memory station number (0 to 9).
 - The stored number is dialed.

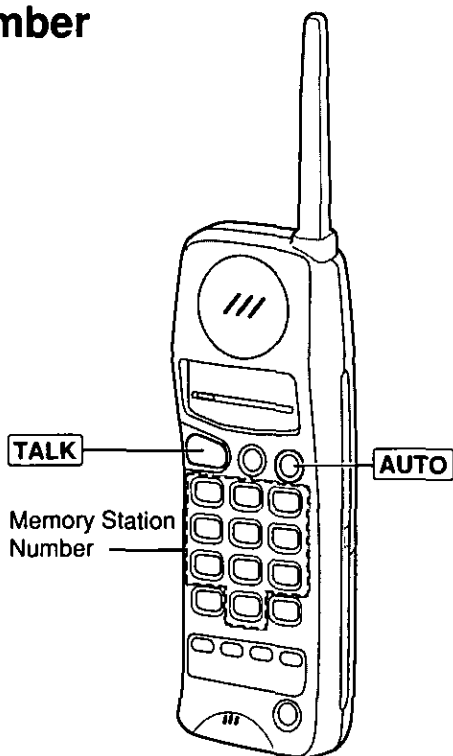

Special Features

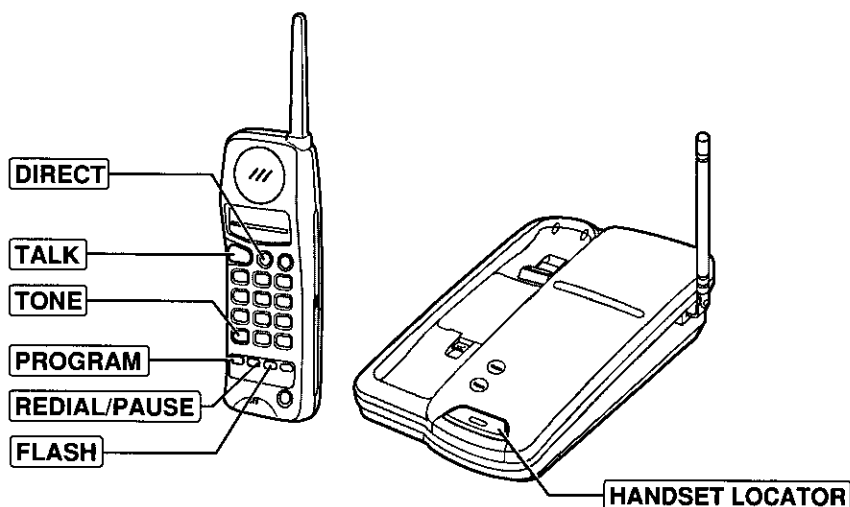

One -Touch Dialing

You can store a phone number in the DIRECT button. The stored number is dialed with a one-touch operation.

To store a phone number in memory

- 1 Press **PROGRAM** when the TALK/BATT LOW indicator light is off
 - The indicator starts to flash
- 2 Enter a phone number up to 16 digits
 - If you misdial, press **PROGRAM**, then restart from step 1
- 3 Press **DIRECT**
 - A confirmation tone sounds (See page 12)

To dial a stored number

- 1 Press **TALK**
- 2 Press **DIRECT**
 - The stored number is dialed

• To erase a stored number; Press **PROGRAM** ➔ **DIRECT**

Handset Locator

From the base unit you can locate the handset or page a person at the handset with beep tones

- 1 Press **HANDSET LOCATOR**
 - The IN USE/CHARGE indicator flashes and the handset beeps for 1 minute
- 2 To stop paging, press **HANDSET LOCATOR** again or press **TALK** twice on the handset

For Call Waiting Service Users

Press **FLASH** lightly if you hear a call-waiting tone while talking

- The first call is put on hold and you can answer the second call
- To return to the first caller, press **FLASH** again

Automatic Security Code Setting

Whenever you place the handset on the base unit, the unit automatically selects one of a million security codes. These codes help to avoid unauthorized use of your telephone line by another cordless telephone

Temporary Tone Dialing (For Rotary Service Users)

Press **TONE** before entering access numbers which require tone dialing

- The dialing mode changes to tone. You can enter numbers to access answering systems, electronic banking services, etc. When you hang up, the mode returns to pulse

If Your Unit is Connected to a PBX

We recommend you press **REDIAL/PAUSE** between the access number for an outside line and the phone number

- Pressing **REDIAL/PAUSE** once creates a 3.5 second pause. This prevents misdialing when you redial or dial a stored number (**REDIAL/PAUSE** counts as one digit)

Optional Spare Battery

When the handset battery needs charging, replace it with a fully charged optional spare battery. This eliminates having to wait for the handset battery to recharge. **Please purchase a Panasonic P-P592 (KX-A92) battery** and install it in the base unit to charge.

Installing the spare battery in the base unit

- 1 Open the cradle cover by pushing the tab and lifting the cover

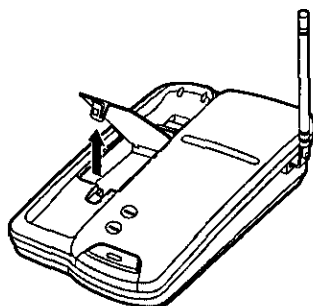

- 2 Install the spare battery as shown observing the proper polarity, then close the cradle cover

- The SPARE CHARGE indicator lights

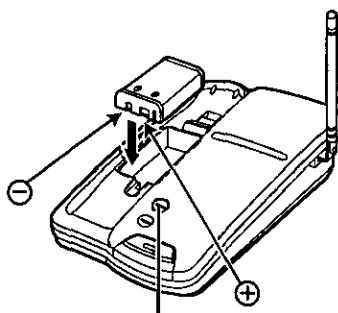

SPARE CHARGE Indicator

The spare battery is always being charged in the base unit while the AC adaptor is connected. The battery cannot be overcharged.

Attention:

The product that you have purchased contains a rechargeable battery. The battery is recyclable. At the end of its useful life, under various state and local laws, it may be illegal to dispose of this battery into the municipal waste stream. Check with your local solid waste officials for details in your area for recycling options or proper disposal.



Replacing the handset battery with the spare battery

To prevent memory loss, replace within 5 minutes.

- 1 Remove the handset cover, then remove the battery.

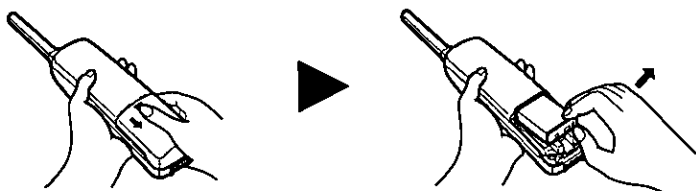

- 2 Replace the handset battery with the spare battery in the base unit.

- ① Remove the spare battery.
- ② Insert the handset battery in the base unit observing the proper polarity.

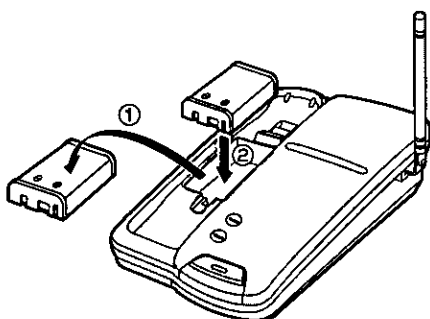

- 3 Install the spare battery in the handset observing the proper polarity.

- When you finish, close the handset cover.

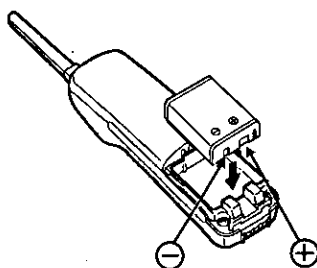

- If the TALK/BATT LOW indicator flashes slowly even when the handset battery has been fully charged, it is time to change the battery with a new one. Remember to fully charge the new battery after battery replacement.
- Please use only a Panasonic P-P592 (KX-A92) battery. For accessory order, call 1-800-332-5368.

Before Requesting Help

Problem	Remedy
An alarm tone sounds when you press TALK .	<ul style="list-style-type: none">• You are too far from the base unit. Move closer and try again.• Place the handset on the base unit and try again.• Plug in the AC adaptor.
An alarm tone sounds continuously while using the handset.	<ul style="list-style-type: none">• Move closer to the base unit quickly, or the call will be terminated within 60 seconds.• Plug in the AC adaptor.
The unit does not work.	<ul style="list-style-type: none">• Check the setting (p. 6-8)• Charge the battery fully.• Clean the charge contacts and charge again.
Static, sound cuts in/out, fades. Interference from other electrical units.	<ul style="list-style-type: none">• Set the handset and the base unit away from electrical appliances.• Move closer to the base unit.• Raise the base unit antenna.• Press CH to change the channel.
The unit stops working during operation.	<ul style="list-style-type: none">• Place the handset on the base unit and unplug the AC adaptor to reset. Plug in, then try again.
The handset does not ring.	<ul style="list-style-type: none">• The ringer volume is set to OFF. Press VOLUME/RINGER when the TALK/BATT LOW indicator light is off.
You cannot store a phone number in memory.	<ul style="list-style-type: none">• You cannot store a number while the unit is in the talk mode.• Do not pause for over 30 seconds while storing.
While storing a phone number, the unit starts to ring.	<ul style="list-style-type: none">• To answer a call, press TALK. The program will be canceled; store the number again.
HANDSET LOCATOR does not function.	<ul style="list-style-type: none">• The handset is too far from the base unit or is engaged in an outside call.

Problem	Remedy
<p>REDIAL/PAUSE does not function properly.</p>	<ul style="list-style-type: none"> • The button will redial the last number dialed if pressed at the outset of a call (p. 10). If another number has been dialed first, it will operate as a pause button (p. 15).
<p>The TALK/BATT LOW indicator flashes slowly or the unit beeps intermittently.</p>	<ul style="list-style-type: none"> • Charge the battery fully or replace with a fully charged optional spare battery (p. 8, 16).
<p>You charged the battery fully, but the TALK/BATT LOW indicator flashes slowly.</p>	<ul style="list-style-type: none"> • Clean the charge contacts and charge again. • It is time to change the battery. Please purchase a new battery (p. 16).
<p>The IN USE/CHARGE indicator and/or the SPARE CHARGE indicator light never goes out while charging.</p>	<ul style="list-style-type: none"> • This is normal.
<p>If you cannot solve your problem.</p>	<ul style="list-style-type: none"> • Call our customer satisfaction center at 201-348-9090.

Adding Another Phone

This unit will not function during a power failure. To connect a standard telephone on the same line, use Panasonic T-adaptor KX-J66. (To order, call 1-800-332-5368.)

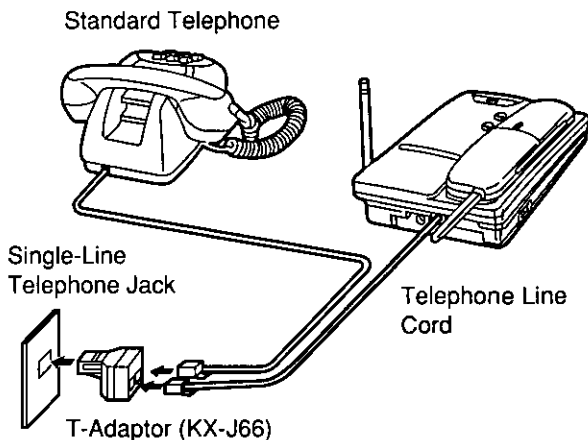

Important Safety Instructions

When using this unit, basic safety precautions should always be followed to reduce the risk of fire, electric shock, or personal injury.

1. Read and understand all instructions.
2. Follow all warnings and instructions marked on this unit.
3. Unplug this unit from AC outlets before cleaning. Do not use liquid or aerosol cleaners. Use a damp cloth for cleaning.
4. Do not use this unit near water, for example, near a bath tub, wash bowl, kitchen sink, or the like.
5. Place this unit securely on a stable surface. Serious damage and/or injury may result if the unit falls.
6. Do not cover slots and openings on the unit. They are provided for ventilation and protection against overheating. Never place the unit near radiators, or in a place where proper ventilation is not provided.
7. Use only the power source marked on the unit. If you are not sure of the type of power supplied to your home, consult your dealer or local power company.
8. Do not place objects on the power cord. Install the unit where no one can step or trip on the cord.
9. Do not overload wall outlets and extension cords. This can result in the risk of fire or electric shock.
10. Never push any objects through slots in this unit. This may result in the risk of fire or electric shock. Never spill any liquid on the unit.
11. To reduce the risk of electric shock, do not disassemble this unit. Take the unit to an authorized servicer when service is required. Opening or removing covers may expose you to dangerous voltages or other risks. Incorrect reassembly can cause electric shock when the unit is subsequently used.
12. Unplug this unit from the wall outlet and refer servicing to an authorized servicer when the following conditions occur:
 - A. When the power supply cord or plug is damaged or frayed.
 - B. If liquid has been spilled into the unit.
 - C. If the unit has been exposed to rain or water.
 - D. If the unit does not work normally by following the operating instructions. Adjust only controls covered by the operating instructions. Improper adjustment may require extensive work by an authorized servicer.
 - E. If the unit has been dropped or physically damaged.
 - F. If the unit exhibits a distinct change in performance.
13. During thunderstorms, avoid using telephones except cordless types. There may be a remote risk of an electric shock from lightning.
14. Do not use this unit to report a gas leak, when in the vicinity of the leak.

SAVE THESE INSTRUCTIONS

CAUTION:

To reduce the risk of fire or injury to persons, read and follow these instructions

- 1 Use only the battery(ies) specified
- 2 Do not dispose of the battery(ies) in a fire. They may explode. Check with local waste management codes for special disposal instructions
- 3 Do not open or mutilate the battery(ies). Released electrolyte is corrosive and may cause burns or injury to the eyes or skin. The electrolyte may be toxic if swallowed
- 4 Exercise care in handling batteries in order not to short the battery to conductive materials such as rings, bracelets, and keys. The battery and/or conductor may overheat and cause burns
- 5 Charge the battery(ies) provided with or identified for use with this product only in accordance with the instructions and limitations specified in this manual

WARNING:

TO PREVENT FIRE OR SHOCK HAZARD, DO NOT EXPOSE THIS PRODUCT TO RAIN OR ANY TYPE OF MOISTURE

FCC and Other Information

If requested by the telephone company, inform them as follows:

FCC Registration No.(found on the bottom of the unit)

Ringer Equivalence0.2B

The particular telephone line to which the equipment is connected.

This unit must not be connected to a coin operated line.

If you are on a party line, check with your local telephone company.

Ringer Equivalence No. (REN):

The REN is useful in determining the quantity of devices you may connect to your telephone line and still have all of those devices ring when your telephone number is called. In most, but not all areas, the sum of the REN's of all devices connected to one line should not exceed five (5.0). To be certain of the number of devices you may connect to your line, as determined by the REN, you should contact your local telephone company to determine the maximum REN for your calling area.

In the event terminal equipment causes harm to the telephone network, the telephone company should notify the customer, if possible, that service may be stopped.

However, where prior notice is impractical, the company may temporarily cease service providing that they:

- (a) Promptly notify the customer.
- (b) Give the customer an opportunity to correct the problem with their equipment.
- (c) Inform the customer of the right to bring a complaint to the Federal Communication Commission pursuant to procedures set out in FCC Rules and Regulations Subpart E of Part 68.

The Telephone Company may make changes in its communications facilities, equipment, operations or procedures, where such action is reasonably required in the operation of its business and is not inconsistent with the rules and regulations in FCC Part 68.

If such changes can be reasonably expected to render any customer terminal equipment incompatible with telephone company communications facilities, or require modification or alteration of such terminal equipment, or otherwise materially affect its use or performance, the customer shall be given adequate notice in writing, to allow the customer an opportunity to maintain uninterrupted service.

When programming emergency numbers and/or making test calls to emergency numbers:

1. Remain on the line and briefly explain to the dispatcher the reason for the call before hanging up.
2. Perform such activities in the off-peak hours, such as early morning hours or late evenings.

This device complies with Part 15 of the FCC Rules. Operation is subject to the following two conditions: (1) This device may not cause harmful interference, and (2) this device must accept any interference received, including interference that may cause undesired operation.

CAUTION

Any changes or modifications not expressly approved by the party responsible for compliance could void the user's authority to operate this device.

Note

This equipment has been tested and found to comply with the limits for a Class B digital device, pursuant to Part 15 of the FCC Rules. These limits are designed to provide reasonable protection against harmful interference in a residential installation. This equipment generates, uses, and can radiate radio frequency energy and, if not installed and used in accordance with the instructions, may cause harmful interference to radio communications. However, there is no guarantee that interference will not occur in a particular installation. If this equipment does cause harmful interference to radio or television reception, which can be determined by turning the equipment off and on, the user is encouraged to try to correct the interference by one or more of the following measures:

- Reorient or relocate the receiving antenna
- Increase the separation between the equipment and receiver
- Connect the equipment into an outlet on a circuit different from that to which the receiver is connected
- Consult the dealer or an experienced radio/TV technician for help

Some cordless telephones operate at frequencies that may cause interference to nearby TVs and VCRs. To minimize or prevent such interference, the base of the cordless telephone should not be placed near or on top of a TV or VCR. If interference is experienced, move the cordless telephone further away from the TV or VCR. This will often reduce or eliminate interference.

Privacy of communications may not be ensured when using this phone.

- **Environment** — do not place the unit in room where the temperature is less than 5°C (41°F) or greater than 40°C (104°F). Allow 10 cm (4") clearance around the unit for proper ventilation. Avoid excessive smoke, dust, mechanical vibration, shock, or direct sunlight.
- **Routine care** — wipe the unit with a soft cloth. Do not use benzene, thinner, or any abrasive powder. When you leave the unit unused for long time, unplug the AC adaptor from the outlet.
- **If there is any trouble** — disconnect the unit from the telephone line and connect a known working phone. If the known working phone operates properly, have your unit repaired by one of the authorized Panasonic Factory Service Centers. If the known working phone does not operate properly, consult with your telephone company.

For product service

- Panasonic Servcenters are listed in the servicenter directory
- Call 1-800-545-2672 for the location of an authorized servicenter

When you ship the product

- Carefully pack your unit, preferably in the original carton
- Attach a letter, detailing the symptom, to the outside of the carton

Symptom

- Send the unit to an authorized servicenter, prepaid and adequately insured
- Do not send your unit to the Matsushita Consumer Electronics Company listed below or to executive or regional sales offices. These locations do not repair consumer products

- This cordless telephone is designed for use in the United States of America. Sale or use of this product in other countries may violate local laws
- Ce telephone sans fil est conçu pour être utilisé aux Etats-Unis d'Amérique. La vente ou l'emploi de cet appareil dans certains autres pays peut constituer une infraction à la législation locale
- Este telefono sin cordón fue elaborado para uso en los Estados Unidos de América. La venta o el empleo de este producto en ciertos países puede constituir violación de la legislación local
- このコードレス電話機は、日本国外での使用を目的として設計されており、日本国内での使用は法律違反となります。従って、当社では日本国内においては原則として修理などのサービスは致しかねます。

**Matsushita Consumer Electronics Company,
Division of Matsushita Electric Corporation of America**
One Panasonic Way, Secaucus, New Jersey 07094

**Panasonic Sales Company ("PSC"),
Division of Matsushita Electric of Puerto Rico, Inc**
Ave 65 de Infantería, Km 9.5, San Gabriel Industrial Park
Carolina, Puerto Rico 00985