

# Panasonic

900MHz Cordless Phone

Model No. **KX-TCC902-B**  
**KX-TCC902-W**

Pulse-or-tone dialing capability

## Operating Instructions



KX-TCC902-B

**PLEASE READ BEFORE USE  
AND SAVE.**

**Caller ID Compatible**

Charge the battery for about 15 hours before initial use.

*Preparation*

*Basic Operation*

*Advanced Operation*

*Useful Information*

# Before Initial Use

Please read IMPORTANT SAFETY INSTRUCTIONS on pages 44-45 before use. Read and understand all instructions.

*Thank you for purchasing the Panasonic cordless telephone.*

Caller ID and Visual Call Waiting (Call Waiting ID), where available, are telephone company services. After subscribing to Caller ID, this phone will display the caller's name and phone number. An added service, Visual Call Waiting, will display the second caller's name and phone number during call waiting.

Attach your purchase receipt here.

## For your future reference

Serial No.

Date of purchase

(found on the bottom of the unit)

Name and address of dealer

**Accessories** To order accessories, call 1-800-211-PANA(7262).

AC Adaptor (p. 12)  
Order No. KX-TCA1-G

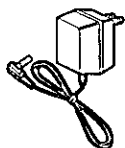

one

Telephone Line Cord (p. 12)



one

Wall Mounting Adaptor (p. 17)  
Order No. PQKL24Z0 (Black)  
PQKL24Y81 (White)

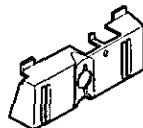

one

Battery (p. 11)  
Order No. P-P592  
(KX-A92)



one

Handset Cover (p. 11)

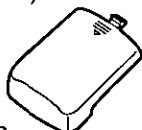

one

Cradle Cover (p. 11)



one

# For Best Performance

---

## Battery Charge

A rechargeable Ni-Cd battery powers the handset. Install the battery (p. 11) and charge it for about **15 hours** before initial use (p. 12).

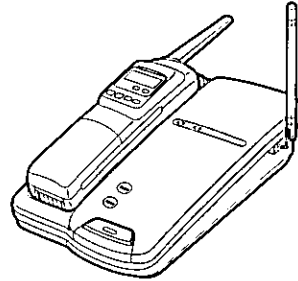

## Operating Distance/Noise

Calls are transmitted between the base unit and the handset using wireless radio waves. **For maximum distance and noise free operation, the recommended base unit location is:**

Away from electrical appliances such as a TV, radio or personal computer.

In a **HIGH** and **CENTRAL** location with no obstructions, such as walls.

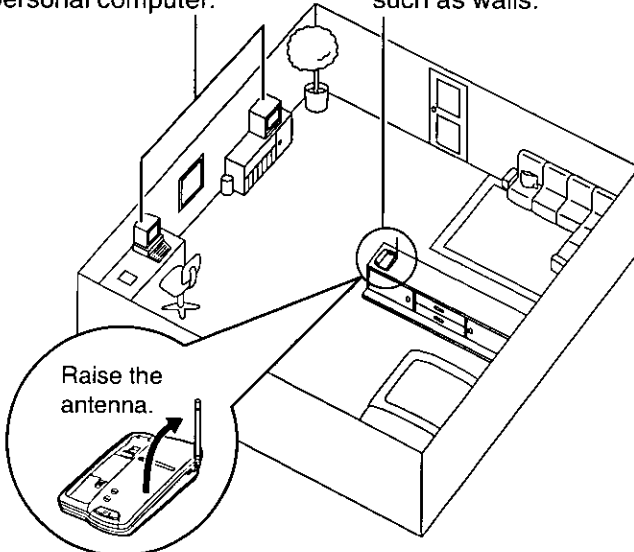

# Contents

---

## ***Preparation***

<b>Location of Controls</b> .....	6
<b>Handset Display</b> .....	9
<b>Settings</b> .....	11
Installing the Battery in the Handset .....	11
Installing the Cradle Cover on the Base Unit .....	11
Connections.....	12
Battery Charge .....	12
Selecting the Dialing Mode .....	14
Storing the Area Code .....	15
Setting the Auto Talk Feature .....	16
<b>Wall Mounting</b> .....	17

## ***Basic Operation***

<b>Making Calls</b> .....	18
<b>Answering Calls</b> .....	20
<b>Automatic Dialing</b> .....	22
Storing Phone Numbers in Memory .....	22
Dialing a Stored Number .....	25

## ***Advanced Operation***

<b>Caller ID Service</b> .....	26
<b>Using the Caller List</b> .....	28
Viewing the Caller List .....	28
Calling Back from the Caller List .....	30
Editing the Caller's Phone Number .....	31

Storing the Caller List Information in Automatic Dialing Memory .....	32
Erasing the Caller List Information .....	33
<b>Voice Mail Service .....</b>	<b>34</b>
<b>Special Features .....</b>	<b>36</b>
Handset Locator .....	36
One-Touch Dialing .....	37
For Call Waiting Service Users .....	38
Automatic Security Code Setting .....	38
Temporary Tone Dialing (For Rotary Pulse Service Users) .....	38
If Your Unit is Connected to a PBX (Analog Only) .....	38

*Preparation*

*Basic Operation*

***Useful Information***

<b>Optional Spare Battery .....</b>	<b>39</b>
<b>Before Requesting Help .....</b>	<b>41</b>
<b>Adding Another Phone .....</b>	<b>43</b>
<b>Important Safety Instructions .....</b>	<b>44</b>
<b>FCC and Other Information .....</b>	<b>46</b>

*Advanced Operation*

*Useful Information*

# Location of Controls

## Handset (Front side)

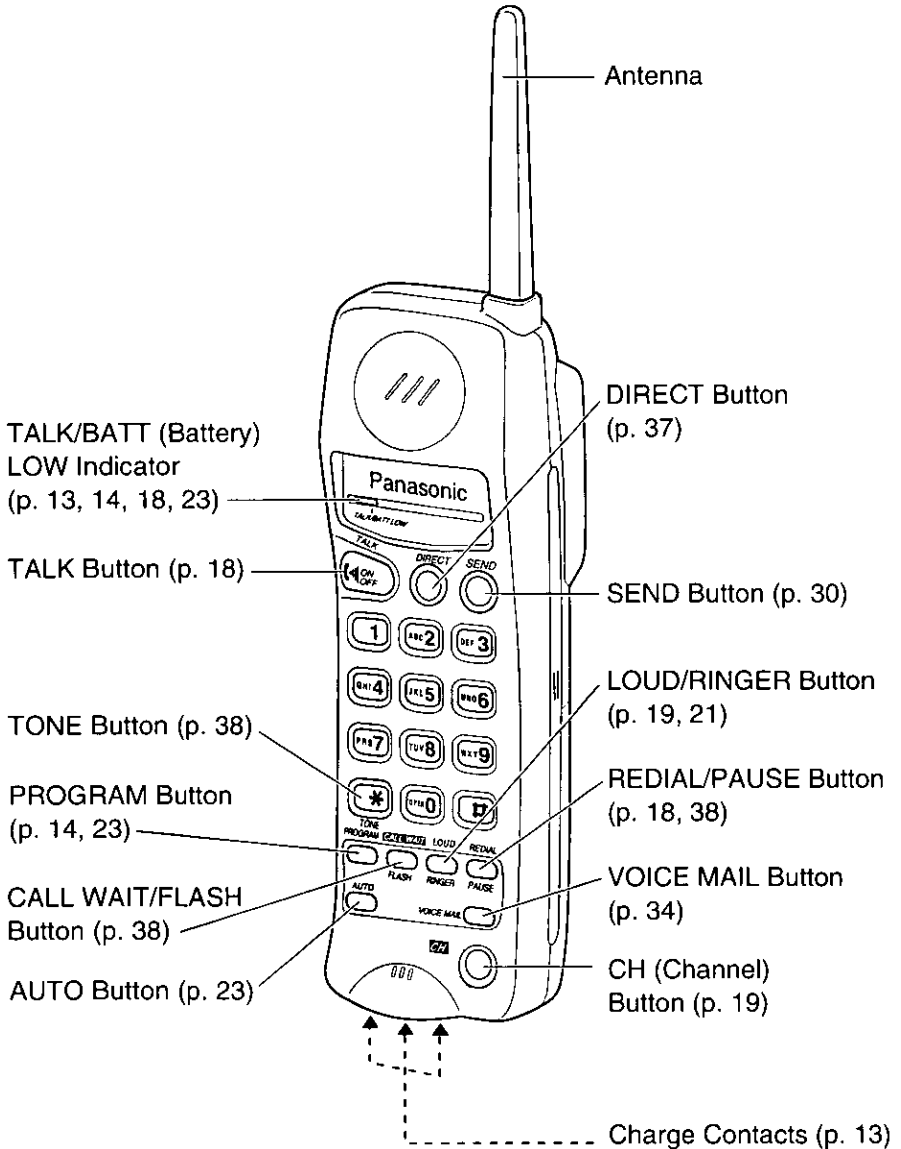



## Handset (Back side)

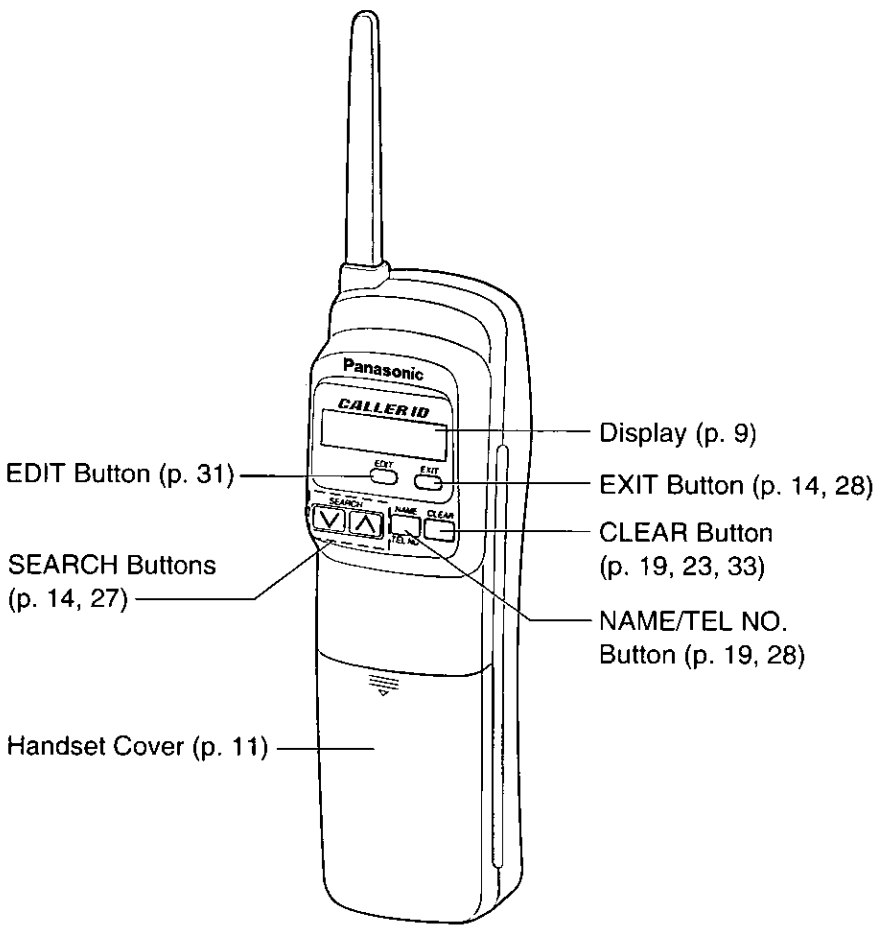

### Illuminated Search Keys

The **SEARCH** (∨, ∧) buttons use non-radioactive luminescent material which can absorb light energy of sunlight or lamps (incandescent, fluorescent, halogen, etc.), and release this absorbed light for darkened room operation.

- As the absorbed energy in the **SEARCH** (∨, ∧) buttons decreases, the button brightness will fade naturally.
- Button brightness and duration depend on the amount of room lighting and exposure time.

## ➔ Location of Controls

### Base unit

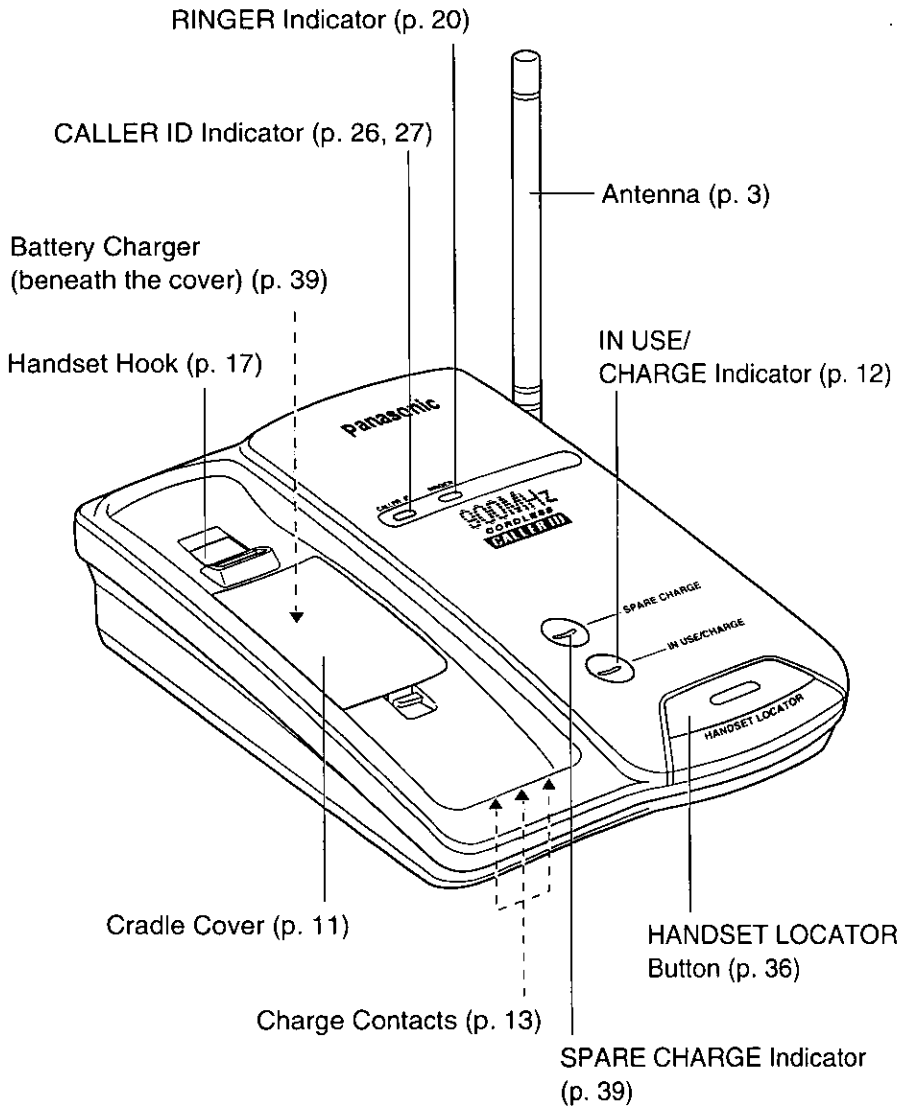



# Handset Display



The handset gives you instructions and information on the display. These display prompts are shown below.

NO CALLERS

The Caller List is empty.

12 NEW CALLS

The display shows the number of new calls while the handset is on the base unit.

12 NEW CALLS  
∨=NEW      ∧=OLD

This display will be shown when:

- you lift the handset off the base unit, or
- pressing **SEARCH** (∨ or ∧) when the handset is off the base unit.

To search from the most recent call, press **SEARCH** ∨ (NEW key). To search from the oldest call, press **SEARCH** ∧ (OLD key) (p. 28).

01-06-35 CH12

During a conversation, the display counts the length of the call (ex. 1 hour, 6 minutes and 35 seconds). The selected channel number is displayed.

OUT OF RANGE

The handset has lost communication with the base unit (p. 19).

SAVE ERROR

While programming, the handset lost communication with the base unit. Move closer to the base unit (p. 14, 34).

PAGING

The base unit is paging the handset (p. 36).

SUSAN HAMMER  
----WAITING----

A second call is received during a conversation (p. 38).

SUSAN HAMMER  
11:20A JAN12 ×3

This is a name from the Caller List. The time and date of the last call (ex. Jan. 12, 11:20 AM) and the number of times called (ex. 3 times) are displayed.

## ➔ Handset Display

---

OUT OF AREA

The caller dialed from an area which does not provide the Caller ID service.

PRIVATE CALLER

The caller has requested not to display their information.

END OF NEW CALL

You finished viewing the NEW CALLS in the Caller List. To exit, press **EXIT**.

END OF OLD CALL

You finished viewing the OLD CALLS in the Caller List. To exit, press **EXIT**.

END

You are at the end of the Caller List. To exit, press **EXIT**.

PLEASE LIFT UP  
AND TRY AGAIN

**SEARCH** (∨ or ∧) was pressed while the handset was on the base unit. Lift the handset and press **SEARCH** (∨ or ∧) again.

# Settings



## Installing the Battery in the Handset

Install the battery as shown observing the proper polarity.  
Then install the handset cover.

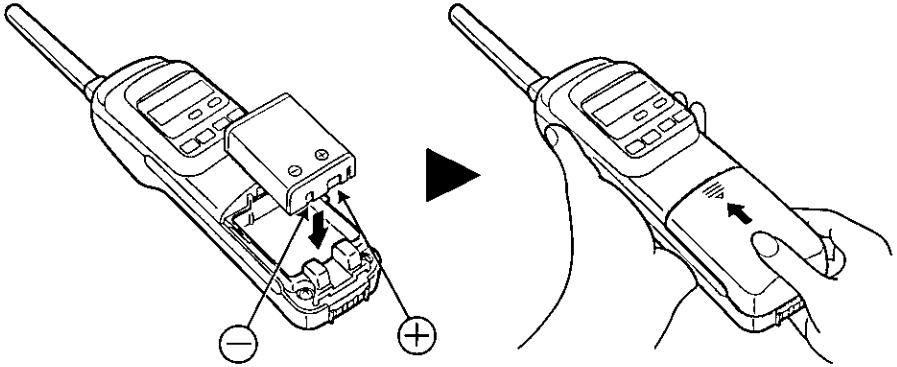

## Installing the Cradle Cover on the Base Unit

Close the cradle cover as shown.

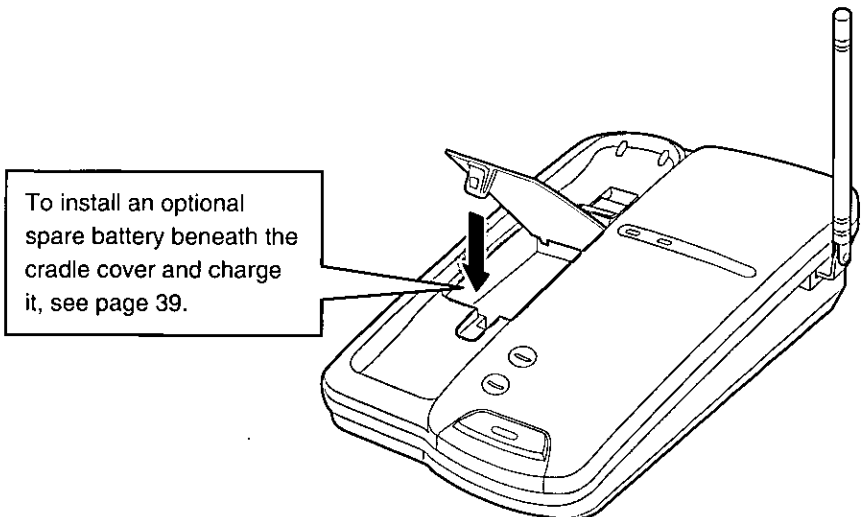

## Connections

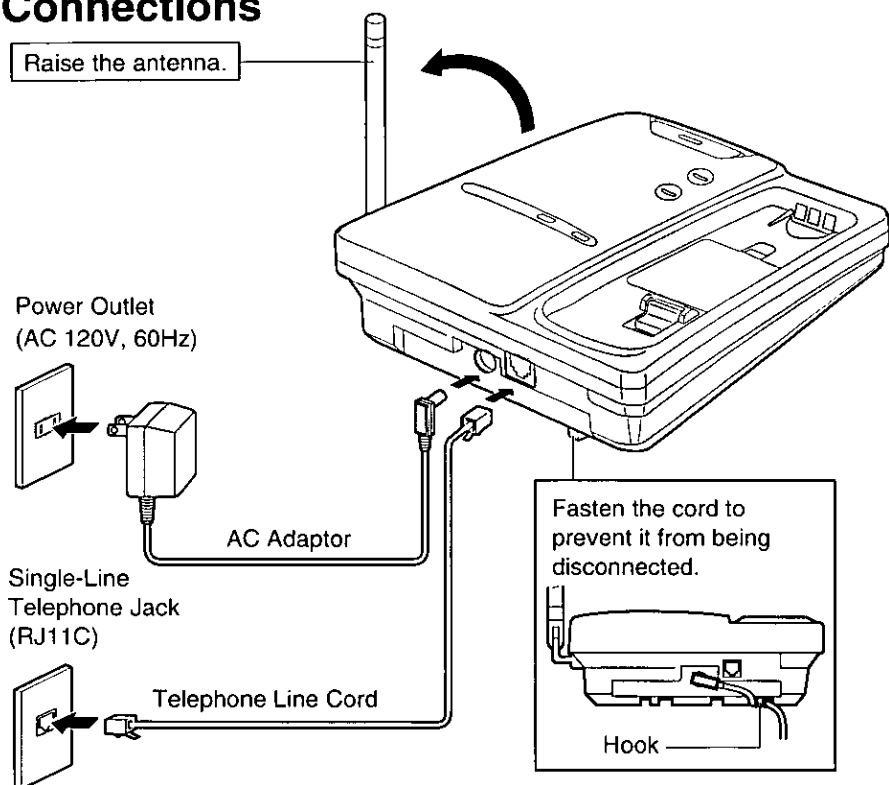

- USE ONLY Panasonic AC ADAPTOR KX-TCA1.
- The AC adaptor must remain connected at all times. (It is normal for the adaptor to feel warm during use.)
- To connect a standard telephone on the same line, see page 43.
- When the unit is connected to a PBX system, you cannot receive caller information.

## Battery Charge

Place the handset on the base unit and charge for about **15 hours** before initial use.

- The IN USE/CHARGE indicator lights.

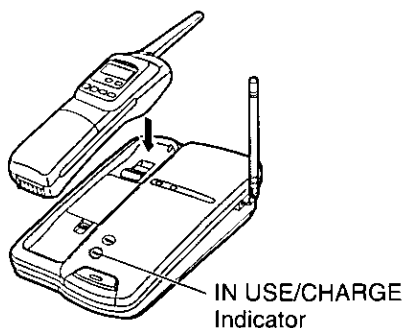



## Recharge

When the TALK/BATT LOW indicator flashes slowly or the unit beeps intermittently, recharge the battery.

- The TALK/BATT LOW indicator will continue to flash for at least 30 minutes once you begin recharging. This time will increase the more you use the handset while recharging.

TALK/BATT LOW Indicator

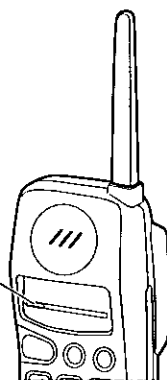

If you do not want to wait until the battery is fully recharged, we recommend you purchase an optional spare battery (page 39).

## Battery information

If your Panasonic battery is fully charged;

While in use (TALK)	Up to about 4.5 hours
While not in use (Stand-By)	Up to about 14 days

- Battery life may be shortened depending on usage conditions, such as viewing the Caller ID Caller List, and ambient temperature.
- **Clean the handset and the base unit charge contacts with a soft dry cloth once a month. Clean more often if the unit is subject to grease, dust or high humidity.** If not, the battery may not charge properly.
- A fully charged battery does not require the handset to be placed on the base unit until the TALK/BATT LOW indicator flashes slowly. This will maximize the battery life.
- The battery cannot be overcharged.

## Stand-by mode (The handset is off the base unit.)

The handset goes into the stand-by mode a few seconds after you finish using the handset (making a call, viewing the caller list, etc.).

The display is blank, but the handset can receive calls.

The battery life is conserved in this mode.

### Selecting the Dialing Mode

You can program the dialing mode **using the handset close to the base unit**. If you have touch tone service, set to TONE. If rotary pulse service is used, set to PULSE. The factory preset is TONE.

**The TALK/BATT LOW indicator light must be off before programming.**

1 Press **PROGRAM**.

- The TALK/BATT LOW indicator flashes.

```
SAVE AUTO# ?
v=NEXT      ^=YES
```

2 Press **SEARCH** v (NEXT key) 4 times until "SET DIAL MODE ?" is displayed.

```
SET DIAL MODE ?
v=NEXT      ^=YES
```

3 Press **SEARCH** ^ (YES key).

```
DIAL MODE
v=TONE      ^=PULSE
```

4 To select PULSE, press **SEARCH** ^.  
OR

To select TONE, press **SEARCH** v.

- A confirmation tone sounds.\*
- The selected mode is displayed.
- In a few seconds, the handset will return to the stand-by mode.

```
DIAL MODE
PULSE
```

```
DIAL MODE
TONE
```

- To cancel, press **EXIT** or **PROGRAM**, then start from step 1.
- If the display shows "SAVE ERROR", move closer to the base unit and try again. If "SAVE ERROR" is still displayed, place the handset on the base unit. Restart from step 1.

#### \*What the confirmation tone means

- 1 beep: The mode is different from a previously selected one.
- 2 beeps: The mode is the same as a previously selected one.

If a power failure occurs, the mode will return to the factory preset (TONE). Reprogram if necessary.



## Storing the Area Code

You have to program your area code first before using the Caller ID feature (p. 26). Then incoming calls from the same area will be recorded in the Caller List without the code. You do not have to remove the area code before storing or calling back. Also, when incoming calls from a different area code are received, "1" will be added before the area code automatically.

**The TALK/BATT LOW indicator light must be off before programming.**

1 Press **PROGRAM**.

- The TALK/BATT LOW indicator flashes.

```
SAVE AUTO# ?
v=NEXT      ^=YES
```

2 Press **SEARCH** ∨ (NEXT key) 3 times until "SAVE AREA CODE?" is displayed.

```
SAVE AREA CODE?
v=NEXT      ^=YES
```

3 Press **SEARCH** ^ (YES key).

- The current setting is displayed. The factory preset is "---".

```
AREA CODE = ---
ENTER AREA CODE
```

4 Enter your area code.

- If you enter a wrong number, press **CLEAR**, then enter the correct number.

```
AREA CODE = 123
PROGRAM=SAVE
```

5 When finished, press **PROGRAM**.

- The stored number is displayed.
- In a few seconds, the handset will return to the stand-by mode.

```
AREA CODE = 123
```

• To cancel, press **EXIT**, then start from step 1.

### To erase the area code

1. Press **PROGRAM**.
2. Press **SEARCH** ∨ (NEXT key) 3 times.
3. Press **SEARCH** ^ (YES key).
4. Press **CLEAR**.
5. Press **PROGRAM**.

### Setting the Auto Talk Feature

The Auto Talk feature allows you to answer a call by lifting the handset off the base unit without pressing **TALK**. If you want to view caller's information on the display after lifting the handset, turn this feature OFF by programming. The factory preset is ON.

**The TALK/BATT LOW indicator light must be off before programming.**

1 Press **PROGRAM**.

- The TALK/BATT LOW indicator flashes.

SAVE AUTO# ?
∇=NEXT     ^=YES

2 Press **SEARCH** ∇ (NEXT key) 5 times until "TALK SWITCHING?" is displayed.

TALK SWITCHING?
∇=NEXT     ^=YES

3 Press **SEARCH** ^ (YES key).

AUTO TALK
∇=ON       ^=OFF

4 To select OFF, press **SEARCH** ^.  
OR

To select ON, press **SEARCH** ∇.

- The selected mode is displayed.
- In a few seconds, the handset will return to the stand-by mode.

AUTO TALK
OFF

AUTO TALK
ON

- To cancel, press **EXIT** or **PROGRAM**, then start from step 1.
- To answer a call when the Auto Talk feature is OFF, lift the handset off the base unit, then press **TALK**.



# Wall Mounting

This unit can be mounted on a wall phone plate.

- 1 Pull down the handset hook until it locks **so the tab holds the handset.**

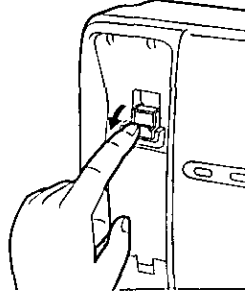

- 2 Connect the AC adaptor. Tuck the telephone line cord inside the wall mounting adaptor, then push it in the direction of the arrow.

- The word "UP" should face upward.

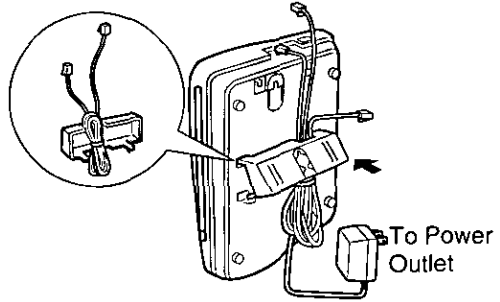

- 3 Connect the telephone line cord. Mount the unit, then slide down.

- Raise the antenna.

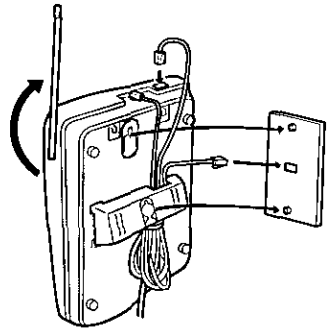

- 4 **To charge the handset battery:** Place the handset on the handset hook as shown.

- The IN USE/CHARGE indicator lights.

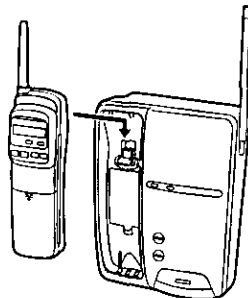

# Making Calls

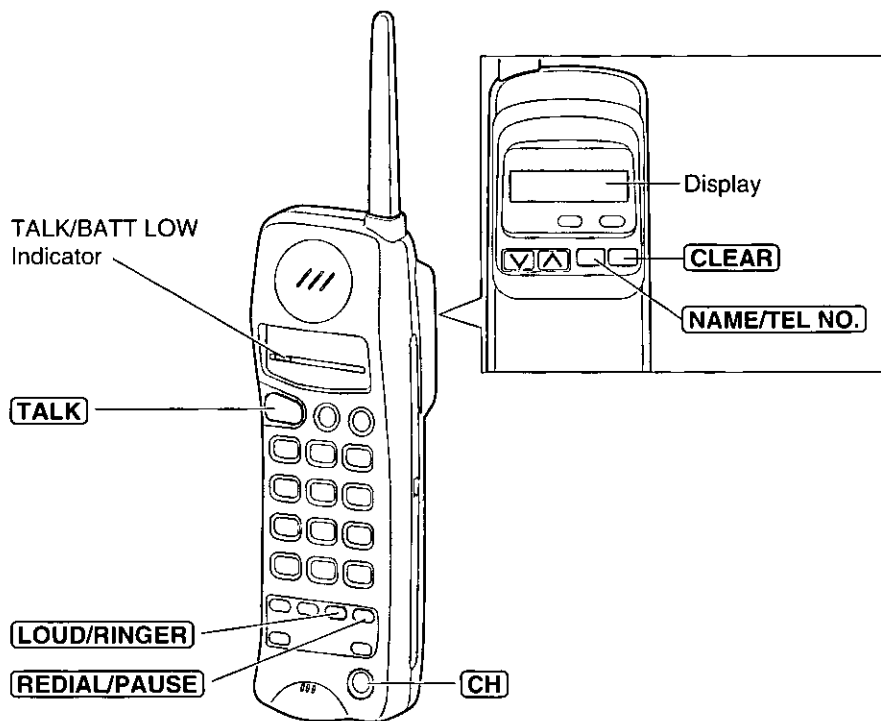

- 1** Press **TALK**.
- The TALK/BATT LOW indicator lights.

TALK	CH10
------	------

- 2** Dial a phone number.
- The dialed number is displayed.
  - After a few seconds, the display will show the length of the call.

1112222	CH10
---------	------

00-00-00	CH10
----------	------

- 3** To hang up, press **TALK** or place the handset on the base unit.
- The TALK/BATT LOW indicator light goes out.

## To redial the last number dialed

Press **TALK** ➔ **REDIAL/PAUSE**.

- If "OUT OF RANGE" is displayed and an alarm tone sounds after pressing **(TALK)** when making a call, move closer to the base unit or place the handset on the base unit. Then try again.
- To display the dialed number during a conversation, press **(NAME/TEL NO.)**. To return to the length of the call, press **(CLEAR)**.

## To select the receiver volume

Press **(LOUD/RINGER)** while talking.

- Each time you press the button, the volume level will change from MEDIUM (preset) to HIGH to LOW.

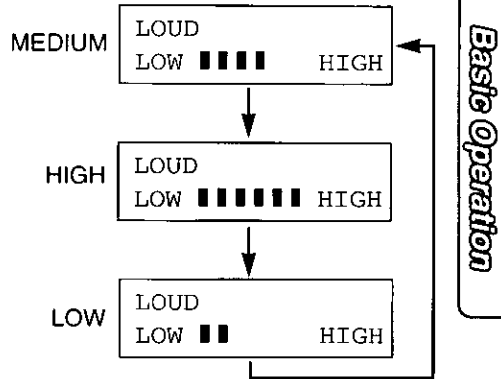

## If noise interferes with the conversation

Press **(CH)** to select a clearer channel or move closer to the base unit.

- The selected channel number is displayed.

## Lighted keypad

The dialing buttons will light while dialing and flash when a call is received. The lights will go out about 10 seconds after dialing or answering a call.

## Lighted display

The display will light when the handset is in use (making/answering a call, viewing the caller list, etc.). The light will go out about 10 seconds after pressing a handset button or answering a call.

# Answering Calls

---

When a call is received, the unit rings and the RINGER indicator on the base unit flashes quickly. If you subscribe to a Caller ID service, the calling party information will be displayed after the first ring (p. 26).

If the handset is off the base unit, press **TALK**.

- You can also answer a call by pressing any dialing button 0 to 9, \*, or # (— **Any Key Talk**).

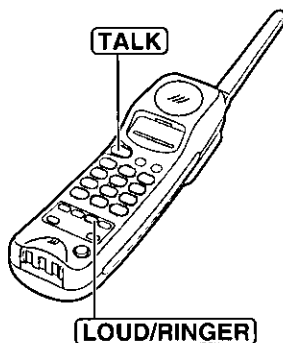

**OR**

If on the base unit, just lift it up.  
(This is not available when the Auto Talk feature is set to OFF. See page 16.)

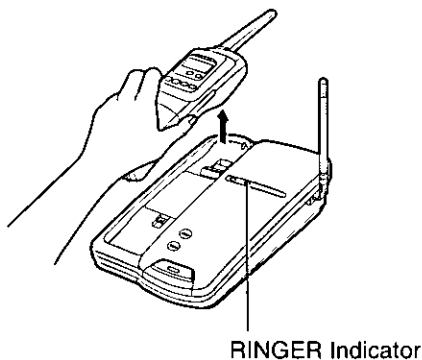

## Adjusting the handset ringer volume

The TALK/BATT LOW indicator light must be off.

- To select **HIGH (preset) or LOW**, press **[LOUD/RINGER]** lightly. (Each time you press the button lightly, the ringer volume will change.)

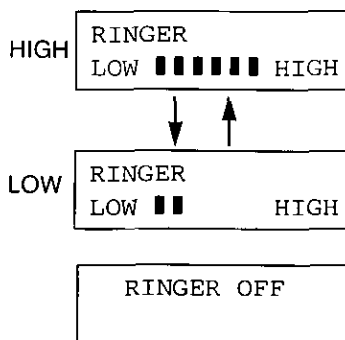

- To turn the ringer **OFF**, press **[LOUD/RINGER]** until 2 beeps sound.

“RINGER OFF” will be displayed for about 1 minute before the handset returns to the stand-by mode.

- To turn the ringer **ON**, press **[LOUD/RINGER]** lightly. The ringer sounds at the HIGH level.

## Selecting the ringer tone (2 types)

The TALK/BATT LOW indicator light must be off.

1. Press **[LOUD/RINGER]**.
2. Press **[\*]** within 5 seconds.
  - The selected ringer tone sounds.
  - Each time you press **[\*]** within 5 seconds, the ringer tone will change.

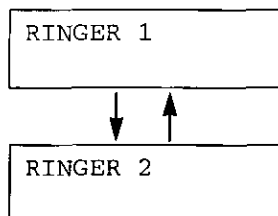

# Automatic Dialing

## Storing Phone Numbers in Memory

You can store up to 10 phone numbers in the handset. The dialing buttons (0 to 9) function as memory stations.

**The TALK/BATT LOW indicator light must be off before programming.**

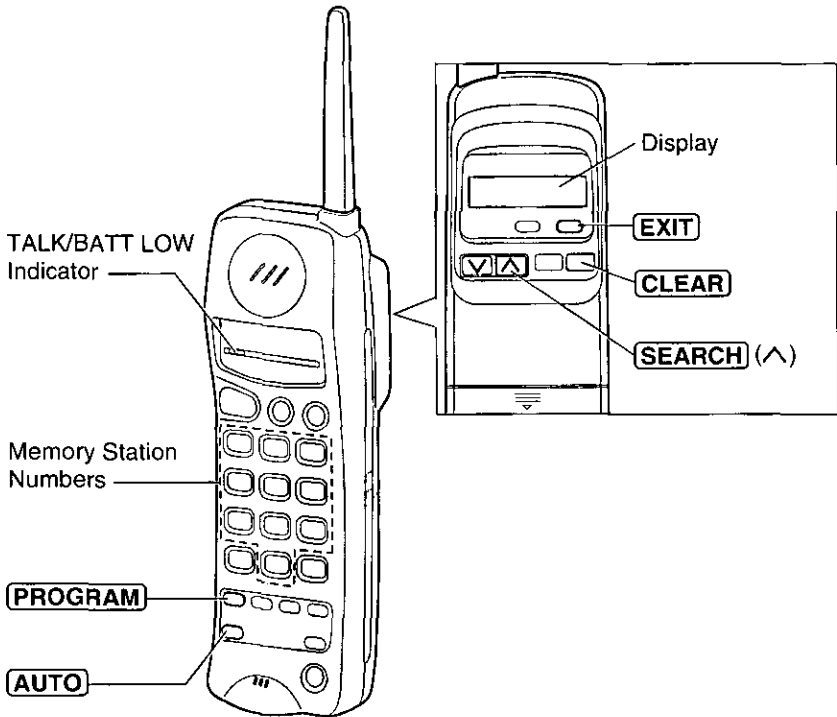



- 1 Press **PROGRAM**.
  - The TALK/BATT LOW indicator flashes.
- 2 Press **SEARCH** ^ (YES key).
- 3 Enter a phone number up to 16 digits.
  - If you misdial, press **CLEAR**. Digits are corrected from the right.
- 4 Press **AUTO**.
- 5 Press a memory station number (0 to 9).
  - A confirmation tone sounds.\*
  - In a few seconds, the handset will return to the stand-by mode.
  - To store other numbers, repeat steps 1 through 5.

SAVE AUTO# ?  
v=NEXT    ^=YES

ENTER PHONE NO.

3334444  
AUTO=SAVE

SELECT 0-9  
TO SAVE IN AUTO

3334444  
SAVE IN AUTO 1

*Basic Operation*

- To cancel, press **PROGRAM** or **EXIT**, then start from step 1.

### \*What the confirmation tone means

- 1 beep: The new number is stored.
- 2 beeps: The number is the same as a previously stored one.

## ➔ Automatic Dialing

### Memory sticker

Use the included memory sticker as a name or phone number index for automatic dialing. Attach the sticker to the unit or in a convenient place.

10-STATION AUTOMATIC DIALER	
1	6
2	7
3	8
4	9
5	0
TEL. NO.	

### To erase a stored number

- 1 Press **PROGRAM**.
  - The TALK/BATT LOW indicator flashes.
- 2 Press **SEARCH** ^ (YES key).
- 3 Press **CLEAR**.
- 4 Press **AUTO**.
- 5 Press the memory station number (0 to 9) of the phone number to be erased.

SAVE AUTO# ?  
√=NEXT    ^=YES

ENTER PHONE NO.

AUTO=CLEAR

SELECT 0-9 TO  
CLEAR IN AUTO

CLEAR IN AUTO 1



---

## Dialing a Stored Number

- 1 Press **TALK**.
- 2 Press **AUTO**.
- 3 Press the memory station number (0 to 9).
  - The stored number is dialed.

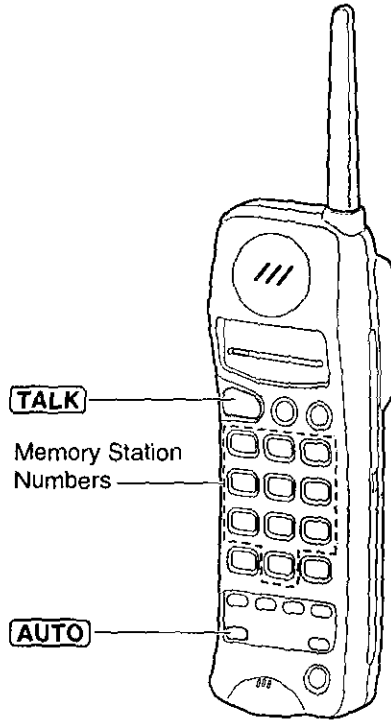

*Basic Operation*

# Caller ID Service

This unit is compatible with a Caller ID service offered by your telephone company.

After you subscribe to a Caller ID service, the calling party information will be displayed after the first ring.

The unit records information of up to 30 callers, including the time and date received and the number of times called, in the Caller List. The Caller List information is sorted by the most recent to oldest call.

Using the list, you can automatically dial the caller. You can store the caller's numbers in the Caller List into the automatic dialing memory.

If you subscribe to a Visual Call Waiting (Call Waiting ID) service, when a second call is received, the new caller's name and phone number will be displayed (p. 38).

## How caller information is displayed when a call is received

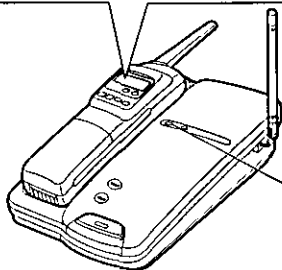
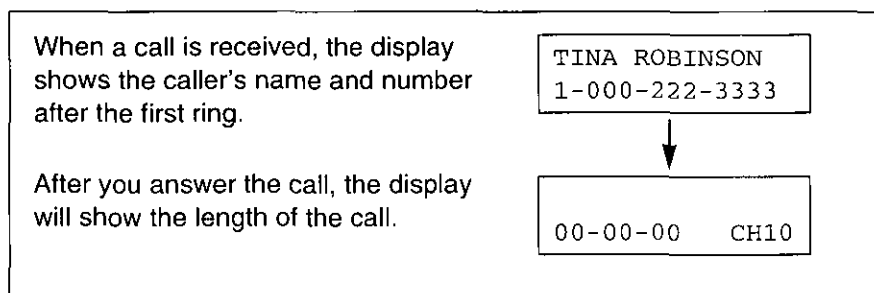

The CALLER ID indicator light flashes quickly when a call is received.

- In some cases, caller information cannot be displayed. In these cases, the display will show as follows.

The caller dialed from an area which does not provide a Caller ID service.

OUT OF AREA

The caller has requested not to display their information.

PRIVATE CALLER

- When the unit is connected to a PBX system, you cannot receive caller information.
- In some calling areas, the name display service may not be available. For further information, please contact your telephone company.

## To check the number of new calls

When new calls have been received, the CALLER ID indicator flashes slowly on the base unit.

### While the handset is on the base unit:

If you have received 10 new calls, the display will show the following.

10 NEW CALLS

When you lift the handset, the display changes to the following.

10 NEW CALLS  
 √=NEW      ^=OLD

- After 10 seconds, the display changes to the stand-by mode (p. 13).

CALLER ID Indicator

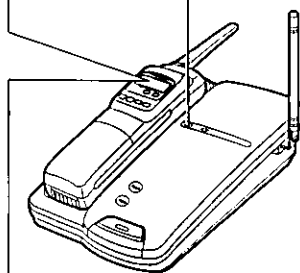

Advanced Operation

### While the handset is off the base unit:

Press **SEARCH** (√ or ^) to turn the display on. If you have received 10 new calls, the display will show the following.

10 NEW CALLS  
 √=NEW      ^=OLD

**SEARCH**

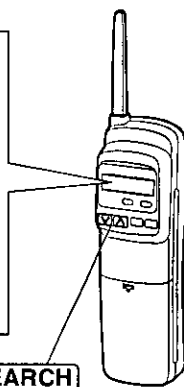

# Using the Caller List

## Viewing the Caller List

To confirm who has called you, follow the steps below.

- 1 Lift the handset off the base unit.  
OR

When the handset is off the base unit, press **SEARCH** (∨ or ∧) to enter the list.

- The display will show the following.

1 NEW CALL
∨=NEW      ∧=OLD

- 2 To search from the most recent call, press **SEARCH** ∨ (NEW key).  
To search from the oldest call, press **SEARCH** ∧ (OLD key).

- To move between callers, press **SEARCH** (∨ or ∧).
- To alternate the display between the name and number, press **NAME/TEL NO.**

- 3 To exit the list, press **EXIT**.

- The handset will return to the stand-by mode.

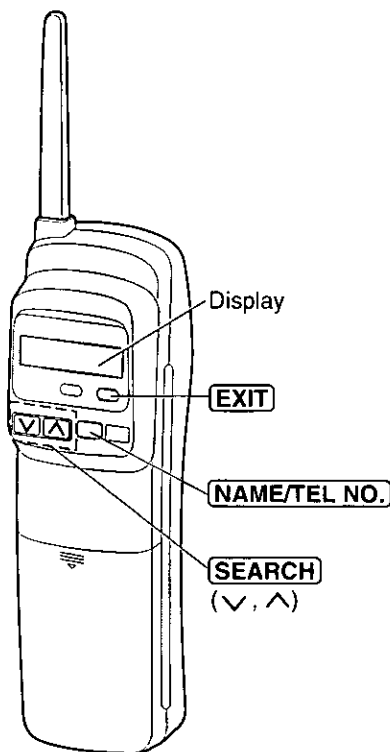

- Once NEW calls have been checked, they will be listed as OLD. The number of NEW calls will be displayed as "0 NEW CALL" after all of the NEW calls have been checked.
  - When you answer a call or call back, the caller information will be listed as OLD.
  - If "NO CALLERS" is displayed in step 1, the Caller List is empty. Press **EXIT** to exit the list.
  - If more than one call is received from the same caller, the date and time of the last call will be recorded.
- Also, OLD call entries will be deleted when the same caller calls again.



### Ex. When you search from the most recent call:

1 NEW CALL

Lift the handset off the base unit.

OR

[Empty box]

When the handset is off the base unit, press **SEARCH** v.

1 NEW CALL  
v=NEW    ^=OLD

Press **SEARCH** v. ↓\*

JACK SMITH  
11:20A JAN12 ×3

Press **NAME/TEL NO.**

111-2222  
11:20A JAN12 ×3

Press **SEARCH** v. ↓

Press **SEARCH** v.

END OF NEW CALL

Press **SEARCH** v. ↓\*

•NANCY BROWN  
9:54A JAN10 ×2

Press **NAME/TEL NO.**

•222-3333  
9:54A JAN10 ×2

Press **SEARCH** v. ↓\*

Press **SEARCH** v.

/KEVIN PARKER  
8:35P JAN 9

Press **NAME/TEL NO.**

/333-4444  
8:35P JAN 9

Press **SEARCH** v. ↓

Press **SEARCH** v.

END

\*If the next caller does not have name information, the display will only show the phone number.

Press **SEARCH** v.

Advanced Operation

To exit the Caller List, press **EXIT**.

• The handset will return to the stand-by mode.

#### Display Symbols

- : You have viewed this caller information at least once or answered the call.
- / : You have called back the caller.
- ×2-×9 : The number of times they called (up to 9).

## ➔ Using the Caller List

### Calling Back from the Caller List

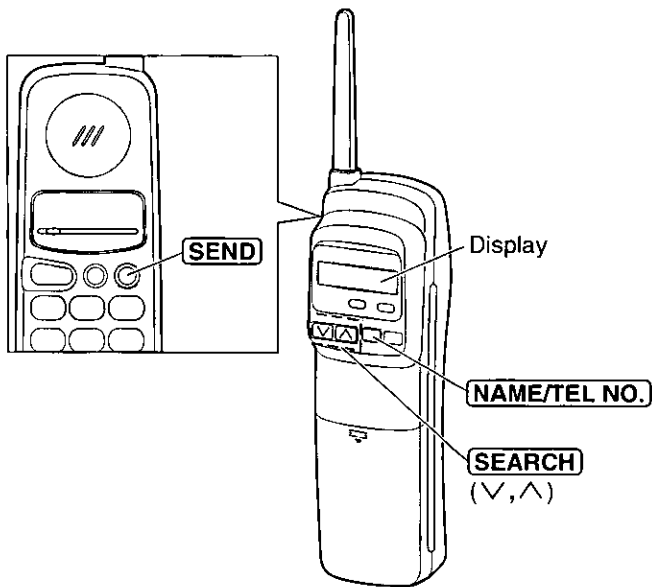

- 1** Lift the handset off the base unit.  
OR  
When the handset is off the base unit,  
press **SEARCH** (∨ or ∧) to enter the list.

3 NEW CALLS ∨=NEW      ∧=OLD
---------------------------------

- 2** Press **SEARCH** (∨ or ∧) repeatedly to  
find the desired caller.
- To confirm the caller's phone number,  
press **NAME/TEL NO.**

CINDY TURNER 11:20A JAN12 ×3
---------------------------------

- 3** Press **SEND**.
- The unit obtains a dial tone and  
automatically dials the displayed phone  
number.

1-234-456-7890 CH11
------------------------

- In some cases you may have to edit the number before it is dialed (p. 31).  
(Ex. You may have to add "1" for long distance calls.)  
If the area code is not stored (p. 15), the edited number will not be saved  
in the Caller List.
- If a phone number is not displayed in the caller information, you cannot  
call back that caller.



# Editing the Caller's Phone Number

The unit can edit a phone number into one of 4 patterns.

- 1** Lift the handset off the base unit.  
 OR  
 When the handset is off the base unit, press **[SEARCH]** (∨ or ∧) to enter the list.

5 NEW CALLS
∨=NEW      ∧=OLD

- 2** Press **[SEARCH]** (∨ or ∧) repeatedly to find the desired caller.

FRED PARKER
11:20A JAN12 ×3

- 3** Press **[NAME/TEL NO.]** to display the caller's phone number.

321-5555
11:20A JAN12 ×3

- 4** Press **[EDIT]** to select an edit pattern. Each time you press **[EDIT]**, the number is rearranged into one of 4 different patterns.

- (a) 1 -
- (b) 1 -  -
- (c)  -
- (d)

- The cursor on the area code will flash. You can change the area code by entering the correct number using the dialing buttons.
- The order in which patterns (a) – (d) are displayed depends on which pattern the telephone number is displayed in step 3.

(a) 

1-321-5555
11:20A JAN12 ×3

(b) 

1-234-321-5555
11:20A JAN12 ×3

(c) 

234-321-5555
11:20A JAN12 ×3

(d) 

321-5555
11:20A JAN12 ×3

Advanced Operation

- 5** After you edit the number into the desired pattern, you can continue with storing or call back procedures.

To store the number in automatic dialing memory, press **[AUTO]**. Then press a memory station number (0 to 9) (p. 32).  
 To call back, press **[SEND]** (p. 30).

## ➔ Using the Caller List

---

### Storing the Caller List Information in Automatic Dialing Memory

You can store numbers that are in the Caller List into the automatic dialing memory.

**The TALK/BATT LOW indicator light must be off.**

- 1 Lift the handset off the base unit.  
OR  
When the handset is off the base unit, press **SEARCH** (∨ or ∧) to enter the list.

10 NEW CALLS  
∨=NEW      ∧=OLD
- 2 Press **SEARCH** (∨ or ∧) repeatedly to find the caller you want to store in memory.

  - To check the phone number, press **NAME/TEL NO.**. If the number requires editing, see page 31.

CINDY TURNER  
11:20A JAN12 ×3
- 3 Press **AUTO**.

SELECT 0-9  
TO SAVE IN AUTO
- 4 Press a memory station number (0 to 9).

  - A confirmation tone sounds (p. 23).

1-234-456-7890  
SAVE IN AUTO 0

- You cannot store caller information in automatic dialing memory when a phone number is not displayed.



---

# Erasing the Caller List Information

After checking the Caller List, you can erase some or all of the entries.

## To erase a specific caller from the Caller List

- 1** Lift the handset off the base unit.  
OR  
When the handset is off the base unit,  
press **SEARCH** (∨ or ∧) to enter the list.

10 NEW CALLS  
∨=NEW      ∧=OLD

- 2** Press **SEARCH** (∨ or ∧) repeatedly to  
find the caller you want to erase from  
memory.

TOM REAGAN  
12:20A JAN12 ×3

- 3** Press **CLEAR**.
- The information is erased.
  - In a few seconds, the display shows  
the previous caller information.

CLEAR

## To erase all of the entries in the Caller List

- 1** Lift the handset off the base unit.  
OR  
When the handset is off the base unit,  
press **SEARCH** (∨ or ∧) to enter the list.

Be sure this display is  
shown.

0 NEW CALL  
∨=NEW      ∧=OLD

- 2** Press **CLEAR**.

PRESS CLEAR FOR  
ALL CLEAR

- 3** Press **CLEAR** again.
- All of the entries are erased.
  - In a few seconds, the handset will  
return to the stand-by mode.

ALL CLEAR

- You can also erase all of the entries by setting the display to “END OF NEW CALL”, “END OF OLD CALL” or “END” using **SEARCH** (∨ or ∧) in step 1.

Advanced Operation

# Voice Mail Service

Voice mail service is an electronic on-line answering system offered by your telephone company. After you subscribe, the voice mail system can answer calls automatically when your line is busy or if calls are not answered. Callers can leave messages by following the pre-recorded instructions. When voice mail messages are recorded, you will hear a voice mail tone after pressing **TALK**. You can access the voice mail system quickly by pressing **VOICE MAIL**.

Store your access phone number first **using the handset close to the base unit. The TALK/BATT LOW indicator light must be off before programming.**

## To store an access number in your voice mail

1 Press **PROGRAM**.

- The TALK/BATT LOW indicator flashes.

SAVE AUTO# ?

∨=NEXT     ^=YES

2 Press **SEARCH** ∨ (NEXT key) twice until "SAVE MAILBOX# ?" is displayed.

SAVE MAILBOX# ?

∨=NEXT     ^=YES

3 Press **SEARCH** ^ (YES key).

ENTER MAILBOX#

4 Enter your access phone number up to 30 digits.

1234567890

VOICEMAIL=SAVE

- If you enter a wrong number, press **CLEAR**. Digits are corrected from the right.

5 Press **VOICE MAIL**.

1234567890

SAVE MAILBOX#

- A confirmation tone sounds (p. 23).
- The stored number is displayed.
- In a few seconds, the handset will return to the stand-by mode.

- To cancel, press **EXIT** or **PROGRAM**, then start from step 1.
- If the display shows "SAVE ERROR", move closer to the base unit and try again. If "SAVE ERROR" still remains, place the handset on the base unit. Restart from step 1.

---

## To listen to voice mail message(s)

When you have received a voice mail message, you will hear a voice mail tone after pressing **TALK**. You can listen to the message from the handset.

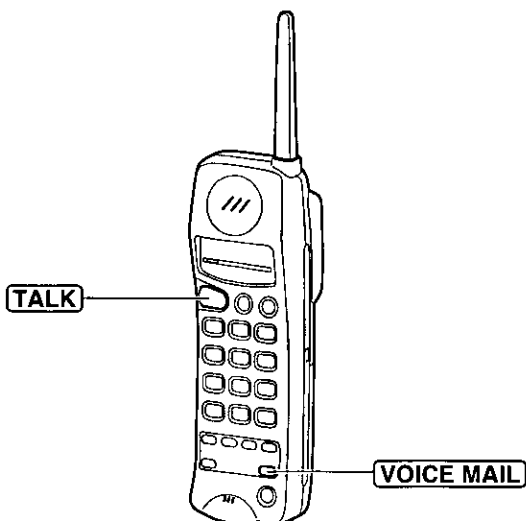

- 1 Press **VOICE MAIL**.
  - The unit obtains a dial tone and automatically dials the number.
- 2 Follow the pre-recorded instructions.
- 3 When finished, press **TALK**.

# Special Features

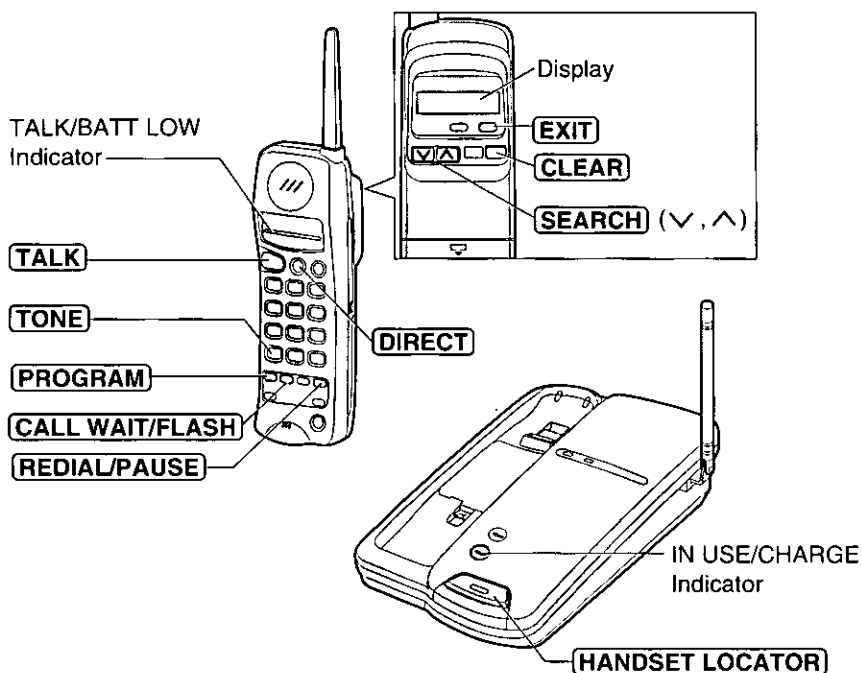

## Handset Locator

From the base unit, you can locate the handset or page a person at the handset with beep tones.

1. Press **HANDSET LOCATOR**.

- The IN USE/CHARGE indicator flashes. The handset beeps for 1 minute and "PAGING" is displayed.

2. To stop paging, press **HANDSET LOCATOR** again or press **TALK** twice on the handset.



# One-Touch Dialing

You can store a phone number in the DIRECT button. The stored number is dialed with a one-touch operation. **The TALK/BATT LOW indicator light must be off before programming.**

## To store a phone number in memory

1 Press **PROGRAM**.

- The TALK/BATT LOW indicator flashes.

SAVE AUTO# ?
∨=NEXT     ^=YES

2 Press **SEARCH** ∨ (NEXT key) once. Be sure that "SAVE DIRECT# ?" is displayed.

SAVE DIRECT# ?
∨=NEXT     ^=YES

3 Press **SEARCH** ^ (YES key).

ENTER PHONE NO.
-----------------

4 Enter a phone number up to 16 digits.

- If you misdial, press **CLEAR**. Digits are corrected from the right.

3334444
DIRECT=SAVE

5 Press **DIRECT**.

- A confirmation tone sounds (p. 23).
- The stored number is displayed.
- In a few seconds, the handset will return to the stand-by mode.

3334444
SAVE IN DIRECT

- To cancel, press **PROGRAM** or **EXIT**, then start from step 1.

## To dial a stored number

1. Press **TALK**.

2. Press **DIRECT**.

- The stored number is dialed.

### • To erase a stored number

Press **PROGRAM** ⇒ **SEARCH** ∨ (NEXT key) ⇒ **SEARCH** ^ (YES key) ⇒ **CLEAR** ⇒ **DIRECT**.

Advanced Operation

### For Call Waiting Service Users

Press **CALL WAIT/FLASH** if you hear a call-waiting tone while talking.

- The first call is put on hold and you can answer the second call.
- To return to the first caller, press **CALL WAIT/FLASH** again.

### Visual Call Waiting (Call Waiting ID) Service

Visual Call Waiting (Call Waiting ID) Service allows your handset to display the second caller's information. After you hear a call-waiting tone while talking, the handset will display the caller's name with the phone number and "----WAITING----" alternately.

- Please contact your telephone company for details and availability in your area.

### Automatic Security Code Setting

Whenever you place the handset on the base unit, the unit automatically selects one of a million security codes. These codes help prevent the unauthorized use of your telephone line by another cordless telephone.

### Temporary Tone Dialing (For Rotary Pulse Service Users)

Press **TONE** before entering access numbers which require tone dialing.

- The dialing mode changes to tone. You can enter numbers to access an answering service, electronic banking services, etc. When you hang up, the mode returns to pulse.

### If Your Unit is Connected to a PBX (Analog Only)

We recommend you press **REDIAL/PAUSE** between the access number for an outside line and the phone number.

- Pressing **REDIAL/PAUSE** once creates a 3.5 second pause. This prevents misdialing when you redial or dial a stored number. (**REDIAL/PAUSE** counts as one digit.)

# Optional Spare Battery



When the handset battery needs charging, you may replace it with a fully charged optional spare battery. This eliminates waiting for the handset battery to recharge. **Please purchase a Panasonic P-P592 (KX-A92) battery** and install it in the base unit to charge.

## Installing a spare battery in the base unit

- 1 Open the cradle cover by pushing the tab and lifting the cover.

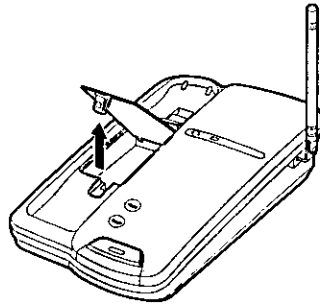

- 2 Install the spare battery as shown, observing the proper polarity. Then close the cradle cover.

- The SPARE CHARGE indicator lights.

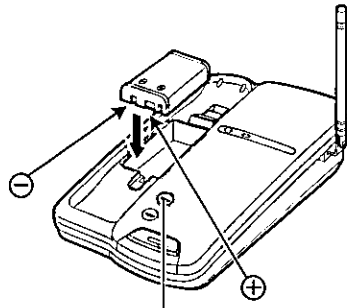

SPARE CHARGE Indicator

The spare battery is always being charged in the base unit while the AC adaptor is connected. The battery cannot be overcharged.

### Attention:

The product you have purchased is powered by a nickel cadmium battery which is recyclable. At the end of its useful life, under various state and local laws, it is illegal to dispose of this battery into your municipal waste stream. Please call 1-800-8-BATTERY for information on how to recycle this battery.



## ➔ Optional Spare Battery

### Replacing the handset battery with the spare battery

To prevent memory loss, replace the battery within 5 minutes.

- 1 Remove the handset cover, then remove the battery.

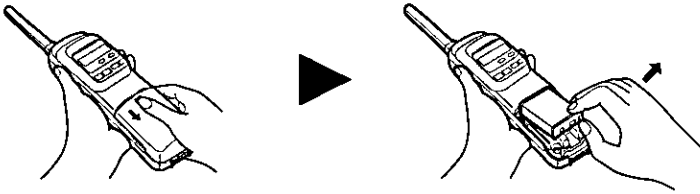

- 2 Replace the handset battery with the spare battery in the base unit.

- ① Remove the spare battery.
- ② Insert the handset battery in the base unit observing the proper polarity.

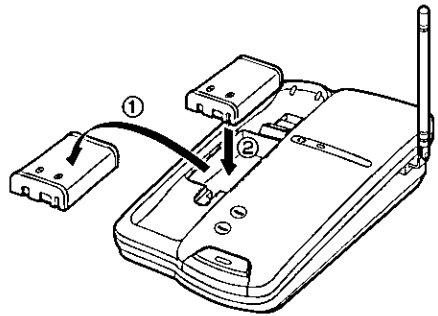

- 3 Install the spare battery in the handset, observing the proper polarity.

- When finished, close the handset cover.

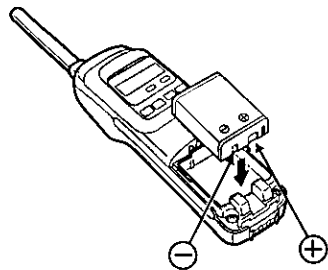

- If the TALK/BATT LOW indicator flashes slowly even when the handset battery has been fully charged, it is time to replace the battery with a new one. Remember to charge the new battery completely after battery replacement.
- Please use only a Panasonic P-P592 (KX-A92) battery. To order, call 1-800-211-PANA(7262).



# Before Requesting Help



Problem	Remedy
"OUT OF RANGE" is displayed and an alarm tone sounds when you press <b>TALK</b> .	<ul style="list-style-type: none"><li>• You are too far from the base unit. Move closer and try again.</li><li>• Place the handset on the base unit and try again.</li><li>• Plug in the AC adaptor.</li></ul>
An alarm tone sounds continuously while using the handset.	<ul style="list-style-type: none"><li>• Move closer to the base unit quickly, or the call will be terminated within 60 seconds.</li><li>• Plug in the AC adaptor.</li></ul>
The unit does not work.	<ul style="list-style-type: none"><li>• Check the settings (p. 11-16).</li><li>• Charge the battery fully (p. 12).</li><li>• Clean the charge contacts and charge again (p. 13).</li><li>• Install the battery properly (p. 11).</li><li>• Place the handset on the base unit and unplug the AC adaptor to reset. Plug in, then try again.</li><li>• Re-install the handset battery within 5 minutes to avoid memory loss and try again.</li></ul>
Static, sound cuts in/out, fades. Interference from other electrical units.	<ul style="list-style-type: none"><li>• Locate the handset and the base unit away from other electrical appliances (p. 3).</li><li>• Move closer to the base unit.</li><li>• Raise the base unit antenna.</li><li>• Press <b>CH</b> to select a clearer channel.</li></ul>
The handset does not ring.	<ul style="list-style-type: none"><li>• The ringer volume is set to OFF. Press <b>LOUD/RINGER</b> lightly while the TALK/BATT LOW indicator light is off (p. 21).</li></ul>
The handset display is blank.	<ul style="list-style-type: none"><li>• The handset is in the stand-by mode (p. 13). Press <b>SEARCH</b> (v or ^) to turn the display on.</li></ul>

## ➔ Before Requesting Help

Problem	Remedy
The handset display is still blank after pressing <b>SEARCH</b> (∨ or ∧).	<ul style="list-style-type: none"><li>• Charge the battery fully (p. 12).</li></ul>
You cannot program items, such as the dialing mode.	<ul style="list-style-type: none"><li>• Programming is not available while the unit is in the talk mode or when viewing the caller information.</li></ul>
You cannot store a phone number in memory.	<ul style="list-style-type: none"><li>• <b>SEARCH</b> (∨ or ∧) may have been pressed when you picked up the handset. Press <b>EXIT</b>, then try again.</li><li>• You cannot store a number while the unit is in the talk mode.</li><li>• Do not pause for over 30 seconds while storing.</li></ul>
While programming or searching, the unit starts to ring and stops the program/search.	<ul style="list-style-type: none"><li>• To answer the call, press <b>TALK</b>. Start from the beginning after hanging up.</li></ul>
The unit does not display the name and/or phone number of callers.	<ul style="list-style-type: none"><li>• Other telephone equipment may be interfering with your phone. Disconnect them and try again.</li><li>• Other electrical appliances connected to the same outlet as the phone may be interfering with the Caller ID information. Telephone line noise may be affecting the Caller ID information.</li></ul>
The handset display becomes blank while searching.	<ul style="list-style-type: none"><li>• Do not pause for over 60 seconds while searching.</li></ul>
<b>HANDSET LOCATOR</b> does not function.	<ul style="list-style-type: none"><li>• The handset is too far from the base unit.</li><li>• The handset is engaged in an outside call or in the search mode. Wait until the IN USE/CHARGE indicator light goes out.</li></ul>

Problem	Remedy
<p><b>REDIAL/PAUSE</b> does not function properly.</p>	<ul style="list-style-type: none"> <li>• The button has a double function as either redial or pause. It will redial the last number dialed if pressed at the outset of a call (p. 18). If another number has been dialed first, it will operate as a pause button (p. 38).</li> </ul>
<p>The TALK/BATT LOW indicator flashes slowly or the unit beeps intermittently.</p>	<ul style="list-style-type: none"> <li>• Charge the battery fully or replace with a fully charged optional spare battery (p. 12, 39).</li> </ul>
<p>You charged the battery fully, but the TALK/BATT LOW indicator flashes slowly.</p>	<ul style="list-style-type: none"> <li>• Clean the charge contacts and charge again (p. 13).</li> <li>• Replace the battery. Please purchase a new battery (p. 40).</li> </ul>
<p>The IN USE/CHARGE indicator and/or the SPARE CHARGE indicator light never goes out while charging.</p>	<ul style="list-style-type: none"> <li>• This is normal.</li> </ul>
<p>If you cannot solve your problem.</p>	<ul style="list-style-type: none"> <li>• Call our customer satisfaction center at 1-800-211-PANA(7262).</li> </ul>

## Adding Another Phone

This unit will not function during a power failure. To connect a standard telephone on the same line, use a Panasonic T-adaptor KX-J66. To order, call 1-800-211-PANA(7262).

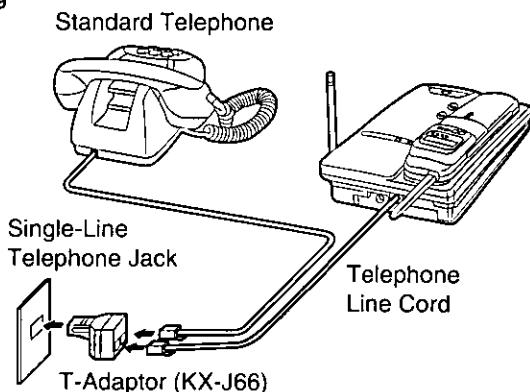

# Important Safety Instructions

---

When using this unit, basic safety precautions should always be followed to reduce the risk of fire, electric shock, or personal injury.

1. Read and understand all instructions.
2. Follow all warnings and instructions marked on this unit.
3. Unplug this unit from AC outlets before cleaning. Do not use liquid or aerosol cleaners. Use a damp cloth for cleaning.
4. Do not use this unit near water, for example, near a bathtub, washbowl, kitchen sink, or the like.
5. Place this unit securely on a stable surface. Serious damage and/or injury may result if the unit falls.
6. Do not cover slots and openings on the unit. They are provided for ventilation and protection against overheating. Never place the unit near radiators, or in a place where proper ventilation is not provided.
7. Use only the power source marked on the unit. If you are not sure of the type of power supplied to your home, consult your dealer or local power company.
8. Do not place objects on the power cord. Install the unit where no one can step or trip on the cord.
9. Do not overload wall outlets and extension cords. This can result in the risk of fire or electric shock.
10. Never push any objects through slots in this unit. This may result in the risk of fire or electric shock. Never spill any liquid on the unit.
11. To reduce the risk of electric shock, do not disassemble this unit. Take the unit to an authorized servicer when service is required. Opening or removing covers may expose you to dangerous voltages or other risks. Incorrect reassembly can cause electric shock when the unit is subsequently used.
12. Unplug this unit from the wall outlet and refer servicing to an authorized servicer when the following conditions occur:
  - A. When the power supply cord or plug is damaged or frayed.
  - B. If liquid has been spilled into the unit.
  - C. If the unit has been exposed to rain or water.
  - D. If the unit does not work normally by following the operating instructions. Adjust only controls covered by the operating instructions. Improper adjustment may require extensive work by an authorized servicer.
  - E. If the unit has been dropped or physically damaged.
  - F. If the unit exhibits a distinct change in performance.
13. During thunderstorms, avoid using telephones except cordless types. There may be a remote risk of an electric shock from lightning.
14. Do not use this unit to report a gas leak, when in the vicinity of the leak.

## SAVE THESE INSTRUCTIONS

---

## **CAUTION:**

To reduce the risk of fire or injury to persons, read and follow these instructions.

1. Use only the battery(ies) specified.
2. Do not dispose of the battery(ies) in a fire. They may explode. Check with local waste management codes for special disposal instructions.
3. Do not open or mutilate the battery(ies). Released electrolyte is corrosive and may cause burns or injury to the eyes or skin. The electrolyte may be toxic if swallowed.
4. Exercise care in handling batteries in order not to short the battery to conductive materials such as rings, bracelets, and keys. The battery and/or conductor may overheat and cause burns.
5. Charge the battery(ies) provided with or identified for use with this product only in accordance with the instructions and limitations specified in this manual.

## **WARNING:**

TO PREVENT FIRE OR SHOCK HAZARD, DO NOT EXPOSE THIS PRODUCT TO RAIN OR ANY TYPE OF MOISTURE.

# FCC and Other Information

---

If requested by the telephone company, inform them as follows:

FCC Registration No. ....(found on the bottom of the unit)

Ringer Equivalence .....0.2B

The particular telephone line to which the equipment is connected.

This unit must not be connected to a coin operated line.

If you are on a party line, check with your local telephone company.

## **Ringer Equivalence No. (REN):**

The REN is useful in determining the quantity of devices you may connect to your telephone line and still have all of those devices ring when your telephone number is called. In most, but not all areas, the sum of the REN's of all devices connected to one line should not exceed five (5.0). To be certain of the number of devices you may connect to your line, as determined by the REN, you should contact your local telephone company to determine the maximum REN for your calling area.

In the event terminal equipment causes harm to the telephone network, the telephone company should notify the customer, if possible, that service may be stopped.

However, where prior notice is impractical, the company may temporarily cease service providing that they:

- (a) Promptly notify the customer.
- (b) Give the customer an opportunity to correct the problem with their equipment.
- (c) Inform the customer of the right to bring a complaint to the Federal Communication Commission pursuant to procedures set out in FCC Rules and Regulations Subpart E of Part 68.

The Telephone Company may make changes in its communications facilities, equipment, operations or procedures, where such action is reasonably required in the operation of its business and is not inconsistent with the rules and regulations in FCC Part 68.

If such changes can be reasonably expected to render any customer terminal equipment incompatible with telephone company communications facilities, or require modification or alteration of such terminal equipment, or otherwise materially affect its use or performance, the customer shall be given adequate notice in writing, to allow the customer an opportunity to maintain uninterrupted service.

When programming emergency numbers and/or making test calls to emergency numbers:

1. Remain on the line and briefly explain to the dispatcher the reason for the call before hanging up.
2. Perform such activities in the off-peak hours, such as early morning hours or late evenings.

---

This device complies with Part 15 of the FCC Rules. Operation is subject to the following two conditions: (1) This device may not cause harmful interference, and (2) this device must accept any interference received, including interference that may cause undesired operation.

Privacy of communications may not be ensured when using this phone.

**CAUTION:**

Any changes or modifications not expressly approved by the party responsible for compliance could void the user's authority to operate this device.

**Note:**

This equipment has been tested and found to comply with the limits for a Class B digital device, pursuant to Part 15 of the FCC Rules. These limits are designed to provide reasonable protection against harmful interference in a residential installation. This equipment generates, uses, and can radiate radio frequency energy and, if not installed and used in accordance with the instructions, may cause harmful interference to radio communications. However, there is no guarantee that interference will not occur in a particular installation. If this equipment does cause harmful interference to radio or television reception, which can be determined by turning the equipment off and on, the user is encouraged to try to correct the interference by one or more of the following measures:

- Reorient or relocate the receiving antenna.
- Increase the separation between the equipment and receiver.
- Connect the equipment into an outlet on a circuit different from that to which the receiver is connected.
- Consult the dealer or an experienced radio/TV technician for help.

Some cordless telephones operate at frequencies that may cause interference to nearby TVs and VCRs. To minimize or prevent such interference, the base of the cordless telephone should not be placed near or on top of a TV or VCR. If interference is experienced, move the cordless telephone further away from the TV or VCR. This will often reduce or eliminate interference.

- **Environment** — do not place the unit in room where the temperature is less than 5°C (41°F) or greater than 40°C (104°F). Allow 10 cm (4") clearance around the unit for proper ventilation. Avoid excessive smoke, dust, mechanical vibration, shock, or direct sunlight.
- **Routine care** — wipe the unit with a soft cloth. Do not use benzine, thinner, or any abrasive powder. When you left the unit unused for long time, unplug the AC adaptor from the outlet.
- **If there is any trouble** — disconnect the unit from the telephone line and connect a known working phone. If the known working phone operates properly, have your unit repaired by one of the authorized Panasonic Factory Service Centers. If the known working phone does not operate properly, consult with your telephone company.

## For product service

- Panasonic Servicenters are listed in the servicenter directory.
- Call 1-800-211-PANA(7262) for the location of an authorized servicenter.

## When you ship the product

- Carefully pack your unit, preferably in the original carton.
- Attach a letter, detailing the symptom, to the outside of the carton.

Symptom

---

- Send the unit to an authorized servicenter, prepaid and adequately insured.
- Do not send your unit to the Panasonic Consumer Electronics Company listed below or to executive or regional sales offices. These locations do not repair consumer products.

• This cordless telephone is designed for use in the United States of America. Sale or use of this product in other countries may violate local laws.

• Ce téléphone sans fil est conçu pour être utilisé aux États-Unis d'Amérique. La vente ou l'emploi de cet appareil dans certains autres pays peut constituer une infraction à la législation locale.

• Este teléfono sin cordón fue elaborado para uso en los Estados Unidos de América. La venta o el empleo de este producto en ciertos países puede constituir violación de la legislación local.

• このコードレス電話機は、日本国外での使用を目的として設計されており、日本国内での使用は法律違反となります。従って、当社では日本国内においては原則として修理などのサービスは致しかねます。

**Panasonic Consumer Electronics Company,  
Division of Matsushita Electric Corporation of America**  
One Panasonic Way, Secaucus, New Jersey 07094

**Panasonic Sales Company,  
Division of Matsushita Electric of Puerto Rico, Inc.**  
Ave. 65 de Infantería, Km. 9.5, San Gabriel Industrial Park  
Carolina, Puerto Rico 00985