

Panasonic

Cordless Answering System

Model No. **KX-TCM420-B**

Pulse-or-tone dialing capability

Operating Instructions

Preparation

Cordless Telephone

Answering System

Useful Information



SOUND CHARGER
CELLS

25
CHANNEL

PLEASE READ BEFORE USE AND SAVE.

Charge the battery for about 10 hours before initial use.

For Best Performance

Battery Charge

A rechargeable Ni-Cd battery powers the handset. Charge the battery for about **10 hours** before initial use (p. 11).



Operating Distance/Noise

Calls are transmitted between the base unit and the handset using wireless radio waves. **For maximum distance and noise free operation**, the recommended base unit location is:

Away from electrical appliances such as a TV, radio, or personal computer.

In a **HIGH** and **CENTRAL** location with no obstructions such as walls.

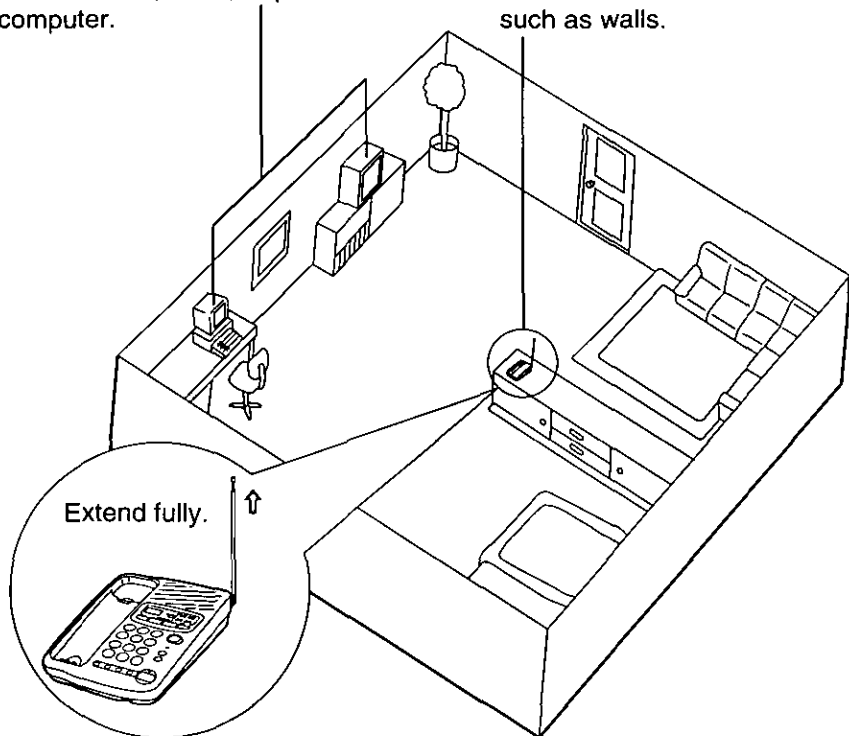

Contents

Preparation

Location of Controls	6
Settings	10
Connections	10
Battery Charge	11
Selecting the Dialing Mode	12
Greeting Message	13
Programmable Preparations	15
Time and Day Adjustment	16
Selecting the Caller's Recording Time	17
Selecting the Number of Rings	18
Setting the CPC (Calling Party Control) Function	19
Setting the Greeting Monitor Function	19

Cordless Telephone

Making/Answering Calls	20
Making Calls with the Handset	20
Answering Calls with the Handset	21
Making Calls with the Base Unit (Digital Duplex Speakerphone) ..	22
Answering Calls with the Base Unit	24
Simultaneous Keypad Dialing	25
Remote Speakerphone	26
Automatic Dialing	28
Storing Phone Numbers in Memory	28
Dialing a Stored Number	29
Intercom	30
Transferring a Call Using the Intercom	31
Special Features	32
For Call Waiting Service Users	32
Automatic Security Code Setting	32
Temporary Tone Dialing (For Rotary Service Users)	32
If Your Unit is Connected to a PBX (Analog Only)	32

Answering System

Automatic Answering Operation 33

 Setting the Unit to Answer Calls 33

Listening to Messages 34

Erasing Messages 36

Recording a Memo Message 37

Pager Call 38

 Storing the Pager Number 38

 Setting the Unit to Call the Pager 39

Remote Operation from a Touch Tone Phone 40

 Setting the Remote Code 41

 Voice Menu 42

 Direct Remote Operation 44

Remote Operation with the Handset 46

 Monitoring incoming calls with the handset 48

 Recording your telephone conversation with the handset 48

Remote Operation Card 49

Useful Information

Battery Replacement 51

Wall Mounting 52

Convenient Desk Usage 54

Adding Another Phone 54

Before Requesting Help 55

Important Safety Instructions 58

FCC and Other Information 60

Location of Controls

Base unit

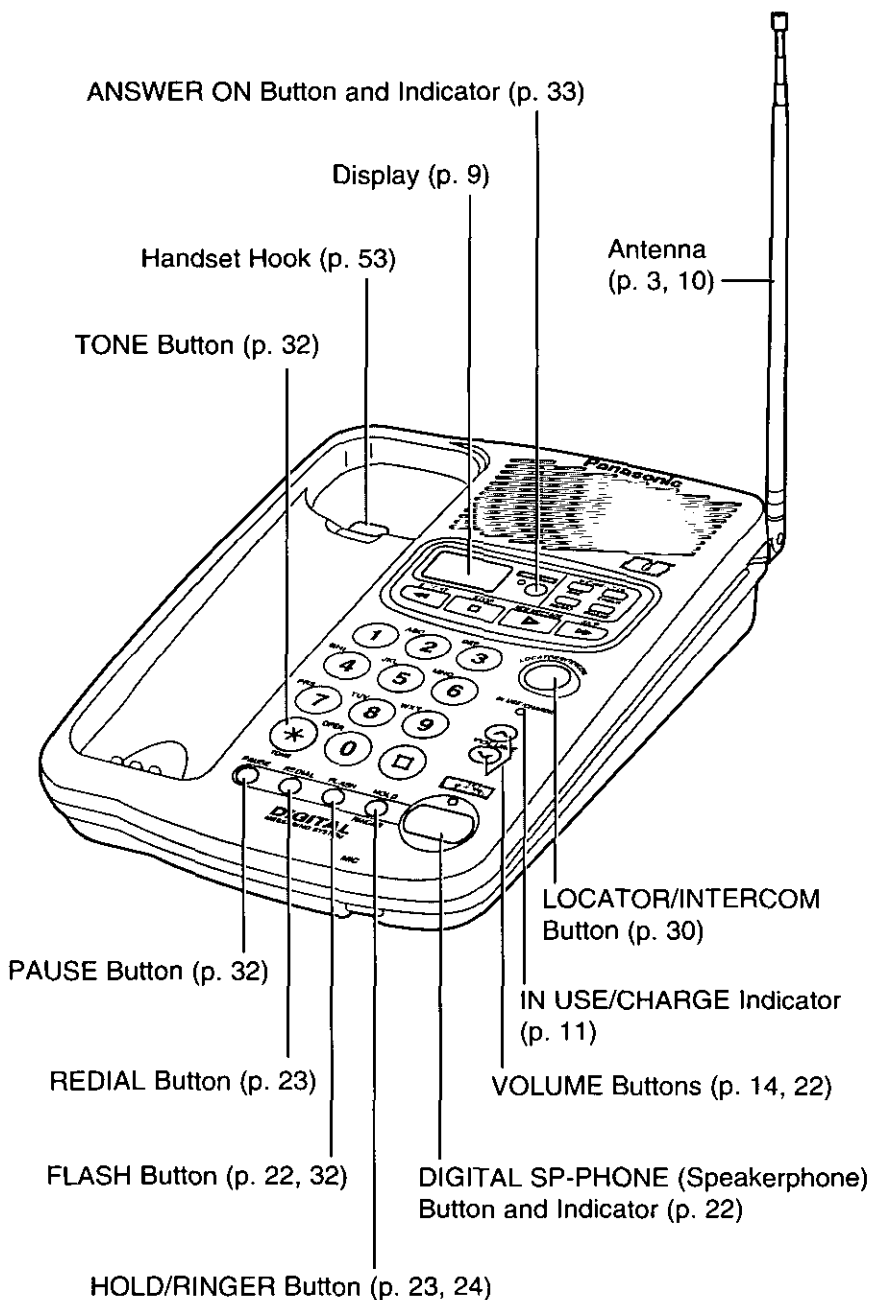

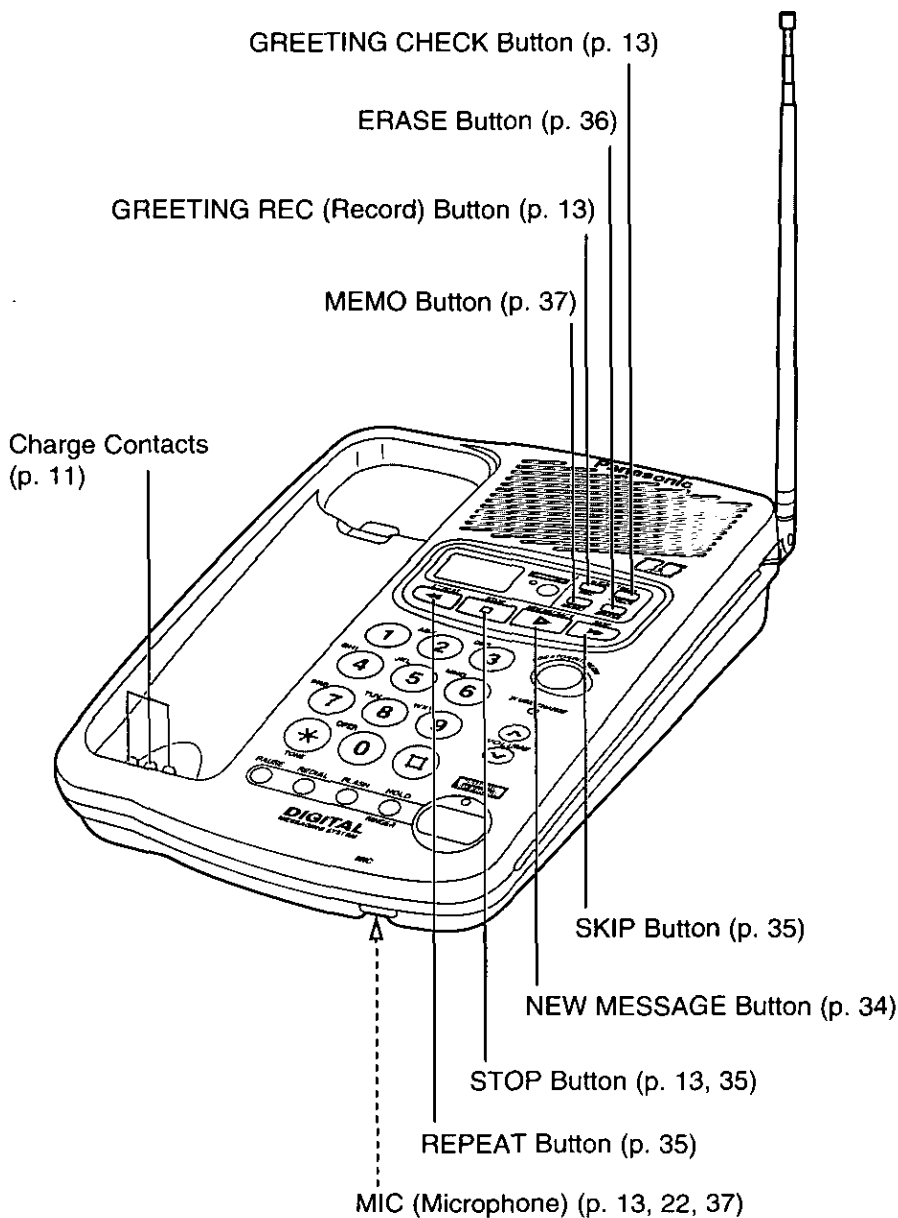

Location of Controls

Handset

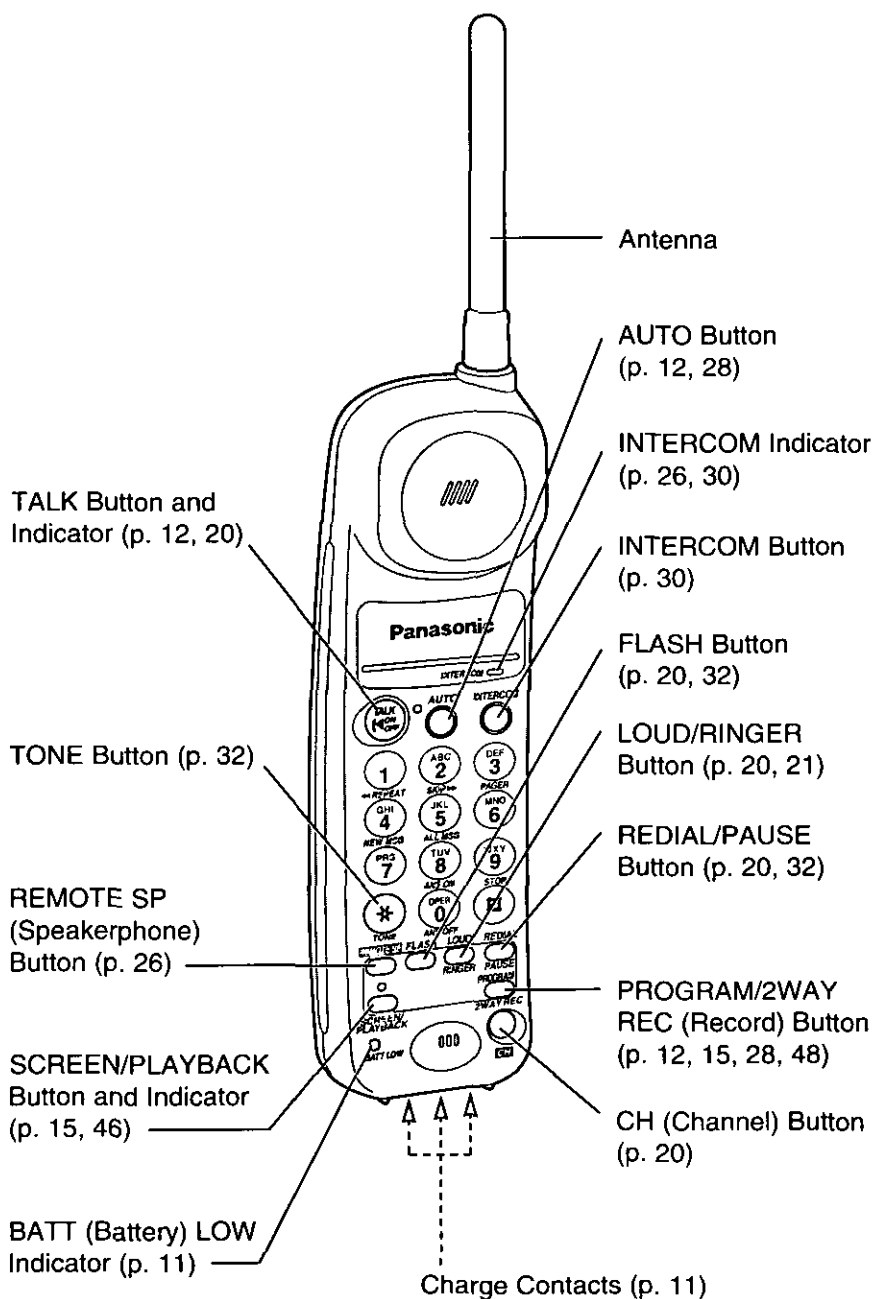

Base unit display

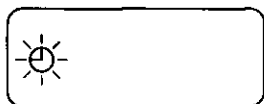

The clock needs adjusting (p. 16).

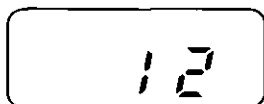

12 messages have been recorded.

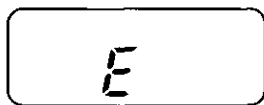

Your message was not recorded correctly. Record it again (p. 13, 37).

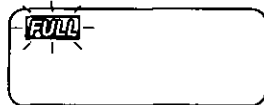

Memory is full. Erase some or all of the messages (p. 36).

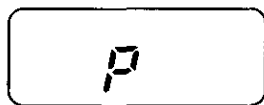

The unit is in programming mode.

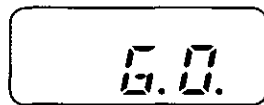

The recording time is set to "greeting only" (p. 17).

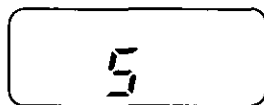

The speaker volume level is set to "5". You can select:

- o 9 levels (0–8) while using the answering system (p. 14, 34).
- o 8 levels (1–8) while using the speakerphone (p. 22).



The base unit ringer volume is set to OFF (p. 24).



The pager call mode is set to ON (p. 39).

Settings

Connections

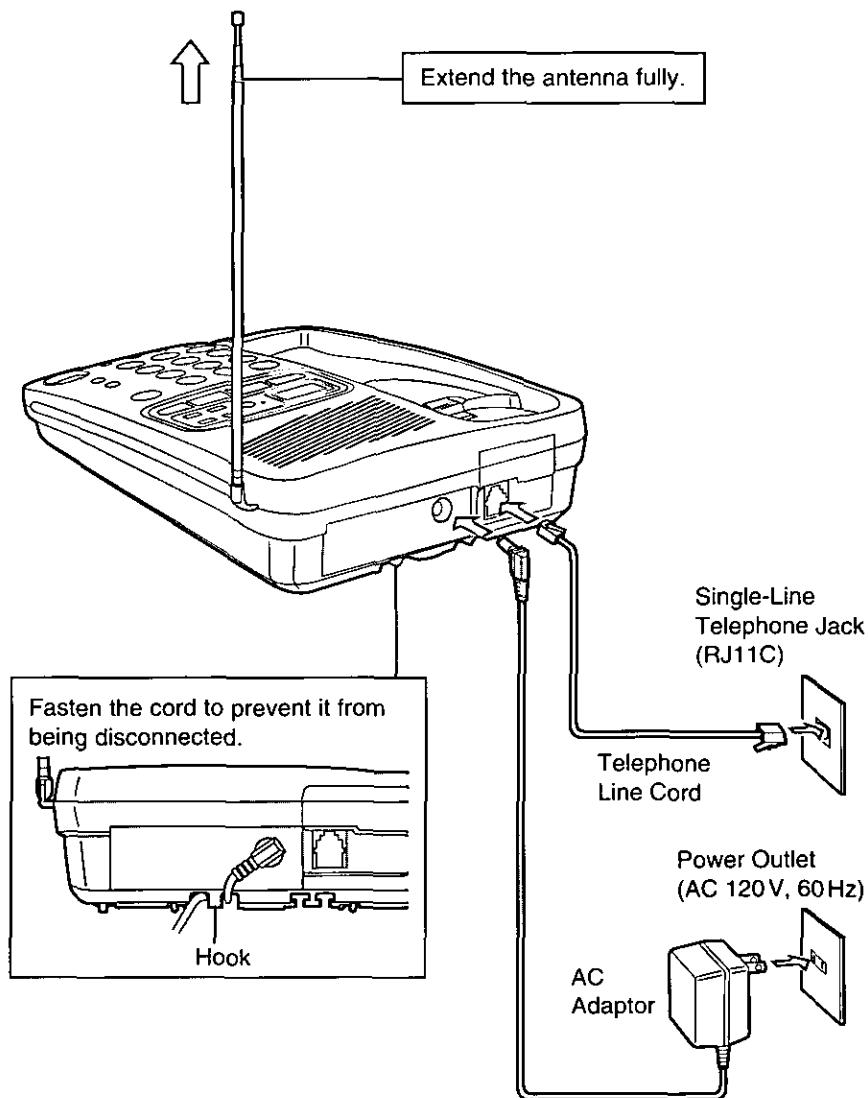

○USE ONLY Panasonic AC ADAPTOR KX-A11.

○The AC adaptor must remain connected at all times. (It may feel warm during use. This is normal.)

○If you connect a standard telephone on the same line, see page 54.



Battery Charge

Place the handset on the base unit for about **10 hours** before initial use.

- The IN USE/CHARGE indicator lights.

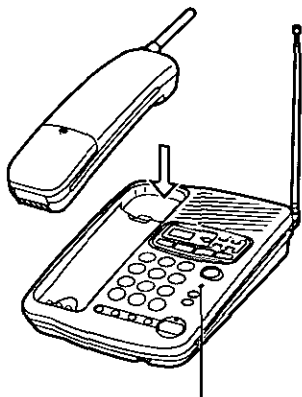

IN USE/CHARGE Indicator

Recharge

When the BATT LOW indicator flashes or the unit beeps intermittently, recharge the battery.

- The BATT LOW indicator will continue to flash for at least 30 minutes once you begin recharging. This time will increase the more you use the handset while recharging.

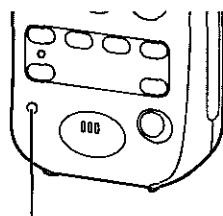

BATT LOW Indicator

Standard battery life

If your Panasonic battery is fully charged;

While in use (TALK)	Up to about 8 hours
While not in use (Stand-By)	Up to about 30 days

- Battery life may vary depending on usage conditions and ambient temperature.
- Clean the handset and the base unit charge contacts with a soft dry cloth once a month or once a week if the unit is subject to grease, dust or high humidity.** If not, the battery may not charge properly.
- Once the battery is fully charged, you do not have to place the handset on the base unit until the BATT LOW indicator flashes. This will maximize the battery life.
- The battery cannot be overcharged.

Selecting the Dialing Mode

You can program the dialing mode by using the handset near the base unit. When your telephone line has touch tone service, set to TONE. If rotary service is used, set to PULSE. The factory preset is TONE.

The TALK and DIGITAL SP-PHONE indicator lights must be off before programming.

- 1 Press **PROGRAM/2WAY REC**.
oThe TALK indicator flashes.
- 2 Press **AUTO**.
- 3 To select PULSE, press **#** twice.
OR
To select TONE, press ***** twice.
- 4 When finished, press **PROGRAM/2WAY REC**.
oA confirmation tone sounds.*

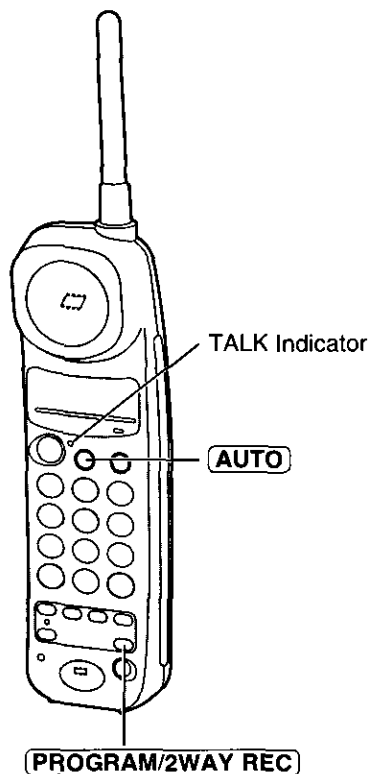

- oTo cancel programming, press **PROGRAM/2WAY REC**, then restart from the beginning.
- oIf 3 beeps sound during programming, you have pressed a wrong key. Restart from step 1.

*What the confirmation tone means

- 1 beep: The mode is different from a previously selected one.
- 2 beeps: The mode is the same as a previously selected one.

If a power failure occurs, the mode will return to the factory preset (TONE). Reprogram if necessary.

Greeting Message



You can prepare a personal greeting message. If you do not, one of two pre-recorded greetings will be played when a call is received (p. 14).

All messages (greeting, incoming, memo, etc.) are stored in digital memory (p. 35). The **total recording time is about 16 minutes**. We recommend you record a **brief greeting message** (see sample below) in order to leave more time in memory.

To record a greeting message

- 1 Press **GREETING REC** to start the recording mode.
 - "Press RECORD again to record greeting." is heard.
- 2 Within 5 seconds, press **GREETING REC** again to record your greeting.
 - A long beep sounds.
- 3 After the long beep, speak clearly about 8 inches (20 cm) away from the **MIC** (microphone).
 - The display shows the elapsed recording time.
- 4 When finished, press **STOP**.
 - To check the recorded greeting, press **GREETING CHECK**.
 - To change the message, repeat from step 1.

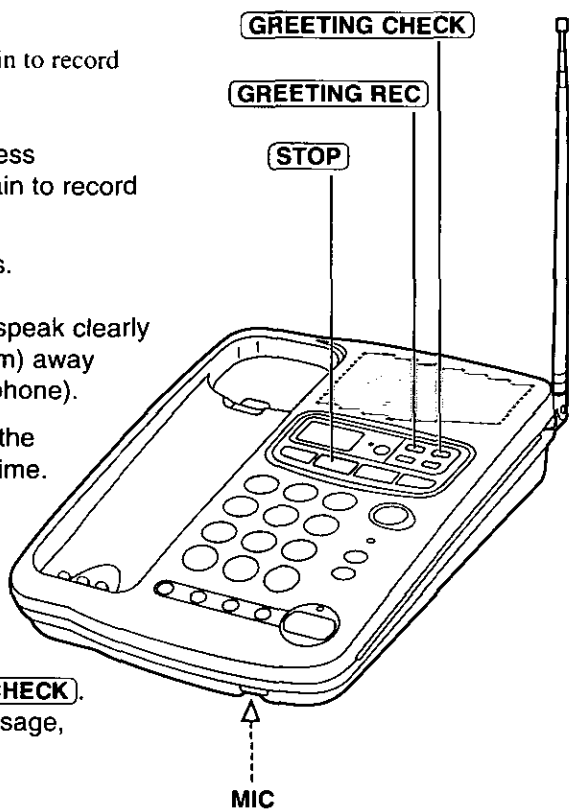

Sample of greeting message

"Hello, this is (your name and/or number). Sorry I cannot take your call. Please leave a message after the beep. Thank you."

◇ Greeting Message

To erase the recorded greeting message

Press **GREETING CHECK** ⇨ press **ERASE** while the message is being played.

◦The unit will answer a call with a pre-recorded greeting.

Pre-recorded greeting message

If you do not record a personal greeting message (p. 13), one of the following two messages will be played when a call is received depending on the caller's recording time (p. 17).

To check the pre-recorded greeting, press **GREETING CHECK**.

◦The pre-recorded greeting is played as below.

□When the recording time is set to "1 minute" or "unlimited";
"Hello, we are not available now. Please leave your name and phone number after the beep. We will return your call."

□When the recording time is set to "greeting only";
"Hello, we are not available now. Please call again. Thank you for your call."

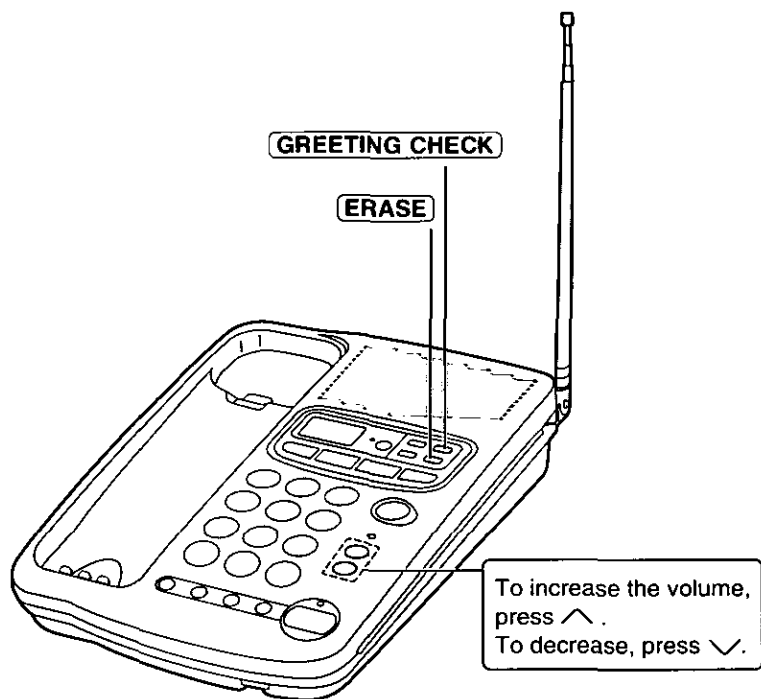

Programmable Preparations



You can program the following functions **by using the handset near the base unit**. See the bracketed pages for details.

Be sure that the TALK and DIGITAL SP-PHONE indicator lights are off before programming.

Lift the handset, then press **PROGRAM/2WAY REC**.



Press **SCREEN/PLAYBACK**.



◦If an alarm tone sounds, move towards the base unit, then try again.

- To adjust **the time and day**, press "0". (page 16)
- To set **the remote code**, press "1". (page 41)
- To select **the number of rings**, press "2". (page 18)
- To set **the CPC function**, press "3". (page 19)
- To set **the greeting monitor function**, press "4". (page 19)
- To select **the caller's recording time**, press "5". (page 17)
- To store **the pager number**, press "#". (page 38)



When finished, press **PROGRAM/2WAY REC**.

◦A confirmation tone sounds.*

- To cancel programming, press **PROGRAM/2WAY REC**, then restart from the beginning.
- If 6 beeps sound during programming, you have pressed a wrong key. Enter the correct number again.

*What the confirmation tone means

- 1 beep: The new programmed number is stored.
- 2 beeps: The number is the same as a previously stored one.
- 6 beeps: The number is not correct. Try again from the beginning.

If a power failure occurs, the mode will return to the factory preset. Reprogram if necessary.

➤ Programmable Preparations

Time and Day Adjustment

Voice Time/Day Stamp: During playback a synthesized voice will announce the time and day when each message was recorded.

- 1 Press **PROGRAM/2WAY REC**.
 - The TALK indicator flashes.
- 2 Press **SCREEN/PLAYBACK**.
 - The indicator lights.
 - “P” is displayed on the base unit.
- 3 Press **0**.
 - “Ⓟ” is displayed.
 - “Set time” is announced.
 - The time/day is heard if it was adjusted beforehand.
- 4 Enter the current time (hour and minute) by using a 4-digit number. (Ex. To set 9:30, enter “0930”.)
 - The entered number is displayed.
- 5 Press ***** to select “AM” or “PM”. Press **#** repeatedly to set the day.
- 6 When finished, press **PROGRAM/2WAY REC**.
 - The unit announces the time/day.
 - The clock starts working.

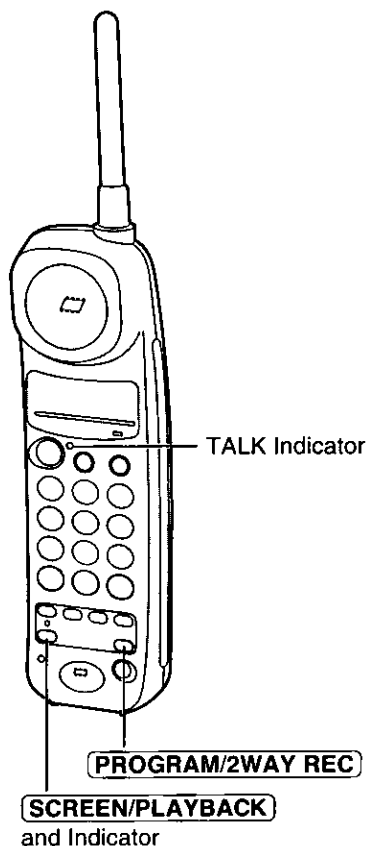

- In step 4, you cannot enter numbers greater than 12. (To set 13:00 hours, enter “0100” and select “PM” by pressing *****.)
- The accuracy of the clock is approximately ± 45 seconds a month at room temperature.

To check the time/day

Press **PROGRAM/2WAY REC** ⇒ **SCREEN/PLAYBACK** ⇒ **0**.

- The current time/day is heard. When finished, press **PROGRAM/2WAY REC**.



Selecting the Caller's Recording Time

You may select the caller's recording time as either "1 minute", "unlimited" or "greeting only". The factory preset is "unlimited".

- 1 Press **PROGRAM/2WAY REC**.
 - The TALK indicator flashes.
- 2 Press **SCREEN/PLAYBACK**.
 - The indicator lights.
 - "P" is displayed on the base unit.
- 3 Press **5**.
 - The current setting is displayed.
 - 1: 1 minute
 - 2: unlimited (factory preset)
 - 3: greeting only
- 4 Press **1**, **2** or **3** to select the recording time.
 - The setting is displayed.
- 5 When finished, press **PROGRAM/2WAY REC**.
 - The indicator lights go out.

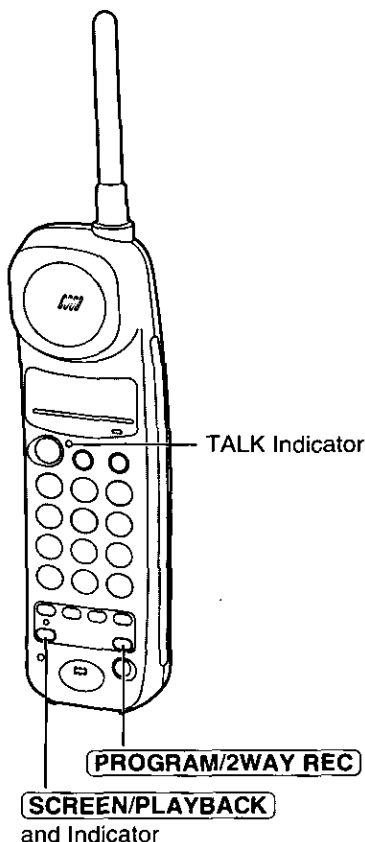

- If you select "greeting only", the unit answers a call with the greeting message, then hangs up. The unit will not record any messages.

◇ Programmable Preparations

Selecting the Number of Rings

You may select the number of rings before the answering system answers a call, from "1" to "7" or "AUTO (for Toll Saver)". The factory preset is "AUTO".

- 1 Press **PROGRAM/2WAY REC**.
 - The TALK indicator flashes.
- 2 Press **SCREEN/PLAYBACK**.
 - The indicator lights.
 - "P" is displayed on the base unit.
- 3 Press **2**.
 - The current setting is displayed.
- 4 Press a dialing button **0** to **7** to set the number of rings.
 - 0**: Selects "AUTO".
"A" is displayed.
 - 1-7**: The unit will answer on the selected number of rings.
- 5 When finished, press **PROGRAM/2WAY REC**.
 - The indicator lights go out.

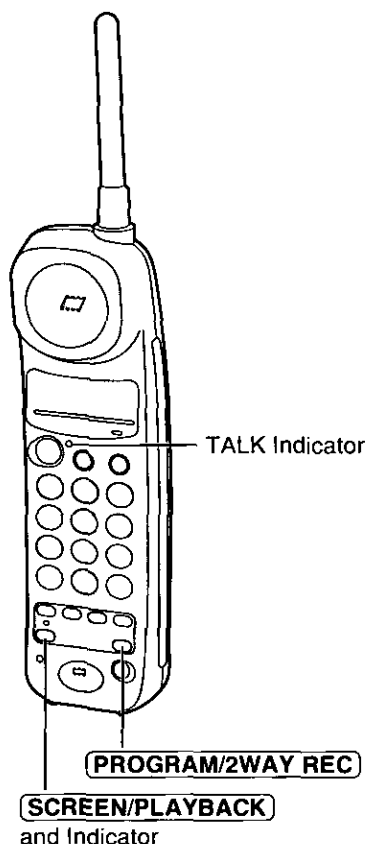

Toll Saver (When set to "AUTO")

When you call the unit from a touch tone telephone:

If the unit answers on the 2nd ring, there is at least one new message.

If the unit answers on the 4th ring, there are no new messages.

Hang up when you hear the 3rd ring. This will save you the toll charge for the call.

Setting the CPC (Calling Party Control) Function

The CPC function is preset to "A". If you use a call waiting service, set to "b", or the call waiting tone will disconnect someone leaving a message.

1. Press **PROGRAM/2WAY REC**.
2. Press **SCREEN/PLAYBACK**.
3. Press **3**.
 - The current setting "A" or "b" is displayed on the base unit.
4. To select "b", press **2**.
OR
To select "A", press **1**.
 - The setting is displayed.
5. When finished, press **PROGRAM/2WAY REC**.

Setting the Greeting Monitor Function

When your greeting message is being played to the caller, you can also listen to it through the speaker. To listen to your greeting, set to "2 (ON)". The factory preset is "1 (OFF)".

1. Press **PROGRAM/2WAY REC**.
2. Press **SCREEN/PLAYBACK**.
3. Press **4**.
 - The current setting "1" or "2" is displayed on the base unit.
4. To select "2 (ON)", press **2**.
OR
To select "1 (OFF)", press **1**.
 - The setting is displayed.
5. When finished, press **PROGRAM/2WAY REC**.

Making/Answering Calls

Making Calls with the Handset

- 1 Press **TALK**.
 - The TALK indicator lights.
- 2 Dial a telephone number.
 - If you misdial, press **FLASH** firmly then dial again.
- 3 To hang up, press **TALK** or place the handset on the base unit.
 - The TALK indicator light goes out.

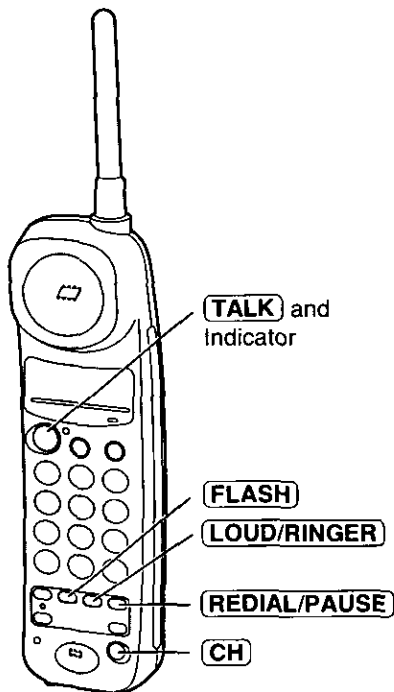

- If an alarm tone sounds in step 1, move towards the base unit or place the handset on the base unit. Then try again.
- To switch to the speakerphone during a call with the handset, see page 26.

To redial the last number

Press **TALK** ⇨ **REDIAL/PAUSE**.

To select the receiver volume LOW, MEDIUM (preset) or HIGH

Press **LOUD/RINGER** while talking.

- Each time you press the button, the volume level will change. (MEDIUM ⇨ HIGH ⇨ LOW ⇨ MEDIUM ⇨ ...)

If noise interferes with the conversation

Press **CH** to select a clear channel or move closer to the base unit.



Answering Calls with the Handset

If the handset is off the base unit, press **TALK**.

- You can also answer a call by pressing any dialing button 0 to 9, *, or # (**Any Key Talk**).

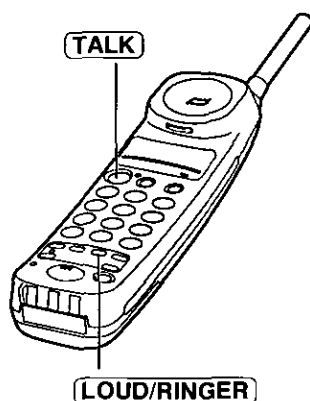

OR

If on the base unit, just lift it up.

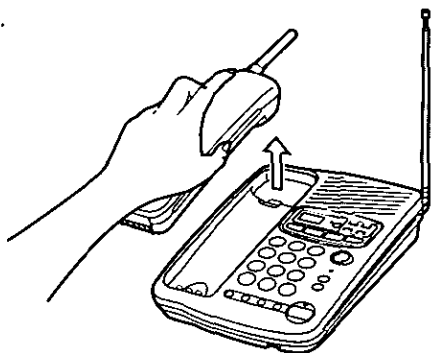

Cordless Telephone

Adjusting the handset ringer volume

Be sure the TALK indicator light is off.

- To select **HIGH (preset)** or **LOW**, press **LOUD/RINGER** lightly. (Each time you press the button, the ringer volume will change.)
- To turn the ringer **OFF**, press **LOUD/RINGER** until 2 beeps sound.
- To turn the ringer **ON**, press **LOUD/RINGER** lightly. The ringer sounds at the HIGH level.

Lighted keypad

The dialing buttons will light while dialing and flash when a call is received. The lights will go out about 10 seconds after dialing or answering a call.

◇ Making/Answering Calls

Making Calls with the Base Unit (Digital Duplex Speakerphone)

1 Press **DIGITAL SP-PHONE**.
◦The indicator lights.

2 Dial a telephone number.
◦If you misdial, press **FLASH** firmly then dial again.

3 When the other party answers, speak into the **MIC** (microphone).

4 To hang up, press **DIGITAL SP-PHONE**.
◦The indicator light goes out.

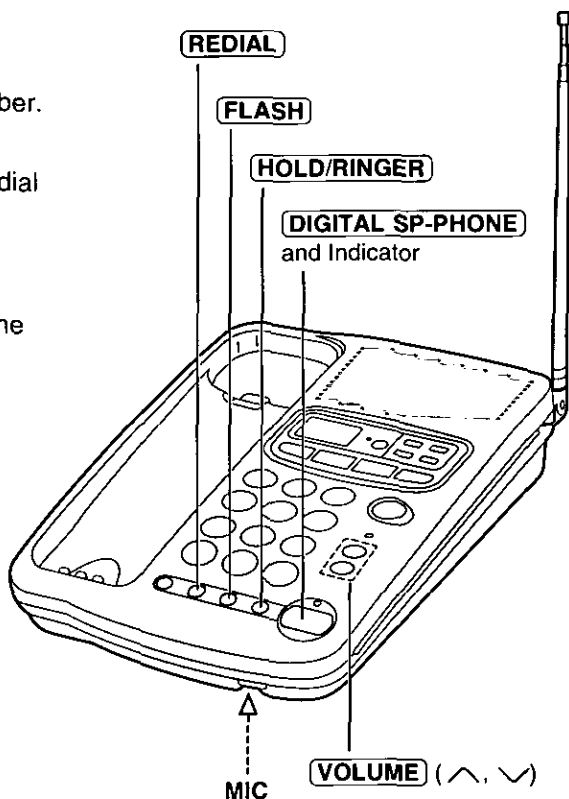

◦While using the speakerphone, if the handset is on the base unit, you may switch to the handset by lifting it up.

To adjust the speaker volume (8 levels)

To increase, press \wedge . To decrease, press \vee .



Hands-Free Digital Duplex Speakerphone

The digital speakerphone enhances your telephone conversation. For best performance, please note the following.

- Use the speakerphone in a quiet room.
- Speak alternately with the caller.
- If the caller complains that your voice is hard to hear, press **∨** to decrease the speaker volume.
- If the other party's voice from the speaker cuts in/out during a conversation, press **∨** to decrease the speaker volume.

To redial the last number

Press **DIGITAL SP-PHONE** ⇒ **REDIAL**.

To put a call on hold

Press **HOLD/RINGER**.

- The DIGITAL SP-PHONE indicator flashes.
- If you put a call on hold for 6 minutes, a warning tone will sound. The call will be disconnected after a total of 10 minutes.

To release the hold

For the base unit, press **DIGITAL SP-PHONE**.

For the handset, press **TALK** or lift the handset off the base unit.

- You may also press **REMOTE SP** on the handset to release the hold at the base unit.
- If another phone is connected on the same line (p. 54), you can also release the hold by lifting its handset.

➤ Making/Answering Calls

Answering Calls with the Base Unit

1 Press **DIGITAL SP-PHONE**.

2 Speak into the **MIC**.

3 To hang up, press **DIGITAL SP-PHONE**.

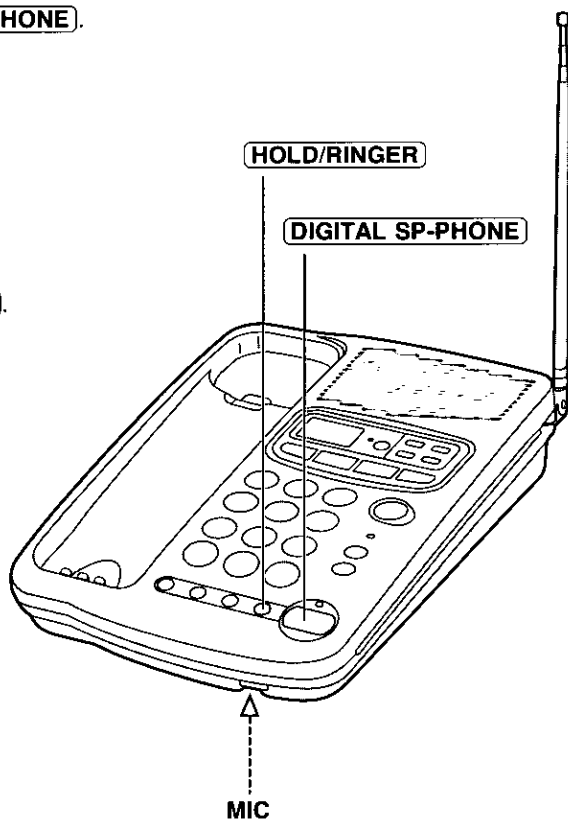

Adjusting the base unit ringer volume

Be sure the **DIGITAL SP-PHONE** indicator light is off.

- To select **HIGH (preset)** or **LOW**, press **HOLD/RINGER** lightly.
(Each time you press the button, the ringer volume will change.)
- To turn the ringer **OFF**, press **HOLD/RINGER** until 2 beeps sound.
“**RINGER OFF**” is displayed.
- To turn the ringer **ON**, press **HOLD/RINGER** lightly. The ringer sounds at the **HIGH** level.



Simultaneous Keypad Dialing

You can use the base unit like a standard telephone. After pressing **TALK** to make a call with the handset near the base unit, you can also dial using the base unit keypad.

1 Handset:
Press **TALK**.

2 Base unit:
Dial a telephone number while hearing a dial tone with the handset.

◦When the other party answers, talk using the handset.

3 Handset:
To hang up, press **TALK** or place the handset on the base unit.

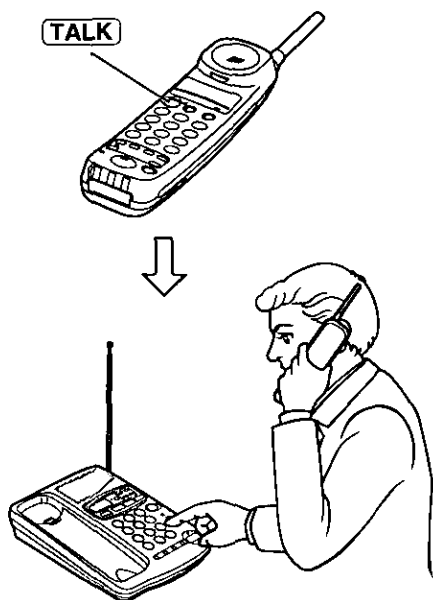

Useful information

This feature is convenient when you need to enter numbers during a call using the handset (for example, to access an answering service, electronic banking services, etc.). You can enter numbers using the base unit keypad.

1. Handset:
Press **TALK**.

2. Handset:
Dial a telephone number.
◦You may also dial with the base unit keypad.

3. Base unit:
Enter the required numbers.

4. Handset:
To hang up, press **TALK** or place the handset on the base unit.

Simultaneous Keypad Dialing is available only after pressing **REMOTE SP** (p. 27) or **TALK**.

➤ Making/Answering Calls

Remote Speakerphone

You can switch a call with the handset to the speakerphone easily.

1 Handset:
During a call with the handset, press **REMOTE SP**.

- The call is switched to the base unit.
- The INTERCOM indicator flashes.
- The DIGITAL SP-PHONE indicator lights.

2 Base unit:
Speak into the **MIC**.

3 Base unit:
To hang up, press **DIGITAL SP-PHONE**.

- The indicator lights go out.
- You can also hang up by pressing **REMOTE SP**.

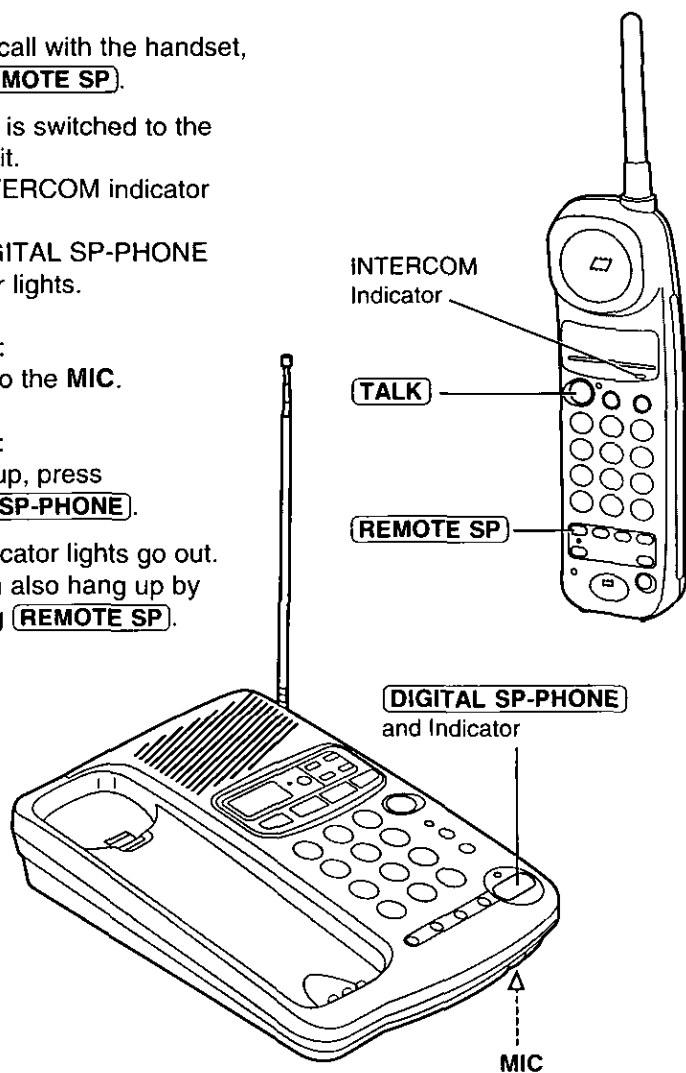

When you use **REDIAL/PAUSE** or **REDIAL**, dial a stored number (p. 29), etc., press **REMOTE SP** after dialing is completed.

You can turn on the base unit speakerphone by using the handset as a remote control.

Making calls with the remote speakerphone

1. Handset:
Press **REMOTE SP**.
2. Handset:
Dial a telephone number.
◦ You may also dial with the base unit keypad.
3. Base unit:
Speak into the **MIC**.
4. Handset:
To hang up, press **REMOTE SP**.
◦ You may also hang up by pressing **DIGITAL SP-PHONE**.

When you redial

A number dialed with the handset keypad is saved in the handset.
A number dialed with the base unit keypad is saved in the base unit.

To switch to the handset (while using the remote speakerphone)

- Press **TALK**.
- You can continue the conversation using the handset.
 - To hang up, press **TALK** or place the handset on the base unit.

When you use **REDIAL/PAUSE** or **REDIAL**, dial a stored number (p. 29), etc., press **TALK** after dialing is completed.

Answering calls with the remote speakerphone

1. Handset:
Press **REMOTE SP**.
2. Base unit:
Speak into the **MIC**.
3. Handset:
To hang up, press **REMOTE SP**.
◦ You may also hang up by pressing **DIGITAL SP-PHONE**.

Automatic Dialing

Storing Phone Numbers in Memory

You can store up to 10 numbers in the handset. The dialing buttons (0 to 9) function as memory stations. The TALK indicator light must be off.

1 Press **PROGRAM/2WAY REC**.
oThe TALK indicator flashes.

2 Enter a phone number up to 16 digits.
oIf you misdial, press **PROGRAM/2WAY REC** to end storing, then restart from step 1.

3 Press **AUTO**.

4 Press a memory station number (0 to 9).
oA confirmation tone sounds.*
oTo store other numbers, repeat steps 1 through 4.

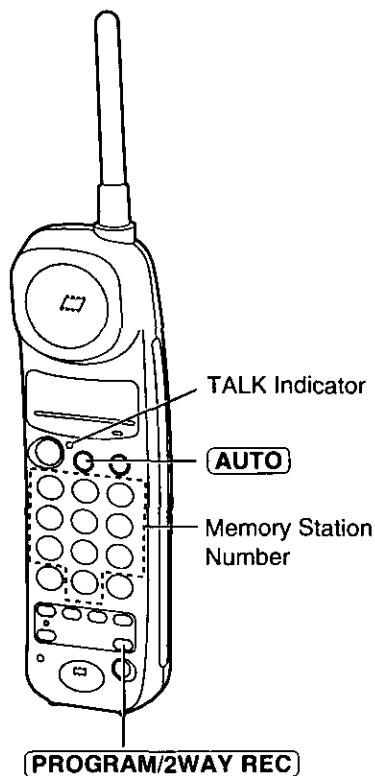

*What the confirmation tone means

- 1 beep: The new number is stored.
- 2 beeps: The number is the same as a previously stored one.

To erase a stored number

Press **PROGRAM/2WAY REC** ⇒ **AUTO** ⇒ the memory station number (0 to 9) for the phone number to be erased.

Memory sticker

Use the included memory sticker as a name or phone number index for automatic dialing. Attach the sticker to the unit or in a convenient place.

10-STATION AUTOMATIC DIALER	
1	6
2	7
3	8
4	9
5	0
TELNO	

Dialing a Stored Number

- 1 Press **TALK**.
- 2 Press **AUTO**.
- 3 Press the memory station number (0 to 9).
 - The stored number is dialed.

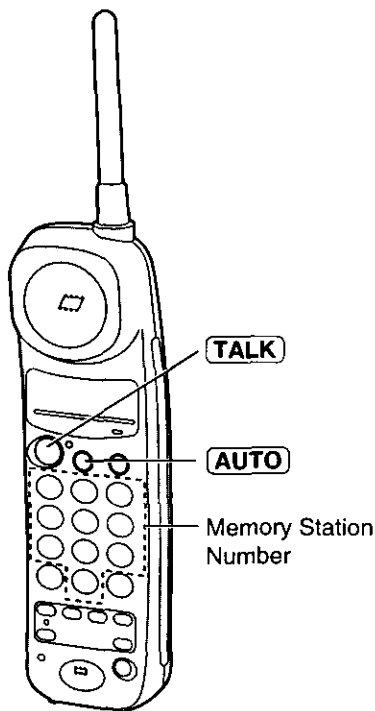

Intercom

A 2-way intercom is available between the handset and the base unit.

Paging the base unit from the handset

- 1 Handset:**
Press **INTERCOM**,
then speak.
◦The indicator lights.
- 2 Base unit:**
When the other party's
voice is heard, answer
through the **MIC**.
- 3 Handset:**
To end the intercom,
press **INTERCOM**.

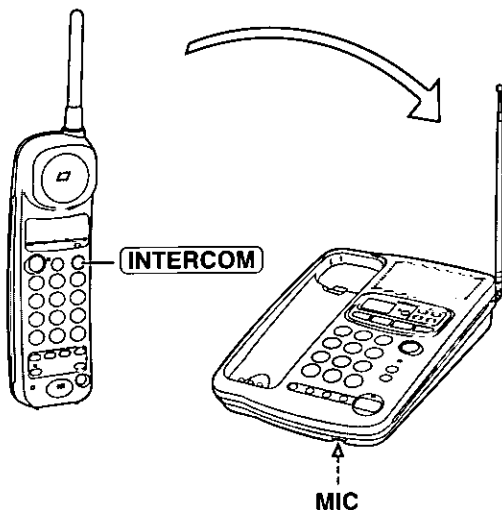

Paging the handset from the base unit (Handset locator)

Using this feature, you can locate the handset, if misplaced.

- 1 Base unit:**
Press **LOCATOR/INTERCOM**.
◦The handset beeps for
1 minute.
◦To stop paging, press
LOCATOR/INTERCOM
again.
- 2 Handset:**
Press **INTERCOM**
to answer.
- 3 Base unit:**
Speak into the **MIC**.
- 4 Handset:**
To end the intercom, press
INTERCOM.

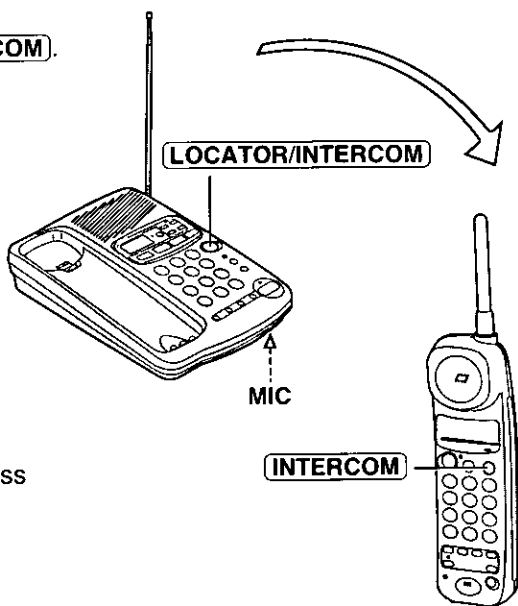

During the intercom:

- Intercom calls can only be ended by the handset.
- If two tones sound, an incoming call has been received. To answer, press **TALK**, **REMOTE SP** or **DIGITAL SP-PHONE**. The intercom is ended.

Transferring a Call Using the Intercom

The intercom can be used during a call. This feature enables you to transfer the call between the handset and the base unit.

From the handset to the base unit

- 1** Handset:
During a call, press **INTERCOM** then speak.
 - The call is put on hold.
 - If the base unit does not answer, press **TALK**.
- 2** Base unit:
When the paging party's voice is heard, answer through the **MIC**.
- 3** Base unit:
To answer the call, press **DIGITAL SP-PHONE**.
 - The transfer is completed.
 - The handset user can join the conversation by pressing **TALK**.

From the base unit to the handset

- 1** Base unit:
During a call, press **LOCATOR/INTERCOM**.
 - The call is put on hold.
 - If the handset does not answer, press **DIGITAL SP-PHONE**.
- 2** Handset:
Press **INTERCOM** to answer the page.
- 3** Handset:
To answer the call, press **TALK**.
 - The transfer is completed.
 - The base unit user can join the conversation by pressing **DIGITAL SP-PHONE**.

Special Features

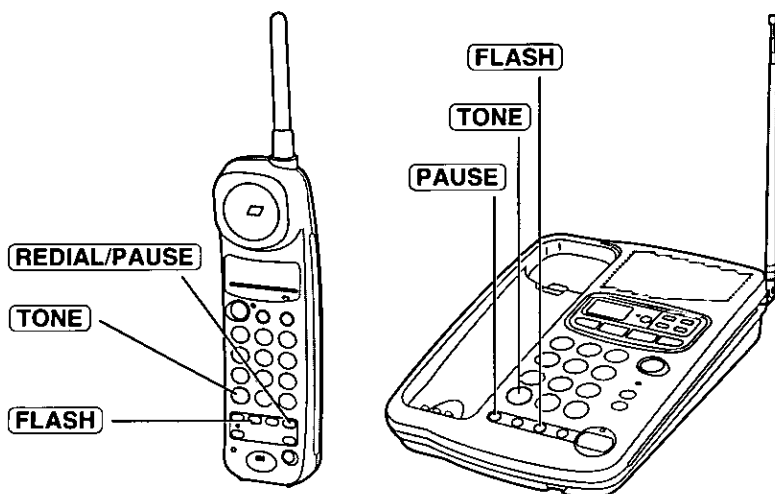

For Call Waiting Service Users

- Press **FLASH** lightly if you hear a call-waiting tone while talking.
- The first call is put on hold and you can answer the second call.
 - To return to the first caller, press **FLASH** again.

Automatic Security Code Setting

Whenever you place the handset on the base unit, the unit automatically selects one of 65,000 security codes. These codes help to avoid unauthorized use of your telephone line by another cordless telephone.

Temporary Tone Dialing (For Rotary Service Users)

- Press **TONE** before entering access numbers which require tone dialing.
- The dialing mode changes to tone. You can enter numbers to access an answering service, electronic banking services, etc. When you hang up, the mode returns to pulse.

If Your Unit is Connected to a PBX (Analog Only)

- We recommend you press **REDIAL/PAUSE** or **PAUSE** between the access number for an outside line and the phone number.
- Pressing **REDIAL/PAUSE** or **PAUSE** once creates a 3.5 second pause. This prevents misdialing when you redial or dial a stored number. (**REDIAL/PAUSE** or **PAUSE** counts as one digit.)

Automatic Answering Operation

When the unit answers a call, the unit plays back your greeting message and records the caller's message.

- The total recording time (including the greeting message) is **about 16 minutes**. If messages are recorded in noisy rooms, the time may be shortened up to 5 minutes.
- A maximum of 64 messages can be recorded.

Setting the Unit to Answer Calls

Press **ANSWER ON** to turn on the answering system.

- The indicator lights and "Answer set" is heard.
- The unit will announce the remaining recording time if it is less than 5 minutes.
- If you hear "Memory full" and the indicator flashes rapidly, erase some or all of the messages (p. 36).

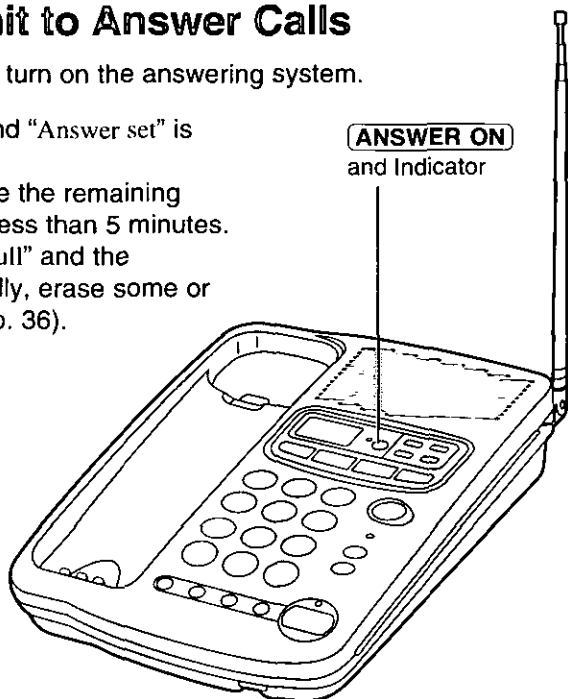

- If you do not want the unit to answer calls, press **ANSWER ON** to turn the answering system off. The indicator light goes out and "Answer off" is heard.
- You can also turn on the answering system remotely using any phone (p. 45).

Monitoring incoming calls

While a call is being recorded, you can monitor it through the speaker. To answer the call with the speakerphone, press **DIGITAL SP-PHONE** or **REMOTE SP**. For the handset, lift the handset off the base unit or press **TALK**. The unit stops recording.
(To monitor incoming calls with the handset, see page 48).

Listening to Messages

You can see the total number of recorded messages on the display. If the ANSWER ON indicator flashes, new messages have been recorded.

Listening to new messages only

Press **NEW MESSAGE** lightly.

- o The unit announces the number of new messages and plays them back.

Listening to all of the recorded messages

Press and hold **NEW MESSAGE** firmly until a short beep sounds.

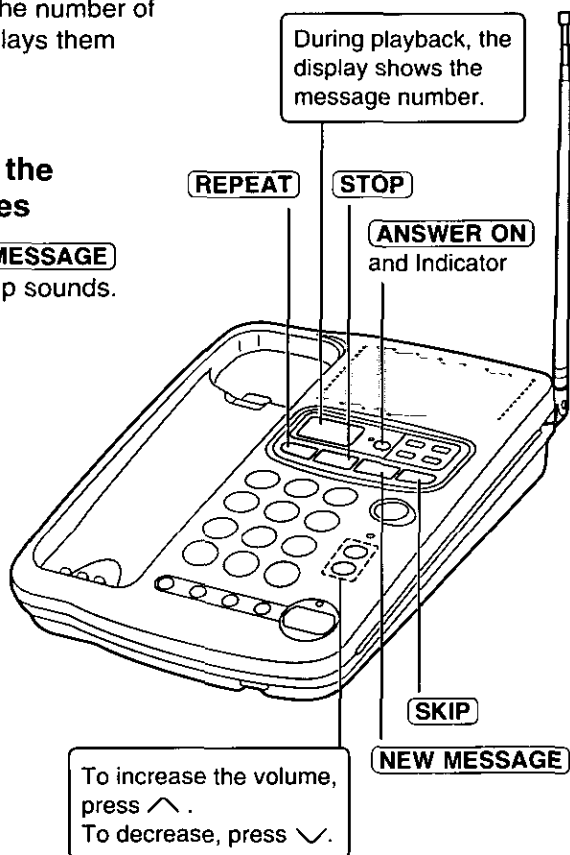

At the end of the last message, "End of final message" is heard. 7 seconds after the announcement, the unit will automatically turn the answering system back on.

During playback

To repeat the message	Press REPEAT during playback. (If you press within 5 seconds of playback, the previous message will be played.)
To skip the message	Press SKIP during playback. The next message is played.
To stop the operation	Press STOP . ◦To resume playback, press NEW MESSAGE . To turn on the answering system, press ANSWER ON .

Flash Memory Message Backup

Messages are stored in a “flash memory” IC chip for long term storage—even if a power failure occurs. All of the messages are saved until you erase them.

Erasing Messages

The unit will announce the remaining recording time after playback if it is less than 5 minutes. New messages cannot be recorded when:

- “Memory full” is heard.
- “**FULL**” is displayed.
- the ANSWER ON indicator flashes rapidly.

Erase some or all of the messages. We recommend you erase unnecessary messages after each playback.

Erasing a specific message

Press **ERASE** while the message you want to erase is being played.

- The unit erases the message.
- A series of beeps will sound and the unit continues to play the next message.

Erasing all of the messages

All of the recorded messages except the greeting message can be erased at one time.

- 1 Press **ERASE**.
 - “Press ERASE again to erase all messages.” is heard.
- 2 Within 5 seconds, press **ERASE** again.
 - A series of beeps and “No message” are heard.
 - The display shows “0”.

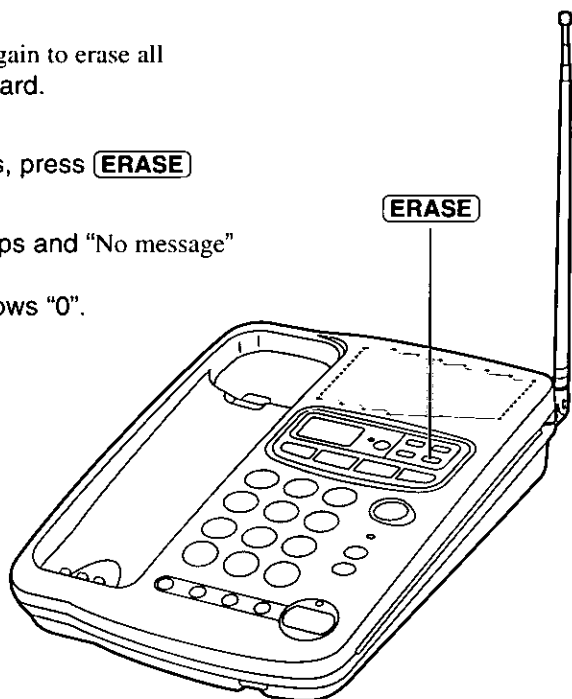

Recording a Memo Message

You may record a personal message in memory.

- 1 Press **MEMO**.
 - A long beep sounds.
- 2 After the beep, speak clearly about 8 inches (20 cm) away from the **MIC**.
 - The display shows the elapsed recording time.
- 3 When finished, press **STOP**.
 - A beep sounds.

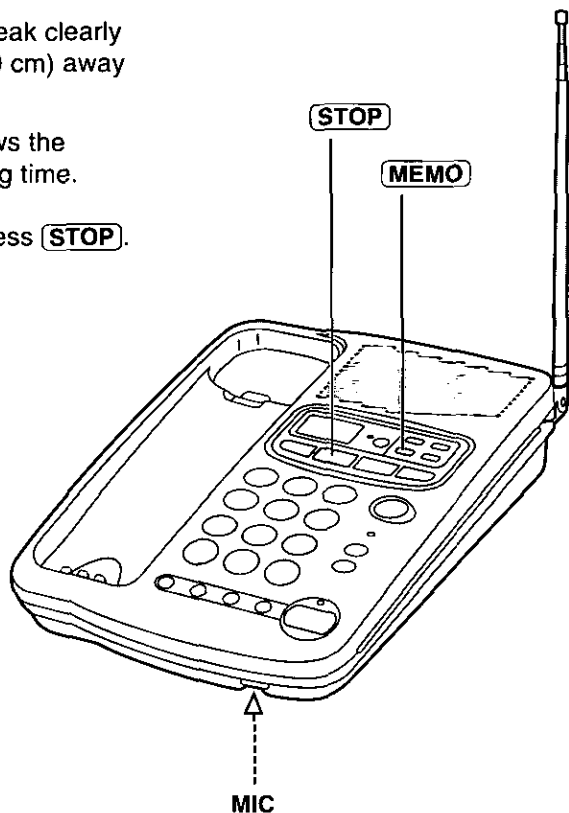

Pager Call

This feature allows you to alert your pager when the unit records an incoming message. You can retrieve the message from a touch tone telephone (p. 40). First store the pager number, then turn on the pager call mode.

The TALK and DIGITAL SP-PHONE indicator lights must be off before programming.

Storing the Pager Number

- 1 Press **PROGRAM/2WAY REC**.
 - The TALK indicator flashes.
- 2 Press **SCREEN/PLAYBACK**.
 - The indicator lights.
 - “P” is displayed on the base unit.
- 3 Press **#**.
- 4
 - a) Enter your pager number. (If necessary, press **REDIAL/PAUSE** twice.)*
 - b) Enter the call back number to be displayed on the pager. (Press **#** if required by your pager company.)
 - If you misdial, press **PROGRAM/2WAY REC** then restart from step 1.
 - You can enter up to 48 digits total.
- 5 When finished, press **PROGRAM/2WAY REC**.
 - The indicator lights go out.

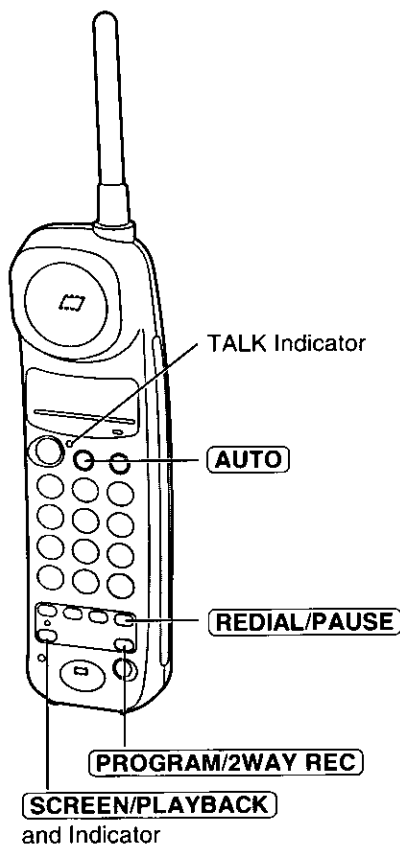

*Your pager company may require a delay after the pager number is dialed. Contact your pager company regarding the required pause time. Pressing **REDIAL/PAUSE** once creates a 3.5 second delay and counts as one digit.

To confirm the stored pager number

Press **TALK** ⇨ **AUTO** ⇨ **#**.

- The unit dials the stored number.
- If the pager does not beep, restart from step 1 to store the number again.

To erase the stored pager number

Press **PROGRAM/2WAY REC** ⇨ **SCREEN/PLAYBACK** ⇨ **#** ⇨
⇨ **PROGRAM/2WAY REC**.

Setting the Unit to Call the Pager

- 1 Press **SCREEN/PLAYBACK**.
 - The indicator lights.
 - The number of recorded messages is heard* (p. 47).
- 2 Press **3**.
 - “**PAGER**” is displayed on the base unit.
 - If 6 beeps sound at the handset, the pager number is not stored. Store the number, then try again.
- 3 When finished, press **SCREEN/PLAYBACK**.
 - The indicator light goes out.

To turn off the pager call mode, repeat steps 1 through 3.

- “**PAGER**” will disappear.
- Each time you press **3** in step 2, the mode will turn on or off alternately.

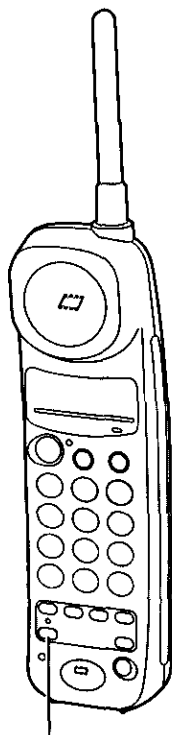

SCREEN/PLAYBACK
and Indicator

Remote Operation from a Touch Tone Phone

You can operate the answering system from any touch tone phone. A synthesized voice menu will guide you on how to operate the unit (p. 42).

- To skip the voice menu and operate the unit directly, see page 44.

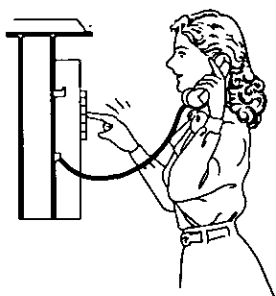

Summary of the remote operation

Call your unit from a touch tone phone.



During/after the greeting message playback, enter your remote code (p. 41).
◦ The number of recorded messages is heard.*



After 3 seconds, the voice menu starts (p. 42).
Follow the menu or enter the direct remote commands (p. 44).



To end the remote operation, hang up.
◦ You will not lose any messages when you hang up.

*The number of messages depends on the currently selected number of rings setting (p. 18).

For the AUTO setting, the number of new messages is heard.

For all other settings, the total number of messages is heard.



Setting the Remote Code

The remote code prevents unauthorized persons from accessing your unit and listening to your messages. Choose any **2-digit number (00–99)**. The factory preset is "11".

The TALK and DIGITAL SP-PHONE indicator lights must be off before programming.

1 Press **PROGRAM/2WAY REC**.

◦The TALK indicator flashes.

2 Press **SCREEN/PLAYBACK**.

◦The indicator lights.

◦"P" is displayed on the base unit.

3 Press **1**.

◦The current remote code is displayed.

4 Enter a remote code by using a **2-digit number (00–99)**.

◦The entered number is displayed.

5 When finished, press **PROGRAM/2WAY REC**.

◦The indicator lights go out.

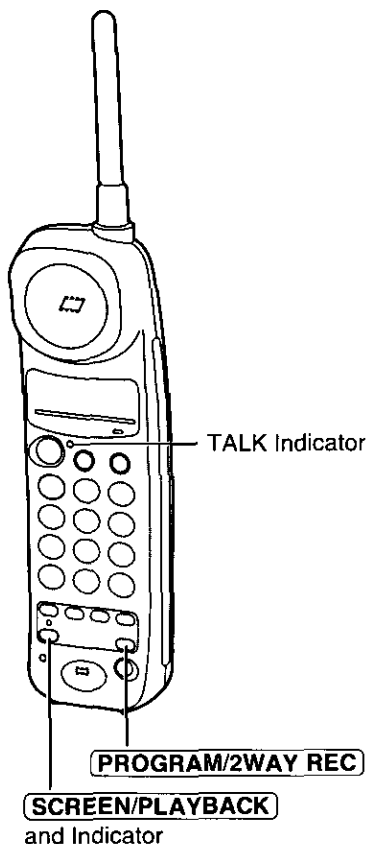

◦If 6 beeps sound in step 5, you entered a one digit number. Restart from step 1 to program a 2-digit number.

◦If you want to use a single number remote code, enter "0" first, then the number.

To check the remote code

Press **PROGRAM/2WAY REC** ⇒ **SCREEN/PLAYBACK** ⇒ **1**.

The current remote code is displayed. When finished, press

PROGRAM/2WAY REC.

➤ Remote Operation from a Touch Tone Phone

Voice Menu

Shaded boxes are voice prompts.

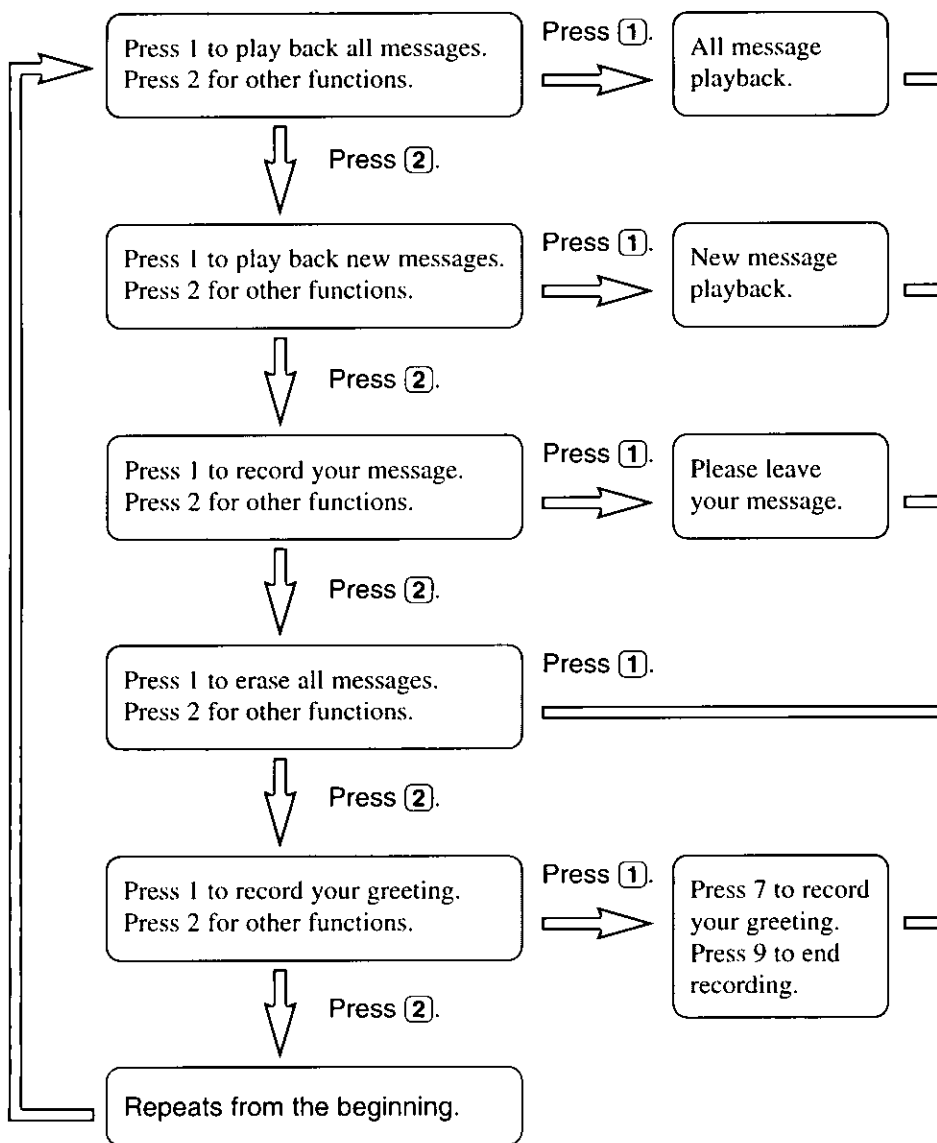



All Message Playback

The unit plays back all of the recorded messages. At the end of the last message, "End of final message" and the remaining recording time are announced.



New Message Playback

The unit plays back messages which have not been played yet.



Recording a Memo Message

You can leave a personal message.

1. Speak after you hear "Please leave your message."
2. When you finish recording, hang up.



Erasing All Messages

All of the recorded messages (except the greeting message) are erased.



Recording a Greeting Message

You can re-record your greeting message.

1. Press **7**.
You hear a voice prompt followed by a long beep.
2. Speak after the long beep.
3. When you finish recording, press **9**.
4. Your greeting will be played back for confirmation.

- o 3 seconds after playback, the voice menu will repeat from the beginning.
- o If you hear "Memory full" after playback, erase some or all of the messages (p. 44).

➤ Remote Operation from a Touch Tone Phone

Direct Remote Operation

Once you have entered the remote code, you can also control your unit by direct remote commands instead of using the voice menu. To end the remote operation, hang up anytime.

Direct commands

NEW MESSAGE
PLAYBACK

4

◦ Only new messages are played back.

ALL MESSAGE
PLAYBACK

5

◦ All of the messages are played back.

REPEAT
(During playback)

1

◦ The current message is repeated.

SKIP
(During playback)

2

◦ The current message is skipped.
The next message is played.

STOP
(During playback)

9

◦ Playback is stopped temporarily.
◦ To resume playback, press (9) again within 15 seconds or the voice menu will start.

GREETING
MESSAGE
RECORDING

7

◦ A long beep sounds.



RECORD

◦ Speak immediately after the long beep.



9

◦ Recording is stopped.
◦ The recorded message is played.

ERASING A
SPECIFIC
MESSAGE
(During playback)

* 4

◦ The current message is erased.
◦ A series of beeps will sound and the next message is played.

ERASING ALL
MESSAGES

* 5

◦ All of the recorded messages are erased.
◦ A series of beeps and "No message" are heard.

PAGER CALL
ON/OFF

3

- Each time you press **3**, the mode will turn on/off alternately.
- 2 beeps sound and "on/off" is heard.
- If you did not store a pager number, 6 beeps sound and the mode will not turn on.

ANSWERING
SYSTEM OFF

0

- The unit hangs up and will not answer calls until turned on again.
-

Turning on the answering system

Call your unit and wait for 15 rings.

- The unit will answer and the greeting message is played.
- The answering system will turn on. Hang up or enter the remote code for other options.
- When turning on the answering system using a rotary service telephone, you cannot enter the remote code for other options.

Skipping the greeting message

After calling your unit, press ***3** during the greeting message playback.

- The unit skips the rest of the greeting and callers can start recording their message after the long beep.

Remote Operation with the Handset

You can operate your answering system with the handset.

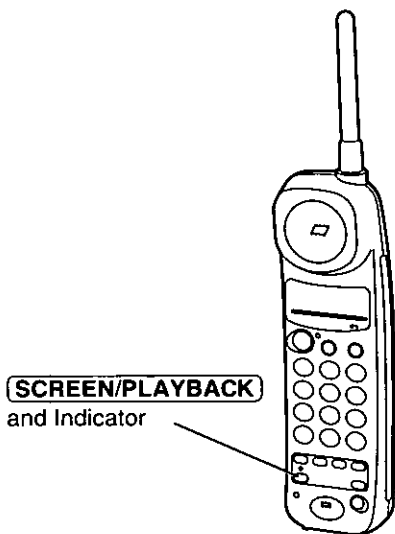

Summary of the remote operation

Press **SCREEN/PLAYBACK**.

- The indicator lights.
- The number of recorded messages is heard.*



◦If the SCREEN/PLAYBACK indicator flashes, the answering system is off. To turn it on, press **8**.

Press the desired command buttons (see the following pages).

- If you do not press any command, the voice menu will start.**
- 5 seconds after the voice menu, all message playback will start.



To end the remote operation, press **SCREEN/PLAYBACK**.

- You will not lose any messages when you hang up.

◦If you hear "Memory full" after playback, erase some or all of the messages (p. 47).

◦When an incoming message has been recorded, 4 short beeps sound two times on the handset.



*The number of messages depends on the currently selected number of rings setting (p. 18).

For the AUTO setting, the number of new messages is heard.

For all other settings, the total number of messages is heard.

**Voice menu

If no commands are given after you press **SCREEN/PLAYBACK**, the unit will start the following voice menu.

“Press 4 to play back new messages; Press 5 to play back all messages.”

◦You can enter direct commands even when the voice menu has started.

Direct commands

NEW MESSAGE PLAYBACK	4	◦Only new messages are played back.
ALL MESSAGE PLAYBACK	5	◦All of the messages are played back.
REPEAT (During playback)	1	◦The current message is repeated.
SKIP (During playback)	2	◦The current message is skipped. The next message is played.
STOP (During playback)	9	◦Playback is stopped temporarily. ◦To resume playback, press 9 again within 15 seconds or the voice menu will start.
ERASING A SPECIFIC MESSAGE (During playback)	* 4	◦The current message is erased. ◦A series of beeps will sound and the next message is played.
ERASING ALL MESSAGES	* 5	◦All of the recorded messages are erased. ◦A series of beeps and “No message” are heard.

(continued ⇨)

Remote Operation with the Handset

PAGER CALL
ON/OFF

3

- Each time you press **3**, the mode will turn on/off alternately.
- 2 beeps sound and "on/off" is heard.
- If you did not store a pager number, 6 beeps sound and the mode will not turn on.

ANSWERING
SYSTEM OFF

0

- The SCREEN/PLAYBACK indicator flashes.

ANSWERING
SYSTEM ON

8

- The SCREEN/PLAYBACK indicator lights.

Monitoring incoming calls with the handset

When an incoming message is being recorded, the SCREEN/PLAYBACK indicator flashes slowly.

1. Press **SCREEN/PLAYBACK**.
 - The indicator lights and you can listen to the incoming call.
 - To answer the call, press **TALK**. The recording is ended.
2. When finished monitoring the call, press **SCREEN/PLAYBACK**.

Recording your telephone conversation with the handset

1. During a conversation with the handset, press **PROGRAM/2WAY REC**.
 - The SCREEN/PLAYBACK indicator lights.
2. Continue your conversation.
3. When finished recording the conversation, press **PROGRAM/2WAY REC**.
 - The SCREEN/PLAYBACK indicator light goes out.

Many states have imposed regulations on the manner in which 2-way telephone conversations may be recorded, so you should inform the other party that the conversation is being recorded. Consult your local telephone company for further information.



OPERATION WITH THE HANDSET

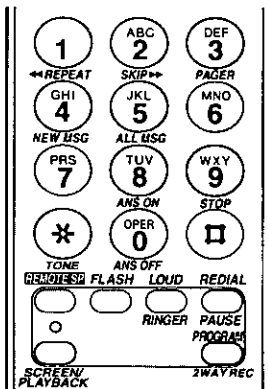

- If the **SCREEN/PLAYBACK** indicator flashes when you press **SCREEN/PLAYBACK**, the answering system is off. To turn it on, press "8".

Press **SCREEN/PLAYBACK**.



- Press the desired command number as below.
- To play back new messages, press "4".
 - To play back all messages, press "5".
 - To repeat, press "1".
 - To skip, press "2".
- (For more functions, see the reverse side.)



To end the remote operation, press **SCREEN/PLAYBACK**.

OPERATION FROM A TOUCH TONE PHONE

Call your unit.



Enter your remote code _____.



Press the desired direct command number as shown here.
OR
Wait for 3 seconds and the unit will start the voice menu.
Follow the instructions. (See reverse side.)



To end the remote operation, hang up.

No.	Direct Commands
1	Repeat the message
2	Skip the message
3	Pager call on/off
4	New message playback
5	All message playback
7	Recording your greeting
9	Stop
0	Answer off
*	Greeting message skip
*4	Erasing a specific message
*5	Erasing all messages

- When you press a button, press firmly.

➤ Remote Operation Card

Press **SCREEN/PLAYBACK**.



- **To erase a specific message,** press “*4” during the message playback.
- **To erase all messages,** press “*5”.
- **To turn on/off the pager call feature,** press “3”.
- **To turn off the answering system,** press “0”.



To end the remote operation, press **SCREEN/PLAYBACK**.

- **To use the voice menu:**

Call your unit.



Enter your remote code ____.



After 3 seconds, the unit starts the voice menu.



Press “1” to use the voice feature.
OR
Press “2” to proceed with other functions.



To end the remote operation, hang up.

- **To monitor incoming calls:** When the SCREEN/PLAYBACK indicator flashes slowly, press **SCREEN/PLAYBACK**. When finished, press the button again. To answer the call, press **TALK**.
- **To stop playback temporarily:** Press “9” during playback. To resume playback, press “9” again within 15 seconds.
- **To record a telephone conversation:** Press **PROGRAM/2WAY REC**. When finished, press **PROGRAM/2WAY REC** again.

- **To turn on the answering system:** Call your unit and wait for 15 rings. The unit will answer, then hang up.
- **To skip the greeting message:** After calling your unit, press “*” during the greeting message playback. Callers can start recording their message after the long beep.

Battery Replacement

If the BATT LOW indicator flashes after being fully charged, replace the battery with a new Panasonic P-P301 (KX-A36A) battery. (To order, call 1-800-332-5368.) To prevent memory loss, replace within 5 minutes.

- 1 Remove the cover by sliding it while pressing the arrow.

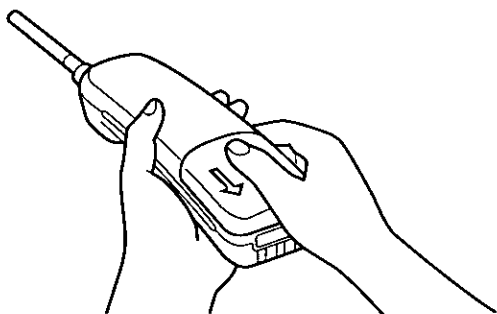

- 2 Replace the battery, then close the cover.

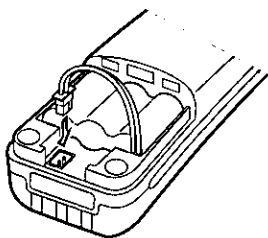

- 3 Be sure to charge the new battery for about 10 hours.

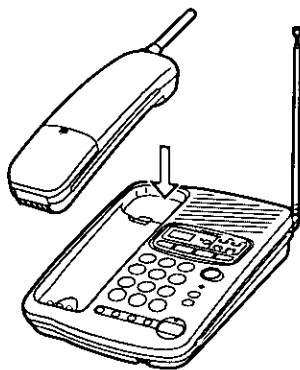

Attention:

The product you have purchased is powered by a nickel cadmium battery which is recyclable. At the end of its useful life, under various state and local laws, it is illegal to dispose of this battery into your municipal waste stream. Please call 1-800-8-BATTERY for information on how to recycle this battery.



Wall Mounting

This unit can be mounted on a wall phone plate.

- 1 Connect the AC adaptor.

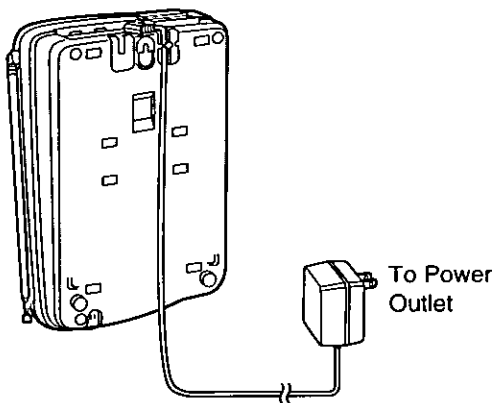

- 2 Tuck the telephone line cord inside the wall mounting adaptor.

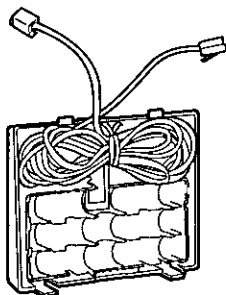

- 3
- 1 Insert the tabs of the wall mounting adaptor into the "WALL" openings in the unit.
 - 2 Push the adaptor in the direction of the arrow.
- o "UP WALL" should face upward.

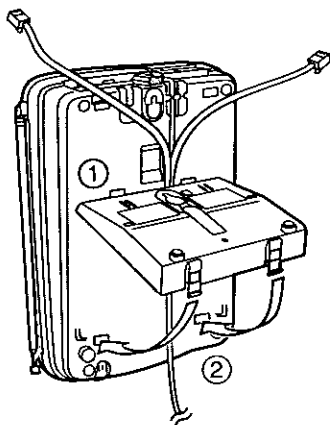

- 4** Connect the telephone line cord. Mount the unit, then slide down.

◦Extend the antenna fully.

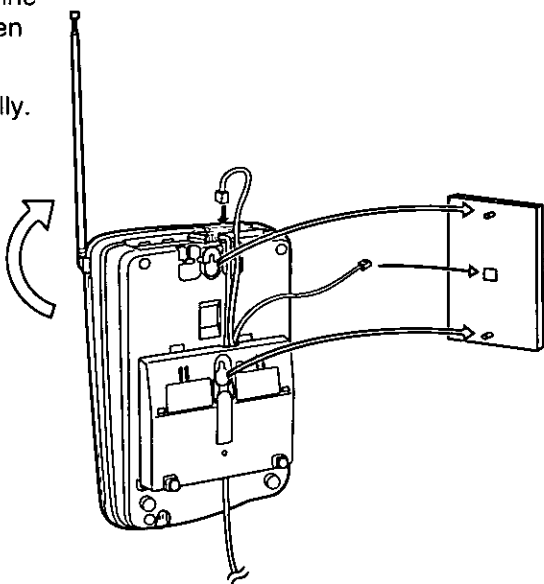

- 5** Pull down the handset hook until it locks **so the tab holds the handset.**

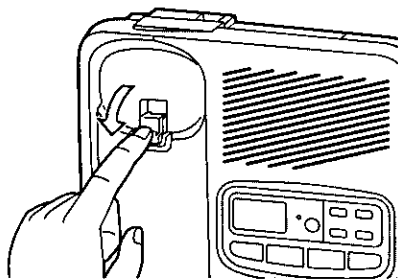

- 6 To charge the battery:** Place the handset on the handset hook as shown.

◦The IN USE/CHARGE indicator lights.

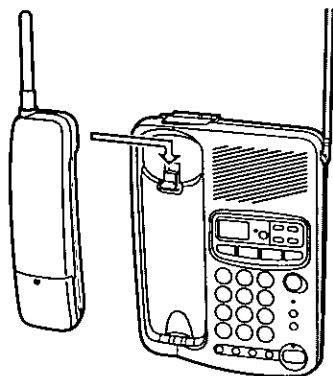

Convenient Desk Usage

The wall mounting adaptor can also be used to raise the unit at an angle.

- ① Insert the tabs of the wall mounting adaptor into the "DESK" openings in the unit.
- ② Push the adaptor in the direction of the arrow.
 - o "UP DESK" should face upward.

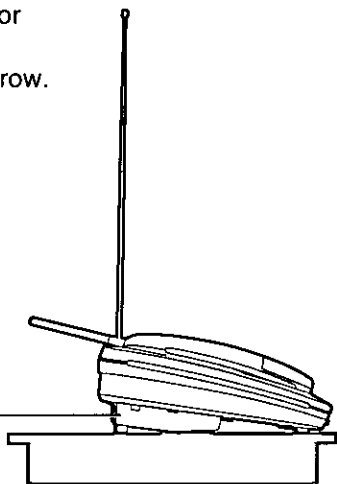
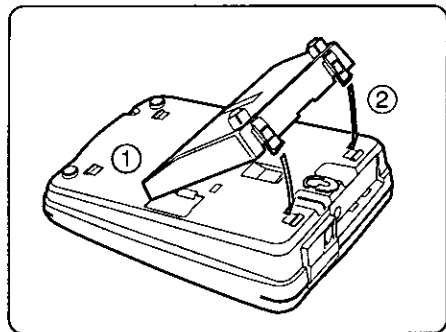

o It is not necessary to pull down the handset hook (p. 6).

Adding Another Phone

This unit will not function during a power failure. To connect a standard telephone on the same line, use a Panasonic T-adaptor KX-J66. (To order, call 1-800-332-5368.)

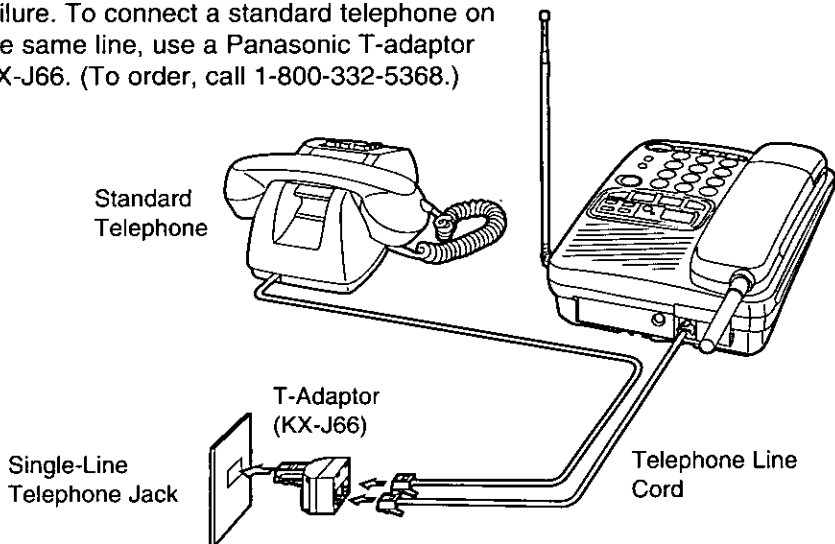



Cordless Telephone

Problem	Remedy
An alarm tone sounds when you press TALK , REMOTE SP , SCREEN/PLAYBACK or INTERCOM .	<ul style="list-style-type: none">◦ You are too far from the base unit. Move closer and try again.◦ Place the handset on the base unit and try again.◦ Plug in the AC adaptor.◦ Extend the base unit antenna fully.
Static, sound cuts in/out, fades. Interference from other electrical units.	<ul style="list-style-type: none">◦ Set the handset and the base unit away from other electrical appliances (p. 3).◦ Move closer to the base unit.◦ Extend the base unit antenna fully.◦ Press CH to select a clearer channel.
The handset does not ring.	<ul style="list-style-type: none">◦ The ringer volume is set to OFF. Press LOUD/RINGER lightly while the TALK indicator light is off (p. 21).
The base unit does not ring.	<ul style="list-style-type: none">◦ The ringer volume is set to OFF. Press HOLD/RINGER lightly while the DIGITAL SP-PHONE indicator light is off (p. 24).
You cannot store a phone number in memory.	<ul style="list-style-type: none">◦ You cannot store a number while the unit is in the talk, speakerphone or intercom mode.◦ Do not pause for over 30 seconds while storing.
While storing a phone number, the unit starts to ring.	<ul style="list-style-type: none">◦ To answer the call, press TALK, REMOTE SP or DIGITAL SP-PHONE. The program will be canceled. Store the number again.
LOCATOR/INTERCOM does not function.	<ul style="list-style-type: none">◦ The handset is too far from the base unit or is engaged in an outside call.
REDIAL/PAUSE does not function properly.	<ul style="list-style-type: none">◦ It will redial the last dialed number if pressed at the outset of a call (p. 20). If another number has been dialed first, it will operate as a pause button (p. 32).

➤ Before Requesting Help

Answering System

Problem	Remedy
The answering system is on, but no incoming messages are recorded.	<ul style="list-style-type: none">◦The recording time is set to "greeting only". Select "1 minute" or "unlimited" (p. 17).◦Memory is full. Erase some or all of the messages (p. 36).
" FULL " is displayed and the ANSWER ON indicator flashes rapidly, and no new messages are recorded.	<ul style="list-style-type: none">◦Memory is full. Erase some or all of the messages (p. 36). If "FULL" is still displayed and the ANSWER ON indicator flashes rapidly, erase your greeting message and re-record a shorter greeting (p. 13, 14).
Some incoming messages have not been recorded completely.	<ul style="list-style-type: none">◦Set the CPC function to "b" (p. 19).
You cannot operate the answering system at the base unit.	<ul style="list-style-type: none">◦The handset user is operating the answering system. Wait until the IN USE/CHARGE indicator light goes out.
You cannot operate the answering system from a touch tone phone.	<ul style="list-style-type: none">◦Be sure to press the correct remote code.◦The answering system may not respond if the phone produces tones which are too short to activate the unit. Press each button firmly.◦The answering system is off. Turn it on (p. 45).
You cannot operate the answering system with the handset.	<ul style="list-style-type: none">◦Someone is operating the answering system.◦You are too far from the base unit. Move closer to the base unit.

General

Problem	Remedy
The unit does not work.	<ul style="list-style-type: none">◦ Check the settings (p. 10–12).◦ Charge the battery fully (p. 11).◦ Clean the charge contacts and charge again (p. 11).◦ Install the battery properly (p. 51).◦ Place the handset on the base unit and unplug the AC adaptor to reset. Plug in, then try again.◦ Re-insert the handset battery within 5 minutes to avoid memory loss and place the handset on the base unit. Then try again.
You cannot program items such as the time/day adjustment (p. 16).	<ul style="list-style-type: none">◦ Programming is not available while the unit is in the talk, speakerphone or intercom mode.◦ Move closer to the base unit.
The BATT LOW indicator flashes or the unit beeps intermittently.	<ul style="list-style-type: none">◦ Charge the battery fully (p. 11).
You charged the battery fully, but the BATT LOW indicator flashes.	<ul style="list-style-type: none">◦ Clean the charge contacts and charge again (p. 11).◦ Install a new battery (p. 51).
The IN USE/CHARGE indicator light never goes out while charging.	<ul style="list-style-type: none">◦ This is normal.
If you cannot solve your problem.	<ul style="list-style-type: none">◦ Call our customer satisfaction center at 1-800-922-0028.

Important Safety Instructions

When using this unit, basic safety precautions should always be followed to reduce the risk of fire, electric shock, or personal injury.

1. Read and understand all instructions.
2. Follow all warnings and instructions marked on this unit.
3. Unplug this unit from AC outlets before cleaning. Do not use liquid or aerosol cleaners. Use a damp cloth for cleaning.
4. Do not use this unit near water, for example, near a bathtub, washbowl, kitchen sink, or the like.
5. Place this unit securely on a stable surface. Serious damage and/or injury may result if the unit falls.
6. Do not cover slots and openings on the unit. They are provided for ventilation and protection against overheating. Never place the unit near radiators, or in a place where proper ventilation is not provided.
7. Use only the power source marked on the unit. If you are not sure of the type of power supplied to your home, consult your dealer or local power company.
8. Do not place objects on the power cord. Install the unit where no one can step or trip on the cord.
9. Do not overload wall outlets and extension cords. This can result in the risk of fire or electric shock.
10. Never push any objects through slots in this unit. This may result in the risk of fire or electric shock. Never spill any liquid on the unit.
11. To reduce the risk of electric shock, do not disassemble this unit. Take the unit to an authorized servicer when service is required. Opening or removing covers may expose you to dangerous voltages or other risks. Incorrect reassembly can cause electric shock when the unit is subsequently used.
12. Unplug this unit from the wall outlet and refer servicing to an authorized servicer when the following conditions occur:
 - A. When the power supply cord or plug is damaged or frayed.
 - B. If liquid has been spilled into the unit.
 - C. If the unit has been exposed to rain or water.
 - D. If the unit does not work normally by following the operating instructions. Adjust only controls covered by the operating instructions. Improper adjustment may require extensive work by an authorized servicer.
 - E. If the unit has been dropped or physically damaged.
 - F. If the unit exhibits a distinct change in performance.
13. During thunderstorms, avoid using telephones except cordless types. There may be a remote risk of an electric shock from lightning.
14. Do not use this unit to report a gas leak, when in the vicinity of the leak.

SAVE THESE INSTRUCTIONS

CAUTION:

To reduce the risk of fire or injury to persons, read and follow these instructions.

1. Use only the battery(ies) specified.
2. Do not dispose of the battery(ies) in a fire. They may explode. Check with local waste management codes for special disposal instructions.
3. Do not open or mutilate the battery(ies). Released electrolyte is corrosive and may cause burns or injury to the eyes or skin. The electrolyte may be toxic if swallowed.
4. Exercise care in handling batteries in order not to short the battery to conductive materials such as rings, bracelets, and keys. The battery and/or conductor may overheat and cause burns.
5. Charge the battery(ies) provided with or identified for use with this product only in accordance with the instructions and limitations specified in this manual.

WARNING:

TO PREVENT FIRE OR SHOCK HAZARD, DO NOT EXPOSE THIS PRODUCT TO RAIN OR ANY TYPE OF MOISTURE.

FCC and Other Information

If requested by the telephone company, inform them as follows:

FCC Registration No.(found on the bottom of the unit)

Ringer Equivalence0.2B

The particular telephone line to which the equipment is connected.

This unit must not be connected to a coin operated line.

If you are on a party line, check with your local telephone company.

Ringer Equivalence No. (REN):

The REN is useful in determining the quantity of devices you may connect to your telephone line and still have all of those devices ring when your telephone number is called. In most, but not all areas, the sum of the REN's of all devices connected to one line should not exceed five (5.0). To be certain of the number of devices you may connect to your line, as determined by the REN, you should contact your local telephone company to determine the maximum REN for your calling area.

In the event terminal equipment causes harm to the telephone network, the telephone company should notify the customer, if possible, that service may be stopped.

However, where prior notice is impractical, the company may temporarily cease service providing that they:

- (a) Promptly notify the customer.
- (b) Give the customer an opportunity to correct the problem with their equipment.
- (c) Inform the customer of the right to bring a complaint to the Federal Communication Commission pursuant to procedures set out in FCC Rules and Regulations Subpart E of Part 68.

The Telephone Company may make changes in its communications facilities, equipment, operations or procedures, where such action is reasonably required in the operation of its business and is not inconsistent with the rules and regulations in FCC Part 68.

If such changes can be reasonably expected to render any customer terminal equipment incompatible with telephone company communications facilities, or require modification or alteration of such terminal equipment, or otherwise materially affect its use or performance, the customer shall be given adequate notice in writing, to allow the customer an opportunity to maintain uninterrupted service.

When programming emergency numbers and/or making test calls to emergency numbers:

1. Remain on the line and briefly explain to the dispatcher the reason for the call before hanging up.
2. Perform such activities in the off-peak hours, such as early morning hours or late evenings.

This device complies with Part 15 of the FCC Rules. Operation is subject to the following two conditions: (1) This device may not cause harmful interference, and (2) this device must accept any interference received, including interference that may cause undesired operation.

Privacy of communications may not be ensured when using this phone.

CAUTION:

Any changes or modifications not expressly approved by the party responsible for compliance could void the user's authority to operate this device.

Note:

This equipment has been tested and found to comply with the limits for a Class B digital device, pursuant to Part 15 of the FCC Rules. These limits are designed to provide reasonable protection against harmful interference in a residential installation. This equipment generates, uses, and can radiate radio frequency energy and, if not installed and used in accordance with the instructions, may cause harmful interference to radio communications. However, there is no guarantee that interference will not occur in a particular installation. If this equipment does cause harmful interference to radio or television reception, which can be determined by turning the equipment off and on, the user is encouraged to try to correct the interference by one or more of the following measures:

- Reorient or relocate the receiving antenna.
- Increase the separation between the equipment and receiver.
- Connect the equipment into an outlet on a circuit different from that to which the receiver is connected.
- Consult the dealer or an experienced radio/TV technician for help.

Some cordless telephones operate at frequencies that may cause interference to nearby TVs and VCRs. To minimize or prevent such interference, the base of the cordless telephone should not be placed near or on top of a TV or VCR. If interference is experienced, move the cordless telephone further away from the TV or VCR. This will often reduce or eliminate interference.

- Environment**—do not place the unit in room where the temperature is less than 5°C (41°F) or greater than 40°C (104°F). Allow 10 cm (4") clearance around the unit for proper ventilation. Avoid excessive smoke, dust, mechanical vibration, shock, or direct sunlight.
- Routine care**—wipe the unit with a soft cloth. Do not use benzine, thinner, or any abrasive powder. When you left the unit unused for long time, unplug the AC adaptor from the outlet.
- If there is any trouble**—disconnect the unit from the telephone line and connect a known working phone. If the known working phone operates properly, have your unit repaired by one of the authorized Panasonic Factory Service Centers. If the known working phone does not operate properly, consult with your telephone company.

For product service

- Panasonic Servicenters are listed in the servicenter directory.
- Call 1-800-545-2672 for the location of an authorized servicenter.

When you ship the product

- Carefully pack your unit, preferably in the original carton.
- Attach a letter, detailing the symptom, to the outside of the carton.

Symptom

- Send the unit to an authorized servicenter, prepaid and adequately insured.
- Do not send your unit to the Panasonic Consumer Electronics Company listed on the back cover or to executive or regional sales offices. These locations do not repair consumer products.

- This cordless telephone is designed for use in the United States of America. Sale or use of this product in other countries may violate local laws.
- Ce téléphone sans fil est conçu pour être utilisé aux États-Unis d'Amérique. La vente ou l'emploi de cet appareil dans certains autres pays peut constituer une infraction à la législation locale.
- Este teléfono sin cordón fue elaborado para uso en los Estados Unidos de América. La venta o el empleo de este producto en ciertos países puede constituir violación de la legislación local.
- このコードレス電話機は、日本国外での使用を目的として設計されており、日本国内での使用は法律違反となります。従って、当社では日本国内においては原則として修理などのサービスは致しかねます。

**Panasonic Consumer Electronics Company,
Division of Matsushita Electric Corporation of America**
One Panasonic Way, Secaucus, New Jersey 07094

**Panasonic Sales Company,
Division of Matsushita Electric of Puerto Rico, Inc.**
Ave. 65 de Infantería, Km. 9.5, San Gabriel Industrial Park
Carolina, Puerto Rico 00985