



# Panasonic

2.4GHz Multi-Handset Cordless Phone System

Model No. **KX-TG2000B**

Pulse-or-tone dialing capability

## Operating Instructions



**DIGITAL**  
VOICE MAIL SYSTEM

**2-LINE**

**Caller ID Compatible**

**PLEASE READ BEFORE USE AND SAVE.**

**Charge the handset battery for about 8 hours before initial use.**

Panasonic World Wide Web address: <http://www.panasonic.com>  
for customers in the USA or Puerto Rico

# Before Initial Use

---

Please read IMPORTANT SAFETY INSTRUCTIONS on page 102 before use. Read and understand all instructions.

*Thank you for purchasing your new Panasonic cordless telephone.*

Caller ID and Call Waiting Service, where available, are telephone company services. After subscribing to Caller ID, this phone will display a caller's name and phone number. Call Waiting Caller ID, which displays a second caller's name and phone number while the user is on another call on the same line, requires a subscription to both Caller ID and Call Waiting.

**Attach your purchase receipt here.**

## For your future reference

Serial No. \_\_\_\_\_  
(found on the bottom of the unit)

Date of purchase \_\_\_\_\_

Name and address of dealer \_\_\_\_\_

## Accessories (included) For extra orders, call 1-800-332-5368.

- AC Adaptor for Base Unit (p. 13)  
Order No. PQLV12Z

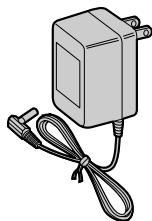

one

- AC Adaptor for Charger (p. 16)  
Order No. KX-TCA1-G

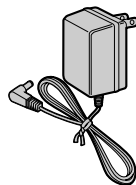

one

- Base Unit Handset (p. 13)  
Order No. PQJXF0113Z

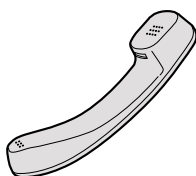

one

- Charger (p. 16)  
Order No. PQLV30001Z

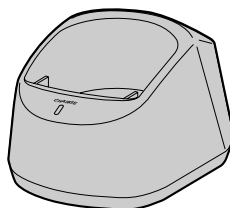

one

- 4-Wire Telephone Line Cord with Green Plugs (p. 14, 15)

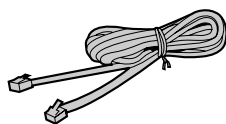

one

- 2-Wire Telephone Line Cord with Transparent Plugs (p. 15)

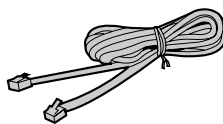

one

- Handset Cord (p. 13)  
Order No. PQJA212N

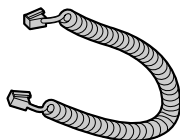

one

- Backup Battery (p. 12)  
Order No.  
P-P507 (PQP50AA61)

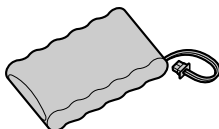

one

- Belt Clip (p. 85)  
Order No. PQKE10101Z1

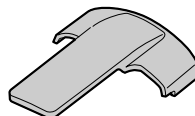

one

To use more than one cordless handset, please purchase the optional cordless handset KX-TGA200B. The charger is included. To order, contact your dealer or call 1-800-211-PANA(7262) to locate a dealer.

# For Best Performance

## Handset Battery Charge

A rechargeable Nickel-Metal Hydride (Ni-MH) battery powers the cordless handset. Charge the battery for about **8 hours** before initial use (p. 16). Make sure the handset faces forward as shown.

- If you charge the discharged battery, it will be charged quickly. In that case the handset may feel warm. This is normal.



## Base Unit Location/Noise

Calls are transmitted between the base unit and the cordless handset using wireless radio waves. **For maximum distance and noise-free operation**, the recommended base unit location is:

Away from electrical appliances such as a TV, personal computer or another cordless phone.

In a **HIGH** and **CENTRAL** location with no obstructions such as walls.

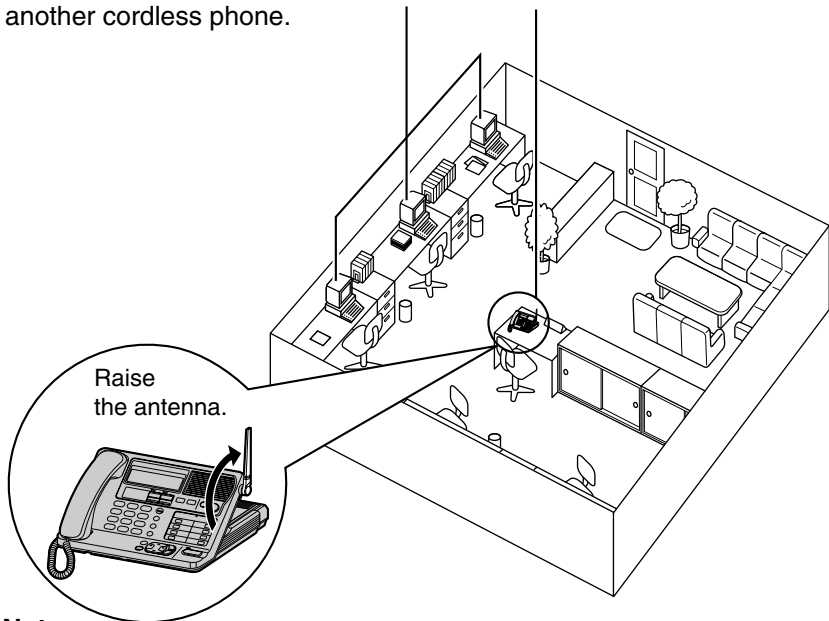

### Note:

- If you use the cordless handset near a microwave oven which is being used, noise may be heard from the receiver. Move away from the microwave oven and closer to the base unit.
- If you use the cordless handset near another phone's base unit, noise may be heard. Move away from the other cordless phone's base unit and closer to your base unit.



## Chapter 1 Preparation

<b>Location of Controls</b> .....	8
<b>Displays</b> .....	11
<b>Installation</b> .....	12
Installing the Backup Battery in the Base Unit.....	12
Connecting the Handset and AC Adaptor .....	13
Connecting the Telephone Line Cord(s).....	14
Connecting the AC Adaptor to the Charger.....	16
Handset Battery Charge .....	16
<b>Programmable Settings</b> .....	18
Programming Guidelines <b>Base Unit Handset</b> .....	18
Registration for Additional Cordless Handsets <b>Base Unit &amp; Handset</b> .....	19
Date and Time Adjustment <b>Base Unit</b> .....	20
Selecting the Dialing Mode <b>Base Unit</b> .....	21
Selecting the Ringer Volume <b>Base Unit Handset</b> .....	22
Ring Group Setting <b>Base Unit</b> .....	23
Function Menu Table <b>Base Unit Handset</b> .....	24

Chapter 1

Chapter 2

Chapter 3

## Chapter 2 Basic Operation

<b>The Unit Capabilities (Operating More than One Handset)</b> .....	25
<b>Making Calls</b> <b>Base Unit Handset</b> .....	26
With the Base Unit.....	26
With the Cordless Handset.....	28
<b>Answering Calls</b> <b>Base Unit Handset</b> .....	30
<b>Using the Other Line During a Conversation</b> <b>Base Unit Handset</b> .....	31
<b>Intercom</b> <b>Base Unit Handset</b> .....	32
Making Intercom Calls .....	32
Answering Intercom Calls .....	33
<b>Transferring a Call</b> <b>Base Unit Handset</b> .....	34
<b>Conference</b> <b>Base Unit Handset</b> .....	35
<b>Using the Directory</b> <b>Base Unit Handset</b> .....	36
Storing Names and Numbers in the Directory .....	36
Dialing from the Directory .....	38

Chapter 4

Chapter 5

### Important:

**Base Unit** : Must be carried out with the base unit.

**Handset** : Must be carried out with the cordless handset.

**Base Unit & Handset** : Must be carried out by both the base unit and cordless handset together.

**Base Unit Handset** : Must be carried out separately by the base unit and the cordless handset.

# ➔ Contents

Editing an Item in the Directory .....	39
Erasing an Item in the Directory .....	39
<b>Caller ID Service</b> .....	40
<b>Using the Caller List</b> <i>Base Unit</i> <i>Handset</i> .....	41
Viewing the Caller List .....	41
Calling Back from the Caller List .....	42
Editing the Caller's Phone Number .....	43
Storing Caller List Information in the Directory .....	44
Erasing Caller List Information .....	45

## **Chapter 3**      *Advanced Operation*

<b>Special Features</b> .....	46
How to Use the PAUSE Button <i>Base Unit</i> <i>Handset</i> (For Analog PBX Line/Long Distance Service Users) .....	46
For Call Waiting Service Users <i>Base Unit</i> <i>Handset</i> .....	46
Temporary Tone Dialing <i>Base Unit</i> <i>Handset</i> (For Rotary or Pulse Service Users) ...	46
Setting the Key Lock <i>Handset</i> .....	47
FLASH Button <i>Base Unit</i> <i>Handset</i> .....	47
<b>Other Programmable Settings</b> .....	48
Setting the Auto Talk Feature <i>Handset</i> .....	48
Selecting the Ringer Pattern <i>Base Unit</i> <i>Handset</i> .....	48
Calling Line Selection <i>Base Unit</i> <i>Handset</i> .....	49
Setting Call Restriction Numbers <i>Base Unit</i> .....	50
Incoming Call Tone <i>Base Unit</i> <i>Handset</i> .....	51
Setting the PIN <i>Base Unit</i> .....	52
Registering Optional Cordless Handsets Using the PIN <i>Base Unit &amp; Handset</i> ....	53
Canceling Cordless Handset Registration <i>Base Unit &amp; Handset</i> .....	54
Selecting the Line Mode <i>Base Unit</i> .....	55
Erasing the Directory, Caller List and Redial List <i>Base Unit</i> <i>Handset</i> .....	55

## **Chapter 4**      *Voice Mail System/Automated Attendant System/Answering System*

<b>Voice Mail System</b> .....	56
Setting the Mailbox Password <i>Base Unit</i> <i>Handset</i> .....	57
<b>Automated Attendant System</b> .....	58
How Automated Attendant System Works .....	58
Setting the Automated Attendant System <i>Base Unit</i> .....	59
Setting the Handset Answer Mode <i>Handset</i> .....	61
Recording a Personal Greeting Message <i>Handset</i> .....	62

Call Transfer Status .....	63
Call Operator Status .....	64
<b>Answering System</b> .....	65
Setting the Answering System <b>Base Unit</b> .....	65
<b>Listening to Messages with the Base Unit</b> .....	68
Transferring a Message.....	70
Erasing a Message.....	70
<b>Listening to Messages with the Cordless Handset</b> .....	71
Transferring a Message.....	72
Erasing a Message.....	73
Listening to Messages in the General Delivery Mailbox.....	73
<b>Delivering Your Own Message</b> <b>Base Unit</b> <b>Handset</b> .....	74
<b>Other Voice Mail System Features</b> .....	75
Call Monitoring Feature <b>Base Unit</b> .....	75
Recording Mode <b>Base Unit</b> .....	75
Transferring a Call to a Personal Mailbox <b>Base Unit</b> .....	76
Checking the Remaining Recording Time and Number of Messages <b>Base Unit</b> ..	76
Message Menu Mode <b>Base Unit</b> <b>Handset</b> .....	77
Automatic Message Delete Feature <b>Base Unit</b> .....	77
Erasing All Messages in Mailboxes <b>Base Unit</b> .....	78
<b>Remote Operation from a Touch Tone Phone</b> .....	79
How to Access the Voice Mail System .....	79
<b>Pager Call</b> <b>Base Unit</b> <b>Handset</b> .....	82
Storing a Pager Number .....	82
Storing the Pager Display Number .....	83
Setting the Unit to Call a Pager .....	84

## **Chapter 5**      *Useful Information*

<b>Using the Handset Belt Clip</b> .....	85
<b>Wall Mounting for the Charger</b> .....	85
<b>Using an Optional Headset</b> <b>Base Unit</b> <b>Handset</b> .....	86
<b>Clearing Settings</b> <b>Base Unit</b> <b>Handset</b> .....	89
<b>Handset Battery Replacement</b> .....	90
<b>Backup Battery Replacement</b> .....	90
<b>RESET Button</b> .....	91
<b>Adding Another Phone</b> .....	91
<b>Error Messages</b> .....	92
<b>Before Requesting Help</b> .....	95
<b>Important Safety Instructions</b> .....	102
<b>FCC and Other Information</b> .....	104
<b>Index</b> .....	106

# Location of Controls

## Base unit

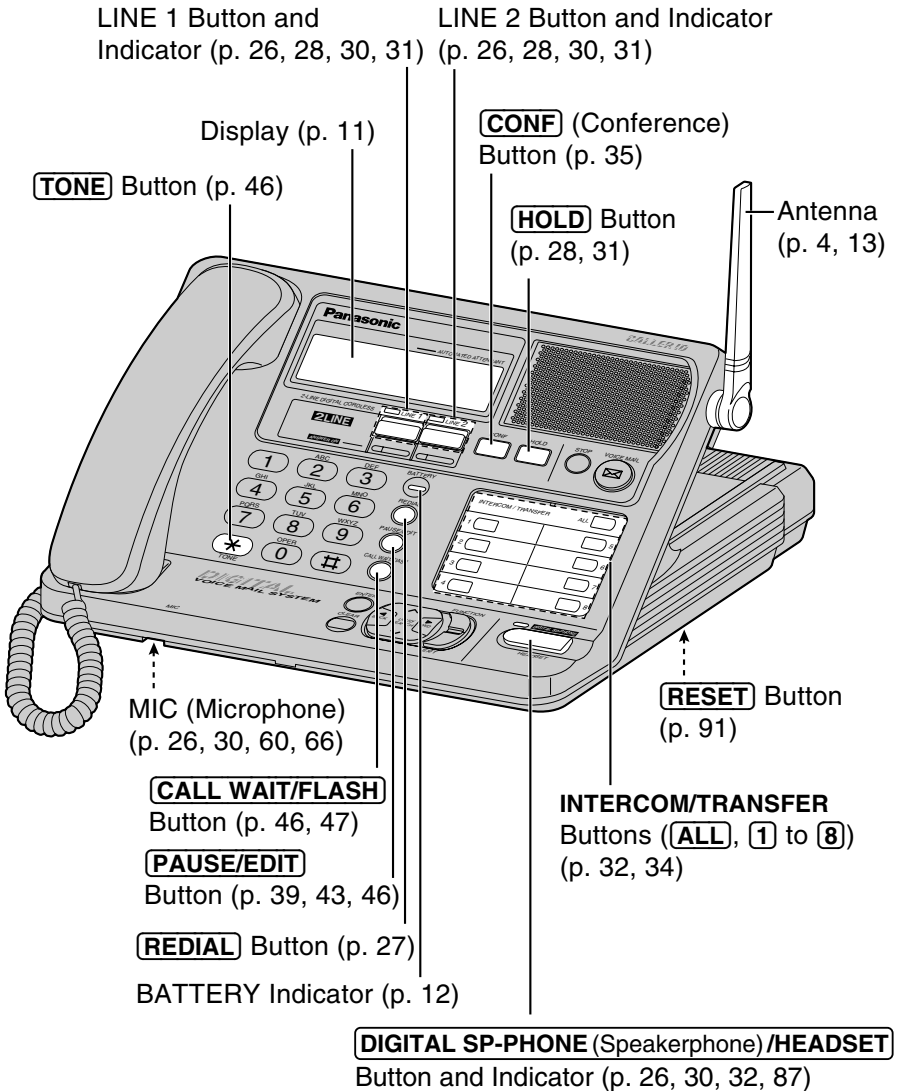



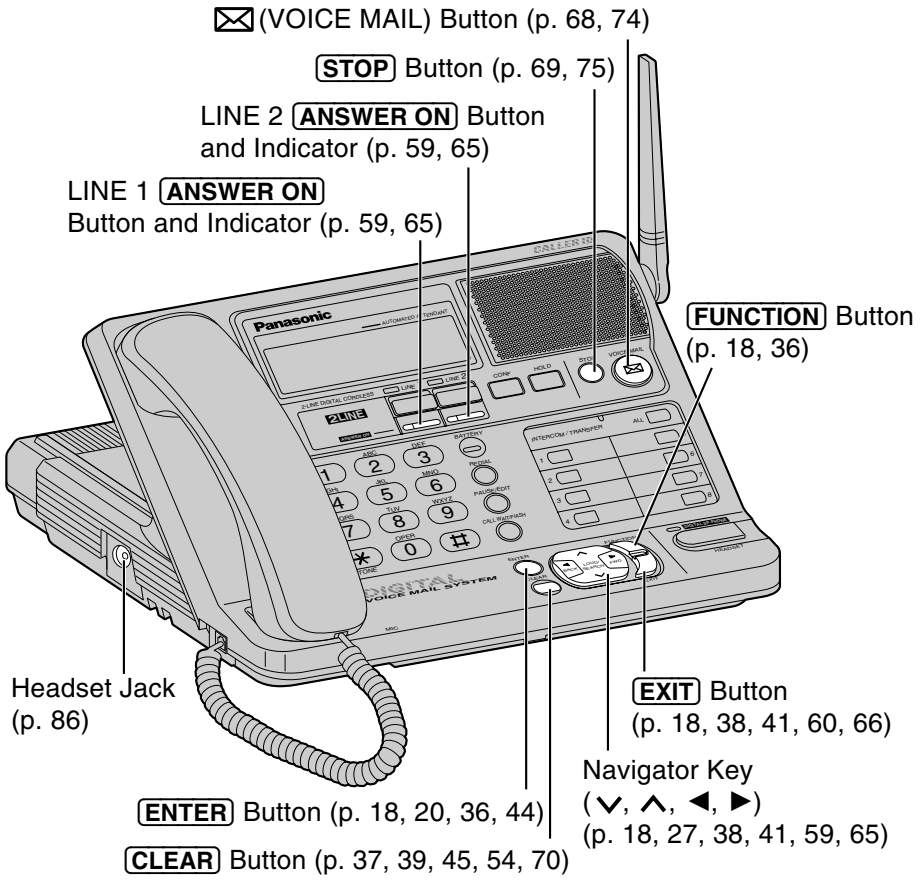

**Memory card:**

Remove the memory card and use it as a name index for the cordless handsets (p. 19, 53).

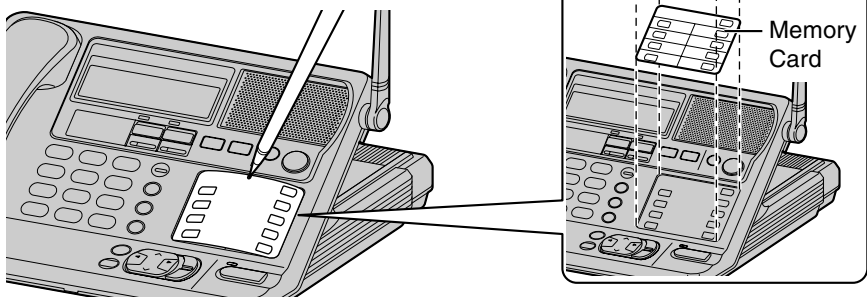

## ➔ Location of Controls

### Cordless handset

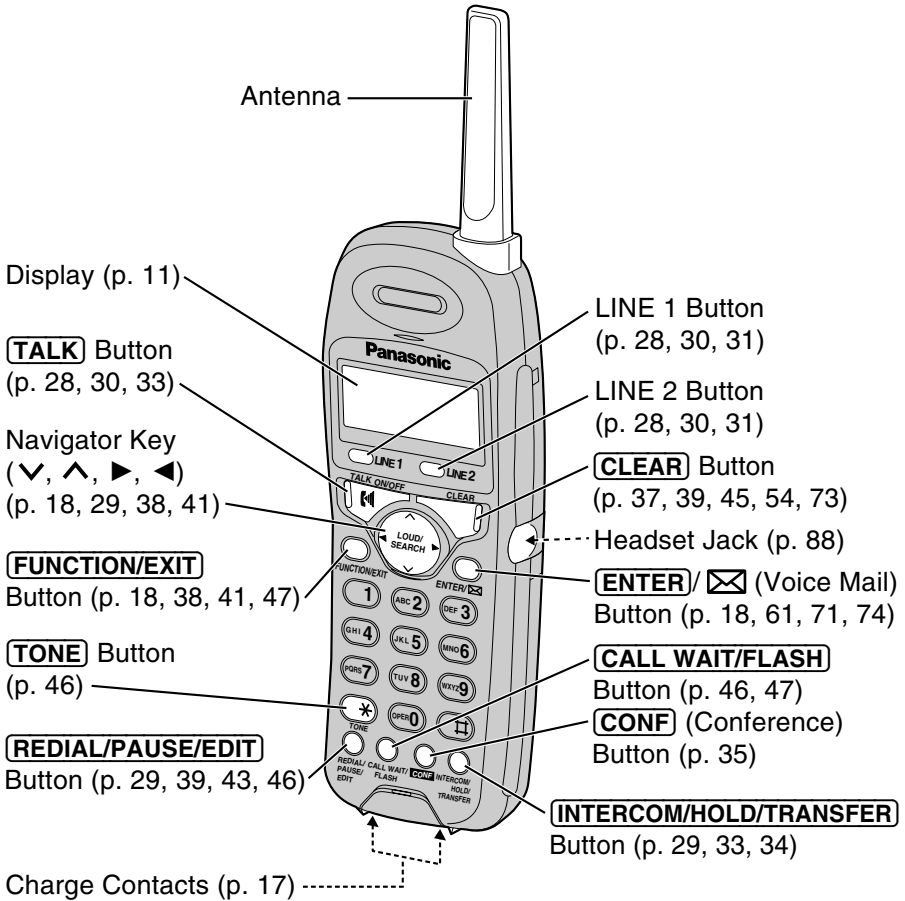

### Charger

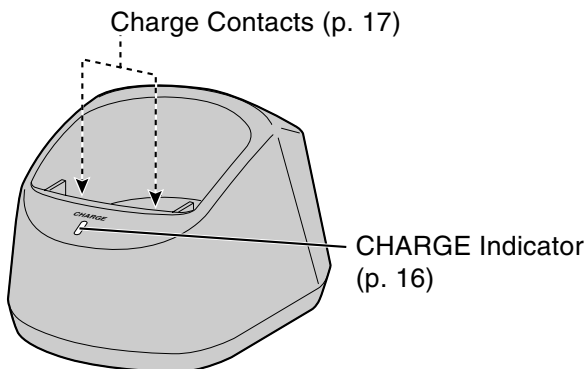

# Displays

## Base unit

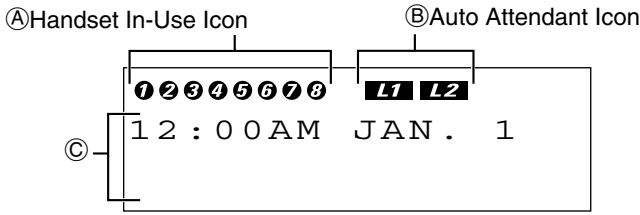

- A The handset in-use icon indicates the status of registered cordless handsets. If a cordless handset is in the talk or intercom mode, or listening to messages, the relevant number is displayed.
- B If you turn the Automated Attendant System on, the relevant line icon is displayed (p. 59).
- C The time and date are displayed on the first line in the standby mode. The display shows the dialed number, call status, programming options and directory items etc. If you subscribe to a Caller ID service, caller information will be displayed (p. 40).

## Cordless handset

- A The voice mail icon flashes if there is at least one new message in your mailbox (p. 71). During playback, it will be displayed.

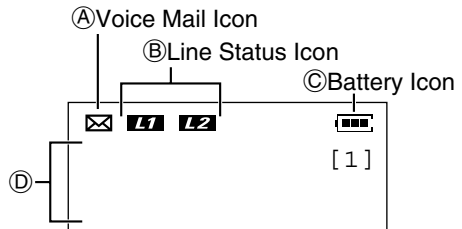

- B The line status icons function as follows.

<b>Off</b> (invisible)	The line is free.
<b>On</b>	The line is being used.
<b>Flashing</b>	A call is on hold. The Automated Attendant System or Answering System is responding to a call (p. 58, 65).
<b>Flashing quickly</b>	A call is being received.

- C The battery icon indicates the battery strength (p. 17).
- D The handset number ([1] to [8]) is displayed in the standby mode (p. 19, 53). The display shows the dialed number, call status, programming options and directory items etc. If you subscribe to a Caller ID service, caller information will be displayed (p. 40).

## Backlit LCD displays

Both the base unit and cordless handset have a backlit LCD display. The lighted cordless handset display will stay on for about 10 seconds after pressing a button or lifting the handset off the charger.

# Installation

## Installing the Backup Battery in the Base Unit

A rechargeable Ni-Cd battery works as emergency power during a power failure. The fully charged backup battery provides the base unit with a minimum of 20 minutes operation. The battery is charged in the base unit while the AC adaptor is connected (p. 13). It takes about 10 hours to charge fully.

- 1 Open the battery cover.

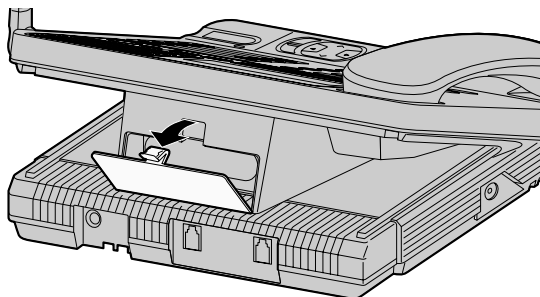

- 2 Install the backup battery in the battery compartment. Close the battery cover.

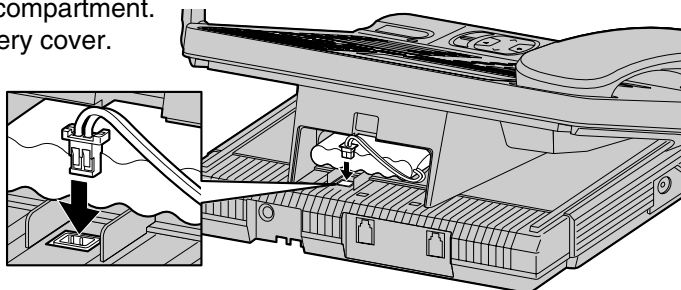

### **BATTERY Indicator:**

- The BATTERY indicator lights while the battery is being charged. (This is normal.)
- During a power failure (or if the AC adaptor is disconnected), the BATTERY indicator shows the battery strength:
  - Full to Medium:** The indicator lights.
  - Low:** The indicator flashes.
  - No power:** The indicator light is off.

### BATTERY Indicator

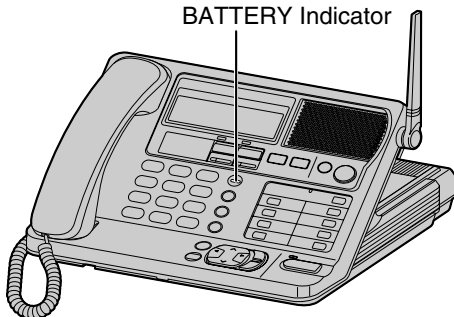

- The battery cannot be overcharged.
- If the backup battery has been discharged during a power failure, the unit will not work. If required, you can connect a standard telephone on the same line. See page 91.



## Connecting the Handset and AC Adaptor

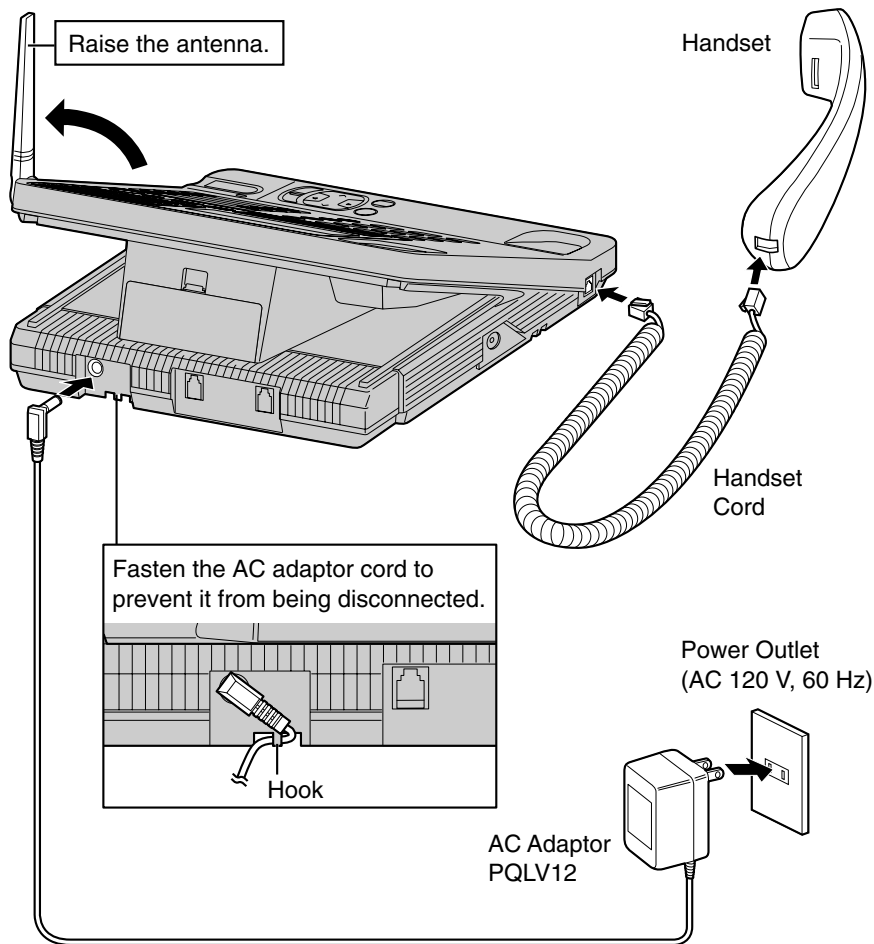

- Use only a Panasonic Handset for the KX-TG2000B.
- USE ONLY WITH Panasonic AC ADAPTOR PQLV12 (Order No. PQLV12Z).
- The AC adaptor must remain connected at all times. (It is normal for the adaptor to feel warm during use.)
- The BATTERY indicator lights while the AC adaptor is connected with the backup battery installed (p. 12). (This is normal.)

## ➔ Installation

### Connecting the Telephone Line Cord(s)

Connect the telephone line cord(s) to the base unit.

#### To connect a two-line telephone jack

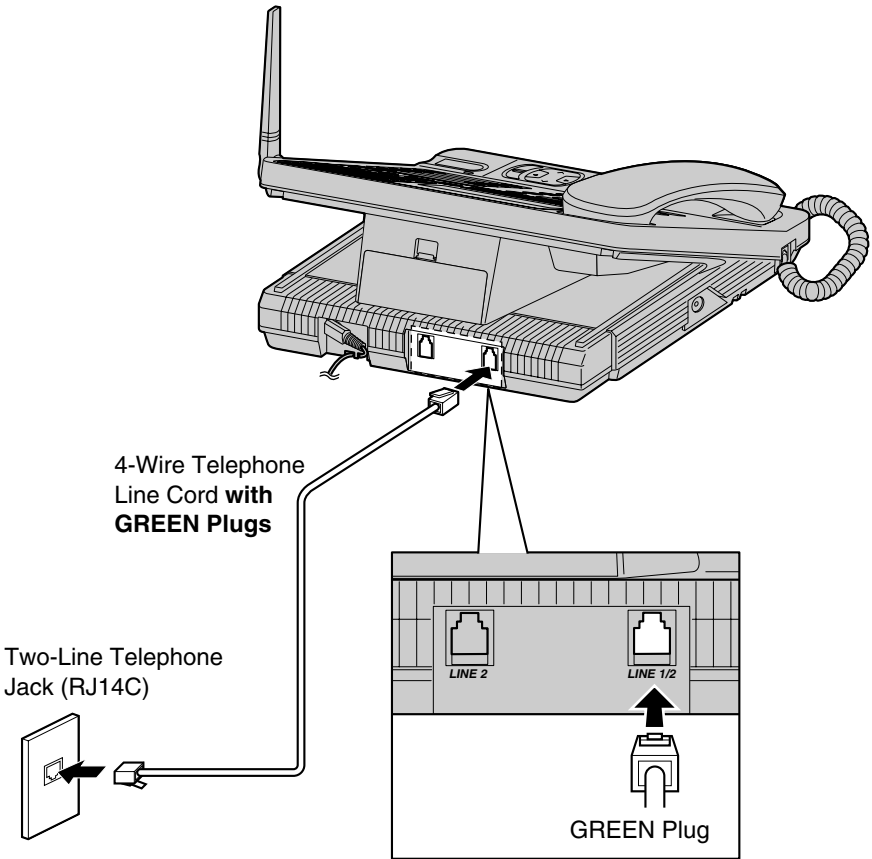



## To connect two single-line telephone jacks

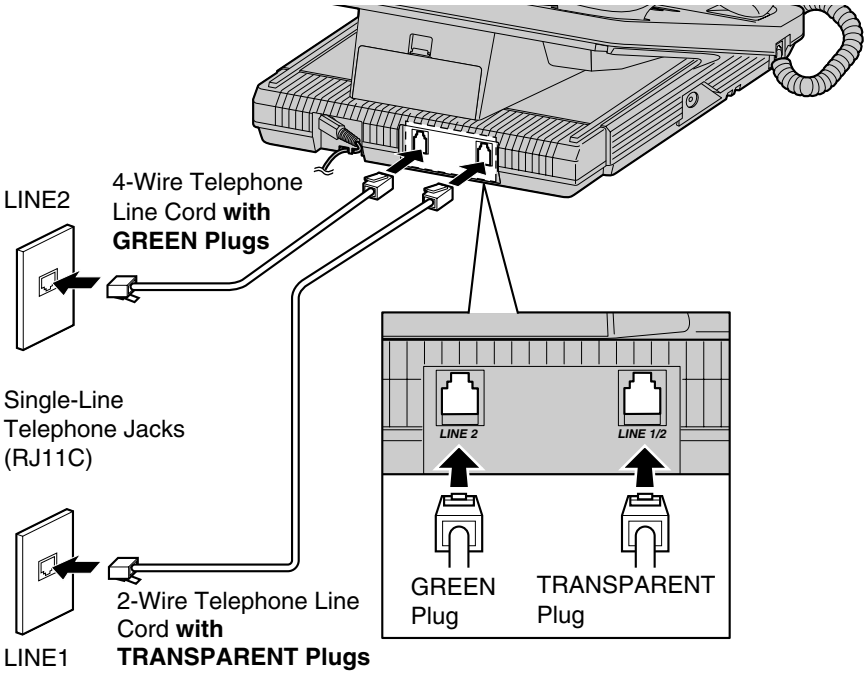

## If you use the unit as a single-line telephone only

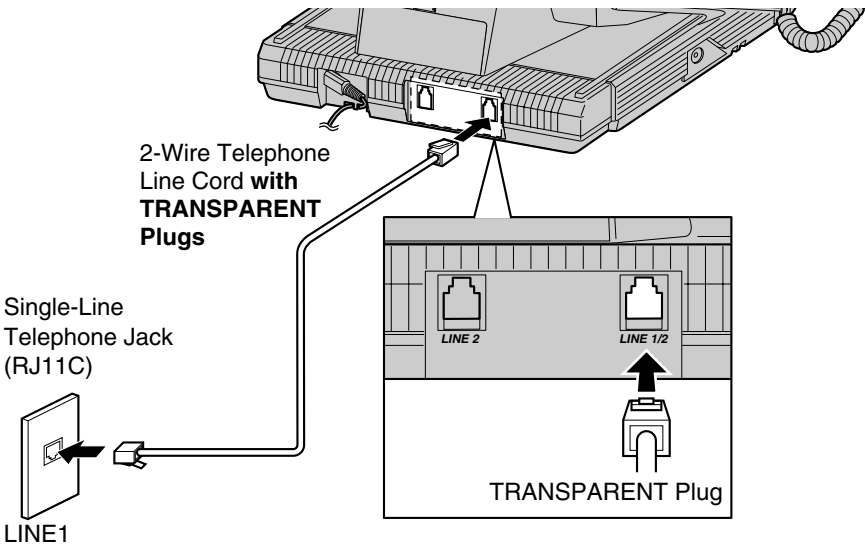

- With this connection, you can only use LINE 1.

## ➔ Installation

### Connecting the AC Adaptor to the Charger

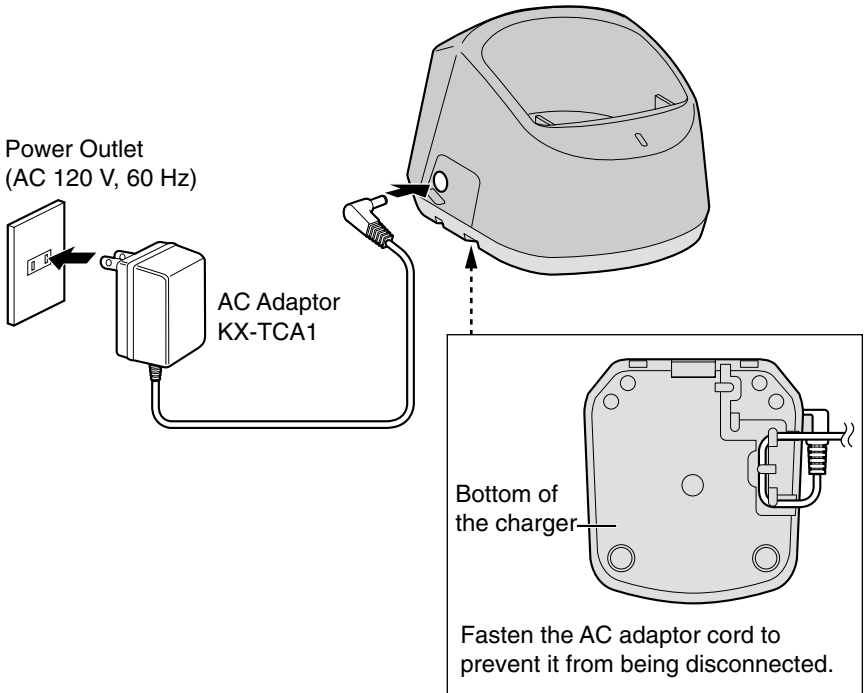

- USE ONLY WITH Panasonic AC ADAPTOR KX-TCA1 (Order No. KX-TCA1-G).
- The AC adaptor must remain connected at all times. (It is normal for the adaptor to feel warm during use.)

### Handset Battery Charge

Place the cordless handset on the charger and charge for about **8 hours** before initial use. Make sure the handset faces forward as shown.



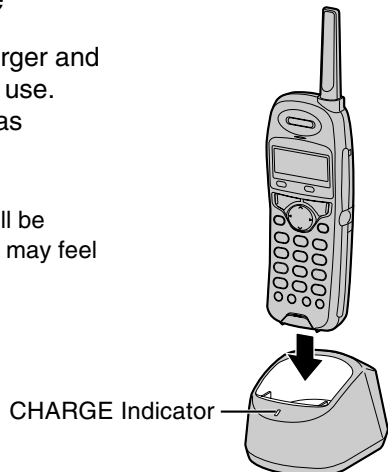

- The CHARGE indicator lights.
- If you charge the discharged battery, it will be charged quickly. In that case the handset may feel warm. This is normal.





## Handset battery strength

You can check the battery strength on the handset display. The battery strength is shown as in the chart below.

Display prompt	Battery strength
	Fully charged
	Medium
	Low
 (flashing)	Needs to be recharged.

## Recharge

Recharge the battery when:

- “Recharge” is displayed on the handset,
- “” flashes on the handset display, or
- the handset beeps intermittently while it is in use.

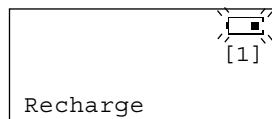

- If you DO NOT recharge the battery for more than 15 minutes, the display will keep indicating “Recharge” and/or “” will continue to flash.

## Handset battery information

After your Panasonic battery is fully charged (p. 16):

Operation	Approx. battery life
While in use (TALK)	Up to about 8 hours
While not in use (Standby)	Up to about 4 days

- Battery life may be shortened depending on usage conditions and ambient temperature.
- **Clean the charge contacts of the handset and the charger with a soft, dry cloth once a month. Clean more often if the unit is subject to grease, dust or high humidity.** Otherwise the battery may not charge properly.
- If the battery is fully charged, you do not have to place the handset on the charger until “Recharge” is displayed and/or “” flashes. This will maximize the battery life.
- The battery cannot be overcharged.

# Programmable Settings

## Programming Guidelines **Base Unit** **Handset**

This unit has various programmable functions. Most of them are selected from the function menu on the display (p. 24).

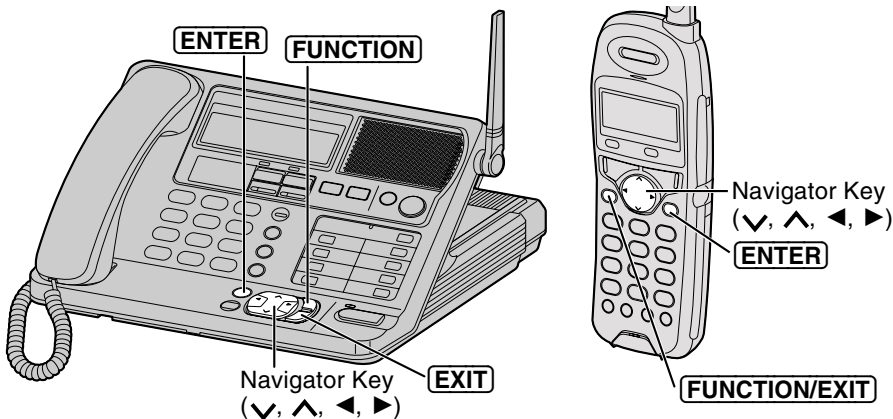

### How to select a function item from the menu

1. Press **FUNCTION** while in the standby mode. The main menu is displayed.
2. You can scroll through the menu by pressing **↓** or **↑**. Find the desired item and point the arrow to the item by pressing **↓** or **↑**.
3. Press **▶** to select the item.
4. If the selected item has a sub-menu, it will be displayed. Select the sub-menu item by pressing **↓** or **↑**, and press **▶**.
5. You can then select the desired setting.
  - **ENTER** is used to select or save a programming setting.
6. When programming is complete, a confirmation tone sounds. The display will return to the main menu or the sub-menu (if the function item is in the sub-menu). You can continue programming other items. To return to the standby mode, press **EXIT**.

Base Unit

Ex. "Ringer setting" is at the arrow.

```
Save directory
Date and time
▶Ringer setting
```

### Useful information:

- You can go back to the previous display by pressing **◀** except when entering characters or numbers. To return to the main menu from the sub-menu, press **◀**.
- You can exit the programming mode any time by pressing **EXIT**.
- If you do not press any buttons for 60 seconds, the unit will return to the standby mode.
- If the unit detects a problem, an error message will be displayed (p. 92).



## Registration for Additional Cordless Handsets **Base Unit & Handset**

The included cordless handset is pre-registered at the factory and assigned the handset number 1. **Do not try to register the handset number 1** which has “[1]” on the display. Optional handsets must be registered at the base unit. You can add up to 7 optional handsets to the handset number 1. Only one handset can be registered at a time. The handset number is used as the extension number (p. 32, 58).

The model number of the optional cordless handset is KX-TGA200B. To order, contact your dealer or call 1-800-211-PANA(7262) to locate a dealer.

**Make sure that the base unit and cordless handset are in the standby mode. Registration must be completed within 1 minute.**

### 1 Base unit:

Press **FUNCTION**.

2 Press  $\blacktriangledown$  or  $\blacktriangle$  until the arrow points to “Registration”, and press  $\blacktriangleright$ .

3 Press  $\blacktriangledown$  or  $\blacktriangle$  until the arrow points to “HS registration”, and press  $\blacktriangleright$ .

```
Handset
registering
```

### 4 Cordless handset:

Press **FUNCTION**.

5 Press  $\blacktriangledown$  or  $\blacktriangle$  until the arrow points to “Registration”, and press  $\blacktriangleright$ .

6 While “HS registration” is at the arrow, press  $\blacktriangleright$ .

```
Handset
registering
```

### 7 Base unit/cordless handset:

Wait until a beep sounds on the base unit and handset and until both of the displays show the assigned handset number. Ex. Handset number is 2.

Base Unit

```
Handset2
registered
```

Cordless Handset

```
Handset2
registered
```

- To return to the standby mode, press **EXIT**.
- The handset number ([1] to [8]) will be displayed on the handset.

You can store a PIN (Personal Identification Number) to prevent unauthorized persons from registering and using a cordless handset (p. 52). Once the PIN is set, you must enter the PIN at registration (p. 53). If you forget your PIN, please refer to “Clearing Settings” (p. 89).

## Date and Time Adjustment **Base Unit**

Make sure that the base unit is in the standby mode.

1 Press **[FUNCTION]**.

2 Press **▼** or **▲** until the arrow points to "Date and time", and press **▶**.

```
Date : 2000.01.01
Time : 12:00 AM
▼ = PM   ENTER = Save
```

3 ① Enter the year, and month and day using 4-digit numbers.  
Ex. To set Apr. 7, 2000, enter "2000" and "0407".

② Enter the time (hour and minute) using a 4-digit number.

Ex. To set 9:30, enter "0930".

```
Date : 2000.04.07
Time : 09:30 AM
▼ = PM   ENTER = Save
```

- If you enter a wrong number, press **◀** or **▶** to move the cursor to the incorrect number. Enter the correct number.

4 Select AM or PM by pressing **▼**.

```
Date : 2000.04.07
Time : 09:30 PM
▼ = AM   ENTER = Save
```

5 Press **[ENTER]**.

- A beep sounds. The clock starts working.
- To return to the standby mode, press **[EXIT]**.

```
9:30 PM APR. 7
```

- If 3 beeps sound, the setting is not correct. Start again from step 3.

- When entering the time in step 3, you cannot enter numbers greater than 12. **Do not use military time.** (To set 13:00 hours, enter "0100" and select "PM" by pressing **▼**.)

**Voice Date/Time Stamp:** After each message playback, a synthesized voice will announce the date and time that each message was recorded (p. 68, 71, 79).

If a power failure occurs, the adjusted date/time will be retained for at least 20 minutes with the backup battery fully charged (p. 12). Readjust if the date/time is flashing on the display.

### For Caller ID service users (p. 40)

- The Caller ID information will re-set the clock after the first ring if the adjusted time is incorrect. However, if the time has not previously been set, the Caller ID information will not adjust the clock.
- The Caller ID information will automatically adjust the clock for daylight saving time.



## Selecting the Dialing Mode **Base Unit**

If your lines have touch tone service, set to “Tone”. If rotary or pulse service is used, set to “Pulse”. Select the mode for each line. Your phone comes from the factory set to “Tone”.

**Make sure that the base unit is in the standby mode.**

- 1 Press **FUNCTION**.
- 2 Press  $\blacktriangledown$  or  $\blacktriangle$  until the arrow points to “Dial setting”, and press  $\blacktriangleright$ .
- 3 While “Set dial mode” is at the arrow, press  $\blacktriangleright$ .

- The current settings are displayed.

Dial mode	
Line1	Line2
Tone	Tone

- 4 Select “Puls” (Pulse) or “Tone” by pressing  $\blacktriangledown$  or  $\blacktriangle$  for each line. To move to the other line, press  $\blacktriangleright$  or  $\blacktriangleleft$ .

## ➔ Programmable Settings

### Selecting the Ringer Volume **Base Unit** **Handset**

You can set the base unit and cordless handset ringer volumes to HIGH, LOW or OFF. If set to OFF, the base unit/handset will not ring. Your phone comes from the factory set to HIGH.

**Programming must be carried out separately for the base unit and cordless handset(s).**

**Make sure that the base unit/cordless handset is in the standby mode.**

- 1 Press **FUNCTION**.
- 2 Press  $\nabla$  or  $\blacktriangle$  until the arrow points to "Ringer setting", and press  $\blacktriangleright$ .
- 3 While "Ringer volume" is at the arrow, press  $\blacktriangleright$ .
  - The current volume is displayed .
- 4 Press  $\blacktriangle$  to increase or press  $\nabla$  to decrease the volume.
  - Each time you press  $\nabla$  or  $\blacktriangle$ , the volume will change and ring.
  - **To turn the ringer OFF**, press and hold  $\nabla$  until a beep sounds.

**To turn the ringer ON**, press  $\blacktriangle$  in step 4.

- The ringer will sound at the LOW level.
- You can also select the ringer volume while a call is being received. Press  $\nabla$  or  $\blacktriangle$  while the unit is ringing.
- To turn the ringer off for each line, use the ring group feature (p. 23).

HIGH

```
Ringer volume
Low ■■■■■ High
v^
```

LOW

```
      ↑   ↓
Low ■■ High
```

OFF

```
      ↑   ↓
Ringer off
```

- To return to the standby mode, press **EXIT**.
- If set to OFF, "Ringer off" will be displayed in the standby mode.



## Ring Group Setting **Base Unit**

This feature allows you to specify which extensions (including the base unit) can answer calls for each line. To stop certain extensions ringing for incoming calls on the line, remove the extensions from the ring group of the line. The extensions can make a call using the line.

**Make sure that the base unit is in the standby mode.**

1 Press **[FUNCTION]**.

2 Press  $\nabla$  or  $\blacktriangle$  until the arrow points to “Ringer setting”, and press  $\blacktriangleright$ .

3 Press  $\nabla$  or  $\blacktriangle$  until the arrow points to “Ring group”, and press  $\blacktriangleright$ .

```

Ring group: L1
Ext. #: 123456780

```

4 Select the desired line (LINE 1 or 2) by pressing  $\blacktriangleright$  or  $\blacktriangleleft$ .

5 Press  $\nabla$  to select “Ext. #”.

```

Ring group: L2
Ext. #: 123456780
ENTER=Save

```

6 Erase the extension numbers which you do not want to ring by pressing the dialing buttons (1 to 8). Enter 0 for the base unit. (Display the extension numbers which can answer calls.)

- If you make a mistake, press the number again to display it.
- To erase all the numbers, press **[CLEAR]**.

```

Ring group: L2
Ext. #: -234-6-8-
ENTER=Save

```

7 Press **[ENTER]**.

- A beep sounds.
- The extensions removed from the ring group of the line will not ring and will not receive Caller ID information for incoming calls on the line.

Ex. Extension 1, 5, 7 and 0 (base unit) will not ring for incoming calls on LINE 2.

```

Ring group: L2
Ext. #: -234-6-8-

```

- To program for the other line, start again from step 3.
- To return to the standby mode, press **[EXIT]**.
- If the base unit is removed from the ring group of the line(s), the display will show, for example, the following in the standby mode.  
Ex. Base unit is removed from the LINE 2 ring group.

```

9:30PM APR. 7
BaseRcvOff L_2

```

In this case the base unit will not ring and will not receive Caller ID information for incoming calls on LINE 2. If the base unit ringer volume is OFF (p. 22), “Ringer off” will display instead. To receive Caller ID information, add Ext.# “0” into the ring group.

## Function Menu Table **Base Unit** **Handset**

You can use the following functions to customize your system according to your needs. After pressing **[FUNCTION]**, the main menu is displayed. Most items in the main menu have a sub-menu. The sub-menu is shown after selecting the item in the main menu.

See the corresponding pages for function details.

Main menu items are written in bold and sub-menu items are under each main menu item on this page.

### Base unit

- ➔ **Save directory** (p. 36)
- Date and time** (p. 20)
- Ringer setting**
  - ↓ Ringer volume (p. 22)
  - ↓ Ringer pattern (p. 48)
  - ↓ Ring group (p. 23)
  - ↓ Incoming call (p. 51)
- Dial setting**
  - ↓ Set dial mode (p. 21)
  - ↓ Set flash time (p. 47)
  - ↓ Call restrict. (p. 50)
- Line setting**
  - ↓ Line selection (p. 49)
  - ↓ Set line mode (p. 55)
- Voice mail**
  - ↓ Set password (p. 57)
  - ↓ Call monitoring (p. 75)
  - ↓ Message menu (p. 77)
  - ↓ Recording mode (p. 75)
  - ↓ Delete message (p. 78)
  - ↓ Remaining space (p. 76)
  - ↓ Auto msg delete (p. 77)
- Pager setting**
  - ↓ Pager number (p. 82)
  - ↓ Pager on/off (p. 84)
  - ↓ Pager display # (p. 83)
  - ↓ Calling pager (p. 83)
- Registration**
  - ↓ Set PIN (p. 52)
  - ↓ HS registration (p. 19, 53)
  - ↓ Deregistration (p. 54)
- Initialization**
  - ↓ Function (p. 89)
  - ↓ Dial data (p. 55)

### Cordless handset

- ➔ **Save directory** (p. 36)
- Ringer setting**
  - ↓ Ringer volume (p. 22)
  - ↓ Ringer pattern (p. 48)
  - ↓ Incoming call (p. 51)
- Talk selection**
  - ↓ Line selection (p. 49)
  - ↓ Auto talk (p. 48)
- Voice mail**
  - ↓ Set password (p. 57)
  - ↓ Message menu (p. 77)
- Pager setting**
  - ↓ Pager number (p. 82)
  - ↓ Pager on/off (p. 84)
  - ↓ Pager display # (p. 83)
  - ↓ Calling pager (p. 83)
- Registration**
  - ↓ HS registration (p. 19, 53)
  - ↓ Deregistration (p. 54)
- Initialization**
  - ↓ Function (p. 89)
  - ↓ Dial data (p. 55)



# The Unit Capabilities (Operating More than One Handset)

This unit can handle up to 2 external telephone lines which are provided by a telephone company, or up to 2 internal lines for intercom calls. You can expand the unit capabilities by registering up to 8 cordless handsets at the base unit (p. 19, 53).

## How many external calls and intercom calls can be conducted by how many users at one time?

Allows two intercom calls while simultaneously conducting one external call with the base unit and 4 handsets.\*

For example, 2 pairs of handsets are engaged in separate intercom calls while the base unit is engaged in an external call.

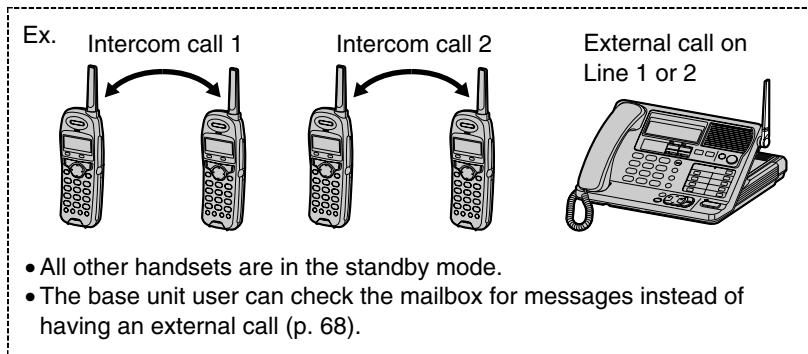

Allows two external calls while simultaneously conducting one intercom call.\*

For example, the base unit and a handset are engaged in separate external calls while another handset is engaged in an intercom call with another handset.

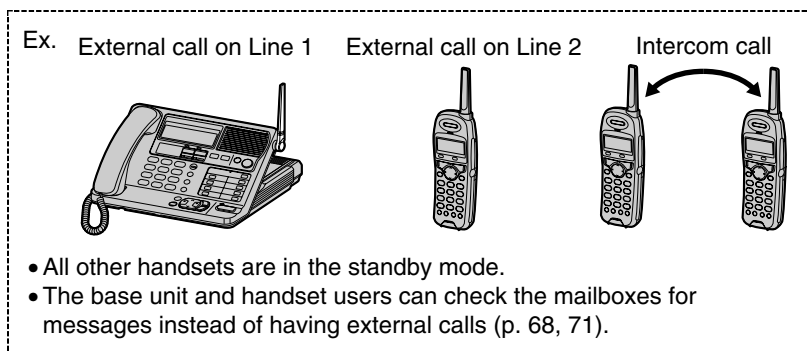

\*The number of cordless handsets that can be used simultaneously will vary depending on usage of external telephone lines and internal lines, and usage of mailboxes (p. 56).

# Making Calls **Base Unit** **Handset**

Two calls can be handled simultaneously on separate telephone lines by the base unit and a cordless handset (or by 2 cordless handsets).

## With the Base Unit

When you lift the handset to make a call, the unit will automatically select a free line. (To change the line selection, see page 49.) Dial a phone number. To hang up, replace the handset.

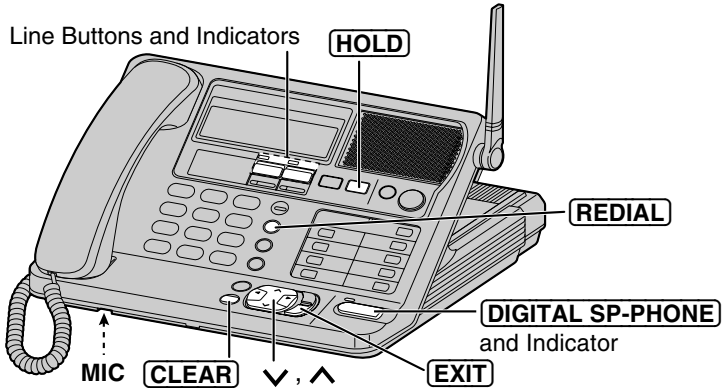

## Using the digital duplex speakerphone

**1** Press **DIGITAL SP-PHONE**.

- The indicator lights.
- A free line is automatically selected and the line indicator lights.

Ex. Line 1 is selected.

Talk	Line 1
------	--------

**2** Dial a phone number.

- The dialed number is displayed.
- If you misdial, press **DIGITAL SP-PHONE**, and start again from step 1.
- After a few seconds, the display will show the length of the call.

Talk	Line 1
1112222	

**3** When the other party answers, talk into the **MIC** (microphone).

**4** To hang up, press **DIGITAL SP-PHONE**.

- The indicator lights go out.

Off
00 - 02 - 50

- In step 1, you can select a line by pressing a line button whose indicator is not lit, instead of pressing **DIGITAL SP-PHONE**.
- If more than one handset is in use, you may not be able to make a call. In that case "System is busy. Please try again later." is displayed.
- If the unit detects a problem, an error message will be displayed (p. 92).



## To dial after confirming the entered number

- 1 Enter a phone number.



- If you misdial, press **CLEAR**. Digits are erased from the right.
- To cancel, press **EXIT**.

- 2 Lift the handset or press **DIGITAL SP-PHONE**.

- The line number is displayed.
- After a few seconds, the display will show the length of the call.
- You can press a line button instead of **DIGITAL SP-PHONE**.

- 3 When the other party answers, talk into the handset or **MIC**.

- 4 To hang up, replace the handset or press **DIGITAL SP-PHONE**.

## To redial the last number dialed

Lift the handset or press **DIGITAL SP-PHONE**, and press **REDIAL**.

## To adjust the handset volume (High, Medium or Low) or the speaker volume (8 levels)

Press **▲** or **▼** while talking.

- Each time you press **▲** or **▼**, the volume level will change.

Ex. Handset volume: High



Ex. Speakerphone volume: 8



## To redial using the redial list

The last 10 phone numbers dialed with the base unit are stored in the redial list.

1. Press **REDIAL**.
  - The last number dialed is displayed.
2. Press **REDIAL** until the desired number is displayed.
  - You can scroll between numbers by pressing **▼** or **▲**.
  - To exit the list, press **EXIT**.
3. Lift the handset or press **DIGITAL SP-PHONE**.

- **To erase an item**, repeat steps 1 and 2, and press **CLEAR**.
- If “No items stored” is displayed, the list is empty.

### Hands-free Digital Duplex Speakerphone

For best performance, please note the following:

- Talk alternately with the caller in a quiet room.
- If the other party has difficulty hearing you, press **▼** to decrease the speaker volume.
- If the other party's voice from the speaker cuts in/out during a conversation, press **▼** to decrease the speaker volume.
- You can switch to the handset by lifting it up. To switch back to the speakerphone, press **DIGITAL SP-PHONE**.

## ➔ Making Calls

### To put a call on hold

Press **HOLD**.

- “Hold” and the line number are displayed.
- If using the handset, you can replace it on the cradle.
- If a call is kept holding for 3 minutes, a warning tone will sound. After 2 additional minutes on hold the automated attendant will respond to the caller and he/she can call a handset or leave a message following the Incomplete Call Handling Menu (p. 64).

### To release the hold

Press the line button whose indicator is flashing.

- Cordless handset users can release the hold by pressing the line button. If another phone is connected on the same line, the hold will also be released by lifting its handset.

### What line indicators mean

<b>Off</b>	The line is free.
<b>On</b>	The line is being used.
<b>Flashing</b>	A call is on hold. The Automated Attendant System or Answering System is responding to a call (p. 58, 65).
<b>Flashing quickly</b>	A call is being received.

### With the Cordless Handset

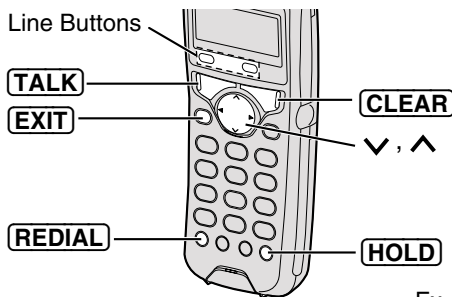

#### 1 Press **TALK**.

- A free line is automatically selected and the line status icon (p. 11) is displayed. (To change the line selection, see page 49.)

Ex. Line 1 is selected.

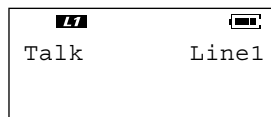

#### 2 Dial a phone number.

- The dialed number is displayed.
- After a few seconds, the display will show the length of the call.



#### 3 To hang up, press **TALK** or place the handset on the charger.

- In step 1, you can select a line by pressing the line button whose line status icon is not displayed, instead of pressing **TALK**.
- If the base unit and another handset or 2 other handsets are in use, you may not be able to make a call. In that case “System is busy. Please try again later.” is displayed.
- If the unit detects a problem, an error message will be displayed (p. 92).

## To dial after confirming the entered number

- 1 Enter a phone number.



- If you misdial, press **CLEAR**.  
Digits are erased from the right.
- To cancel, press **EXIT**.

- 2 Press **TALK**.

- You can press a line button instead of pressing **TALK**.
- The line number is displayed.
- After a few seconds, the display will show the length of the call.

- 3 To hang up, press **TALK** or place the handset on the charger.

## To adjust the receiver volume (High, Medium or Low)

Press **^** or **v** while talking.

- Each time you press **^** or **v**, the volume level will change.

Ex. High



## Lighted handset keypad

The handset dialing buttons will light when you press a button, and flash when a call is received. The lights will go out about 10 seconds after pressing a button, lifting the handset off the charger or answering a call.

## To redial the last number dialed

Press **TALK** and press **REDIAL**.

## To redial using the redial list

The last 10 phone numbers dialed with the handset are stored in the redial list.

1. Press **REDIAL**.
  - The last number dialed is displayed.
2. Press **REDIAL** until the desired number is displayed.
  - You can scroll between numbers by pressing **v** or **^**.
  - To exit the list, press **EXIT**.
3. Press **TALK**.

- **To erase an item**, repeat steps 1 and 2, and press **CLEAR**.
- If "No items stored" is displayed, the list is empty.

## To put a call on hold

Press **HOLD**.

- "Hold" and the line number are displayed.
- The line status icon flashes on the display.
- If a call is kept holding for 3 minutes, a warning tone will sound. After 2 additional minutes on hold the automated attendant will respond to the caller and he/she can call the base unit or another handset or leave a message following the Incomplete Call Handling Menu (p. 63).

## To release the hold

Press the line button.

- The base unit and other handset users can release the hold by pressing the line button. If another phone is connected on the same line, the hold will also be released by lifting its handset.

# Answering Calls **Base Unit** **Handset**

Two calls can be handled simultaneously by the base unit and a cordless handset (or by 2 cordless handsets). When a call is being received, the unit rings and “Incoming call” is displayed. The called line indicator flashes quickly on the base unit and the line status icon flashes quickly on the handset display. The line is automatically selected when you answer the call. If you subscribe to a Caller ID service, the calling party information will be displayed after the first ring (p. 40). In order to view the Caller ID information, please wait until the second ring to answer a call.

## With the Base Unit

You can answer a call by simply lifting the handset. To hang up, replace the handset.

### Using the digital duplex speakerphone

**1** Press **DIGITAL SP-PHONE**.

- The indicator lights.
- The called line indicator light stops flashing.

**2** Talk into the **MIC** (microphone).

**3** To hang up, press **DIGITAL SP-PHONE**.

- The indicator lights go out.

- To transfer the call that you took, to another person, see page 34. To transfer the call to another person’s mailbox to allow the caller to leave a message there, see page 76.

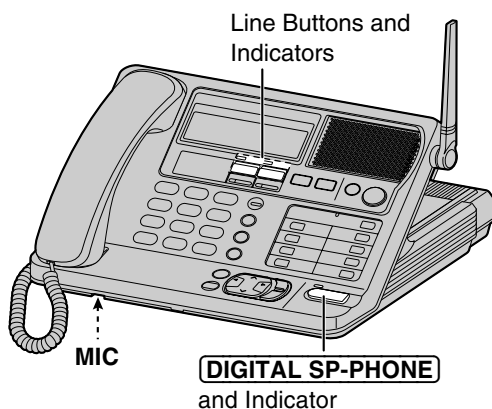

## With the Cordless Handset

Press **TALK**.

- The called line status icon stops flashing.
- You can also answer a call by pressing any dialing button **0** to **9**, **\*** or **#** (— Any Key Talk).

### OR

If the handset is on the charger, just lift up. (This is not possible when the Auto Talk feature is set to OFF. See page 48.)

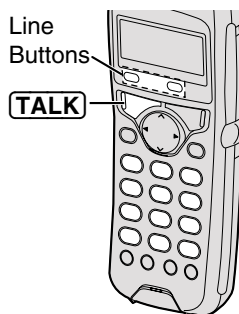

- You can answer a call by pressing the called line button instead of pressing **DIGITAL SP-PHONE** or **TALK**.
- When the base unit and handset ringer volumes are set to OFF, they will not ring (p. 22, 23).

# Using the Other Line During a Conversation

## Base Unit Handset

During a conversation, if an incoming call is being received on the other line, the line indicator on the base unit and the line status icon on the handset display will flash quickly. If you are using the cordless handset, you will hear **two tones**. You can answer the second call while holding the first call. You can also make a call without terminating the first call. If you subscribe to a Caller ID service, the second caller's information will be displayed when a call is being received on the other line (p. 40).

You can delete the **two tones** (incoming call tone) for the cordless handset. You can set the **two tones** for the base unit. See page 51.

### With the base unit

#### 1 Ex. If you are using LINE 1

Press **(HOLD)** to put the first call (LINE 1) on hold.

- The LINE 1 indicator flashes.



#### 2 Press the other line button (LINE 2) to make or answer a second call.

- The LINE 2 indicator lights.



#### 3 To return to the first call (LINE 1), press the line button for the first call (LINE 1).

- The second call is terminated.

### With the cordless handset

#### 1 Ex. If you are using LINE 1

Press **(HOLD)** to put the first call (LINE 1) on hold.

- The line status icon flashes on the display.

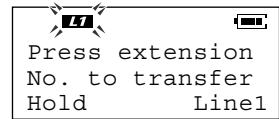

#### 2 Press the other line button (LINE 2) to make or answer a second call.

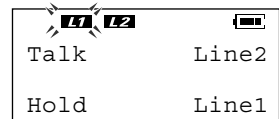

#### 3 To return to the first call (LINE 1), press the line button for the first call (LINE 1).

- The second call is terminated.

- To hold the second call in step 3, press **(HOLD)** before pressing the line button for the first call.

# Intercom **Base Unit** **Handset**

A 2-way intercom is possible between the base unit and a cordless handset or between two cordless handsets. Each number assigned to a handset at registration is the extension number (p. 19, 53). The base unit extension number is 0.

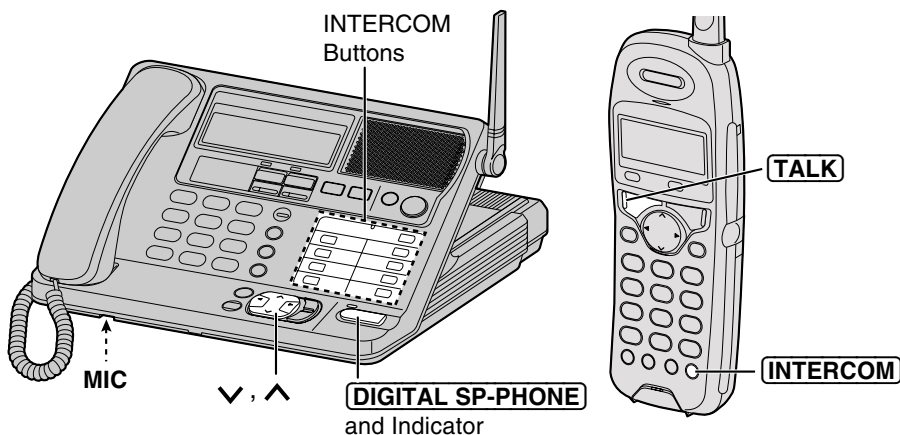

## Making Intercom Calls

### With the base unit

- 1 To page all handsets, press **INTERCOM [ALL]**.  
To page one handset, press the corresponding INTERCOM button (**1** to **8**).

- The paged handsets ring for 1 minute.
- To stop paging, press **[DIGITAL SP-PHONE]**.

- 2 When the other party's voice is heard, lift the handset or talk into the **MIC** (microphone).

- The display will show the length of the call and the handset in-use icon.

- 3 To end the intercom, replace the handset or press **[DIGITAL SP-PHONE]**.

Ex. Paging all Handsets

```
Paging [ALL]
```

Ex. Paging Handset 1

```
Calling [0] → [1]
```

Ex. Handset 1 answered.

```
📞  
Intercom  
00-00-00
```

```
Off  
00-10-08
```

- If you page all handsets, you can only talk with the handset user who answers first.
- Using this feature, you can locate a misplaced cordless handset.



## With the cordless handset

1 Press **INTERCOM**.



Press extension  
No. to call

2 To page the base unit, enter **0**.  
To page another handset, enter the  
extension number (**1** to **8**).

Ex. Handset 1 paging Base Unit

Calling [1] → [0]

- The base unit or the paged handset rings.
- To stop paging, press **INTERCOM**.
- After the paged party answers, the display will show the length of the call.

Intercom  
00-00-00

3 To end the intercom, press **TALK** or place  
the handset on the charger.

Off  
00-07-15

## Answering Intercom Calls

### With the base unit:

After the rings, lift the handset or  
press **DIGITAL SP-PHONE**.

To end the intercom, replace the  
handset or press **DIGITAL SP-PHONE**.

Ex. Handset 2 paging

Call [0] ← [2]

### With the cordless handset:

After the rings, press **TALK** or lift the  
handset off the charger.

To end the intercom, press **TALK** or  
place the handset on the charger.

Ex. Base Unit paging Handset 1



Call [1] ← [0]

### During an intercom call:

- If an incoming call is being received, the line indicator on the base unit will flash quickly or the handset user will hear two tones (incoming call tone p. 51). To answer, press the relevant line button.
- If the unit detects a problem, an error message will be displayed (p. 92).

- When the base unit and handset ringer volumes are set to OFF, they will not ring (p. 22).

# Transferring a Call **Base Unit** **Handset**

You can transfer an external call between the base unit and a cordless handset, or between two cordless handsets.

## With the base unit

- 1 During a call, press the corresponding TRANSFER button (1 to 8) to page the handset. To page all handsets, press TRANSFER **ALL**.
  - The call is put on hold and the line indicator flashes.
  - Even if you press TRANSFER **ALL**, only the handset user who answers first can take the transferred call.
- 2 If required, wait for the handset user to answer, and you can announce the transfer. If not required, go to step 3.
  - If the paged party does not answer, press the relevant line button.
- 3 To complete the transfer, replace the handset on the base unit or press **DIGITAL SP-PHONE**.

## To answer a transferred call with the base unit:

Lift the handset or press

**DIGITAL SP-PHONE** after the rings.

- After the paging party hangs up, you can talk to the outside caller.
- You can press the relevant line button instead of pressing **DIGITAL SP-PHONE** to talk to the outside caller.
- If the paged party does not answer within about 30 seconds after you hang up, the transferred call will be returned to you with a sounding tone from the base. If you still do not answer the caller's call within 2 minutes, the automated attendant will respond to the caller (p. 58). You may answer the caller by pressing the relevant line button before the sounding tone or before the start of the automated attendant. You may also transfer the caller into the caller's intended extension mailbox by performing the three procedures: 1) telling the caller the intended extension number with the # sign, 2) your pressing the VOICE MAIL () button on the base unit, and 3) your hanging up the line, so the intended extension mailbox will be presented to the caller (p. 76). If the incoming call is answered by a cordless handset, the call can also be transferred to other mailbox by the above procedures 1), 2) (VOICE MAIL button on the handset) and 3).
- Any users can take a transferred call by pressing the relevant line button.

## With the cordless handset

- 1 During a call, press **TRANSFER**.
  - The call is put on hold and "Press extension No. to transfer" is displayed.
- 2 To page the base unit, enter 0. To page another handset, enter the extension number (1 to 8).
- 3 If required, wait for the paged party to answer, and you can announce the transfer. If not required, go to step 4.
  - If the paged party does not answer, press the relevant line button.
- 4 To complete the transfer, press **TALK** or place the handset on the charger.

## To answer a transferred call with the cordless handset:

Press **TALK** or lift the handset off the charger after the rings.

- After the paging party hangs up, you can talk to the outside caller.
- You can press the relevant line button instead of pressing **TALK** to talk to the outside caller.

# Conference **Base Unit** **Handset**

This feature allows you to join two other calls to make a conference call. At least one of the other two parties should be on an external line.

## Conference with two external calls

- 1 Press **(HOLD)** to put the first call on hold.
- 2 Press the other line button to make or answer a second call.
- 3 When the second call is connected, press **(CONF)** to make a conference call.

Base unit

```
Conference
00-00-50
```

Handset

```
1 2
Conference
00-00-50
```

(Ex. Conference with LINE1 & 2)

## Conference with an external call and intercom call

- 1 Press **(HOLD)** to put the first call on hold.
- 2 If using the base unit:  
Press the corresponding INTERCOM button (**(1)** to **(8)**) to page the handset.  
OR  
If using the cordless handset:  
To page the base unit, enter **(0)**.  
To page another handset, enter the extension number (**(1)** to **(8)**).
- 3 When the paged party answers, press **(CONF)** to make a conference call.

### • To hang up both lines:

For the base unit: replace the handset or press **(DIGITAL SP-PHONE)**.

For the cordless handset: press **(TALK)** or place the handset on the charger.

### • To hang up only one line, press the line button for the party with which you want to continue talking.

### • To put both lines on hold, press **(HOLD)**.

To talk with only one caller, press the corresponding line button.

To resume both lines, press **(CONF)**.

### • To hang up only the intercom call, press the line button.

### • To leave the conference:

For the base unit: replace the handset or press **(DIGITAL SP-PHONE)**.

For the cordless handset: press **(TALK)** or place the handset on the charger.

The two other parties can continue the conversation.

# Using the Directory **Base Unit** **Handset**

You can store names and phone numbers in both the base unit and cordless handset directories. The base unit can store up to 100 items. Each cordless handset can store up to 50 items. All directory items are sorted by the first word in alphabetical order. Using the directories, you can make a call by selecting a name on the display.

## Storing Names and Numbers in the Directory

**Make sure that the base unit/cordless handset is in the standby mode.**

**1** Press **FUNCTION**.

Base Unit

```
► Save directory
   Date and time
   Ringer setting
```

**2** While “Save directory” is at the arrow, press ►.

- The display shows the number of items, and “Enter name”.

```
Directory=
   0 item
```

```
Enter name :
█
◄► ENTER=Next
```

**3** Enter a name, up to 16 characters, using the dialing buttons (p. 37).

- To move the cursor, press ◀ or ▶.
- If a name is not required, go to step 4.

```
Enter name :
Tom Jones█
◄► ENTER=Next
```

**4** Press **ENTER**.

```
Enter phone No. :
```

**5** Enter a phone number, up to 22 digits.

- If you misdial, press **CLEAR**. Digits are erased from the right. To erase all digits, press and hold **CLEAR**.

```
0 9 8 7 6 5 4 3 2 1 █
ENTER=Save
```

**6** Press **ENTER**.

- A beep sounds.
- To store other items, repeat from step 2.
- To return to the standby mode, press **EXIT**.

```
Tom Jones
0 9 8 7 6 5 4 3 2 1
```

- If a pause is required for dialing, **PAUSE** can be stored in a phone number in step 5. This counts as one digit (p. 46).
- If the display shows “Memory is full” in step 2, press **EXIT** and erase other stored items from the directory (p. 39).



## Selecting characters to enter names

The base unit and cordless handset dialing buttons (0 to 9) can be used to enter letters and symbols. The letters are printed on the dialing buttons. Pressing each button selects a character as shown below.

Keys	Number of times key is pressed										
	1	2	3	4	5	6	7	8	9	10	11
1	#	&	'	( )	*	,	-	.	/	1	
2	A	B	C	a	b	c	2				
3	D	E	F	d	e	f	3				
4	G	H	I	g	h	i	4				
5	J	K	L	j	k	l	5				
6	M	N	O	m	n	o	6				
7	P	Q	R	S	p	q	r	s	7		
8	T	U	V	t	u	v	8				
9	W	X	Y	Z	w	x	y	z	9		
0	0	Blank									
◀	Moves the cursor to the left.										
▶	Moves the cursor to the right. (To enter another character using the same number key, move the cursor to the next space.)										
CLEAR	Erases characters.										

### If you make a mistake while entering a name:

Press ◀ or ▶ to move the cursor to the incorrect character, press CLEAR to delete, and enter the correct character. Each time you press CLEAR a character is erased from the right. To erase all characters, press and hold CLEAR.

### For example, to enter "Tom Jones":

1. Press 8.

2. Press 6 six times, then press ▶.

3. Press 6 four times, then press ▶ twice.

4. Press 5, press 6 six times, then press ▶.

5. Press 6 five times, press 3 five times, then press 7 eight times.

## ➔ Using the Directory

### Dialing from the Directory

1 Press ◀ or ▶ to enter the directory.

2 Press √ or ^ to find the desired item.

- All directory items are sorted in the order shown on the right.

3 If using the base unit:  
Lift the handset or press **DIGITAL SP-PHONE**.

OR

If using the cordless handset:  
Press **TALK**.

- The number is dialed automatically.
- You can press a line button instead of pressing **DIGITAL SP-PHONE** or **TALK**.

Directory list  
√ ^  
▶ = Caller's list

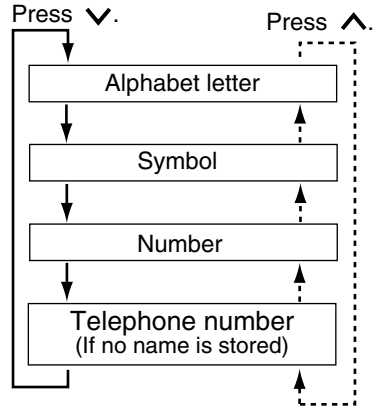

### To search for a name by initial

1 Press ◀ or ▶ to enter the directory.

2 Press the dialing button for the first letter of the desired name until any name with the same initial is displayed (see table on page 37).

Ex. To find "Frank", press **3** until the first item under "F" is displayed.

3 Press √ until the name is displayed.

4 If using the base unit:  
Lift the handset or press **DIGITAL SP-PHONE**.

OR

If using the cordless handset:  
Press **TALK**.

- The number is dialed automatically.
- You can press a line button instead of pressing **DIGITAL SP-PHONE** or **TALK**.

Base Unit

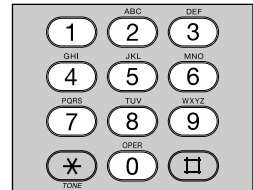

Cordless Handset



- You can leave the directory any time by pressing **EXIT**.
- If "No items stored" is displayed in step 1, the directory is empty.
- In step 1, you can go to the Caller List by pressing ▶ (p. 41).

## Editing an Item in the Directory

Make sure that the base unit/cordless handset is in the standby mode.

1 Press ◀ or ▶ to enter the directory.

2 Press ▼ or ▲ to find the directory item you want to edit.

- To search for the item by initial, see page 38.

3 Press **[EDIT]**.

- If you do not need to change the name, go to step 5.

```
Enter name :
Jane
◀▶          ENTER=Next
```

4 Edit the name using the dialing buttons, up to 16 characters (p. 37).

- To move the cursor, press ◀ or ▶.

```
Enter name :
Jane Walker
◀▶          ENTER=Next
```

5 Press **[ENTER]**.

- If you do not need to change the number, go to step 7.

```
1 2 3 4 5 6 7
          ENTER=Save
```

6 Add a number to the current number.

- Pressing **[CLEAR]** erases the digit to the left of the cursor. To erase all digits, press and hold **[CLEAR]**.

```
0 9 8 1 2 3 4 5 6 7
          ENTER=Save
```

7 Press **[ENTER]**.

- A beep sounds.
- To edit other items, start again from step 2.
- To return to the standby mode, press **[EXIT]**.

## Erasing an Item in the Directory

Make sure that the base unit/cordless handset is in the standby mode.

1 Press ◀ or ▶ to enter the directory.

2 Press ▼ or ▲ to find the directory item you want to erase.

- To search for the item by initial, see page 38.

3 Press **[CLEAR]**.

- To stop erasing, press ◀.

```
Clear?
◀=No      ENTER=Yes
```

4 Press **[ENTER]**.

- A beep sounds and "Clear" is displayed.
- To erase other items, start again from step 2.
- To return to the standby mode, press **[EXIT]**.

- To erase all items in the directory, see page 55.

# Caller ID Service

---

This unit is compatible with a Caller ID service offered by your telephone company. After subscribing to a Caller ID service, the calling party's information will be shown on the base unit and cordless handset displays after the first ring.

The base unit can record information of up to 50 different callers in the caller list. Each cordless handset can record information of up to 30 different callers in the Caller List.

The Caller List information is sorted from the most recent to the oldest call. When the base unit receives the 51st call or the handset receives the 31st call, the oldest call is deleted.

Using this list, you can automatically call back a caller. You can store the callers' names and numbers from the Caller List in the directory.

If you subscribe to both Caller ID and Call Waiting services, when a second call is received on the same line, the new caller's name and phone number will be displayed (p. 46).

## How caller information is displayed when a call is received

The display shows the caller's name, number and the called line after the first ring.

Base Unit

```
TINA ROBINSON
1-000-222-3333
-----Line1-----
```

Cordless Handset

```
📞 🔋
TINA ROBINSON
1-000-222-3333
-----Line1-----
```

- After you answer the call, the display will show the length of the call.
- If both lines receive calls at the same time, each caller's information will be displayed alternately.
- Caller information cannot be displayed in the following cases:
  - If the caller dialed from an area which does not provide a Caller ID service, the display will show "Out of area".
  - If the caller has requested not to display his/her information, the display will show "Private caller".
- If your unit is connected to a PBX which does not support Caller ID services, you cannot access those services.
- The name display service may not be available in some areas. For more information, please contact your telephone company.
- If the cordless handset has lost communication with the base unit when a call is received, the caller information will not be recorded in the handset Caller List.
- Caller ID information will not be displayed on the base unit when the Automated Attendant System is responding to a call (p. 58). Caller ID information will be displayed on the called handset or the base unit after the caller enters the extension number.



# Using the Caller List **Base Unit** **Handset**



If you have received new calls, “Received calls” will be displayed in the standby mode.

## Base Unit

```
12:00AM JAN. 1
Received calls
```

## Cordless Handset

```
Received calls [1]
```

## Viewing the Caller List

Caller List information includes the caller’s name and phone number, the time and date the call was received, and the number of times that caller called.

### With the base unit

Make sure that the base unit is in the standby mode.

- 1 Press  $\nabla$  or  $\blacktriangle$  to enter the list.
  - The number of new calls is displayed.

```
10 new calls
v^      ▶=Directory
```

- 2 To search from the most recent call, press  $\nabla$ .  
To search from the oldest call, press  $\blacktriangle$ .
  - To scroll between callers, press  $\nabla$  or  $\blacktriangle$ .

```
JACK SMITH
1-234-567-8901
3:10P JUN. 9
```

### With the cordless handset

Make sure that the cordless handset is in the standby mode.

- 1 Press  $\nabla$  or  $\blacktriangle$  to enter the list.
  - The number of new calls is displayed.

```
10 new calls
v^      ▶=Directory
```

- 2 To search from the most recent call, press  $\nabla$ .  
To search from the oldest call, press  $\blacktriangle$ .
  - To scroll between callers, press  $\nabla$  or  $\blacktriangle$ .

```
CINDY TURNER
1-234-456-7890
10:38A JUN. 9
```

- 3 To exit the list, press **EXIT**.

- 3 To exit the list, press **EXIT**.

- If “No items stored” is displayed in step 1, the Caller List is empty.
- If there is no name information for a caller, the display will only show the phone number.
- After viewing all of the new call entries, “Received calls” will disappear.
- In step 1, you can go to the directory by pressing  $\blacktriangleright$  (p. 38).

## ➔ Using the Caller List

### What “√” means

When you have viewed a new call, answered the call or called back the caller, “√” will be added to the caller information.

```
NANCY BROWN
1 - 000 - 222 - 3333
3 : 10P JUN . 10 √
```

### If a caller calls more than once

The number of times the same caller called is displayed (×2 to ×9). The date and time of the most recent call will be recorded. After checking, ×2 to ×9 will be replaced with “√”.

Ex. The caller called 5 times.

```
NANCY BROWN
1 - 000 - 222 - 3333
3 : 10P JUN . 10 ×5
```

## Calling Back from the Caller List

### With the base unit

1 Press **√** or **^** to enter the list.

- The number of new calls is displayed.

2 Press **√** or **^** to find the desired caller.

```
JACK SMITH
1 - 234 - 567 - 8901
3 : 10P JUN . 9
```

3 Lift the handset or press

**DIGITAL SP-PHONE**.

- The displayed phone number is dialed automatically.
- You can press a line button instead of pressing

**DIGITAL SP-PHONE**.

```
Talk Line2
12345678901
```

### With the cordless handset

1 Press **√** or **^** to enter the list.

- The number of new calls is displayed.

2 Press **√** or **^** to find the desired caller.

```
JACK SMITH
1-234-567-8901
3:10P JUN. 9
```

3 Press **TALK**.

- The displayed phone number is dialed automatically.
- You can press a line button instead of pressing **TALK**.

```
TALK 
Talk Line2
12345678901
```

- In some cases, you may have to edit the number before dialing (p. 43). (Ex. You may have to delete “1” and the area code.)
- If a phone number is not displayed in the caller information, you cannot call back that caller.



## Editing the Caller's Phone Number

The unit can edit a phone number into one of 4 patterns.

**Make sure that the base unit/cordless handset is in the standby mode.**

1 Press  $\checkmark$  or  $\wedge$  to enter the list.

```
30 new calls
v^      ▶=Directory
```

2 Press  $\checkmark$  or  $\wedge$  to find the desired caller.

```
FRED PARKER
1-234-321-5555
11:20A JAN.12
```

3 Press **EDIT** to select a pattern. Each time you press **EDIT**, the number is rearranged into one of 4 different patterns.

(a) **Phone no.**

(b) **Area code** – **Phone no.**

(c) 1 – **Phone no.**

(d) 1 – **Area code** – **Phone no.**

- The order in which patterns (a) – (d) are displayed depends on how the telephone number is displayed in step 2.

(a)

```
FRED PARKER
321-5555
11:20A JAN.12
```



(b)

```
FRED PARKER
234-321-5555
11:20A JAN.12
```



(c)

```
FRED PARKER
1-321-5555
11:20A JAN.12
```



(d)

```
FRED PARKER
1-234-321-5555
11:20A JAN.12
```

4 After editing the number, you can continue with calling back or storing procedures.

To call back, if using the base unit, lift the handset or press

**DIGITAL SP-PHONE**. If using the cordless handset, press **TALK**.

To store the number in the directory, press **ENTER** (see page 44, from step 3).

- The number edited in step 3 will not be maintained in the Caller List.

## ➔ Using the Caller List

### Storing Caller List Information in the Directory

The base unit and cordless handsets can store names and phone numbers that are in the Caller List into the directory.

**Make sure that the base unit/cordless handset is in the standby mode.**

1 Press **▼** or **▲** to enter the list.

```
30 new calls
▼▲      ►=Directory
```

2 Press **▼** or **▲** to find the desired caller.

- If the number requires editing, see page 43.

```
CINDY TURNER
1-234-456-7890
11:20A JAN.12
```

3 Press **ENTER**.

```
Save directory?

ENTER=Yes
```

4 Press **ENTER** again.

```
CINDY TURNER
12344567890
```

**If there is no name information for the caller, "Enter name" will be displayed.**

```
Enter name :
█
◀▶      ENTER=Save
```

a) If a name is not required, press **ENTER**.

b) If a name is required, enter the name (p. 37), and press **ENTER**.

```
Enter name :
CINDY TURNER█
◀▶      ENTER=Save
```

- A beep sounds.
- To store other items, repeat from step 2.
- To return to the standby mode, press **EXIT**.

- If the display shows "Memory is full" in step 4, press **EXIT**. To erase stored items from the directory, see page 39.
- You cannot store caller information in the directory if a phone number is not displayed.

## Erasing Caller List Information

After checking the Caller List, the base unit and cordless handsets can erase some or all of their entries.

**Make sure that the base unit/cordless handset is in the standby mode.**

### To erase a specific caller from the Caller List

1 Press  $\checkmark$  or  $\wedge$  to enter the list.

```

30 new calls
v^      ▶=Directory
  
```

2 Press  $\checkmark$  or  $\wedge$  to find the caller you want to erase from the caller list.

```

TOM REAGAN
1-666-444-5555
12:20A JAN.12 ✓
  
```

3 Press **CLEAR**.

- A beep sounds and the information is erased.
- To erase other items, repeat from step 2.
- To return to the standby mode, press **EXIT**.

```

Clear
  
```

### To erase all entries in the Caller List

1 Press  $\checkmark$  or  $\wedge$  to enter the list.

Make sure this display is shown.

```

0 new call
v^      ▶=Directory
  
```

2 Press **CLEAR**.

- To stop erasing, press  $\blacktriangleleft$ .

```

All clear?
◀=No    CLEAR=Yes
  
```

3 Press **CLEAR**.

- A beep sounds and all entries are erased.

```

All clear
  
```

# Special Features

---

## How to Use the PAUSE Button **Base Unit** **Handset** (For Analog PBX Line/Long Distance Service Users)

We recommend you press **PAUSE** if a pause is required for dialing with a PBX or to access a long distance service.

Ex. Line access number **9** (PBX)

**9** → **PAUSE** → Phone number

- Pressing **PAUSE** once creates a 3.5 second pause. This prevents misdialing when you redial or dial a stored number.
- Pressing **PAUSE** more than once increases the length of the pause between numbers.

## For Call Waiting Service Users **Base Unit** **Handset**

If another call is received on the same line while talking, you will hear a call-waiting tone. Press **CALL WAIT** to answer the second call.

- The first call is put on hold.
- To return to the first caller, press **CALL WAIT** again.
- The call waiting service cannot be used when:
  - the first call on the same line is placed on hold,
  - you are having a conference call (p. 35), or
  - the Automated Attendant System or Answering System is responding to the first call on the same line (p. 58, 65).
- If this function does not operate properly, consult your telephone company for details.

## Call Waiting Caller ID Feature

Call Waiting Caller ID feature allows the base unit and cordless handset to display a second caller's information.

NANCY BROWN
1 - 0 0 0 - 2 2 2 - 3 3 3 3
- - - - - W a i t i n g - - - - -

After you hear a call-waiting tone while talking, the display will show the caller's name with the phone number and "----Waiting----".

- Please contact your telephone company for details and availability in your area.

## Temporary Tone Dialing **Base Unit** **Handset** (For Rotary or Pulse Service Users)

Press **TONE** before entering access numbers which require tone dialing.

- The dialing mode changes to tone. You can enter numbers to access an answering service, electronic banking service, etc. When you hang up, the mode will return to pulse.
- Access numbers entered after pressing **TONE** will not be included when redialing.

## Setting the Key Lock **Handset**

You can lock all the buttons and the navigator key of the cordless handset. Only incoming calls are accepted until the key lock is canceled.

**Make sure that the cordless handset is in the standby mode.**

Press and hold **FUNCTION** until a short beep sounds.

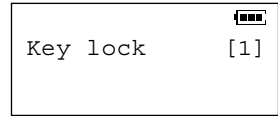

- In this mode emergency calls cannot be made. Key lock mode must be canceled.

**To cancel the key lock**, press and hold **FUNCTION** until a short beep sounds.

- “Key lock” will disappear.

## FLASH Button **Base Unit Handset**

Pressing **FLASH** allows you to use special features of your host PBX such as transferring an extension call or accessing special telephone services (optional) such as call waiting.

### Selecting the flash time for each line **Base Unit**

The flash time depends on your telephone exchange or host PBX. You can select from flash times: “700, 600, 400, 300, 250, 110, 100 or 90 ms (milliseconds)”. Your phone comes from the factory set to “700 ms”.

**Make sure that the base unit is in the standby mode.**

- 1 Press **FUNCTION**.
- 2 Press **▼** or **▲** until the arrow points to “Dial setting”, and press **▶**.
- 3 Press **▼** or **▲** until the arrow points to “Set flash time”, and press **▶**.
  - The current settings are displayed.
- 4 Select the desired time by pressing **▼** or **▲** for each line. To move to the other line, press **▶** or **◀**.
- 5 Press **ENTER**.
  - A beep sounds.
  - To return to the standby mode, press **EXIT**.

Flash time	
Line1	Line2
700m	700m

- If you are connected via a PBX, a longer flash time may be necessary to use PBX functions (transferring a call etc.). Consult your PBX installer for the correct setting.

# Other Programmable Settings

## Setting the Auto Talk Feature **Handset**

The Auto Talk feature allows you to answer a call by lifting the cordless handset off the charger without pressing **(TALK)**. To view caller's information on the display after lifting the handset, turn this feature OFF. Your phone comes from the factory set to ON.

**Make sure that the cordless handset is in the standby mode.**

- 1 Press **(FUNCTION)**.
- 2 Press  $\nabla$  or  $\blacktriangle$  until the arrow points to "Talk selection", and press  $\blacktriangleright$ .
- 3 Press  $\nabla$  or  $\blacktriangle$  until the arrow points to "Auto talk", and press  $\blacktriangleright$ .
  - The current setting is displayed.
- 4 Select "Off" or "On" by pressing  $\nabla$  or  $\blacktriangle$ .
- 5 Press **(ENTER)**.
  - A beep sounds.
  - To return to the standby mode, press **(EXIT)**.
  - To answer a call when the Auto Talk feature is OFF, lift the handset off the charger, and press **(TALK)** or the relevant line button.

```
Auto talk  ;On
           ;
           ;
v^         ENTER=Save
```

## Selecting the Ringer Pattern **Base Unit Handset**

You can select the desired ringer patterns of the base unit and cordless handsets. 4 patterns are available for each line. Your phone comes from the factory set to pattern 1. **Programming must be carried out separately for the base unit and cordless handset(s).**

**Make sure that the base unit/cordless handset is in the standby mode.**

- 1 Press **(FUNCTION)**.
- 2 Press  $\nabla$  or  $\blacktriangle$  until the arrow points to "Ringer setting", and press  $\blacktriangleright$ .
- 3 Press  $\nabla$  or  $\blacktriangle$  until the arrow points to "Ringer pattern", and press  $\blacktriangleright$ .
  - The current settings are displayed.
- 4 Enter the desired pattern using the dialing buttons (**(1)** to **(4)**) for each line. To move to the other line, press  $\blacktriangleright$  or  $\blacktriangleleft$ .
  - Each time you select a pattern, it rings.
- 5 Press **(ENTER)**.
  - A beep sounds.
  - To return to the standby mode, press **(EXIT)**.

```
Ringer pattern
Line1      Line2
1          1
```





## Calling Line Selection **Base Unit** **Handset**

The base unit and cordless handsets will automatically select a free line when you make a call. You can change the calling line selection of the base unit and handsets.

**Programming must be carried out separately for the base unit and cordless handset(s).**

**Make sure that the base unit/cordless handset is in the standby mode.**

**1** Press **[FUNCTION]**.

**2** If using the base unit:  
Press  $\nabla$  or  $\blacktriangle$  until the arrow points to "Line setting", and press  $\blacktriangleright$ .

OR

If using the cordless handset:  
Press  $\nabla$  or  $\blacktriangle$  until the arrow points to "Talk selection", and press  $\blacktriangleright$ .

**3** While "Line selection" is at the arrow, press  $\blacktriangleright$ .

- The current setting is displayed.

Line selection	:	Auto
$\nabla$ $\blacktriangle$		ENTER = Save

### **Auto:**

A free line will be selected (LINE 1 has priority) when making a call (factory preset).

**Line1:** Line 1 will be selected when making a call.

**Line2:** Line 2 will be selected when making a call.

**4** Select the desired line selection by pressing  $\nabla$  or  $\blacktriangle$ .

**5** Press **[ENTER]**.

- A beep sounds.
- To return to the standby mode, press **[EXIT]**.

- Any line can be selected manually, regardless of the programmed line selection, by pressing that line button.

### Setting Call Restriction Numbers **Base Unit**

You can prevent selected phone numbers from being dialed by the base unit and cordless handsets. Phone numbers with the restricted leading digits cannot be dialed out. You can assign up to 4 call restriction numbers (up to 11 digits each) to the base unit and handsets. If you try to dial the restricted numbers, busy tones will sound and “Call restriction” will be displayed. Your phone comes from the factory set to OFF.

**Make sure that the base unit is in the standby mode.**

1 Press **FUNCTION**.

2 Press **▼** or **▲** until the arrow points to “Dial setting”, and press **▶**.

3 Press **▼** or **▲** until the arrow points to “Call restrict.”, and press **▶**.

- “1” indicates the first restriction number.

```
▶Call restrict.1
No. :
Ext. #: - - - - -
```

(To store the second to fourth restriction numbers, select the number by pressing the dialing button, **2** to **4**.)

4 Press **▼** to select “No.”.

```
Call restrict.1
▶No. : ■
Ext. #: - - - - -
```

5 Enter a call restriction number up to 11 digits.

- If you misdial, press **CLEAR**. The digits are erased from the right. To erase all the digits, press and hold **CLEAR**.

6 Press **▼** to select “Ext. #”.

```
Call restrict.1
No. : 111
▶Ext. #: - - - - -
```

7 Enter the extension numbers (**1** to **8**) which cannot dial the restricted numbers. Enter **0** for the base unit.

- If you make a mistake, press the number again to delete.
- To erase all the numbers, press **CLEAR**.

```
Call restrict.1
No. : 111
▶Ext. #: - 2 - 4 - - - 0
```

8 Press **ENTER**.

- A beep sounds.  
Ex. Phone numbers starting with “111” are restricted for handset 2 & 4 and the base unit.

```
Call restrict.1
No. : 111
Ext. #: - 2 - 4 - - - 0
```

- To store a second call restriction number, start again from step 3.
- To return to the standby mode, press **EXIT**.



## To cancel the restricted handset(s) and/or base unit

Repeat steps 1 to 4 on page 50, and press **✓** to select “Ext. #”. Erase the base unit and/or handset number(s) by pressing the dialing button(s) (**0**, **1** to **8**), and press **ENTER**.

## To cancel the restriction

Repeat steps 1 to 3 on page 50. Select the restriction number “1” through “4” by pressing the dialing button (**1** to **4**). Press **CLEAR**, and press **ENTER**.

## Incoming Call Tone **Base Unit** **Handset**

While using one line, you can be informed if another call arrives on the other line by two tones. During an intercom call or while listening to messages (p. 68, 71), you can also be informed by two tones if a call arrives. If you set to ON, this incoming call tone will be heard for as long as the other line rings. To delete this incoming call tone, set to OFF. To set the incoming call tone to sound twice, set to “2”. Your base unit comes from the factory set to OFF. Your cordless handset comes from the factory set to ON.

**Programming must be carried out separately for the base unit and cordless handset(s).**

**Make sure that the base unit/cordless handset is in the standby mode.**

- 1 Press **FUNCTION**.
- 2 Press **✓** or **^** until the arrow points to “Ringer setting”, and press **▶**.
- 3 Press **✓** or **^** until the arrow points to “Incoming call”, and press **▶**.
  - The current setting is displayed.
- 4 Select the desired setting, “2”, “On” or “Off”, by pressing **✓** or **^**.
- 5 Press **ENTER**.
  - A beep sounds.
  - To return to the standby mode, press **EXIT**.

```

Incoming call,
                tone: 2
  v ^          ENTER = Save
```

### Setting the PIN **Base Unit**

A 4-digit PIN (Personal Identification Number) prevents unauthorized persons from registering a cordless handset at the base unit and using it. Once the PIN is set, the PIN is required for registration of the cordless handsets (p. 53).

**Make sure that the base unit is in the standby mode.**

- 1 Press **FUNCTION**.
- 2 Press **▼** or **▲** until the arrow points to “Registration”, and press **▶**.
- 3 While “Set PIN” is at the arrow, press **▶**.

```
Enter new PIN
                : ■ ---
                ENTER=Set
```

- 4 Enter a 4-digit PIN, and press **ENTER**.
  - If you enter a wrong number, press **CLEAR**, and enter the PIN again.

```
Enter new PIN
again          : ■ ---
                ENTER=Save
```

- 5 Enter the PIN again, and press **ENTER**.
  - A beep sounds.
  - To return to the standby mode, press **EXIT**.

Once you have set a PIN, you cannot confirm it. We recommend you write down the PIN. If you forget your PIN, please refer to “Clearing Settings” (p. 89).

### To change the PIN

- 1 Press **FUNCTION**. Press **▼** or **▲** until the arrow points to “Registration”, and press **▶**.
- 2 While “Set PIN” is at the arrow, press **▶**.

```
Enter old PIN
                : ■ ---
                ENTER=Set
```

- 3 Enter the current PIN, and press **ENTER**.

```
Enter new PIN
                : ■ ---
                ENTER=Set
```

- 4 Enter a new 4-digit PIN, and press **ENTER**.

```
Enter new PIN
again          : ■ ---
                ENTER=Save
```

- 5 Enter the new PIN again, and press **ENTER**.
  - A beep sounds.
  - To return to the standby mode, press **EXIT**.

**To erase the PIN**, repeat steps 1 to 3 and press **ENTER** twice.



# Registering Optional Cordless Handsets

## Using the PIN *Base Unit & Handset*

The included cordless handset has been pre-registered with the base unit. You will have to register optional cordless handsets. Handsets will not operate unless registered with the base unit. A handset will be assigned the number at registration. The handset number is used as the extension number (p. 32, 58). After storing the PIN (p. 52), you must enter it at registration. Only one handset can be registered at a time.

**Make sure that the base unit and cordless handset are in the standby mode. Registration must be completed within 1 minute.**

### 1 Base unit:

Press **FUNCTION**.

2 Press  $\nabla$  or  $\blacktriangle$  until the arrow points to "Registration", and press  $\blacktriangleright$ .

3 Press  $\nabla$  or  $\blacktriangle$  until the arrow points to "HS registration", and press  $\blacktriangleright$ .

```
Handset
registering
```

### 4 Cordless handset:

Press **FUNCTION**.

5 Press  $\nabla$  or  $\blacktriangle$  until the arrow points to "Registration", and press  $\blacktriangleright$ .

6 While "HS registration" is at the arrow, press  $\blacktriangleright$ .

```
Handset
registering
```

7 Enter the PIN (p. 52).

```
HS registration
Enter PIN: ■---
ENTER=Set
```

- If you enter the wrong PIN, press **CLEAR**, and enter the PIN again.

8 Press **ENTER**.

### 9 Base unit/cordless handset:

Wait until a beep sounds on the base unit and handset and until both of the displays show the assigned handset number. Ex. Handset number is 5.

Base Unit

```
Handset5
registered
```

Cordless Handset

```
Handset5
registered
```

- To return to the standby mode, press **EXIT**.
- The handset number ([1] to [8]) will be displayed on the handset.

### Canceling Cordless Handset Registration **Base Unit & Handset**

If you no longer need to use a cordless handset or if you need to register a handset to a different base unit of the same model, it may be necessary to cancel the registration.

Only one handset can be canceled at a time.

**Make sure that the base unit and cordless handset are in the standby mode.**

#### Base unit

- 1 Press **FUNCTION**.
- 2 Press  $\nabla$  or  $\blacktriangle$  until the arrow points to "Registration", and press  $\blacktriangleright$ .
- 3 Press  $\nabla$  or  $\blacktriangle$  until the arrow points to "Deregistration", and press  $\blacktriangleright$ .

- The registered handset numbers are displayed.

```
Deregistering
HS No. : 1 2 3 4 5 6 7 8
◀▶          ENTER=Set
```

- 4 Press  $\blacktriangleright$  or  $\blacktriangleleft$  to move the cursor to the handset number to be canceled.
- 5 Press **ENTER**.

```
Deregister?
Handset3
◀=No    CLEAR=Yes
```

- To stop, press  $\blacktriangleleft$ .

- 6 Press **CLEAR**.
  - A beep sounds and "Clear" is displayed.
  - To cancel registration of another handset, start again from step 3.
  - To return to the standby mode, press **EXIT**.

#### Cordless handset

- 1 Press **FUNCTION**.
- 2 Press  $\nabla$  or  $\blacktriangle$  until the arrow points to "Registration", and press  $\blacktriangleright$ .
- 3 Press  $\nabla$  or  $\blacktriangle$  until the arrow points to "Deregistration", and press  $\blacktriangleright$ .

```
Deregister?
Handset3
◀=No    CLEAR=Yes
```

- To stop, press  $\blacktriangleleft$ .

- 4 Press **CLEAR**.
  - A beep sounds and "Clear" is displayed.
  - To return to the standby mode, press **EXIT**.
  - [-] will be displayed.

The canceling procedure must be carried out with both the base unit and the cordless handset.

- The cordless handset will not work. To use it again, registration will be required (p. 19, 53).

## Selecting the Line Mode **Base Unit**

If the line is connected to a low voltage system such as a PBX, set to “B”. Otherwise, the line indicator may not operate properly, the Call Waiting Caller ID feature may not be used (p. 46), you may not hear the incoming call tone (p. 51), and the unit may not alert your pager (p. 82). Both lines are preset to “A”.

**Make sure that the base unit is in the standby mode.**

- 1 Press **FUNCTION**.
- 2 Press  $\downarrow$  or  $\uparrow$  until the arrow points to “Line setting”, and press  $\blacktriangleright$ .
- 3 Press  $\downarrow$  or  $\uparrow$  until the arrow points to “Set line mode”, and press  $\blacktriangleright$ .
  - The current settings are displayed.
- 4 Select “B” or “A” by pressing  $\downarrow$  or  $\uparrow$  for each line. To move to the other line, press  $\blacktriangleright$  or  $\blacktriangleleft$ .
- 5 Press **ENTER**.
  - A beep sounds.
  - To return to the standby mode, press **EXIT**.

Line mode	
Line1	Line2
A	A

## Erasing the Directory, Caller List and Redial List **Base Unit Handset**

You can erase all entries in the directory, caller list and redial list.

**Programming must be carried out separately for the base unit and cordless handset(s).**

**Make sure that the base unit/cordless handset is in the standby mode.**

- 1 Press **FUNCTION**.
- 2 Press  $\downarrow$  or  $\uparrow$  until the arrow points to “Initialization”, and press  $\blacktriangleright$ .
- 3 Press  $\downarrow$  or  $\uparrow$  until the arrow points to “Dial data”, and press  $\blacktriangleright$ .
  - The current settings are displayed.
  - RDL=Redial List CID=Caller List DIR=Directory
- 4 Select “Yes” to erase the list by pressing  $\downarrow$  or  $\uparrow$ . Select “No” to leave the list. To move to another list, press  $\blacktriangleright$  or  $\blacktriangleleft$ .
- 5 Press **ENTER**.
  - A beep sounds.
  - To return to the standby mode, press **EXIT**.

Delete dial data		
RDL	CID	DIR
No	No	No

# Voice Mail System

The Voice Mail System allows you to receive and deliver voice messages using mailboxes. The unit accommodates one general delivery mailbox and a maximum of 8 personal mailboxes which are assigned to the registered cordless handsets. The mailbox numbers are the same as the handset numbers.

The Voice Mail System works fully with the Automated Attendant System, which routes incoming calls to a specified mailbox and allows a caller to leave a message (p. 58). If a caller does not specify a mailbox, the call is routed to the general delivery mailbox. With the Answering System (p. 65), all calls are routed to the general delivery mailbox. **You can set either the Automated Attendant System or the Answering System to either line.**

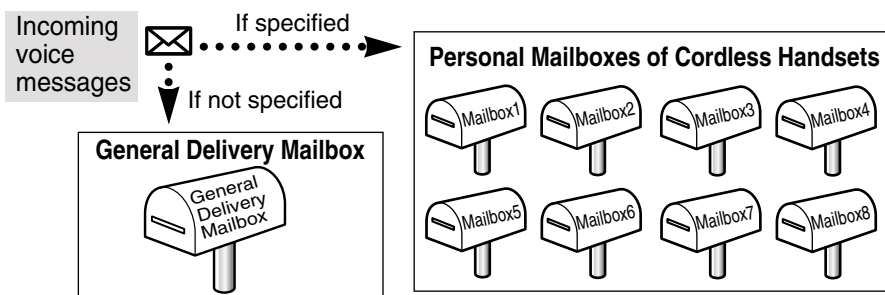

- The maximum number of personal mailboxes you can use is equal to the number of registered handsets.

The base unit and handset users can use the Voice Mail System by accessing their mailboxes. Each cordless handset user can only access his/her own mailbox. The general delivery mailbox is managed by the base unit user (operator). The cordless handset users can access this mailbox. The following functions are possible:

- listening to messages left in a mailbox (p. 68, 71)
- transferring a message left in a mailbox to other mailboxes (p. 70, 72)
- delivering your own message to other mailboxes (p. 74)

You can also access the Voice Mail System features remotely from a touch tone phone (p. 79).

All messages (greeting, incoming, etc.) are stored in digital memory (p. 69). **The total recording time is about 50 minutes** (about 100 minutes in “Long Recording mode” p. 75). The maximum recording time for each caller is 3 minutes. A maximum of 255 messages (including greeting messages) can be recorded.

- The base unit user can monitor incoming calls that are being recorded in the general delivery mailbox. (Call monitoring feature p. 75).
- The base unit user can check the remaining recording time and number of messages which can still be recorded (p. 76).



## Setting the Mailbox Password **Base Unit** **Handset**

Assign a **4-digit password (0000-9999)** to each mailbox to prevent unauthorized persons from accessing mailboxes and listening to the messages remotely from a touch tone phone. The factory preset of the general delivery mailbox is "0000". The preset password for each mailbox is a 4-digit number using the mailbox number. (Ex. "1111" for Mailbox 1, "2222" for Mailbox 2) Each password must be unique.

You can stop unauthorized accesses to your personal mailbox from the cordless handset using this password. If required, turn the direct handset access mode OFF on your handset. Once you turn it OFF, no one can use the ☒ (Voice Mail) button features and access the mailbox without entering the password. Your cordless handset comes from the factory set to ON. **The general delivery mailbox password must be stored using the base unit and each personal mailbox password must be stored using the handset.**

**Make sure that the base unit/cordless handset is in the standby mode.**

**1** Press **[FUNCTION]**, and press  
 ▼ or ▲ until the arrow points  
 to "Voice mail", and press ►.

**2** While "Set password" is at the  
 arrow, press ►.

- The password is displayed.

**3** Enter a password using a **4-**  
**digit number.**

- If you enter a wrong number, press **[CLEAR]**, and enter the password again.

**4** If using the base unit:  
 Press **[ENTER]**.

**OR**

If using the cordless handset,  
 turn on/off the direct handset  
 access mode:

① Press **[ENTER]**.

Direct HS. access
: On
▼ ^ ENTER=Save

② Select "Off" or "On" by  
 pressing ▼ or ▲, and  
 press **[ENTER]**.

- A beep sounds.
- To return to the standby mode, press **[EXIT]**.

### To check the password:

Repeat steps 1 and 2.

- The password is displayed. When finished, press **[EXIT]**.

### To erase the password

After erasing the password, the  
 remote operation feature will not be  
 used.

Press **[CLEAR]** in step 3, and press  
**[ENTER]**.

- The direct handset access mode will be on and you can access the mailbox from your handset without the password.

# Automated Attendant System

## How Automated Attendant System Works

The Automated Attendant System is a flexible communication tool that can enhance your productivity by improving your call management. The automated attendant answers incoming calls and then routes the callers to the base unit or the desired cordless handset.

The base unit plays the role of operator with the cordless handsets as the extensions. The extension numbers are the same as the handset numbers (p. 19, 53). Callers can reach desired mailboxes using this system to leave messages.

You can set this system to either line to suit your needs (p. 59).

### Calling the automated attendant

When a caller calls a line to which the Automated Attendant System is assigned, the caller will first hear a greeting message. You can record this message yourself or use the pre-recorded message (p. 59, 60).

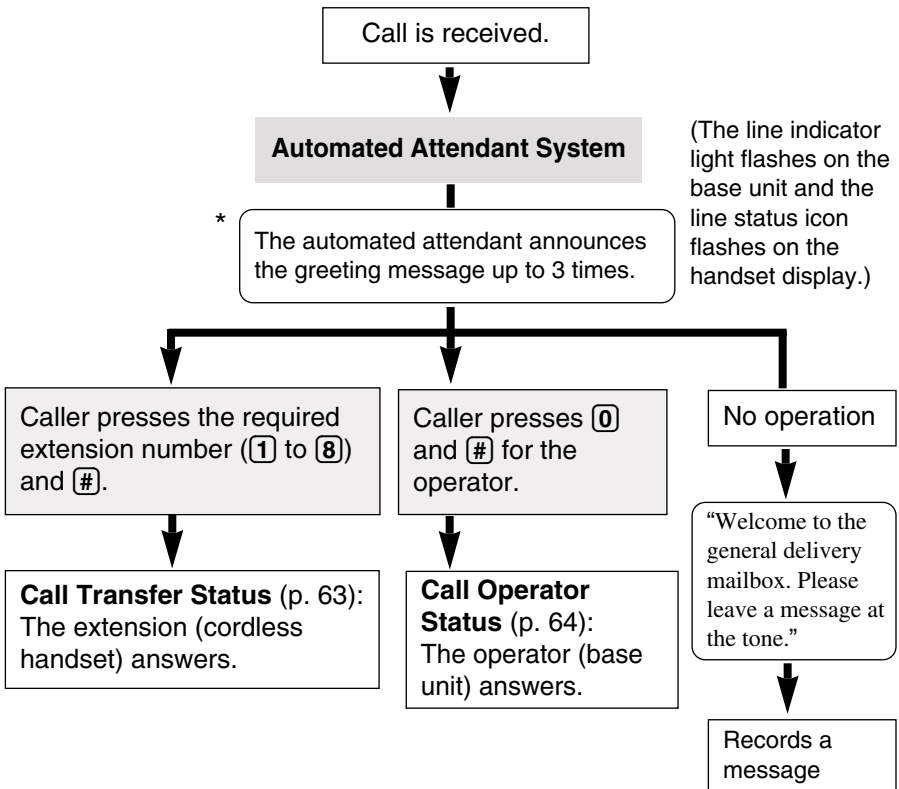

\*If callers select neither extension nor operator, or call from rotary telephones, the greeting message will be repeated 3 times, and then they will be transferred to the general delivery mailbox where they can leave messages.



## Setting the Automated Attendant System **Base Unit**

The Automated Attendant System can be set to either line. You can record up to 5 greeting messages of **up to 2 minutes** each. The same greeting message can be used on either line. The same messages can be used for the Answering System (p. 65).

We recommend you record **brief greeting messages** (see sample on next page) in order to leave more time for recording new messages.

If you do not record a greeting message, the following pre-recorded greeting message will be used:

"Hello, this is Automated Attendant System. Please enter your party's extension, followed by #. If you are using a rotary telephone, stay on the line."

**Make sure that the base unit is in the standby mode.**

### To turn on the Automated Attendant System and select the pre-recorded greeting message

If the line's ANSWER ON indicator lights, press the **ANSWER ON** button to turn it off.

**1** Press the line's **ANSWER ON** button.

- The ANSWER ON indicator lights.
- The current setting is displayed.

```
Auto answering
Prerecord greet.
-L1-          ▶=Change
```

**2** Press **▶** within 10 seconds.

```
Auto attendant
▶Auto answering
v^          ▶=Set
```

**3** Select "Auto attendant" by pressing **v** or **^**, and press **▶**.

```
Select greeting
:Prerecord"
v^          ▶=Set
```

**4** To select "Prerecord", press **▶**.

- The pre-recorded message is played.
- The relevant line's auto attendant icon will be displayed.

```
L1
Auto attendant
Prerecord greet.
```

```
12:00AM JAN. 1
```

## ➔ Automated Attendant System

### To turn on the Automated Attendant System and record a greeting message

If the line's ANSWER ON indicator lights, press the **ANSWER ON** button to turn it off.

**1** Press the line's **ANSWER ON** button.

- The ANSWER ON indicator lights.
- The current setting is displayed.

```
Auto answering
Prerecord greet.
-L1-           ▶=Change
```

**2** Press ▶ within 10 seconds.

**3** Select "Auto attendant" by pressing ▼ or ▲, and press ▶.

```
▶Auto attendant
Auto answering
▼▲           ▶=Set
```

**4** Select "Greeting1" by pressing ▼ or ▲.

- If the message has not been stored, "(none)" is displayed.
- Each time you press ▼, the display changes from "Greeting1" through "Greetings5".

```
Select greeting
:Greeting1 (none)
▼▲           ▶=Set
```

**5** Press ▶.

```
Greeting1 record
           ▶=Start
```

**6** Press ▶ to start recording.

```
Greeting1 record
           : 00
           ▶=End
```

**7** After the tone, talk clearly, about 8 inches (20 cm) away from the **MIC** (microphone). To end, press ▶.

- If the elapsed recording time exceeds 2 minutes, the unit will stop recording.
- The recorded message will be played.
- To change the message, press **1** and start again from step 6.

```
Greeting1 check
           : 55
1=Change    2=OK
```

**8** Press **2** to select the message.

- The relevant line's auto attendant icon will be displayed.

```
12 : 00AM JAN . 1
```

#### Greeting message sample:

"Thank you for calling (your company name and/or number). For Mr. Smith, press 1 and #. For Mr. Jones, press 2 and #. To call the operator, press 0 and #."

- You can adjust the speaker volume by pressing ▲ or ▼.
- You can exit the programming mode any time by pressing **EXIT**.
- If a caller uses a rotary telephone, the caller can leave a message at general delivery mailbox after 3 times of greeting.



## To select/change the recorded greeting message

If the line's ANSWER ON indicator lights, press the **ANSWER ON** button to turn it off.

1. Press the line's **ANSWER ON** button, and press ► within 10 seconds.
2. Select "Auto attendant" by pressing ▼ or ▲, and press ►.
3. Select "Greeting1" through "Greeting5" by pressing ▼ or ▲, and press ►.

Greeting3	check	
		: 0 0
1 = Change		2 = OK

- You can go back to the previous display by pressing ◀.

4. **To select the message**, press [2].

OR

### To change the message:

Press [1]. Press ► to start recording. After the tone, talk into the MIC. To end, press ►. Press [2] to select the message.

- If you use the message for the other line, it will also be changed.

## To turn off the Automated Attendant System

Press the line's **ANSWER ON** button.

- The ANSWER ON indicator light goes out and the relevant line's auto attendant icon will disappear.

## Setting the Handset Answer Mode **Handset**

If you are out of the office or unavailable to answer calls, turn ON the answer mode of your handset. Calls will be greeted with a greeting message (see "Recording a Personal Greeting Message" on page 62) and callers can leave messages in your mailbox. Your phone comes from the factory set to OFF. To take calls, leave this mode OFF.

- 1 While the handset is in the standby mode, press ☒.

- If the direct handset access mode is OFF (p. 57), enter the mailbox password and press [#].
- If you have new messages, listen to all of them.

1=Play all msg.
2=Deliver msg.
3=Personal greet

4=To general box
5=Answer on/off
*=End



- 2 Press [5].

- The current setting is displayed.

Auto attendant	
Answer	: Off
1=On	2=Off

- 3 To select ON, press [1].  
To select OFF, press [2].

- 4 Press ☒.

# ➔ Automated Attendant System

## Recording a Personal Greeting Message **Handset**

If the handset answer mode is ON, callers will hear a pre-recorded personal greeting message after reaching your handset's mailbox, as follows:

“Sorry, no one is available to answer the call. Please leave a message at the tone.”  
You can also record your own greeting message of **up to 2 minutes**.

We recommend you record a **brief greeting message** (see sample below) in order to leave more time for recording new messages.

- 1 While the handset is in the standby mode, press ☒.
  - If the direct handset access mode is OFF (p. 57), enter the mailbox password and press #.
  - If you have new messages, listen to all of them.

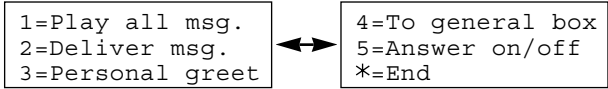

- 2 Press 3.
  - After the current message is played, “To change, press 1. To accept, press 2” is heard.
- 3 Press 1.
  - “Record greeting at the tone. To end recording, press 1” is heard.
- 4 After the tone, talk clearly. To end, press 1.
  - If the elapsed recording time exceeds 2 minutes, the unit will stop recording.
  - The message will be played.

Greeting check	
1=Change	2=OK

Greeting record	
	:00
	1=End

Greeting check	
	:00
1=Change	2=OK

- 5 Press 2, and press ☒.

**Greeting message sample:**  
“Hello, this is (your name). Sorry I cannot take your call. Please leave a message at the tone. Thank you.”

**To erase the recorded message:**  
Follow steps 1 and 2. Press 3 while the message is being played.

- The unit will answer with the pre-recorded greeting message.
- You can adjust the handset volume by pressing ^ or v .



## Call Transfer Status

When a caller specifies an extension by pressing the extension number (1 to 8) followed by (#), the call is connected to that extension, and the extension can take the call. If the extension user is on another call or does not answer, a list of options (Incomplete Call Handling Menu) is announced to guide the caller. If the handset answer mode is ON (p. 61), the caller can leave a message in the mailbox.

- If a caller presses an invalid extension number, “Sorry this number is not assigned” is announced. The caller can call the operator or another extension or leave a message in the general delivery mailbox following the Incomplete Call Handling Menu.

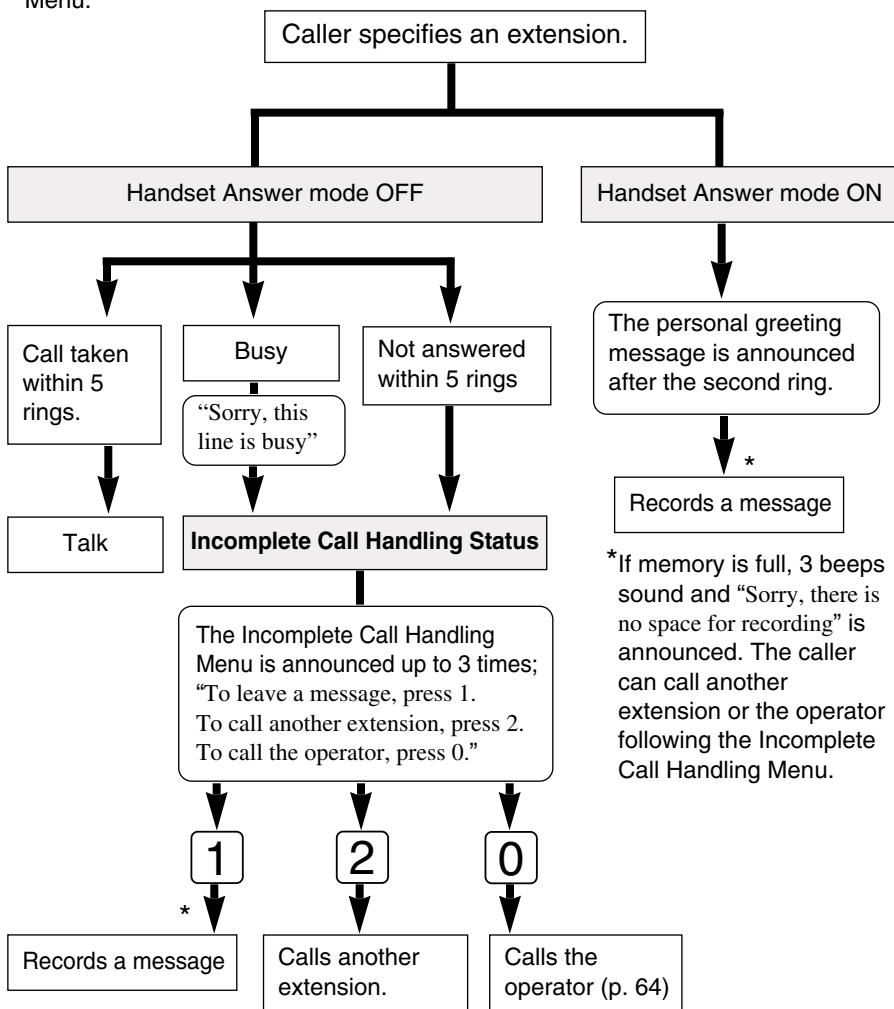

## Call Operator Status

When a caller specifies the operator by pressing **0** and **#**, the call is connected to the operator. If the operator is on another call or does not answer, a list of options (Incomplete Call Handling Menu) is announced to guide the caller. The caller can leave a message in the general delivery mailbox or call an extension.

The operator will also be responsible for answering and handling calls that have been transferred.

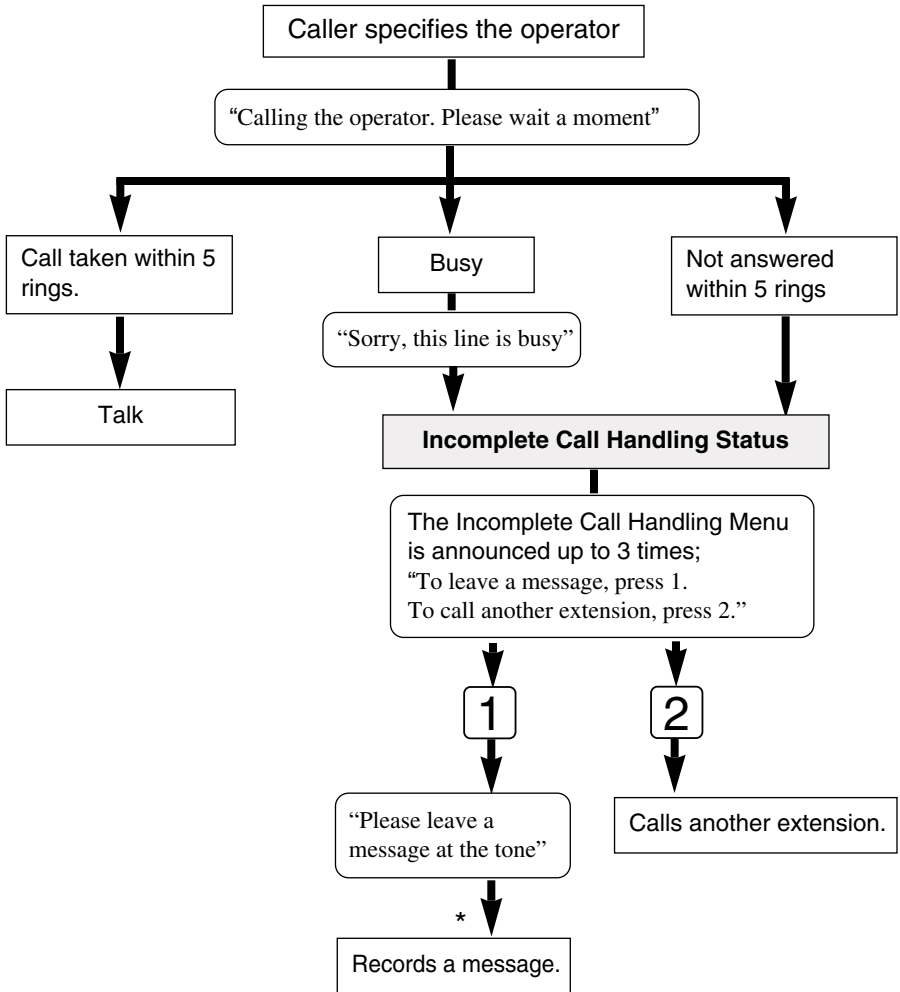

\*If memory is full, 3 beeps sound and “Sorry, there is no space for recording” is announced. The caller can call an extension following the Incomplete Call Handling Menu.





## Setting the Answering System **Base Unit**

The Answering System allows the unit to answer calls with a greeting message. Callers can leave a message in the general delivery mailbox. You can assign this system to either line. Select the number of times the unit rings before the Answering System answers a call, from “2” to “7” or “Toll saver”\* (factory preset). You can record up to 5 greeting messages of **up to 2 minutes** each. The same greeting message can be used on either line. If you do not record a greeting message, the following pre-recorded greeting message will be used:

“Hello, we are not available now. Please leave your name and phone number after the beep. We will return your call.”

**Make sure that the base unit is in the standby mode.**

### To turn on the Answering System and select the pre-recorded greeting message

If the line’s ANSWER ON indicator lights, press the **ANSWER ON** button to turn it off.

**1** Press the line’s **ANSWER ON** button.

- The ANSWER ON indicator lights.
- The current setting is displayed.

```
Auto answering
Prerecord greet.
-L1-           ▶=Change
```

**2** Press **▶** within 10 seconds.

```
Auto attendant
▶Auto answering
∨∧           ▶=Set
```

**3** While “Auto answering” is at the arrow, press **▶**.

- The current setting is displayed.

```
Number of rings
:Toll saver
∨∧           ▶=Set
```

**4** Select the number of rings, “2” to “7” or “Toll saver”\*, by pressing **∨** or **∧**, and press **▶**.

```
Select greeting
:Prerecord
∨∧           ▶=Set
```

**5** To select “Prerecord”, press **▶**.

- The pre-recorded message is played.

```
Line1
Auto answering
Prerecord greet.
```

#### \*Toll Saver:

When you call a line to which the Answering System is assigned, from a touch tone telephone: If the unit answers on the 2nd ring, there is at least one new message in the general delivery mailbox. If the unit answers on the 4th ring, there are no new messages there. **Hang up when you hear the 3rd ring.** This will save you the toll charge for the call.

## ➔ Answering System

### To turn on the Answering System and record a greeting message

We recommend you record **brief greeting messages** (see sample below) in order to leave more time for recording new messages.

If the line's ANSWER ON indicator lights, press the **ANSWER ON** button to turn it off.

**1** Press the line's **ANSWER ON** button.

- The ANSWER ON indicator lights.
- The current setting is displayed.

```
Auto answering
Prerecord greet.
-L1-           ▶=Change
```

**2** Press ▶ within 10 seconds.

```
Auto attendant
▶Auto answering
▽^           ▶=Set
```

**3** While "Auto answering" is at the arrow, press ▶.

**4** Select the number of rings, "2" to "7" or "Toll saver"\* (p. 65), by pressing ▼ or ^ and press ▶.

```
Number of rings
:Toll saver
▽^           ▶=Set
```

**5** Select "Greeting1" by pressing ▼ or ^, and press ▶.

- If the message has not been stored, "(none)" is displayed.
- Each time you press ▼, the display changes from "Greeting1" through "Greetings5".

```
Select greeting
:Greeting1(none)
▽^           ▶=Set
```

**6** Press ▶ to start recording.

```
Greeting1 record
           ▶=Start
```

**7** After the tone, talk clearly, about 8 inches (20 cm) away from the **MIC** (microphone). To end, press ▶.

- If the elapsed recording time exceeds 2 minutes, the unit will stop recording.
- The recorded message will be played.
- To change the message, press **1** and start again from step 6.

```
Greeting1 record
           : 00
           ▶=End
```

```
Greeting1 check
           : 05
1=Change   2=OK
```

**8** Press **2** to select the message.

#### Greeting message sample:

"Thank you for calling (your company name and/or number). Sorry we cannot take your call. Please leave a message at the tone."

- You can adjust the speaker volume by pressing ^ or ▼.
- You can exit the programming mode any time by pressing **EXIT**.

## To select/change the recorded message

If the line's ANSWER ON indicator lights, press the **ANSWER ON** button to turn it off.

1. Press the line's **ANSWER ON** button, and press ► within 10 seconds.
2. While "Auto answering" is at the arrow, press ►.
3. Select the number of rings, "2" to "7" or "Toll saver"\* (p. 65), by pressing ▼ or ▲, and press ►.
  - You can go back to the previous display by pressing ◀.
4. Select "Greeting1" through "Greeting5" by pressing ▼ or ▲, and press ►.

Greeting3	check	
		: 00
1 = Change		2 = OK

5. **To select the message**, press **2**.

OR

### To change the message:

Press **1**. Press ► to start recording.

After the tone, talk into the **MIC**.

To end, press ►. Press **2** to select the message.

- If you use the message for the other line, it will also be changed.

## To turn off the Answering System

Press the line's **ANSWER ON** button.

- The ANSWER ON indicator light goes out.

# Listening to Messages with the Base Unit

If the  (VOICE MAIL) button flashes, new messages have been received in the general delivery mailbox.

The base unit user (operator) will be responsible for handling the following aspects of the general delivery mailbox:

- checking the mailbox for messages and transferring them to the appropriate mailboxes.
- erasing unnecessary messages to lengthen remaining recording time for new messages.

During playback the  (VOICE MAIL) button lights.

## Listening to only new messages

**1** While the base unit is in the standby mode, press .

- The unit announces the number of new messages.

New messages playback *=Command menu
--------------------------------------------

**2** New messages are played.

- During each message playback, the message number is displayed.
- After each message playback, the Message Menu will be announced and displayed:

“To repeat this message, press 1. To play the next message, press 2. To erase this message, press 3. To transfer this message, press 7.”

- At the end of the last message, “This is the last message” will be heard.

1 = Repeat	2 = Next
3 = Erase	
7 = Transfer	

**3** To end the operation, press .

## Listening to all messages

**1** While the base unit is in the standby mode, press and hold  until playback starts.

- The unit announces the total number of messages.

All messages playback *=Command menu
--------------------------------------------

**2** All messages are played.

- During each message playback, the message number is displayed.
- After each message playback, the Message Menu will be announced:

“To repeat this message, press 1. To play the next message, press 2.  
To erase this message, press 3. To transfer this message, press 7.”

- The Message Menu will be displayed.
- At the end of the last message, “This is the last message” will be heard.

**3** To end the operation, press .

- To delete the Message Menu, see page 77.

**Command Menu:**

If you do not press  in step 3 on page 68, after listening to new messages or all messages, the Command Menu will be announced and displayed:

“To play all messages, press 1.

To deliver a message, press 2. (p. 74)”

```
1=Play all msg.
2=Deliver msg.
*=End
```

**During playback**

To <b>repeat</b> a message	Press <b>1</b> or <b>◀</b> . (If you press within 5 seconds of playback, the previous message will be played.)
To <b>skip</b> a message	Press <b>2</b> or <b>▶</b> . (The next message is played.)
To <b>stop</b> operation	Press <b>STOP</b> . <ul style="list-style-type: none"> <li>• To resume playback, press <b>STOP</b>.</li> <li>• If you do not press any button for 60 seconds, the unit will return to the standby mode.</li> </ul>

**To adjust the speaker volume (8 levels):**

Press **▲** or **▼** during playback.

Ex. Level 8

- Each time you press **▲** or **▼**, the volume level will change.

```
Loud
Low ■■■■■■■■ High
```

**Flash Memory Message Backup**

Messages are stored indefinitely on a “flash memory” IC chip and will not be affected by power failures. All messages are saved until you erase them.

**For Caller ID service users (p. 40)**

During playback, the display shows the name and/or number of the caller whose message is being played.

```
JACK SMITH
1-234-567-8901
-- Message 3--
```

**To call back the displayed number:**

During playback, lift the handset or press **DIGITAL SP-PHONE**.

- You can press a line button instead of pressing **DIGITAL SP-PHONE**.
- The unit stops playback and automatically dials the displayed phone number.

## ➔ Listening to Messages with the Base Unit

---

### Transferring a Message

After listening to a message left in the general delivery mailbox, you can transfer it to other mailboxes.

**1** During playback or before the start of the next message, press **[7]**.

- “Enter the destination mailbox number” is announced.

```
Transfer message
Enter mailbox #
```

**2** Enter the destination mailbox numbers using the corresponding dialing buttons (**[1]** to **[8]**) or **[ALL]** for all mailboxes.

- The mailbox numbers and “To accept, press #. To cancel, press \*.” are announced.
- If you make a mistake, press **[\*]** and start again from step 1.

```
Transfer message
BoxNo. : 12 - - 5 - - 8 -
*=Cancel      # = OK
```

**3** Press **[#]**.

- The mailbox numbers entered in step 2 will be announced, and the next message will be played.

```
Transfer message
BoxNo. : 12 - - 5 - - 8 -
```

### Erasing a Message

The base unit display shows the remaining recording time if it is less than 10 minutes or the number of messages which can still be recorded is less than 10.

If the time or number is 0, “Message full” will flash on the display. New messages cannot be recorded.

Erase unnecessary messages. We recommend you erase unnecessary messages after each playback, and regularly check the remaining recording time and the number of messages (p. 76).

While the message you want to erase is being played or before the start of the next message, press **[3]** or **[CLEAR]**.

- A beep sounds and “Message erased” is heard.
- The unit will play the next message.
- The information in the Caller List will not be erased. To erase Caller List information, see page 45.

# Listening to Messages with the Cordless Handset ➔

You can access your handset mailbox and listen to the messages, transfer the messages to other mailboxes or erase unnecessary messages. You can also access the general delivery mailbox from your handset. If "☒" flashes and "Voice mail" is shown on your handset display, new messages have been received in your mailbox. During playback "☒" is displayed.

## Listening to new messages

**1** While the handset is in the standby mode, press ☒.

New messages  
playback  
\*=Command menu

- If the direct handset access mode is OFF (p. 57), enter the mailbox password and press #.
- The unit announces the mailbox number and the number of new messages.

**2** New messages are played.

- During each message playback, the message number is displayed.
- After each message playback, the Message Menu will be announced and displayed:  
"To repeat this message, press 1. To play the next message, press 2. To erase this message, press 3. To transfer this message, press 7."
- At the end of the last message, "This is the last message" will be heard.

1=Repeat    2=Next  
3=Erase  
7=Transfer

**3** After listening to all new messages, the Command Menu is announced and displayed:

- "To play all messages, press 1.
- To deliver a message, press 2. (p. 74)
- To change the personal greeting, press 3. (p. 62)
- To change to the general delivery mailbox, press 4. (p. 73)
- For Automated Attendant Status, press 5. (To turn on/off the handset answer mode p. 61)"

1=Play all msg.  
2=Deliver msg.  
3=Personal greet



4=To general box  
5=Answer on/off  
\*=End

**To listen to all messages, press 1.**

- After each message playback, the Message Menu will be announced and displayed.

**To end the operation, press ☒.**

- To delete the Message Menu, see page 77.

# ➔ Listening to Messages with the Cordless Handset

## During playback

To <b>repeat</b> a message	Press <b>[1]</b> or <b>◀</b> . (If you press within 5 seconds of playback, the previous message will be played.)
To <b>skip</b> a message	Press <b>[2]</b> or <b>▶</b> . (The next message is played.)

### To adjust the handset volume (High, Medium or Low):

Press **▲** or **▼** during playback.

Ex. High

- Each time you press **▲** or **▼**, the volume level will change.

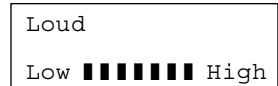

### For Caller ID service users (p. 40)

During playback, the display shows the name and/or number of the caller whose message is being played.

```
JACK SMITH  
1-234-567-8901  
---Message 1---
```

### To call back the displayed number:

During playback, press **[TALK]**.

- You can press a line button instead of pressing **[TALK]**.
- The unit stops playback and automatically dials the displayed phone number.

## Transferring a Message

After listening to a message left in your mailbox, you can transfer it to other mailboxes.

**1** During playback or before the start of the next message, press **[7]**.

- “Enter the destination mailbox number” is announced.

```
Transfer message  
Enter mailbox #
```

**2** Enter the destination mailbox numbers using the corresponding dialing buttons (**[0]**, **[1]** to **[8]**). For the general delivery mailbox, enter **[0]**.

- The mailbox numbers and “To accept, press #. To cancel, press \*” are announced.
- If you make a mistake, press **[\*]** and start again from step 1.

```
Transfer message  
BoxNo.:12--5--80  
*=Cancel #=OK
```

**3** Press **[#]**.

- The mailbox numbers entered in step 2 will be announced, and the next message will be played.

```
Transfer message  
BoxNo.:12--5--80
```





## Erasing a Message

We recommend you erase unnecessary messages after each playback. While the message you want to erase is being played or before the start of the next message, press **3** or **CLEAR**.

- A beep sounds and “Message erased” is heard.
- The unit will play the next message.



## Listening to Messages in the General Delivery Mailbox

You can access the general delivery mailbox from your handset.

- 1** While the handset is in the standby mode, press .
  - If the direct handset access mode is OFF (p. 57), enter the mailbox password and press **#**.
  - If you have new messages, listen to all of them.
- 2** Press **4**.
  - “This is the general delivery mailbox” is heard.
  - After the number of new messages is announced, new messages will be played.
- 3** After listening to all new messages;  
To listen to all messages, press **1**.  
To return to your mailbox, press **4**.  
To end the operation, press .

### Listening to personal mailbox messages from the base unit

If the handset battery has no power or the cordless handset cannot be used any more, you (or the operator) can access your mailbox from the base unit.

1. Press .
  - If you have new messages, listen to all of them.
2. Press the corresponding INTERCOM button (**1** to **8**).
3. Enter your mailbox password (p. 57), and press **ENTER**.
  - The mailbox number will be heard and new messages will be played.
  - To end the operation, press .

# Delivering Your Own Message **Base Unit** **Handset**

The base unit user or cordless handset users can send an identical message of **up to 3 minutes**, to several mailboxes in a single operation.

## With the base unit

- 1 While the base unit is in the standby mode, press .
  - If you have new messages, listen to all of them.

- 2 Press **2**.

```
Deliver message
Enter mailbox #
```

- 3 Enter the destination mailbox numbers using the corresponding dialing buttons (**1** to **8**) or **ALL** for all mailboxes.

```
Deliver message
BoxNo. : 1 - - - - 7 8 -
*=Cancel      # = OK
```

- 4 Press **#**.
  - "Please leave a message at the tone. To end recording, press 1" is heard.

```
Message record
                : 0 0
                1 = End
```

- 5 After the tone, talk clearly, about 8 inches (20 cm) away from the **MIC** (microphone). To end, press **1**.
  - The recorded message is played.

```
Message play
                : 0 0
1 = Change     2 = OK
```

- To change the message, press **1** and record the message again.

- 6 Press **2**, and press .

- In step 3, if you make a mistake, press **\*** and start again from step 2.
- If the elapsed recording time exceeds 3 minutes, the unit will stop recording.
- "Message recorded by (extension number)" is announced before a delivered message is played at the destination extension.

## With the cordless handset

- 1 While the handset is in the standby mode, press .
  - If the direct handset access mode is OFF (p. 57), enter the mailbox password and press **#**.
  - If you have new messages, listen to all of them.

- 2 Press **2**.

```
Deliver message
Enter mailbox #
```

- 3 Enter the destination mailbox numbers using the corresponding dialing buttons (**0**, **1** to **8**). For the general delivery mailbox, enter **0**.

```
Deliver message
BoxNo. : 12 - - 5 - - 8 0
*=Cancel      # = OK
```

- 4 Press **#**.
  - "Please leave a message at the tone. To end recording, press 1" is heard.

```
Message record
                : 0 0
                1 = End
```

- 5 After the tone, talk clearly. To end, press **1**.
  - The recorded message is played.

```
Message play
                : 0 0
1 = Change     2 = OK
```

- To change the message, press **1** and record the message again.

- 6 Press **2**, and press .

# Other Voice Mail System Features ➔

## Call Monitoring Feature **Base Unit**

While a caller is recording a message in the general delivery mailbox, you can monitor the call through the speaker of the base unit. If both lines are receiving calls at the same time, only the first one can be monitored.

You can answer the call by lifting the base unit handset, pressing

**[DIGITAL SP-PHONE]** or the relevant line button.

If the call monitoring feature is not required, turn it OFF by pressing

**[STOP]**. Each time you press **[STOP]** in the standby mode, the feature will

turn ON or OFF. While monitoring a call, you can temporarily turn the

feature OFF by pressing **[STOP]**. The feature will return to ON after the call is disconnected.

Your phone comes from the factory set to ON.

You can also turn the feature ON or OFF using the function menu.

**Make sure that the base unit is in the standby mode.**

1. Press **[FUNCTION]**, and press  $\checkmark$  or  $\wedge$  until the arrow points to "Voice mail", and press  $\blacktriangleright$ .
2. Press  $\checkmark$  or  $\wedge$  until the arrow points to "Call monitoring", and press  $\blacktriangleright$ .
3. Select "Off" or "On" by pressing  $\checkmark$  or  $\wedge$ .
4. Press **[ENTER]**.
  - A beep sounds.
  - To return to the standby mode, press **[EXIT]**.

## Recording Mode **Base Unit**

Messages are recorded in a "High quality sound mode". To lengthen the available recording time, the base unit user can select "Long recording mode" which doubles the total recording time to 100 minutes. Your phone comes from the factory set to "High quality sound mode".

**Make sure that the base unit is in the standby mode.**

- 1 Press **[FUNCTION]**.
- 2 Press  $\checkmark$  or  $\wedge$  until the arrow points to "Voice mail", and press  $\blacktriangleright$ .
- 3 Press  $\checkmark$  or  $\wedge$  until the arrow points to "Recording mode", and press  $\blacktriangleright$ .
- 4 Select "Long recording mode" or "High quality sound" by pressing  $\checkmark$  or  $\wedge$ .

```
Long recording
mode 100min
 $\checkmark$  $\wedge$  ENTER=Save
```

- 3 Press  $\checkmark$  or  $\wedge$  until the arrow points to "Recording mode", and press  $\blacktriangleright$ .

- The current setting is displayed.

```
High quality
sound 50min
 $\checkmark$  $\wedge$  ENTER=Save
```

- 5 Press **[ENTER]**.
  - A beep sounds.
  - To return to the standby mode, press **[EXIT]**.
  - "LR" (Long recording mode) will be displayed if selected.

## ➔ Other Voice Mail System Features

### Transferring a Call to a Personal Mailbox **Base Unit**

After the base unit user (operator) answers an incoming call, the call can be transferred to a mailbox of the person the caller wishes to speak to, where the caller can leave a message. To transfer to a personal mailbox, calls must be sent through the General Delivery Mailbox by the operator. The caller can then enter the extension number and the # sign to reach the mailbox.

The following is how calls must be transferred to the voice mail:

After you (operator) answered a call, you may announce that person the caller wishes to speak to is not available, and remind the caller of the extension number followed by the # sign. You then press , and hang up the line by replacing the handset or pressing **DIGITAL SP-PHONE** on the base unit.

- The caller will then hear the line's greeting message. While the greeting is playing, the caller can press the extension number (1 to 8) followed by (#). After that,
  - If the handset answer mode of the extension is on (p. 61), the caller will hear the personal greeting message at the end of the 2nd ring, then he/she can leave a message at the tone.
  - If the handset answer mode is off (p. 61), the caller will hear "Sorry, no one is available to answer the call. To leave a message press 1. To call another extension press 2. To call the operator press 0" at the end of the 5th ring. Or if the person the caller wishes to speak to, is on another call, the caller will hear "Sorry, this line is busy. To leave a message press 1. To call another extension press 2. To call the operator press 0".

### Checking the Remaining Recording Time and Number of Messages **Base Unit**

If the remaining recording time is less than 10 minutes or the number of messages which can still be recorded is less than 10, the base unit will display the time or number while in the standby mode.

- If the remaining time is less than 1 minute, it will be shown with "sec" (seconds).

	<b>11</b>
12:00AM JAN. 1	
Msg space: 9min	

12:00AM JAN. 1	
Msg space: 9msg	

If the remaining recording time or the number of messages that can still be recorded is 0, "Message full" will flash on the display. Erase unnecessary messages (p. 70, 73).

You can check the time and number of messages by using the function menu as follows. **Make sure that the base unit is in the standby mode.**

- 1 Press **FUNCTION**.
- 2 Press  $\nabla$  or  $\blacktriangle$  until the arrow points to "Voice mail", and press  $\blacktriangleright$ .
- 3 Press  $\nabla$  or  $\blacktriangle$  until the arrow points to "Remaining space", and press  $\blacktriangleright$ .

Remaining space
time: 45min
messages: 200

- To return to the standby mode, press **EXIT**.
- You can erase all messages in the required mailboxes. See page 78.



## Message Menu Mode **Base Unit** **Handset**

After each message is played, the Message Menu is announced and displayed on the base unit and cordless handset as a guide (p. 68, 71). With a touch tone phone from a remote location, this menu is also announced (p. 79). To delete this menu, turn the feature OFF. Your phone comes from the factory set to ON. **Programming must be carried out separately for the base unit and cordless handset(s).**

**Make sure that the base unit/cordless handset is in the standby mode.**

- 1 Press **FUNCTION**.
- 2 Press  $\nabla$  or  $\wedge$  until the arrow points to "Voice mail", and press  $\blacktriangleright$ .
- 3 Press  $\nabla$  or  $\wedge$  until the arrow points to "Message menu", and press  $\blacktriangleright$ .
  - The current setting is displayed.
- 4 Select "Off" or "On" by pressing  $\nabla$  or  $\wedge$ .
- 5 Press **ENTER**.
  - A beep sounds.
  - To return to the standby mode, press **EXIT**.

Message menu $\nabla$
$\nabla$ On $\wedge$
$\nabla$ $\wedge$ ENTER = Save

## Automatic Message Delete Feature **Base Unit**

If this feature is set to ON, messages left in all mailboxes will automatically be erased after a month. Your phone comes from the factory set to OFF.

**Make sure that the base unit is in the standby mode.**

- 1 Press **FUNCTION**.
  - 2 Press  $\nabla$  or  $\wedge$  until the arrow points to "Voice mail", and press  $\blacktriangleright$ .
  - 3 Press  $\nabla$  or  $\wedge$  until the arrow points to "Auto msg delete", and press  $\blacktriangleright$ .
    - The current setting is displayed.
  - 4 Select "On" or "Off" by pressing  $\nabla$  or  $\wedge$ .
  - 5 Press **ENTER**.
    - A beep sounds.
    - To return to the standby mode, press **EXIT**.
- The information in the Caller List will not be erased. To erase Caller List information, see page 45.

Auto msg delete
$\nabla$ Off $\wedge$
$\nabla$ $\wedge$ ENTER = Save

### Erasing All Messages in Mailboxes **Base Unit**

The base unit user can erase all incoming messages in any mailbox. Greeting messages can also be erased at the same time if required. Inform the mailbox owners before erasing and check that there are no new messages in the mailboxes.

**Make sure that the base unit is in the standby mode.**

**1** Press **[FUNCTION]**.

**2** Press **▼** or **▲** until the arrow points to "Voice mail", and press **▶**.

**3** Press **▼** or **▲** until the arrow points to "Delete message", and press **▶**.

```
Delete message
BoxNo. : - - - - -
                ▶=Next
```

**4** Enter the mailbox numbers where messages are to be erased, using the corresponding dialing buttons (**1** to **8**). Enter **0** for the general delivery mailbox.

- If you make a mistake, press the number again to delete.

**5** Press **▶**.

```
BoxNo. : 1 - - 4 5 - - - 0
Incoming message
▼▲ CLEAR=Delete
```

**6** To erase the greeting messages at the same time, press **▼** or **▲** to select "Greet. & Incoming". If not required, go to step 7.

```
BoxNo. : 1 - - 4 5 - - - 0
Greet. & Incoming
▼▲ CLEAR=Delete
```

**7** Press **[CLEAR]**.

- A beep sounds and "Clear" will be displayed.
- To return to the standby mode, press **[EXIT]**.
- The Caller List information will not be erased. To erase the Caller List information, see page 45 or 55.

# Remote Operation from a Touch Tone Phone

You can access the Voice Mail System from any touch tone phone if the Automated Attendant System or the Answering System is on for either line. You can listen to recorded messages in your mailbox and the general delivery mailbox, and you can transfer the messages and deliver your own messages to other mailboxes.

When you access your mailbox, you are required to enter the mailbox password (p. 57).

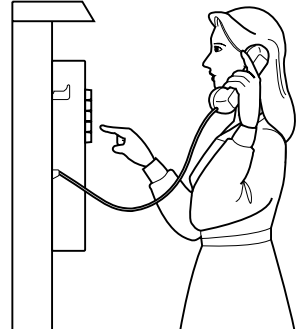

## How to Access the Voice Mail System

Call the line's phone number to which the Automated Attendant System or the Answering System is assigned.



Press **\*** and enter your mailbox password during or after the greeting message.

- Automated voice prompt will not come on until the last digit of the password (p. 57) is entered.
- A beep sounds and then "Mailbox (No.);" or "This is the general delivery mailbox" is heard.



After the number of new messages is announced, new messages will be played. After each message playback, the Message Menu is announced (if the Message Menu mode is on p. 77):

"To repeat this message, press 1. To play the next message, press 2.

To erase this message, press 3. To transfer this message, press 7. (p. 80)"

If required, enter a command.



After playing back all new messages, the Command Menu is announced:

"To play all messages, press 1. (p. 80) To deliver a message, press 2. (p. 80)

To change the personal greeting, press 3. (for personal mailboxes only p. 80)

To change to the general delivery mailbox, press 4. (for personal mailboxes only p. 81) To end this call, press \*."

If required, enter a command.



To end remote operation, press **\*** and hang up.

## Remote Operation from a Touch Tone Phone

---

### During message playback

During playback or before the start of the next message;

To repeat the message, press **1**.

To play the next message, press **2**.

To erase the message, press **3**.

### To transfer a message

After listening to a message, you can transfer it to other mailboxes.

1. During playback or before the start of the next message, press **7**.
2. Enter the destination mailbox numbers using the corresponding dialing buttons (**0**, **1** to **8**). For the general delivery mailbox, enter **0**.
3. Press **#**.

### To listen to all messages

While the Command Menu is announced (p. 79), press **1**.

### To deliver your own message

You can send an identical message of up to 3 minutes, to several mailboxes.

1. While the Command Menu is announced (p. 79), press **2**.
2. Enter the destination mailbox numbers using the corresponding dialing buttons (**0**, **1** to **8**). For the general delivery mailbox, enter **0**.
3. Press **#**.
4. Talk clearly after the tone. To end, press **1**.
5. Press **2**.
6. Press **\*** and hang up.

### To change the personal greeting message (for personal mailboxes only)

You can change the mailbox personal greeting message.

1. While the Command Menu is announced (p. 79), press **3**.
2. Press **1**.
3. Talk clearly after the tone. To end, press **1**.
4. Press **2**.
5. Press **\*** and hang up.



## To switch to the general delivery mailbox from your personal mailbox

After entering your mailbox, you can switch to the general delivery mailbox to listen to messages.

1. While the Command Menu is announced (p. 79), press **[4]**.
  - “This is the general delivery mailbox” is heard.
  - After the number of new messages is announced, new messages will be played.
2. After listening to all new messages;
  - To listen to all messages, press **[1]**.
  - To return to your mailbox, press **[4]**.
  - To end the operation, press **[\*]** and hang up.

### Interrupting remote operation

If a user is accessing a mailbox from a remote location, and you mistakenly answer the call;

1. Press **[✉]**.
2. If you are using the base unit, place the handset or press **[DIGITAL SP-PHONE]**.

If you are using the cordless handset, press **[TALK]**.

The user can then access the mailbox.

### Calling the Answering System to leave a message in the general delivery mailbox without entering the password

Press **[\*]** twice during the greeting message. The unit skips the rest of the message and you can leave your message after the tone.

- The Automated Attendant System and the Answering System cannot be turned on from a remote location.

# Pager Call **Base Unit** **Handset**

This feature allows the unit to alert your pager when your mailbox has received an incoming message from an outside caller. (When a message has been transferred or delivered from another user, the unit will not alert your pager.) You can retrieve the message from a touch tone telephone (p. 79). If you subscribe to a Caller ID service, the caller's telephone number will be displayed on your pager. First store a pager number and the pager display number with the base unit or each cordless handset (p. 82, 83), then set the unit to call the pager. **Programming must be carried out separately for the base unit and cordless handset(s).** **Make sure that the base unit/cordless handset is in the standby mode.**

## Storing a Pager Number

1 Press **FUNCTION**.

2 Press  $\nabla$  or  $\blacktriangle$  until the arrow points to "Pager setting", and press  $\blacktriangleright$ .

3 While "Pager number" is at the arrow, press  $\blacktriangleright$ .

Enter pager No. :

- If the number has already been stored, it will be displayed .

4 Enter your pager number, and press **PAUSE** twice.\* Enter the access code, if required by your pager company, and press **PAUSE** twice again.\*

OR

**If you use a 1-800 pager number with a pager PIN code:**

Enter the 1-800 number, and press **PAUSE** 3 times.\*

Enter the pager PIN code, and press **PAUSE** twice.\*

- If you misdial, press **CLEAR**. Digits are erased from the right. To erase all the digits, press and hold **CLEAR**.
- You can enter a total of 44 digits.

5 Press **ENTER**.

- A beep sounds.
- To return to the standby mode, press **EXIT**.

\*Pager companies require a delay after the pager number and/or the access code is dialed.

For a 1-800 pager number, a delay will be required after the pager number and the pager PIN code are dialed.

Contact your pager company regarding the required pause time. Pressing **PAUSE** once creates a 3.5 second delay and counts as one digit.

- If the line(s) has(have) rotary or pulse service, press **\*** between the pager number and **PAUSE** in step 4.
- If you stored a 1-800 pager number, alphanumeric voice dispatch pager services will not work with this function.



## Storing the Pager Display Number

After storing one of the unit's phone numbers, you can check that pager number is stored correctly. This phone number will be displayed on your pager if the message is received from an area which does not provide a caller ID service or a caller requests not to show his/her information.

- 1 Press **FUNCTION**.
- 2 Press  $\nabla$  or  $\blacktriangle$  until the arrow points to "Pager setting", and press  $\blacktriangleright$ .
- 3 Press  $\nabla$  or  $\blacktriangle$  until the arrow points to "Pager display #", and press  $\blacktriangleright$ .
  - "Enter display #" is displayed.
  - If the number has already been stored, it will be displayed .
- 4 Enter the phone number, up to 11 digits.

Enter display # : 2 2 2 3 3 3 4 4 4 4 ■ ENTER = Save
------------------------------------------------------------

- If you misdial, press **CLEAR**. Digits are erased from the right. To erase all the digits, press and hold **CLEAR**.
- 5 Press **ENTER**.
    - A beep sounds.
    - To return to the standby mode, press **EXIT**.

### To check the stored pager number and pager display number

1. Press **FUNCTION**, and select "Pager setting" by pressing  $\nabla$  or  $\blacktriangle$ , and press  $\blacktriangleright$ .
  2. Select "Calling pager" by pressing  $\nabla$  or  $\blacktriangle$ , and press  $\blacktriangleright$ .
  3. If using the base unit, press **DIGITAL SP-PHONE**.  
OR  
If using the cordless handset, press **TALK**.
    - The pager number is dialed.
    - The pager beeps, and displays the pager display number followed by "11". If not, store the pager number and pager display number again.
- Other users can let you know when they want you to call back, by following the procedure above.

#### \*What "11" means:

When your unit alerts your pager after receiving a message in the mailbox, "11" will be displayed after the caller's telephone number.

## ➔ Pager Call

### To erase the pager number

1. Press **FUNCTION**, and press  $\checkmark$  or  $\wedge$  until the arrow points to “Pager setting”, and press  $\blacktriangleright$ .
2. While “Pager number” is at the arrow, press  $\blacktriangleright$ .
3. Press **CLEAR**.
4. Press **ENTER**.

- The pager call mode will automatically return to OFF (see below).

### To erase the pager display number

1. Press **FUNCTION**, and press  $\checkmark$  or  $\wedge$  until the arrow points to “Pager setting”, and press  $\blacktriangleright$ .
2. Press  $\checkmark$  or  $\wedge$  until the arrow points to “Pager display #”, and press  $\blacktriangleright$ .
3. Press **CLEAR**.
4. Press **ENTER**.

## Setting the Unit to Call a Pager

- 1 Press **FUNCTION**.
- 2 Press  $\checkmark$  or  $\wedge$  until the arrow points to “Pager setting”, and press  $\blacktriangleright$ .
- 3 Press  $\checkmark$  or  $\wedge$  until the arrow points to “Pager on/off”, and press  $\blacktriangleright$ .
  - “Off” (factory preset) is displayed.
- 4 Select “On” by pressing  $\checkmark$  or  $\wedge$ .

Pager on/off $\checkmark$
$\checkmark$ On $\wedge$
$\checkmark$ ENTER = Save $\wedge$

- 5 Press **ENTER**.
  - A beep sounds.
  - To return to the standby mode, press **EXIT**.
  - If using the base unit, “Pager” will be displayed.

To turn off the pager call mode, select “Off” in step 4.

If you have not subscribed to a Caller ID service, the caller’s telephone number will not be displayed on your pager.

- If another message is received before the unit alerts your pager for a previous message, the previous caller information will not be sent to your pager. Only the last call received will be sent to your pager.
- If someone else makes or answers another call with your unit before the unit alerts your pager for a previous message, the unit will stop alerting your pager for that message.
- If you receive a telephone number on your pager but cannot recognize the caller, you may have received a direct inward dial (DID) call, such as from a PBX. Please call your unit to check the caller’s message.

# Using the Handset Belt Clip

You can hang the cordless handset on your belt or pocket using the belt clip.

**To attach the belt clip**

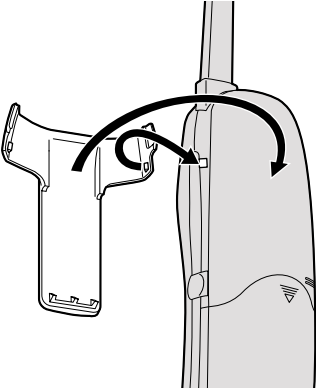

**To remove the belt clip**



# Wall Mounting for the Charger

The charger can be wall mounted.

Install screws using the wall template on the right. Connect the AC adaptor. Mount the charger, then slide it down.

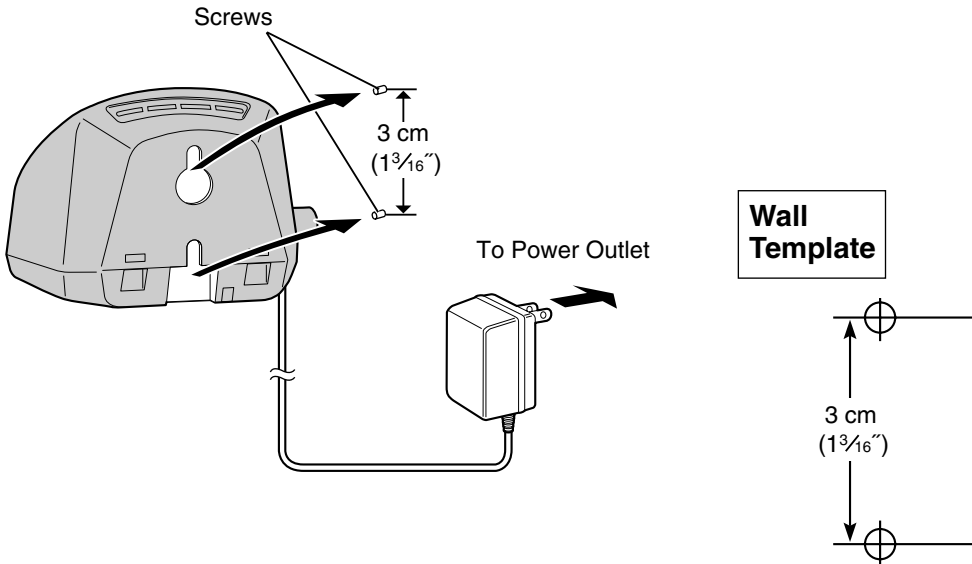

# Using an Optional Headset **Base Unit** **Handset**

Plugging an optional headset into the base unit or cordless handset allows a hands-free phone conversation. Please use only the Panasonic KX-TCA88 headset. To order, call the accessories telephone number on page 3.

## With the Base Unit

### Connecting the headset to the base unit

Connect the headset to the headset jack as shown.

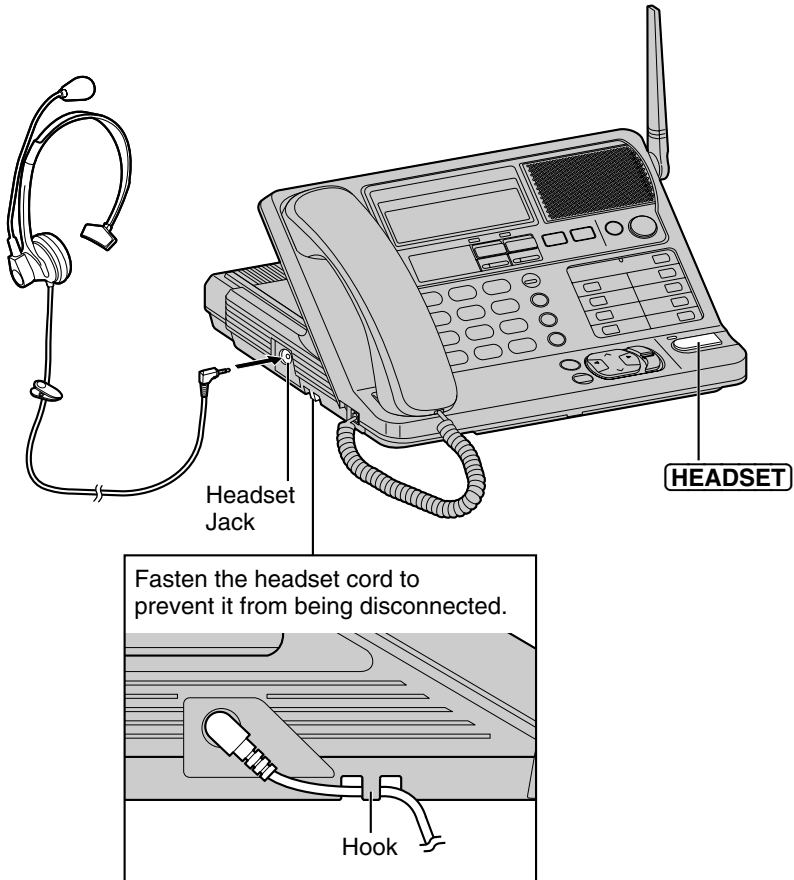



## Making/Answering calls

- 1 Press **HEADSET** to make or answer a call.
  - You can press the line button instead of pressing **HEADSET**.
  - If you misdial when making a call, press **HEADSET** twice and dial again.
- 2 To hang up, press **HEADSET**.

## Intercom

- 1 **To make an intercom call:**
  - To page all handsets, press **INTERCOM ALL**.
  - To page one handset, press the required INTERCOM button (**1** to **8**).
  - To stop paging, press **HEADSET**.

**To answer an intercom call:**  
Press **HEADSET**.
- 2 To end the intercom, press **HEADSET**.

### To adjust the headset volume (High, Medium or Low):

While using the headset, press **▲** or **▼**.

#### To switch to the speakerphone while using the headset:

“ENTER=SP-phone” is displayed. Press **ENTER**.

To return to the headset, press **ENTER** again.

- Each time you press **ENTER**, the call will switch to the headset or speakerphone. While in the speakerphone mode, “ENTER=Headset” is displayed.

- During a conversation using the headset, you can switch the call to the handset by lifting it off the cradle.
- If you disconnect the headset during a conversation, you can continue the conversation with the speakerphone.

## ➔ Using an Optional Headset

---

### With the Cordless Handset

#### Connecting the headset to the cordless handset

Open the headset jack cover, and connect the headset to the headset jack as shown.

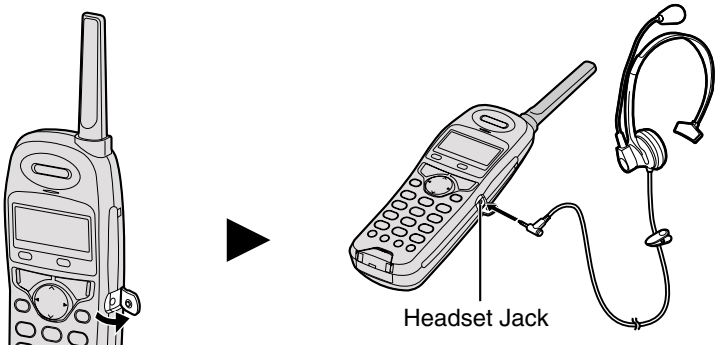

When the headset is connected, make sure to use the headset to talk with the caller. If you want to have a normal cordless phone conversation, disconnect the headset.



# Clearing Settings **Base Unit** **Handset**

## With the base unit

The following settings of the base unit and the registered cordless handsets will return to the factory preset.

Function	Factory preset
Base unit ringer volume	HIGH
Base unit ringer pattern	Pattern 1
Ring group	All extensions ring
Base unit Incoming call tone	OFF
Dialing mode	Tone
Flash time	700 ms
Call restriction	OFF
Base unit line selection	AUTO
Line mode	A mode
General delivery mailbox password	0000
Personal mailbox password	1111-8888 (see page 57)

Function	Factory preset
Direct HS. Access	ON
Call monitoring	ON
Message menu	ON
Recording mode	High quality
Auto message delete	OFF
Pager number	Clear
Pager on/off	OFF
Pager display No.	Clear
PIN for registration	Clear
Auto Attendant System	OFF
Answering System	OFF
Line 1 & 2 greetings	Pre-recorded greeting
Number of rings	Toll Saver
Handset answer mode	OFF

**Make sure that the base unit is in the standby mode.**

- 1 Press **[FUNCTION]**.
- 2 Press  $\blacktriangledown$  or  $\blacktriangle$  until the arrow points to "Initialization", and press  $\blacktriangleright$ .
- 3 While "Function" is at the arrow, press  $\blacktriangleright$ .

- 4 Press **[CLEAR]**.
  - A beep sounds and "Clear" is displayed.
  - To return to the standby mode, press **[EXIT]**.

## With the cordless handset

The following settings of the cordless handset will return to the factory preset.

Function	Factory preset
Ringer volume	HIGH
Ringer pattern	Pattern 1
Incoming call tone	ON
Line selection	AUTO
Auto talk	ON

**Make sure that the cordless handset is in the standby mode.**

- 1 Press **[FUNCTION]**.
- 2 Press  $\blacktriangledown$  or  $\blacktriangle$  until the arrow points to "Initialization", and press  $\blacktriangleright$ .
- 3 While "Function" is at the arrow, press  $\blacktriangleright$ .
- 4 Press **[CLEAR]**.
  - A beep sounds and "Clear" is displayed.
  - To return to the standby mode, press **[EXIT]**.

# Handset Battery Replacement

If “Recharge” is displayed and/or “” flashes after being fully charged, replace the battery with a new Panasonic HHR-P506 (PQHHR150AA21) battery. To order, call the accessories telephone number on page 3.

- 1 Remove the cover by sliding while pressing the arrow.
- 2 Replace the battery, and close the cover.
- 3 Be sure to charge the new battery for about 8 hours in order to display the battery strength prompt correctly (p. 17).

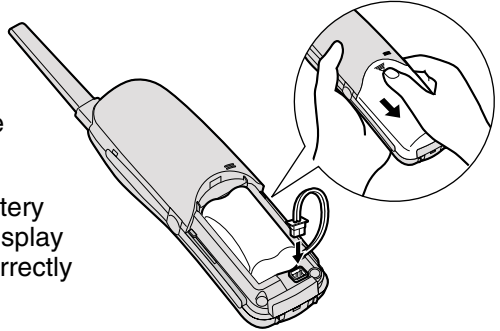

- After replacing the battery or re-connecting the battery plug, be sure to place the handset on the charger until a confirmation tone sounds or the battery strength prompt displays (p. 17).
- The handset battery is a Nickel-Metal Hydride battery. You cannot recycle this battery.

# Backup Battery Replacement

Even if the backup battery has been fully charged, the BATTERY indicator may flash or the unit may not work within minutes after a power failure. In that case, replace the battery with a new Panasonic P-P507 (PQP50AA61) battery. To order, call the accessories telephone number on page 3.

Disconnect the telephone line cord(s), and open the battery cover by pushing down the tab. Replace the battery, close the battery cover and reconnect the telephone line cord(s).

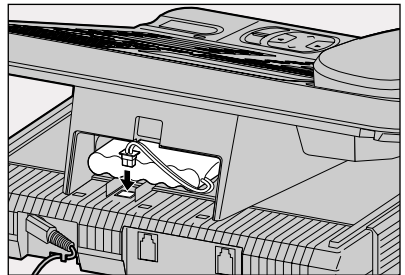

## Attention:

The product you have purchased is powered by a nickel cadmium battery which is recyclable. At the end of its useful life, under various state and local laws, it is illegal to dispose of this battery into your municipal waste stream. Please call 1-800-8-BATTERY for information on how to recycle this battery.



# RESET Button

If the unit does not work, press **RESET** on the bottom of the base unit with a pointed object, such as a pen.

- After pressing **RESET**, the adjusted date/time will be erased. Readjust the date/time (p. 20).

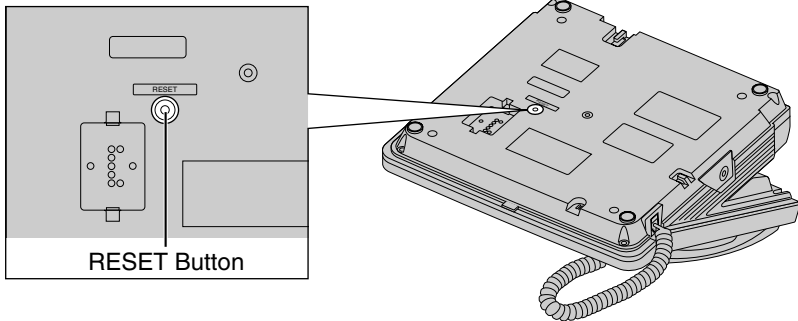

# Adding Another Phone

If the backup battery has been discharged during a power failure, the unit will not work. If required, you can connect a standard telephone on the same line using the Panasonic T-adaptor KX-J66.

To order, call the accessories telephone number on page 3.

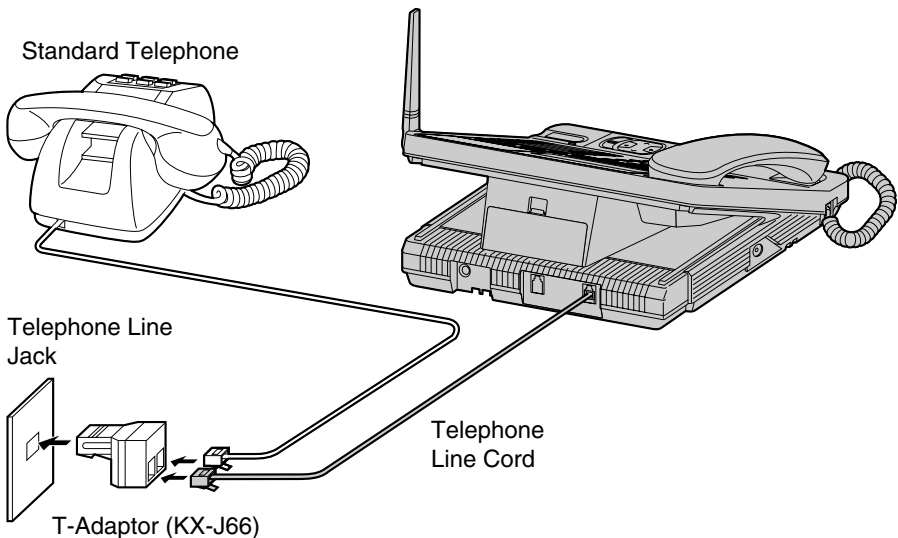

# Error Messages

## Display messages

If the unit detects a problem, one of the following messages will be displayed on the base unit or cordless handset. Error beeps or a busy tone will sound.

Display message	Cause & Remedy
<b>No link to base. Walk closer to base &amp; try again</b> (cordless handset only)	The cordless handset has lost communication with the base unit. Walk closer to the base unit, and try again.
<b>Recharge</b> (cordless handset only)	The handset battery needs to be charged. Recharge the battery by placing it on the charger.
<b>System is busy. Please try again later.</b>	If more than one handset or the base unit and a handset are in use: – you may not be able to program certain function items, such as “Set password” or “Pager on/off”, – you may not be able to make an external or internal call, or – you may not be able to listen to messages in your mailbox. Try again later.
<b>Busy</b>	<ul style="list-style-type: none"><li>• The paged party is engaged in a call.</li><li>• While another user is listening to messages in the general delivery mailbox, you cannot access that mailbox (p. 73).</li><li>• Both lines are in use or a line of the button you pressed is in use. You cannot make a call. Try again later.</li><li>• A paged handset is too far from the base unit.</li></ul>
<b>Invalid</b>	<ul style="list-style-type: none"><li>• A paged handset has not been registered (p. 19, 53).</li><li>• The handset you are canceling has not been registered (for cordless handset only p. 54).</li></ul>
<b>Please lift up and try again</b> (cordless handset only)	▼, ▲, ► or ◀ is pressed while the cordless handset is on the charger. Lift the handset and try again.
<b>Memory is full</b>	When trying to store an item in the directory, the directory memory is full. Erase other items and try again (p. 39).



<b>Display message</b>	<b>Cause &amp; Remedy</b>
<b>Message full</b> (base unit only)	The remaining recording time or the number of messages which can still be recorded is 0. Erase unnecessary messages (p. 70, 73).
<b>Call restriction</b>	The dialed number is restricted. Cancel the restriction (p. 51).
<b>Please set pager number</b>	You tried to check the number or set the unit to call the pager without first storing the pager number (p. 82).
<b>Incorrect PIN. Try again.</b>	You entered a wrong PIN (p. 52, 53). Enter the correct PIN.
<b>No registered handset</b> (base unit only)	The handsets have not been registered to the base unit when you try to cancel the handset registration (p. 54).
<b>Not available. Please deregister HS</b> (cordless handset only)	The handset you are registering has already been registered.
<b>Error!!</b> (cordless handset only)	<ul style="list-style-type: none"><li>•When you tried to register the cordless handset, the handset and base unit could not link for some reason, such as interference from other electrical appliances. Take the handset and base unit away from the electrical appliances and try again.</li><li>•8 handsets have already been registered to the base unit. To cancel another handset registration, see page 54.</li></ul>
<b>Please enter another password</b>	You selected a password which is the same as another mailbox (p. 57). Select another one.
<b>Invalid. Please register to the base unit</b> (cordless handset only)	The handset you tried to make a call or access the mailbox has not been registered to the base unit. Register the handset (p. 19, 53).

## Error Messages

---

### Voice messages

If the unit detects a problem, one of the following messages will be announced.

Voice message	Cause & Remedy
“Sorry, there is no space for recording”	The remaining recording time or the number of messages which can still be recorded is 0. Erase unnecessary messages (p. 70, 73, 80).
“Incorrect entry”	An invalid extension number was entered when transferring or delivering a message. Make sure that the handset is registered to the base unit (p. 19, 53).
“This is your mailbox”	You entered your own mailbox number when transferring or delivering a message (p. 70, 72, 74).
“Sorry, this mailbox is in use”	You tried to access the general delivery mailbox from the handset or access a personal mailbox from the base unit while another user was listening to the messages there (p. 73, 81).
“Sorry, this number is not assigned”	The extension number of the INTERCOM button you pressed is invalid when you tried to access your mailbox from the base unit (p. 73). Make sure that the handset is registered to the base unit (p. 19, 53).

# Before Requesting Help



## With the base unit

Problem	Remedy
The unit does not work.	<ul style="list-style-type: none"><li>• Check the settings (p. 12–17).</li><li>• Press <b>RESET</b> on the bottom of the base unit with a pointed object, such as a pen (p. 91).</li></ul>
The unit does not ring.	<ul style="list-style-type: none"><li>• The ringer volume is set to OFF. Select HIGH or LOW (p. 22).</li><li>• If 2 cordless handsets are in use, the unit may not ring. The handset users will hear incoming call tones.</li><li>• The base unit is removed from the ring group. Add to the ring group (p. 23).</li></ul>
The line indicators do not work properly.	<ul style="list-style-type: none"><li>• Check the settings (p. 12–17).</li><li>• The line mode selection is incorrect (p. 55).</li></ul>
You cannot dial.	<ul style="list-style-type: none"><li>• Check whether the dialing mode selection is correct (p. 21).</li><li>• The dialed number is restricted. To cancel, see page 51.</li></ul>
You cannot program function items, such as the dialing mode.	<ul style="list-style-type: none"><li>• Programming is not possible while the handset is off the cradle or the DIGITAL SP-PHONE indicator lights.</li><li>• Do not pause for over 60 seconds while programming.</li></ul>
You cannot make a call even if there is a free line.	<ul style="list-style-type: none"><li>• If 2 cordless handsets are in use, you may not be able to make a call. Wait until one of the handset in-use icons goes out.</li></ul>
You cannot page a cordless handset.	<ul style="list-style-type: none"><li>• If 4 cordless handsets are in use, you can not page. Wait until one of the handset in-use icons goes out.</li><li>• The handset is too far from the base unit.</li><li>• The handset is in use. Wait until the handset in-use icon goes out.</li></ul>
You cannot store a name and phone number in the directory.	<ul style="list-style-type: none"><li>• You cannot store an item in the directory while the handset is off the cradle or the DIGITAL SP-PHONE indicator lights.</li><li>• Do not pause for over 60 seconds while programming.</li></ul>

## ➔ Before Requesting Help

Problem	Remedy
While programming or searching, the unit starts to ring and stops the program/search.	<ul style="list-style-type: none"><li>• To answer the call, lift the handset, press <b>(DIGITAL SP-PHONE)</b> or the line button whose indicator is flashing quickly. Start again from the beginning after hanging up.</li></ul>
The caller's information is not displayed.	<ul style="list-style-type: none"><li>• The base unit is removed from the ring group. Add to the ring group (p. 23).</li><li>• Other telephone equipment may be interfering with your phone. Disconnect it and try again.</li><li>• Other electrical appliances connected to the same outlet may be interfering with the Caller ID information.</li><li>• Telephone line noise may be affecting the Caller ID information.</li></ul>
The display goes to the standby mode while viewing the Caller List or directory.	<ul style="list-style-type: none"><li>• Do not pause for over 60 seconds while searching.</li></ul>
When a second call is received on the same line, the unit does not display the new caller's information.	<ul style="list-style-type: none"><li>• If another call is received on the same line while;<ul style="list-style-type: none"><li>– the Automated Attendant System or Answering System is responding to a call, or</li><li>– a call is placed on hold,</li></ul>the caller information will not be displayed.</li><li>• The line mode selection is incorrect. See page 55.</li></ul>
You cannot redial the last number dialed.	<ul style="list-style-type: none"><li>• If the last number dialed was more than 32 digits long, the number will not be redialed.</li><li>• Access numbers entered after pressing <b>(TONE)</b> will not be included when redialing.</li></ul>
You cannot have a conversation using the headset.	<ul style="list-style-type: none"><li>• Make sure that the headset is plugged into the headset jack properly (p. 86).</li><li>• If "ENTER=Headset" is displayed, press <b>(ENTER)</b> to switch from the speakerphone to the headset.</li></ul>
The BATTERY indicator light does not go out after the battery has been charged.	<ul style="list-style-type: none"><li>• This is normal.</li></ul>





## With the cordless handset

Problem	Remedy
The unit does not work.	<ul style="list-style-type: none"><li>• Charge the battery fully (p. 16).</li><li>• Clean the charge contacts and charge again (p. 17).</li><li>• Install the battery properly (p. 90).</li><li>• Re-install the battery and place the handset on the charger (p. 90). Try again.</li><li>• The handset has not been registered to the base unit. Register the handset (p. 19, 53).</li></ul>
“No link to base. Walk closer to base & try again” is displayed and an alarm tone sounds.	<ul style="list-style-type: none"><li>• You are too far from the base unit. Walk closer to the base unit and try again.</li><li>• Raise the base unit antenna.</li></ul>
Static, sound cuts in/out, fades. Interference from other electrical units.	<ul style="list-style-type: none"><li>• Locate the cordless handset and the base unit away from other electrical appliances (p. 4).</li><li>• Walk closer to the base unit.</li><li>• Raise the base unit antenna.</li></ul>
The unit does not ring.	<ul style="list-style-type: none"><li>• The ringer volume is set to OFF. Select HIGH or LOW (p. 22).</li><li>• If 2 other handsets or the base unit and another handset are in use, the unit may not ring. The handset and base unit users will hear incoming call tones.</li><li>• The handset is removed from the ring group. Add to the ring group (p. 23).</li></ul>
You cannot dial.	<ul style="list-style-type: none"><li>• The dialed number is restricted. To cancel, see page 51.</li><li>• Key lock mode is set. Cancel the mode by pressing and holding <b>FUNCTION</b>.</li></ul>
The display is blank.	<ul style="list-style-type: none"><li>• Charge the battery fully (p. 16).</li></ul>
You cannot program function items, such as the line selection.	<ul style="list-style-type: none"><li>• Programming is not possible while in the talk or intercom mode, or while listening to messages.</li><li>• Do not pause for over 60 seconds while programming.</li><li>• Make sure that the handset is in the standby mode.</li></ul>

## ➔ Before Requesting Help

---

Problem	Remedy
You cannot make a call even if there is a free line.	<ul style="list-style-type: none"><li>• If 2 other handsets or the base unit and another handset are in use, you may not be able to make a call. Try again later.</li></ul>
You cannot page another cordless handset or the base unit.	<ul style="list-style-type: none"><li>• If 4 other cordless handsets are in use, you may not be able to page. Try again later.</li><li>• The handset is too far from the base unit.</li><li>• The base unit or the handset is in use.</li></ul>
You cannot store a name and phone number in the directory.	<ul style="list-style-type: none"><li>• You cannot store an item in the directory while the unit is in the talk or intercom mode.</li><li>• Do not pause for over 60 seconds while programming.</li></ul>
While programming or searching, the unit starts to ring and stops the program/search.	<ul style="list-style-type: none"><li>• To answer the call, press <b>TALK</b> or the line button whose line status icon is flashing quickly. Start again from the beginning after hanging up.</li></ul>
The caller's information is not displayed.	<ul style="list-style-type: none"><li>• The handset is removed from the ring group. Add to the ring group (p. 23).</li><li>• Other telephone equipment may be interfering with your phone. Disconnect it and try again.</li><li>• Other electrical appliances connected to the same outlet may be interfering with the Caller ID information.</li><li>• Telephone line noise may be affecting the Caller ID information.</li></ul>
The display goes to the standby mode while viewing the Caller List or directory.	<ul style="list-style-type: none"><li>• Do not pause for over 60 seconds while searching.</li></ul>
You cannot register the cordless handset at the base unit.	<ul style="list-style-type: none"><li>• Charge the battery fully (p. 16).</li></ul>







Problem	Remedy
When a second call is received on the same line, the unit does not display the new caller's information.	<ul style="list-style-type: none"><li>• If another call is received on the same line while;<ul style="list-style-type: none"><li>– the Automated Attendant System or Answering System is responding to a call, or</li><li>– a call is placed on hold, the caller information will not be displayed.</li></ul></li><li>• The line mode selection is incorrect. See page 55.</li></ul>
You cannot redial the last number dialed.	<ul style="list-style-type: none"><li>• If the last number dialed was more than 32 digits long, the number will not be redialed.</li><li>• Access numbers entered after pressing <b>(TONE)</b> will not be included when redialing.</li><li>• The <b>(REDIAL)</b> button also functions as the <b>(PAUSE)</b> button. It will redial the last number dialed if pressed at the outset of a call (p. 29). If another number has been dialed first, it will operate as a pause button (p. 46).</li></ul>
You cannot have a conversation using the handset.	<ul style="list-style-type: none"><li>• When the headset is connected (p. 88), you must use the headset to talk with the caller. To have a normal cordless phone conversation, disconnect the headset.</li></ul>
You cannot have a conversation using the headset.	<ul style="list-style-type: none"><li>• Make sure that the headset is plugged into the headset jack properly (p. 88).</li></ul>
"Recharge" is displayed, "■" flashes or the unit beeps intermittently.	<ul style="list-style-type: none"><li>• Charge the battery fully (p. 16).</li></ul>
You charged the battery fully, but "Recharge" is still displayed and/or "■" still continues to flash.	<ul style="list-style-type: none"><li>• Clean the charge contacts and charge again (p. 16, 17).</li><li>• Install a new battery (p. 90).</li></ul>
The CHARGE indicator light does not go out after the battery has been charged.	<ul style="list-style-type: none"><li>• This is normal.</li></ul>

## ➔ Before Requesting Help

---

### Voice Mail System/Automated Attendant System/ Answering System

Problem	Remedy
The Automated Attendant System or Answering System is on, but incoming messages are not recorded.	<ul style="list-style-type: none"><li>• The remaining recording time or the number of messages which can still be recorded is 0. Erase unnecessary messages (p. 70, 73).</li></ul>
“Message full” flashes on the base unit display, and no new messages are recorded.	<ul style="list-style-type: none"><li>• The remaining recording time or the number of messages which can still be recorded is 0. Erase unnecessary messages (p. 70, 73).</li></ul>
You cannot access your mailbox by pressing  .	<ul style="list-style-type: none"><li>• Make sure that the base unit/cordless handset is in the standby mode.</li><li>• If 2 cordless handsets or the base unit and a handset are in use, you may not be able to access the mailbox. Try again later.</li><li>• If the Automated Attendant System or Answering System is responding to 2 calls on separate lines, you cannot access the mailbox. Try again later.</li><li>• You are too far from the base unit. Walk closer to the base unit.</li><li>• If “Enter mailbox password” is displayed, the direct handset access mode is OFF (p. 57). Enter the mailbox password and press .</li></ul>
You cannot access a mailbox from a touch tone phone.	<ul style="list-style-type: none"><li>• Make sure you press  and enter the correct password.</li><li>• The Automated Attendant System or Answering System may not respond if the tones are too short to activate the unit. Press each button firmly.</li></ul>
While recording a greeting message, the unit starts to ring and stops recording.	<ul style="list-style-type: none"><li>• To answer the call, press the called line button. The recording will stop. Start from the beginning after hanging up.</li></ul>

Problem	Remedy
During playback, incoming call tones are heard.	<ul style="list-style-type: none"> <li>• To answer the call, press the called line button. To resume playback, press  after hanging up.</li> </ul>
The display does not show the name and/or number of the caller whose message is being played.	<ul style="list-style-type: none"> <li>• If the caller is not stored in the caller list, the caller's information will not be displayed.</li> </ul>
The unit does not alert your pager.	<ul style="list-style-type: none"> <li>• The line mode selection is incorrect. See page 55.</li> </ul>

- If you cannot solve your problem, call our customer call center at 1-800-211-PANA(7262).
- Panasonic's e-mail address for customer inquiries: [consumerproducts@panasonic.com](mailto:consumerproducts@panasonic.com) for customers in the USA or Puerto Rico ONLY

# Important Safety Instructions

---

When using this unit, basic safety precautions should always be followed to reduce the risk of fire, electric shock, or personal injury.

1. Read and understand all instructions.
2. Follow all warnings and instructions marked on this unit.
3. Unplug this unit from AC outlets before cleaning. Do not use liquid or aerosol cleaners. Use a damp cloth for cleaning.
4. Do not use this unit near water, for example, near a bathtub, washbowl, kitchen sink, or the like.
5. Place this unit securely on a stable surface. Serious damage and/or injury may result if the unit falls.
6. Do not cover slots and openings on the unit. They are provided for ventilation and protection against overheating. Never place the unit near radiators, or in a place where proper ventilation is not provided.
7. Use only the power source marked on the unit. If you are not sure of the type of power supplied to your home, consult your dealer or local power company.
8. Do not place objects on the power cord. Install the unit where no one can step or trip on the cord.
9. Do not overload wall outlets and extension cords. This can result in the risk of fire or electric shock.
10. Never push any objects through slots in this unit. This may result in the risk of fire or electric shock. Never spill any liquid on the unit.
11. To reduce the risk of electric shock, do not disassemble this unit. Take the unit to an authorized servicer when service is required. Opening or removing covers may expose you to dangerous voltages or other risks. Incorrect reassembly can cause electric shock when the unit is subsequently used.
12. Unplug this unit from the wall outlet and refer servicing to an authorized servicer when the following conditions occur:
  - A. When the power supply cord or plug is damaged or frayed.
  - B. If liquid has been spilled into the unit.
  - C. If the unit has been exposed to rain or water.
  - D. If the unit does not work normally by following the operating instructions. Adjust only controls covered by the operating instructions. Improper adjustment may require extensive work by an authorized servicer.
  - E. If the unit has been dropped or physically damaged.
  - F. If the unit exhibits a distinct change in performance.
13. During thunderstorms, avoid using telephones except cordless types. There may be a remote risk of an electric shock from lightning.
14. Do not use this unit to report a gas leak, when in the vicinity of the leak.

## SAVE THESE INSTRUCTIONS

---

**CAUTION:**

To reduce the risk of fire or injury to persons, read and follow these instructions.

1. Use only the battery(ies) specified.
2. Do not dispose of the battery(ies) in a fire. They may explode. Check with local waste management codes for special disposal instructions.
3. Do not open or mutilate the battery(ies). Released electrolyte is corrosive and may cause burns or injury to the eyes or skin. The electrolyte may be toxic if swallowed.
4. Exercise care in handling batteries in order not to short the battery to conductive materials such as rings, bracelets, and keys. The battery and/or conductor may overheat and cause burns.
5. Charge the battery(ies) provided with or identified for use with this product only in accordance with the instructions and limitations specified in this manual.

**WARNING:**

TO PREVENT FIRE OR SHOCK HAZARD, DO NOT EXPOSE THIS PRODUCT TO RAIN OR ANY TYPE OF MOISTURE.

# FCC and Other Information

---

If requested by the telephone company, inform them as follows:

FCC Registration No. ....(found on the bottom of the unit)

Ringer Equivalence .....0.2B

The particular telephone lines to which the equipment is connected.

This unit must not be connected to a coin operated line.

If you are on a party line, check with your local telephone company.

## **Ringer Equivalence No. (REN):**

The REN is useful in determining the quantity of devices you may connect to your telephone line and still have all of those devices ring when your telephone number is called. In most, but not all areas, the sum of the REN's of all devices connected to one line should not exceed five (5.0). To be certain of the number of devices you may connect to your line, as determined by the REN, you should contact your local telephone company to determine the maximum REN for your calling area.

In the event terminal equipment causes harm to the telephone network, the telephone company should notify the customer, if possible, that service may be stopped.

However, where prior notice is impractical, the company may temporarily cease service providing that they:

- (a) Promptly notify the customer.
- (b) Give the customer an opportunity to correct the problem with their equipment.
- (c) Inform the customer of the right to bring a complaint to the Federal Communication Commission pursuant to procedures set out in FCC Rules and Regulations Subpart E of Part 68.

The Telephone Company may make changes in its communications facilities, equipment, operations or procedures, where such action is reasonably required in the operation of its business and is not inconsistent with the rules and regulations in FCC Part 68.

If such changes can be reasonably expected to render any customer terminal equipment incompatible with telephone company communications facilities, or require modification or alteration of such terminal equipment, or otherwise materially affect its use or performance, the customer shall be given adequate notice in writing, to allow the customer an opportunity to maintain uninterrupted service.

When programming emergency numbers and/or making test calls to emergency numbers:

1. Remain on the line and briefly explain to the dispatcher the reason for the call before hanging up.
2. Perform such activities in the off-peak hours, such as early morning hours or late evenings.

This device complies with Part 15 of the FCC Rules. Operation is subject to the following two conditions: (1) This device may not cause harmful interference, and (2) this device must accept any interference received, including interference that may cause undesired operation.



---

Privacy of communications may not be ensured when using this phone.

**CAUTION:**

Any changes or modifications not expressly approved by the party responsible for compliance could void the user's authority to operate this device.

**Note:**

This equipment has been tested and found to comply with the limits for a Class B digital device, pursuant to Part 15 of the FCC Rules. These limits are designed to provide reasonable protection against harmful interference in a residential installation. This equipment generates, uses, and can radiate radio frequency energy and, if not installed and used in accordance with the instructions, may cause harmful interference to radio communications. However, there is no guarantee that interference will not occur in a particular installation. If this equipment does cause harmful interference to radio or television reception, which can be determined by turning the equipment off and on, the user is encouraged to try to correct the interference by one or more of the following measures:

- Reorient or relocate the receiving antenna.
- Increase the separation between the equipment and receiver.
- Connect the equipment into an outlet on a circuit different from that to which the receiver is connected.
- Consult the dealer or an experienced radio/TV technician for help.

Some cordless telephones operate at frequencies that may cause interference to nearby TVs and VCRs. To minimize or prevent such interference, the base of the cordless telephone should not be placed near or on top of a TV or VCR. If interference is experienced, move the cordless telephone further away from the TV or VCR. This will often reduce or eliminate interference.

Operating near 2.4GHz electrical appliances may cause interference. Move away from the electrical appliances.

- **Environment** — do not place the unit in a room where the temperature is less than 5°C (41°F) or greater than 40°C (104°F). Allow 10 cm (4") clearance around the unit for proper ventilation. Avoid excessive smoke, dust, mechanical vibration, shock, or direct sunlight.
- **Medical** — consult the manufacturer of any personal medical devices, such as pacemakers, to determine if they are adequately shielded from external RF (radio frequency) energy. (The unit operates in the frequency range of 2401MHz to 2480MHz, and the power output level can range from 0.04 watts to 0.40 watts.) Do not use the unit in health care facilities if any regulations posted in the area instruct you not to do so. Hospitals or health care facilities may be using equipment that could be sensitive to external RF (radio frequency) energy.
- **Routine care** — wipe the unit with a soft cloth. Do not use benzine, thinner, or any abrasive powder. When you leave the unit unused for a long period of time, unplug the AC adaptor from the outlet.
- **If there is any trouble** — disconnect the unit from the telephone line and connect a known working phone. If the known working phone operates properly, have your unit repaired by one of the authorized Panasonic Factory Service Centers. If the known working phone does not operate properly, consult your telephone company.

# Index

---

## A

- Access to General Delivery Mailbox .....56, 57, 79
- Access to personal mailbox ...56, 57, 79
- Accessories .....3
- Answering calls .....30
- Auto answering mode .....65
- Auto talk .....30, 48
- Automated Attendant setting .....59
- Automated Attendant System .....58

## B

- Backlit LCD .....11
- Base location .....4
- BaseRcvOff .....23
- Battery life .....17
- Battery replacement .....90
- Battery, Handset .....4, 16
- Battery strength, Handset .....17

## C

- Call on hold .....28, 29, 31
- Call restriction .....50
- Call restriction, cancelation .....51
- Call transfer .....34, 63, 64
- Call waiting caller ID .....46
- Call waiting tone .....46
- Caller ID display .....40, 69, 72
- Caller ID service .....20, 30, 40
- Caller ID, edit .....43
- Caller List, erasing .....45, 55
- Caller List, storing .....44
- Caller List, viewing .....41, 42
- Calling back from Caller ID List .....42, 69, 72
- Calling extensions .....58, 63, 64
- Calling operator .....58, 64
- Command menu .....69, 71
- Conference call .....35
- Cordless handset extension .....58

## D

- Date and time .....20
- Delivering voice messages .....74
- Deregistration .....54
- Dialing mode .....21
- Directory .....36
- Directory, dialing .....38
- Directory, editing .....39

- Directory, erasing .....55
- Directory, name and symbols .....37
- Directory, searching .....38
- Displays on LCD .....11

## E

- Erasing a voice mail message .....70, 73
- Erasing all voice mail messages .....78
- Error messages .....92
- Error messages, display .....92
- Error messages, voice .....94
- Extension number, Base .....32
- Extension number, Handset...19, 32, 53

## F

- Factory preset function setting .....89
- FCC and other information .....104
- FLASH button .....47
- Flash time .....47
- Function Menu, Selection .....18
- Function Menu, Table .....24

## G

- Greeting message .....59, 60, 61, 65
- Greeting, Auto answering..... 65, 66, 67
- Greeting, Automated Attendant .....58, 59, 60, 62
- Greeting, Handset answer setting .....61, 62, 63

## H

- Handset belt clip .....85
- Headset, optional .....86, 88
- Hold alarm .....28, 29
- Hold time .....28, 29

## I

- Incoming call monitoring .....75
- Incoming call tone .....31, 51, 33
- Initialization .....89
- Installation .....12
- Installation, AC adaptor .....13
- Installation, adding another phone .....91
- Installation, Backup battery .....12
- Installation, Charger .....16, 85
- Installation, Corded handset .....13
- Installation, Telephone line cords ...14, 15
- Intercom call .....32
- Intercom paging .....32, 33

<b>K</b>		<b>S</b>	
Key lock.....	47	Safety Instructions.....	102
<b>L</b>		Setting, Ringer volume.....	22
Line mode.....	55	Shipping product for service	
Line selection.....	49	.....Back cover	
Listening to voice mail messages		System capability.....	25
.....	68, 71, 73	<b>T</b>	
Location of buttons.....	8, 9, 10	Toll saver.....	65
LR, Long recording mode.....	75	Transferring a voice mail message	
<b>M</b>		.....	70, 72
Mailbox password.....	57	Troubleshooting, Help line.....	101
Making Calls.....	26	Troubleshooting, System.....	100
Making Calls, Base SP-phone.....	26, 27	Troubleshooting, Base unit.....	95
Memory card.....	9	Troubleshooting, Cordless handset.....	97
Message delete, Automatic.....	77	<b>V</b>	
Message Menu.....	68, 71, 77	Voice Mail.....	56
Message storage time.....	69	Voice mail transfer.....	34, 76
<b>N</b>		Voice Mail, General Mailbox.....	56, 65
Noise.....	4	Voice Mail, Personal mailbox.....	56
<b>P</b>		Volume control, Headset.....	87
Pager call.....	82	Volume control, Cordless handset.....	29
Pager call mode, setting.....	84	Volume control, Base SP-phone.....	27, 69
Pager display number.....	83	Volume control, Corded handset.....	27
Pager number.....	82		
PAUSE.....	46		
PIN number.....	52		
Pulse service.....	46		
<b>R</b>			
Recording time.....	75		
Recording time, remaining.....	76		
Recording time, voice mail.....	56		
Redial.....	27, 29		
Redial list, erasing.....	55		
Registration, Optional Handset.....	19, 53		
Remote access.....	77, 79		
Remote access operation.....	79, 80, 81		
RESET button.....	91		
Ring Group.....	23		
Ringer Off.....	22, 23, 30, 33		
Ringer pattern.....	48		
Rotary service.....	46, 58		
Rotary service, tone dialing.....	46		

## For product service

- Call 1-800-211-PANA(7262) for the location of an authorized servicenter.
- Panasonic's e-mail address for customer inquiries:  
consumerproducts@panasonic.com  
for customers in the USA or Puerto Rico ONLY

## When you ship the product

- Carefully pack your unit, preferably in the original carton.
- Attach a letter, detailing the symptom, to the outside of the carton.

Symptom

---

- Send the unit to an authorized servicenter, prepaid and adequately insured.
- Do not send your unit to the Panasonic Consumer Electronics Company listed below or to executive or regional sales offices. These locations do not repair consumer products.

- This cordless telephone is designed for use in the United States of America. Sale or use of this product in other countries may violate local laws.
- Ce téléphone sans fil est conçu pour être utilisé aux États-Unis d'Amérique. La vente ou l'emploi de cet appareil dans certains autres pays peut constituer une infraction à la législation locale.
- Este teléfono sin cordón fue elaborado para uso en los Estados Unidos de América. La venta o el empleo de este producto en ciertos países puede constituir violación de la legislación local.
- このコードレス電話機は、日本国外での使用を目的として設計されており、日本国内での使用は法律違反となります。従って、当社では日本国内においては原則として修理などのサービスは致しかねます。

**Panasonic Consumer Electronics Company,**  
**Division of Matsushita Electric Corporation of America**  
One Panasonic Way, Secaucus, New Jersey 07094

**Panasonic Sales Company,**  
**Division of Matsushita Electric of Puerto Rico, Inc.**  
Ave. 65 de Infantería, Km. 9.5, San Gabriel Industrial Park  
Carolina, Puerto Rico 00985