

Panasonic

2.4GHz Digital Cordless Answering system

Model No. **KX-TG2227S**

Pulse-or-tone dialing capability

Operating Instructions



Preparation

Cordless Telephone

Answering System

Useful Information

PLEASE READ BEFORE USE AND SAVE.

Charge the battery for about 15 hours before initial use.

Panasonic World Wide Web address: <http://www.panasonic.com>
for customers in the USA or Puerto Rico

Before Initial Use

Please read IMPORTANT SAFETY INSTRUCTIONS on page 52 before use. Read and understand all instructions.

Thank you for purchasing your new Panasonic cordless telephone.

Attach your purchase receipt here.

For your future reference

Serial No. _____
(found on the bottom of the unit)

Date of purchase _____

Name and address of dealer _____

Accessories (included) For extra orders, call 1-800-332-5368.

- AC Adaptor (p. 9)
Order No. PQLV1Z

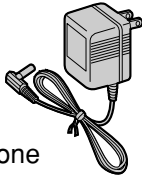

one

- Telephone Line Cord
(p. 9)
Order No. PQJA10075Z

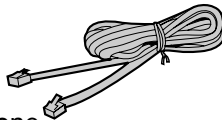

one

- Battery (p. 10, 45)
Order No.
PQPP511SVC
(P-P511)

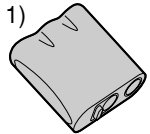

one

- Handset Cover
(p. 10, 45)
Order No.
PQKK10127Z1



one

- Wall Mounting Adaptor
(p. 42)
Order No.
PQKL10035Z3

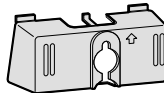

one

- Belt Clip (p. 44)
Order No.
PQKE10341Z1

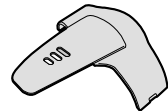

one

For Best Performance

Battery Charge

A rechargeable Ni-Cd battery powers the handset. Charge the battery for about **15 hours** before initial use (p. 10).

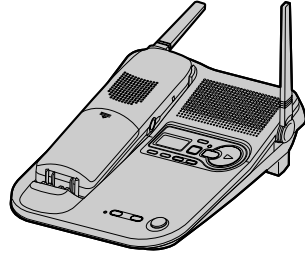

Base Unit Location/Noise

Calls are transmitted between the base unit and the handset using wireless radio waves. **For maximum distance and noise-free operation**, the recommended base unit location is:

Away from electrical appliances such as a TV, personal computer or another cordless phone.

In a HIGH and CENTRAL location with no obstructions such as walls.

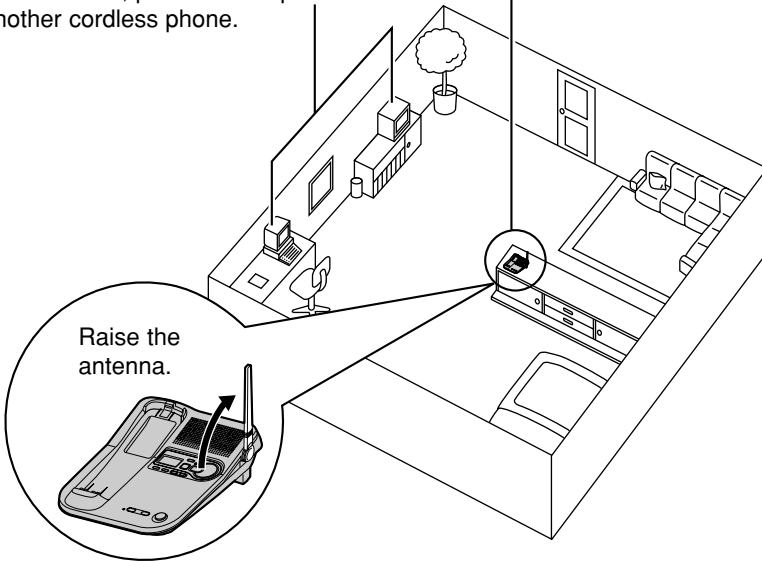

Note:

While using the handset:

- If you are near a microwave oven which is being used, noise may be heard from the receiver or the speaker. Move away from the microwave oven and closer to the base unit.
- If more than one cordless phone is being used and your handset is near another cordless phone's base unit, noise may be heard. Move away from the other cordless phone's base unit and closer to your base unit.

Contents

Preparation

Location of Controls	6
Display	8
Settings	9
Connections	9
Installing the Battery in the Handset	10
Battery Charge	10
Dialing Mode	12
Line Mode	13
Ringer Volume	14
Ringer Pattern	14
Preparing the Answering System	15
Greeting Message	15
Programming Summary for Answering System	17
Day and Time	18
Caller's Recording Time	19
Number of Rings	20

Cordless Telephone

Making Calls	21
Answering Calls	23
Speed Dialer	24
Storing Phone Numbers	24
Dialing a Stored Number	24
Intercom	25
Special Features	26
Automatic Security Code Setting	26
Temporary Tone Dialing (For Rotary or Pulse Service Users)	26
Muting Your Conversation	26
For Call Waiting Service Users	26
How to Use the PAUSE Button (For Analog PBX Line/Long Distance Service Users)	27
FLASH Button	27

Answering System

Automatic Answering Operation	28
Setting the Unit to Answer Calls	28
Listening to Messages	29
Slow Talk Message Playback	29
From the Handset	31
Erasing Messages	32
Recording a Memo Message	33
Recording Your Telephone Conversation	33
Remote Operation from a Touch Tone Phone	34
Remote Code	35
Voice Menu	36
Direct Remote Operation	38
Remote Operation with the Handset	40

Useful Information

Wall Mounting	42
Belt Clip	44
Optional Headset	44
Battery Replacement	45
Adding Another Phone	46
Troubleshooting	47
Important Safety Instructions	52
FCC and Other Information	54
Index	57

Location of Controls

Handset

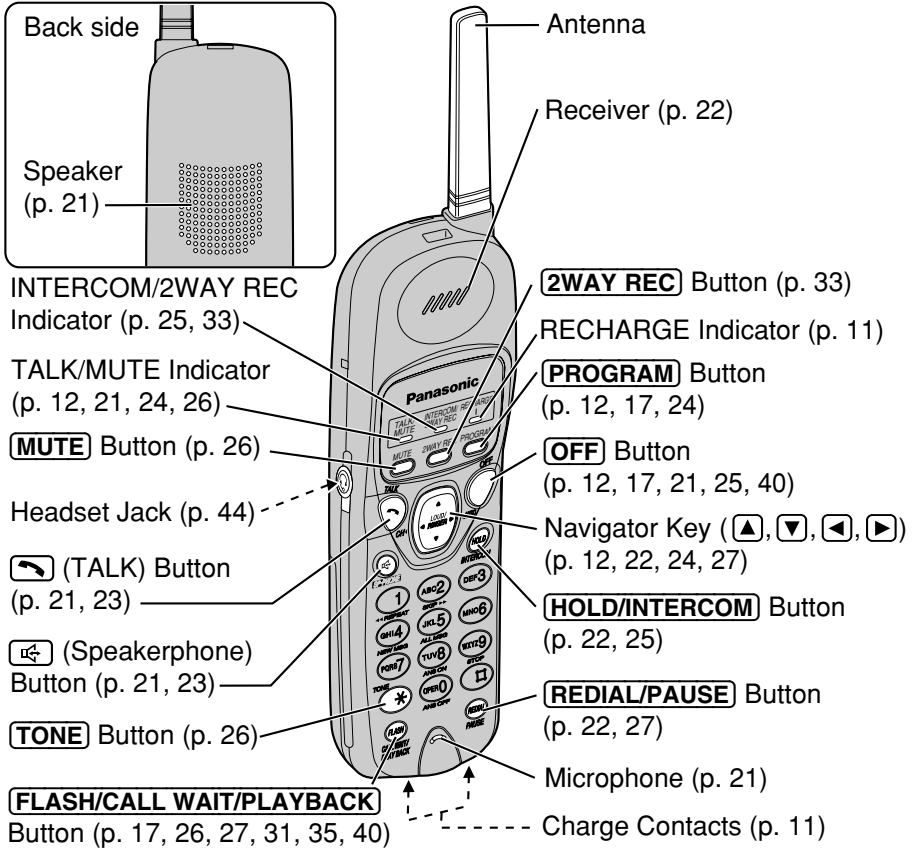

How to use the Navigator key

This key has four active areas that are indicated by arrows.

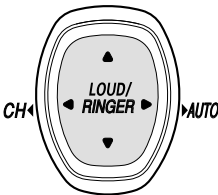

- Pressing the up or down arrow allows you to adjust the handset ringer and receiver/speaker volumes.
- Pressing the right or left arrow allows you to adjust the handset ringer pattern.
 - The right arrow is used to set the dialing mode, the speed dialer or the flash time.
 - The left arrow is used to select a clearer channel.

Throughout this Operating Instructions, the navigator key is indicated by the arrows ▼, ▲, ◀ or ▶.

Base unit

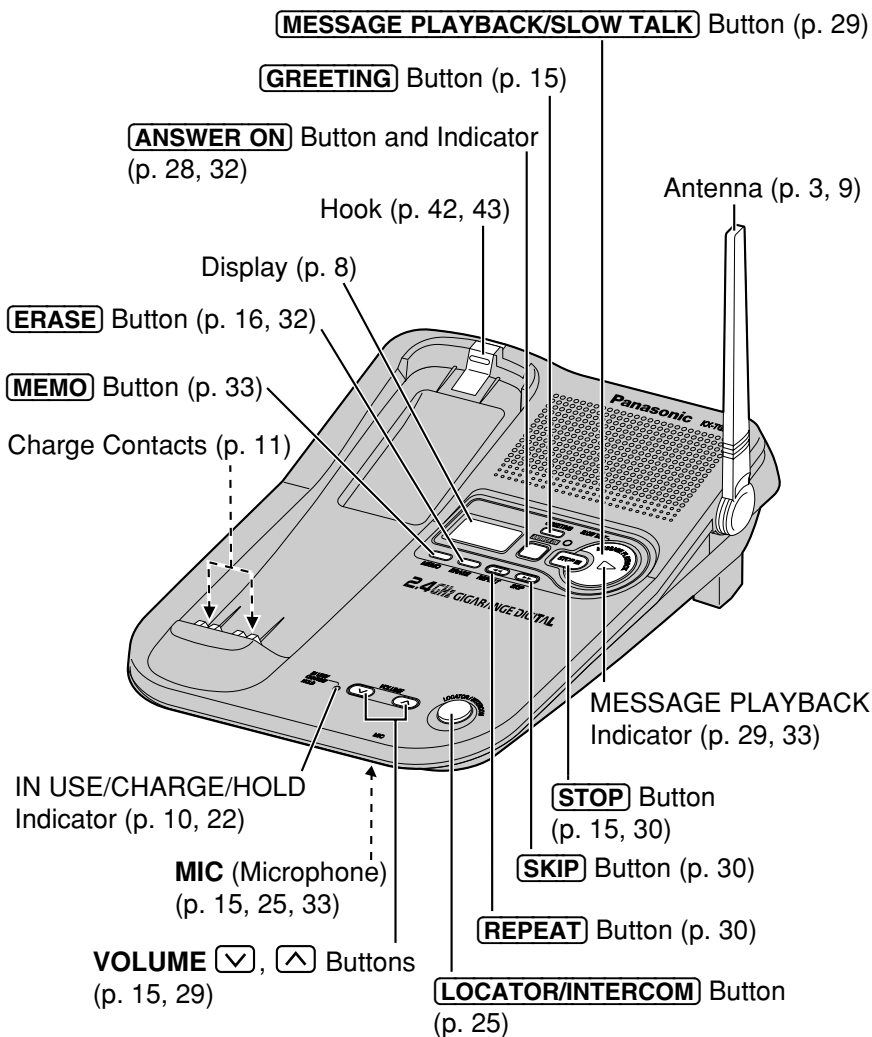

Display

Base unit display



The clock needs adjusting (p. 18).

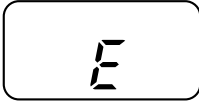

Your greeting or memo message was not recorded correctly. Record it again (p. 15, 33).

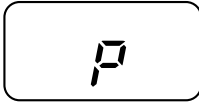

The unit is in the answering system programming mode.

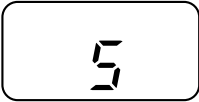

The speaker volume level is set to "5".

You can select:

—9 levels (0–8) are available while using the answering system (p. 15, 29).

—8 levels (1–8) are available while using the intercom (p. 25).

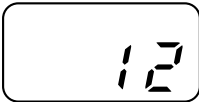

12 messages have been recorded.



Memory is full. Erase some, or all, of the messages (p. 32).



The recording time is set to "Greeting only" (p. 19). (The display is blank.)

Settings



Connections

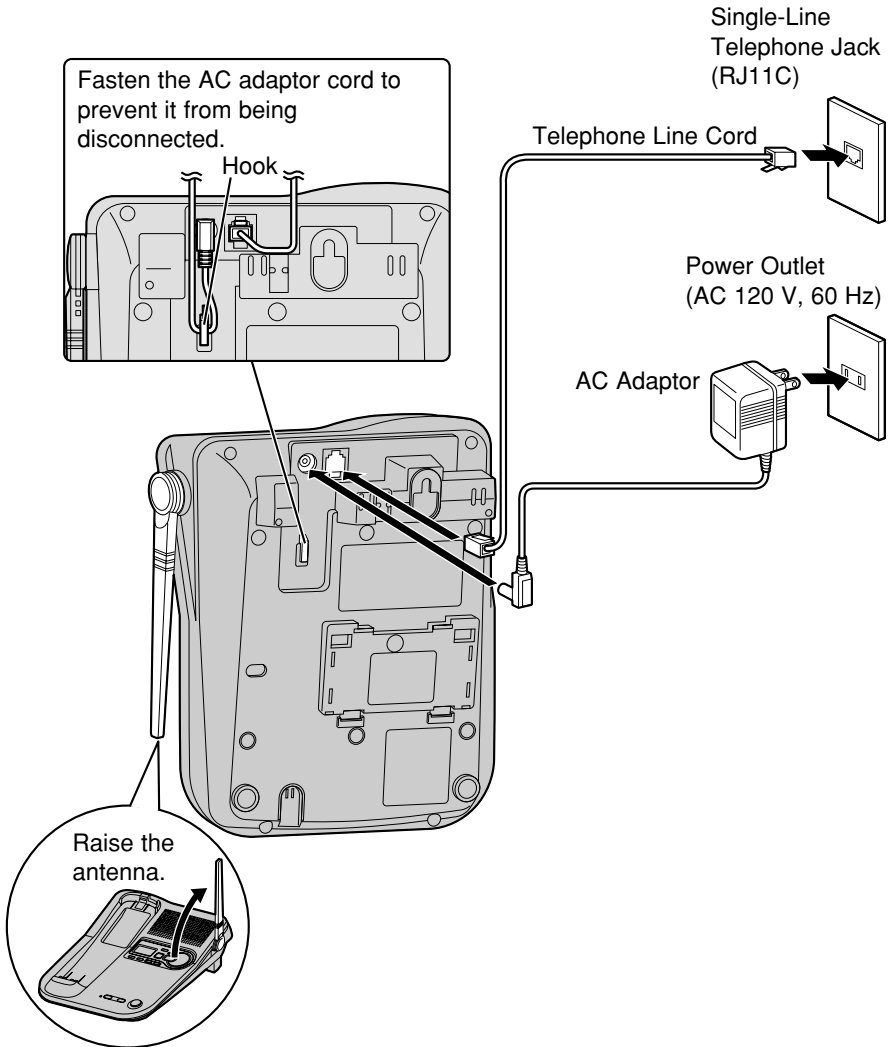

- USE ONLY WITH Panasonic AC ADAPTOR PQLV1 (Order No. PQLV1Z).
- The AC adaptor must remain connected at all times. (It is normal for the adaptor to feel warm during use.)
- To connect a standard telephone on the same line, see page 46.

➡ Settings

Installing the Battery in the Handset

Insert the battery into the handset as shown (①), matching the correct polarity. Press the battery down until it places into the compartment (②). When finished, close the cover.

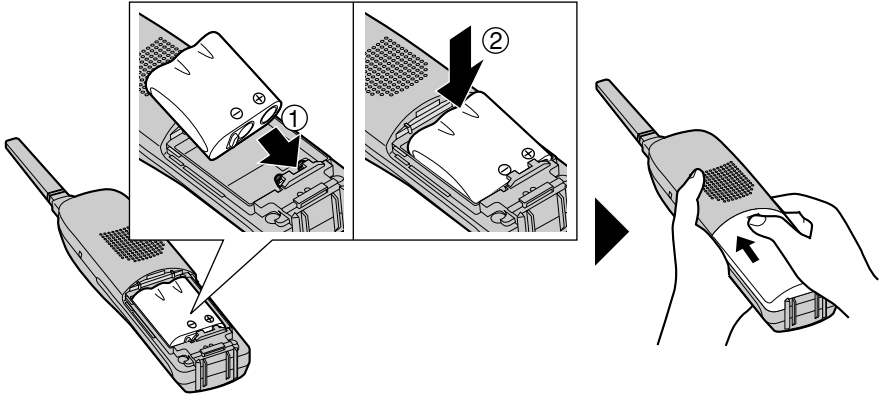

Battery Charge

Place the handset on the base unit and charge for about **15 hours** before initial use.

- The IN USE/CHARGE/HOLD indicator lights and a beep sounds.

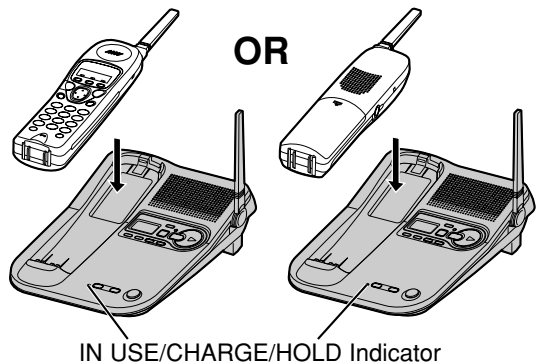



Recharge

When the RECHARGE indicator flashes or the unit beeps intermittently while it is use, place the handset on the base unit to recharge the battery for 15 hours.

- If you DO NOT recharge the handset battery for more than 15 minutes, the RECHARGE indicator will continue to flash.

RECHARGE
Indicator

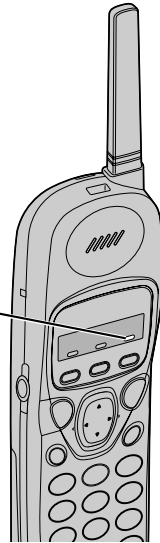

Battery information

After your Panasonic battery is fully charged (p. 10):

Operation	Operating time
While in use (TALK)	Up to 5 hours
While not in use (Standby)	Up to 11 days

- The battery operating time may be shortened depending on usage conditions and ambient temperature.
- Clean the handset and the base unit charge contacts with a soft, dry cloth once a month. Clean more often if the unit is subject to grease, dust or high humidity.** Otherwise the battery may not charge properly.
- If the battery is fully charged, you do not have to place the handset on the base unit until the RECHARGE indicator flashes. This will maximize the battery life.
- The battery cannot be overcharged.

➔ Settings

Dialing Mode

You can program the dialing mode using the handset near the base unit. If you have touch tone service, set to TONE. If rotary or pulse service is used, set to PULSE. Your phone comes from the factory set to TONE.

Make sure the unit is not being used and the handset is lifted off the base unit.

- 1 Press **PROGRAM**.
 - The TALK/MUTE indicator flashes.
- 2 Press **▶**.
- 3 To select PULSE, press **#** **twice**.
OR
To select TONE, press ***** **twice**.
- 4 Press **PROGRAM**.
 - A beep sounds.

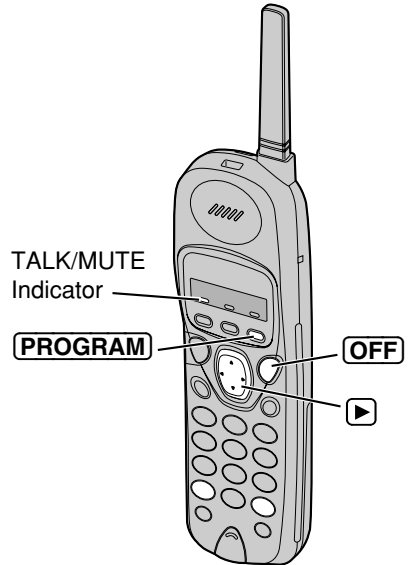

- You can exit the programming mode anytime by pressing **OFF**.
- If 3 beeps sound during programming,
 - a wrong key was pressed. Start again from step 1.
 - the handset is too far from the base unit. Move closer to the base unit or place the handset on the base unit. Start again from step 1.
- If you do not press any buttons for 60 seconds, the unit will exit the programming mode.



Line Mode

If the line is connected to a low voltage system such as a PBX, set to “B”. Your phone comes from the factory set to “A”.

Make sure the unit is not being used and the handset is lifted off the base unit.

- 1 Press **PROGRAM**.
 - The TALK/MUTE indicator flashes.

- 2 Press **FLASH/CALL WAIT/PLAYBACK**.
 - “P” is displayed on the base unit.

- 3 Press **3**.
 - The current setting is displayed on the base unit.

- 4 To select “A”, press **1**.
OR
To select “B”, press **2**.
 - The setting is displayed on the base unit.

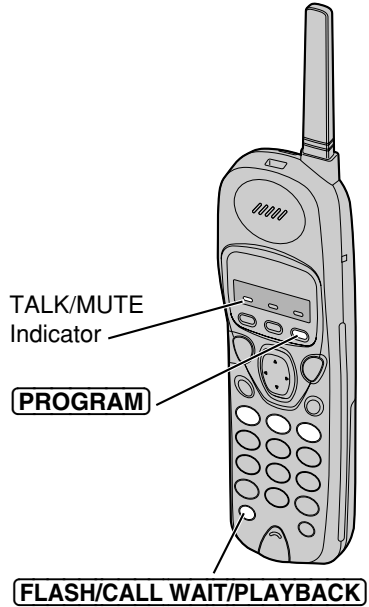

- 5 Press **PROGRAM**.
 - A beep sounds.







Ringer Volume

You can program the handset ringer volume to HIGH, LOW or OFF. If set to OFF, the handset will not ring. Your phone comes from the factory set to HIGH.

Make sure the unit is not being used and the handset is lifted off the base unit.

- To select **HIGH (preset) or LOW**, press  or .





Each time you press the button, the ringer volume will change and the selected volume will ring.

- To turn the ringer **OFF**, press and hold  until 2 beeps sound.
- To turn the ringer **ON**, press  or . The ringer will sound at the LOW level by pressing  or at the HIGH level by pressing .

Ringer Pattern

You can select the handset ringer pattern out of 6 patterns. When an incoming call is being received, the unit rings in the selected pattern.

Make sure the unit is not being used and the handset is lifted off the base unit.

- 1 Press  or .
 - The unit rings at the current setting.
 - If you set the ringer volume to OFF, the unit will not ring.
- 2 Within 5 seconds, select the desired ringer pattern by pressing  or .
 - Each time you press the button, the ringer pattern will change and ring.

Preparing the Answering System →

Greeting Message

You can record a personal greeting message of **up to 2 minutes**. If a greeting message is not recorded, one of two pre-recorded greetings will be played when a call is received (p. 16).

All messages (greeting, incoming, memo, etc.) are stored in digital memory (p. 16). The **total recording time is about 15 minutes**. We recommend you record a **brief greeting message** (see sample below) in order to leave more time for recording new messages.

To record a greeting message

- 1 Press and hold **[GREETING]** until “Record greeting after the beep” is heard.
 - A long beep sounds.
- 2 Talk clearly, about 8 inches (20 cm) away from the **MIC** (microphone).
 - The base unit display shows the elapsed recording time.
 - If you record for over 2 minutes, the unit will automatically stop recording.
- 3 When finished, press **[GREETING]**.
 - The unit will automatically play back the recorded greeting.
 - You can also finish a recording by pressing **[STOP]**.
 - To change the message, start again from step 1.

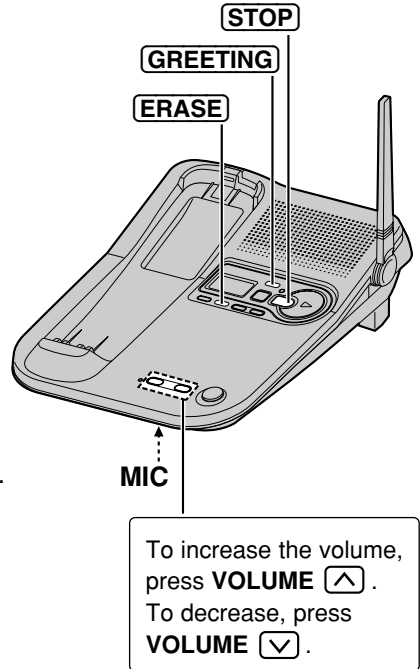

Greeting message sample

“Hello, this is (your name and/or number). Sorry I cannot take your call. Please leave a message after the beep. Thank you.”

➡ Preparing the Answering System

To check the recorded greeting message

Press **[GREETING]**.

To erase the recorded greeting message

Press **[GREETING]** → Press **[ERASE]** while the message is being played.

- The unit will answer a call with a pre-recorded greeting.

Pre-recorded greeting message

If you do not record a greeting message (p. 15), one of two messages will be played when a call is received, depending on the caller's recording time (p. 19).

To check the pre-recorded greeting, press **[GREETING].**

- A pre-recorded greeting will be played as follows:

- When the recording time is set to "1 minute", "2 minutes" or "3 minutes":
"Hello, we are not available now. Please leave your name and phone number after the beep. We will return your call."
- When the recording time is set to "Greeting only":
"Hello, we are not available now. Please call again. Thank you for your call."

Flash Memory Message Backup

Messages are stored on a "flash memory" IC chip and will not be affected by power failures. All messages are saved until you erase them.



Programming Summary for Answering System

You can program the following functions **using the handset near the base unit**. See the corresponding pages for function details.

Make sure the unit is not being used and the handset is lifted off the base unit.

Press **PROGRAM**.



Press **FLASH/CALL WAIT/PLAYBACK**.



- If an alarm tone sounds, move closer to the base unit and try again.

To adjust **the day and time**, press **0**. (page 18)

To set **the remote code**, press **1**. (page 35)

To select **the number of rings**, press **2**. (page 20)

To select **the line mode**, press **3**. (page 13)

To select **the caller's recording time**, press **5**. (page 19)

- The base unit display shows numbers or characters related to the adjustment or settings.



Press **PROGRAM**.

- A beep sounds from the base unit.

- You can exit the programming mode any time by pressing **OFF**.
- If you do not press any buttons for 60 seconds, the unit will exit the programming mode.

➡ Preparing the Answering System

Day and Time

Voice Day/Time Stamp: During playback, a synthesized voice will announce the day and time that each message was recorded.

Make sure the unit is not being used and the handset is lifted off the base unit.

- 1 Press **PROGRAM**.
 - The TALK/MUTE indicator flashes.
- 2 Press **FLASH/CALL WAIT/PLAYBACK**.
 - “P” is displayed on the base unit.
- 3 Press **0**.
 - “Set time” is announced from the base unit. If previously adjusted, the day/time will be heard.
- 4 Enter the current time (hour and minute) using a 4-digit number. (Ex. To set 9:30, enter “0930”).
 - The 2 digits of the entered number is displayed.
- 5 Press ***** to select “AM” or “PM”. Press **#** repeatedly to set the day.
- 6 Press **PROGRAM**.
 - The base unit announces the day/time. The clock starts working.
 - If 6 beeps sounds from the base unit, the setting is not correct. Start again from the beginning.

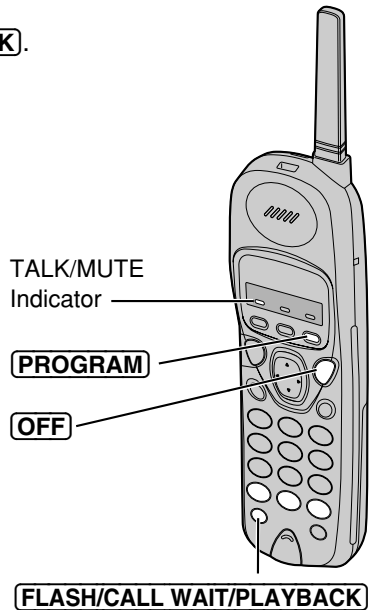

- You can exit the programming mode any time by pressing **OFF**.
- In step 4, you cannot enter numbers greater than 12. **Do not use military time.** (To set 13:00 hours, enter “0100” and select “PM” by pressing *****.)

If a power failure occurs, the time may be shifted. When “⌚” flashes on the base unit display, reprogram the current day/time.

To check the day/time

Press **PROGRAM** → **FLASH/CALL WAIT/PLAYBACK** → **0**.

- The base unit announces the current day/time. When finished, press **OFF**.



Caller's Recording Time

You can select "1 minute", "2 minutes", "3 minutes" or "Greeting only" for the caller's recording time. Your phone comes from the factory set to "3 minutes".

Make sure the unit is not being used and the handset is lifted off the base unit.

- 1 Press **PROGRAM**.
 - The TALK/MUTE indicator flashes.
- 2 Press **FLASH/CALL WAIT/PLAYBACK**.
 - "P" is displayed on the base unit.
- 3 Press **5**.
 - The current setting is displayed on the base unit.
 - 1: 1 minute
 - 2: 2 minutes
 - 3: 3 minutes
 - Blank: Greeting only
- 4 Press **1**, **2**, **3** or **0** to select the recording time.
 - The setting is displayed on the base unit.
 - 1: 1 minute
 - 2: 2 minutes
 - 3: 3 minutes
 - 0: Greeting only
- 5 Press **PROGRAM**.
 - A beep sounds from the base unit.

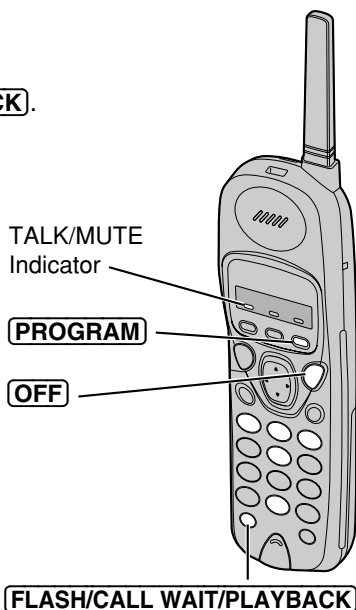

- You can exit the programming mode any time by pressing **OFF**.

If you select "Greeting only", the unit will answer a call with the greeting message, and then hang up. The unit will not record any incoming messages.

➔ Preparing the Answering System

Number of Rings

You can select the number of times the unit rings before the answering system answers a call, from “2” to “7” or “AUTO” (for Toll saver*).

Your phone comes from the factory set to “4”.

Make sure the unit is not being used and the handset is lifted off the base unit.

1 Press **PROGRAM**.
•The TALK/MUTE indicator flashes.

2 Press **FLASH/CALL WAIT/PLAYBACK**.
•“P” is displayed on the base unit.

3 Press **2**.
•The current setting is displayed on the base unit.

4 Press **0**, or **2** to **7** to set the number of rings.
0: Selects “AUTO”.
“A” is displayed.
2–7: The unit will answer after the selected number of rings.

5 Press **PROGRAM**.
•A beep sounds from the base unit.

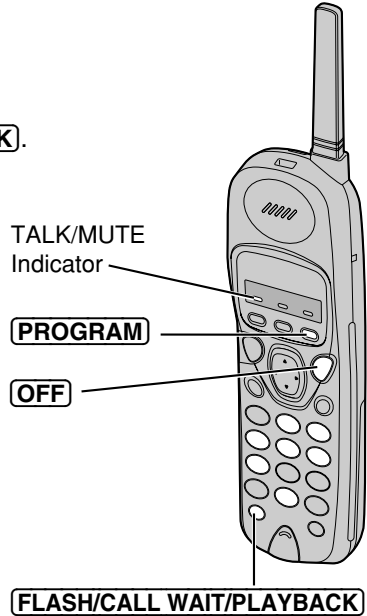

•You can exit the programming mode any time by pressing **OFF**.

***Toll saver (When set to “AUTO”)**

If the unit answers on the 2nd ring, there is at least one new message.
If the unit answers on the 4th ring, there are no new messages.

Hang up when you hear the 3rd ring. This will save you the toll charge for the call.

Making Calls



- 1 Press .
 - The TALK/MUTE indicator lights.
- 2 Dial a phone number.
- 3 To hang up, press **OFF** or place the handset on the base unit.
 - The indicator light goes out.

•If an alarm tone sounds in step 1, move closer to the base unit or place the handset on the base unit and try again.

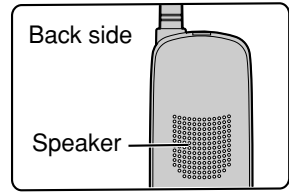

To have a hands-free phone conversation (Using Digital Duplex Speakerphone)

- 1 Press .
 - The TALK/MUTE indicator lights.
- 2 Dial a phone number.
- 3 When the other party answers, talk into the microphone.
- 4 To hang up, press **OFF** or place the handset on the base unit.
 - The indicator light goes out.

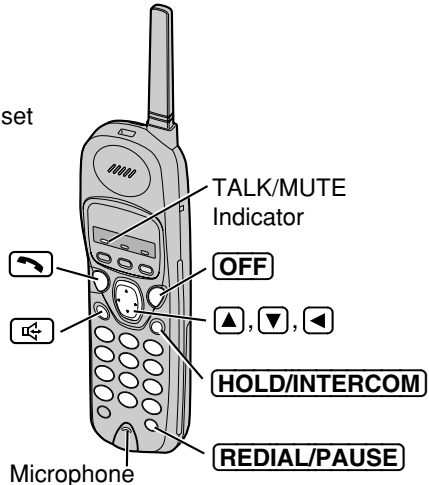

Hands-free Digital Duplex Speakerphone

For best performance, please note the following:



- Talk alternately with the caller in a quiet room.
- If the other party has difficulty hearing you, press to decrease the speaker volume.
- If the other party's voice from the speaker cuts in/out during a conversation, press to decrease the speaker volume.
- While talking using , you can switch to the hands-free phone conversation by pressing . To switch back to the receiver, press .

➡ Making Calls



If noise interferes with the conversation

Press  to select a clearer channel in the talk, intercom or remote operation mode, or move closer to the base unit.



To redial the last number dialed on the handset

Press  or  and press **REDIAL/PAUSE**.



To adjust the receiver volume (HIGH, MEDIUM or LOW) or speaker volume (6 levels) while talking

To increase, press . To decrease, press .

While using

- Each time you press  or , the volume level will change among 3 levels (HIGH, MEDIUM or LOW).
Your phone comes from the factory set to level MEDIUM.

While using



- Each time you press  or , the volume level will change among 6 levels.
Your phone comes from the factory set to level 3.
- When you replace the battery, the selected receiver/speaker volume setting will return to the factory set. Reprogram if necessary.

To put a call on hold

Press **HOLD/INTERCOM**.

- The TALK/MUTE indicator and the IN USE/CHARGE/HOLD indicator flash.
- If you put a call on hold for more than 6 minutes, an alarm tone will sound. The call will be disconnected after a total of 10 minutes.

To release the hold

Lift the handset, or press  or .

- If another phone is connected on the same line (p. 46), you can also release the hold by lifting its handset.

Lighted handset keypad

The handset dialing buttons will light when you press a button or lift the handset off the base unit. They flash when a call is received with the handset off the base unit.

The lights will go out a few seconds after pressing a button, lifting the handset, answering a call, hanging up a call, leaving the programming mode or ending the intercom.

Answering Calls

When a call is received, the unit rings and the IN USE/CHARGE/HOLD indicator on the base unit flashes quickly.

1 If the handset is off the base unit;
Press .

- You can also answer a call by pressing any dialing button **0** to **9**, ***** or **#** (—Any Key Talk).

OR

Press , and when the other party answers, talk into the microphone.

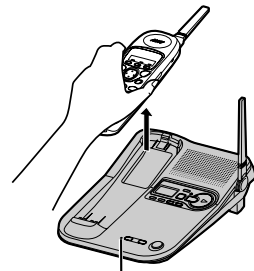
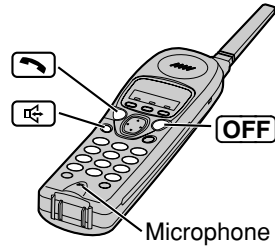

OR

If the handset is on the base unit, just lift up.



2 To hang up, press **OFF** or place the handset on the base unit.

IN USE/CHARGE/HOLD Indicator

- You can select the ringer volume while a call is being received. Press  or  while the handset is just ringing. To set to OFF, press and hold .
- When the handset ringer volume is set to OFF, the unit will not ring (p. 14).

Speed Dialer

Storing Phone Numbers

You can store up to 10 phone numbers in the handset. The dialing buttons (0) to (9) function as memory stations.

Make sure the unit is not being used and the handset is lifted off the base unit.

- 1 Press **PROGRAM**.
 - The TALK/MUTE indicator flashes.
- 2 Enter a phone number up to 22 digits.
 - If you misdial, press **OFF** to end storing and start again from step 1.
- 3 Press **▶**.
- 4 Press a memory station number (0) to (9).
 - A beep sounds.
 - To store other numbers, repeat steps 1 through 4.

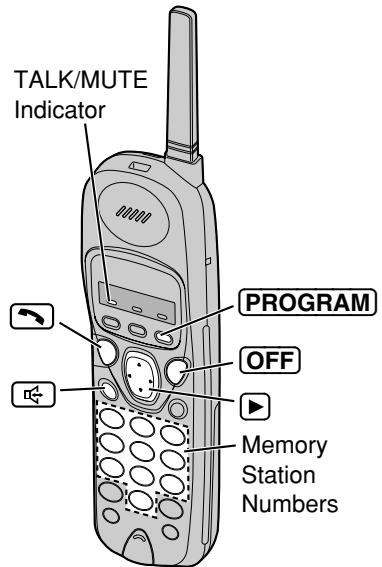

•If a pause is required for dialing, press **REDIAL/PAUSE** where needed. Pressing **REDIAL/PAUSE** counts as one digit (p. 27).

To erase a stored number

Press **PROGRAM** → **▶** → the memory station number (0) to (9) for the phone number to be erased.

Dialing a Stored Number

- 1 Press **☎** or **☎**.
- 2 Press **▶**.
- 3 Press the memory station number (0) to (9).

Intercom

A 2-way intercom is possible between the handset and the base unit.

Paging the base unit from the handset

1 Handset:
Press **HOLD/INTERCOM**.
Talk to the paged party after the beeps.

- The INTERCOM/2WAY REC indicator lights.

2 Base unit:
When the other party's voice is heard, answer using the **MIC**.

3 To end the intercom, press **OFF** on the handset.
OR

Press **LOCATOR/INTERCOM** on the base unit.

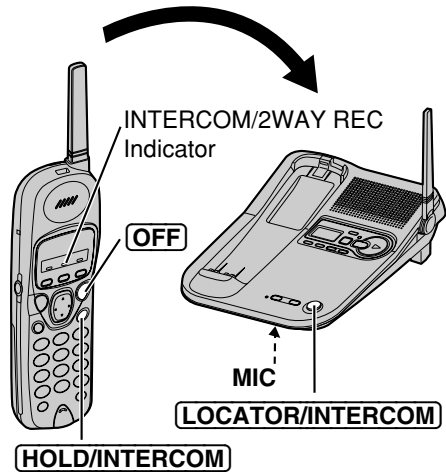

Paging the handset from the base unit (Handset locator)

Using this feature, you can also locate a misplaced handset.

1 Base unit:
Press **LOCATOR/INTERCOM**.

- The handset beeps for 1 minute.
- To stop paging, press **LOCATOR/INTERCOM** again.

2 Handset:
Press **HOLD/INTERCOM** to answer.

3 Base unit:
Talk into the **MIC**.

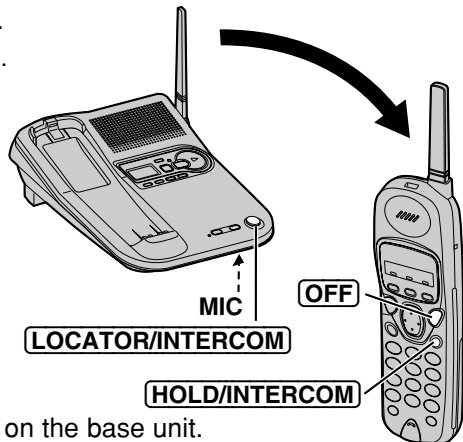

4 To end the intercom, press **OFF** on the handset.
OR

Press **LOCATOR/INTERCOM** on the base unit.



•If you do not want to answer the page in step 2, press **OFF** to stop beeping.

During an intercom call:

- If the handset user has difficulty hearing the base unit user, decrease the base unit speaker volume by pressing **VOLUME** .
- If an incoming call is received, the intercom call stops and the unit starts to ring. To answer, press , .

Special Features

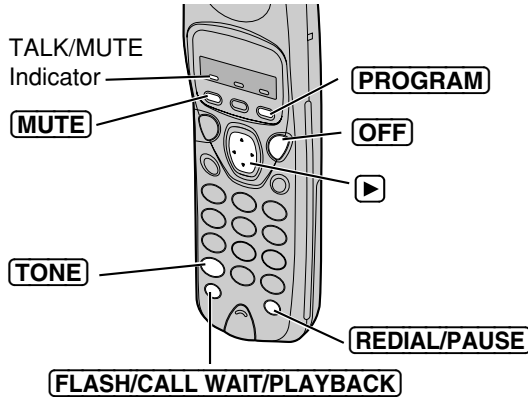

Automatic Security Code Setting

Each time you place the handset on the base unit, the unit automatically selects one of more than a million security codes. These codes help prevent the unauthorized use of your telephone line by another cordless telephone user.

Temporary Tone Dialing (For Rotary or Pulse Service Users)

Press **TONE** before entering access numbers which require tone dialing.

- The dialing mode changes to tone. You can enter numbers to access an answering service, electronic banking service, etc. When you hang up, the mode will return to pulse.

Muting Your Conversation

Press **MUTE** while talking.

- The TALK/MUTE indicator flashes.
- The other party cannot hear your voice but you can hear theirs.

To release the mute, press **MUTE**,  or .

For Call Waiting Service Users

Press **FLASH/CALL WAIT/PLAYBACK** if you hear a call-waiting tone while talking.

- The first call is put on hold and you can answer the second call.
- To return to the first caller, press **FLASH/CALL WAIT/PLAYBACK** again.
- The call waiting service cannot be used when:
 - the answering system is recording someone's message, or
 - a parallel connected telephone is in use.
- If this function does not operate properly, consult your telephone company for details.

How to Use the PAUSE Button (For Analog PBX Line/Long Distance Service Users)

We recommend you press **[REDIAL/PAUSE]** if a pause is required for dialing with a PBX or to access a long distance service.

Ex. Line access number **[9]** (PBX)

[9] → **[REDIAL/PAUSE]** →

- Pressing **[REDIAL/PAUSE]** once creates a 3.5 second pause. This prevents misdialing when you redial or dial a stored number.
- Pressing **[REDIAL/PAUSE]** more than once increases the length of the pause between numbers.

FLASH Button

Pressing **[FLASH/CALL WAIT/PLAYBACK]** allows you to use special features of your host PBX such as transferring an extension call or accessing special telephone services (optional) such as call waiting.

- Pressing **[FLASH/CALL WAIT/PLAYBACK]** causes to release following operations:
 - temporary tone dialing,
 - muting your conversation, or
 - recording your conversation.

Selecting the flash time

The flash time depends on your telephone exchange or host PBX. You can select the following flash times: “700, 600, 400, 300, 250, 110, 100 or 90 ms (milliseconds)”. Your phone comes from the factory set to “700 ms”.

Make sure the unit is not being used and the handset is lifted off the base unit.

1. Press **[PROGRAM]**.
 - The TALK/MUTE indicator flashes.
2. Press a dialing button (**[1]** to **[8]**).

[1] : 90 ms	[2] : 100 ms	[3] : 110 ms	[4] : 250 ms
[5] : 300 ms	[6] : 400 ms	[7] : 600 ms	[8] : 700 ms
3. Press **[▶]**.
4. Press **[FLASH/CALL WAIT/PLAYBACK]**.
 - A beep sounds.

- You can exit the programming mode any time by pressing **[OFF]**.
- If the unit is connected via a PBX, PBX functions (transferring a call etc.) might not work correctly. Consult your PBX supplier for the correct setting.

Automatic Answering Operation

When the unit answers a call, a greeting message is played and the caller's message is recorded.

- The total recording time (including greeting message) is **about 15 minutes**. If messages are recorded in noisy rooms, the time may be shortened by up to 3 minutes.
- A maximum of 64 messages (including greeting message) can be recorded.

Setting the Unit to Answer Calls

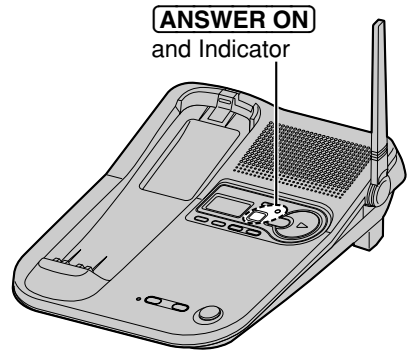

Press **ANSWER ON** to turn on the answering system.

- The indicator lights and "Answer set" is heard.
- The unit will announce the remaining recording time if it is less than 5 minutes.
- If you hear "Memory full", "**FULL**" is displayed on the base unit and the ANSWER ON indicator flashes rapidly, erase some, or all, of the messages (p. 32).



- If you do not want the unit to answer calls, press **ANSWER ON** again to turn off the answering system. The indicator light goes out and "Answer off" is heard.
- You can also turn on the answering system remotely using any other phone (p. 39).

Monitoring incoming calls

While a call is being recorded, you can monitor it through the speaker. To answer the call, press  or . The unit stops recording.

Listening to Messages



You can see the total number of recorded messages on the base unit display. If MESSAGE PLAYBACK indicator flashes, new message have been recorded.

To play back messages, press **MESSAGE PLAYBACK/SLOW TALK**.

When you have new messages: the unit announces the number of new messages and only new messages are played back.

When you have no new messages: the unit announces “No new messages. All messages playback” and plays back all messages.

When you have no messages: the unit announces “No messages”.

At the end of the last message, “End of final message” is heard. The unit will announce the remaining recording time if it is less than 5 minutes.

MESSAGE PLAYBACK/SLOW TALK

MESSAGE PLAYBACK Indicator

During playback, the display shows the message number.

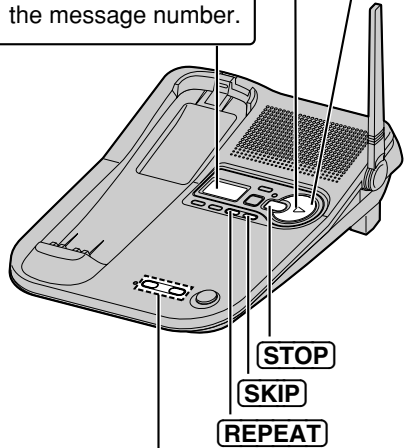

STOP

SKIP

REPEAT

To increase the volume, press **VOLUME** .
To decrease, press **VOLUME** .

Slow Talk Message Playback

For easier listening of recorded messages, you can slow down the playback speed by pressing **MESSAGE PLAYBACK/SLOW TALK** during playback. Each time you press the button, the playback speed will change to slow/normal.

Press **MESSAGE PLAYBACK/SLOW TALK** during playback.

- The playback speed will slow down by 30%.
- To return to the normal speed, press **MESSAGE PLAYBACK/SLOW TALK** again during playback.
- The playback speed will return to normal after playing back all messages.

➡ Listening to Messages

During playback

To repeat message	Press REPEAT . <ul style="list-style-type: none">•If you press within 5 seconds of playback, the previous message will be played.
To skip message	Press SKIP .
To stop operation	Press STOP . <ul style="list-style-type: none">•To resume playback, press MESSAGE PLAYBACK/SLOW TALK.•If you do not press any button for 60 seconds or if you press STOP again, the playback mode will be canceled.

From the Handset

If someone else is in the room and you want to listen to the recorded messages privately, you can use the handset.

- 1 Handset:
Press **FLASH/CALL WAIT/PLAYBACK**.

- The number of new messages is heard on the handset.

- 2 Base unit:
To listen to messages:
Press
MESSAGE PLAYBACK/SLOW TALK.

When you have new messages:

the unit announces the number of new messages and only new messages are played back.

When you have no new messages:

the unit announces
“No new messages. All message playback” and plays back all messages.

When you have no messages:

the unit announces “No messages”.

- The messages will be heard on the handset.
- MESSAGE PLAYBACK/SLOW TALK**, **REPEAT**, **SKIP** and **STOP*** can also be used during playback (p. 30).

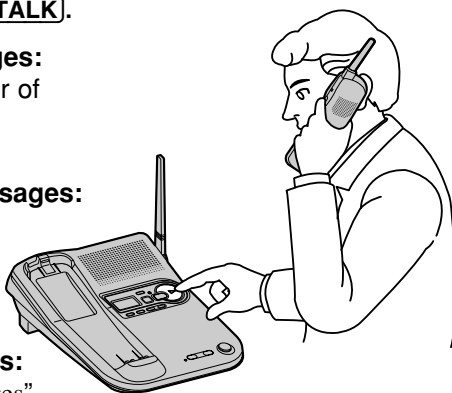

- 3 When finished, press **FLASH/CALL WAIT/PLAYBACK** or place the handset on the base unit.

- You can also listen to messages without using the base unit. See page 40.

*When you press **STOP** during playback, operation is stopped.

To resume the playback, press **MESSAGE PLAYBACK/SLOW TALK** within 15 seconds, or the voice menu will start (p. 40).

Erasing Messages

The unit will announce the remaining recording time after playback, if it is less than 5 minutes. New messages cannot be recorded when:

- “Memory full” is heard.
- “**FULL**” is displayed on the base unit.
- the **ANSWER ON** indicator flashes rapidly.

Erase some, or all, of the messages. We recommend you erase unnecessary messages after each playback.

Erasing a specific message

Press **ERASE** while the message you want to erase is being played.

- The unit erases the message.
- A short beep will sound and the unit will continue to play the next message.

Erasing all messages

All recorded messages, except the greeting message, can be erased at one time.

- 1 Press **ERASE**.
 - “To erase all messages, press ERASE again” is heard.
- 2 Within 5 seconds, press **ERASE** again.
 - A long beep sounds and “No messages” is heard.
 - The base unit display shows “0”.

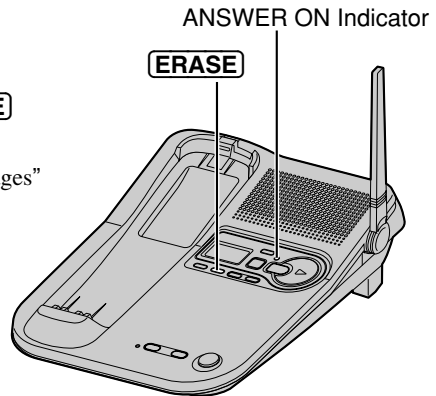

Recording a Memo Message

You may record a personal message in memory.

- 1 Press **MEMO**.
 - A long beep sounds.
- 2 After the beep, talk clearly approximately 8 inches (20 cm) away from the **MIC**.
 - The base unit display shows the elapsed recording time.
- 3 When finished, press **MEMO** or **STOP**.
 - A beep sounds.
 - The MESSAGE PLAYBACK indicator flashes.

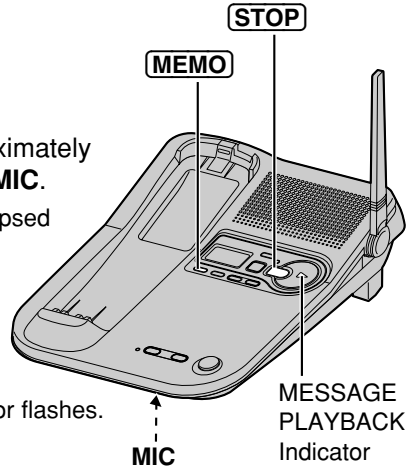

Recording Your Telephone Conversation

- 1 During a conversation with the handset, press **2WAY REC**.
 - The INTERCOM/2WAY REC indicator flashes.
 - The base unit shows the elapsed recording time.
- 2 Continue your conversation.
- 3 When finished recording the conversation, press **2WAY REC**.
 - The MESSAGE PLAYBACK indicator flashes.

INTERCOM/2WAY REC Indicator



Many states have imposed regulations on the manner in which 2-way telephone conversations may be recorded, so you should inform the other party that the conversation is being recorded. Consult your local telephone company for further information.

Remote Operation from a Touch Tone Phone

You can operate the answering system from any touch tone phone. A synthesized voice menu will guide you on how to operate the unit (p. 36).

- To skip the voice menu and operate the unit directly, see page 38.



Summary of remote operation

Call your unit from a touch tone phone.



Enter your remote code (p. 35) during or after the greeting message.
•The number of new messages is heard.



After 3 seconds, the voice menu will start (p. 36).
Follow the menu or enter the direct commands (p. 38).



To end remote operation, hang up.
•The messages are saved.

- The unit will announce the remaining recording time after playback, if it is less than 5 minutes.



Remote Code

The remote code prevents unauthorized people from accessing your unit and listening to your messages. Choose any **2-digit number (00–99)**. The factory preset remote code is “11”. If you do not program your own remote code, you can use “11”.

Make sure the unit is not being used and the handset is lifted off the base unit.

- 1 Press **PROGRAM**.
 - The TALK/MUTE indicator flashes.
- 2 Press **FLASH/CALL WAIT/PLAYBACK**.
 - “P” is displayed on the base unit.
- 3 Press **1**.
 - The current remote code is displayed on the base unit.
- 4 Enter a remote code using a **2-digit number (00–99)**.
 - The entered number is displayed on the base unit.
- 5 Press **PROGRAM**.
 - A beep sounds from the base unit.

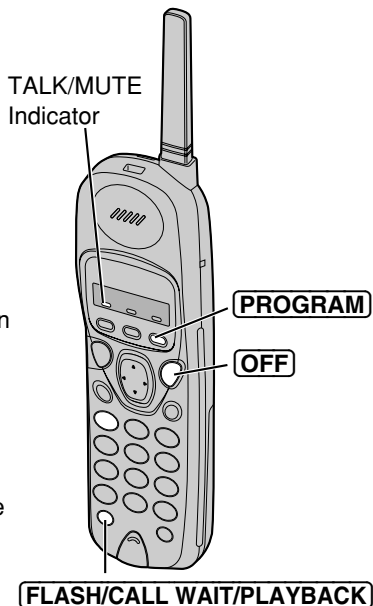

- You can exit the programming mode any time by pressing **OFF**.

To check the remote code

Press **PROGRAM** → **FLASH/CALL WAIT/PLAYBACK** → **1**.

- The current remote code is displayed on the base unit. When finished, press **OFF**.

➔ Remote Operation from a Touch Tone Phone

Voice Menu

The shaded boxes are voice prompts.

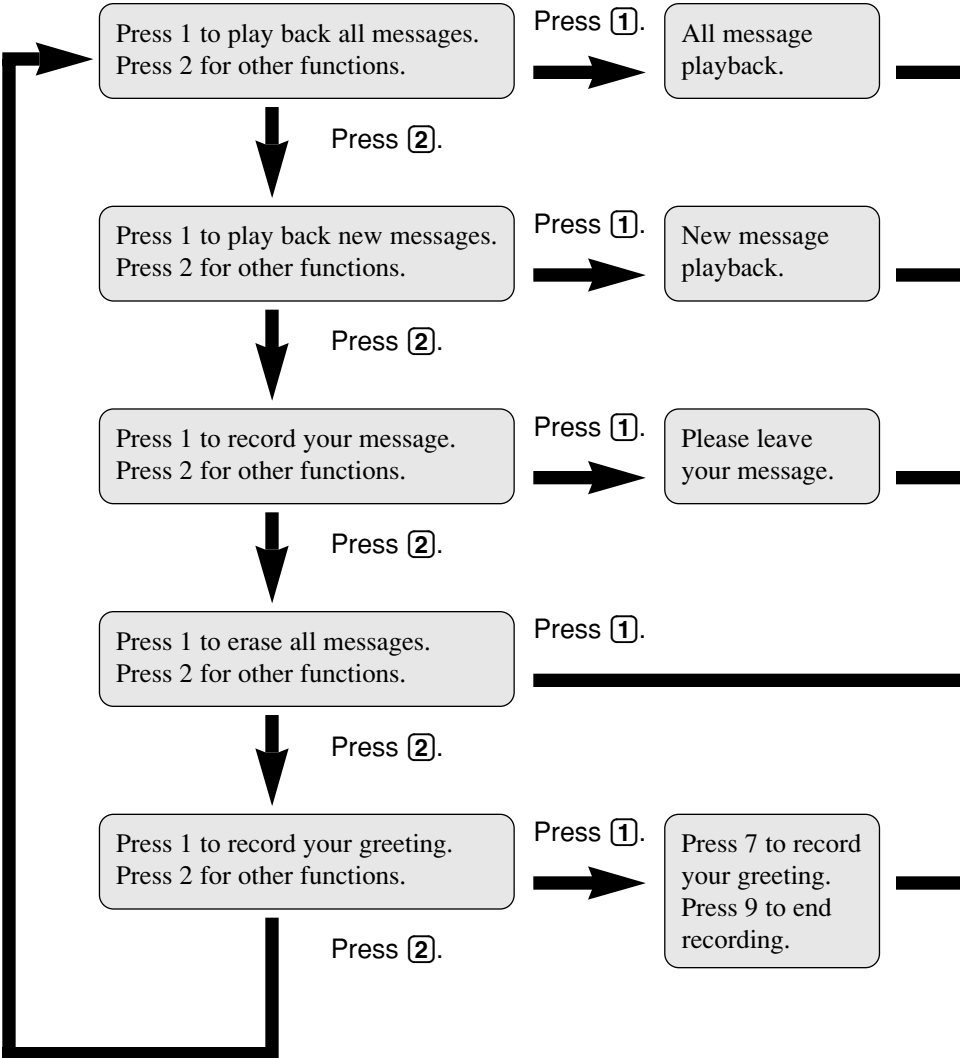



All Message Playback

All recorded messages are played back. At the end of the last message, "End of final message" is heard. The unit will announce the remaining recording time if it is less than 5 minutes.

New Message Playback

Only new messages are played back. At the end of the last message, "End of final message" is heard. The unit will announce the remaining recording time if it is less than 5 minutes.

Recording a Memo Message

You can leave a personal message.

1. Talk after you hear "Please leave your message".
2. When you finish recording, hang up.

Erasing All Messages

All recorded messages (except greeting message) are erased.

Recording a Greeting Message

You can re-record your greeting message.

1. Press **[7]**.
You will hear a voice prompt followed by a long beep.
2. After the beep, talk for up to 2 minutes.
3. When you finish recording, press **[9]**.
4. Your greeting will be played back for confirmation.

- 3 seconds after playback, the voice menu will start again from the beginning.
- If you hear "Memory full" after playback, erase some, or all, of the messages (p. 39).

➡ Remote Operation from a Touch Tone Phone

Direct Remote Operation

Once you have entered the remote code, you can also control your unit by direct commands instead of using the voice menu. To end the remote operation, hang up anytime.

Direct commands

NEW MESSAGE
PLAYBACK

4

- Only new messages are played back.
-

ALL MESSAGE
PLAYBACK

5

- All messages are played back.
-

REPEAT
(During playback)

1

- The current message is repeated.
 - If you press within 5 seconds of playback, the previous message will be played.
-

SKIP
(During playback)

2

- The current message is skipped.
The next message is played.
-

CHANGING
PLAYBACK
SPEED
(During playback)

3

- Each time you press the button, the playback speed will change to slow/normal.
-

STOP

9

- Operation is stopped temporarily.
 - To resume operation, enter a direct command within 15 seconds, or the voice menu will start.
-

GREETING
MESSAGE
RECORDING

7

- A long beep sounds.

↓
RECORD

- After the beep, talk immediately for up to 2 minutes.

↓
9

- The recording is stopped.
 - The recorded message is played.
-

ERASING A
SPECIFIC
MESSAGE
(During playback)

***** **4**

- The current message is erased.
- A short beep will sound and the next message will be played.

ERASING ALL
MESSAGES

***** **5**

- All recorded messages are erased.
- A long beep sounds and “No messages” is heard.

ANSWERING
SYSTEM OFF

0

- The unit hangs up and will not answer calls until turned on again.
-

Turning on the answering system

Call your unit and wait for 15 rings.

- The unit will answer and the greeting message will be played.
- The answering system will turn on. Hang up or enter the remote code for other options.
- When turning on the answering system using a rotary or pulse service telephone, you cannot enter the remote code for other options.

Skipping the greeting message

After calling your unit, press ***** during the greeting message.

- The unit skips the rest of the greeting message and you can start recording your message after the long beep.

Remote Operation with the Handset

You can operate your answering system with the handset.

The announcements and recorded messages can only be heard with the handset.

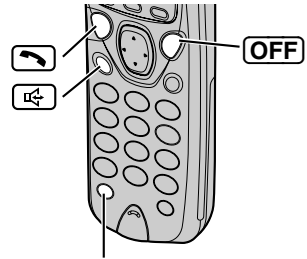

FLASH/CALL WAIT/PLAYBACK

Summary of remote operation

Press **FLASH/CALL WAIT/PLAYBACK**.

- The number of new messages is heard.



To listen to the announcements and messages from the speaker, press  **while they are heard.**

- To switch back to the receiver, press .



Enter the desired direct commands (p. 41).

- If you do not enter a command, the voice menu will start (see below).
- After the voice menu, all message playback will start.



To end remote operation, press **FLASH/CALL WAIT/PLAYBACK** or **OFF**.

- The messages are saved.

- The unit will announce the remaining recording time after playback, if it is less than 5 minutes.
- If the unit starts to ring during the remote operation, press  or  to answer the call. The remote operation is ended.
- If you hear "Memory full" after playback, erase some, or all, of the messages (p. 41).

Voice menu

If no commands are entered after you press **FLASH/CALL WAIT/PLAYBACK**, the unit will start the following voice menu.

"Press 4 to play back new messages. Press 5 to play back all messages."

- You can enter direct commands even if the voice menu has started.

Direct commands

NEW MESSAGE PLAYBACK	4	<ul style="list-style-type: none"> • Only new messages are played back.
ALL MESSAGE PLAYBACK	5	<ul style="list-style-type: none"> • All messages are played back.
REPEAT (During playback)	1	<ul style="list-style-type: none"> • The current message is repeated. • If you press within 5 seconds of playback, the previous message will be played.
SKIP (During playback)	2	<ul style="list-style-type: none"> • The current message is skipped. The next message is played.
CHANGING PLAYBACK SPEED (During playback)	3	<ul style="list-style-type: none"> • Each time you press the button, the playback speed will change to slow/normal.
STOP	9	<ul style="list-style-type: none"> • Operation is stopped temporarily. • To resume operation, enter a direct command within 15 seconds, or the voice menu will start (p. 40).
ERASING A SPECIFIC MESSAGE (During playback)	* 4	<ul style="list-style-type: none"> • The current message is erased. • A short beep will sound and the next message will be played.
ERASING ALL MESSAGES	* 5	<ul style="list-style-type: none"> • All recorded messages are erased. • A long beep sounds and “No messages” is heard.
ANSWERING SYSTEM OFF	0	<ul style="list-style-type: none"> • “Answer off” is heard and the answering system is turned off.
ANSWERING SYSTEM ON	8	<ul style="list-style-type: none"> • “Answer set” is heard and the answering system is turned on.

Wall Mounting

This unit can be mounted on a wall phone plate.

- 1 Push the hook and turn it around.
Turn the hook until a click is heard.

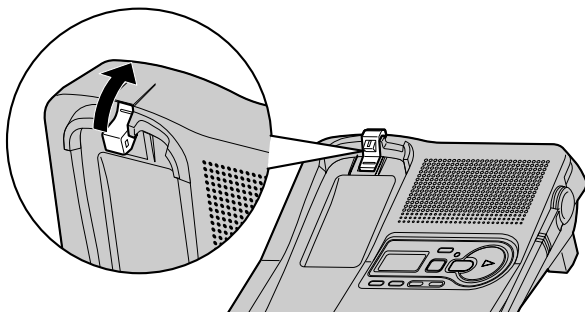

- 2 Connect the AC adaptor.

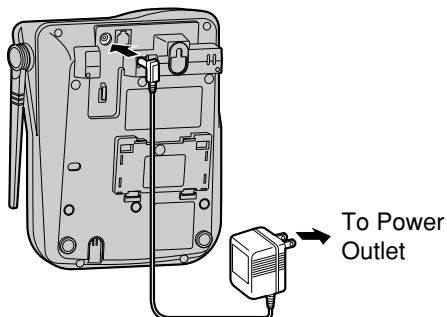

- 3 Tuck the telephone line cord inside the wall mounting adaptor, then push it in the direction of the arrow.
 - The word "UP" should face upward.

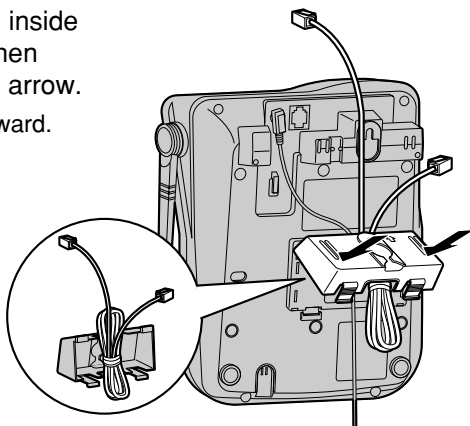

4 Connect the telephone line cord.
Mount the unit, then slide down.

- Raise the antenna.
- Fasten the telephone line cord to prevent it from being disconnected.

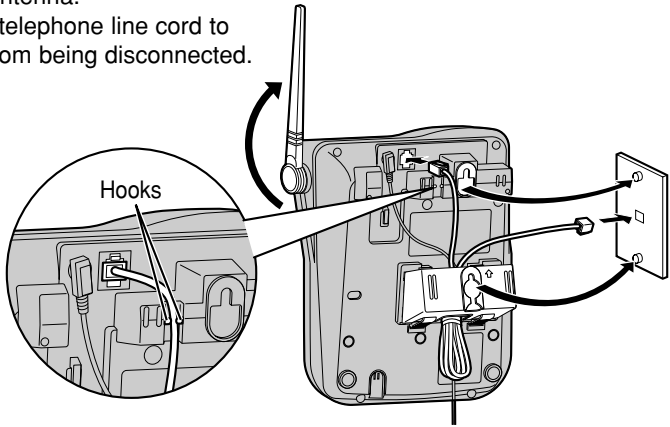

5 **To charge the handset battery:**
Fix the charge contacts (①) and insert the hook to the handset hole (②).

- The IN USE/CHARGE/HOLD indicator lights.

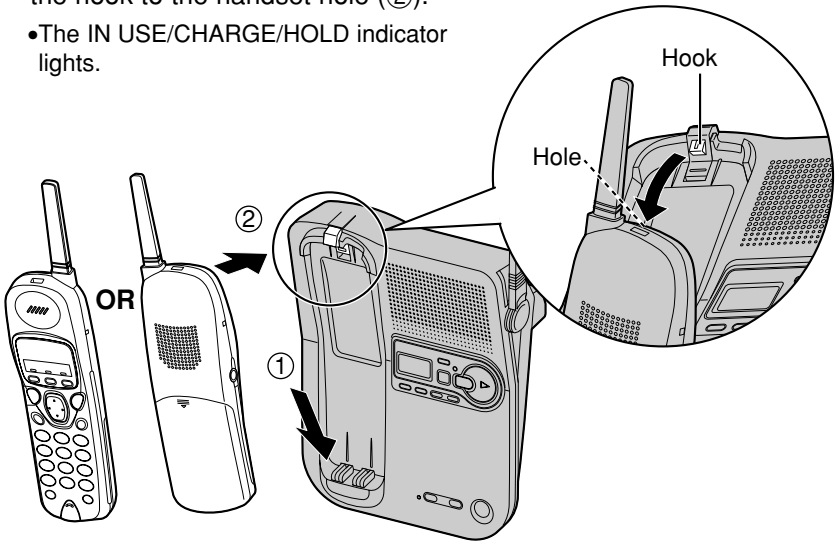

Belt Clip

You can hang the handset on your belt or pocket using the belt clip.

To attach the belt clip

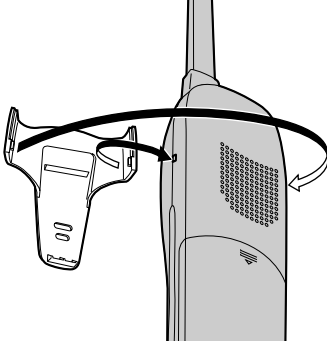

To remove the belt clip



Optional Headset



Plugging an optional headset into the handset allows a hands-free phone conversation. Please use only a Panasonic KX-TCA88 or KX-TCA90 headset. To order, call the accessories telephone number on page 2.

Connecting an optional headset to the handset

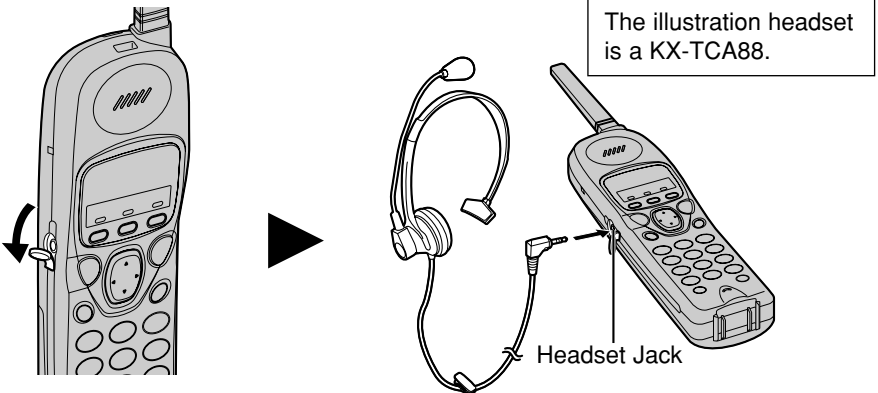
Open the headset jack cover, and connect an optional headset to the headset jack as shown below.



To switch to the speakerphone while using the headset:

Press . To return to the headset, press .

Battery Replacement

If the RECHARGE indicator flashes after being fully charged, replace the battery with a new Panasonic P-P511 (PQPP511SVC) battery. To order, call the accessories telephone number on page 2.

- 1 Press the notch on the handset cover firmly and slide it as indicated by the arrow.

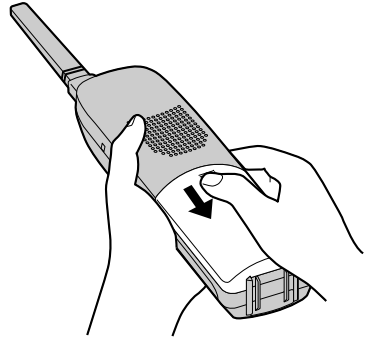

- 2 Remove the old battery. Insert the new battery into the handset as shown (1), matching the correct polarity. Press the battery down until it places into the compartment (2).

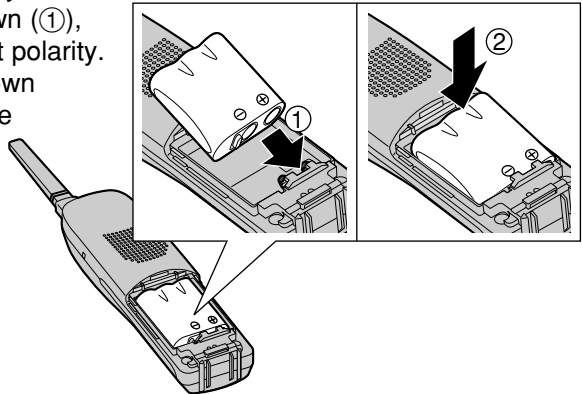

- 3 Close the cover. Make sure you charge the new battery for about 15 hours (p. 10).

A nickel cadmium battery that is recyclable powers the product you have purchased. At the end of its useful life, under various state and local laws, it is illegal to dispose of this battery into your municipal waste stream. Please call 1-800-8-BATTERY for information on how to recycle this battery.



Adding Another Phone

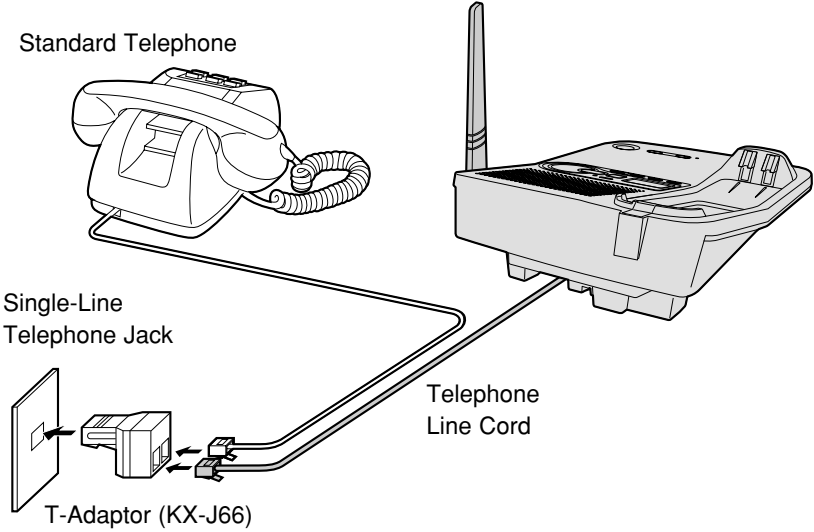

This unit will not function during a power failure. To connect a standard telephone on the same line, use the Panasonic T-adaptor KX-J66. To order, call the accessories telephone number on page 2.





Troubleshooting



Cordless Telephone



Problem	Remedy
An alarm tone sounds.	<ul style="list-style-type: none">•You are too far from the base unit. Move closer and try again.•Place the handset on the base unit and try again.•Plug in the AC adaptor.•Raise the base unit antenna.
Static, sound cuts in/out, fades. Interference from other electrical units.	<ul style="list-style-type: none">•Locate the handset and the base unit away from other electrical appliances (p. 3).•Move closer to the base unit.•Raise the base unit antenna.•Press  to select a clearer channel in the talk, speakerphone, intercom or remote operation mode.
The unit does not ring.	<ul style="list-style-type: none">•The ringer volume is set to OFF. Set to HIGH or LOW (p. 14).
You cannot store a phone number in memory.	<ul style="list-style-type: none">•You cannot store a number while the unit is in the talk or intercom mode.•Do not pause for over 60 seconds while storing.
While storing a phone number, the unit starts to ring.	<ul style="list-style-type: none">•To answer the call, press , . Start again from the beginning after hanging up.
You cannot make a call with the handset.	<ul style="list-style-type: none">•You cannot make a call when the unit is in the remote operation mode. Exit the mode by pressing OFF (p. 40).
You cannot page the handset.	<ul style="list-style-type: none">•The handset is too far from the base unit.•The handset is engaged in an outside call or listening to messages. Wait until the IN USE/CHARGE/HOLD indicator light goes out.

➔ Troubleshooting





Problem	Remedy
You cannot redial by pressing REDIAL/PAUSE .	<ul style="list-style-type: none">• If the last number dialed was more than 32 digits long, the number will not be redialed correctly.• The button has a double function as either redial or pause. It will redial the last number dialed if pressed at the outset of a call (p. 22). If another number has been dialed first, it will operate as a pause button (p. 27).
You cannot have a conversation using the headset.	<ul style="list-style-type: none">• Make sure that an optional headset is connected properly (p. 44).•  may have been pressed, press  to continue the conversation with the headset.



Answering System

Problem	Remedy
The answering system is on, but incoming messages are not recorded.	<ul style="list-style-type: none">•The recording time is set to “Greeting only”. Select “1 minute”, “2 minutes” or “3 minutes” (p. 19).•Memory is full. Erase some, or all, of the messages (p. 32).
You cannot listen to the recorded messages.	<ul style="list-style-type: none">•Make sure that the unit is not being used.
“ FULL ” is displayed and the ANSWER ON indicator flashes rapidly, and no new messages are recorded.	<ul style="list-style-type: none">•Memory is full. Erase some, or all, of the messages (p. 32).
You cannot operate the answering system with the base unit.	<ul style="list-style-type: none">•The handset user is operating the answering system, or is engaged in an outside call. Wait until the IN USE/CHARGE/HOLD indicator light goes out.
You cannot operate the answering system from a touch tone phone.	<ul style="list-style-type: none">•Make sure you enter the correct remote code.•The answering system may not respond if the tones are too short to activate the unit. Press each button firmly.•The answering system is off. Turn it on (p. 39).
You cannot operate the answering system with the handset.	<ul style="list-style-type: none">•Someone is operating the answering system.•You are too far from the base unit. Move closer to the base unit.•The unit is recording a message. To answer the call, press  or .

➔ Troubleshooting

Problem	Remedy
While recording a greeting message, the unit starts to ring and stops recording.	<ul style="list-style-type: none">•To answer the call, lift the handset off the base unit or press,  or . Start again from the beginning after hanging up.
During playback, the unit starts to ring and stops playback.	<ul style="list-style-type: none">•To answer the call, lift the handset off the base unit or press,  or . To resume playback, press MESSAGE PLAYBACK/SLOW TALK after hanging up.

General

Problem	Remedy
The unit does not work.	<ul style="list-style-type: none">•Check the settings (p. 9–14).•Charge the battery fully (p. 10).•Clean the charge contacts and charge again (p. 11).•Install the battery properly (p. 10).•Place the handset on the base unit and unplug the AC adaptor to reset. Plug in, and try again.•Re-install the battery and place the handset on the base unit (p. 45). Try again.

Problem	Remedy
You cannot program items such as the dialing mode.	<ul style="list-style-type: none"> •Programming is not possible while the unit is in the talk or intercom mode, or while the answering system is in use. •Do not pause for over 60 seconds while programming. •Move closer to the base unit.
Previously programmed information is erased.	<ul style="list-style-type: none"> •If a power failure occurs, programmed information may be erased. Reprogram if necessary.
The RECHARGE indicator flashes or the unit beeps intermittently.	<ul style="list-style-type: none"> •Charge the battery fully (p. 10).
You charged the battery fully, but the RECHARGE indicator flashes.	<ul style="list-style-type: none"> •Clean the charge contacts and charge again (p. 11). •Install a new battery (p. 45).
The IN USE/CHARGE/HOLD indicator light does not go out after the battery has been charged.	<ul style="list-style-type: none"> •This is normal.
If you cannot solve your problem	<ul style="list-style-type: none"> •Call our customer call center at 1-800-211-PANA(7262). •Panasonic's e-mail address for customer inquiries: consumerproducts@panasonic.com for customers in the USA or Puerto Rico ONLY

Important Safety Instructions

When using this unit, basic safety precautions should always be followed to reduce the risk of fire, electric shock, or personal injury.

1. Read and understand all instructions.
2. Follow all warnings and instructions marked on this unit.
3. Unplug this unit from AC outlets before cleaning. Do not use liquid or aerosol cleaners. Use a damp cloth for cleaning.
4. Do not use this unit near water, for example, near a bathtub, washbowl, kitchen sink, or the like.
5. Place this unit securely on a stable surface. Serious damage and/or injury may result if the unit falls.
6. Do not cover slots and openings on the unit. They are provided for ventilation and protection against overheating. Never place the unit near radiators, or in a place where proper ventilation is not provided.
7. Use only the power source marked on the unit. If you are not sure of the type of power supplied to your home, consult your dealer or local power company.
8. Do not place objects on the power cord. Install the unit where no one can step or trip on the cord.
9. Do not overload wall outlets and extension cords. This can result in the risk of fire or electric shock.
10. Never push any objects through slots in this unit. This may result in the risk of fire or electric shock. Never spill any liquid on the unit.
11. To reduce the risk of electric shock, do not disassemble this unit. Take the unit to an authorized servicer when service is required. Opening or removing covers may expose you to dangerous voltages or other risks. Incorrect reassembly can cause electric shock when the unit is subsequently used.
12. Unplug this unit from the wall outlet and refer servicing to an authorized servicer when the following conditions occur:
 - A. When the power supply cord or plug is damaged or frayed.
 - B. If liquid has been spilled into the unit.
 - C. If the unit has been exposed to rain or water.
 - D. If the unit does not work normally by following the operating instructions. Adjust only controls covered by the operating instructions. Improper adjustment may require extensive work by an authorized servicer.
 - E. If the unit has been dropped or physically damaged.
 - F. If the unit exhibits a distinct change in performance.
13. During thunderstorms, avoid using telephones except cordless types. There may be a remote risk of an electric shock from lightning.
14. Do not use this unit to report a gas leak, when in the vicinity of the leak.

SAVE THESE INSTRUCTIONS

CAUTION:

To reduce the risk of fire or injury to persons, read and follow these instructions.

1. Use only the battery(ies) specified.
2. Do not dispose of the battery(ies) in a fire. They may explode. Check with local waste management codes for special disposal instructions.
3. Do not open or mutilate the battery(ies). Released electrolyte is corrosive and may cause burns or injury to the eyes or skin. The electrolyte may be toxic if swallowed.
4. Exercise care in handling batteries in order not to short the battery to conductive materials such as rings, bracelets, and keys. The battery and/or conductor may overheat and cause burns.
5. Charge the battery(ies) provided with or identified for use with this product only in accordance with the instructions and limitations specified in this manual.

WARNING:

TO PREVENT FIRE OR SHOCK HAZARD, DO NOT EXPOSE THIS PRODUCT TO RAIN OR ANY TYPE OF MOISTURE.

- The AC adaptor is used as the main disconnect device, ensure that the AC outlet is located/installed near the unit and is easily accessible.

FCC and Other Information

If requested by the telephone company, inform them as follows:

Registration No.(found on the bottom of the unit)

Ringer Equivalence0.1B

The particular telephone line to which the equipment is connected.

This unit must not be connected to a coin operated line.

If you are on a party line, check with your local telephone company.

Ringer Equivalence No. (REN):

The REN is useful in determining the quantity of devices you may connect to your telephone line and still have all of those devices ring when your telephone number is called. In most, but not all areas, the sum of the REN's of all devices connected to one line should not exceed five (5.0). To be certain of the number of devices you may connect to your line, as determined by the REN, you should contact your local telephone company to determine the maximum REN for your calling area.

In the event terminal equipment causes harm to the telephone network, the telephone company should notify the customer, if possible, that service may be stopped.

However, where prior notice is impractical, the company may temporarily cease service providing that they:

- (a) Promptly notify the customer.
- (b) Give the customer an opportunity to correct the problem with their equipment.
- (c) Inform the customer of the right to bring a complaint to the Federal Communication Commission pursuant to procedures set out in FCC Rules and Regulations Subpart E of Part 68.

The Telephone Company may make changes in its communications facilities, equipment, operations or procedures, where such action is reasonably required in the operation of its business and is not inconsistent with the rules and regulations in 47 CFR Part 68.

If such changes can be reasonably expected to render any customer terminal equipment incompatible with telephone company communications facilities, or require modification or alteration of such terminal equipment, or otherwise materially affect its use or performance, the customer shall be given adequate notice in writing, to allow the customer an opportunity to maintain uninterrupted service.

When programming emergency numbers and/or making test calls to emergency numbers:

1. Remain on the line and briefly explain to the dispatcher the reason for the call before hanging up.
2. Perform such activities in the off-peak hours, such as early morning hours or late evenings.

This device complies with Part 15 of the FCC Rules. Operation is subject to the following two conditions: (1) This device may not cause harmful interference, and (2) this device must accept any interference received, including interference that may cause undesired operation.

Privacy of communications may not be ensured when using this phone.

**CAUTION:**

Any changes or modifications not expressly approved by the party responsible for compliance could void the user's authority to operate this device.

Note:

This equipment has been tested and found to comply with the limits for a Class B digital device, pursuant to Part 15 of the FCC Rules. These limits are designed to provide reasonable protection against harmful interference in a residential installation. This equipment generates, uses, and can radiate radio frequency energy and, if not installed and used in accordance with the instructions, may cause harmful interference to radio communications. However, there is no guarantee that interference will not occur in a particular installation. If this equipment does cause harmful interference to radio or television reception, which can be determined by turning the equipment off and on, the user is encouraged to try to correct the interference by one or more of the following measures:

- Reorient or relocate the receiving antenna.
- Increase the separation between the equipment and receiver.
- Connect the equipment into an outlet on a circuit different from that to which the receiver is connected.
- Consult the dealer or an experienced radio/TV technician for help.

Some cordless telephones operate at frequencies that may cause interference to nearby TVs and VCRs. To minimize or prevent such interference, the base of the cordless telephone should not be placed near or on top of a TV or VCR. If interference is experienced, move the cordless telephone further away from the TV or VCR. This will often reduce, or eliminate, interference.

Operating near 2.4GHz electrical appliances may cause interference. Move away from the electrical appliances and/or press the CH (Channel) button.

CAUTION:

To comply with FCC RF exposure requirements, the base unit should be installed with its antenna located at 20 cm or more from persons and handset should be carried with the specific belt-clip provided for the handset to ensure compliance. Other non-tested belt-clips or similar body-worn accessories may not comply, therefore, should be avoided.

This equipment is hearing aid compatible.

A TIA/EIA-IS-968 compliant telephone cord and modular plug is provided with this equipment. This equipment is designed to be connected to the telephone network or premises wiring using a compatible modular jack that is also TIA/EIA-IS-968 compliant.

➡ FCC and Other Information

- **Environment** — do not place the unit in a room where the temperature is less than 5°C (41°F) or greater than 40°C (104°F). Allow 10 cm (4") clearance around the unit for proper ventilation. Avoid excessive smoke, dust, mechanical vibration, shock, or direct sunlight.
- **Medical** — consult the manufacturer of any personal medical devices, such as pacemakers, to determine if they are adequately shielded from external RF (radio frequency) energy. (The unit operates in the frequency range of 2402MHz to 2480MHz, and the power output level can range 0.015 watts.) Do not use the unit in health care facilities if any regulations posted in the area instruct you not to do so. Hospitals or health care facilities may be using equipment that could be sensitive to external RF (radio frequency) energy.
- **Routine care** — wipe the unit with a soft cloth. Do not use benzine, thinner, or any abrasive powder. When you leave the unit unused for a long period of time, unplug the AC adaptor from the outlet.
- **If there is any trouble** — disconnect the unit from the telephone line and connect a known working phone. If the known working phone operates properly, have your unit repaired by one of the authorized Panasonic Factory Service Centers. If the known working phone does not operate properly, consult your telephone company.

Index

- A** Accessories 2
- Answering calls 23
- Automatic Security Code Setting . 26
- B** Base location..... 3
- Battery Charge 3, 10
- Battery information 11
- Battery replacement45
- Belt Clip..... 44
- C** Call on hold 22
- Caller's recording time 19
- Call waiting tone 26
- Command menu 38, 39, 41
- D** Day and time 18
- Dialing mode 12
- Display 8
- E** Erasing a message 32
- Erasing all messages 32
- F** FCC and other information..... 54
- FLASH button..... 27
- Flash time..... 27
- G** Greeting message 15
- Greeting, answer setting 28
- H** Headset, optional 44
- Hold alarm 22
- I** Installation
- AC adaptor 9
- Adding another phone..... 46
- Battery10
- Telephone line cord 9
- Intercom call..... 25
- Intercom paging 25
- L** Lighted Handset Keypad..... 22
- Line mode 13
- Listening to messages 29
- Location of controls 6, 7
- M** Making Calls.....21, 22
- Memo Message.....33
- Microphone
- Base Unit15, 25
- Handset..... 21, 23
- Message storage time 16
- Muting a conversation 26
- N** Noise 3
- Number of rings..... 20
- P** PAUSE 27
- Pulse service 26
- R** Recording a conversation33
- Recording time 19
- Redial 22
- Remote Code 35
- Remote operation..... 34, 40
- Ringer Off 14
- Ringer Pattern14
- Ringer Volume 14
- Rotary service, tone dialing..... 26
- S** Safety Instructions..... 52
- Slow Talk Message Playback29
- Shipping product for service 58
- Speakerphone 21
- Speed Dialer
- Dialing24
- Storing.....24
- T** Toll saver..... 20
- Troubleshooting
- Answering System 49
- Cordless telephone 47
- General 50
- V** Voice menu36, 40
- Volume control
- Base Unit 15, 25, 29
- Handset..... 22

For product service

- Call 1-800-211-PANA(7262) for the location of an authorized servicer.
- Panasonic's e-mail address for customer inquiries:
consumerproducts@panasonic.com
for customers in the USA or Puerto Rico ONLY

When you ship the product

- Carefully pack your unit, preferably in the original carton.
- Attach a letter, detailing the symptom, to the outside of the carton.

Symptom

- Send the unit to an authorized servicer, prepaid and adequately insured.
- Do not send your unit to the Panasonic Consumer Electronics Company listed on the back cover or to executive or regional sales offices. These locations do not repair consumer products.

- This cordless telephone is designed for use in the United States of America. Sale or use of this product in other countries may violate local laws.
- Ce téléphone sans fil est conçu pour être utilisé aux États-Unis d'Amérique. La vente ou l'emploi de cet appareil dans certains autres pays peut constituer une infraction à la législation locale.
- Este teléfono sin cordón fue elaborado para uso en los Estados Unidos de América. La venta o el empleo de este producto en ciertos países puede constituir violación de la legislación local.
- このコードレス電話機は、日本国外での使用を目的として設計されており、日本国内での使用は法律違反となります。従って、当社では日本国内においては原則として修理などのサービスは致しかねます。

**If you need assistance with the set-up or operation,
please call 1-800-211-PANA(7262)**

**Panasonic Consumer Electronics Company,
Division of Matsushita Electric Corporation of America**
One Panasonic Way, Secaucus, New Jersey 07094

**Panasonic Sales Company,
Division of Matsushita Electric of Puerto Rico, Inc.**
Ave. 65 de Infantería, Km. 9.5, San Gabriel Industrial Park
Carolina, Puerto Rico 00985