

Panasonic

2.4GHz Expandable Cordless Phone System

Operating Instructions

Model No. **KX-TG2352W**

Pulse-or-tone dialing capability

Preparation

Basic Operation

Advanced Operation

Useful Information



Caller ID Compatible

PLEASE READ BEFORE USE AND SAVE.

Charge the battery for about 15 hours before initial use.

**Panasonic World Wide Web address: <http://www.panasonic.com>
for customers in the USA or Puerto Rico**

Thank you for purchasing your new Panasonic cordless telephone.

Please read IMPORTANT SAFETY INSTRUCTIONS on page 62 before use. Read and understand all instructions.

Caller ID and Call Waiting Service and Voice Mail Service, where available, are telephone company services. After subscribing to Caller ID, this phone will display a caller's name and phone number. Call Waiting Caller ID, which displays a second caller's name and phone number while the user is on the phone line with the first caller, requires a subscription to both Caller ID with Name and Call Waiting Service. After subscribing to Voice Mail Service, "Voice mail" will be displayed on the handset when there are new messages left in the voice mail box at phone company.

Attach your purchase receipt here.

Energy Star:

As an ENERGY STAR® Partner, Panasonic has determined that this product meets the ENERGY STAR guidelines for energy efficiency. ENERGY STAR is a U.S. registered mark.



Accessories (included) For extra orders, call 1-800-332-5368.

- AC Adaptor for base unit (p. 8)
Order No. PQLV10Z (PQLV10)

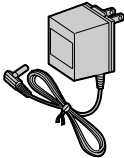

one

- Charger Unit (p. 8)
Charger Order No. PQLV30017ZW
AC Adaptor Order No. PQLV2Z (PQLV2)

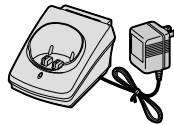

one

- Telephone Line Cord (p. 8)
Order No. PQJA10075Z

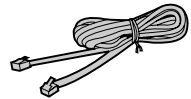

one

- Battery (p. 9, 53)
Order No. N4HHGMB00001 (HHR-P103)

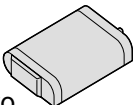

two

- Handset Cover (p. 9, 53)
Order No. PQKK10131Z2

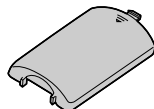

two

- Belt Clip (p. 11)
Order No. PQKE10352Z2

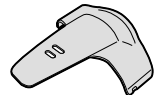

two

If you want to add one more handset to the system, please purchase the optional handset KX-TGA230B or KX-TGA230W. The charger is included. To order, contact your dealer or call 1-800-211-PANA(7262) to locate a dealer.

For Best Performance

Battery Charge

A rechargeable Ni-MH battery powers the handset. Charge the battery for about **15 hours** before initial use (p. 9).

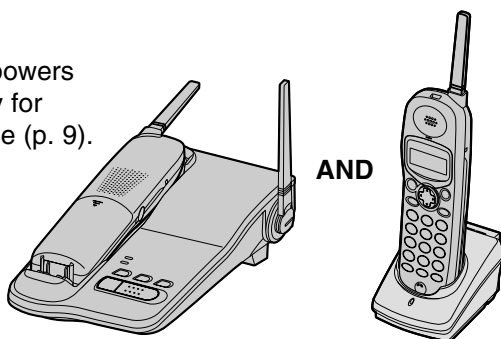

Base Unit Location/Noise

Calls are transmitted between the base unit and the handset using wireless radio waves. **For maximum distance and noise-free operation**, the recommended base unit location is:

Away from electrical appliances such as a TV, personal computer or another cordless phone.

In a **HIGH** and **CENTRAL** location with no obstructions such as walls.

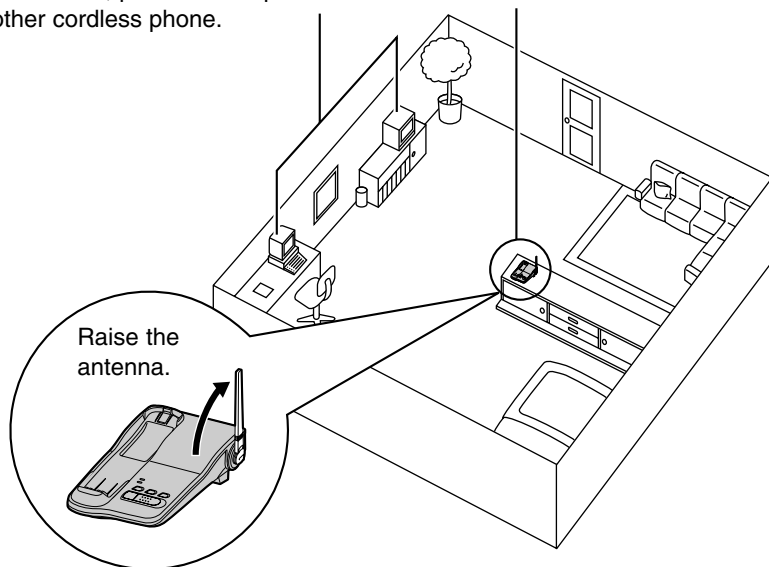

Note:

While using the handset:

- If you are near a microwave oven which is being used, noise may be heard from the receiver or the speaker. Move away from the microwave oven and closer to the base unit.
- If you use the handset near another cordless phone's base unit, noise may be heard. Move away from the other cordless phone's base unit and closer to your base unit.

Contents

Preparation

Location of Controls	6
Installation	8
Connections	8
Installing the Battery in the Handset	9
Battery Charge	9
Belt Clip	11
Optional Headset	11
Programmable Settings	12
Programming Guidelines	12
Function Menu Table	13
Dialing Mode	14
Line Mode	15
Auto Talk Feature	16
Ringer Volume	17
LCD Contrast	18
Registration for Additional Handsets	19

Basic Operation

Making Calls	20
Answering Calls	24
Caller ID Service	25
Using the Caller List	26
Viewing the Caller List	26
Calling Back from the Caller List	27
Editing the Caller's Phone Number	28
The Caller ID Number Auto Edit Feature	29
Storing Caller List Information in the Directory	30
Erasing Caller List Information	31

Advanced Operation

Directory	32
Storing Names and Numbers	32
Dialing from the Directory	35
Editing.....	36
Erasing	37
Intercom	38
Making Intercom Calls.....	38
Answering Intercom Calls	39
Transferring a Call	40
Conference	41
Call Share	41
Voice Mail Service	42
Storing a Voice Mail Access Number	42
Setting the Voice Mail (VM) Tone Detection	44
Listening to Voice Mail Messages	45
Special Features	46
Temporary Tone Dialing (For Rotary or Pulse Service Users)	46
Muting Your Conversation.....	46
Handset Locator.....	46
For Call Waiting Service Users	47
How to Use the PAUSE Button (For PBX Line/Long Distance Calls).....	47
FLASH Button	48
Ringer Tone	49
Incoming Call Tone	49

Useful Information

Wall Mounting	50
Adding Another Phone	52
Battery Replacement	53
Canceling Registration/Re-registration	54
Canceling the Handset Registration	54
Re-registering the Handset	55
If the Following Appear	56
Troubleshooting	58
Important Safety Instructions	62
FCC and Other Information	64
Specifications	67
Index	68
Warranty	69

Location of Controls

Base unit

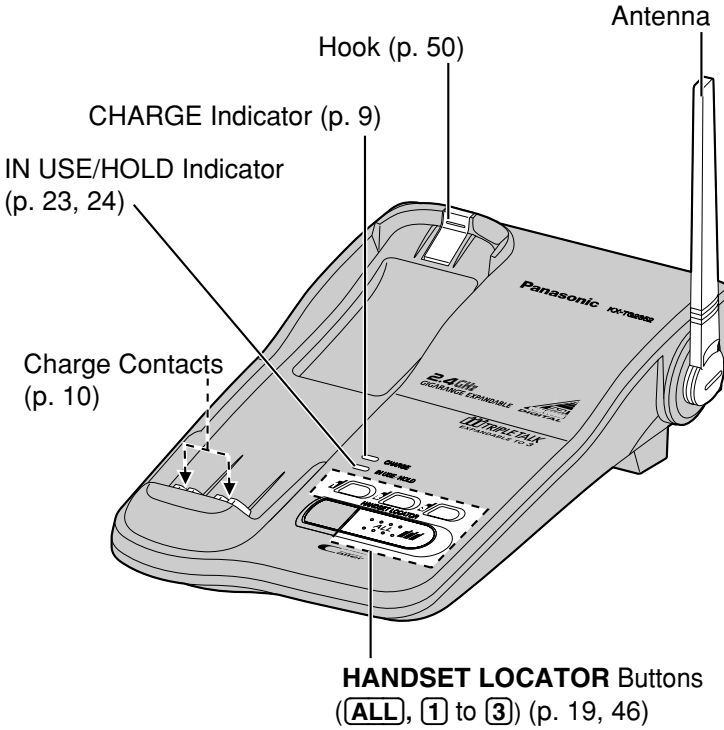

Charger unit

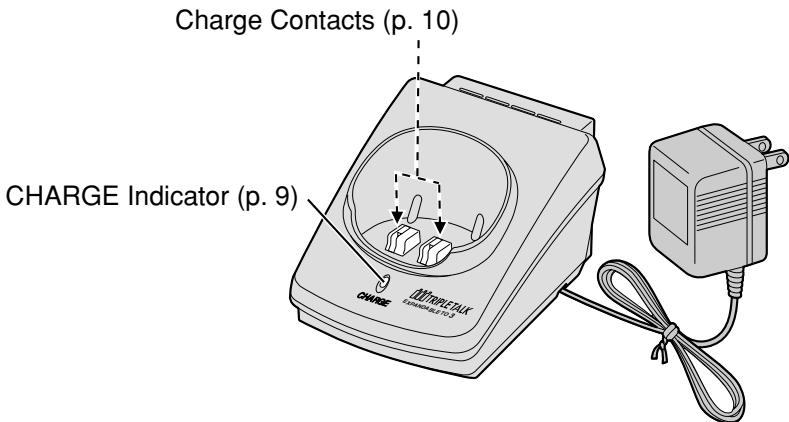



Handset

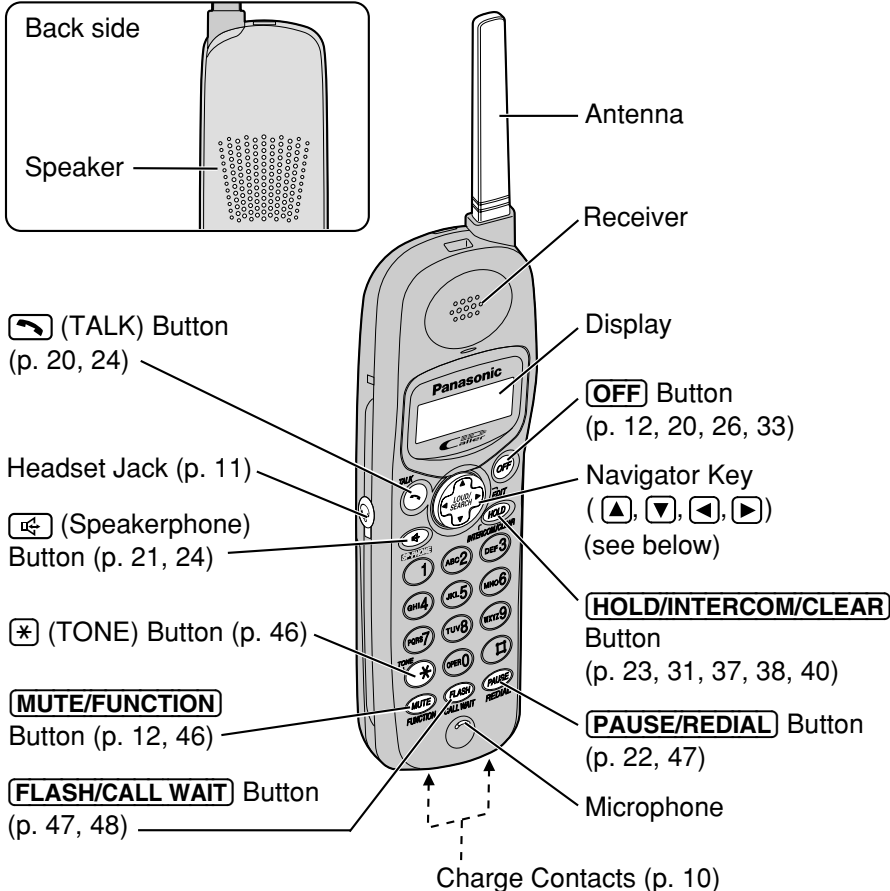
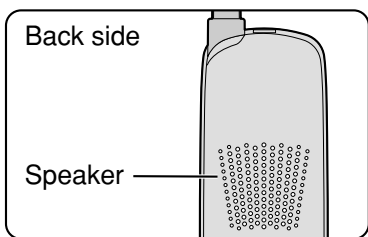

How to use the Navigator key

This key has four active areas that are indicated by arrows.



- Pressing the up and down arrows allows you to scroll through a list of settings, the Caller List and your personal directory. The up and down arrows are also used to adjust the ringer volume and the receiver/speaker volume.
- Pressing the right and left arrows allows you to enter the directory list and to move the cursor when entering directory items.
- The right arrow is also used to select your menu choices.

Throughout these Operating Instructions, the Navigator key is indicated by the arrows ▼, ▲, ◀ or ▶.

Installation

Connections

Base unit

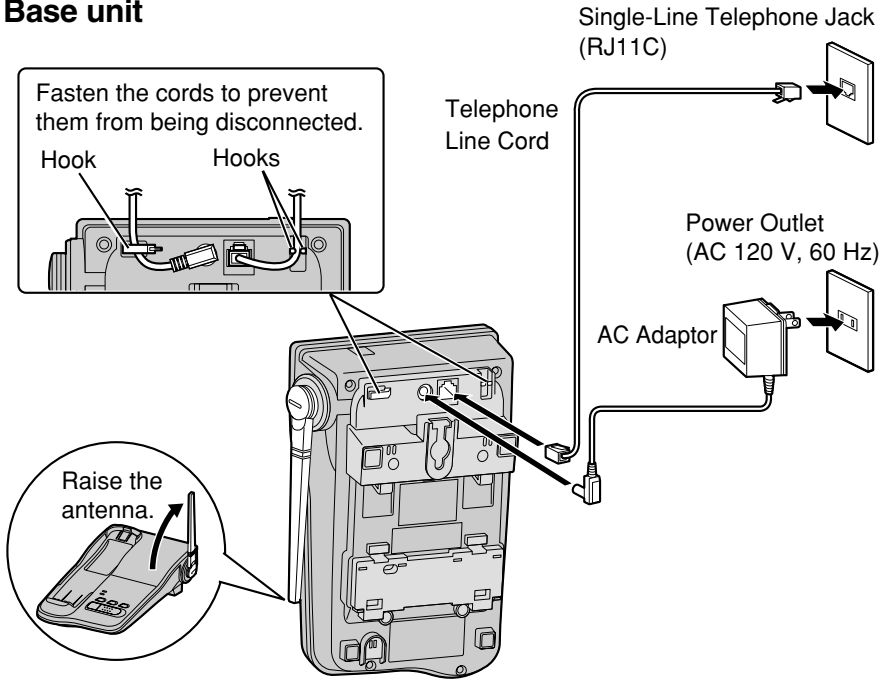

- USE ONLY WITH Panasonic AC ADAPTOR PQLV10 (Order No. PQLV10Z).
- The AC adaptor must remain connected at all times. (It is normal for the adaptor to feel warm during use.)
- To connect a standard telephone on the same line, see page 52.
- If your unit is connected to a PBX which does not support Caller ID and voice mail services, you cannot access those services.

Charger unit

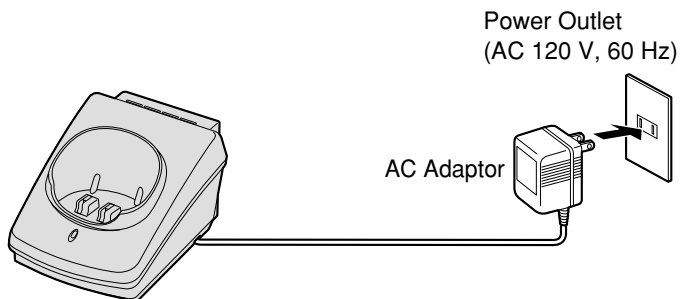

- USE ONLY WITH Panasonic AC ADAPTOR PQLV2 (Order No. PQLV2Z).
- The AC adaptor must remain connected at all times. (It is normal for the adaptor to feel warm during use.)



Installing the Battery in the Handset

Insert the battery into the handset as shown, matching the correct polarity (①). Press the battery down until it fits securely into the compartment (②). When finished, close the cover.

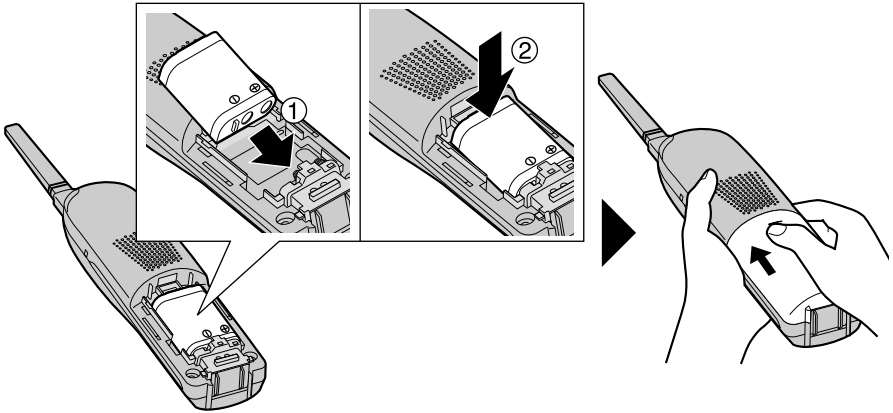

Battery Charge

Place the handsets on the base unit and the charger, then charge for about **15 hours** before initial use.

- The CHARGE indicator on the base unit will light, a beep will sound and “Charging” will be displayed on the handset.
- Each handset has an extension number, the number [1] or [2] is shown on the top right of the display (p. 19).
- You can charge either handset on the base unit or the charger.

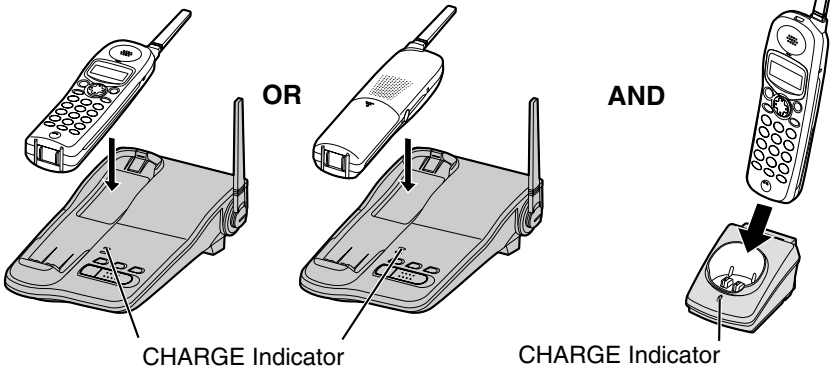
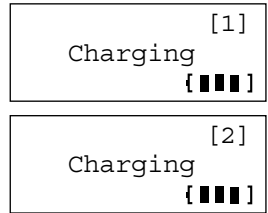

➔ Installation

Battery strength

You can check the battery strength on the handset display. The battery strength is as shown in the chart below.

Display prompt	Battery strength
{ ■■■ }	Fully charged
{ ■■ }	Medium
{ ■ }	Low
{ ■ } (flashing)	Needs to be recharged.

Recharge

Recharge the battery when:

- “Recharge” is displayed on the handset,
- “{ ■ }” flashes on the display, or
- the handset beeps intermittently while it is in use.



- If you DO NOT recharge the handset battery for more than 15 minutes, the display will continually indicate “Recharge” and/or “{ ■ }” will flash when the handset is lifted off the base unit or the charger.
- If the battery has been discharged, the handset will display “Charge for 15h” when you place the handset on the base unit or the charger. The handset will not work. Keep charging until fully charged.

Battery information

After your Panasonic battery is fully charged (p. 9):

Operation	Operating time
While in use (TALK)	Up to 4 hours
While not in use (Standby)	Up to 7 days

- The battery operating time may be shortened depending on usage conditions and ambient temperature.
- Clean the charge contacts of the handset, the base unit and the charger with a soft, dry cloth once a month. Clean more often if the unit is subject to grease, dust or high humidity.** Otherwise the battery may not charge properly.
- If the battery is fully charged, you do not have to place the handset on the base unit or the charger until “Recharge” is displayed and/or “{ ■ }” flashes. This will maximize the battery life.
- The battery cannot be overcharged.

Belt Clip

You can hang the handset on your belt or pocket using the belt clip.

To attach the belt clip

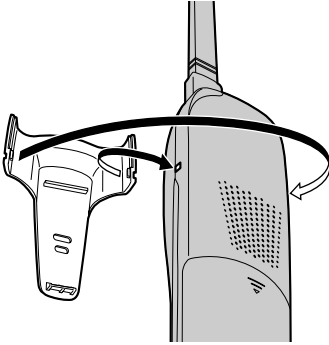

To remove the belt clip

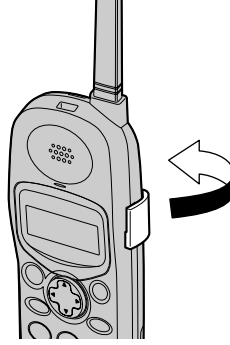

Optional Headset



Plugging a headset into the handset allows a hands-free phone conversation. Please use only the Panasonic KX-TCA88 headset. To order, call the accessories telephone number on page 2.

Connecting the optional headset to the handset

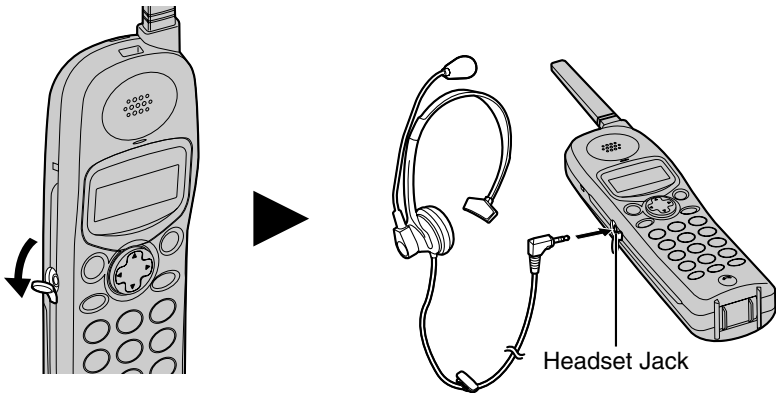
Open the headset jack cover, and connect the optional headset to the headset jack as shown below.



To switch to the speakerphone while using the headset:

Press . To return to the headset, press .

Programmable Settings

Programming Guidelines

This unit has programmable functions. Most of them are selected from the function menu on the display (p. 13).

Navigator key has four active areas that are indicated by arrows. The key is indicated by the arrows ▲, ▼, ◀, ▶ or ► in the Operating Instructions.

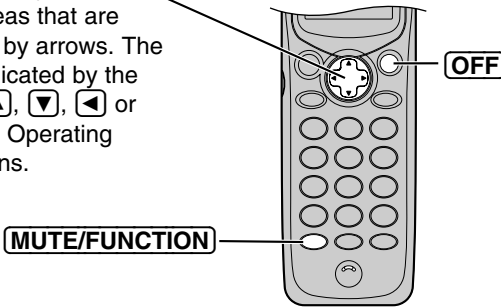

How to select a function item from the menu

Make sure the unit is not being used and the handset is lifted off the base unit.

1. Press **MUTE/FUNCTION**.

- The main menu is displayed (p. 13).

```
-----
▶Save directory
  V.M. access
```

2. You can scroll through the menu by pressing ▼ or ▲. Scroll to the desired item by pressing ▼ or ▲.

```
V.M. access
▶Ringer setting
  Initial set
```

3. Press ► to select the item.

4. If the item has a sub-menu I, it will be displayed. Select the sub-menu item by pressing ▼ or ▲, and press ►. If the sub-menu I item has the sub-menu II, it will be displayed. Select the sub-menu II item in the same way.

```
Ringer volume
▶Ringer tone
  Incoming call
```

5. You can then select the desired setting by pressing ▼ or ▲.

```
Ex. Ringer tone setting
Ringer tone
                                     :1
▼▲                                     ▶=Save
```

6. To save the setting, press ► (Save key).

- When programming is complete, a confirmation tone sounds. The display will return to the main menu or the sub-menu I or the sub-menu II (if the function item is in the sub-menu I or in the sub-menu II). You can continue programming other items. To exit the menu, press **OFF**.



Useful information:

- “-----” indicates the beginning or the end of the function menu.
- You can go back to the previous display by pressing except when entering characters or numbers. To return to the main menu from the sub-menu I or sub-menu II, press .
- You can exit the programming mode any time by pressing **[OFF]**.
- If you do not press any buttons for 60 seconds, the handset will exit the programming mode.
- If the unit detects a problem, an error message will be displayed (p. 56).

Function Menu Table

You can use the following functions to customize your unit. After pressing **[MUTE/FUNCTION]**, the main menu is displayed. Most items in the main menu have a sub-menu I. The sub-menu I is shown after selecting the item in the main menu. If the sub-menu I item has the sub-menu II, it will be displayed after selecting that sub-menu I item. See the corresponding pages for function details.

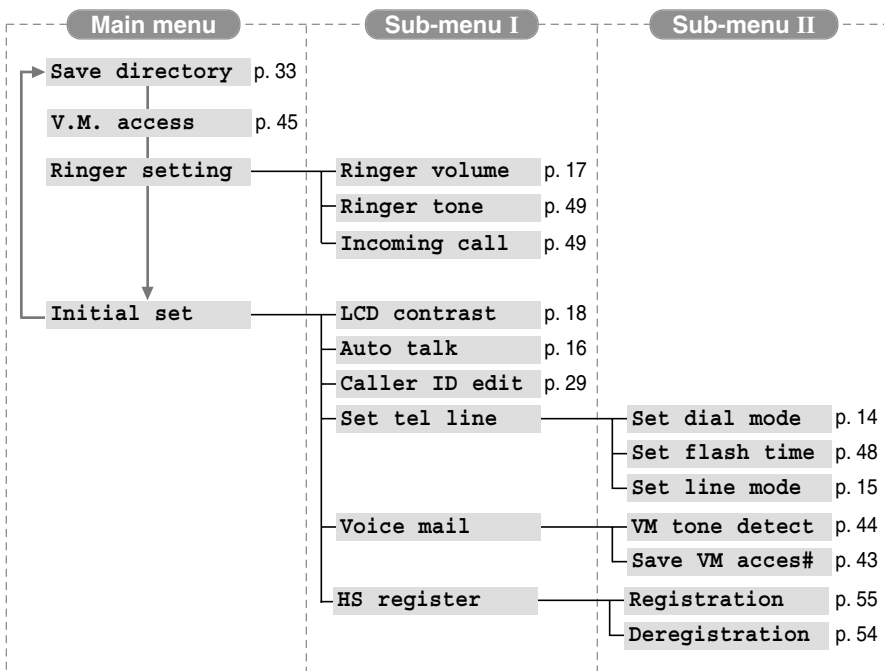

- If you program the dialing mode, the flash time, the line mode or the voice mail feature using one of the handsets, you will not need to program the same function using the other handsets.

➡ Programmable Settings

Dialing Mode

If you have touch tone service, set to “Tone”. If rotary or pulse service is used, set to “Pulse”. Your phone comes from the factory set to “Tone”.
Make sure the unit is not being used and the handset is lifted off the base unit.

1 Press **MUTE/FUNCTION**.

```
-----  
▶Save directory  
V.M. access
```

2 Scroll to “Initial set” by pressing ▼ or ▲.

```
Ringer setting  
▶Initial set  
-----
```

3 Press ▶.

```
-----  
▶LCD contrast  
Auto talk
```

4 Scroll to “Set tel line” by pressing ▼ or ▲.

```
Caller ID edit  
▶Set tel line  
Voice mail
```

5 Press ▶.

```
-----  
▶Set dial mode  
Set flash time
```

6 Press ▶ at “Set dial mode”.
•The current setting is displayed.

```
Set dial mode  
:Tone  
▼▲ ▶=Save
```

7 Select “Pulse” or “Tone” by pressing ▼ or ▲.

```
Set dial mode  
:Pulse  
▼▲ ▶=Save
```

8 Press ▶ (Save key).
•A beep sounds.
•To exit the programming mode, press **OFF**.

```
Set dial mode  
:Pulse
```

•You can exit the programming mode any time by pressing **OFF**.



Line Mode

If the line is connected to a low voltage system such as a PBX, set to "B". Your phone comes from the factory set to "A".

Make sure the unit is not being used and the handset is lifted off the base unit.

1 Press **MUTE/FUNCTION**.

```
-----
▶Save directory
  V.M. access
```

2 Scroll to "Initial set" by pressing **▼** or **▲**, and press **▶**.

```
Ringer setting
▶Initial set
-----
```

3 Scroll to "Set tel line" by pressing **▼** or **▲**.

```
Caller ID edit
▶Set tel line
  Voice mail
```

4 Press **▶**.

```
-----
▶Set dial mode
  Set flash time
```

5 Scroll to "Set line mode" by pressing **▼** or **▲**.

```
Set flash time
▶Set line mode
-----
```

6 Press **▶**.
•The current setting is displayed.

```
Set line mode
                               :A
▼▲                               ▶=Save
```

7 Select "B" or "A" by pressing **▼** or **▲**.

```
Set line mode
                               :B
▼▲                               ▶=Save
```



8 Press **▶** (Save key).
•A beep sounds.
•To exit the programming mode, press **OFF**.

```
Set line mode
                               :B
```

•You can exit the programming mode any time by pressing **OFF**.

➡ Programmable Settings



Auto Talk Feature

The Auto Talk feature allows you to answer a call by lifting the handset off the base unit or the charger without pressing  or . If you want to use this feature, turn the feature ON by programming. Your phone comes from the factory set to OFF.

Make sure the unit is not being used and the handset is lifted off the base unit.

1 Press **MUTE/FUNCTION**.



```
-----
▶Save directory
  V.M. access
```

2 Scroll to “Initial set” by pressing  or .

```
Ringer setting
▶Initial set
-----
```

3 Press .



```
-----
▶LCD contrast
  Auto talk
```

4 Scroll to “Auto talk” by pressing  or .

```
LCD contrast
▶Auto talk
  Caller ID edit
```

5 Press .
•The current setting is displayed.

```
Auto talk
                                :Off
▼▲                               ▶=Save
```

6 Select “On” or “Off” by pressing  or .

```
Auto talk
                                :On
▼▲                               ▶=Save
```

7 Press  (Save key).
•A beep sounds.
•To exit the programming mode, press **OFF**.

```
Auto talk
                                :On
```

- You can exit the programming mode any time by pressing **OFF**.
- In order to view Caller ID information after you lift up the handset to answer a call, leave the Auto Talk feature OFF.



Ringer Volume

You can program the handset ringer volume to HIGH, MEDIUM, LOW or OFF. If set to OFF, the handset will not ring for external calls, and for internal calls it will ring at the LOW level. Your phone comes from the factory set to HIGH.

Make sure the unit is not being used and the handset is lifted off the base unit.

- 1 Press **MUTE/FUNCTION**.
- 2 Scroll to "Ringer setting" by pressing **▼** or **▲**, and press **▶**.
- 3 Press **▶** at "Ringer volume".
- 4 Select the desired volume by pressing **▼** or **▲**.
 - Each time you press **▼** or **▲**, the volume will change and ring.
 - To turn the ringer OFF:** press **▼** repeatedly until "Off ?" is displayed.
- 5 Press **▶** (Save key).
 - A beep sounds.

```

V.M. access
▶Ringer setting
Initial set
  
```

```

-----
▶Ringer volume
Ringer tone
  
```

HIGH

```

Ringer volume
Low  - - - - - High
▶▲          ▶=Save
▲▲         ▼▼
  
```

MEDIUM

```

Ringer volume
Low  - - - - High
▲▲         ▼▼
  
```

LOW

```

Ringer volume
Low  - - High
▲▲         ▼▼
  
```

OFF

```

Ringer volume
Off ?
  
```

To turn the ringer ON:

Press **▲** in step 4.

- The ringer will sound at the LOW level.

- You can exit the programming mode any time by pressing **OFF**.
- If set to OFF, "Ringer off" will be displayed while the handset is not in use.
- If you have received new calls, "Ringer off" will not be displayed but "Received calls" will be displayed while the handset is not in use. "Ringer off" will be displayed for about 5 seconds after completing operations or lifting the handset from the base unit or the charger.
- You can also select the ringer volume while an external call is being received. Press **▼** or **▲** while the handset is just ringing.
- You can change the ringer tone for external calls. See page 49.

➡ Programmable Settings

LCD Contrast

You can program the handset LCD contrast (6 levels). Your phone comes from the factory set to level 3.

Make sure the unit is not being used and the handset is lifted off the base unit.

- 1 Press **MUTE/FUNCTION**.
- 2 Scroll to "Initial set" by pressing **▼** or **▲**, and press **▶**.
- 3 Press **▶** at "LCD contrast".
- 4 Select the desired contrast by pressing **▼** or **▲**.
 - Each time you press **▼** or **▲**, the LCD contrast will change.
 - The number of steps shows the LCD contrast level.
- 5 Press **▶** (Save key).
 - A beep sounds.
 - To exit the programming mode, press **OFF**.

```
Ringer setting
▶Initial set
-----
```

```
-----
▶LCD contrast
Auto talk
```

```
Level 6
LCD contrast
Low  . . . . . High
▼▲   ▶=Save
```

```
Level 4  :
LCD contrast
Low  . . . . High
      :
      ▼
```

```
Level 1  :
LCD contrast
Low  . High
      :
      ▼
```

- You can exit the programming mode any time by pressing **OFF**.

Registration for Additional Handsets ➔

KX-TG2352W includes two handsets with the base unit. You can expand the system by adding up to 1 optional handset to the system. A maximum of 3 handsets can be registered at the base unit. Generally a maximum of 3 extensions excluding or including the base unit can operate at a time. But while you make a conference call (p. 41), the 3rd handset cannot operate. "Busy" will be displayed when you try to operate 3rd handset.

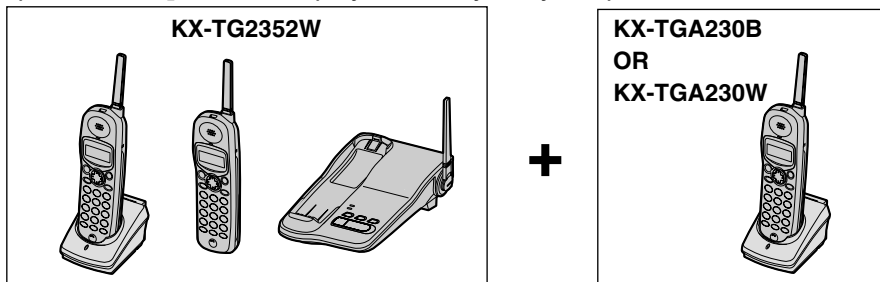

The included handsets are pre-registered at the factory and assigned the extension number 1 and 2. You do not need to register these handsets which has "[1]" and "[2]" on the display.

If you purchase an optional handset, you must register it at the base unit. A handset will be assigned the extension number 3 at registration. The 3rd handset is displayed "[3]".

The model numbers of the optional handsets are KX-TGA230B and KX-TGA230W. To order, contact your dealer or call 1-800-211-PANA(7262) to locate a dealer.

Make sure the base unit and the other handsets are not being used. Registration must be completed within 1 minute.

The handset display shows the instructions as shown on the right.

Press [ALL] on base for 3 sec, then press [▶].

- 1 Base unit:**
Press and hold **HANDSET LOCATOR** [ALL] until the CHARGE indicator flashes.

- 2 Handset:**
① Press [▶].

- ② Wait until a long beep sounds and the display shows the registered number. The registration will be then complete.

Handset
Registering

Ex. Extension number 3

Handset [3]
Registered

- The registered number "[1]" to "[3]" is shown on the top right of the display.

[3]

{■■■■}

➔ Registration for Additional Handsets

- You can stop registration by pressing **OFF** on the handset and pressing **HANDSET LOCATOR ALL** on the base unit.
- After you register an additional handset to the base unit, please confirm that the other (first one and second one) pre-registered handsets display "Talk" by pressing . If one of the handsets does not display "Talk", re-register that handset to the base unit.

To re-register a handset to a different base unit of the same model, see pages 54 and 55.

Making Calls

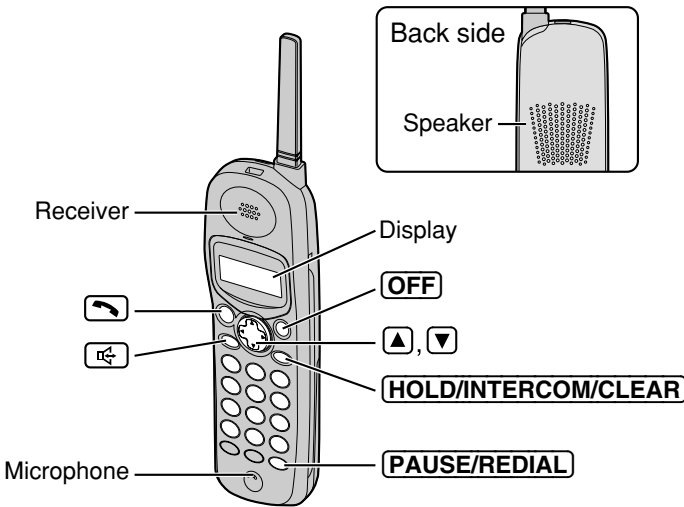

1 Press .

Talk

2 Dial a phone number.

- The dialed number is displayed.
- After a few seconds, the display will show the length of the call and the battery strength.

Talk
1112222

Talk
00-00-00 [■■■■]

3 To hang up, press **OFF** or place the handset on the base unit or the charger.

Off
00-01-08 [■■■■]

- When a handset is engaged in an outside call, "Line in use" is shown on the display of other handsets.



To have a hands-free phone conversation (Using Digital Duplex Speakerphone)

1 Press .

SP-phone

2 Dial a phone number.

- The dialed number is displayed.
- After a few seconds, the display will show the length of the call and the battery strength.

SP-phone
1112222

SP-phone
00-00-00 {■■■■}





3 When the other party answers, talk into the microphone.

4 To hang up, press **OFF** or place the handset on the base unit or the charger.

Off
00-01-08 {■■■■}

Hands-free Digital Duplex Speakerphone

For best performance, please note the following:

- Talk alternately with the caller in a quiet room.
- If the other party has difficulty hearing you, press  to decrease the speaker volume.
- If the other party's voice from the speaker cuts in/out during a conversation, press  to decrease the speaker volume.
- While talking using , you can switch to the hands-free phone conversation by pressing . To switch back to the receiver, press .

➔ Making Calls

To dial after confirming the entered number

- 1 Dial a phone number.
 - If you misdial, press **HOLD/INTERCOM/CLEAR**. One digit is erased. Dial the correct phone number.
 - To cancel, press **OFF**.

3334444

- 2 Press .
OR
To have a hands-free phone conversation, press , and when the other party answers, talk into the microphone.
 - After a few seconds, the display will show the length of the call and the battery strength.

Ex. was pressed.

Talk
3334444

- 3 To hang up, press **OFF** or place the handset on the base unit or the charger.

To redial the last number dialed on the handset

Press or and press **PAUSE/REDIAL**.

To redial using the redial list (Memory Redial)

The last 5 phone numbers dialed with the handset are stored in the redial list.

1. Press **PAUSE/REDIAL**.
 - The last number dialed is displayed.
2. Scroll to the desired number by pressing or .
- You can also scroll through the list by pressing **PAUSE/REDIAL**.
- To exit the list, press **OFF**.
3. Press or .

333-4444
▼▲ Redial list1

- To erase an item, repeat steps 1 and 2, and press **HOLD/INTERCOM/CLEAR**.
- If “No items stored” is displayed, the list is empty.

To put a call on hold

Press **HOLD/INTERCOM/CLEAR** twice.

- The IN USE/HOLD indicator light flashes, “Hold” is displayed and the call is put on hold.



- To transfer the call to another handset, see page 40.
- If a call is kept holding for 6 minutes, an alarm tone will start to sound. After 4 additional minutes on hold the call will be disconnected.
- When you put on hold the call, “Line on hold” is shown on the display of other handsets.

To release the hold

Press or .

- Another handset user can also release the hold by pressing or .
- If another phone is connected on the same line (p. 52), you can also release the hold by lifting its handset.

To adjust the receiver volume (HIGH, MEDIUM or LOW) or speaker volume (6 levels) while talking

To increase, press .

To decrease, press .

Ex. Receiver volume: High
Speaker volume: Level 6

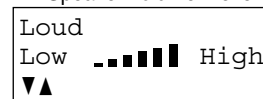

- Each time you press or , the volume level will change.
- The number of steps indicates the volume level.
- The display will return to the length of the call.

Lighted handset keypad

The handset dialing buttons will light when you press a button, lift the handset off the base unit or the charger, or when a call is received. The lights will go out a few seconds after pressing a button, lifting the handset, answering a call, hanging up a call, leaving the programming mode or ending the intercom.



Backlit LCD display

The lighted handset display will stay on for a few seconds after pressing a handset button, lifting the handset off the base unit or the charger, hanging up a call, leaving the programming mode or ending the intercom.

Answering Calls



When a call is received, the unit rings and “Incoming call” is displayed on the handset and the IN USE/HOLD indicator flashes quickly on the base unit.

If you subscribe to a Caller ID service, the calling party information will be displayed after the first ring (p. 25). In order to view the Caller ID information, please wait until the second ring to answer a call.

- 1 Press .
 - You can also answer a call by pressing any dialing button **0** to **9**, ***** or **#** (**Any Key Talk**).OR
Press , and when the other party answers, talk into the microphone.

- 2 To hang up, press **OFF**.

Auto Talk

If you set the Auto Talk feature to ON (p. 16), you can answer a call by lifting the handset off the base unit or the charger without pressing  or .

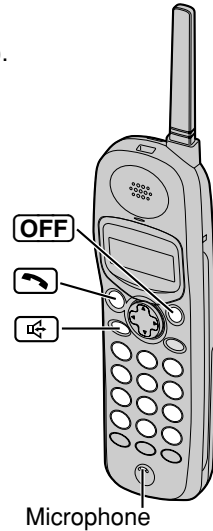

Caller ID Service

This unit is compatible with a Caller ID service offered by your telephone company. If you subscribe to a Caller ID service, the calling party's information will be shown on the handset after the first ring.

The handset can record information of up to 30 different callers, including the time and date received and the number of times called, in the Caller List. The Caller List information is sorted by the most recent to the oldest call. When the 31st call is received, the first call is deleted.

Using the list, you can automatically call back a caller. You can store the callers' names and numbers from the Caller List into the directory. If you subscribe to both Caller ID and Call Waiting services, when a second call is received while talking, the new caller's name and phone number will be displayed (p. 47).

How caller information is displayed when a call is received

The handset display shows the caller's name and phone number after the first ring.

ROBINSON, TINA
1-000-222-3333

- After you answer the call, the display will show the length of the call.

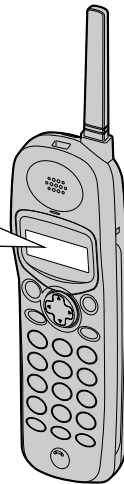

- Caller information cannot be displayed in the following cases:
 - If the caller dialed from an area which does not provide a Caller ID service, the display will show "Out of area".
 - If the caller has requested not to display his/her information, the display will show "Private caller".
- If your unit is connected to a PBX which does not support Caller ID services, you cannot access those services.
- The name display service may not be available in some areas. For further information, please contact your telephone company.
- If the handset has lost communication with the base unit when a call is received, the caller information will not be recorded in the Caller List.

Using the Caller List

If you have received new calls, "Received calls" will be displayed while the handset is not in use.

Handset on the base unit

```
[1]
Received calls
{■■■■}
```

Handset off the base unit

```
[1]
Received calls▼
{■■■■}
```

Viewing the Caller List

To check who has called, follow the steps below.

Make sure the unit is not being used and the handset is lifted off the base unit.

- 1 Press **▼** or **▲** to enter the Caller List.
 - The display will show, for example, the following.

```
Caller list
2 new calls
▼▲ ▶=Directory
```

- 2 To search from the most recent call, press **▼**.
To search from the oldest call, press **▲**.
 - To scroll between callers, press **▼** or **▲**.

```
SMITH, JACK
1-222-333-4444
3:10P JUN10
```

- 3 To exit the list, press **OFF**.

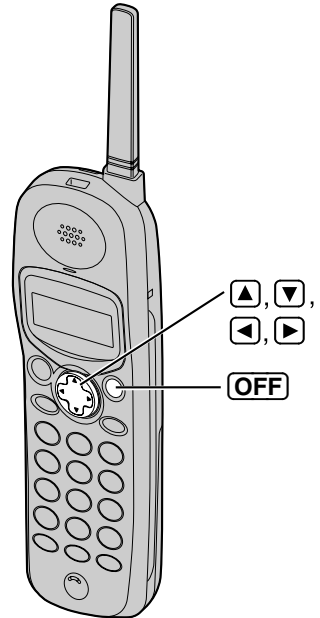

- If "No items stored" is displayed, the Caller List is empty.
- If there is no name information for a caller, the display will only show the phone number.
- After viewing all of the new call entries in the Caller List, "Received calls" will disappear.
- Once new calls have been checked, "√" will be added to caller information.
- Each handset has the Caller List individually. If you checked the Caller List on your handset, Caller List information in the other handsets will remain still NEW and "√" will not be added.
- In step 1, you can go to the directory list by pressing **▶** (p. 35).
- If you do not press any buttons for 60 seconds, the handset will exit the Caller List.



What “√” means

When the display shows “√”, you have already viewed this calling information, answered the call or called back the caller. If the same caller calls again, the call entry with “√” will be replaced with the new call entry.

SMITH, JACK
1-222-333-4444
3:10P JUN10 √

If a caller calls more than once

The number of times the same caller called is displayed (X2 to X9). The date and time of the most recent call will be recorded. After checking, X2 to X9 will be replaced with “√”.

Ex. The caller called 3 times.

TURNER, CINDY
1-234-456-7890
11:20A JAN12 X3

Calling Back from the Caller List

1 Press or to enter the Caller List.

Caller list
3 new calls
▼▲ ▶=Directory

2 Scroll to the desired caller by pressing or .

TURNER, CINDY
1-234-456-7890
11:20A JAN12 X3

3 Press or .
•The displayed phone number is dialed automatically.

Ex. Talk mode

Talk
12344567890

- In some cases, you may have to edit the number before dialing (p. 28). (Ex. You may have to delete “1” and the area code.)
- If a phone number is not displayed in the caller information, you cannot call back that caller.

➔ Using the Caller List



Editing the Caller's Phone Number

You can edit a phone number into one of 3 patterns to call back or store it into the directory.



The Caller ID Number Auto Edit Feature (p. 29)

This feature will allow the unit to edit a Caller ID number into one of 3 patterns you desired for you automatically in the Caller List. For details and activation please see page 29.

Make sure the unit is not being used and the handset is lifted off the base unit.

1 Press  or  to enter the Caller List.

```
Caller list
  5 new calls
▼▲ ▶=Directory
```

2 Scroll to the desired caller by pressing  or .

```
PARKER, FRED
1-234-321-5555
11:20A JAN12 ✓
```

3 Press .

```
▶Edit
  Save directory
▼▲ ▶=Yes
```

4 Press  (Yes key) at "Edit".

```
PARKER, FRED
1-234-321-5555
▼=Next ▶=Edit
```

5 Press  (Edit key) to select a pattern.

•Each time you press , the number is rearranged into one of 3 patterns.

(a)

(b) -

(c) 1 - -

•The order in which patterns (a)–(c) are displayed depends on how the telephone number is displayed in step 2.



(a)
▼=Next ▶=Edit

(b)
▼=Next ▶=Edit

(c)
▼=Next ▶=Edit

6 After editing the number, you can continue with calling back or storing procedures.

To call back, press  or  (p. 27).

To store the number in the directory, press  (Next key) and press  (Save key). (If the caller has no name information, see page 30, from step 3.)



The Caller ID Number Auto Edit Feature

There are 3 patterns of phone number (a, b, and c on p. 28). This feature allows your phone to automatically edit an in-coming Caller ID number into one pattern you preferred, and displays the Caller ID number with that pattern on the handset automatically.

After this feature is activated, Caller ID numbers coming from considered area codes (201, for example), from which the Caller ID numbers have been chosen to follow the desired pattern (7 digit pattern, for example), will be automatically edited from other patterns (11 digit pattern, for example) into the same pattern you have previously selected (which is 7 digit pattern, in the example).

Up to 4 area codes are allowed for this feature for patterns a, b and c (p. 28).

To activate this feature, you must (1) set this feature to on, and (2) make an out-going call from Caller List (p. 27) with a number which has one of 3 patterns that you have edited with considered area code, and that you prefer to be followed by future Caller ID numbers, so that in the future all the Caller ID numbers coming from the same area code will be displayed in the same pattern.

The Caller ID number Auto Edit feature is preset to ON at factory.

•If you fail to reach your destination when making the call, the phone number you dialed might have an incorrect pattern, please edit the phone number with another pattern (p. 28).

For example, if you move to another area, you may need to turn this feature to OFF to erase previously edited area codes. Then, if still need, you may activate this feature again.

Make sure the unit is not being used and the handset is lifted off the base unit.

1. Press **MUTE/FUNCTION**.
2. Scroll to "Initial set" by pressing or , and press .
3. Scroll to "Caller ID edit" by pressing or , and press .
4. Select "on" or "Off" by pressing or .
5. Press (Save key).
 - A beep sounds.
 - To exit the programming mode, press **OFF**.

```

Ringer setting
▶Initial set
-----
  
```

```

Auto talk
▶Caller ID edit
Set tel line
  
```

```



Auto edit
                                :On
▼▲                               ▶=Save
  
```

•When the feature is set to OFF, the unit will still be able to display Caller ID, like regular Caller ID telephone, but the in-coming Caller ID number will not be edited by pattern and by area codes.



➡ Using the Caller List

Storing Caller List Information in the Directory

You can store phone numbers that are in the Caller List into the directory. **Make sure the unit is not being used and the handset is lifted off the base unit.**

1 Press  or  to enter the Caller List.



```
Caller list
10 new calls
▼▲ ▶=Directory
```

2 Scroll to the caller you want to store in the directory by pressing  or , and press .

```
TURNER, CINDY
1-234-456-7890
11:20A JAN12 X3
```

•If the number requires editing, see page 28.

```
▶Edit
Save directory
▼▲ ▶=Yes
```

3 Scroll to “Save directory” by pressing  or , and press .

```
Edit
▶Save directory
▼▲ ▶=Yes
```





- A beep sounds.
- To continue storing other items, repeat from step 2.
- To exit the programming mode, press **OFF**.

```
TURNER, CINDY
1-234-456-7890
```

If there is no name information for the caller,

“E n t e r
n a m e” will
be displayed.

```
Enter name
█
◀▶ ▼=Next
```

- If a name is not required, press  (Next key) and press  (Save key).
- If a name is required, enter the name (p. 34). When finished, press  (Next key) and press  (Save key).

```
Enter name
CINDY TURNER
◀▶ ▼=Next
```

- A beep sounds.
- To continue storing other items, repeat from step 2.
- To exit the programming mode, press **OFF**.

```
CINDY TURNER
1-234-456-7890
```

- You can exit the programming mode any time by pressing **OFF**.
- If the display shows “Directory full” in step 3, press **OFF** to exit the list. To erase other stored items from the directory, see page 37.

•You cannot store caller information in the directory if a phone number is not displayed.

Erasing Caller List Information

After checking the Caller List, you can erase some or all of the entries. **Make sure the unit is not being used and the handset is lifted off the base unit.**

To erase a specific caller from the Caller List

- 1 Press **▼** or **▲** to enter the Caller List.

```
Caller list
 10 new calls
▼▲ ▶=Directory
```

- 2 Scroll to the caller you want to erase from the Caller List by pressing **▼** or **▲**.

```
REAGAN, TOM
1-888-777-6666
12:20A JAN12 ✓
```

- 3 Press **HOLD/INTERCOM/CLEAR**.
- A beep sounds and the information is erased.
 - To erase other items, repeat from step 2.
 - To exit the Caller List, press **OFF**.

```
Clear
```

To erase all entries in the Caller List

Before erasing all entries, make sure that "0 new call" is displayed.

- 1 Press **▼** or **▲** to enter the Caller List.

```
Caller list
 0 new call
▼▲ ▶=Directory
```

- 2 Press **HOLD/INTERCOM/CLEAR**.
- To stop erasing, press **◀** (No key).

```
All clear?
◀=No CLEAR=Yes
```

- 3 Press **HOLD/INTERCOM/CLEAR**.
- A beep sounds and all entries are erased.

```
All clear
```

Directory

You can store up to 30 names and phone numbers in the directory using the handset. All of the directory items are sorted by the first word in alphabetical order. You can make a call by selecting a name on the handset display.

Each handset has the directory list individually.

Storing Names and Numbers

Make sure the unit is not being used and the handset is lifted off the base unit.

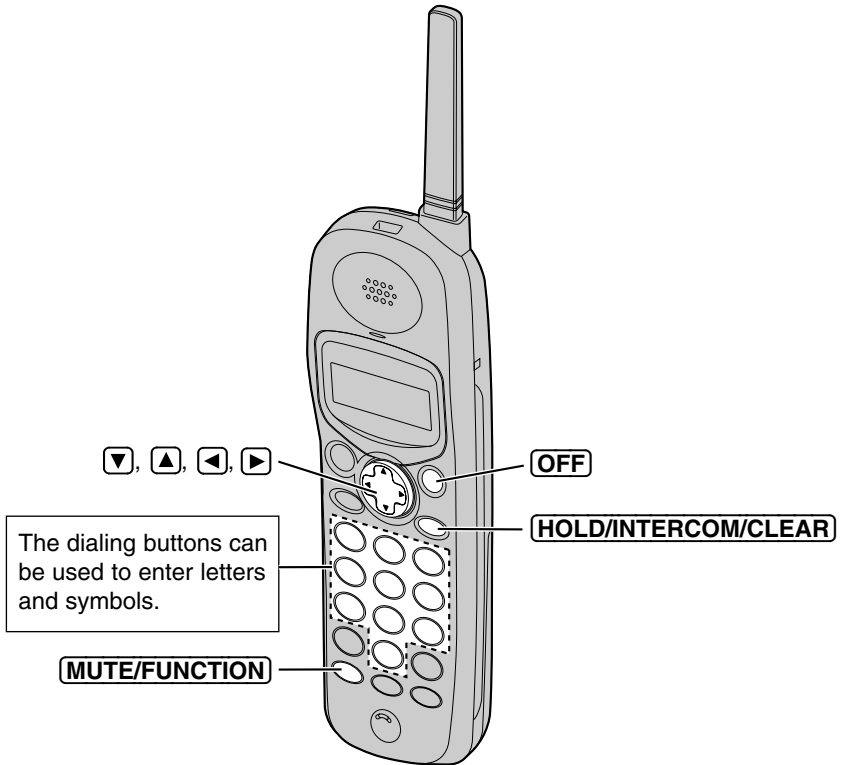



1 Press **MUTE/FUNCTION**.

```
-----
▶Save directory
  V.M. access
```

2 Press **▶** at “Save directory”.
•The display shows the number of stored items in the directory.

```
Directory
  10 items
```

3 Enter a name, up to 15 characters with the dialing buttons, (**0** to **9**) (p. 34).
•If a name is not required, press **▼** (Next key) and go to step 5.
•To move the cursor, press **◀** or **▶**.

```
Enter name
█
◀▶          ▼=Next
```

```
Enter name
Tom Jones
◀▶          ▼=Next
```

4 Press **▼** (Next key).

```
Enter phone no.
```

5 Enter a phone number, up to 22 digits.
•Each time you press **HOLD/INTERCOM/CLEAR**, a digit is erased.
To erase all of the digits, press and hold **HOLD/INTERCOM/CLEAR**.
•To move the cursor, press **◀** or **▶**.

```
0987654321 █
◀▶          ▼=Next
```

6 Press **▼** (Next key).
•If you want to change the name or number, press **▲** (Edit key) to reach the desired display and change it.

```
Tom Jones
098-765-4321
▲=Edit    ▶=Save
```

7 Press **▶** (Save key).
•A beep sounds.
•To continue storing other items, repeat from step 2.
•To exit the programming mode, press **OFF**.

```
Tom Jones
098-765-4321
```

•If a pause is required for dialing, **PAUSE/REDIAL** can be stored in a phone number counting as one digit in step 5.

•You can exit the programming mode any time by pressing **OFF**.

•If the display shows “Directory full” in step 2, the display will return to step 1, press **OFF** to exit the programming mode. To erase other stored items from the directory, see page 37.

➔ Directory

Selecting characters to enter names

The handset dialing buttons (0 to 9) can be used to enter letters and symbols. The letters are printed on the dialing buttons. Pressing each button selects a character as shown below.

Keys	Number of times key is pressed										
	1	2	3	4	5	6	7	8	9	10	11
①	#	&	'	()	*	,	-	.	/	1
②	a	b	c	A	B	C	2				
③	d	e	f	D	E	F	3				
④	g	h	i	G	H	I	4				
⑤	j	k	l	J	K	L	5				
⑥	m	n	o	M	N	O	6				
⑦	p	q	r	s	P	Q	R	S	7		
⑧	t	u	v	T	U	V	8				
⑨	w	x	y	z	W	X	Y	Z	9		
⑩	0	Blank									
◀	Moves the cursor to the left.										
▶	Moves the cursor to the right. (To enter another character using the same number key, move the cursor to the next space.)										
(HOLD/INTERCOM/CLEAR) erases characters.											

For example, to enter “Tom Jones”:

1. Press ⑧ four times.

T

2. Press ⑥ three times, then press ▶.

To

3. Press ⑥ once, then press ▶ twice.

Tom

4. Press ⑤ four times, press ⑥ three times, then press ▶.

Tom Jo

5. Press ⑥ twice, press ③ twice, then press ⑦ four times.

Tom Jones

If you make a mistake while entering a name:

Press ◀ or ▶ to move the cursor to the incorrect character, press

(HOLD/INTERCOM/CLEAR) to delete and enter the correct character. Each time you press **(HOLD/INTERCOM/CLEAR)** a character is erased. To erase all characters, press and hold **(HOLD/INTERCOM/CLEAR)**.



Dialing from the Directory

Make sure the unit is not being used and the handset is lifted off the base unit.

- 1 Press or to enter the directory list.
 - The display shows the number of stored items in the directory.

Directory list
 30 items
 = Caller

- 2 Scroll to the desired item by pressing or .
- All directory items are stored in the order shown on the right.

To search for a name by initial:

- ① Press the dialing button for the first letter of the desired name until any name with the same initial is displayed (see the Index table below).
 Ex. To find "Frank", press repeatedly until the first item under "F" is displayed.

- ② Press repeatedly until the name is displayed.

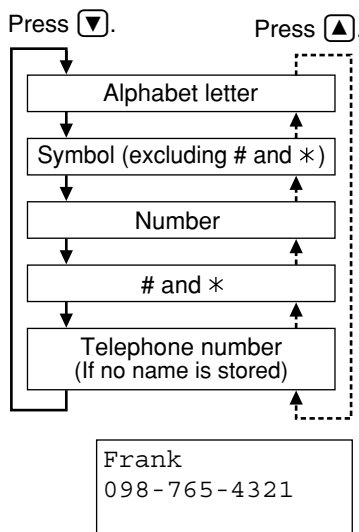

- 3 Press or .
- The number is dialed automatically.

- If "No items stored" is displayed in step 1, the directory list is empty.
- You can leave the directory list any time by pressing **OFF**.
- In step 1, you can go to the Caller List by pressing (p. 26).

Index table

Keys	Index	Keys	Index
	Other symbols, 1		M, N, O, 6
	A, B, C, 2		P, Q, R, S, 7
	D, E, F, 3		T, U, V, 8
	G, H, I, 4		W, X, Y, Z, 9
	J, K, L, 5		0, Blank

➡ Directory

Editing

Make sure the unit is not being used and the handset is lifted off the base unit.

1 Press ◀ or ▶ to enter the directory list.

2 Scroll to the directory item you want to change by pressing ▼ or ▲, and press ▶.

- To search for the item by initial, see page 35.

```
Jane
456-7890
```

```
Enter name
Jane
◀▶          ▼=Next
```

3 Edit the name using the dialing buttons, up to 15 characters.

- To move the cursor, press ◀ or ▶.
- If you do not need to change the name, press ▼ (Next key) and go to step 5.

```
Enter name
Jane Walker
◀▶          ▼=Next
```

4 Press ▼ (Next key).

```
4567890
◀▶          ▼=Next
```

5 Add a number to the current number.

- If you do not need to change the number, press ▼ (Next key) and go to step 7.

- Each time you press **HOLD/INTERCOM/CLEAR**, a digit is erased.

To erase all digits, press and hold

HOLD/INTERCOM/CLEAR.

- To move the cursor, press ◀ or ▶.

```
12344567890
◀▶          ▼=Next
```

6 Press ▼ (Next key).

- If you want to change the name or number, press ▲ (Edit key) to reach the desired display and change it.

```
Jane Walker
1-234-456-7890
▲=Edit    ▶=Save
```

7 When finished, press ▶ (Save key).



- A beep sounds.
- To continue editing other items, repeat from step 2.
- To exit the directory list, press **OFF**.



```
Jane Walker
1-234-456-7890
```

- You can exit the edit mode any time by pressing **OFF**.

Erasing

Make sure the unit is not being used and the handset is lifted off the base unit.

1 Press  or  to enter the directory list.

2 Scroll to the directory item that you want to erase by pressing  or .

- To search for the item by initial, see page 35.

Helen 1-234-567-8901

3 Press **HOLD/INTERCOM/CLEAR**.

- To stop erasing, press  (No key).

Clear?
◀=No CLEAR=Yes

4 Press **HOLD/INTERCOM/CLEAR**.

- A beep sounds and the item is erased.
- To erase other items, repeat from step 2.
- To exit the directory list, press **OFF**.

Clear

- You can exit the directory list any time by pressing **OFF**.

Intercom

A 2-way intercom is possible between two handsets.

The handset included with the base unit has the extension number 1 and 2 which has “[1]” and “[2]” on the display. An additional handset is assigned the extension number 3 at registration (p. 19). The 3rd handset is displayed “[3]”.

Making Intercom Calls

1 Press **HOLD/INTERCOM/CLEAR**.

Press
handset#[1-3]

2 To page another handset, enter the extension number using the dialing button (**1** to **3**).

Ex. Calling Handset 2



Calling [2]

- The destination handset will ring for 1 minute.
- To stop paging, press **OFF**.

3 When the paged party answers, talk into the handset.

Intercom

00-00-03 [■■■■]



- You can switch to the speaker by pressing .
- To switch back to the receiver, press .

4 To end the intercom, press **OFF**.

Off

00-00-50 [■■■■]

During an intercom call:

- If you have difficulty hearing the other party, decrease the speaker volume by pressing .
- If an incoming call is being received, you will hear two tones (incoming call tone, p. 49) and the IN USE/HOLD indicator on the base unit will flash quickly. To answer, press **OFF** and press  or .
- If the handset detects a problem, an error message will be displayed (p. 56).

Answering Intercom Calls

When an intercom call is being received, the handset rings and the display shows the calling extension.

Press ,  or **HOLD/INTERCOM/CLEAR**.

•You can also answer the call by pressing any dialing button **0** to **9**, ***** or **#** (**Any Key Talk**).

To end the intercom, press **OFF** or place the handset on the base unit or the charger.



Ex. Handset 2 calling

Call from [2]

Intercom

00-00-03 {■■■■}

Auto Talk:

If you set the Auto Talk feature to ON (p. 16), you can answer a call by lifting the handset off the base unit or the charger without pressing ,  or **HOLD/INTERCOM/CLEAR**.

- When the ringer volume is off (p. 17), the handset will ring at the LOW level for internal calls.
- You cannot change the ringer tone for internal calls.

Transferring a Call

You can transfer an external call between two handsets.

To transfer a call from the handset

1 During a call, press **HOLD/INTERCOM/CLEAR**.

- The IN USE/HOLD indicator flashes and the call is put on hold.

```
Line on hold.  
Press handset#  
to transfer:1-3
```



2 To page another handset, enter the extension number using the dialing button (1) to (3).

Ex. Calling Handset 2

```
Hold  
Calling [2]
```



3 If required, wait for the paged party to answer, and you can announce the transfer. If not required, go to step 4.

```
Intercom hold  
◀=Conference  
00-00-05 [||||]
```

- If the paged party does not answer, press  or  to return to the outside call.



4 To complete the transfer, press **OFF**.

To answer from another handset a transferred call:





–If the paging party announces the transfer, the calling extension is displayed. Press ,  or **HOLD/INTERCOM/CLEAR** to answer the page.

```
Call from [1]
```

- After the paging party hangs up the call, you can talk to the outside caller.

–If the paging party hangs up before you answer the page, “Incoming call” is displayed. Press  or  to take the transferred call.

```
Incoming call
```

- Any users can take a transferred call by pressing  or .
- If you do not announce the transfer and if the paged party does not answer within 60 seconds after you hang up, the transferred call will be returned to you with ringing. If you still do not answer the caller’s call within 4 minutes, the call will be disconnected. You may answer the caller by pressing  or  before or during the ringing.

Conference

While you are talking with an outside caller, you can make a conference call with your handset and another handset.

Ex. A conference call with Handset 1 and 2.

- 1 During a call, press **HOLD/INTERCOM/CLEAR**.
 - The IN USE/HOLD indicator flashes and the call is put on hold.

Line on hold.
Press handset#
to transfer:1-3

- 2 To page another handset, enter the extension number using the dialing button (**1** to **3**).

Ex. Calling Handset 2

Hold
Calling [2]

- 3 When the paged party answers, press **◀** (Conference) on your handset to make a conference call.
 - To leave the conference, press **OFF**. The two other parties can continue the conversation.

Ex. Intercom hold with Handset 1

Intercom hold
◀=Conference
00-00-05 {■■■■}

Conference

00-00-05 {■■■■}

- During a conference, the outside call can be placed on hold by pressing **HOLD/INTERCOM/CLEAR** on the handset. Internal communications between extensions are not suspended. Only the person who placed the call on hold can resume the full conference; press **◀** on the handset.

Call Share

This feature allows the handset to join the existing external call. A handset user can join another handset user's conversation.

To join a conversation (Call Share)

Press **☎** or **☎**.

Conference

00-00-05 {■■■■}

- A maximum of three parties including the outside party can join a conversation, if all other extensions are not being used.
Ex. While the handset is engaged in an external call, another handset can join the conversation. In that event, the 3rd handset or the base unit cannot operate.

Voice Mail Service

Voice mail service is an electronic on-line answering system offered by your telephone company. After subscribing, the voice mail system can answer calls automatically for you when your line is busy or if calls are not answered, and caller can leave their messages at the voice mail box virtually located at the telephone company. After the voice mail box has received messages, "Voice mail" will be displayed on the handset. To use this feature, you must first store your access number.

Storing a Voice Mail Access Number

Make sure the unit is not being used and the handset is lifted off the base unit.

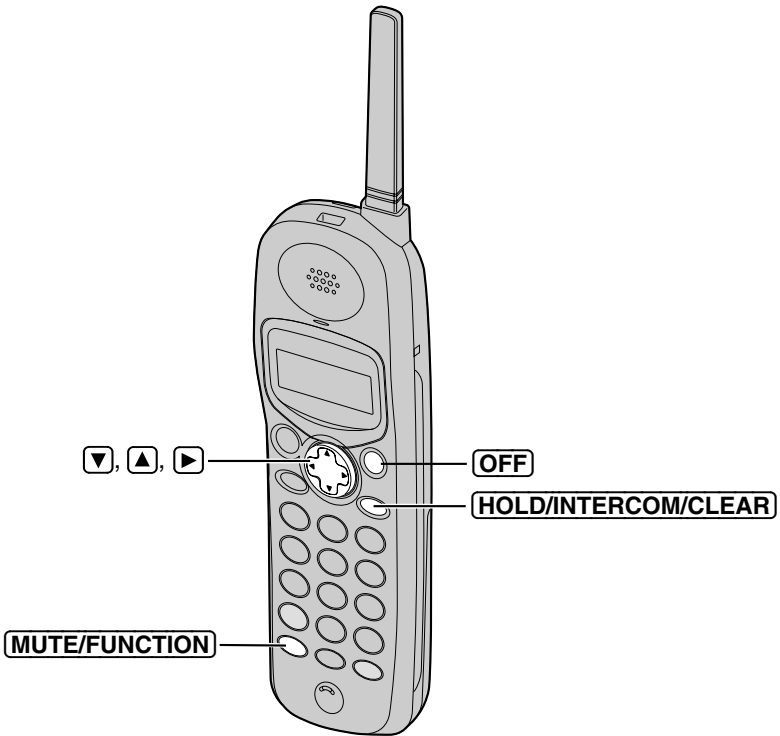



1 Press **MUTE/FUNCTION**.

2 Scroll to "Initial set" by pressing **▼** or **▲**, and press **▶**.

```
Ringer setting
▶Initial set
-----
```

3 Scroll to "Voice mail" by pressing **▼** or **▲**, and press **▶**.

```
Set tel line
▶Voice mail
HS register
```

4 Scroll to "Save VM acces#" by pressing **▼** or **▲**, and press **▶**.

```
VM tone detect
▶Save VM acces#
-----
```

5 Enter your access number, up to 32 digits.

- You may enter pauses*(see below).
- Each time you press **HOLD/INTERCOM/CLEAR**, a digit is erased. To erase all digits, press and hold **HOLD/INTERCOM/CLEAR**.

```
1234567PPP890 █
                                ▼=Save
```

6 Press **▼** (Save key).

- A beep sounds.
- To exit the programming mode, press **OFF**.

```
1234567PPP890
```

•You can exit the programming mode any time by pressing **OFF**.

To erase a stored number

Repeat steps 1 through 5 → Press and hold **HOLD/INTERCOM/CLEAR** until all of the digits are erased → **▼** (Save key).

•A beep sounds.

*For quick access to your voice mail box, you may add pauses between your voice mail box access number and your mail box password in step 5.

EX. 1-222-333-4444 PPPP 8888

Your voice mail box access number



Pauses

Your mail box password

Pressing **PAUSE/REDIAL** once creates a 3.5 second delay and counts as one digit. The delay time depends on a telephone company.

➡ Voice Mail Service

Setting the Voice Mail (VM) Tone Detection



Your telephone company sends special signals (Voice mail tones) to activate the voice mail display. Press  or  to listen to the dial tone. If you hear a series of dial tones followed by a continuous dial tone, this is indication that a new message was recorded. Your phone comes set to detect these tones (set to "On"). Minutes after you hang up or after the phone stops ringing, your unit will seize the phone line and check if a message has been recorded. If a new message was recorded at your telephone company, "Voice mail" will be displayed on the handset.

Set this programming to "Off" when:



- you do not subscribe to a voice mail service,
 - your telephone company does not send a series of tones, followed by a continuous tone, or
 - your phone is connected to a business or office telephone system (PBX).
- Please refer to below to set this programming to OFF.

If you are not sure which setting is required, consult your local telephone company or contact Panasonic Customer Call Center.

Make sure the unit is not being used and the handset is lifted off the base unit.

1 Press **MUTE/FUNCTION** and scroll to "Initial set" by pressing  or , and press .



```
Ringer setting
▶Initial set
-----
```

2 Scroll to "Voice mail" by pressing  or , and press .

```
Set tel line
▶Voice mail
HS register
```

3 Press  at "VM tone detect".
•The current setting is displayed.

```
-----
▶VM tone detect
Save VM acces#
```

4 Select "On" or "Off" by pressing  or .

```
VM tone detect
      :On
▼▲           ▶=Save
```

5 Press  (Save key).
•A beep sounds.
•To exit the programming mode, press **OFF**.

```
VM tone detect
      :On
```

•You can exit the programming mode any time by pressing **OFF**.

Listening to Voice Mail Messages

After the voice mail box has received messages, "Voice mail" will be displayed on the handset.

```
Voice mail [1]
                {■■■■}
```

To listen to your voice mail message(s)

- 1 Press **MUTE/FUNCTION**.
- 2 Scroll to "V.M. access" by pressing **▼** or **▲**, and press **▶**.

```
Save directory
▶V.M. access
Ringer setting
```
- 3 Press **☎** or **☎**.
 - The unit is connected to the telephone line and dials the access number (p. 43).
- 4 Follow the pre-recorded instructions.
- 5 When finished, press **OFF**.

- If "Store VM acces#" is displayed and 3 beeps sounds, store the number (p. 43).
- If "Voice mail" still remains on the handset even if you have listened to your voice mail message(s), press **MUTE/FUNCTION**, and press and hold **HOLD/INTERCOM/CLEAR** until the unit beeps. "Voice mail" will disappear.
- If your voice mail service uses a voice mail tone and the recorded message is over 3 minutes long, "Voice mail" may not be displayed.
- If your voice mail service uses a voice mail tone, the tone will be heard from any parallel connected phone. If you use another phone to retrieve messages, you have to dial your access number manually.

Special Features

Temporary Tone Dialing (For Rotary or Pulse Service Users)

Press **[*]** before entering access numbers which require tone dialing.

- The dialing mode changes to tone. You can enter numbers to access an answering service, electronic banking service, etc. When you hang up, the mode will return to pulse.

Muting Your Conversation

Press **[MUTE/FUNCTION]** while talking.

Ex. **[MUTE/FUNCTION]**
was pressed.

- The display on the right will be shown.

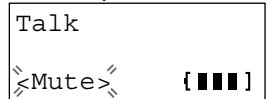

- The other party cannot hear your voice but you can hear theirs.
- To release the mute**, press **[MUTE/FUNCTION]** on the handset.
- When you switch between the receiver and speaker, the mute will be released.

Handset Locator

You can locate the handset or page the handset user from the base unit.

- 1 To page the handset**, press **HANDSET LOCATOR** (**[1]** to **[3]**).
 - The IN USE/HOLD indicator flashes.
 - The handset will ring for 1 minute.

To page all handsets, press **HANDSET LOCATOR** (**[ALL]**).

- All handsets will ring for 1 minute.
- When you stop paging with one handset, paging will stop at all handsets.

- 2 To stop paging:**

Base unit:

Press **HANDSET LOCATOR** (**[ALL]** or **[1]** to **[3]**).

OR

Handset:

Press any dialing button (**[0]** to **[9]**, **[*]** or **[#]**), **[↶]**, **[↷]** or **[OFF]**.



For Call Waiting Service Users

Press **FLASH/CALL WAIT** if you hear a call-waiting tone while talking.

- The first call is put on hold and you can answer the second call.
- To return to the first caller, press **FLASH/CALL WAIT** again.
- The call waiting service cannot be used when:
 - the first call is placed on hold, or
 - a parallel connected telephone is in use.
- If this function does not operate properly, consult your telephone company for details.

Call Waiting Caller ID Feature

Call Waiting Caller ID Feature allows your handset to display the second caller's information. After you hear a call-waiting tone while talking, the handset will display the caller's name with the phone number and "----Waiting----".

BROWN, NANCY 1-555-666-7777 ----Waiting----

- Please contact your telephone company for details and availability in your area.

How to Use the PAUSE Button (For PBX Line/Long Distance Calls)

We recommend you press **PAUSE/REDIAL** if a pause is required for dialing with a PBX or to make a long distance call.

Ex. Line access number **9** (PBX)

9 → **PAUSE/REDIAL** → Phone number

- Pressing **PAUSE/REDIAL** once creates a 3.5 second pause. This prevents misdialing when you redial or dial a stored number.
- Pressing **PAUSE/REDIAL** more than once increases the length of the pause between numbers.

➡ Special Features

FLASH Button





Pressing **FLASH/CALL WAIT** allows you to use special features of your host PBX such as transferring an extension call or accessing special telephone services (optional) such as call waiting.



- Pressing **FLASH/CALL WAIT** causes to disable the Temporary Tone Dialing mode or the mute (p. 46).

Selecting the flash time



The flash time depends on your telephone exchange or host PBX. You can select the following flash times: “700, 600, 400, 300, 250, 110, 100 or 90 ms (milliseconds)”. Your phone comes from the factory set to “700 ms”.

Make sure the unit is not being used and the handset is lifted off the base unit.

- 1 Press **MUTE/FUNCTION** and scroll to “Initial set” by pressing  or , and press .
- 2 Scroll to “Set tel line” by pressing  or .

Caller ID edit
▶Set tel line
Voice mail
- 3 Press .
- 4 Scroll to “Set flash time” by pressing  or .

Set dial mode
▶Set flash time
Set line mode
- 5 Press .
 - The current setting is displayed.

Set flash time
:700ms
▼▲ ▶=Save
- 6 Select the desired time by pressing  or .
- 7 Press  (Save key).
 - A beep sounds.
 - To exit the programming mode, press **OFF**.

- You can exit the programming mode any time by pressing **OFF**.
- If the unit is connected via a PBX, PBX functions (transferring a call etc.) might not work correctly. Consult your PBX supplier for the correct setting.

Ringer Tone

You can select the handset ringer tone out of 6 patterns for external calls. When an external call is being received, the handset will ring in the selected tone. Your phone comes from the factory set to "1".

Make sure the unit is not being used and the handset is lifted off the base unit.

- 1 Press **MUTE/FUNCTION**.
- 2 Scroll to "Ringer setting" by pressing **▼** or **▲**, and press **▶**.
- 3 Scroll to "Ringer tone" by pressing **▼** or **▲**, and press **▶**.
 - The current setting will be displayed.
- 4 Select the desired ringer tone by pressing **▼** or **▲**.
 - Each time you press **▼** or **▲**, the tone will change and ring. If the ringer volume has been set to OFF, the handset will not ring (p. 17).
 - You can also select the ringer tone by pressing dialing buttons **1** to **6**.
- 5 Press **▶** (Save key).
 - A beep sounds.
 - To exit the programming mode, press **OFF**.

```
V.M. access
▶Ringer setting
Initial set
```

```
Ringer volume
▶Ringer tone
Incoming call
```

```
Ringer tone
:1
▼▲ ▶=Save
```

Incoming Call Tone

During an intercom call (p. 38), you can be informed by two tones if a call arrives. If you set to ON, this incoming call tone will be heard for as long as the line rings. To delete the incoming call tone, set to OFF. To set the incoming call tone to sound twice, set to "2". Your phone comes from the factory set to "2".

Make sure the unit is not being used and the handset is lifted off the base unit.

- 1 Press **MUTE/FUNCTION** and scroll to "Ringer setting" by pressing **▼** or **▲**, and press **▶**.
- 2 Scroll to "Incoming call" by pressing **▼** or **▲**, and press **▶**.
 - The current setting will be displayed.
- 3 Select the desired setting, "On", "Off" or "2", by pressing **▼** or **▲**.
- 4 Press **▶** (Save key).
 - A beep sounds.
 - To exit the programming mode, press **OFF**.

```
V.M. access
▶Ringer setting
Initial set
```

```
Ringer tone
▶Incoming call
-----
```

```
Incoming call
tone :2
▼▲ ▶=Save
```

Wall Mounting

Base unit

This unit can be mounted on a wall phone plate.

- 1 Push the hook and turn it around.
Turn the hook until a click is heard.

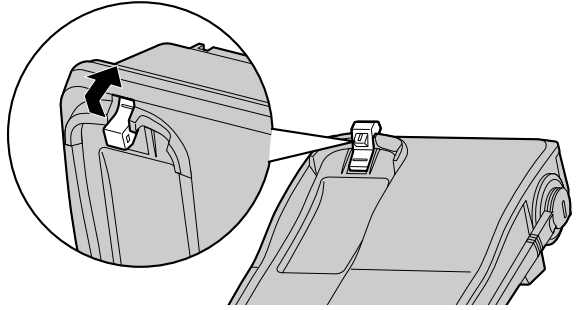

- 2 Press the tabs in the direction of the arrows (①), then remove the wall mounting adaptor (②).

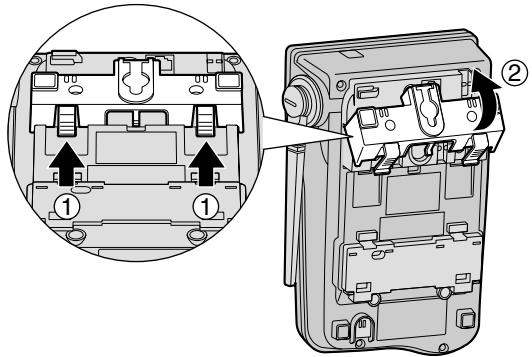

- 3 Connect the AC adaptor. Tuck the telephone line cord inside the wall mounting adaptor, then push it in the direction of the arrow (① and ②).

- The word "UP WALL" should face upward.

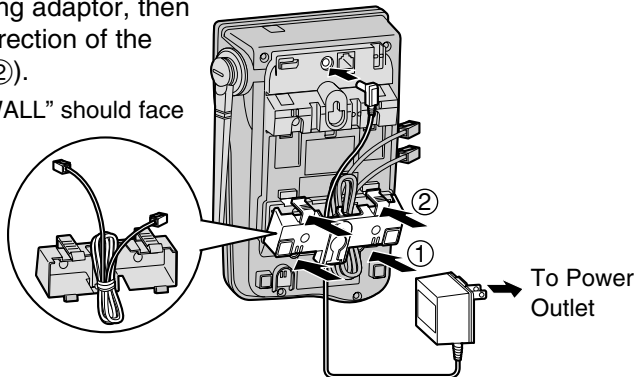



4 Connect the telephone line cord.
Mount the unit, then slide down.

- Raise the antenna.

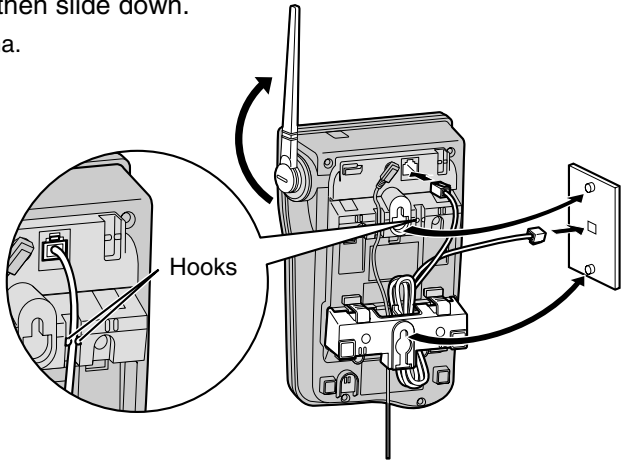

5 **To charge the handset battery:**
Fix the charge contacts (1) and insert
the hook to the handset hole (2).

- The CHARGE indicator lights.

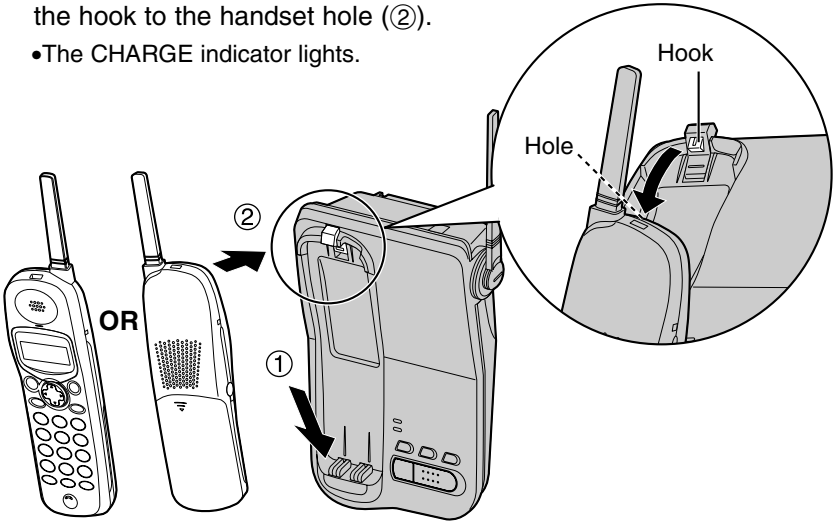

➔ Wall Mounting

Charger unit

The charger can be wall mounted. Connect the AC adaptor. Install screws using the wall template below. Mount the charger (①). Slide it down (②) then slide down to the right (③) until it is secured.

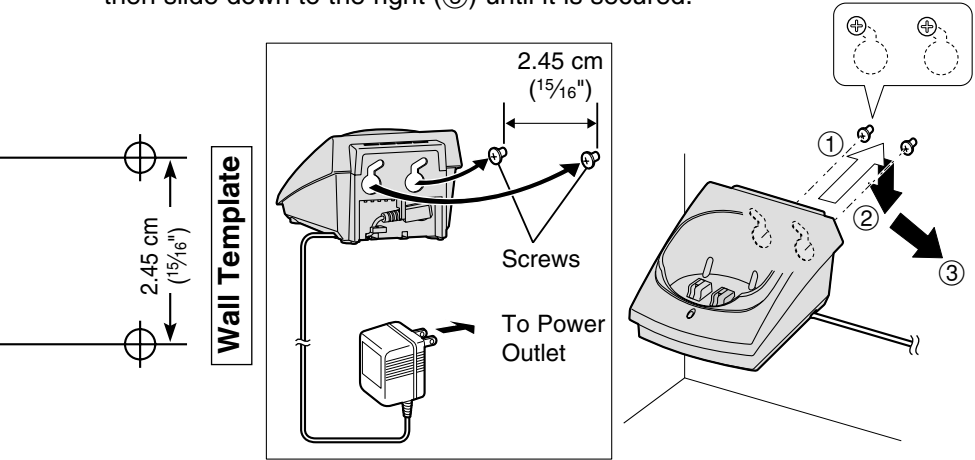

Adding Another Phone

This unit will not function during a power failure. To connect a standard telephone on the same line, use the Panasonic T-adaptor KX-J66. To order, call the accessories telephone number on page 2.

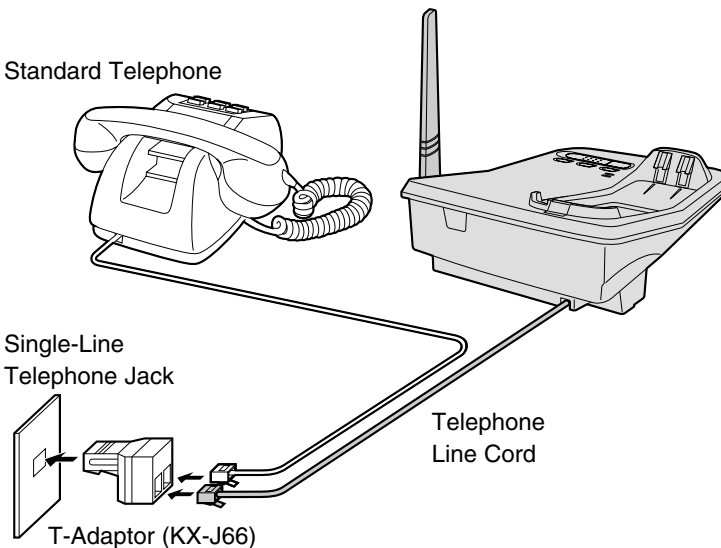

Battery Replacement

If “Recharge” is displayed and/or “{ ■]” flashes after a few telephone calls even if the battery was fully charged, replace the battery with a new Panasonic N4HHGMB00001 (HHR-P103) battery. To order, call the accessories telephone number on page 2.

- 1 Press the notch on the handset cover firmly and slide it as indicated by the arrow.

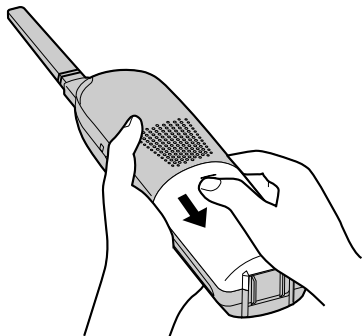

- 2 Remove the old battery and wait for a **few minutes**. And insert the new battery into the handset as shown, matching the correct polarity (①). Press the battery down until it fits securely into the compartment (②).

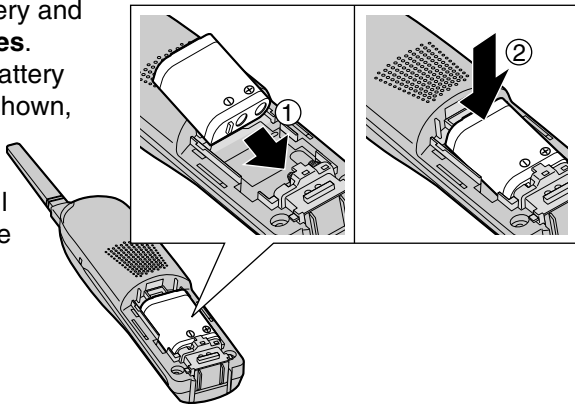

- 3 Close the cover. Make sure the handset display shows “{ ■]”, when you place the handset on the base unit or the charger.
 - If it does not show “{ ■]”, remove the new battery and wait for 10 minutes; and then insert the battery again. Make sure the handset display shows “{ ■]”.
- 4 Charge the new battery for about 15 hours in order to display the battery strength prompt correctly (p. 9, 10).

A nickel metal hydride battery that is recyclable powers the product you have purchased. Please call 1-800-8-BATTERY for information on how to recycle this battery.



Canceling Registration/Re-registration

Canceling the Handset Registration

If you no longer need to use the handset or if you need to register the handset to a different base unit of the same model, it may be necessary to cancel the registration.

Only one handset can be canceled at a time near the base unit to which the handset is currently registered.

Make sure the unit is not being used and the handset is lifted off the base unit.

1 Press **MUTE/FUNCTION**.

2 Scroll to "Initial set" by pressing **▼** or **▲**, and press **▶**.

```
Ringer setting
▶Initial set
-----
```

3 Scroll to "HS register" by pressing **▼** or **▲**, and press **▶**.

```
Voice mail
▶HS register
-----
```

4 Scroll to "Deregistration" by pressing **▼** or **▲**.

```
Registration
▶Deregistration
-----
```

5 Press **▶**.

```
To deregister
press 3,3,5
:--- ▶=Ok
```

6 Press **335** (DEL.) to delete the registration memory.

```
To deregister
press 3,3,5
:335 ▶=Ok
```

•If you make a mistake, press **HOLD/INTERCOM/CLEAR**, and enter "335".

7 Press **▶** (Ok key).

```
Handset [1]
Deregistered
```

- A beep sounds and the registration memory will be erased on both the handset and the base unit.
- If 3 beeps sound, you entered a wrong code. The display will return to step 6. Enter "335".
- To register the handset to another base unit of the same model, start from step 5 on page 55 or see page 19.

•You can exit the programming mode any time by pressing **OFF**.

•The handset will not work. To use it again, registration will be required (p. 19, 55).

Re-registering the Handset

If you want to re-register the handset to the base unit or a different base unit of the same model, you need to register it to that base unit. The handset will be given a new extension number of that base unit. Only one handset can be registered at a time. **Make sure the base unit and the other handsets are not being used. Registration must be completed within 1 minute.**

If you have canceled the handset registration at the previous base unit (p. 54), start from step 5.

1 Handset: Press **[MUTE/FUNCTION]**.

2 Scroll to "Initial set" by pressing **[▼]** or **[▲]**, and press **[▶]**.

```
Ringer setting
▶Initial set
-----
```

3 Scroll to "HS register" by pressing **[▼]** or **[▲]**, and press **[▶]**.

```
Voice mail
▶HS register
-----
```

4 Press **[▶]** at "Registration".

```
-----
▶Registration
Deregistration
```

5 Base unit:
Press and hold **HANDSET LOCATOR [ALL]** until the CHARGE indicator flashes.

```
Press [ALL] on
base for 3 sec,
then press [▶].
```

6 Handset:
① Press **[▶]**.
② Wait until a long beep sounds and the display shows the registered number. The registration will be then complete.

```
Handset
Registering
```

Ex. Extension number 3

```
Handset [3]
Registered
```

•The registered number "[1]" to "[3]" is shown on the top right of the display.

•You can stop registration by pressing **[OFF]** on the handset and pressing **HANDSET LOCATOR [ALL]** on the base unit.

If you have not canceled the handset registration at the previous base unit (p. 54), the handset number still remains on that base unit memory. Erase the handset number from the previous base unit. For KX-TG2352W base unit:
(1) Press and hold **HANDSET LOCATOR [ALL]** until the CHARGE indicator flashes. (2) Press and hold **HANDSET LOCATOR (1 to 3)** of the handset number that you want to erase until the CHARGE indicator flashes, then rapid flashes, then goes out.

If the Following Appear...

If the unit detects a problem, one of the following messages will be displayed on the handset. Error beeps or a busy tone will sound.







Display message	Cause & Remedy
Recharge	The battery needs to be charged. Recharge the battery (p. 9, 10).
Charge for 15h	The battery has been discharged. The handset will not work. Charge the battery fully (p. 9, 10).
No link to base Move closer to base, try again	The handset has lost communication with the base unit. Move closer to the base unit, and try again.
Busy	<ul style="list-style-type: none">• The called handset is in use.• The handset you are calling is too far from the base unit.• If the radio communication between the handset and the base unit is partially impaired, this display will be shown.• If more than one unit is in use, such as conducting an external/internal call, you may not be able to program. Try again later.• You cannot join the conference. A maximum of 2 handsets can take part in a conference call.• While 2 other handsets are making a conference call, you cannot operate the handset. Try again later.
Error!!	When you tried to register or deregister the handset, the handset and the base unit could not link for some reason, such as interference from other electrical appliances. Take the handset and the base unit away from the electrical appliances and try again.

Display message	Cause & Remedy
Directory full	When trying to store an item in the directory, the directory memory is full. To erase other items from the directory, see page 37.
Please lift up and try again.	A handset button was pressed while the handset was on the base unit or the charger. Lift the handset and press the button again.
Invalid	The called handset has not been registered to the base unit or you selected your extension number.
Invalid. Please register to the base.	The handset you tried to make a call has not been registered to the base unit. Register it (p. 19, 55).
All handsets registered. Maximum is 3.	<ul style="list-style-type: none"> • 3 handsets have already been registered to the base unit. To cancel another handset registration, see page 54. • This base unit has the memory of the handset currently registered to another base unit. Erase the handset memory from the base unit. For KX-TG2352W base unit: <ol style="list-style-type: none"> (1) Press and hold HANDSET LOCATOR ALL until the CHARGE indicator flashes. (2) Press and hold HANDSET LOCATOR (1) to (3) of the handset number that you want to erase until the CHARGE indicator flashes, then rapid flashes, then goes out.

Troubleshooting

Problem	Cause & Remedy
The unit does not work.	<ul style="list-style-type: none">•Check the settings (p. 8–10).•Check whether the dialing mode setting is correct (p. 14).•Charge the battery fully (p. 9, 10).•Clean the charge contacts and charge again (p. 10).•Install the battery properly (p. 9).•Unplug the AC adaptor of the base unit to reset. Plug in, and try again.•The handset has not been registered to the base unit. Register the handset (p. 19, 55).•Re-install the battery (p. 53) and charge it fully.
“No link to base Move closer to base, try again” is displayed and an alarm tone sounds.	<ul style="list-style-type: none">•You are too far from the base unit. Move closer to the base unit and try again.•Plug in the AC adaptor of the base unit.•Raise the base unit antenna.
Static, sound cuts in/out, fades. Interference from other electrical units.	<ul style="list-style-type: none">•Locate the handset and the base unit away from other electrical appliances (p. 3).•Move closer to the base unit.•Raise the base unit antenna.
The handset does not ring.	<ul style="list-style-type: none">•The ringer volume is OFF. Set to HIGH or MEDIUM or LOW (p. 17).•While you are making an intercom call, these handsets do not ring. Instead users will hear incoming call tones (p. 49).
The handset display is blank.	<ul style="list-style-type: none">•Charge the battery fully (p. 9, 10).



Problem	Cause & Remedy
You cannot program items, such as the dialing mode.	<ul style="list-style-type: none">•Programming is not possible while the handset is being used.•Do not pause for over 60 seconds while programming.•Move closer to the base unit.•, ,  or  may have been pressed when you picked up the handset. Press OFF and try again.•If more than one other user is using the handsets, you may not be able to program. Try again later.
You cannot store a name and phone number in the directory.	<ul style="list-style-type: none">•You cannot store an item in the directory while the handset is in the talk, speakerphone or intercom mode.•Do not pause for over 60 seconds while storing.
While programming or searching, the handset starts to ring and stops the program/search.	<ul style="list-style-type: none">•To answer the call, press  or . Start again from the beginning after hanging up.
The unit does not display the caller's name and/or phone number.	<ul style="list-style-type: none">•You need to subscribe to a Caller ID service.•Other telephone equipment may be interfering with your phone. Disconnect it and try again.•Other electrical appliances connected to the same outlet may be interfering with the Caller ID information.•Telephone line noise may be affecting the Caller ID information.•The caller requested not to send his/her information. See page 25.•If a call is being transferred to you, the caller information will not be displayed.
The handset display exits the Caller List.	<ul style="list-style-type: none">•Do not pause for over 60 seconds while searching.

➔ Troubleshooting

Problem	Cause & Remedy
<p>You cannot page the handset.</p>	<ul style="list-style-type: none"> •The called handset is too far from the base unit. •The called unit is in use. Try again later. •If more than one other user is using the handsets and base unit, you may not be able to page. Try again later.
<p>You cannot redial by pressing PAUSE/REDIAL on the handset.</p>	<ul style="list-style-type: none"> •If the last number dialed was more than 32 digits long, the number will not be redialed correctly. •The button has a double function as either redial or pause. It will redial the last number dialed if pressed at the outset of a call (p. 22). If another number has been dialed first, it will operate as a pause button (p. 47).
<p>“Recharge” is displayed, “{ ■ }” flashes or the handset beeps intermittently.</p>	<ul style="list-style-type: none"> •Charge the battery fully (p. 9, 10).
<p>“Charge for 15h” is displayed and the handset does not work.</p>	<ul style="list-style-type: none"> •The battery has been discharged. Charge the battery fully (p. 9, 10).
<p>You charged the battery fully, but “Recharge” is still displayed and/or “{ ■ }” continues to flash, or “Charge for 15h” is displayed.</p>	<ul style="list-style-type: none"> •Clean the charge contacts and charge again (p. 10). •Install a new battery (p. 53).
<p>The CHARGE indicator light does not go out after the battery has been charged.</p>	<ul style="list-style-type: none"> •This is normal.
<p>You cannot have a conversation using the headset.</p>	<ul style="list-style-type: none"> •Make sure that an optional headset is connected properly (p. 11). •If “SP-phone” is displayed on the handset, press  to switch to the headset.

Problem	Cause & Remedy
<p>You cannot register the handset at the base unit.</p>	<ul style="list-style-type: none"> •Charge the battery fully (p. 9, 10). •The maximum of 3 handsets have already been registered to the base unit. •This base unit has the memory of the handset currently registered to another base unit. Erase the handset memory from the base unit. •For KX-TG2352W base unit: <ol style="list-style-type: none"> (1) Press and hold HANDSET LOCATOR ALL until the CHARGE indicator flashes. (2) Press and hold HANDSET LOCATOR (1 to 3) of the handset number that you want to erase until the CHARGE indicator flashes, then rapid flashes, then goes out.
<p>If you cannot solve your problem</p>	<ul style="list-style-type: none"> •Call our customer call center at 1-800-211-PANA(7262). •Panasonic's e-mail address for customer inquiries: consumerproducts@panasonic.com for customers in the USA or Puerto Rico ONLY

Important Safety Instructions

When using this unit, basic safety precautions should always be followed to reduce the risk of fire, electric shock, or personal injury.

1. Read and understand all instructions.
2. Follow all warnings and instructions marked on this unit.
3. Unplug this unit from AC outlets before cleaning. Do not use liquid or aerosol cleaners. Use a damp cloth for cleaning.
4. Do not use this unit near water, for example, near a bathtub, washbowl, kitchen sink, or the like.
5. Place this unit securely on a stable surface. Serious damage and/or injury may result if the unit falls.
6. Do not cover slots and openings on the unit. They are provided for ventilation and protection against overheating. Never place the unit near radiators, or in a place where proper ventilation is not provided.
7. Use only the power source marked on the unit. If you are not sure of the type of power supplied to your home, consult your dealer or local power company.
8. Do not place objects on the power cord. Install the unit where no one can step or trip on the cord.
9. Do not overload wall outlets and extension cords. This can result in the risk of fire or electric shock.
10. Never push any objects through slots in this unit. This may result in the risk of fire or electric shock. Never spill any liquid on the unit.
11. To reduce the risk of electric shock, do not disassemble this unit. Take the unit to an authorized servicer when service is required. Opening or removing covers may expose you to dangerous voltages or other risks. Incorrect reassembly can cause electric shock when the unit is subsequently used.
12. Unplug this unit from the wall outlet and refer servicing to an authorized servicer when the following conditions occur:
 - A. When the power supply cord or plug is damaged or frayed.
 - B. If liquid has been spilled into the unit.
 - C. If the unit has been exposed to rain or water.
 - D. If the unit does not work normally by following the operating instructions. Adjust only controls covered by the operating instructions. Improper adjustment may require extensive work by an authorized servicer.
 - E. If the unit has been dropped or physically damaged.
 - F. If the unit exhibits a distinct change in performance.
13. During thunderstorms, avoid using telephones except cordless types. There may be a remote risk of an electric shock from lightning.
14. Do not use this unit to report a gas leak, when in the vicinity of the leak.

SAVE THESE INSTRUCTIONS

CAUTION:

To reduce the risk of fire or injury to persons, read and follow these instructions.

1. Use only the battery(ies) specified.
2. Do not dispose of the battery(ies) in a fire. They may explode. Check with local waste management codes for special disposal instructions.
3. Do not open or mutilate the battery(ies). Released electrolyte is corrosive and may cause burns or injury to the eyes or skin. The electrolyte may be toxic if swallowed.
4. Exercise care in handling batteries in order not to short the battery to conductive materials such as rings, bracelets, and keys. The battery and/or conductor may overheat and cause burns.
5. Charge the battery(ies) provided with or identified for use with this product only in accordance with the instructions and limitations specified in this manual.

WARNING:

TO PREVENT FIRE OR SHOCK HAZARD, DO NOT EXPOSE THIS PRODUCT TO RAIN OR ANY TYPE OF MOISTURE.

- The AC adaptor is used as the main disconnect device, ensure that the AC outlet is located/installed near the unit and is easily accessible.

FCC and Other Information

This equipment complies with Part 68 of the FCC rules and the requirements adopted by the ACTA. On the bottom of this equipment is a label that contains, among other information, a product identifier in the format US:ACJ-----.

If requested, this number must be provided to the telephone company.

Registration No.(found on the bottom of the unit)

Ringer Equivalence No. (REN).....0.1B

A plug and jack used to connect this equipment to the premises wiring and telephone network must comply with the applicable FCC Part 68 rules and requirements adopted by the ACTA. A compliant telephone cord and modular plug is provided with this product. It is designed to be connected to a compatible modular jack that is also compliant.

The REN is used to determine the number of devices that may be connected to a telephone line. Excessive RENs on a telephone line may result in the devices not ringing in response to an incoming call. In most but not all areas, the sum of RENs should not exceed five (5.0). To be certain of the number of devices that may be connected to a line, as determined by the total RENs, contact the local telephone company. For products approved after July 23, 2001, the REN for this product is part of the product identifier that has the format US:AAAEQ##TXXXX. The digits represented by ## are the REN without a decimal point (e.g., 03 is a REN of 0.3).

If this equipment causes harm to the telephone network, the telephone company will notify you in advance that temporary discontinuance of service may be required. But if advance notice isn't practical, the telephone company will notify the customer as soon as possible. Also, you will be advised of your right to file a complaint with the FCC if you believe it is necessary.

The telephone company may make changes in its facilities, equipment, operations or procedures that could affect the operation of the equipment. If this happens the telephone company will provide advance notice in order for you to make necessary modifications to maintain uninterrupted service.

If trouble is experienced with this equipment, for repair or warranty information, please contact a Factory Servicer or other Authorized Servicer. If the equipment is causing harm to the telephone network, the telephone company may request that you disconnect the equipment until the problem is resolved.

Connection to party line service is subject to state tariffs. Contact the state public utility commission, public service commission or corporation commission for information.

If your home has specially wired alarm equipment connected to the telephone line, ensure the installation of this equipment does not disable your alarm equipment. If you have questions about what will disable alarm equipment, consult your telephone company or a qualified installer.



WHEN PROGRAMMING EMERGENCY NUMBERS AND(OR) MAKING TEST CALLS TO EMERGENCY NUMBERS:

- 1) Remain on the line and briefly explain to the dispatcher the reason for the call.
- 2) Perform such activities in the off-peak hours, such as early morning or late evenings.

This device complies with Part 15 of the FCC Rules. Operation is subject to the following two conditions: (1) This device may not cause harmful interference, and (2) this device must accept any interference received, including interference that may cause undesired operation.

Privacy of communications may not be ensured when using this phone.

CAUTION:

Any changes or modifications not expressly approved by the party responsible for compliance could void the user's authority to operate this device.

Note:

This equipment has been tested and found to comply with the limits for a Class B digital device, pursuant to Part 15 of the FCC Rules. These limits are designed to provide reasonable protection against harmful interference in a residential installation. This equipment generates, uses, and can radiate radio frequency energy and, if not installed and used in accordance with the instructions, may cause harmful interference to radio communications. However, there is no guarantee that interference will not occur in a particular installation. If this equipment does cause harmful interference to radio or television reception, which can be determined by turning the equipment off and on, the user is encouraged to try to correct the interference by one or more of the following measures:

- Reorient or relocate the receiving antenna.
- Increase the separation between the equipment and receiver.
- Connect the equipment into an outlet on a circuit different from that to which the receiver is connected.
- Consult the dealer or an experienced radio/TV technician for help.

Some cordless telephones operate at frequencies that may cause interference to nearby TVs and VCRs. To minimize or prevent such interference, the base of the cordless telephone should not be placed near or on top of a TV or VCR. If interference is experienced, move the cordless telephone further away from the TV or VCR. This will often reduce, or eliminate, interference.

Operating near 2.4GHz electrical appliances may cause interference. Move away from the electrical appliances.

➡ FCC and Other Information

CAUTION:

To comply with FCC RF exposure requirements, the base unit should be installed with its antenna located at 20 cm or more from persons and handset should be carried with the specific belt-clip provided for the handset to ensure compliance. Other non-tested belt-clips or similar body-worn accessories may not comply, therefore, should be avoided.

This equipment is hearing aid compatible as defined by the FCC in 47 CFR Section 68.316.

When you hold the phone to your ear, noise might be heard in your Hearing Aid. Some Hearing Aids are not adequately shielded from external RF (radio frequency) energy. If noise occurs, use an optional headset accessory or the speakerphone option (if applicable) when using this phone. Consult with your audiologist or Hearing Aid manufacturer about the availability of Hearing Aids which provide adequate shielding to RF energy commonly emitted by digital devices.

- **Environment** — do not place the unit in a room where the temperature is less than 5°C (41°F) or greater than 40°C (104°F). Allow 10 cm (4") clearance around the unit for proper ventilation. Avoid excessive smoke, dust, mechanical vibration, shock, or direct sunlight.
- **Medical** — consult the manufacturer of any personal medical devices, such as pacemakers or hearing aids, to determine if they are adequately shielded from external RF (radio frequency) energy. (The unit operates in the frequency range of 2400MHz to 2480MHz, and the power output level can range 0.04 watts to 0.40 watts.) Do not use the unit in health care facilities if any regulations posted in the area instruct you not to do so. Hospitals or health care facilities may be using equipment that could be sensitive to external RF (radio frequency) energy.
- **Routine care** — wipe the unit with a soft cloth. Do not use benzine, thinner, or any abrasive powder. When you leave the unit unused for a long period of time, unplug the AC adaptor from the outlet.
- **If there is any trouble** — disconnect the unit from the telephone line and connect a known working phone. If the known working phone operates properly, have your unit repaired by a Factory Servicenter or other Authorized Servicer. If the known working phone does not operate properly, consult your telephone company.

Specifications

■ Base unit

- Power Supply:** AC Adaptor (120 V AC, 60 Hz)
Power Consumption: Standby: Approx. 3.2 W
Maximum: Approx. 6 W
Frequency: 2.40 GHz – 2.48 GHz
Dimensions (H x W x D): Approx. 84 mm x 145 mm x 215 mm
(3 ⁵/₁₆" x 5 ²⁹/₃₂" x 8 ¹⁵/₃₂")
Mass (Weight): Approx. 370 g (0.82 lb.)

■ Charger

- Power Supply:** AC Adaptor (120 V AC, 60 Hz)
Power Consumption: Standby: Approx. 0.8 W
Maximum: Approx. 2.0 W
Dimensions (H x W x D): Approx. 60 mm x 74 mm x 98 mm
(2 ¹¹/₃₂" x 2 ²⁹/₃₂" x 3 ⁷/₈")
Mass (Weight): Approx. 100 g (0.22 lb.)

■ Handset

- Power Supply:** Ni-MH battery (3.6 V, 650 mAh)
Frequency: 2.40 GHz – 2.48 GHz
Dimensions (H x W x D): Approx. 237 mm x 52 mm x 38 mm
(9 ¹¹/₃₂" x 2 ¹/₁₆" x 1 ¹/₂")
Mass (Weight): Approx. 180 g (0.4 lb.)
Security Codes: 1,000,000

■ **Dialing Mode:** Tone (DTMF)/Pulse

■ **Operating Environment:** 5 °C – 40 °C (41 °F – 104 °F)

Specifications are subject to change without notice.

Index

A		I	
Accessories.....	2	Incoming Call Tone.....	49
Answering Calls.....	24	Installation, AC Adaptor.....	8
Auto Talk Feature.....	16, 24	Installation, Adding Another Phone...	52
B		Installation, Battery.....	9
Backlit LCD display.....	23	Installation, Telephone Line Cord.....	8
Base Unit Location.....	3	Intercom call.....	38, 39
Battery Charge.....	3, 9	Intercom paging.....	38, 39
Battery information.....	10	L	
Battery Replacement.....	53	LCD Contrast.....	18
Battery strength.....	10	Lighted handset keypad.....	23
Belt Clip.....	11	Line Mode.....	15
C		Location of Controls.....	6, 7
Call on hold.....	23	M	
Call Waiting Caller ID.....	47	Making Calls.....	20
Call Waiting Tone.....	47	Microphone.....	21
Caller ID Number Auto Edit Feature..	28, 29	MUTE.....	46
Caller ID service.....	25	N	
Caller List, editing.....	28	Noise.....	3
Caller List, erasing.....	31	P	
Caller List, storing.....	30	PAUSE.....	47
Caller List, viewing.....	26	Power failure.....	52
Calling Back from the Caller List.....	27	Pulse service.....	46
Conference call.....	41	R	
D		Redial.....	22
Deregistration.....	54	Redial list.....	22
Dialing Mode.....	14	Registration.....	19, 55
Directory.....	32	Ringer Off.....	17
Directory, dialing.....	35	Ringer Tone.....	49
Directory, editing.....	36	Ringer Volume.....	17
Directory, erasing.....	37	Rotary service, Tone dialing.....	46
Directory, names and symbols.....	34	S	
Directory, storing.....	32	Safety Instructions.....	62
Display.....	56	Shipping product for service.....	71
E		Specifications.....	67
Extension number.....	19, 38	SP-phone.....	21
F		T	
FCC and Other Information.....	64	Transferring a call.....	40
FLASH Button.....	48	Troubleshooting.....	58
Flash time.....	48	V	
Function Menu Table.....	13	VM (Voice Mail Service).....	42
H		Volume control.....	23
Handset Locator.....	46	W	
Headset, optional.....	11	Wall Mounting.....	50
Hold alarm.....	23	Warranty.....	69

**PANASONIC CONSUMER
ELECTRONICS COMPANY, DIVISION
OF MATSUSHITA ELECTRIC
CORPORATION OF AMERICA**
One Panasonic Way
Secaucus, New Jersey 07094

**PANASONIC SALES COMPANY,
DIVISION OF MATSUSHITA
ELECTRIC OF PUERTO RICO, INC.,**
Ave. 65 de Infanteria, Km. 9.5
San Gabriel Industrial Park
Carolina, Puerto Rico 00985

Panasonic Telephone Products Limited Warranty

Limited Warranty Coverage

If your product does not work properly because of a defect in materials or workmanship, Panasonic Consumer Electronics Company or Panasonic Sales Company (collectively referred to as "the warrantor") will, for the length of the period indicated on the chart below, which starts with the date of original purchase ("warranty period"), at its option either (a) repair your product with new or refurbished parts, or (b) replace it with a new or a refurbished product. The decision to repair or replace will be made by the warrantor.

**Parts
One (1) Year**

**Labor
One (1) Year**

During the "Labor" warranty period there will be no charge for labor. During the "Parts" warranty period, there will be no charge for parts. You must mail-in your product during the warranty period. This Limited Warranty excludes both parts and labor for batteries, antennas, and cosmetic parts (cabinet). This warranty only applies to products purchased and serviced in the United States or Puerto Rico. This warranty is extended only to the original purchaser of a new product which was not sold "as is".

Mail-In Service

For assistance in the continental U.S.A. in obtaining repairs please ship the product to:

**Panasonic Services Company
Customer Servicerter
Suite B
4900 George McVay Drive
McAllen, TX 78503**

For assistance in Puerto Rico call Panasonic Sales Company (787)-750-4300 or fax (787)-768-2910.

When shipping the unit carefully pack and send it prepaid, adequately insured and preferably in the original carton. Include a letter detailing the complaint and provide a day time phone number where you can be reached.

IF REPAIR IS NEEDED DURING THE WARRANTY PERIOD THE PURCHASER WILL BE REQUIRED TO FURNISH A SALES RECEIPT/PROOF OF PURCHASE INDICATING DATE OF PURCHASE, AMOUNT PAID AND PLACE OF PURCHASE. CUSTOMER WILL BE CHARGED FOR THE REPAIR OF ANY UNIT RECEIVED WITHOUT SUCH PROOF OF PURCHASE.

Limited Warranty Limits And Exclusions

This warranty ONLY COVERS failures due to defects in materials or workmanship, and DOES NOT COVER normal wear and tear or cosmetic damage. The warranty ALSO DOES NOT COVER damages which occurred in shipment, or failures which are caused by products not supplied by the warrantor, or failures which result from accidents, misuse, abuse, neglect, mishandling, misapplication, alteration, faulty installation, set-up adjustments, misadjustment of consumer controls, improper maintenance, power line surge, lightning damage, modification, introduction of sand, humidity or liquids, commercial use such as hotel, office, restaurant, or other business or rental use of the product, or service by anyone other than a Factory Servicerter or other Authorized Servicer, or damage that is attributable to acts of God.

THERE ARE NO EXPRESS WARRANTIES EXCEPT AS LISTED UNDER "LIMITED WARRANTY COVERAGE". THE WARRANTOR IS NOT LIABLE FOR INCIDENTAL OR CONSEQUENTIAL DAMAGES RESULTING FROM THE USE OF THIS PRODUCT, OR ARISING OUT OF ANY BREACH OF THIS WARRANTY. (As examples, this excludes damages for lost time, lost calls or messages, cost of having someone remove or re-install an installed unit if applicable, travel to and from the servicer. The items listed are not exclusive, but are for illustration only.) ALL EXPRESS AND IMPLIED WARRANTIES, INCLUDING THE WARRANTY OF MERCHANTABILITY, ARE LIMITED TO THE PERIOD OF THE LIMITED WARRANTY.

Some states do not allow the exclusion or limitation of incidental or consequential damages, or limitations on how long an implied warranty lasts, so the exclusions may not apply to you.

This warranty gives you specific legal rights and you may also have other rights which vary from state to state. If a problem with this product develops during or after the warranty period, you may contact your dealer or Servicenter. If the problem is not handled to your satisfaction, then write to the warrantor's Consumer Affairs Department at the addresses listed for the warrantor.

PARTS AND SERVICE, WHICH ARE NOT COVERED BY THIS LIMITED WARRANTY, ARE YOUR RESPONSIBILITY.

Customer Services Directory

For Product Information, Operating Assistance, Literature Request, Dealer Locations, and all Customer Service inquiries please contact: 1-800-211-PANA (7262), Monday-Friday 9 am-9 pm; Saturday-Sunday 9 am-7 pm, EST. or send e-mail : consumerproducts@panasonic.com

***Web Site: <http://www.panasonic.com>
You can purchase parts, accessories or locate your nearest servicenter by visiting our Web Site.***

Accessory Purchases:

**1-800-332-5368 (Customer Orders Only)
Panasonic Services Company 20421 84th Avenue South, Kent, WA 98032
(6 am to 5 pm Monday - Friday; 6 am to 10:30 am Saturday; PST)
(Visa, MasterCard, Discover Card, American Express, Check)**

***Service in Puerto Rico
Matsushita Electric of Puerto Rico, Inc. Panasonic Sales Company/
Factory Servicenter:
Ave. 65 de Infantería, Km. 9.5, San Gabriel Industrial Park,
Carolina, Puerto Rico 00985
Phone (787)750-4300 Fax (787)768-2910***

For product service

- Call 1-800-211-PANA(7262) for the location of an authorized servicer.
- Panasonic's e-mail address for customer inquiries:
consumerproducts@panasonic.com
for customers in the USA or Puerto Rico ONLY

When you ship the product

- Carefully pack your unit, preferably in the original carton.
- Attach a letter, detailing the symptom, to the outside of the carton.

Symptom

- Send the unit to an authorized servicer, prepaid and adequately insured.
- Do not send your unit to the Panasonic Consumer Electronics Company listed on the back cover or to executive or regional sales offices. These locations do not repair consumer products.

For your future reference

Serial No. _____

(found on the bottom of the unit)

Date of purchase _____

Name and address of dealer _____

- This cordless telephone is designed for use in the United States of America. Sale or use of this product in other countries may violate local laws.
- Ce téléphone sans fil est conçu pour être utilisé aux États-Unis d'Amérique. La vente ou l'emploi de cet appareil dans certains autres pays peut constituer une infraction à la législation locale.
- Este teléfono sin cordón fue elaborado para uso en los Estados Unidos de América. La venta o el empleo de este producto en ciertos países puede constituir violación de la legislación local.
- このコードレス電話機は、日本国外での使用を目的として設計されており、日本国内での使用は法律違反となります。従って、当社では日本国内においては原則として修理などのサービスは致しかねます。

**If you need assistance with the set-up or operation,
please call 1-800-211-PANA(7262)**

**Panasonic Consumer Electronics Company,
Division of Matsushita Electric Corporation of America**
One Panasonic Way, Secaucus, New Jersey 07094

**Panasonic Sales Company,
Division of Matsushita Electric of Puerto Rico, Inc.**
Ave. 65 de Infantería, Km. 9.5, San Gabriel Industrial Park
Carolina, Puerto Rico 00985