

# Panasonic

2.4GHz Cordless Phone

Model No. **KX-TG2403B**

Pulse-or-tone dialing capability

## Operating Instructions



**PLEASE READ BEFORE USE  
AND SAVE.**

**Charge the battery for about  
6 hours before initial use.**

### Contents by Section

- 1 Getting Started
- 2 Making/Answering Calls
- 3 Speed Dialer
- 4 One-Touch Dialer
- 5 Special Features
- 6 Things You Should Know
- 7 Referencia rápida

**Panasonic World Wide Web address: <http://www.panasonic.com>**  
for customers in the USA or Puerto Rico

**Attach your purchase receipt here.**

### For your future reference

Serial No. \_\_\_\_\_

Date of purchase \_\_\_\_\_

(found on the bottom of the unit)

Name and address of dealer \_\_\_\_\_

### For product service

- Panasonic Servicenters are listed in the servicenter directory.
- Call 1-800-211-PANA(7262) for the location of an authorized servicenter.
- Panasonic's e-mail address for customer inquiries:  
[consumerproducts@panasonic.com](mailto:consumerproducts@panasonic.com)  
for customers in the USA or Puerto Rico ONLY

### When you ship the product

- Carefully pack your unit, preferably in the original carton.
- Attach a letter, detailing the symptom, to the outside of the carton.

Symptom \_\_\_\_\_

- Send the unit to an authorized servicenter, prepaid and adequately insured.
- Do not send your unit to the Panasonic Consumer Electronics Company listed below or to executive or regional sales offices. These locations do not repair consumer products.

**Panasonic Consumer Electronics Company,  
Division of Matsushita Electric Corporation of America**  
One Panasonic Way, Secaucus, New Jersey 07094

**Panasonic Sales Company,  
Division of Matsushita Electric of Puerto Rico, Inc.**  
Ave. 65 de Infantería, Km. 9.5, San Gabriel Industrial Park  
Carolina, Puerto Rico 00985

# 1 Getting Started



## 1-A Accessories

- AC Adaptor .....one  
Order No. PQLV1Z

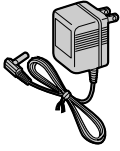

- Telephone Line Cord  
.....one



- Belt Clip .....one  
Order No. PQKE10127Z1



- Wall Mounting Adaptor ..one  
Order No. PQKL10038Z3

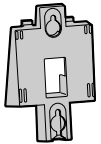

• For extra orders, call 1-800-332-5368.

## 1-B Location of Controls

### Handset

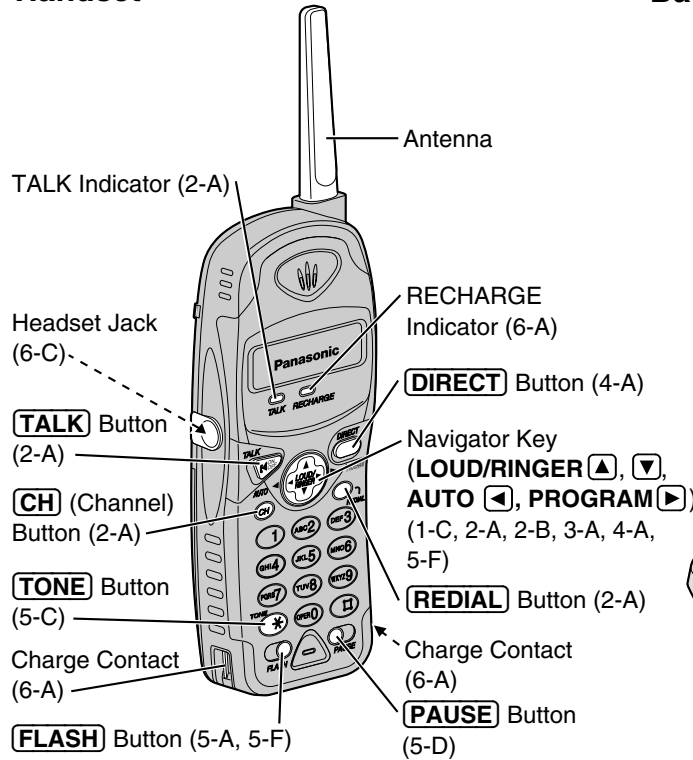

### Base unit

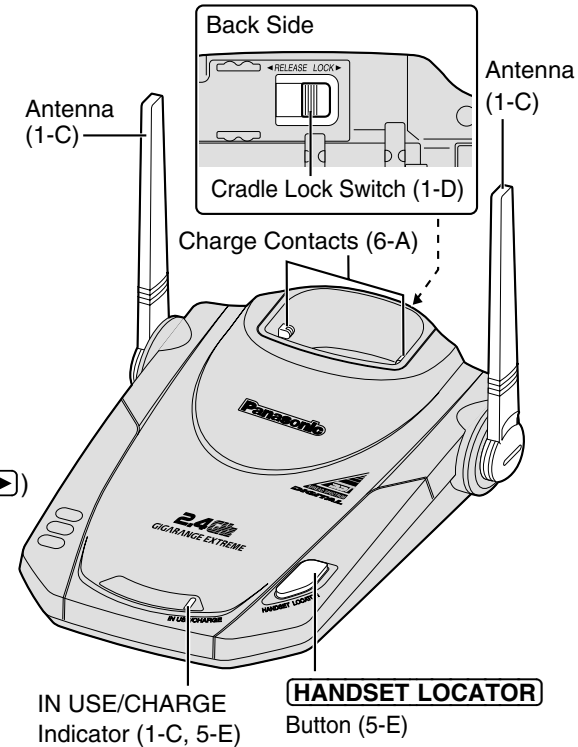

## 1-C Settings

### 1 Connect as shown.

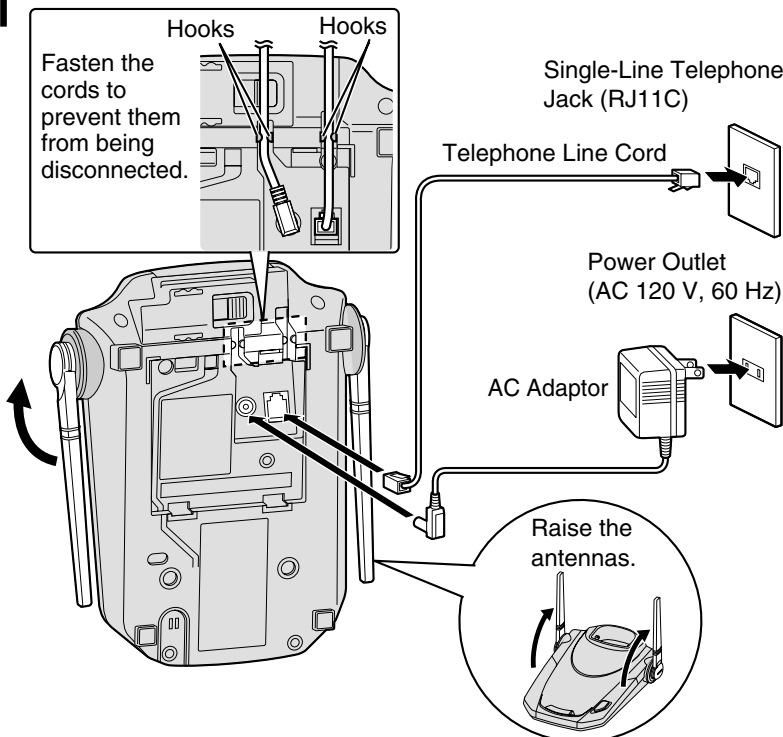

- USE ONLY WITH Panasonic AC ADAPTOR PQLV1 (Order No. PQLV1Z).
- The AC adaptor must remain connected at all times. (It is normal for the adaptor to feel warm during use.)
- To connect a standard telephone on the same line, see section 6-G.

### 2 Raise the antennas.



### 3 Charge the battery for 6 hours.

- See section 6-A for more details.
- The IN USE/CHARGE indicator lights.

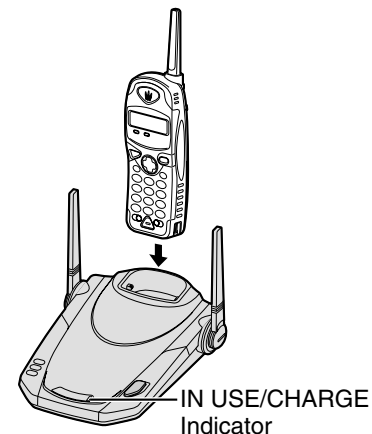

### To select the dialing mode TONE (preset) or PULSE

You can program the dialing mode using the handset near the base unit. The TALK indicator light must be off before programming.

Press **PROGRAM** ▶ → **AUTO** ◀ → # twice (PULSE) OR \* twice (TONE)

→ **PROGRAM** ▶.

- To cancel during programming, press **PROGRAM** ▶. Start again from the beginning.
- If 3 beeps sound during programming, a wrong key was pressed. Start again from the beginning.

## 1-D Wall Mounting

This unit can be mounted on a wall phone plate.

## 1 Adjust the angle of the cradle:

- ① Slide the lock switch to "RELEASE".
- ② Rotate the cradle 90° until it faces straight up.
- ③ Slide the lock switch to "LOCK" with the cradle facing straight up.

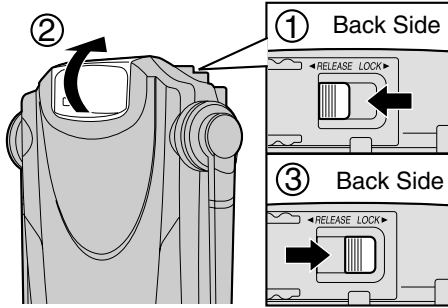

## 2 Connect the AC adaptor.

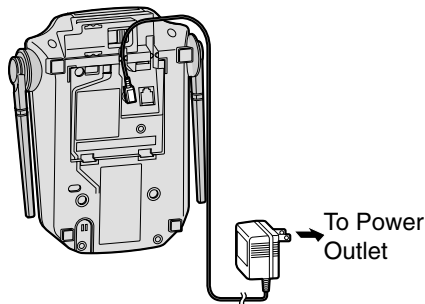

## 3 ① Tuck the telephone line cord inside the wall mounting adaptor.

- ② Connect the telephone line cord to the unit.
- ③ Install the adaptor by pushing it in the direction of the arrow.
  - The word "UP" should face upward.

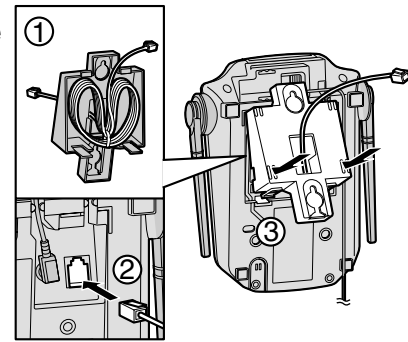

## 4 Connect the telephone line cord. Mount the unit, then slide down.

- Raise the antennas.

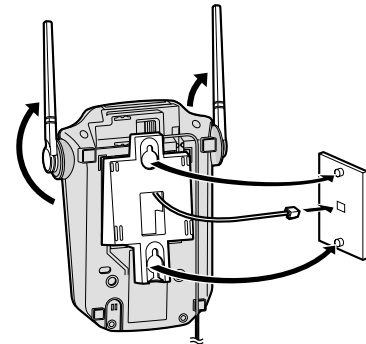

## 2 Making/Answering Calls

## 2-A Making Calls

- 1 Press **TALK**.
  - The TALK indicator lights.
  - If an alarm tone sounds, see 6-F.
- 2 Dial a phone number.
- 3 To hang up, press **TALK** or place the handset on the base unit.
  - The indicator light goes out.

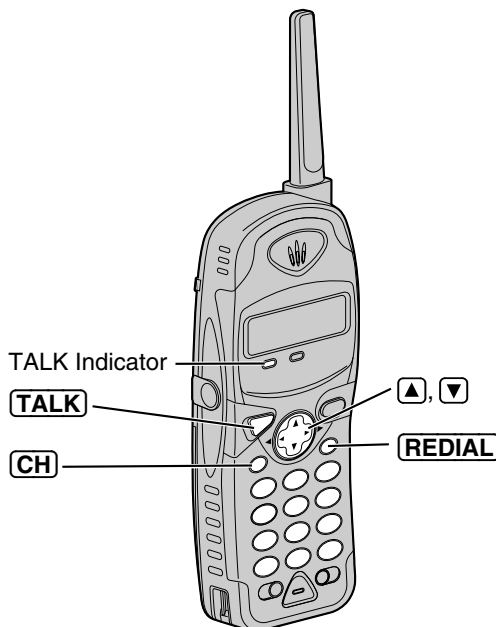

- For best operating performance, see section 6-D.

**To redial the last number dialed**

Press **TALK** → **REDIAL**.

**To select the receiver volume**

3 levels (HIGH, MEDIUM, LOW) are available. Press ▲ or ▼ while talking.

- Each time you press ▲ or ▼, the volume level will change.

**If noise interferes with the conversation**

Press **CH** to select a clearer channel or move closer to the base unit.

## 2-B Answering Calls

If the handset is off the base unit, press **TALK**.

- You can also answer a call by pressing any dialing button 0 to 9, \* or # (— Any Key Talk).

**OR**

If on the base unit, just lift up.

**Selecting the ringer volume**

The TALK indicator light must be off.

- To select **HIGH** (preset) or **LOW**, press ▲ or ▼. Each time you press ▲ or ▼, the ringer volume will change and the selected volume will ring.
- To turn the ringer **OFF**, press and hold ▼ until 2 beeps sound.
- To turn the ringer **ON**, press ▲. The ringer will sound at the HIGH level.
- When you replace the battery, the selected ringer volume setting will return to the factory set.

### 3-A Storing Phone Numbers in Memory

You can store up to 10 phone numbers in the handset. The dialing buttons (0 to 9) function as memory stations. **The TALK indicator light must be off before programming.**

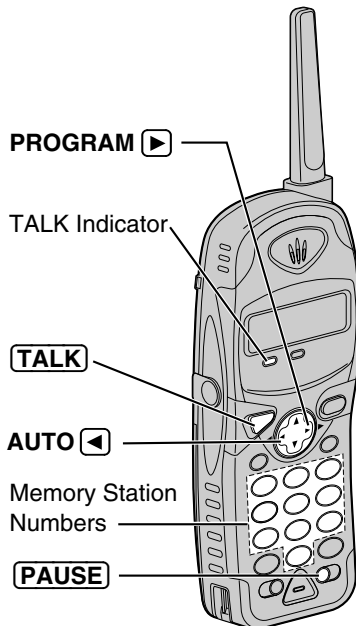

- 1 Press **PROGRAM** .
  - The TALK indicator flashes.
- 2 Enter a phone number up to 22 digits.
- 3 Press **AUTO** .
- 4 Press a memory station number (0 to 9).
  - A beep sounds.
  - To store other numbers, repeat steps 1 through 4.

#### If you misdial

Press **PROGRAM** to end storing. →  
→ Start again from step 1.

#### To erase a stored number

Press **PROGRAM** → **AUTO** →  
→ the memory station number (0 to 9)  
for the phone number to be erased.  
•A beep sounds.

•If a pause is required for dialing, press **PAUSE** where needed. Pressing **PAUSE** counts as one digit (5-D).

### 3-B Dialing a Stored Number

Press **TALK** → **AUTO** → the memory station number (0 to 9).

•If your line has rotary or pulse service, any access numbers stored after pressing **TONE** will not be dialed.

## 5 Special Features

### 5-A For Call Waiting Service Users

Press **FLASH** if you hear a call-waiting tone while talking.

- The first call is put on hold and you can answer the second call.
- To return to the first caller, press **FLASH** again.
- If this function does not operate properly, consult your telephone company for details.

### 5-B Automatic Security Code Setting

Whenever you place the handset on the base unit, the unit automatically selects one of more than a million security codes. These codes help prevent the unauthorized use of your telephone line by another cordless telephone user.

### 5-C Temporary Tone Dialing (For Rotary or Pulse Service Users)

Press **TONE** before entering access numbers which require tone dialing.

- The dialing mode changes to tone. You can enter numbers to access an answering service, electronic banking service, etc. When you hang up, the mode will return to pulse.
- Access numbers entered after pressing **TONE** will not be included when redialing.

### 5-D How to use the PAUSE Button (For Analog PBX Line/Long Distance Service Users)

We recommend you press **PAUSE** if a pause is required for dialing with a PBX or to access a long distance service.

Ex: Line access number 9 (PBX)

9 → **PAUSE** → Phone number

- Pressing **PAUSE** once creates a 3.5 second pause. This prevents misdialing when you redial or dial a stored number.
- Pressing **PAUSE** more than once increases the length of the pause between numbers.

### 5-E Handset Locator

You can locate the handset or page the handset user with beep tones.



- 1 Press **HANDSET LOCATOR** on the base unit.
  - The IN USE/CHARGE indicator flashes and the handset beeps for 1 minute.
- 2 To stop paging, press **HANDSET LOCATOR** again or press **TALK** twice on the handset.

## 4-A Storing a Phone Number in the DIRECT Button

You can store a phone number in the **DIRECT** button. The stored number is dialed with a one-touch operation.

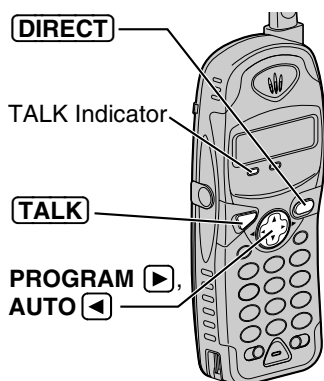
**The TALK indicator light must be off before programming.**



- 1** Press **PROGRAM** .
  - The TALK indicator flashes.
- 2** Enter a phone number up to 22 digits.
  - If you misdial, press **PROGRAM** , and start again from step 1.
- 3** Press **DIRECT**.
  - A beep sounds.

•If a pause is required for dialing, press **PAUSE** where needed. Pressing **PAUSE** counts as one digit (5-D).

## 4-B Dialing a Stored Number in the DIRECT Button

Press **TALK**  **DIRECT**.

•If your line has rotary or pulse service, any access numbers stored after pressing **TONE** will not be dialed.

**To erase a stored number:** press **PROGRAM**   **AUTO**   **DIRECT**.

## Special Features

## Section 5





### 5-F FLASH Button

Pressing **FLASH** allows you to use special features of your host PBX such as transferring an extension call or accessing special telephone services (optional), such as call waiting.

#### Selecting the flash time

The flash time depends on your telephone exchange or host PBX. You can select the following flash times: “90, 100, 110, 250, 300, 400, 600, 700 msec (milliseconds)”, **using the handset near the base unit**. Your phone comes from the factory set to “700 msec”.

**The TALK indicator light must be off before programming.**

Press **PROGRAM**   **Dialing button (1 to 8)**  **AUTO**   **FLASH**.

- |                     |                     |                     |
|---------------------|---------------------|---------------------|
| <b>1</b> : 90 msec  | <b>2</b> : 100 msec | <b>3</b> : 110 msec |
| <b>4</b> : 250 msec | <b>5</b> : 300 msec | <b>6</b> : 400 msec |
| <b>7</b> : 600 msec | <b>8</b> : 700 msec |                     |

- If 3 beeps sound after programming, a wrong key was pressed. Start again from the beginning.
- If you are connected via a PBX, a longer flash time may be necessary to use PBX functions (transferring a call, etc.). Consult your PBX installer for the correct setting.

# 6 Things You Should Know



## 6-A Battery

### Recharge

When the RECHARGE indicator flashes or the unit beeps intermittently, place the handset on the base unit to recharge the battery for 6 hours.

- If you DO NOT recharge the handset battery for more than 15 minutes, the RECHARGE indicator will continue to flash.

RECHARGE Indicator



### Battery information

After your Panasonic battery is fully charged:

Operation		Approx. battery life
While in use (TALK)	near the base unit*	Up to 4.5 hours
	away from the base unit	Up to 3.5 hours
While not in use (Standby)		Up to 11 days

\*Within about 10 feet (3 m)

- Battery life may vary depending on usage conditions and ambient temperature.
- Clean the handset and the base unit charge contacts with a soft dry cloth once a month. Clean more often if the unit is subject to grease, dust or high humidity. Otherwise, the battery may not charge properly.
- If the battery is fully charged, you do not have to place the handset on the base unit until the RECHARGE indicator flashes. This will maximize the battery life.
- The battery cannot be overcharged.

## 6-B Belt Clip

You can hang the handset on your belt or pocket using the belt clip.

### To attach the belt clip

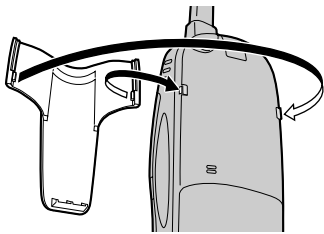

### To remove the belt clip



## 6-C Optional Headset

Plugging an optional headset into the handset allows a hands-free phone conversation. Please use only the Panasonic KX-TCA88 headset. To order, call the accessories telephone number in section 1-A.

### Connecting the optional headset to the handset

Open the headset jack cover, and connect the optional headset to the headset jack as shown.

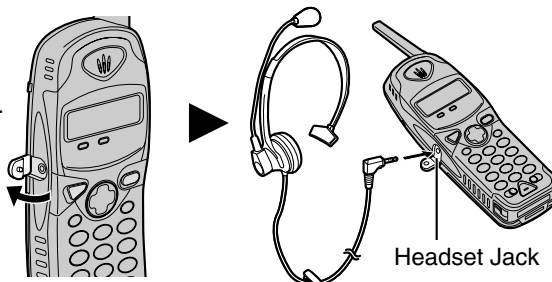

When the optional headset is connected to the handset, make sure to use the headset to talk with the caller. If you want to have a normal cordless phone conversation, disconnect the headset.

## 6-D Base Unit Location/Noise

Calls are transmitted between the base unit and the handset using wireless radio waves. For maximum distance and noise free operation, the recommended base unit location is:

Away from electrical appliances such as a TV, personal computer or another cordless phone.

In a HIGH and CENTRAL location with no obstructions such as walls.

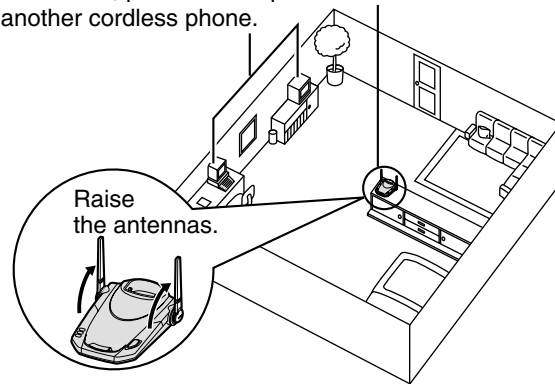

### Note:

While using the handset:

- If you are near a microwave oven which is being used, noise may be heard at the receiver. Move away from the microwave oven and closer to the base unit.
- If more than one cordless phone is being used and your handset is near another cordless phone's base unit, noise may be heard. Move away from the other cordless phone's base unit and closer to your base unit.

## 6-E Battery Replacement

If the RECHARGE indicator flashes after being fully charged, replace the battery with a new Panasonic P-P510 (N4HKGMB00001) battery. To order, call the accessories telephone number in section 1-A.

- 1 Carefully insert a flat metal object in the slot, and push forward to release the lock. Remove the cover.

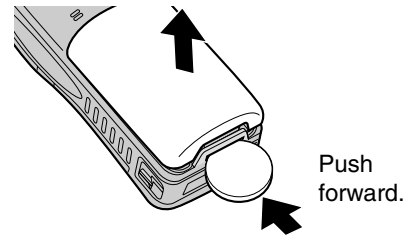

- 2 Replace the battery. Place the battery leads inside the groove, otherwise the leads may be damaged when closing the cover.

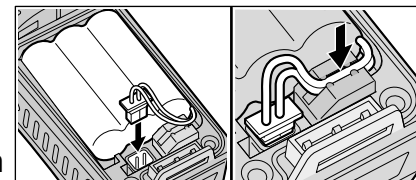

- 3 Close the cover. Make sure to charge the new battery for 6 hours.

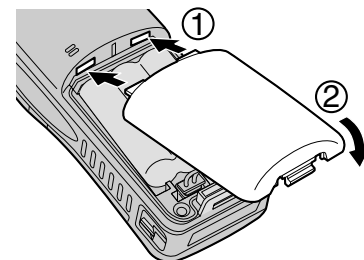

### Attention:

The product you have purchased is powered by a nickel cadmium battery which is recyclable. At the end of its useful life, under various state and local laws, it is illegal to dispose of this battery into your municipal waste stream. Please call 1-800-8-BATTERY for information on how to recycle this battery.



## 6-F Before Requesting Help

Problem	Remedy
The unit does not work.	<ul style="list-style-type: none"> <li>•Check the settings (1-C).</li> <li>•Charge the battery fully (6-A).</li> <li>•Clean the charge contacts and charge again (6-A).</li> <li>•Install the battery properly (6-E).</li> <li>•Place the handset on the base unit and unplug the AC adaptor to reset. Plug in, and try again.</li> <li>•Re-install the battery and place the handset on the base unit. Try again.</li> </ul>
An alarm tone sounds.	<ul style="list-style-type: none"> <li>•You are too far from the base unit. Move closer and try again.</li> <li>•Place the handset on the base unit and try again.</li> <li>•Plug in the AC adaptor.</li> <li>•Raise the base unit antennas.</li> </ul>
Static, sound cuts in/out, fades. Interference from other electrical units.	<ul style="list-style-type: none"> <li>•Locate the handset and the base unit away from other electrical appliances (6-D).</li> <li>•Move closer to the base unit.</li> <li>•Raise the base unit antennas.</li> <li>•Press <b>[CH]</b> to select a clearer channel.</li> </ul>
The unit does not ring.	<ul style="list-style-type: none"> <li>•The ringer volume is set to OFF. Press <b>[▲]</b> or <b>[▼]</b> while the TALK indicator light is off (2-B).</li> </ul>
While storing a phone number, the unit starts to ring.	<ul style="list-style-type: none"> <li>•To answer the call, press <b>[TALK]</b>. The program will be canceled. Store the number again.</li> </ul>
You cannot store a phone number in memory.	<ul style="list-style-type: none"> <li>•You cannot store a number while the unit is in the talk mode.</li> <li>•Do not pause for over 60 seconds while storing.</li> </ul>
Previously programmed information is erased.	<ul style="list-style-type: none"> <li>•If a power failure occurs, programmed information may be erased. Reprogram if necessary.</li> </ul>
You cannot redial by pressing <b>[REDIAL]</b> .	<ul style="list-style-type: none"> <li>•If the last number dialed was more than 32 digits long, the number will not be redialed correctly.</li> </ul>
<b>[HANDSET LOCATOR]</b> does not function.	<ul style="list-style-type: none"> <li>•The handset is too far from the base unit or is engaged in an outside call.</li> </ul>
The RECHARGE indicator flashes or the unit beeps intermittently.	<ul style="list-style-type: none"> <li>•Charge the battery fully (6-A).</li> </ul>
You charged the battery fully, but the RECHARGE indicator flashes.	<ul style="list-style-type: none"> <li>•Clean the charge contacts and charge again (6-A).</li> <li>•Install a new battery (6-E).</li> </ul>
The IN USE/CHARGE indicator light does not go out while charging.	<ul style="list-style-type: none"> <li>•This is normal.</li> </ul>
If you cannot solve your problem.	<ul style="list-style-type: none"> <li>•Call our customer call center at 1-800-211-PANA(7262).</li> <li>•Panasonic's e-mail address for customer inquiries: <a href="mailto:consumerproducts@panasonic.com">consumerproducts@panasonic.com</a> for customers in the USA or Puerto Rico ONLY</li> </ul>

## 6-G Adding Another Phone

This unit will not function during a power failure. To connect a standard telephone on the same line, use the Panasonic T-adaptor KX-J66. To order, call the accessories telephone number in section 1-A.

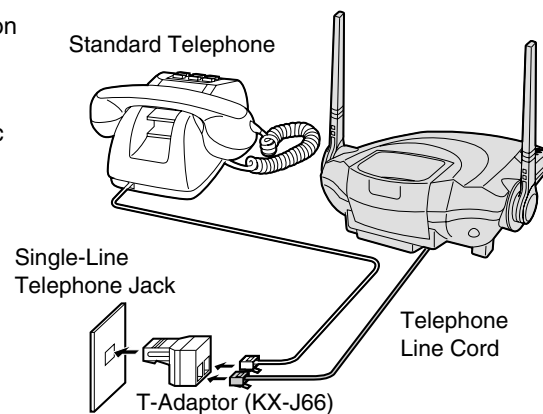

## 6-H Helpful Information

Operating near 2.4GHz electrical appliances may cause interference. Move away from the electrical appliances and/or press the CH (Channel) button. The AC adaptor is used as the main disconnect device, ensure that the AC outlet is located/installed near the unit and is easily accessible.

- **Environment**—do not place the unit in a room where the temperature is less than 5°C (41°F) or greater than 40°C (104°F). Allow 10 cm (4") clearance around the unit for proper ventilation. Avoid excessive smoke, dust, mechanical vibration, shock, or direct sunlight.
- **Medical**—consult the manufacturer of any personal medical devices, such as pacemakers, to determine if they are adequately shielded from external RF (radio frequency) energy. (The unit operates in the frequency range of 2401MHz to 2472MHz, and the power output level can range from 0.001 watts to 0.20 watts.) Do not use the unit in health care facilities if any regulations posted in the area instruct you not to do so. Hospitals or health care facilities may be using equipment that could be sensitive to external RF (radio frequency) energy.
- **Routine care**—wipe the unit with a soft cloth. Do not use benzine, thinner, or any abrasive powder. When you leave the unit unused for a long period of time, unplug the AC adaptor from the outlet.
- **If there is any trouble**—disconnect the unit from the telephone line and connect a known working phone. If the known working phone operates properly, have your unit repaired by one of the authorized Panasonic Factory Service Centers. If the known working phone does not operate properly, consult your telephone company.

### Caution:

To comply with FCC RF exposure requirements, the base unit should be installed with its antenna located at 20 cm or more from persons and handset should be carried with the specific belt-clip provided for the handset to ensure compliance. Other non-tested belt-clips or similar body-worn accessories may not comply, therefore, should be avoided.

### Shock-Resistant (HANDSET ONLY)

Although the handset is designed to be shock resistant, do not throw or step on the handset.

- This cordless telephone is designed for use in the United States of America. Sale or use of this product in other countries may violate local laws.
- Ce téléphone sans fil est conçu pour être utilisé aux États-Unis d'Amérique. La vente ou l'emploi de cet appareil dans certains autres pays peut constituer une infraction à la législation locale.
- Este teléfono sin cordón fue elaborado para uso en los Estados Unidos de América. La venta o el empleo de este producto en ciertos países puede constituir violación de la legislación local.
- このコードレス電話機は、日本国外での使用を目的として設計されており、日本国内での使用は法律違反となります。従って、当社では日本国内においては原則として修理などのサービスは致しかねます。

## 7-A Preparación

**1** Conecte como se muestra.

Toma telefónica de una sola línea

Toma de corriente

Levante las antenas.

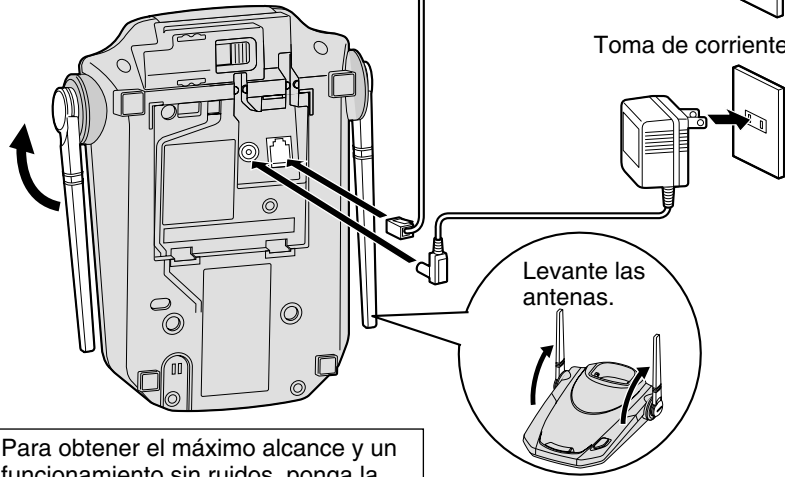

Para obtener el máximo alcance y un funcionamiento sin ruidos, ponga la unidad base en un lugar ELEVADO y CÉNTRICO sin obstrucciones ni interferencias de aparatos eléctricos.

- El adaptador de CA debe permanecer conectado en todo momento.
- Para instalar la presilla para el cinturón o un auricular opcional (n.º de pedido KX-TCA88), consulte la sección 6-B o 6-C.

**2** Levante las antenas.

**3** Cargue la batería durante 6 horas.

- El indicador IN USE/CHARGE se encenderá.

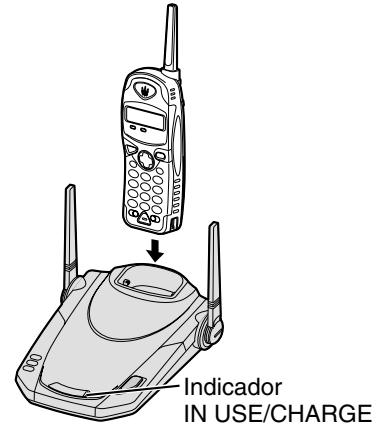

### Selección del modo de marcación por TONO (preajustado) o PULSACIÓN

Utilizando la unidad portátil cerca de la unidad base usted puede programar el modo de marcación. El indicador TALK deberá estar apagado antes de programar.

Presione **PROGRAM** **AUTO** dos veces (PULSACIÓN) dos veces (TONO) **PROGRAM** .

## 7-B Funcionamiento

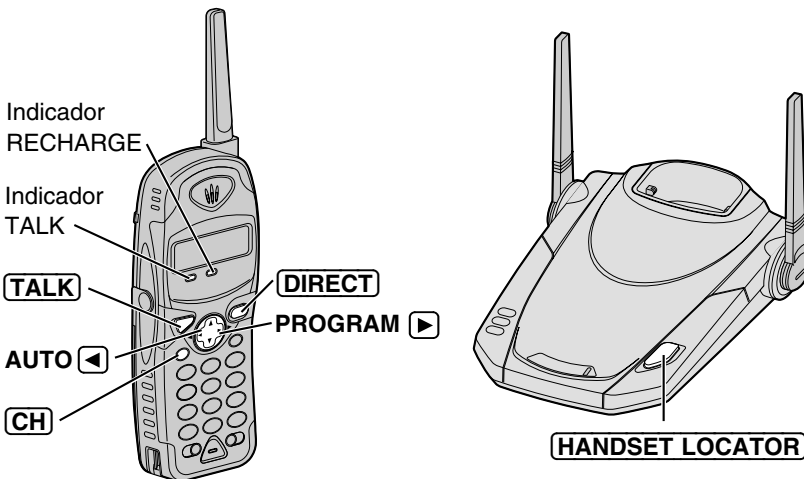

- Cuando el indicador RECHARGE parpadee o la unidad emita pitidos intermitentemente, cargue la batería.

### Para hacer llamadas

Presione **TALK**. Marque un número de teléfono. Para colgar, presione **TALK** o ponga la unidad portátil en la unidad base.

- Si interfiere ruido con su conversación, presione **CH** para seleccionar un canal más claro o acérquese a la unidad base.

### Contestación de llamadas

Si la unidad portátil no está en la unidad base, presione **TALK** o cualquier botón de marcación (**0** a **9**, **\*** o **#**).

Si está en la unidad base, levántela solamente.

### Marcación rápida

Se pueden memorizar hasta 10 números de teléfono en la unidad portátil. Los botones de marcación (**0** a **9**) funcionan como estaciones de memoria. El indicador TALK deberá estar apagado antes de programar.

#### Para almacenar números de teléfono en la memoria

Presione **PROGRAM** Número de teléfono (hasta 22 dígitos) **AUTO** Número de estación.

#### Para marcar un número almacenado

Presione **TALK** **AUTO** Número de estación.

### Marcación de un toque

El número de teléfono almacenado en el botón **DIRECT** se puede marcar con la operación de un toque. El indicador TALK deberá estar apagado antes de programar.

#### Para almacenar un número de teléfono en el botón DIRECT

Presione **PROGRAM** Número de teléfono (hasta 22 dígitos) **DIRECT**.

#### Para marcar el número almacenado en el botón DIRECT

Presione **TALK** **DIRECT**.

### Localización de la unidad portátil

Presione **HANDSET LOCATOR** en la unidad base.

- La unidad portátil emite pitidos durante 1 minuto.
- Para detener la localización, presione de nuevo **HANDSET LOCATOR** o presione dos veces **TALK** en la unidad portátil.