

# Panasonic

2.4GHz Cordless Answering System

Model No. **KX-TGM240-B**  
**KX-TGM240-S**

Pulse-or-tone dialing capability

## Operating Instructions

Preparation

Cordless Telephone

Answering System

Useful Information



**2.4GHz**  
GIGARANGE

**SST**  
SPREAD SPECTRUM  
TECHNOLOGY

**DUAL**  
ANTENNA SYSTEM

SST HOTLINE  
1-800-211-PANA(7262)

KX-TGM240-B

PLEASE READ BEFORE USE AND SAVE.

Charge the battery for about 15 hours before initial use.

# Before Initial Use

Please read **IMPORTANT SAFETY INSTRUCTIONS** on pages 64–65 before use. Read and understand all instructions.

*Thank you for purchasing your new Panasonic cordless telephone.*

Attach your purchase receipt here.

## For your future reference

Serial No. \_\_\_\_\_  
(found on the bottom of the unit)

Date of purchase \_\_\_\_\_

Name and address of dealer \_\_\_\_\_

## Accessories (Included) To order, call 1-800-332-5368.

- AC Adaptor (p. 10)  
Order No. KX-A11-6

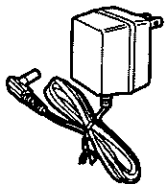

one

- Telephone Line Cord (p. 10)

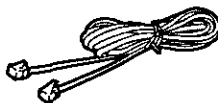

one

- Belt Clip (p. 15)  
Order No.  
PQKE10073Z1 (KX-TGM240-B)  
PQKE10073Z2 (KX-TGM240-S)



one

- Wall Mounting Adaptor (p. 58)  
Order No. PQKL24Z0

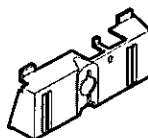

one

# For Best Performance

## Battery Charge

A rechargeable Nickel-Metal Hydride (Ni-MH) battery powers the handset. Charge the battery for about **15 hours** before initial use (p. 11).

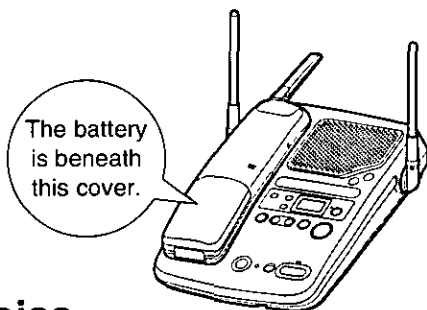

## Base Unit Location/Noise

Calls are transmitted between the base unit and the handset using wireless radio waves. **For maximum distance and noise free operation**, the recommended base unit location is:

Away from electrical appliances such as a TV, personal computer, or another cordless phone.

In a **HIGH** and **CENTRAL** location with no obstructions such as walls.

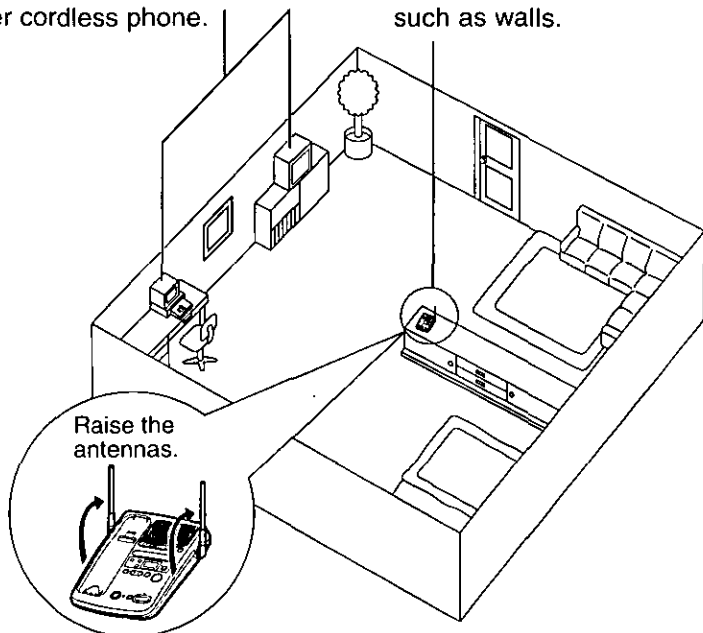

### Note

While using the handset:

- If you are near a microwave oven which is being used, noise may be heard at the receiver. Move away from the microwave oven and closer to the base unit.
- If more than one cordless phone is being used and your handset is near another cordless phone's base unit, noise may be heard. Move away from the other cordless phone's base unit and closer to your base unit.

# Contents

---

## *Preparation*

<b>Location of Controls</b> .....	6
<b>Settings</b> .....	10
Connections .....	10
Battery Charge .....	11
Selecting the Dialing Mode .....	13
Selecting the Ringer Volume .....	14
Selecting the Handset Ringer Tone (2 Types) .....	14
Using the Belt Clip .....	15
Using the Optional Headset .....	16
Connecting the Optional Headset to the Handset .....	16
How to Wear the Optional Headset .....	17
<b>Preparing the Answering System</b> .....	18
Greeting Message .....	18
Programming Summary for the Answering System .....	20
Time and Day Adjustment .....	21
Selecting the Caller's Recording Time .....	22
Selecting the Number of Rings .....	23
Setting the CPC (Calling Party Control) Function .....	24
Setting the Greeting Monitor Function .....	25

## *Cordless Telephone*

<b>Making Calls</b> .....	26
<b>Answering Calls</b> .....	28
With the Handset .....	28
With the Base Unit (Digital Duplex Speakerphone) .....	28
<b>Remote Speakerphone</b> .....	30
<b>Speed Dialer</b> .....	32
Storing Phone Numbers in Memory .....	32
Dialing a Stored Number .....	33
<b>Intercom</b> .....	34
Transferring a Call Using the Intercom .....	35

<b>Special Features</b> .....	36
For Call Waiting Service Users .....	36
Automatic Security Code Setting .....	36
Temporary Tone Dialing (For Rotary or Pulse Service Users) ..	36
How to Use the PAUSE Button (For Analog PBX Line/Long Distance Service Users) .....	36

## **Answering System**

<b>Automatic Answering Operation</b> .....	37
Setting the Unit to Answer Calls .....	37
<b>Listening to Messages</b> .....	38
From the Handset .....	40
<b>Erasing Messages</b> .....	41
<b>Recording a Memo Message</b> .....	42
<b>Pager Call</b> .....	43
Storing the Pager Number .....	43
Setting the Unit to Call a Pager .....	45
<b>Remote Operation from a Touch Tone Phone</b> .....	46
Setting the Remote Code .....	47
Voice Menu .....	48
Direct Remote Operation .....	50
<b>Remote Operation with the Handset</b> .....	52
<b>Remote Operation Card</b> .....	55

## **Useful Information**

<b>Battery Replacement</b> .....	57
<b>Wall Mounting</b> .....	58
<b>Adding Another Phone</b> .....	59
<b>Before Requesting Help</b> .....	60
<b>Important Safety Instructions</b> .....	64
<b>FCC and Other Information</b> .....	66

# Location of Controls

---

## Base unit

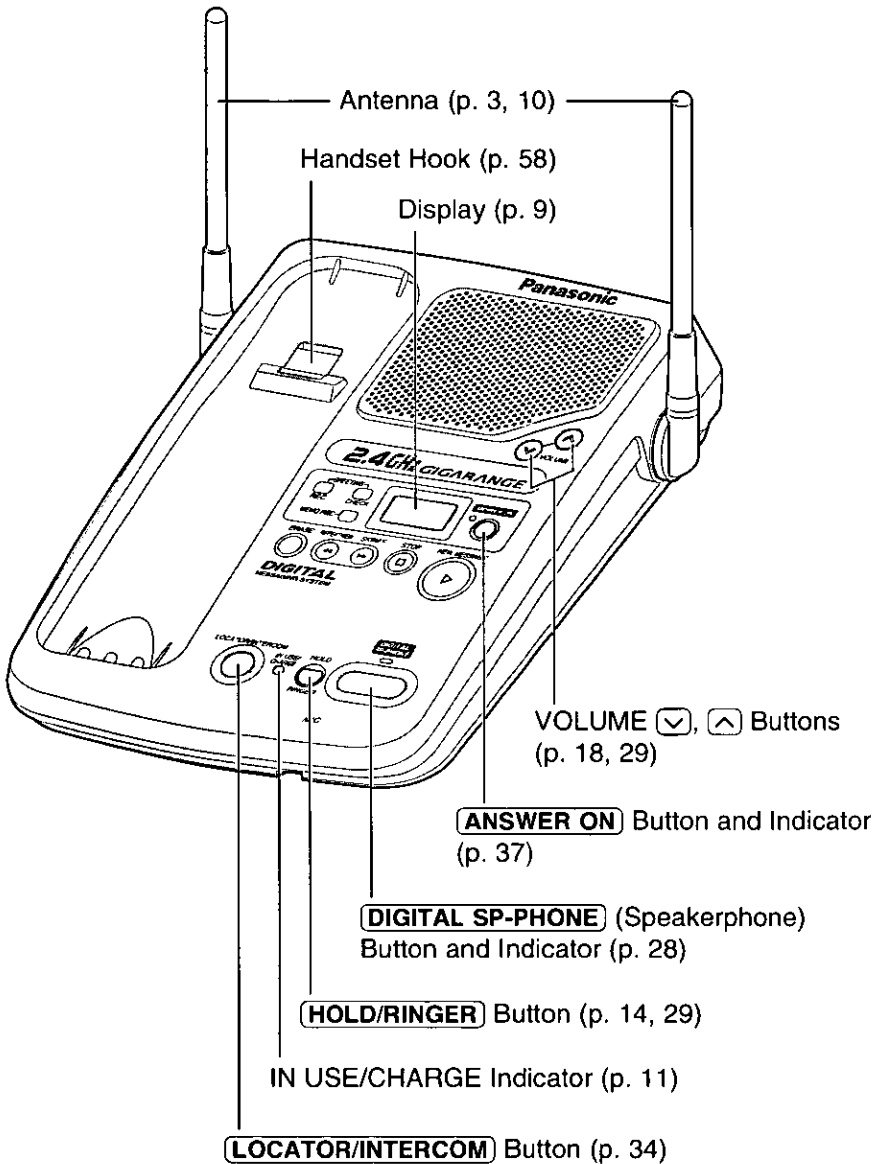

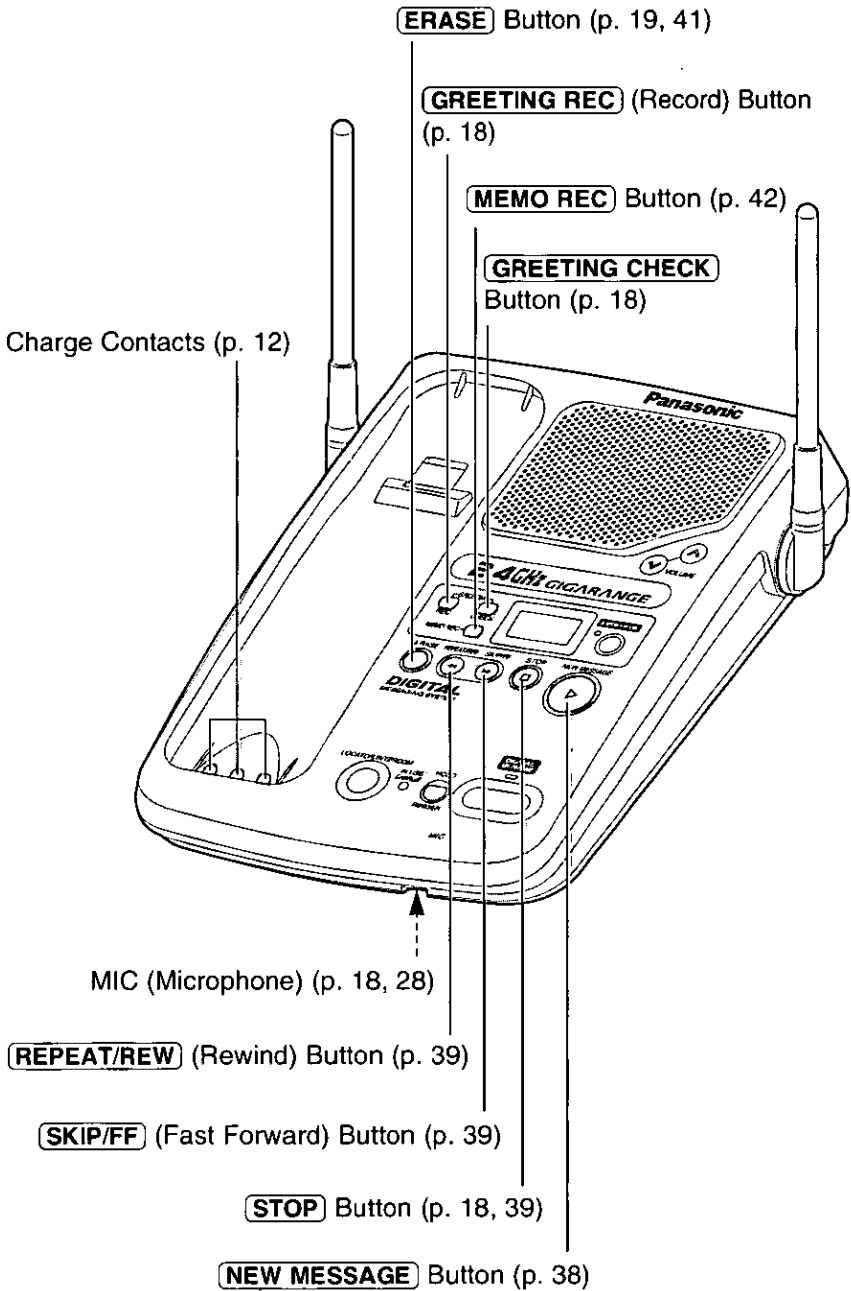

# ► Location of Controls

## Handset

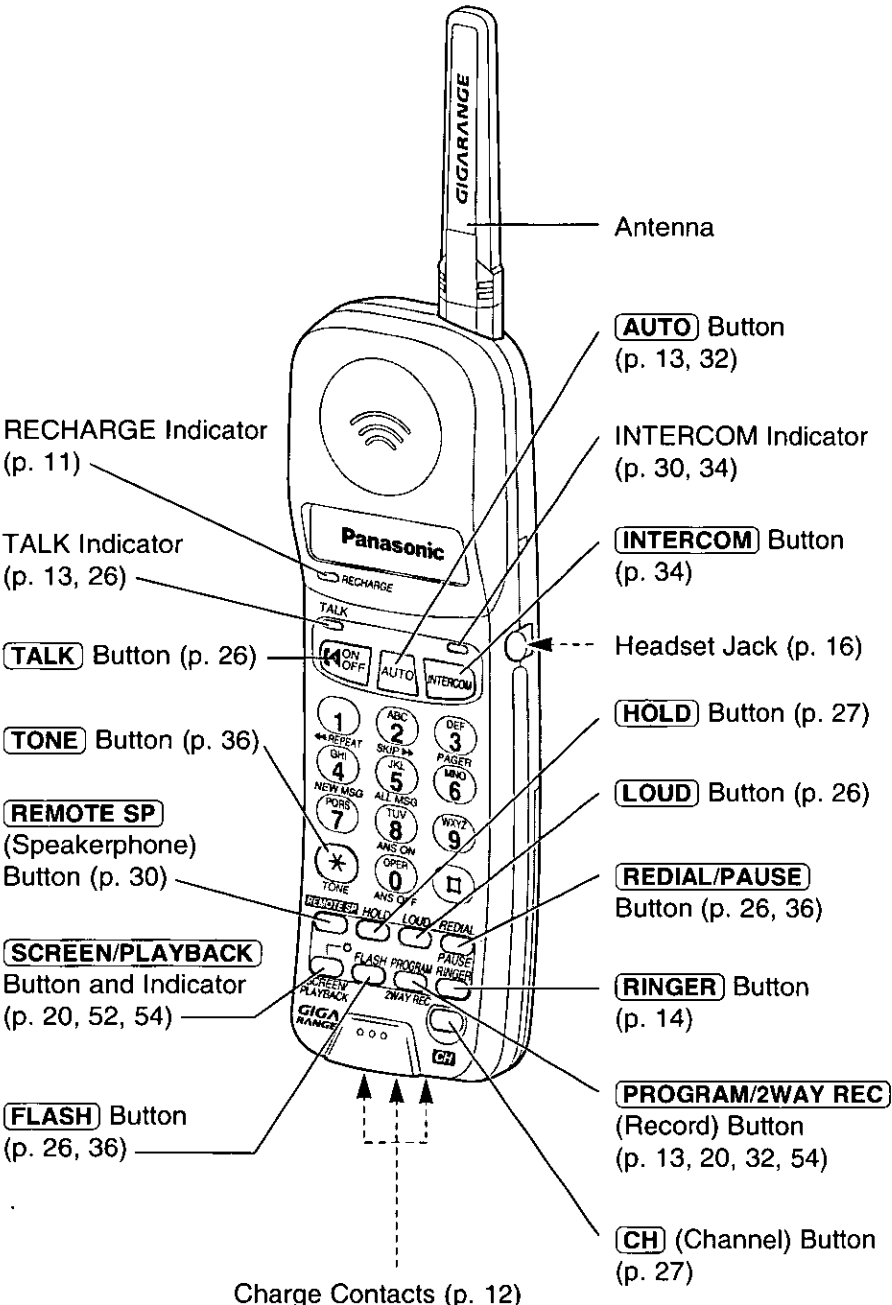



## Base unit display



The clock needs adjusting (p. 21).

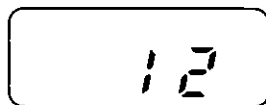

12 messages have been recorded.

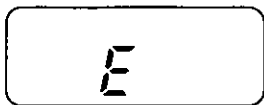

Your message was not recorded correctly. Record it again (p. 18, 42).

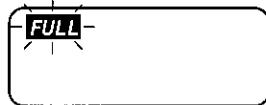

Memory is full. Erase some or all of the messages (p. 41).



The unit is in programming mode.

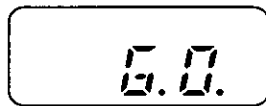

The recording time is set to "greeting only" (p. 22).

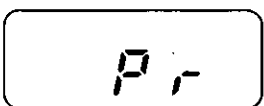

A pre-recorded message is being played (p. 19).



The base unit ringer volume is set to OFF (p. 14).

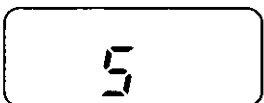

The speaker volume level is set to "5". You can select:

- 9 levels (0–8) while using the answering system (p. 18, 38).
- 8 levels (1–8) while using the speakerphone (p. 29).



The pager call mode is set to ON (p. 45).

# Settings

## Connections

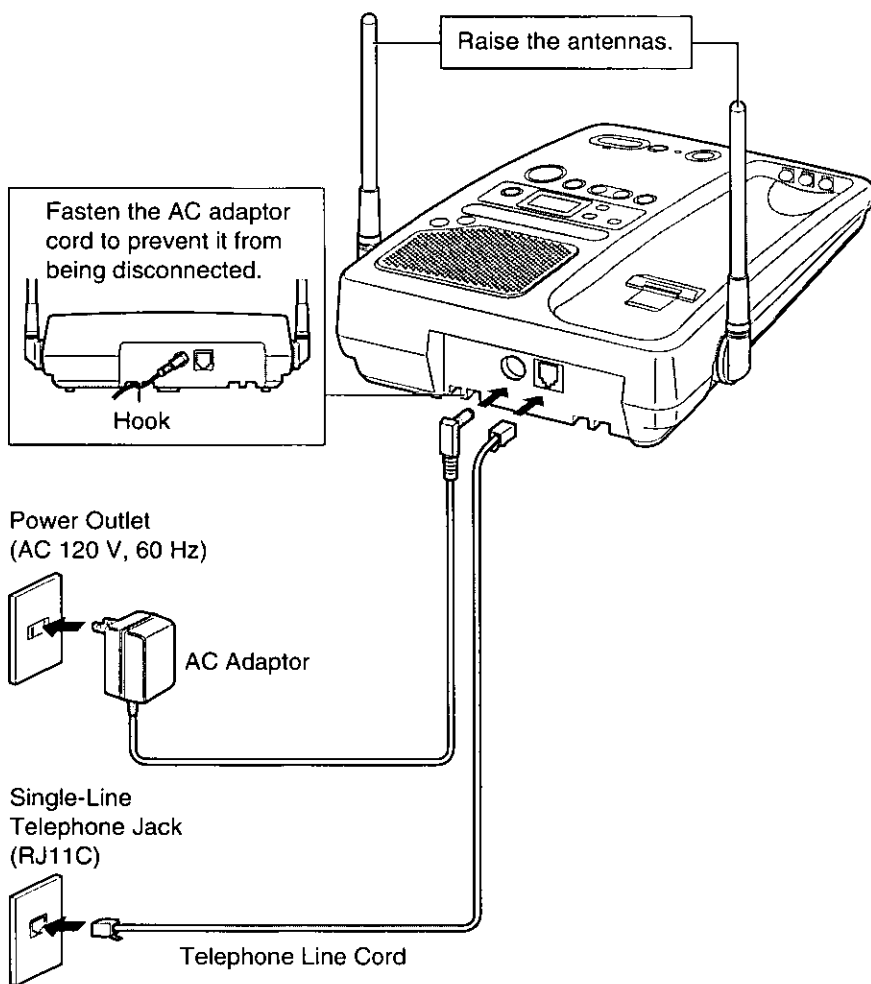

- USE ONLY WITH Panasonic AC ADAPTOR KX-A11 (Order No. KX-A11-6).
- The AC adaptor must remain connected at all times. (It is normal for the adaptor to feel warm during use.)
- To connect a standard telephone on the same line, see page 59.



## Battery Charge

Place the handset on the base unit and charge for about **15 hours** before initial use.

- The IN USE/CHARGE indicator lights.

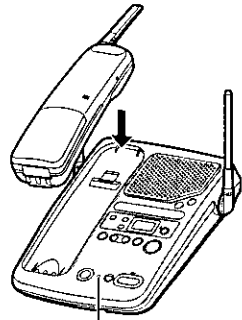

IN USE/CHARGE Indicator

## Recharge

When the RECHARGE indicator flashes or the unit beeps intermittently, recharge the battery for about 15 hours.

- If you **DO NOT** recharge the handset battery for more than 30 minutes, the RECHARGE indicator will continue to flash.

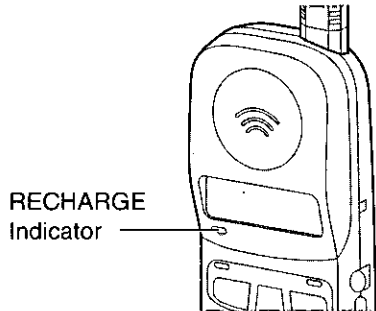

## ► Settings

---

### Battery information

After your Panasonic battery is fully charged (p. 11):

Operation		Approx. battery life
While in use (TALK)	near the base unit*	8–9 hours
	away from the base unit	3–4 hours
While not in use (Stand-By)		14 days

\*Within about 10 feet (3 m)

- Battery life may vary depending on usage conditions and ambient temperature.
- **Clean the handset and the base unit charge contacts with a soft dry cloth once a month. Clean more often if the unit is subject to grease, dust or high humidity.** If not, the battery may not charge properly.
- If the battery is fully charged, you do not have to place the handset on the base unit until the RECHARGE indicator flashes. This will maximize the battery life.
- The battery cannot be overcharged.



## Selecting the Dialing Mode

You can program the dialing mode **by using the handset near the base unit**. If you have touch tone service, set to TONE. If rotary or pulse service is used, set to PULSE. Your phone comes from the factory set to TONE.

The **TALK** and **DIGITAL SP-PHONE** indicator lights must be off before programming.

- 1 Press **PROGRAM/2WAY REC**.
  - The TALK indicator flashes.
- 2 Press **AUTO**.
- 3 To select PULSE, press **#** twice.  
OR  
To select TONE, press **\*** twice.
- 4 When finished, press **PROGRAM/2WAY REC**.
  - A confirmation tone sounds.\*

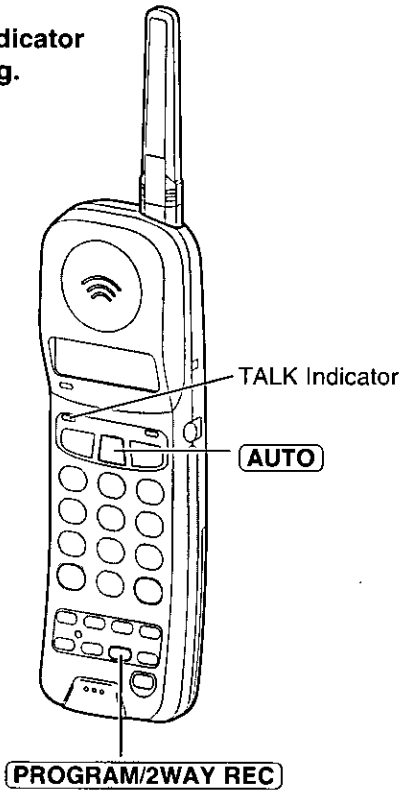

- To cancel during programming, press **PROGRAM/2WAY REC**, then start from step 1.
- If 3 beeps sound during programming, a wrong key was pressed. Restart from step 1.

### \*What the confirmation tone means

- 1 beep: The mode is different from the previously selected one.
- 2 beeps: The mode is the same as the previously selected one.

If a power failure occurs, the mode will return to the factory preset (TONE). Reprogram if necessary.

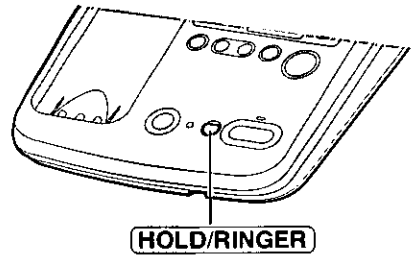
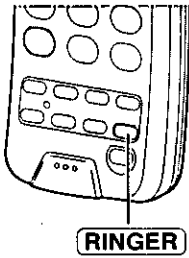

## Selecting the Ringer Volume

### With the handset

The TALK indicator light must be off.

- To select **HIGH (preset) or LOW**, press **RINGER** briefly.  
(Each time you press the button briefly, the selected volume will ring and the ringer volume will change.)
- To turn the ringer **OFF**, press and hold **RINGER** until 2 beeps sound.
- To turn the ringer **ON**, press **RINGER** briefly. The ringer will sound at the HIGH level.

### With the base unit

The DIGITAL SP-PHONE indicator light must be off.

- To select **HIGH (preset) or LOW**, press **HOLD/RINGER** briefly.  
(Each time you press the button briefly, the selected volume will ring and the ringer volume will change.)
- To turn the ringer **OFF**, press and hold **HOLD/RINGER** until 2 beeps sound. "**RINGER OFF**" will be displayed.
- To turn the ringer **ON**, press **HOLD/RINGER** briefly. The ringer will sound at the HIGH level.

## Selecting the Handset Ringer Tone (2 Types)

The TALK indicator light must be off.

- 1 Press **RINGER**.
- 2 Press **\*** within 5 seconds.
  - The selected ringer tone will sound.
  - Each time you press **\*** within 5 seconds, the ringer tone will change.



## Using the Belt Clip

You can hang the handset on your belt or pocket using the belt clip.

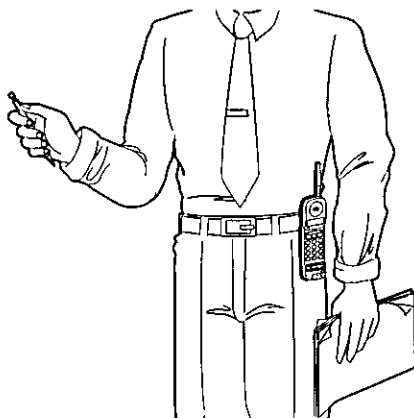

Preparation

### To install the belt clip

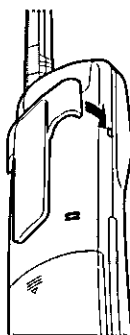
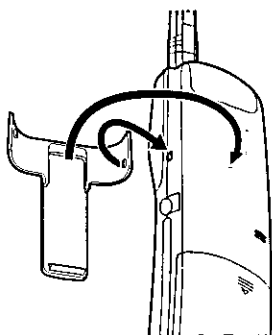

### To remove the belt clip

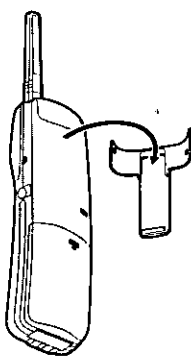
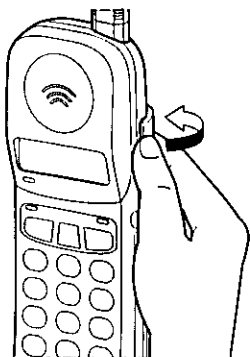

### Using the Optional Headset

Plugging the optional headset into the handset provides a handsfree phone conversation. Please use only the Panasonic KX-TCA90 headset. To order, call 1-800-332-5368.

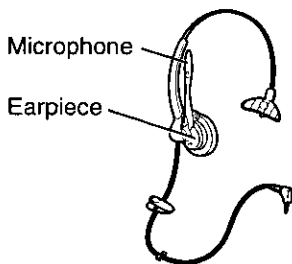

When the optional headset is connected to the handset, be sure to use the headset to talk with the caller. If you want to have a normal cordless phone conversation, disconnect the headset.

### Connecting the Optional Headset to the Handset

Open the headset jack cover, then connect the optional headset to the headset jack as shown below.

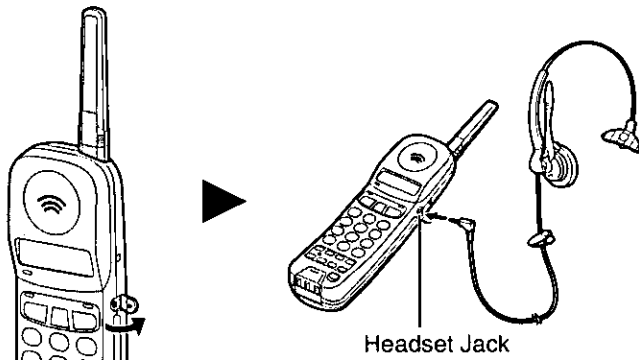



---

## How to Wear the Optional Headset

- 1 Place the headset on your head and attach the clothing clip to the desired position.

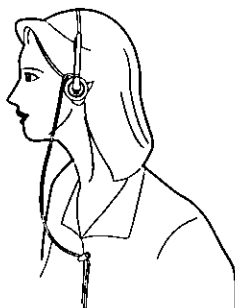

- 2 Adjust the microphone to a comfortable position.
  - Place the microphone near your mouth.



# Preparing the Answering System

## Greeting Message

You can record a personal greeting message. If not, one of two pre-recorded greetings will be played when a call is received (p. 19).

All messages (greeting, incoming, memo, etc.) are stored in digital memory (p. 19). The **total recording time is about 16 minutes**. We recommend you record a **brief greeting message** (see the sample on the next page) in order to leave more time for recording new messages.

### To record a greeting message

1 Press **GREETING REC** to start the recording mode.

- "Press RECORD again to record greeting." is heard.

2 Within 5 seconds, press **GREETING REC** again to record your greeting.

- A long beep sounds.

3 After the long beep, talk clearly about 8 inches (20 cm) away from the **MIC** (microphone).

- The display shows the elapsed recording time.

4 When finished, press **STOP**.

- To check the recorded greeting, press **GREETING CHECK**.
- To change the message, repeat from step 1.

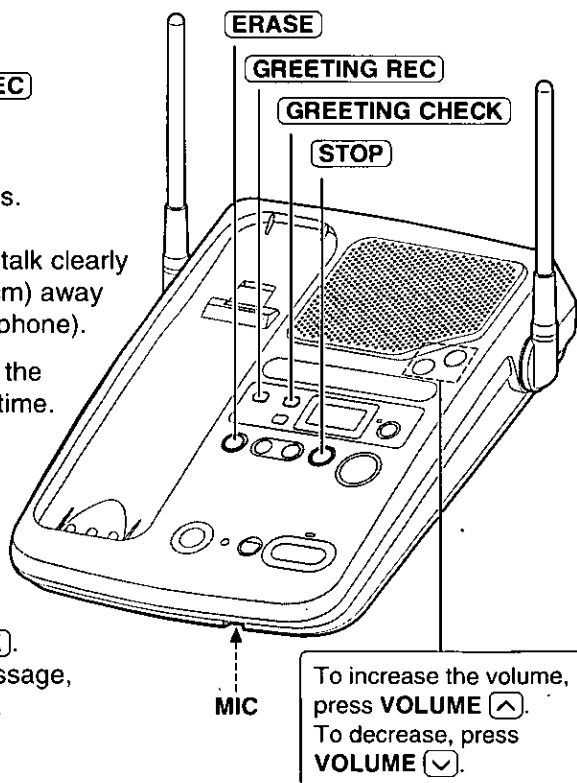



### Greeting message sample

"Hello, this is (your name and/or number). Sorry I cannot take your call. Please leave a message after the beep. Thank you."

### To erase the recorded greeting message

Press **GREETING CHECK** → press **ERASE** while the message is being played.

- The unit will answer a call with a pre-recorded greeting.

### Pre-recorded greeting message

If you do not record a greeting message (p. 18), one of the following two messages will be played when a call is received depending on the caller's recording time (p. 22).

To check the pre-recorded greeting, press **GREETING CHECK**.

- A pre-recorded greeting will be played as below.
- When the recording time is set to "1 minute" or "unlimited";  
"Hello, we are not available now. Please leave your name and phone number after the beep. We will return your call."
- When the recording time is set to "greeting only";  
"Hello, we are not available now. Please call again. Thank you for your call."

### Flash Memory Message Backup

Messages are stored indefinitely on a "flash memory" IC chip—even if a power failure occurs. All of the messages are saved until you erase them.

## ► Preparing the Answering System

### Programming Summary for the Answering System

You can program the following functions by using the handset near the base unit. See the page numbers below for details.

The **TALK** and **DIGITAL SP-PHONE** indicator lights must be off before programming.

Lift the handset, then press **PROGRAM/2WAY REC**.



Press **SCREEN/PLAYBACK**.



● If an alarm tone sounds, move closer to the base unit, then try again.

To adjust the time and day, press **0**. (page 21)

To set the remote code, press **1**. (page 47)

To select the number of rings, press **2**. (page 23)

To set the CPC function, press **3**. (page 24)

To set the greeting monitor function, press **4**. (page 25)

To select the caller's recording time, press **5**. (page 22)

To store the pager number, press **#**. (page 43)



When finished, press **PROGRAM/2WAY REC**.

● A confirmation tone sounds.\*

- To cancel during programming, press **PROGRAM/2WAY REC**, then start from the beginning.
- If 6 beeps sound during programming, a wrong key was pressed. Enter the correct number again.

#### \*What the confirmation tone means

- 1 beep: The new programmed setting or selection is done.
- 2 beeps: The setting or selection is the same as the previous one.
- 3 or 6 beeps: The setting or selection is not correct. Try again from the beginning.

If a power failure occurs, the setting will return to the factory preset. Reprogram if necessary.



## Time and Day Adjustment

**Voice Time/Day Stamp:** During playback, a synthesized voice will announce the time and day when each message was recorded.

- 1 Press **PROGRAM/2WAY REC**.
  - The TALK indicator flashes.
- 2 Press **SCREEN/PLAYBACK**.
  - The indicator lights.
  - “P” is displayed on the base unit.
- 3 Press **0**.
  - “⌚” is displayed.
  - “Set time” is announced.
  - The time/day will be heard if it was adjusted beforehand.
- 4 Enter the current time (hour and minute) by using a 4-digit number. (Ex. To set 9:30, enter “0930”.)
  - The unit announces the time.
  - The entered number is displayed.
- 5 Press **\*** to select “AM” or “PM”.  
Press **#** repeatedly to set the day.
- 6 When finished, press **PROGRAM/2WAY REC**.
  - The unit announces the time/day.
  - The clock starts working.

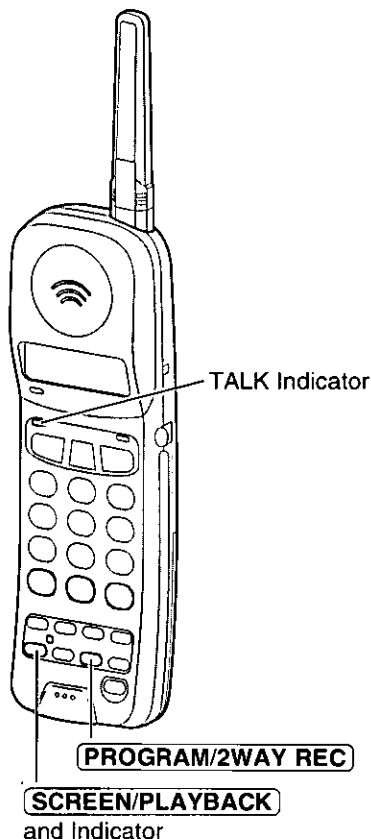

- In step 4, you cannot enter numbers greater than 12. **Do not use military time.** (To set 13:00 hours, enter “0100” and select “PM” by pressing **\***.)
- The accuracy of the clock is approximately  $\pm 45$  seconds a month at room temperature.

### To check the time/day

Press **PROGRAM/2WAY REC** → **SCREEN/PLAYBACK** → **0**.

- The current time/day is heard.
- When finished, press **PROGRAM/2WAY REC**.

## ► Preparing the Answering System

### Selecting the Caller's Recording Time

You may select the caller's recording time as either "1 minute", "unlimited" or "greeting only". Your phone comes from the factory set to "unlimited".

- 1 Press **PROGRAM/2WAY REC**.
  - The TALK indicator flashes.
- 2 Press **SCREEN/PLAYBACK**.
  - The indicator lights.
  - "P" is displayed on the base unit.
- 3 Press **5**.
  - The current setting is displayed.
    - 1: 1 minute
    - 2: unlimited (factory preset)
    - 3: greeting only
- 4 Press **1**, **2** or **3** to select the recording time.
  - The setting is displayed.
- 5 When finished, press **PROGRAM/2WAY REC**.
  - The indicator lights go out.

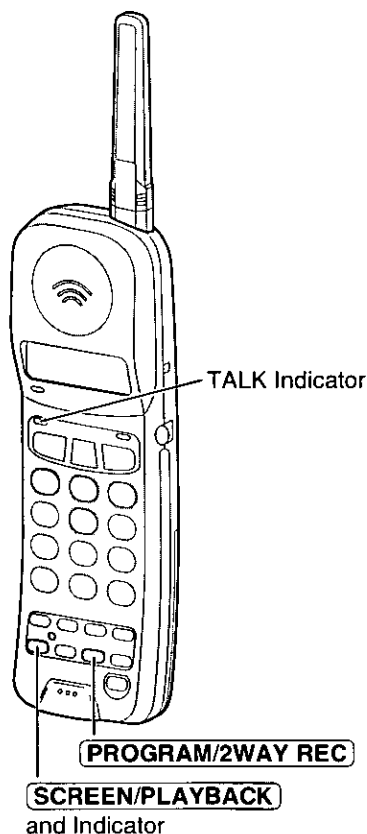

If you select "greeting only", the unit will answer a call with the greeting message, and then hang up. The unit will not record any incoming messages.



## Selecting the Number of Rings

You may select the number of rings before the answering system answers a call, from "1" to "7" or "AUTO (for Toll Saver)". Your phone comes from the factory set to "AUTO".

- 1 Press **PROGRAM/2WAY REC**.
  - The TALK indicator flashes.
- 2 Press **SCREEN/PLAYBACK**.
  - The indicator lights.
  - "P" is displayed on the base unit.
- 3 Press **2**.
  - The current setting is displayed.
- 4 Press a dialing button **0** to **7** to set the number of rings.
  - 0**: Selects "AUTO".  
"A" is displayed.
  - 1-7**: The unit will answer after the selected number of rings.
- 5 When finished, press **PROGRAM/2WAY REC**.
  - The indicator lights go out.

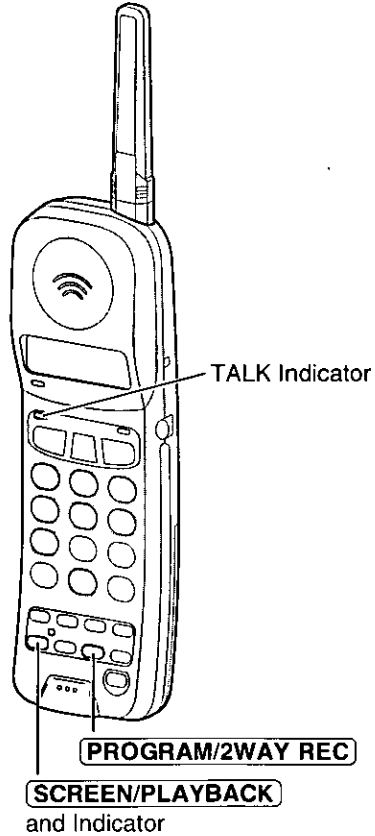

### Toll Saver (When set to "AUTO")

When you call the unit from a touch tone telephone:

If the unit answers on the 2nd ring, there is at least one new message.

If the unit answers on the 4th ring, there are no new messages.

**Hang up when you hear the 3rd ring.** This will save you the toll charge for the call.

## ► Preparing the Answering System

---

### Setting the CPC (Calling Party Control) Function

The CPC function is preset to "A". If you use a call waiting service, set to "b", or the call waiting tone will disconnect someone leaving a message.

1 Press **PROGRAM/2WAY REC**.

2 Press **SCREEN/PLAYBACK**.

3 Press **3**.

- The current setting, "A" or "b", is displayed on the base unit.

4 To select "b", press **2**.  
OR

To select "A", press **1**.

- The setting is displayed.

5 When finished, press **PROGRAM/2WAY REC**.

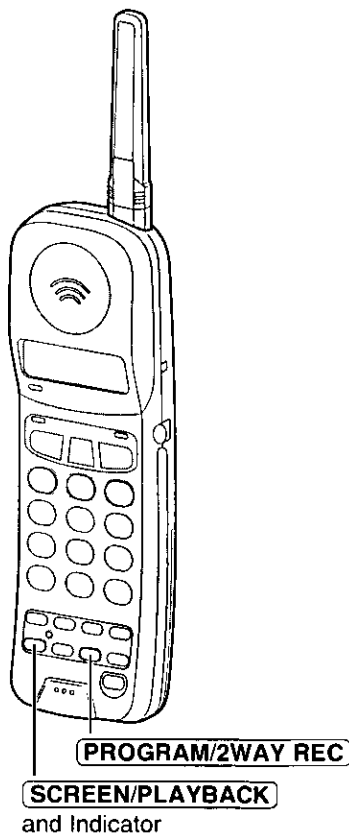



## Setting the Greeting Monitor Function

When your greeting message is being played to the caller, you can also listen to it through the base unit speaker. To listen to your greeting, set to "2 (ON)". Your phone comes from the factory set to "1 (OFF)".

- 1 Press **PROGRAM/2WAY REC**.
- 2 Press **SCREEN/PLAYBACK**.
- 3 Press **(4)**.
  - The current setting, "1" or "2", is displayed on the base unit.
- 4 To select "2 (ON)", press **(2)**.  
OR  
To select "1 (OFF)", press **(1)**.
  - The setting is displayed.
- 5 When finished, press **PROGRAM/2WAY REC**.

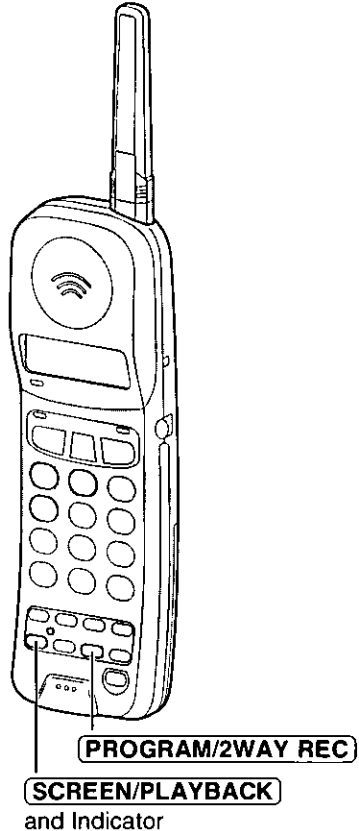

# Making Calls

To have a handsfree conversation, connect the optional headset to the handset and wear it (p. 16, 17).

- 1 Press **TALK**.
  - The TALK indicator lights.
- 2 Dial a telephone number.
  - If you misdial, press **FLASH** firmly then dial again.
- 3 To hang up, press **TALK** or place the handset on the base unit.
  - The indicator lights go out.

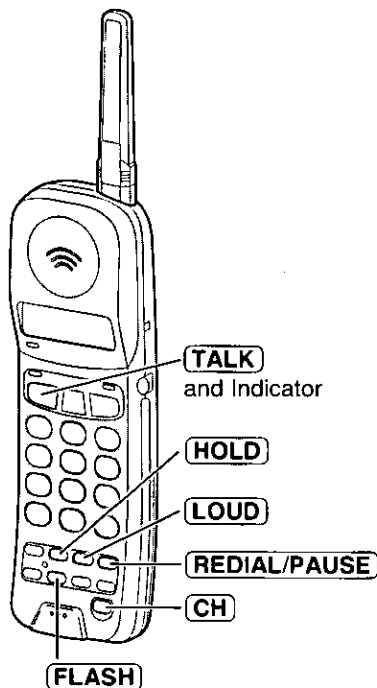

- If an alarm tone sounds in step 1, move closer to the base unit or place the handset on the base unit. Then try again.
- To switch to the speakerphone during a call with the handset, see page 30.

## To redial the last number dialed

Press **TALK** → **REDIAL/PAUSE**.

## To select the handset receiver volume

Press **LOUD** while talking.

- Each time you press the button, the volume level will change from MEDIUM (preset) to HIGH to LOW.

---

## If noise interferes with the conversation

Press **CH** to select a clearer channel or move closer to the base unit.

## To put a call on hold

Press **HOLD**.

- The TALK indicator and the DIGITAL SP-PHONE indicator flash simultaneously.
- After 6 minutes, warning tones will sound every 10–15 seconds. After a total of 10 minutes, the call will be disconnected.

## To release the hold

From the handset, press **TALK**.

From the base unit, press **DIGITAL SP-PHONE**.

- If another phone is connected on the same line (p. 59), you can also release the hold by lifting its handset.

## Lighted handset keypad

The handset dialing buttons will light while dialing and flash when a call is received. The lights will go out about 10 seconds after dialing or answering a call.

# Answering Calls

## With the Handset

If the handset is off the base unit, press **TALK**.

- You can also answer a call by pressing any dialing button **0** to **9**, **\*** or **#** (—Any Key Talk).



## OR

If on the base unit, just lift up.

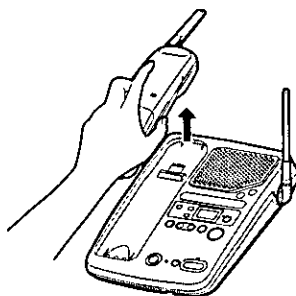

## With the Base Unit (Digital Duplex Speakerphone)

- 1 Press **DIGITAL SP-PHONE**.
  - The DIGITAL SP-PHONE indicator lights.

- 2 Talk into the **MIC** (microphone).

- 3 To hang up, press **DIGITAL SP-PHONE**.
  - The indicator light goes out.

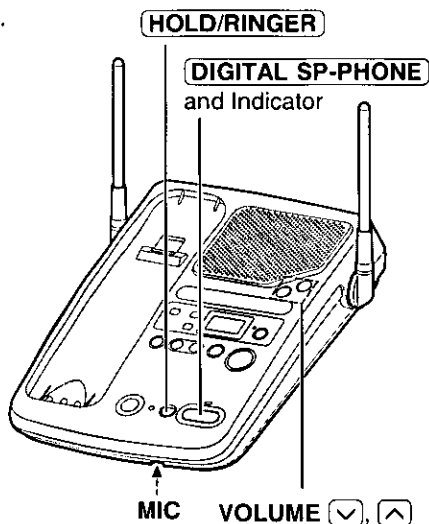

- While using the speakerphone, if the handset is on the base unit, you may switch to it by lifting it up.

### Hands-Free Digital Duplex Speakerphone

The digital duplex speakerphone enhances your telephone conversation.

For best performance, please note the following:

- Use the speakerphone in a quiet room.
- Talk alternately with the caller.
- If the caller complains that your voice is hard to hear, press **VOLUME**  to decrease the speaker volume.
- If the other party's voice from the speaker cuts in/out during a conversation, press **VOLUME**  to decrease the speaker volume.

### To adjust the speaker volume (8 levels) while talking

To increase, press **VOLUME** . To decrease, press **VOLUME** .

### To put a call on hold

Press **HOLD/RINGER**.

- The DIGITAL SP-PHONE indicator flashes.
- After 6 minutes, warning tones will sound every 10–15 seconds. After a total of 10 minutes, the call will be disconnected.

### To release the hold

From the base unit, press **DIGITAL SP-PHONE**.

From the handset, press **TALK** or lift the handset off the base unit.

- You may also press **REMOTE SP** on the handset to release the hold at the base unit.
- If another phone is connected on the same line (p. 59), you can also release the hold by lifting its handset.

# Remote Speakerphone

You can switch a call with the handset to the speakerphone easily.

**1** Handset:  
During a call with the handset, press **REMOTE SP**.

- The call switches to the base unit.
- The INTERCOM indicator flashes.
- The DIGITAL SP-PHONE indicator lights.

**2** Base unit:  
Talk into the **MIC**.

**3** Base unit:  
To hang up, press **DIGITAL SP-PHONE**.

- The indicator lights go out.
- You can also hang up by pressing **REMOTE SP**.

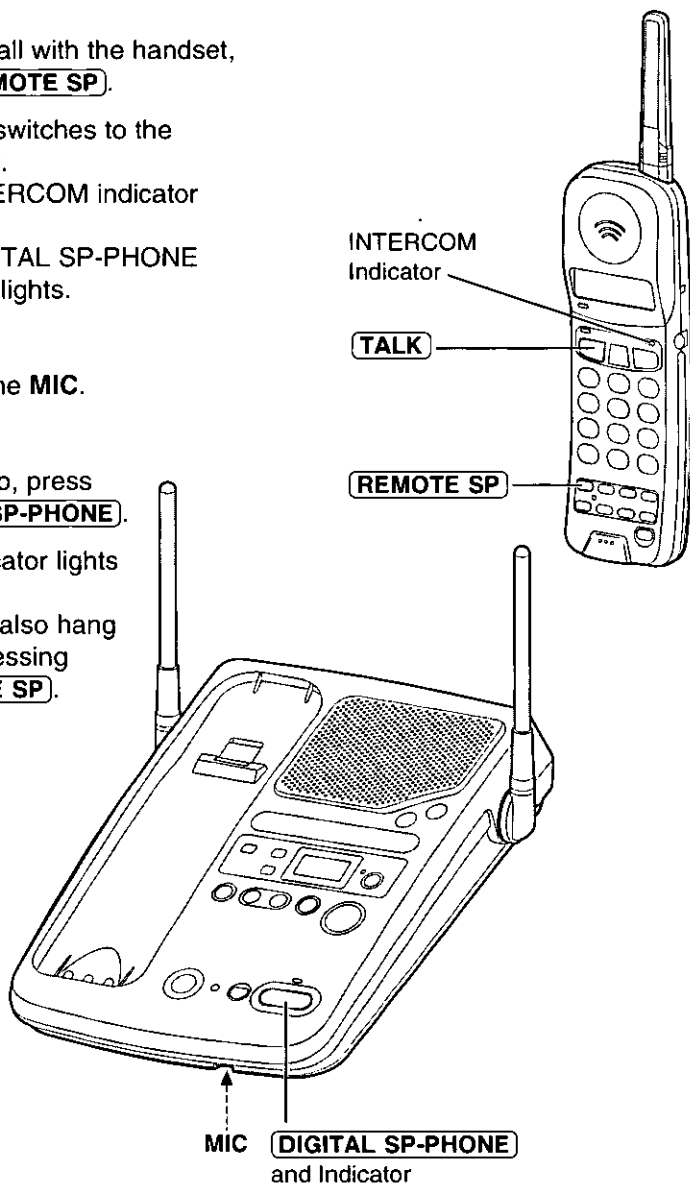

When using the **REDIAL/PAUSE** button, dialing a stored number (p. 33), etc., press **REMOTE SP** after dialing is completed.

You can turn on the base unit speakerphone by using the handset as a remote control.

## Making calls using the handset as a remote control

1. Handset: Press **REMOTE SP**.
2. Handset: Dial a telephone number.
3. Base unit: Talk into the **MIC**.
4. Handset: To hang up, press **REMOTE SP**.
  - You may also hang up by pressing **DIGITAL SP-PHONE**.

## To switch to the handset (while using the remote speakerphone)

Press **TALK**.

- You can continue the conversation using the handset.
- To hang up, press **TALK** or place the handset on the base unit.

When using the **REDIAL/PAUSE** button, dialing a stored number (p. 33), etc., press **TALK** after dialing is completed.

## Answering calls using the handset as a remote control

1. Handset: Press **REMOTE SP**.
2. Base unit: Talk into the **MIC**.
3. Handset: To hang up, press **REMOTE SP**.
  - You may also hang up by pressing **DIGITAL SP-PHONE**.

## Useful information

You can enter numbers using the handset keypad during a call with the remote speakerphone. For example, to access an answering service, electronic banking service, etc.

1. Handset: Press **REMOTE SP**.
2. Handset: Dial a telephone number.
3. Handset: Enter the required numbers while listening to the pre-recorded instructions from the base unit speakerphone.
4. Handset: To hang up, press **REMOTE SP**.
  - You may also hang up by pressing **DIGITAL SP-PHONE**.

# Speed Dialer

## Storing Phone Numbers in Memory

You can store up to 10 phone numbers in the handset. The dialing buttons (0) to (9) function as memory stations.

**The TALK indicator light must be off before programming.**

- 1 Press **PROGRAM/2WAY REC**.
  - The TALK indicator flashes.
- 2 Enter a phone number up to 16 digits.
  - If you misdial, press **PROGRAM/2WAY REC** to end storing, then start from step 1.
- 3 Press **AUTO**.
- 4 Press a memory station number (0) to (9).
  - A confirmation tone sounds.\*
  - To store other numbers, repeat steps 1 through 4.

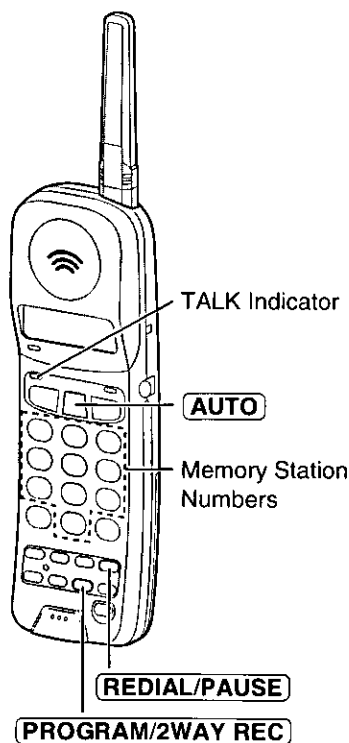

- If a pause is required for dialing, **REDIAL/PAUSE** can be stored in a phone number counting as one digit (p. 36).

### \*What the confirmation tone means

1 beep: The new number is stored.

2 beeps: The number is the same as the previously stored one.



---

## To erase a stored number

Press **PROGRAM/2WAY REC** → **AUTO** → the memory station number (0 to 9) for the phone number to be erased.

## Dialing a Stored Number

- 1 Press **TALK**.
- 2 Press **AUTO**.
- 3 Press the memory station number (0 to 9).
  - The stored number is dialed.

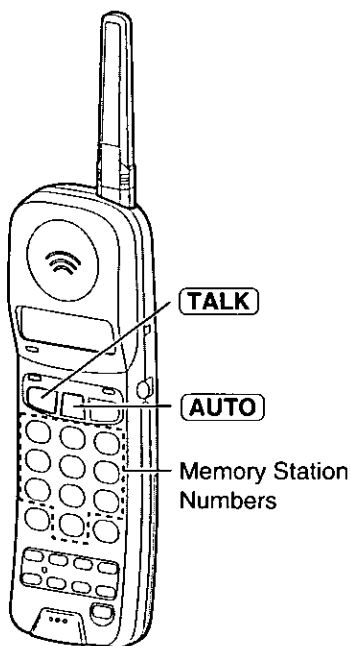

# Intercom

A 2-way intercom is available between the handset and the base unit.

## Paging the base unit from the handset

- 1 Handset:  
Press **INTERCOM**.  
Talk to the paged party  
after the beeps.

- The indicator lights.

- 2 Base unit:  
When the other  
party's voice is heard,  
answer using the **MIC**.

- 3 Handset:  
To end the intercom,  
press **INTERCOM**.

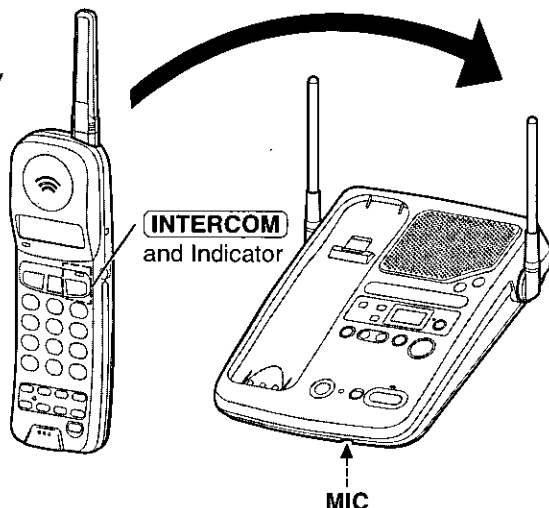

## Paging the handset from the base unit (Handset locator)

Using this feature, you can locate the handset, if misplaced.

- 1 Base unit:  
Press **LOCATOR/INTERCOM**.

- The handset beeps for  
1 minute.

- To stop paging, press  
**LOCATOR/INTERCOM**  
again.

- 2 Handset:  
Press **INTERCOM**  
to answer.

- 3 Base unit:  
Talk into the **MIC**.

- 4 Handset:  
To end the intercom, press  
**INTERCOM**.

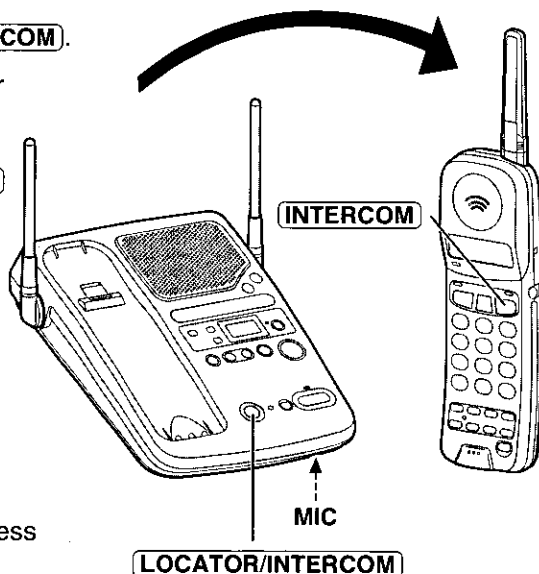

**During the intercom:**

- Intercom calls can only be ended by the handset.
- If two tones sound, an incoming call has been received.

To answer, press **(TALK)**, **(REMOTE SP)** or **(DIGITAL SP-PHONE)**.  
The intercom is ended.

## Transferring a Call Using the Intercom

The intercom can be used during a call. This feature enables you to transfer a call between the handset and the base unit.

### From the handset to the base unit

- 1 Handset:**  
During a call, press **(INTERCOM)**. Talk to the paged party after the beeps.
  - The call is put on hold.
  - If the base unit user does not answer, press **(TALK)**.
- 2 Base unit:**  
When the paging party's voice is heard, answer using the **MIC**.
- 3 Base unit:**  
To answer the call, press **(DIGITAL SP-PHONE)**.
  - The transfer is completed.
  - The handset user can join the conversation by pressing **(TALK)**.

### From the base unit to the handset

- 1 Base unit:**  
During a call, press **(LOCATOR/INTERCOM)**.
  - The call is put on hold.
  - If the handset user does not answer, press **(DIGITAL SP-PHONE)**.
- 2 Handset:**  
Press **(INTERCOM)** to answer the page.
- 3 Handset:**  
To answer the call, press **(TALK)**.
  - The transfer is completed.
  - The base unit user can join the conversation by pressing **(DIGITAL SP-PHONE)**.

# Special Features

---

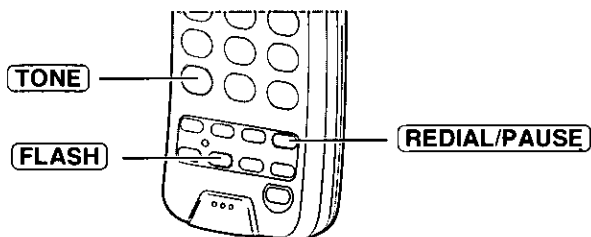

## For Call Waiting Service Users

Press **FLASH** briefly if you hear a call-waiting tone while talking.

- The first call is put on hold and you can answer the second call.
- To return to the first caller, press **FLASH** again.

## Automatic Security Code Setting

Whenever you place the handset on the base unit, the unit automatically selects one of a million security codes. These codes help prevent the unauthorized use of your telephone line by another cordless telephone.

## Temporary Tone Dialing

(For Rotary or Pulse Service Users)

Press **TONE** before entering access numbers which require tone dialing.

- The dialing mode changes to tone. You can enter numbers to access an answering service, electronic banking service, etc. When you hang up, the mode will return to pulse.

## How to Use the PAUSE Button

(For Analog PBX Line/Long Distance Service Users)

We recommend you press **REDIAL/PAUSE** if a pause is required for dialing with a PBX or to access a long distance service.

Ex: Line access number **9** (PBX)

**9** → **REDIAL/PAUSE** → Phone number

- Pressing **REDIAL/PAUSE** once creates a 3.5 second pause. This prevents misdialing when you redial or dial a stored number.
- Pressing **REDIAL/PAUSE** more than once increases the length of the pause between numbers.

# Automatic Answering Operation

When the unit answers a call, a greeting message is played and the caller's message is recorded.

- The total recording time (including the greeting message) is **about 16 minutes**. If messages are recorded in noisy rooms, the memory time may be shortened up to 5 minutes.
- A maximum of 64 messages (including the greeting message) can be recorded.

## Setting the Unit to Answer Calls

Press **ANSWER ON** to turn on the answering system.

- The indicator lights and "Answer set" is heard.
- The unit will announce the remaining recording time if it is less than 5 minutes.
- If you hear "Memory full" and the indicator flashes rapidly, erase some or all of the messages (p. 41).

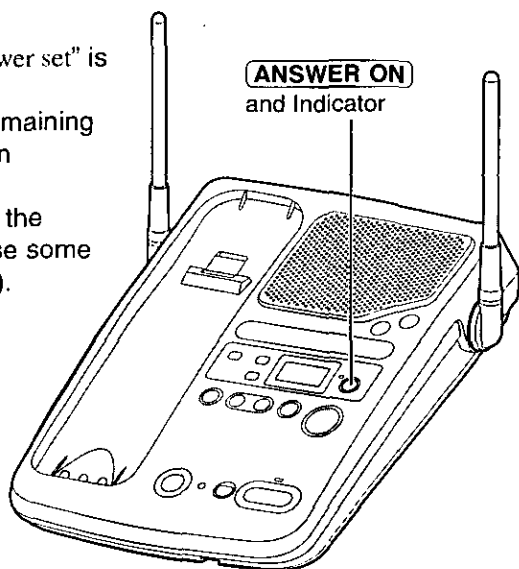

Answering system

- If you do not want the unit to answer calls, press **ANSWER ON** to turn the answering system off. The indicator light goes out and "Answer off" is heard.
- You can also turn on the answering system remotely using any other phone (p. 51).

## Monitoring incoming calls

While a call is being recorded, you can monitor it through the speaker. To monitor incoming calls with the handset, see page 54.

To answer the call with the speakerphone, press **DIGITAL SP-PHONE** or **REMOTE SP**. For the handset, lift the handset off the base unit or press **TALK**. The unit stops recording.

# Listening to Messages

You can see the total number of recorded messages on the display.  
If the ANSWER ON indicator flashes, new messages have been recorded.

## Listening to only the new messages

Press **NEW MESSAGE** briefly.

- The unit announces the number of new messages and plays them back.

## Listening to all of the recorded messages

Press and hold **NEW MESSAGE** firmly until a short beep sounds.

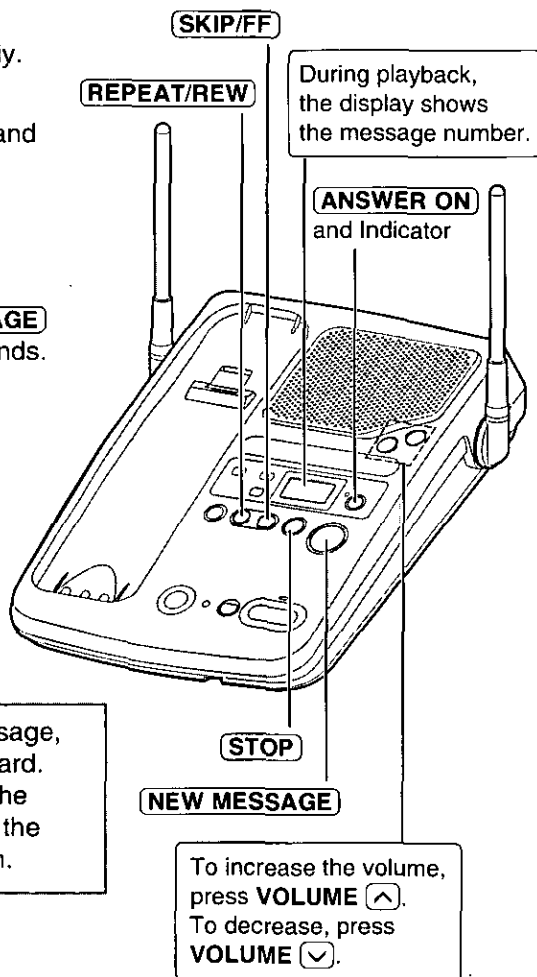

At the end of the last message, "End of final message" is heard. After the announcement, the unit will automatically turn the answering system back on.



## During playback

<p>To <b>repeat/rewind</b> the message</p>	<p><b>To repeat from the beginning of the message</b> Press <b>REPEAT/REW</b> briefly. (If you press within 5 seconds of playback, the previous message will be played.)</p> <p><b>To rewind part of the message</b> Press and hold <b>REPEAT/REW</b> until you reach the desired place.</p> <ul style="list-style-type: none"><li>● At the beginning of the message, 3 beeps will sound.</li></ul>
<p>To <b>skip/cue</b> the message</p>	<p><b>To skip to the next message</b> Press <b>SKIP/FF</b> briefly.</p> <p><b>To cue to part of the message</b> Press and hold <b>SKIP/FF</b> until you reach the desired place.</p> <ul style="list-style-type: none"><li>● The message will be heard twice as fast.</li><li>● At the end of the message, 3 beeps will sound.</li></ul>
<p>To <b>stop</b> the operation</p>	<p>Press <b>STOP</b>.</p> <ul style="list-style-type: none"><li>● To resume playback, press <b>NEW MESSAGE</b>. To turn on the answering system, press <b>ANSWER ON</b>.</li></ul>

## ► Listening to Messages

### From the Handset

If someone else is in the room and you want to listen to the recorded messages privately, you can listen to them using the handset.

**1** Handset:  
Press **SCREEN/PLAYBACK**.

- The number of new messages is heard on the handset.

**2** Base unit:  
To listen to new messages, press **NEW MESSAGE** briefly.

To listen to all of the messages, press and hold **NEW MESSAGE** firmly.

- The messages will be heard on the handset.
- **REPEAT/REW**, **SKIP/FF** and **STOP** are also available during playback (p. 39).

**3** When finished, press **SCREEN/PLAYBACK** or place the handset on the base unit.

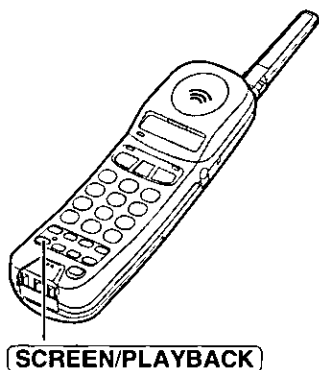

- You can also listen to messages without using the base unit. See page 52.



# Erasing Messages

The unit will announce the remaining recording time after playback, if it is less than 5 minutes. New messages cannot be recorded when:

- “Memory full” is heard.
- “**FULL**” is displayed.
- the ANSWER ON indicator flashes rapidly.

Erase some or all of the messages. We recommend you erase unnecessary messages after each playback.

## Erasing a specific message

Press **ERASE** while the message you want to erase is being played.

- The unit erases the message.
- A short beep will sound and the unit will continue to play the next message.

## Erasing all of the messages

All of the recorded messages except the greeting message can be erased at one time.

- 1 Press **ERASE**.
  - “Press ERASE again to erase all messages.” is heard.
- 2 Within 5 seconds, press **ERASE** again.
  - A long beep and “No messages” are heard.
  - The display shows “0”.

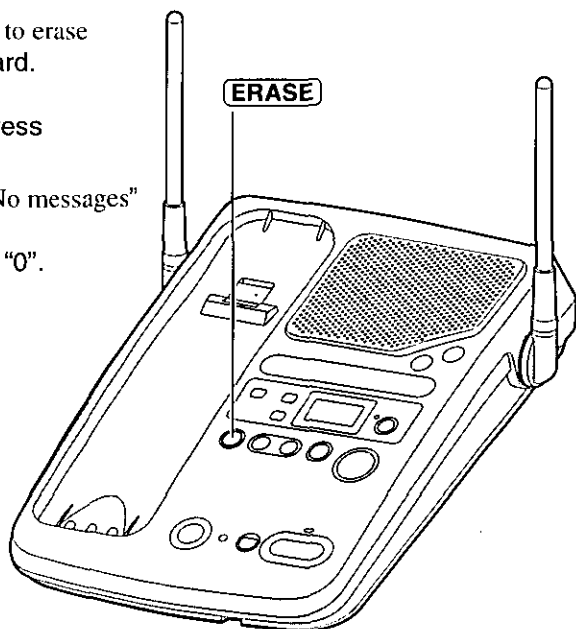

# Recording a Memo Message

---

You may record a personal message in memory.

- 1 Press **MEMO REC**.
  - A long beep sounds.
- 2 After the beep, talk clearly about 8 inches (20 cm) away from the **MIC**.
  - The display shows the elapsed recording time.
- 3 When finished, press **STOP**.
  - A beep sounds.

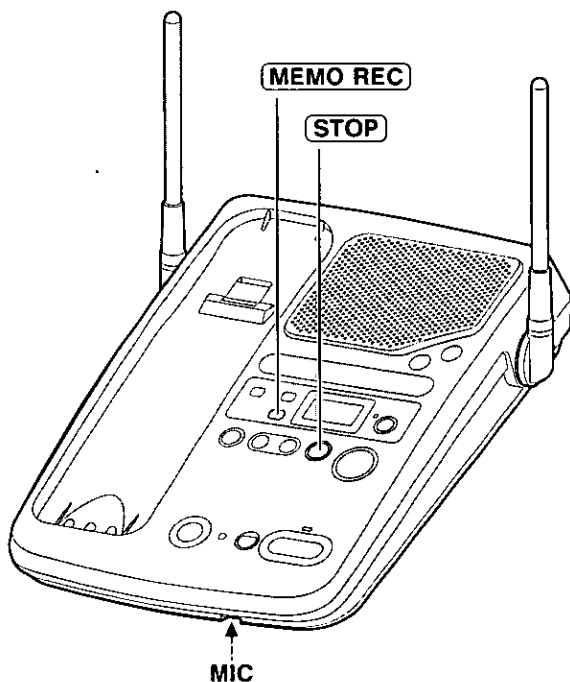

# Pager Call



This feature allows you to alert your pager when the unit records an incoming message. You can retrieve the message from a touch tone telephone (p. 46). First store the pager number, then set the unit to call a pager.

**The TALK and DIGITAL SP-PHONE indicator lights must be off before programming.**

## Storing the Pager Number

If you use a 1-800 pager number, see the next page for the storing procedure.

- 1 Press **PROGRAM/2WAY REC**.
  - The TALK indicator flashes.
- 2 Press **SCREEN/PLAYBACK**.
  - The indicator lights.
  - “P” is displayed on the base unit.
- 3 Press **#**.
- 4
  - a) Enter your pager number and then press **REDIAL/PAUSE** twice.\* Enter the access code, if required by your pager company, and then press **REDIAL/PAUSE** twice again.\*
  - b) Enter the call back number to be displayed on the pager (the telephone number where your unit is connected).
  - c) Press **#** if required by your pager company.
    - If you misdial, press **PROGRAM/2WAY REC** then start from step 1.
    - You can enter a total of 48 digits.
- 5 When finished, press **PROGRAM/2WAY REC**.
  - The indicator lights go out.

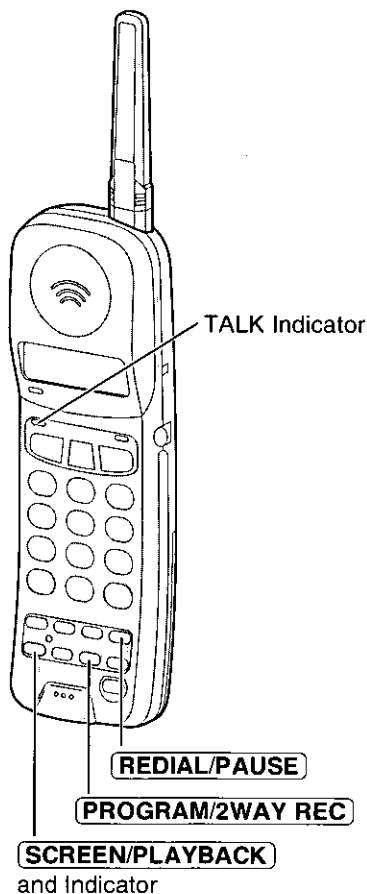

\*Pager companies require a delay after the pager number and/or the access code is dialed. Contact your pager company regarding the required pause time. Pressing **REDIAL/PAUSE** once creates a 3.5 second delay and counts as one digit.

## ► Pager Call

### Storing the 1-800 pager number

If you use a 1-800 pager number with your PIN code, store the pager number as follows.

- 1 Press **PROGRAM/2WAY REC**.
  - The TALK indicator flashes.
- 2 Press **SCREEN/PLAYBACK**.
  - The indicator lights.
  - “P” is displayed on the base unit.
- 3 Press **#**.
- 4
  - a) Enter the 1-800 pager number and then press **REDIAL/PAUSE** 3 times.\*
  - b) Enter the PIN code and then press **REDIAL/PAUSE** twice.\*
  - c) Enter the call back number to be displayed on the pager (the number where your unit is connected).
  - d) Press **#** if required by your pager company.
    - If you misdial, press **PROGRAM/2WAY REC** then start from step 1.
    - You can enter a total of 48 digits.
- 5 When finished, press **PROGRAM/2WAY REC**.
  - The indicator lights go out.

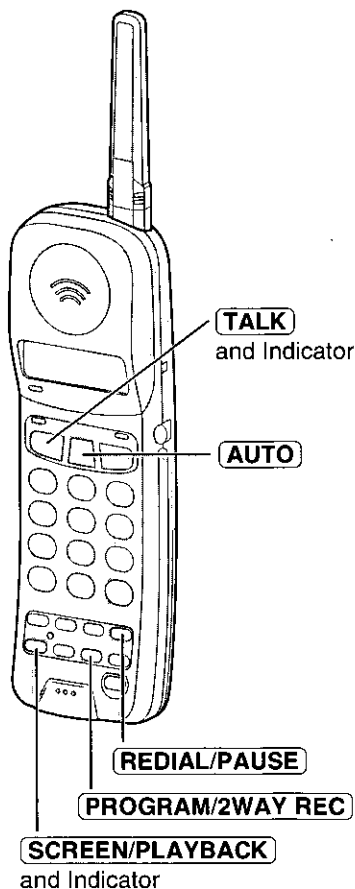

\* Pager companies require a delay after the pager number and the PIN code are dialed. Contact your pager company regarding the required pause time. Pressing **REDIAL/PAUSE** once creates a 3.5 second delay and counts as one digit.

•Alphanumeric voice dispatch pager service will not work with this function.

## To confirm the stored pager number

Press **TALK** → **AUTO** → **#**.

- The unit dials the stored number.
- If the pager does not beep, check your pager by calling it manually to ensure it works. Then restart from step 1 to store the pager number.

## To erase the stored pager number

Press **PROGRAM/2WAY REC** → **SCREEN/PLAYBACK** → **#** → **PROGRAM/2WAY REC**.

## Setting the Unit to Call a Pager

- 1 Press **SCREEN/PLAYBACK**.
  - The indicator lights.
  - The number of new messages is heard.
- 2 Press **3**.
  - “**PAGER**” is displayed on the base unit and “on” is heard.
  - If 6 beeps sound, the pager number is not stored. Store the number, then try again.
- 3 When finished, press **SCREEN/PLAYBACK**.
  - The indicator light goes out.

To turn off the pager call mode, repeat steps 1 through 3.

- “**PAGER**” will disappear and “off” is heard.
- Each time you press **3** in step 2, “on/off” is heard and the mode will turn on or off.

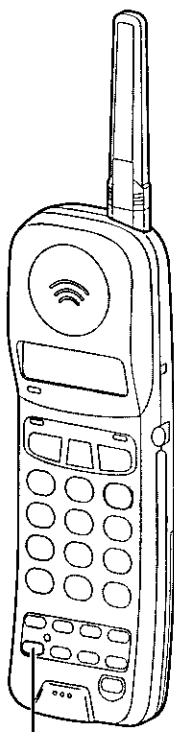

**SCREEN/PLAYBACK**  
and Indicator

# Remote Operation from a Touch Tone Phone

---

You can operate the answering system from any touch tone phone. A synthesized voice menu will guide you on how to operate the unit (p. 48).

- To skip the voice menu and operate the unit directly, see page 50.

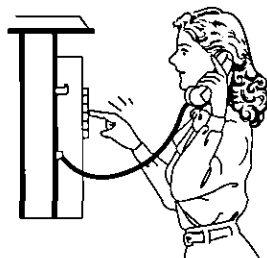

## Summary of the remote operation

Call your unit from a touch tone phone.



During or after the greeting message playback, enter your remote code (p. 47).

- The number of new messages is heard.



After 3 seconds, the voice menu will start (p. 48).  
Follow the menu or enter the direct commands (p. 50).



To end the remote operation, hang up.

- The messages are saved.



## Setting the Remote Code

The remote code prevents unauthorized people from accessing your unit and listening to your messages. Choose any **2-digit number (00–99)**. The factory preset remote code number is “11”. If you do not program your own remote code number, you can use “11”.

**The TALK and DIGITAL SP-PHONE indicator lights must be off before programming.**

- 1 Press **PROGRAM/2WAY REC**.
  - The TALK indicator flashes.
- 2 Press **SCREEN/PLAYBACK**.
  - The indicator lights.
  - “P” is displayed on the base unit.
- 3 Press **1**.
  - The current remote code is displayed.
- 4 Enter a remote code by using a **2-digit number (00–99)**.
  - The entered number is displayed.
- 5 When finished, press **PROGRAM/2WAY REC**.
  - The indicator lights go out.

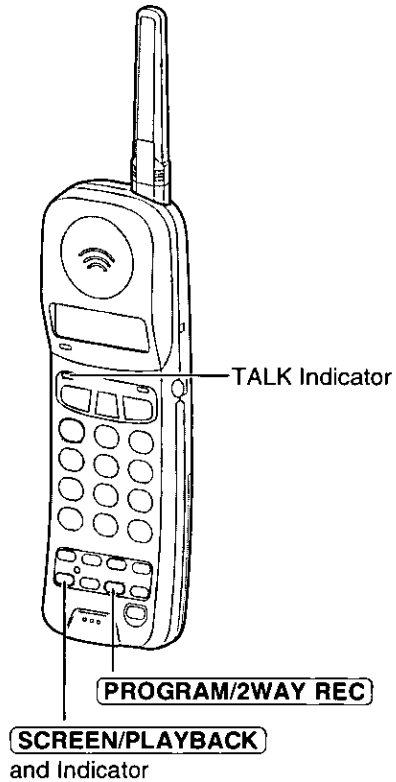

Answering system

•If 3 beeps sound in step 5, you entered a one digit number. Restart from step 1 to program a 2-digit number.

### To check the remote code

Press **PROGRAM/2WAY REC** → **SCREEN/PLAYBACK** → **1**.  
The current remote code is displayed.  
When finished, press **PROGRAM/2WAY REC**.

## ► Remote Operation from a Touch Tone Phone

### Voice Menu

The shaded boxes are voice prompts.

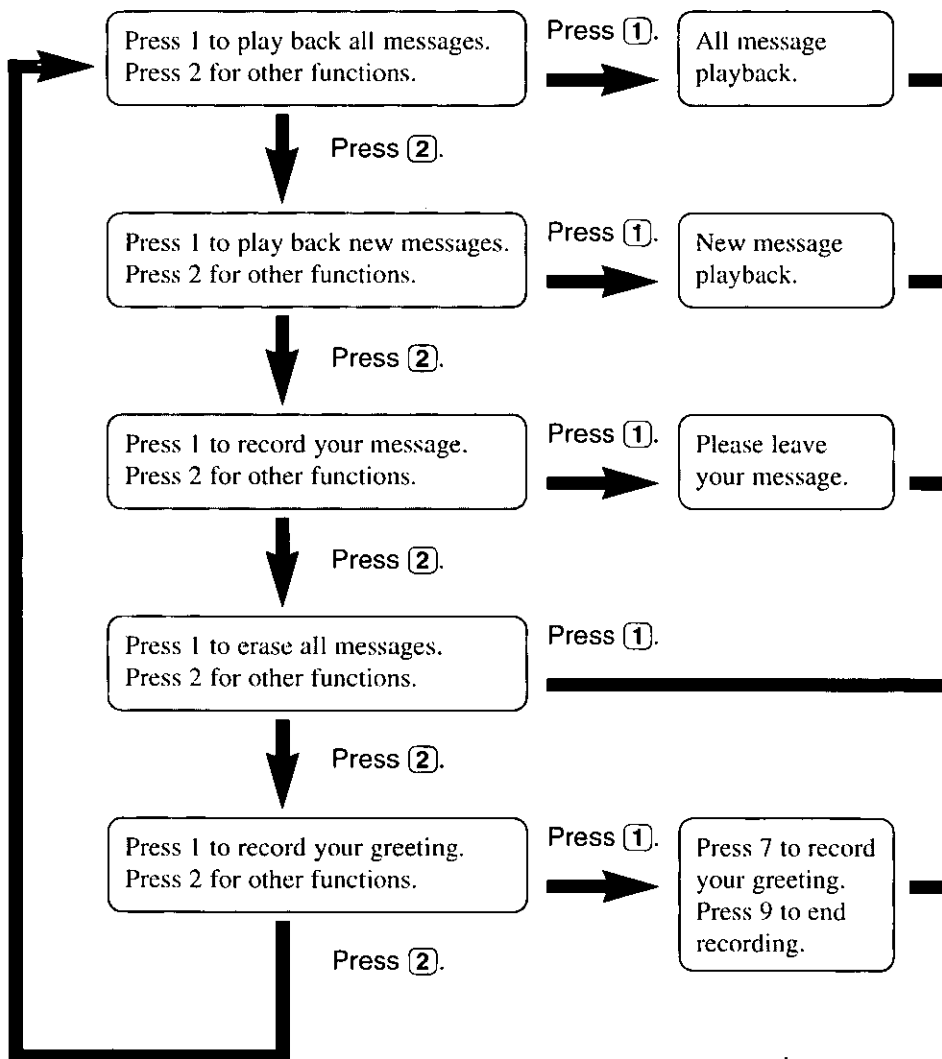





### All Message Playback

All of the recorded messages are played back.

At the end of the last message, "End of final message" and the remaining recording time are announced.



### New Message Playback

Only new messages are played back.



### Recording a Memo Message

You can leave a personal message.

1. Talk after you hear "Please leave your message".
2. When you finish recording, hang up.



### Erasing All Messages

All of the recorded messages (except the greeting message) are erased.



### Recording a Greeting Message

You can re-record your greeting message.

1. Press **7**.  
You hear a voice prompt followed by a long beep.
2. Talk after the long beep.
3. When you finish recording, press **9**.
4. Your greeting will be played back for confirmation.

- 3 seconds after playback, the voice menu will start from the beginning.
- If you hear "Memory full" after playback, erase some or all of the messages (p. 50).

## ► Remote Operation from a Touch Tone Phone

---

### Direct Remote Operation

Once you have entered the remote code, you can also control your unit by direct commands instead of using the voice menu. To end the remote operation, hang up anytime.

#### Direct commands

---

NEW MESSAGE  
PLAYBACK

4

- Only new messages are played back.
- 

ALL MESSAGE  
PLAYBACK

5

- All of the messages are played back.
- 

REPEAT  
(During playback)

1

- The current message is repeated.
- 

SKIP  
(During playback)

2

- The current message is skipped.  
The next message is played.
- 

STOP  
(During playback)

9

- Playback is stopped temporarily.
  - To resume playback, press 9 again within 15 seconds, or the voice menu will start.
- 

GREETING  
MESSAGE  
RECORDING

7

- A long beep sounds.



RECORD

- Talk immediately after the long beep.



9

- The recording is stopped.
  - The recorded message is played.
- 

ERASING A  
SPECIFIC  
MESSAGE  
(During playback)

\* 4

- The current message is erased.
  - A short beep will sound and the next message is played.
- 

ERASING ALL  
MESSAGES

\* 5

- All of the recorded messages are erased.
  - A long beep and “No messages” are heard.
-

---

PAGER CALL  
ON/OFF

**3**

- Each time you press **3**, “on/off” is heard and the mode will turn on/off.
- If you did not store a pager number, 6 beeps will sound and the mode will not turn on.

---

ANSWERING  
SYSTEM OFF

**0**

- The unit hangs up and will not answer calls until turned on again.
- 

## Turning on the answering system

Call your unit and wait for 15 rings.

- The unit will answer and the greeting message will be played.
- The answering system will turn on. Hang up or enter the remote code for other options.
- When turning on the answering system using a rotary or pulse service telephone, you cannot enter the remote code for other options.

## Skipping the greeting message

After calling your unit, press **\***  during the greeting message playback.

- The unit skips the rest of the greeting and callers can start recording their message after the long beep.

# Remote Operation with the Handset

You can operate your answering system with the handset.  
The announcement and recorded messages can only be heard from the handset.

**SCREEN/PLAYBACK**  
and Indicator

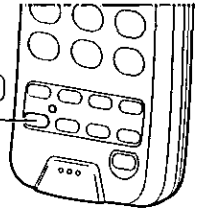

## Summary of the remote operation

Press **SCREEN/PLAYBACK**.

- The indicator lights.
- The number of new messages is heard.



- If the SCREEN/PLAYBACK indicator flashes, the answering system is off. To turn it on, press **8**.

Enter the desired direct commands (p. 53–54).

- If you do not enter any command, the voice menu will start (p. 53).
- After the voice menu, all message playback will start.



To end the remote operation, press **SCREEN/PLAYBACK**.

- The messages are saved.

- If two tones sound during the remote operation, an incoming call has been received. To answer, press **TALK**. The remote operation is ended.
- If you hear “Memory full” after playback, erase some or all of the messages (p. 53).



## Voice menu

If no commands are entered after you press **SCREEN/PLAYBACK**, the unit will start the following voice menu.

“Press 4 to playback new messages. Press 5 to playback all messages.”

- You can enter direct commands even when the voice menu has started.

## Direct commands

---

NEW MESSAGE PLAYBACK	<b>4</b>	• Only new messages are played back.
-------------------------	----------	--------------------------------------

---

ALL MESSAGE PLAYBACK	<b>5</b>	• All of the messages are played back.
-------------------------	----------	--

---

REPEAT (During playback)	<b>1</b>	• The current message is repeated.
-----------------------------	----------	------------------------------------

---

SKIP (During playback)	<b>2</b>	• The current message is skipped. The next message is played.
---------------------------	----------	--

---

STOP (During playback)	<b>9</b>	• Playback is stopped temporarily. • To resume playback, press <b>9</b> again within 15 seconds, or the above voice menu will start.
---------------------------	----------	---

---

ERASING A SPECIFIC MESSAGE (During playback)	<b>* 4</b>	• The current message is erased. • A short beep will sound and the next message is played.
---	------------	---

---

ERASING ALL MESSAGES	<b>* 5</b>	• All of the recorded messages are erased. • A long beep and “No messages” are heard.
-------------------------	------------	--

---

(continued →)

## ► Remote Operation with the Handset

---

PAGER CALL  
ON/OFF

**3**

- Each time you press **3**, "on/off" is heard and the mode will turn on/off.
  - If you did not store a pager number, 6 beeps will sound and the mode will not turn on.
- 

ANSWERING  
SYSTEM OFF

**0**

- The SCREEN/PLAYBACK indicator flashes.
- 

ANSWERING  
SYSTEM ON

**8**

- The SCREEN/PLAYBACK indicator lights.
- 

### Monitoring incoming calls with the handset

When an incoming message is being recorded, the SCREEN/PLAYBACK indicator flashes slowly.

1. Press **SCREEN/PLAYBACK**.
  - The indicator lights and you can listen to the incoming call.
  - To answer the call, press **TALK**. The recording is stopped.
2. When finished monitoring the call, press **SCREEN/PLAYBACK**.

### Recording your telephone conversation with the handset

1. During a conversation with the handset, press **PROGRAM/2WAY REC**.
  - The SCREEN/PLAYBACK indicator lights.
2. Continue your conversation.
3. When finished recording the conversation, press **PROGRAM/2WAY REC**.
  - The SCREEN/PLAYBACK indicator light goes out.

Many states have imposed regulations on the manner in which 2-way telephone conversations may be recorded, so you should inform the other party that the conversation is being recorded. Consult your local telephone company for further information.

# Remote Operation Card



## OPERATION WITH THE HANDSET

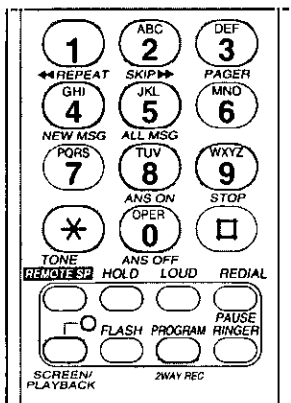

- If the SCREEN/PLAYBACK indicator flashes when you press **SCREEN/PLAYBACK**, the answering system is off. To turn it on, press **8**.

Press **SCREEN/PLAYBACK**.



Enter the desired direct commands as below.

- To play back new messages, press **4**.
- To play back all messages, press **5**.
- To repeat a message, press **1**.
- To skip a message, press **2**.  
(For more functions, see the reverse side.)



To end the remote operation, press **SCREEN/PLAYBACK**.

## OPERATION FROM A TOUCH TONE PHONE

Call your unit.



Enter your remote code \_\_\_\_\_.



Press the desired direct commands as shown here.

OR

Wait for 3 seconds and the voice menu will start. Follow the instructions. (See the reverse side.)



To end the remote operation, hang up.

No.	Direct Command
1	Repeat the message
2	Skip the message
3	Pager call on/off
4	New message playback
5	All message playback
7	Recording your greeting
9	Stop
0	Answer off
*	Greeting message skip
*4	Erasing a specific message
*5	Erasing all messages

- When you press a button, press firmly.

## ➡ Remote Operation Card

---

Press **SCREEN/PLAYBACK**.



- **To erase a specific message,** press **\*4** during the message playback.
- **To erase all messages,** press **\*5**.
- **To turn on/off the pager call feature,** press **3**.
- **To turn off the answering system,** press **0**.



To end the remote operation, press **SCREEN/PLAYBACK**.

- **To use the voice menu:**

Call your unit.



Enter your remote code \_\_\_\_\_.



After 3 seconds, the voice menu will start.



Press **1** to use the voice feature.  
OR  
Press **2** to proceed with other functions.



To end the remote operation, hang up.

- **To monitor incoming calls:**  
When the **SCREEN/PLAYBACK** indicator flashes slowly, press **SCREEN/PLAYBACK**. When finished, press the button again. To answer the call, press **TALK**.

- **To stop playback temporarily:**  
Press **9** during playback. To resume playback, press **9** again within 15 seconds.

- **To record a telephone conversation:**  
Press **PROGRAM/2WAY REC**. When finished, press **PROGRAM/2WAY REC** again.

- **To turn on the answering system:**  
Call your unit and wait for 15 rings. The unit will answer, then hang up.

- **To skip the greeting message:**  
After calling your unit, press **\*** during the greeting message playback. Callers can start recording their message after the long beep.



# Battery Replacement

---

If the RECHARGE indicator flashes after being fully charged, replace the battery with a new Panasonic HHR-P505 (KX-TCA14) battery. To order, call 1-800-332-5368. To prevent memory loss, replace within 5 minutes.

- 1 Remove the cover by sliding it while pressing the arrow.

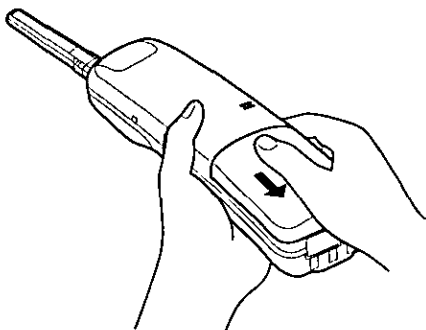

- 2 Replace the battery, then close the cover.

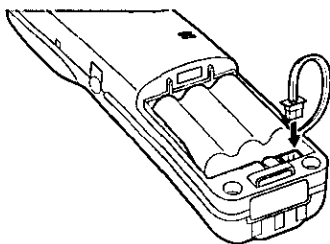

- 3 Be sure to charge the new battery for about 15 hours.

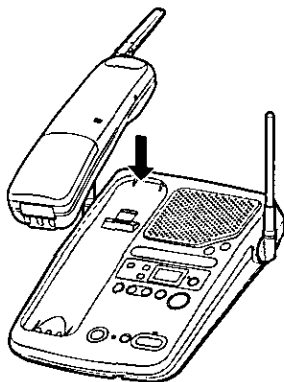

# Wall Mounting

This unit can be mounted on a wall phone plate.

- 1** Pull down the handset hook until it locks, **so the tab holds the handset.**

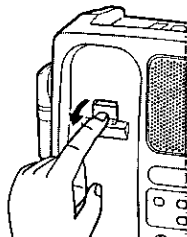

- 2** Connect the AC adaptor. Tuck the telephone line cord inside the wall mounting adaptor, then push it in the direction of the arrow.

- "UP" should face upward.

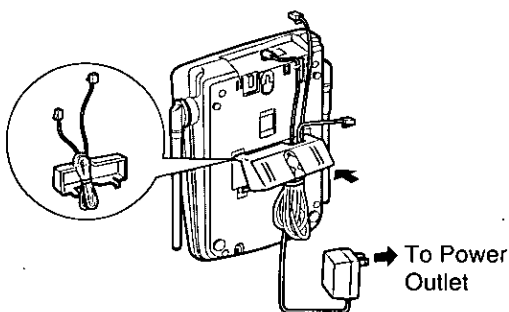

- 3** Connect the telephone line cord. Mount the unit, then slide down.

- Raise the antennas.

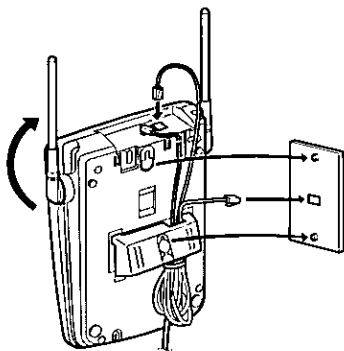

- 4** **To charge the battery:** Place the handset on the handset hook as shown.

- The IN USE/CHARGE indicator lights.

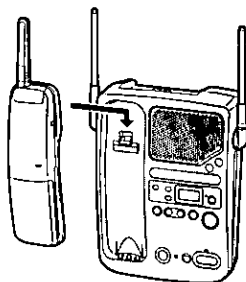

## Adding Another Phone

---

This unit will not function during a power failure. To connect a standard telephone on the same line, use the Panasonic T-adaptor KX-J66. To order, call 1-800-332-5368.

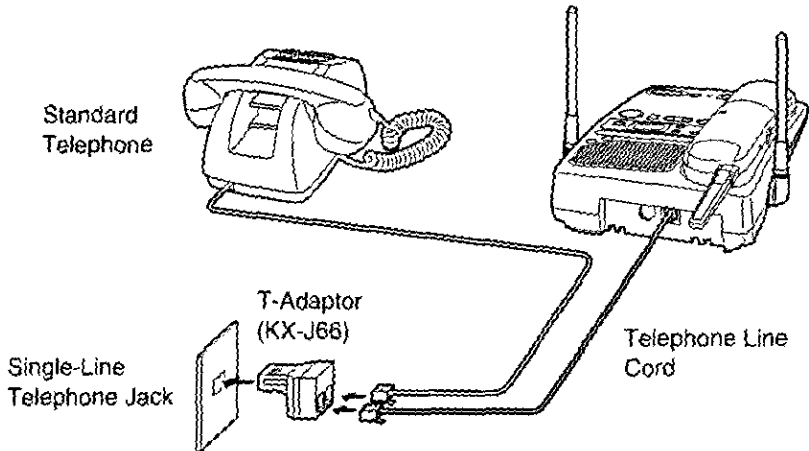

# Before Requesting Help



## Cordless Telephone

Problem	Remedy
An alarm tone sounds when you press <b>TALK</b> , <b>REMOTE SP</b> , <b>SCREEN/PLAYBACK</b> or <b>INTERCOM</b> .	<ul style="list-style-type: none"><li>• You are too far from the base unit. Move closer and try again.</li><li>• Place the handset on the base unit and try again.</li><li>• Plug in the AC adaptor.</li><li>• Raise the base unit antennas.</li></ul>
Static, sound cuts in/out, fades. Interference from other electrical units.	<ul style="list-style-type: none"><li>• Locate the handset and the base unit away from other electrical appliances (p. 3).</li><li>• Move closer to the base unit.</li><li>• Raise the base unit antennas.</li><li>• Press <b>CH</b> to select a clearer channel.</li></ul>
The handset does not ring.	<ul style="list-style-type: none"><li>• The ringer volume is set to OFF. Press <b>RINGER</b> briefly while the TALK indicator light is off (p. 14).</li></ul>
The base unit does not ring.	<ul style="list-style-type: none"><li>• The ringer volume is set to OFF. Press <b>HOLD/RINGER</b> briefly while the DIGITAL SP-PHONE indicator light is off (p. 14).</li></ul>
You cannot store a phone number in memory.	<ul style="list-style-type: none"><li>• You cannot store a number while the unit is in the talk, hold or intercom mode.</li><li>• Do not pause for over 30 seconds while storing.</li></ul>
While storing a phone number, the unit starts to ring.	<ul style="list-style-type: none"><li>• To answer the call, press <b>TALK</b>, <b>REMOTE SP</b> or <b>DIGITAL SP-PHONE</b>. The program will be canceled. Store the number again.</li></ul>

---

<b>Problem</b>	<b>Remedy</b>
<b>LOCATOR/INTERCOM</b> does not function.	<ul style="list-style-type: none"><li>•The handset is too far from the base unit or is engaged in an outside call.</li></ul>
<b>REDIAL/PAUSE</b> does not function properly.	<ul style="list-style-type: none"><li>•It will redial the last number dialed if pressed at the outset of a call (p. 26). If another number has been dialed first, it will operate as a pause button (p. 36).</li></ul>

## ► Before Requesting Help

### Answering System

Problem	Remedy
The answering system is on, but incoming messages are not recorded.	<ul style="list-style-type: none"><li>●The recording time is set to "greeting only". Select "1 minute" or "unlimited" (p. 22).</li><li>●Memory is full. Erase some or all of the messages (p. 41).</li></ul>
"FULL" is displayed and the ANSWER ON indicator flashes rapidly, and no new messages are recorded.	<ul style="list-style-type: none"><li>●Memory is full. Erase some or all of the messages (p. 41). If "FULL" is still displayed and the ANSWER ON indicator flashes rapidly, erase your greeting message and re-record a shorter greeting (p. 18, 19).</li></ul>
Some incoming messages have not been recorded completely.	<ul style="list-style-type: none"><li>●Set the CPC function to "b" (p. 24).</li></ul>
You cannot operate the answering system at the base unit.	<ul style="list-style-type: none"><li>●The handset user is operating the answering system. Wait until the IN USE/CHARGE indicator light goes out.</li></ul>
You cannot operate the answering system from a touch tone phone.	<ul style="list-style-type: none"><li>●Be sure to enter the correct remote code.</li><li>●The answering system may not respond if the tones are too short to activate the unit. Press each button firmly.</li><li>●The answering system is off. Turn it on (p. 51).</li></ul>
You cannot operate the answering system with the handset.	<ul style="list-style-type: none"><li>●Someone is operating the answering system.</li><li>●You are too far from the base unit. Move closer to the base unit.</li></ul>

## General

Problem	Remedy
The unit does not work.	<ul style="list-style-type: none"><li>● Check the settings (p. 10–17).</li><li>● Charge the battery fully (p. 11).</li><li>● Clean the charge contacts and charge again (p. 12).</li><li>● Install the battery properly (p. 57).</li><li>● Place the handset on the base unit and unplug the AC adaptor to reset. Plug in, then try again.</li><li>● Re-insert the handset battery within 5 minutes to avoid memory loss and place the handset on the base unit. Then try again.</li></ul>
You cannot program items such as the time/day adjustment (p. 20).	<ul style="list-style-type: none"><li>● Programming is not available while the unit is in the talk, speakerphone, hold or intercom mode.</li><li>● Move closer to the base unit.</li></ul>
The RECHARGE indicator flashes or the unit beeps intermittently.	<ul style="list-style-type: none"><li>● Charge the battery fully (p. 11).</li></ul>
You charged the battery fully, but the RECHARGE indicator flashes.	<ul style="list-style-type: none"><li>● Clean the charge contacts and charge again (p. 12).</li><li>● Install a new battery (p. 57).</li></ul>
The IN USE/CHARGE indicator light never goes out while charging.	<ul style="list-style-type: none"><li>● This is normal.</li></ul>
If you cannot solve your problem.	<ul style="list-style-type: none"><li>● Call our customer call center at 1-800-211-PANA(7262).</li></ul>

# Important Safety Instructions

---

When using this unit, basic safety precautions should always be followed to reduce the risk of fire, electric shock, or personal injury.

1. Read and understand all instructions.
2. Follow all warnings and instructions marked on this unit.
3. Unplug this unit from AC outlets before cleaning. Do not use liquid or aerosol cleaners. Use a damp cloth for cleaning.
4. Do not use this unit near water, for example, near a bathtub, washbowl, kitchen sink, or the like.
5. Place this unit securely on a stable surface. Serious damage and/or injury may result if the unit falls.
6. Do not cover slots and openings on the unit. They are provided for ventilation and protection against overheating. Never place the unit near radiators, or in a place where proper ventilation is not provided.
7. Use only the power source marked on the unit. If you are not sure of the type of power supplied to your home, consult your dealer or local power company.
8. Do not place objects on the power cord. Install the unit where no one can step or trip on the cord.
9. Do not overload wall outlets and extension cords. This can result in the risk of fire or electric shock.
10. Never push any objects through slots in this unit. This may result in the risk of fire or electric shock. Never spill any liquid on the unit.
11. To reduce the risk of electric shock, do not disassemble this unit. Take the unit to an authorized servicer when service is required. Opening or removing covers may expose you to dangerous voltages or other risks. Incorrect reassembly can cause electric shock when the unit is subsequently used.
12. Unplug this unit from the wall outlet and refer servicing to an authorized servicer when the following conditions occur:
  - A. When the power supply cord or plug is damaged or frayed.
  - B. If liquid has been spilled into the unit.
  - C. If the unit has been exposed to rain or water.
  - D. If the unit does not work normally by following the operating instructions. Adjust only controls covered by the operating instructions. Improper adjustment may require extensive work by an authorized servicer.
  - E. If the unit has been dropped or physically damaged.
  - F. If the unit exhibits a distinct change in performance.
13. During thunderstorms, avoid using telephones except cordless types. There may be a remote risk of an electric shock from lightning.
14. Do not use this unit to report a gas leak, when in the vicinity of the leak.

## SAVE THESE INSTRUCTIONS



---

**CAUTION:**

To reduce the risk of fire or injury to persons, read and follow these instructions.

1. Use only the battery(ies) specified.
2. Do not dispose of the battery(ies) in a fire. They may explode. Check with local waste management codes for special disposal instructions.
3. Do not open or mutilate the battery(ies). Released electrolyte is corrosive and may cause burns or injury to the eyes or skin. The electrolyte may be toxic if swallowed.
4. Exercise care in handling batteries in order not to short the battery to conductive materials such as rings, bracelets, and keys. The battery and/or conductor may overheat and cause burns.
5. Charge the battery(ies) provided with or identified for use with this product only in accordance with the instructions and limitations specified in this manual.

**WARNING:**

TO PREVENT FIRE OR SHOCK HAZARD, DO NOT EXPOSE THIS PRODUCT TO RAIN OR ANY TYPE OF MOISTURE.

# FCC and Other Information

---

If requested by the telephone company, inform them as follows:

- FCC Registration No. .... (found on the bottom of the unit)
- Ringer Equivalence .....0.2B
- The particular telephone line to which the equipment is connected.

This unit must not be connected to a coin operated line.

If you are on a party line, check with your local telephone company.

## **Ringer Equivalence No. (REN):**

The REN is useful in determining the quantity of devices you may connect to your telephone line and still have all of those devices ring when your telephone number is called. In most, but not all areas, the sum of the REN's of all devices connected to one line should not exceed five (5.0). To be certain of the number of devices you may connect to your line, as determined by the REN, you should contact your local telephone company to determine the maximum REN for your calling area.

In the event terminal equipment causes harm to the telephone network, the telephone company should notify the customer, if possible, that service may be stopped.

However, where prior notice is impractical, the company may temporarily cease service providing that they:

- (a) Promptly notify the customer.
- (b) Give the customer an opportunity to correct the problem with their equipment.
- (c) Inform the customer of the right to bring a complaint to the Federal Communication Commission pursuant to procedures set out in FCC Rules and Regulations Subpart E of Part 68.

The Telephone Company may make changes in its communications facilities, equipment, operations or procedures, where such action is reasonably required in the operation of its business and is not inconsistent with the rules and regulations in FCC Part 68.

If such changes can be reasonably expected to render any customer terminal equipment incompatible with telephone company communications facilities, or require modification or alteration of such terminal equipment, or otherwise materially affect its use or performance, the customer shall be given adequate notice in writing, to allow the customer an opportunity to maintain uninterrupted service.

When programming emergency numbers and/or making test calls to emergency numbers:

1. Remain on the line and briefly explain to the dispatcher the reason for the call before hanging up.
2. Perform such activities in the off-peak hours, such as early morning hours or late evenings.

---

**CAUTION:**

Any changes or modifications not expressly approved by the party responsible for compliance could void the user's authority to operate this device.

**Note:**

This equipment has been tested and found to comply with the limits for a Class B digital device, pursuant to Part 15 of the FCC Rules. These limits are designed to provide reasonable protection against harmful interference in a residential installation. This equipment generates, uses, and can radiate radio frequency energy and, if not installed and used in accordance with the instructions, may cause harmful interference to radio communications. However, there is no guarantee that interference will not occur in a particular installation. If this equipment does cause harmful interference to radio or television reception, which can be determined by turning the equipment off and on, the user is encouraged to try to correct the interference by one or more of the following measures:

- Reorient or relocate the receiving antenna.
- Increase the separation between the equipment and receiver.
- Connect the equipment into an outlet on a circuit different from that to which the receiver is connected.
- Consult the dealer or an experienced radio/TV technician for help.

Some cordless telephones operate at frequencies that may cause interference to nearby TVs and VCRs. To minimize or prevent such interference, the base of the cordless telephone should not be placed near or on top of a TV or VCR.

If interference is experienced, move the cordless telephone further away from the TV or VCR. This will often reduce or eliminate interference.

- **Environment**—do not place the unit in room where the temperature is less than 5°C (41°F) or greater than 40°C (104°F). Allow 10 cm (4") clearance around the unit for proper ventilation. Avoid excessive smoke, dust, mechanical vibration, shock, or direct sunlight.
- **Medical**—consult the manufacturer of personal medical devices, such as pacemakers, to determine if they are adequately shielded from external RF (radio frequency) energy. (The unit operates in the frequency range of 909MHz to 921MHz and 2400MHz to 2485MHz and the power output level can range from 0.01 watts to 0.26 watts.) Do not use the unit in health care facilities when any regulations posted in the area instruct you to do so. Hospitals or health care facilities may be using equipment that could be sensitive to external RF (radio frequency) energy.
- **Routine care**—wipe the unit with a soft cloth. Do not use benzine, thinner, or any abrasive powder. When you leave the unit unused for a long period of time, unplug the AC adaptor from the outlet.
- **If there is any trouble**—disconnect the unit from the telephone line and connect a known working phone. If the known working phone operates properly, have your unit repaired by one of the authorized Panasonic Factory Service Centers. If the known working phone does not operate properly, consult with your telephone company.

## For product service

- Panasonic Servicenters are listed in the servicenter directory.
- Call 1-800-211-PANA(7262) for the location of an authorized servicenter.

## When you ship the product

- Carefully pack your unit, preferably in the original carton.
- Attach a letter, detailing the symptom, to the outside of the carton.

### Symptom

---

- Send the unit to an authorized servicenter, prepaid and adequately insured.
- Do not send your unit to the Panasonic Consumer Electronics Company listed below or to executive or regional sales offices. These locations do not repair consumer products.

- This cordless telephone is designed for use in the United States of America. Sale or use of this product in other countries may violate local laws.
- Ce téléphone sans fil est conçu pour être utilisé aux États-Unis d'Amérique. La vente ou l'emploi de cet appareil dans certains autres pays peut constituer une infraction à la législation locale.
- Este teléfono sin cordón fue elaborado para uso en los Estados Unidos de América. La venta o el empleo de este producto en ciertos países puede constituir violación de la legislación local.
- このコードレス電話機は、日本国外での使用を目的として設計されており、日本国内での使用は法律違反となります。従って、当社では日本国内においては原則として修理などのサービスは致しかねます。

**Panasonic Consumer Electronics Company,  
Division of Matsushita Electric Corporation of America**  
One Panasonic Way, Secaucus, New Jersey 07094

**Panasonic Sales Company,  
Division of Matsushita Electric of Puerto Rico, Inc.**  
Ave. 65 de Infantería, Km. 9.5, San Gabriel Industrial Park  
Carolina, Puerto Rico 00985