

**Section 300**  
Issue 1  
August 1990  
S-DBS 308/616 (V1.0)

# Installation Instructions

Small Digital Business System  
**308/616**

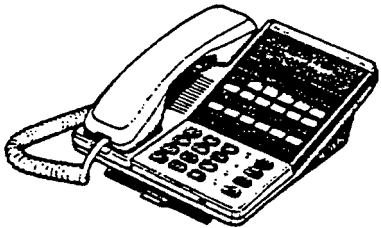
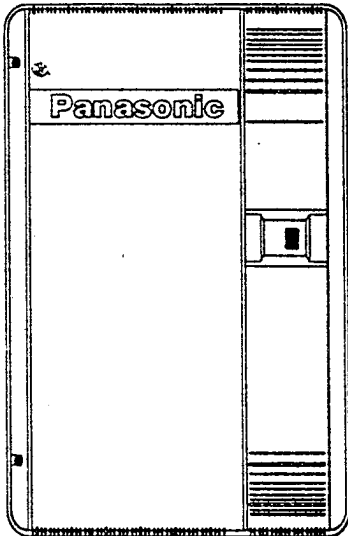
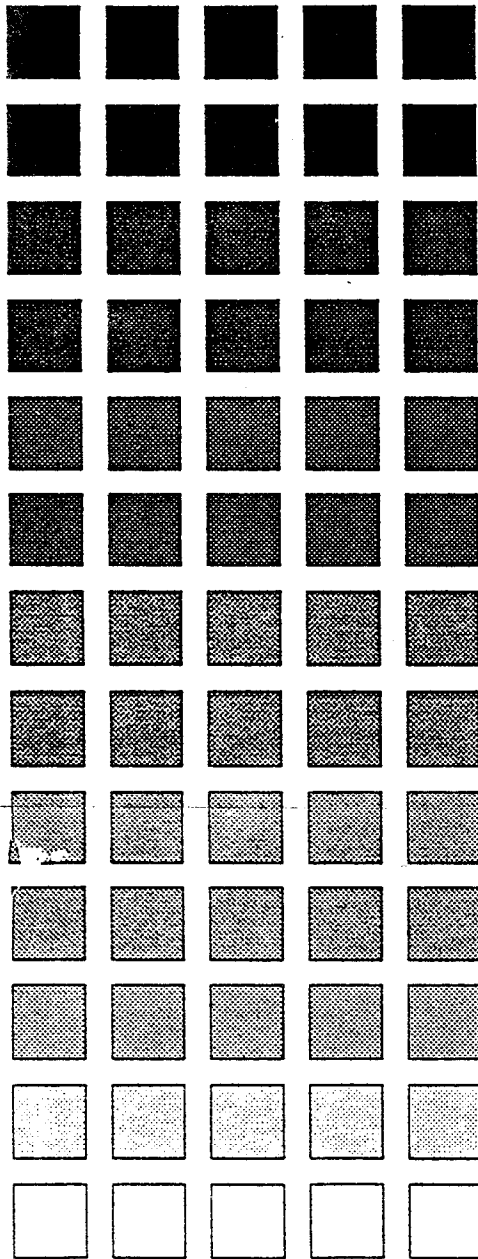

**Panasonic**  
**Digital Business System**  
Small D.B.S. 308 / 616

art

Panasonic

## **FCC RULES AND REGULATIONS (Part 68)**

In compliance with the requirements of Part 68 of the FCC Rules and Regulations for connection of terminal equipment to the telephone network, and for your convenience, the following information is presented.

### **Notifying the Telephone Company**

When connecting or disconnecting the terminal equipment to the telephone network, inform the telephone company of the particular line (s) for connection, the FCC registration number and ringer equivalence number of the registered terminal equipment.

---

### **FCC Registration Numbers**

<b>Model Numbers</b>	<b>Key System</b>	<b>Hybrid System</b>
<b>VB-42010 (DBS308)</b>	<b>ACKUSA-61853-KF-E</b>	<b>ACKUSA-61855-MF-E</b>
<b>VB-42020 (DBS616)</b>	<b>ACKUSA-61854-KF-E</b>	<b>ACKUSA-61856-MF-E</b>

When enabling Pooled Trunk Access, inform the telephone company or a Panasonic service center of the MF-E FCC Registration number. According to FCC rules, Pooled Trunk Access is regarded as one of the distinguishing features of a PBX as opposed to a key telephone system.

### **RINGER EQUIVALENCE NUMBER (REN) 0.5 B**

The REN determines the number of devices you may connect to your telephone line and still have all those devices ring when your telephone number is called. In most, but not all areas, the sum of the REN's of all devices connected to one line should not exceed five (5.0). You should contact your local telephone company to determine the maximum REN for your calling area.

---

Service order code	9.0F
Network address signaling code	E
Facility interface code	02LS2 (2 wire/Loop start)
Required network interface code	RJ25C

### **Connection to a Party Line or Coin Operated Telephone Line**

**Direct Connection to a Party Line or Coin Operated Telephone Line Is Prohibited.**

If you are on a party line, check with your local telephone company for further information.

### **Incidence of Harm to the Telephone Lines**

Should terminal equipment cause harm to the telephone network, the telephone company shall, where practical, notify the customer that temporary discontinuance of service may be required. However, where prior notice is not practical, the telephone company may temporarily discontinue service forthwith, if such action is reasonable in the circumstances. In case of un-notified temporary discontinuance of service, the telephone company shall:

- (A) Promptly notify the customer of such temporary discontinuance of service.
- (B) Afford the customer the opportunity to correct the situation which gave rise to the temporary discontinuance.
- (C) Inform the customer of the right to bring a complaint to the Commission pursuant to the procedures set out in Part 68 of the FCC Rules and Regulations.

### **Compatibility of the Telephone Network and Terminal Equipment**

- (A) Availability of telephone information

Technical information on interface parameters and specifications not set by FCC Rules, including the number of ringers which may be connected to a particular telephone line to permit terminal equipment to operate in a manner compatible with telephone company communications facilities, shall be provided by the telephone company upon customer's request.

- (B) Changes in telephone company communications facilities, equipment, operations and procedures.

The telephone company may make changes in its communications facilities, equipment, operations or procedures, where such action is reasonably required in the operation of its business and is not inconsistent with the rules and regulations in FCC Part 68. If such changes can be reasonably expected to render any customer's terminal equipment incompatible with telephone company communications facilities or require modification or alteration of such terminal equipment or otherwise materially affect its use or performance, the customer shall be given adequate notice in writing to allow the customer an opportunity to maintain un-interrupted service.

### **Hearing Aid Compatibility**

This system is hearing-aid compatible.

### **Automatic Dialers**

#### **When Programming Emergency Numbers or Making Test Calls to Emergency Numbers:**

- (A) Remain on the line and briefly explain to the dispatcher the reason for the call.
- (B) Perform such activities in the off-peak hours, such as early morning or late evening.

## **Responsibility of Grantee (Manufacturer) of Registered Equipment**

**The Grantee or its agent shall provide the user of the registered equipment with the following:**

- (A) Instructions concerning installation, operation and repair procedures, where applicable.
- (B) Notification that the registered terminal equipment may not be used with party lines or coin lines.
- (C) Instruction indicating that when trouble is experienced the customer shall disconnect the registered equipment from the telephone line to determine whether it is malfunctioning. If so, the use of such equipment shall be discontinued until the problem has been corrected.
- (D) If connections other than RJ25C are needed, contact the local telephone company.\*

## **Product Safety**

**Please Observe the Following Guidelines to Assure the Safe Use of Your Telephone**

- (A) This product is an electrical device and can be hazardous if immersed in water.
- (B) To avoid the risk of electrical shock, do not use this unit while in the bathtub, shower, or when wet. If you accidentally drop the unit into water, unplug it first, then retrieve it by pulling the cord.
- (C) The telephone should not be exposed to heat sources, direct sunlight, extreme temperatures, moisture, strong vibrations, greasy or dusty environments.
- (D) Never attempt to insert wires, pins or similar objects in the vents or openings of the telephone.
- (E) Never clean the telephone with benzol, paint thinner or other solvent materials.
- (F) Never install telephone wiring during a lightning storm.
- (G) Never install telephone jacks in a wet area unless they are specifically designed for that purpose.
- (H) Never touch un-insulated telephone wires or terminals unless the telephone line has been disconnected at the network interface.

## **Radio Interference (Part 15)**

**Warning** - This unit generates, uses and can radiate radio frequency energy. If not installed and used in accordance with the instructions manual, the unit may cause radio interference. The Unit has been tested and found to comply with the limits for a Class A digital device pursuant to Part 15 of FCC Rules, which are designed to provide reasonable protection against such interference when operated in a commercial environment.

Operation of this equipment in a residential area is likely to cause harmful interference in which case the user at his own expense will be required to take whatever measures necessary to correct the interference.

If necessary, the user should consult the dealer or an experienced radio/television technician for additional suggestions.

The user may find the following booklet prepared by the Federal Communications Commission helpful:

### **Something about Interference**

This booklet is available from the FCC local regional offices.

# Table of Contents

FCC RULES AND REGULATIONS (Part 68) .....	iii
Notifying the Telephone Company .....	iii
RINGER EQUIVALENCE NUMBER (REN) 0.5 B .....	iii
Connection to a Party Line or Coin Operated Telephone Line .....	iii
Incidence of Harm to the Telephone Lines .....	iv
Compatibility of the Telephone Network and Terminal Equipment .....	iv
Hearing Aid Compatibility .....	iv
Automatic Dialers .....	iv
Responsibility of Grantee (Manufacturer) of Registered Equipment .....	v
Product Safety .....	v
Radio Interference (Part 15) .....	v
INTRODUCTION .....	1
POOLED TRUNK ACCESS .....	2
ENVIRONMENT .....	4
Electrical Noise .....	4
Gas and Airborne Particles .....	4
Humidity .....	4
Lighting .....	4
Lightning .....	4
Temperature .....	4
Vibration .....	5
Water Factor .....	5

INSTALLATION .....	6
Main Unit .....	6
Removing the Main Cabinet Cover .....	6
Wall-Mounting Procedure for the Main Cabinet Cover .....	7
Installing the Backup Battery .....	8
Initializing the System.....	9
Key Telephone .....	10
Wall-Mounting Procedure .....	10
Trunk Lines .....	11
Connecting the Trunk Lines .....	11
Internal Lines .....	13
Connecting the Telephone.....	13
SMDR Interface Card.....	19
Feature Package "B" .....	19
Installing the SMDR Card .....	20
Doorphone Interface Card .....	22
Installing the Doorphone Interface .....	22
Door Box .....	24
Connecting the Door Box .....	24
Power Failure Unit.....	25
Wall-Mounting Procedure .....	25
Connecting the Power Failure Unit .....	26
Music-On-Hold (MOH) .....	28
External Paging .....	29

## FIGURES

1. Main Unit - RAM Switch .....	2
2. System Connection Layout .....	3
3. Removing the Main Cabinet Cover .....	6
4. Wall-Mounting Procedure for the Main Cabinet Cover .....	7
5. Installing the Backup Battery .....	8
6. Initializing the System .....	9
7. Wall-Mounting Procedure for the Key Telephone .....	10
8. Connecting the Trunk Lines .....	12
9. Connecting the Telephone .....	13
10. 66 Split Block .....	18
11. SMDR Interface Card - Feature Package "B" .....	19
12. Installing the SMDR CARD .....	22
13. Doorphone Interface Card .....	23
14. Connecting the Door Box .....	24
15. Connecting the Power Failure Unit .....	27
16. Connecting Music Source to the MOH Connector .....	28
17. Connecting the Paging Speaker to the Amplifier .....	29

## TABLES

1. System Configuration .....	1
2. Extension Connector S-DBS 308/616 .....	14,15
2A. Extension Connector S-DBS 616 .....	16,17
3. Printer Connection .....	20
4. Wire Gauges .....	22,24
5. MOH Input Impedance .....	28
6. EPA Output Impedance .....	29

## INTRODUCTION

---

The S-DBS is available in two basic system configurations, each has a different number of outside and internal lines.

**TABLE 1. System Configuration**

<b>System Designation</b>	<b>Trunk Ports</b>	<b>Extension Ports</b>
<b>VB-42010/DBS 308</b>	<b>3</b>	<b>8</b>
<b>VB-42020/DBS 616</b>	<b>6</b>	<b>16</b>

The S-DBS consists of the main unit, telephones and various peripheral equipment and requires installation, wiring and programming. This manual describes the installation and wiring procedures.



## POOLED TRUNK ACCESS

### PROGRAMMING FOR AN AUTOMATIC OUTSIDE LINE GROUP

This function cannot be programmed until one jumper cable on the KSU has been cut. After cutting the cable and programming for Pooled Trunk Access, calls are automatically connected to an outside line.

### FCC Registration Numbers

Model Numbers	Key System	Hybrid System
VB-42010 (DBS308)	ACKUSA-61853-KF-E	ACKUSA-61855-MF-E
VB-42020 (DBS616)	ACKUSA-61854-KF-E	ACKUSA-61856-MF-E

When enabling Pooled Trunk Access, inform the telephone company or a Panasonic service center of the MF-E FCC Registration number. According to FCC rules, Pooled Trunk Access is regarded as one of the distinguishing features of a PBX as opposed to a key telephone system.

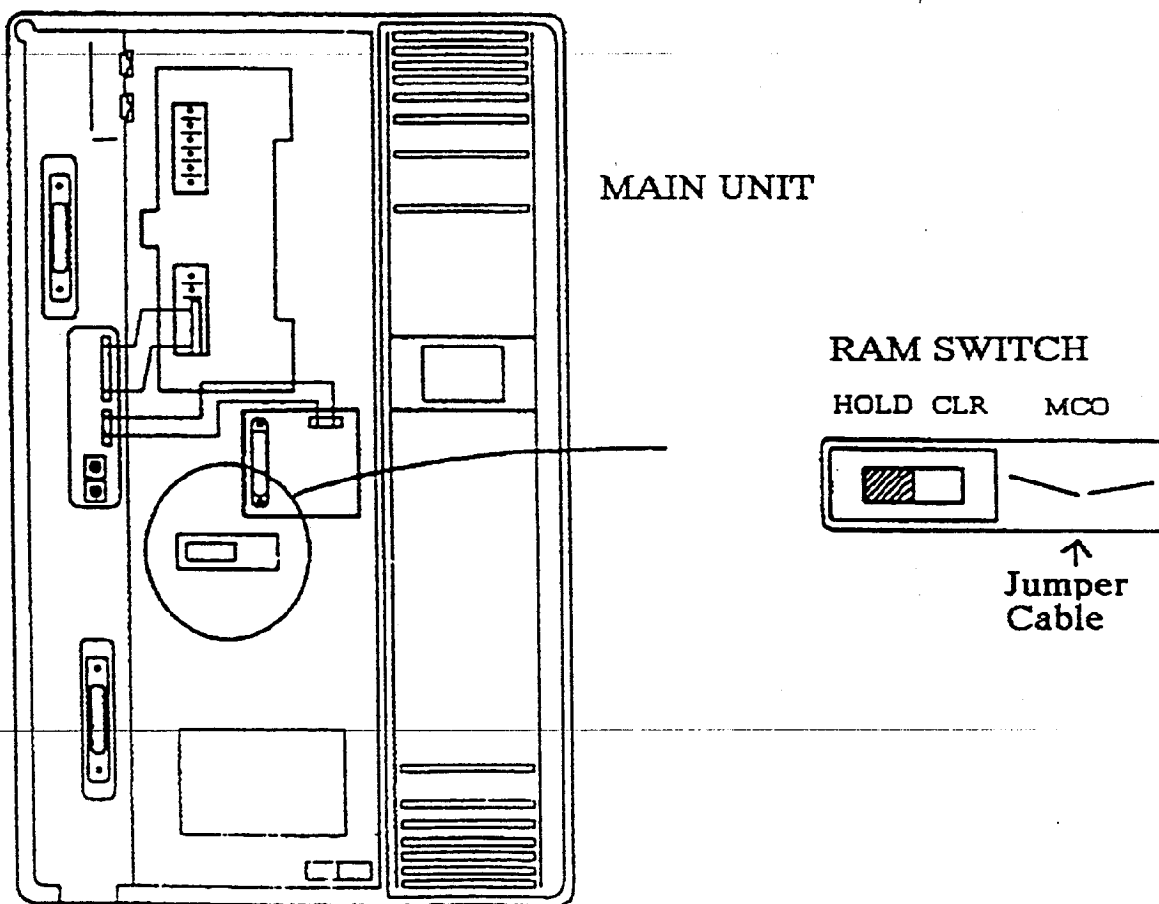
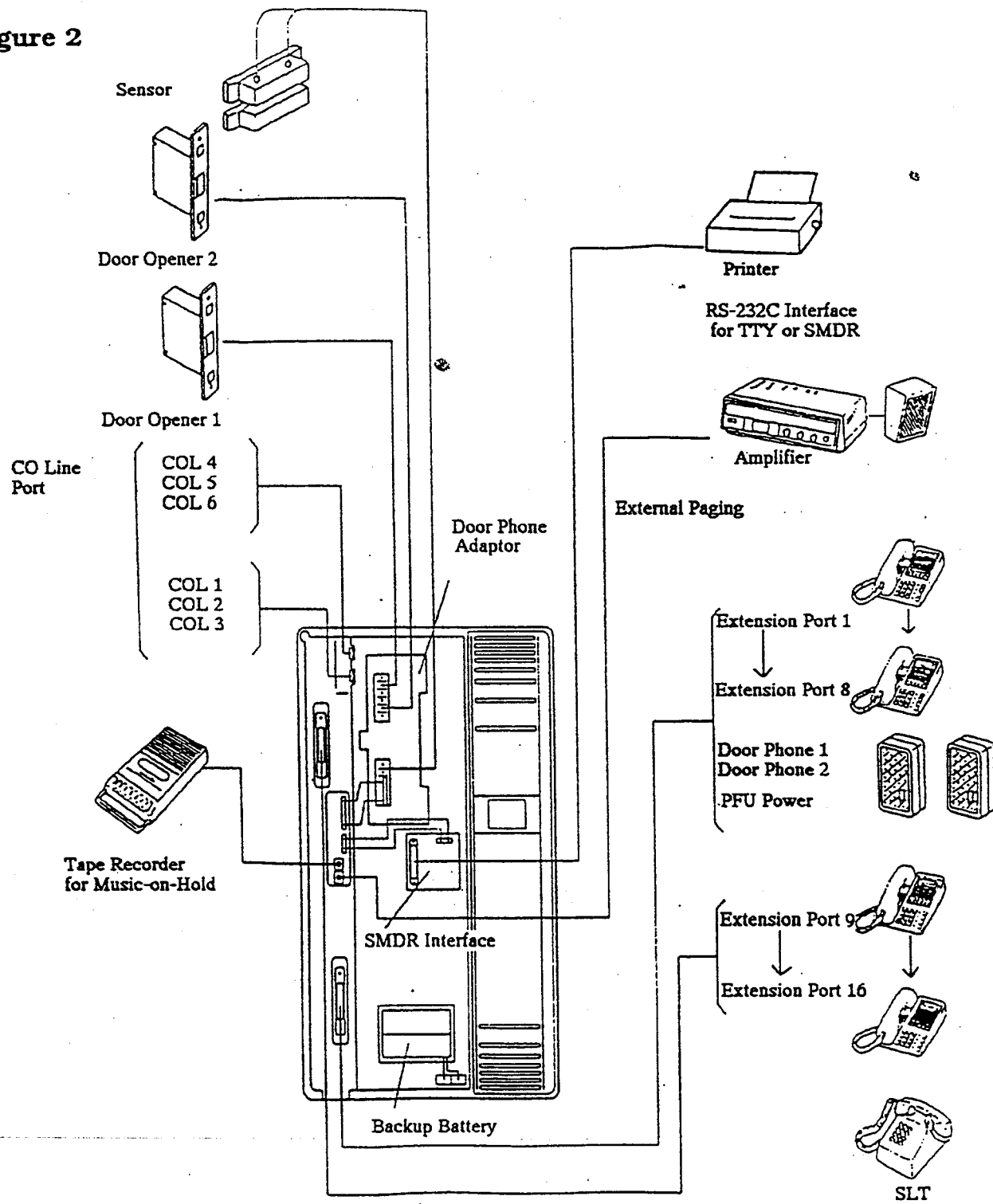

Figure 1

### SYSTEM CONNECTION LAYOUT

Figure 2



## **ENVIRONMENT**

### **Electrical Noise**

Electrical noise might disturb the operation of the system's digital control circuits. Place the equipment away from heavy motors, welders or dimmers, and radio receivers and computers which generate electrical noise.

Conversely, this system may interfere with radio receivers and computers. Place the main unit at least 10 feet (3 meters) away from all other equipment.

### **Gas and Airborne Particles**

To avoid corrosion or oxidation of electrical relay contacts, place the equipment in an area free of airborne particles and corrosive gas.

### **Humidity**

Excessive humidity may oxidize the metallic parts and cause errors in performance. Do not install equipment in high humidity areas.

---

**Humidity: 30% to 90% relative humidity  
Non-Condensing**

### **Lighting**

Appropriate lighting is required when servicing the main unit.

### **Lightning**

Protect the system from lightning by properly grounding the AC cable as well as installing voltage surge suppressors and diode clamps on all external cables attached to the system.

### **Temperature**

Integrated circuits (ICs) and Large Scale Integrated circuits (LSIs) require adequate ventilation for the main unit to allow upward circulation of air through the cabinet grille.

Operating room temperature: 0°C to 40°C (32°F to 104°F)

Storage Temperature: -10°C to 50°C (14°F to 122°F)

## **ENVIRONMENT** (continued)

### **Vibration**

Do not install the system in an area with excessive vibration which can cause disconnection or loosening of components.

### **Water Factor**

Water is a dangerous hazard to equipment and can totally damage the system. Do not place the equipment near anything containing water or under overhead plumbing, sprinkler system valves or in areas that are susceptible to flooding.

## INSTALLATION

### MAIN UNIT

Always set the power switch to **OFF** before installing or connecting the AC power to the key system unit (KSU).

Use the appropriate screwdriver to fasten the screws.

Handle the Main Unit carefully to avoid damaging the cover.

#### 1. Removing the Main Unit Cover

- a) Remove the two screws (a) from the front cover (B) of the main unit.
- b) Remove the front cover (B) by pulling it to the left (b).

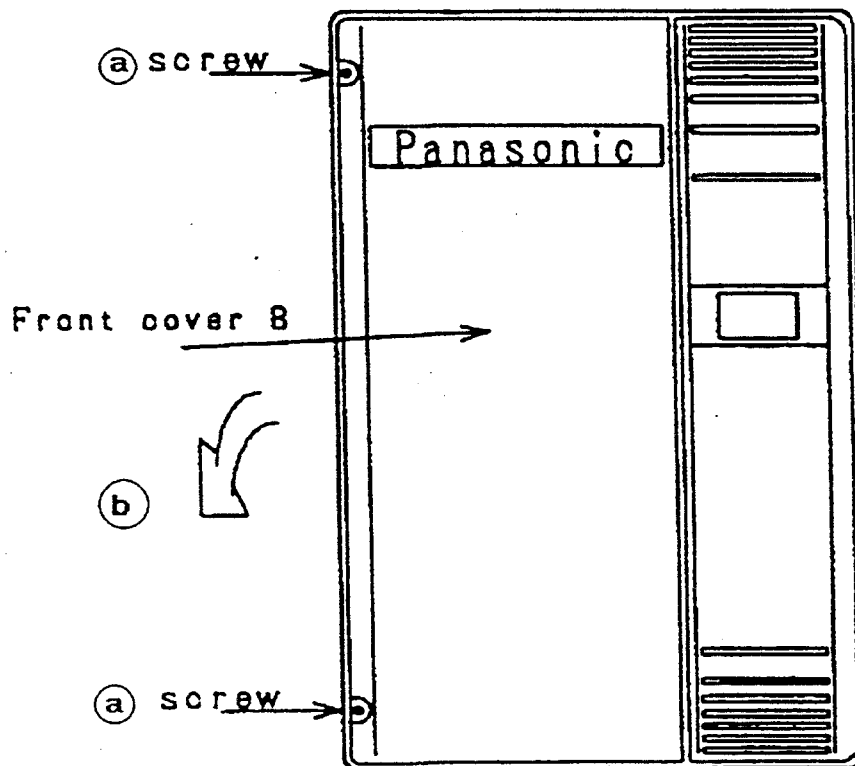
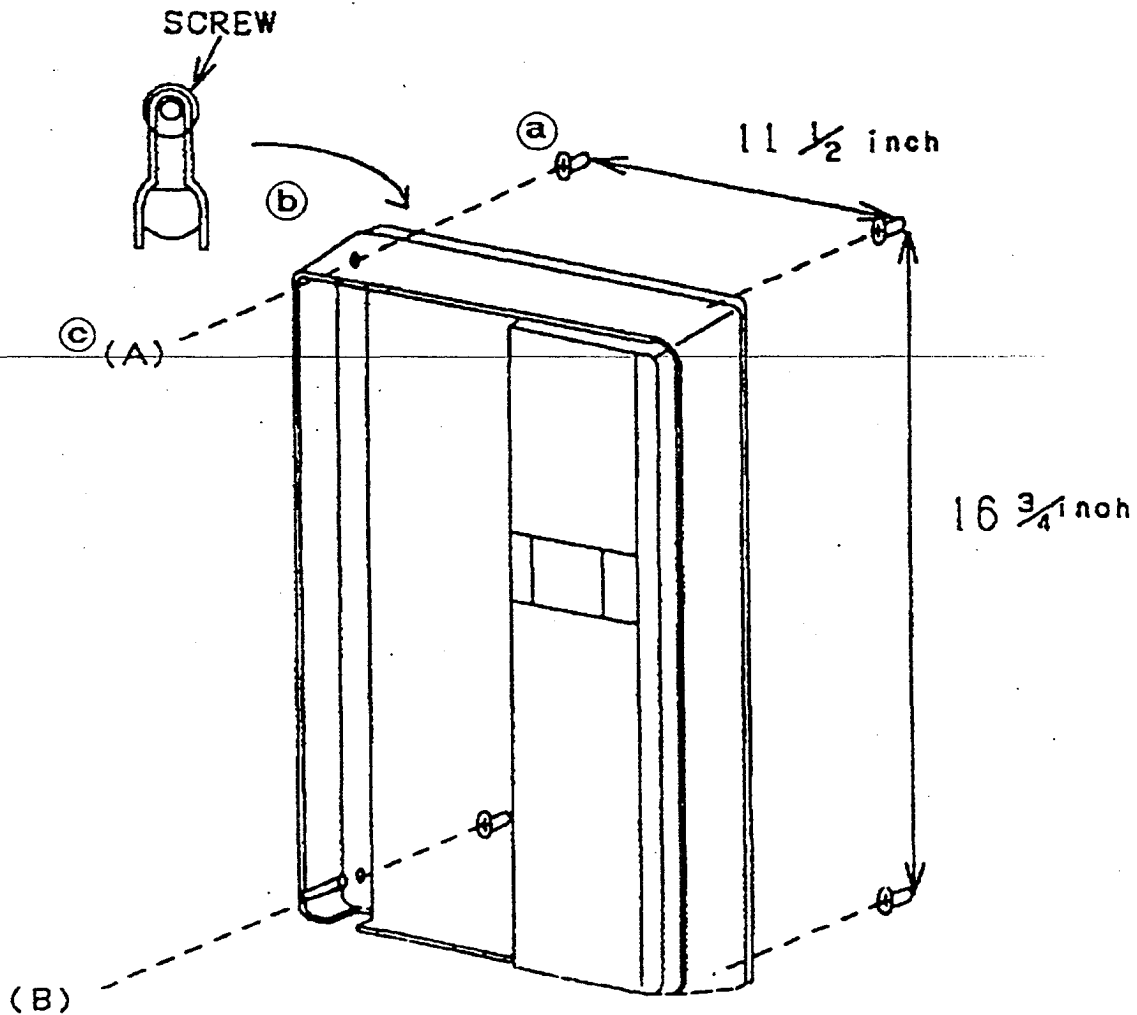

Figure 3

**INSTALLATION** (continued)

**2. Wall-Mounting Procedure for the Main Cabinet Cover**

- a) Attach four screws loosely to a wall strong enough to hold the weight of a KSU. The screws should stand out one-fourth of an inch from the wall surface.
- b) Pass the screws through the holes on the back of the main cabinet and pull the cabinet in a downward direction.
- c) Tighten the two screws (A) and (B) with a screwdriver to secure the cabinet to the wall.



**Figure 4**

## INSTALLATION (continued)

### 3. Installing the Backup Battery

- a) Place the backup batteries (VB-42130) in the battery compartment of the KSU.
- b) Insert the connector cord of the batteries onto the BAT terminals of the KSU (+ and -).

In case of power failure the backup battery will support normal system operation for, approximately, 30 minutes under full-load for the DBS308 system and, approximately, 20 minutes for the DBS616 system.

The batteries are trickle charged during normal system operation.

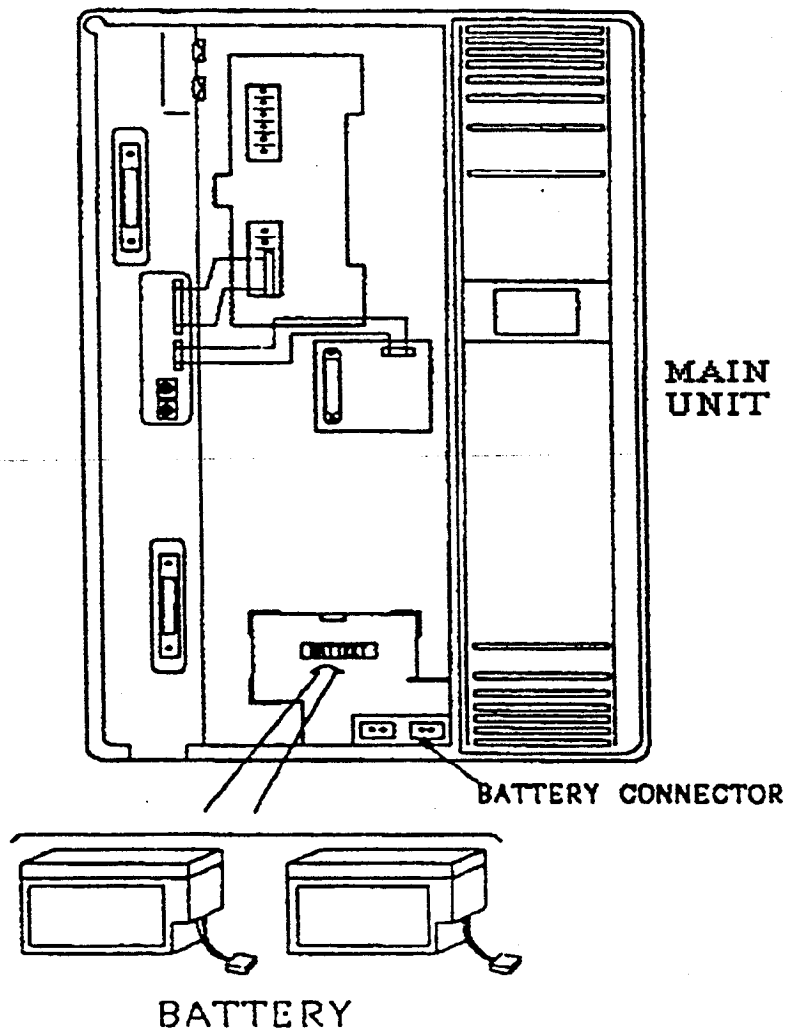

Figure 5

## INSTALLATION (continued)

### 4. Initializing the System

- a) Set the power switch of the main unit to **OFF**.
- b) Set the **RAM** switch in the center of the KSU from the **HOLD** to the **CLEAR** position.
- c) Turn the power switch of the main unit to **ON**.
- d) Set the **RAM** switch back to **HOLD**.

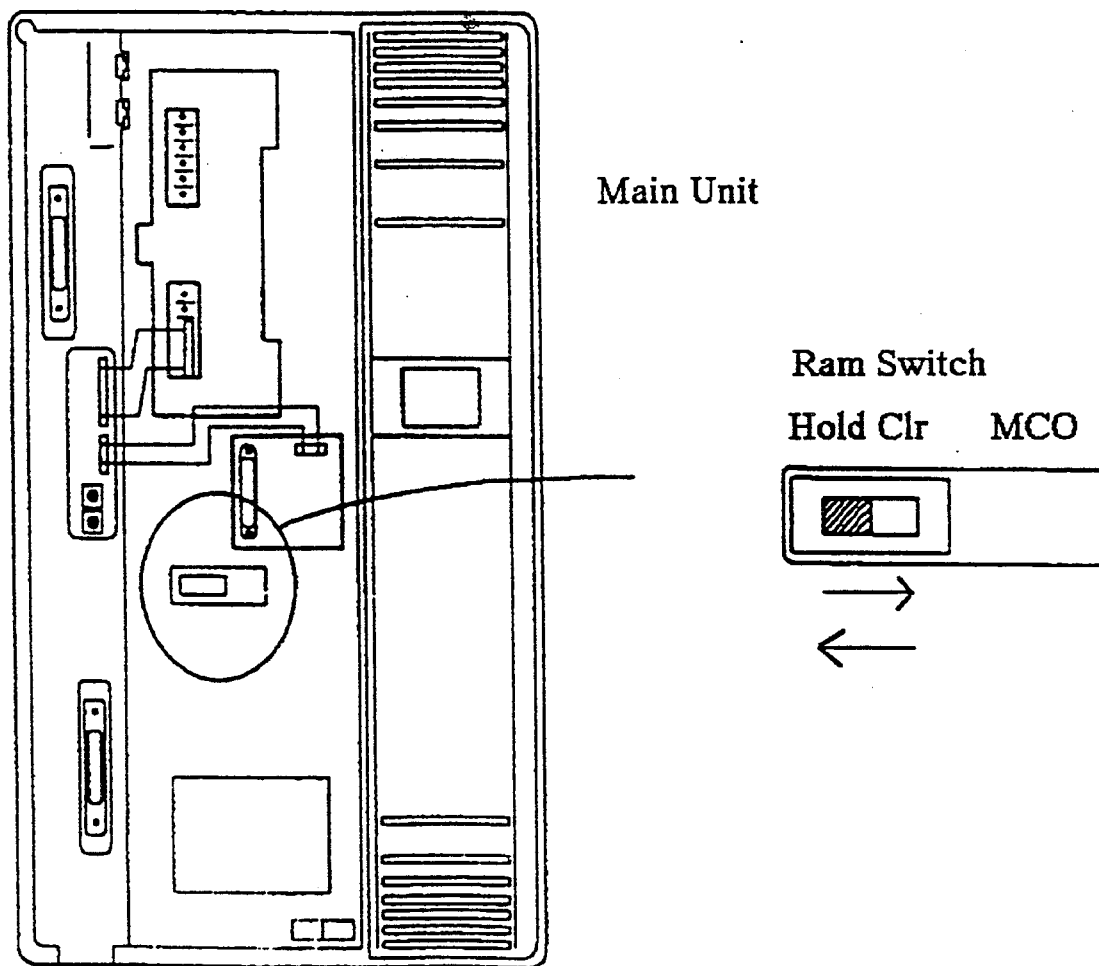

Figure 6



## KEY TELEPHONE

### 1. Wall-Mounting Procedure

- a) Place the telephone face down on a soft surface. Push in on the wide end of the dark grey wall adapter with thumbs or heels of hands until the adapter is released.
- b) Turn the adapter upside down. Insert the guides into the two adapter mounting holes at the lower end of the key telephone, then push in the adapter.
- c) Place the mounting holes of the bracket over the studs of the modular jack and pull the telephone downward to secure it in place. Short station cords are provided for wall mounting.
- d) Remove the handset guide by pulling it up and out with fingernail or screwdriver. Turn the guide upside down and reinsert it into the handset.

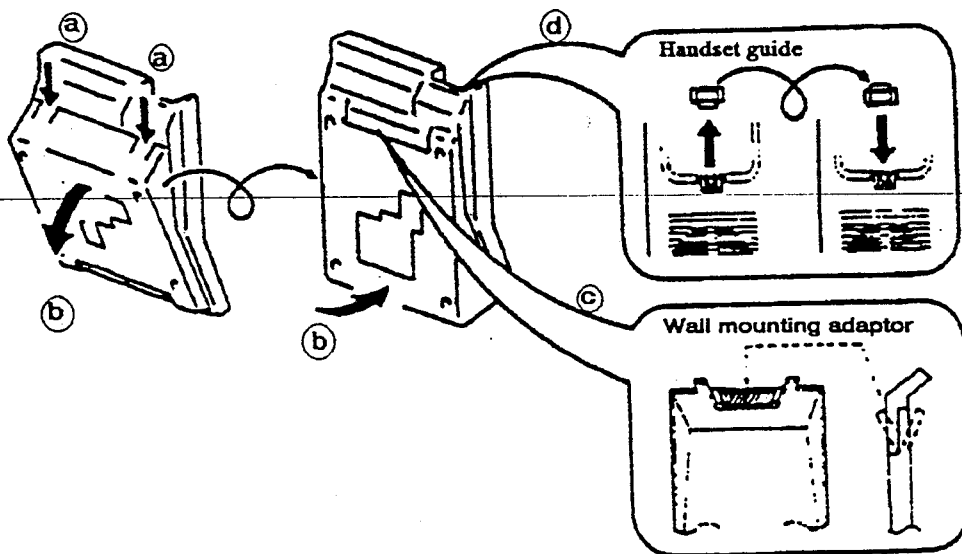

Figure 7

## **TRUNK LINES**

### **1. Connecting the Trunk Lines**

The telephone cable from the CO/PBX line can be directly connected to the outside line jack on the main unit.

The DBS308 system has a six-pin modular jack (RJ-25C) for COL 1, COL 2, and COL 3. The DBS616 system has two modular jacks for COL 1, COL 2 and COL 3, and COL 4, COL 5 and COL 6.

Connect the outside lines to the COL jack with a 6-wire modular cord no longer than 15 feet.

**TRUNK LINES** (continued)

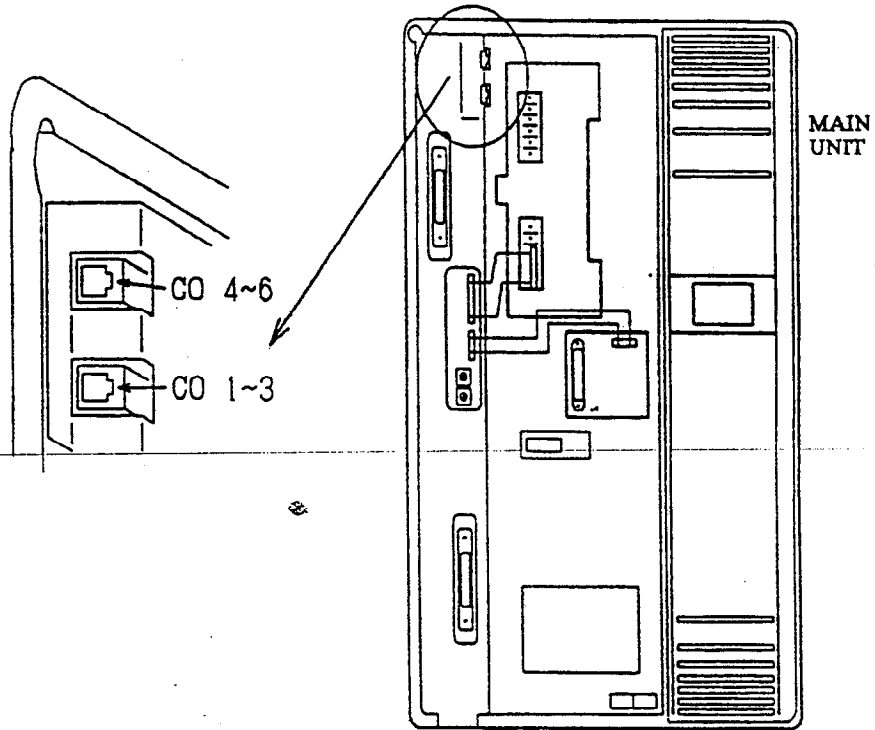

**Figure 8**

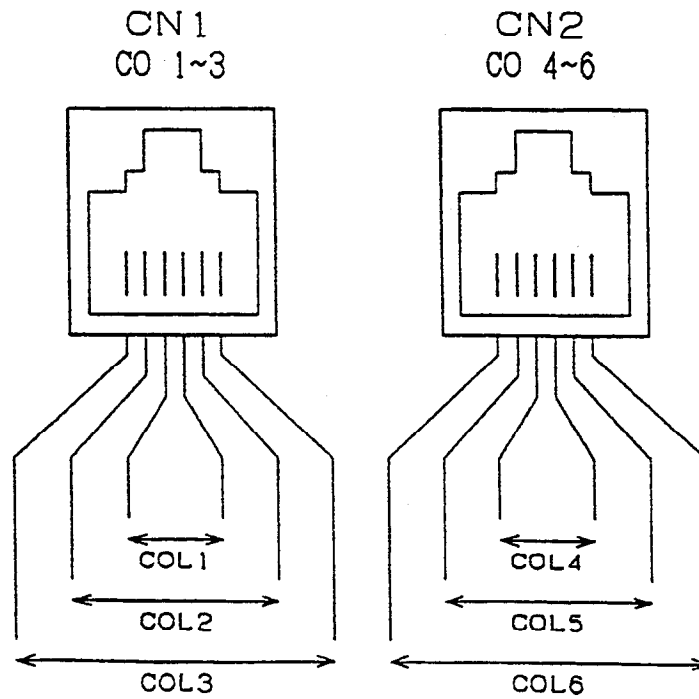

## INTERNAL LINES

Use a female 25-pair cable to connect the extension ports to a 50-pin split block.

The DBS308 system has one connector on the main unit for extensions 1 to 8, DPH1, DPH2 and PFU output. The DBS616 has two connectors for extensions 1 to 8 and extensions 9 to 16.

Except for ports 1 and 2 which are for key telephones **only**, each extension port can connect a key telephone and/or a single line telephone (SLT).

### 1. Connecting the Telephone

- a) For each telephone connect two wires to the appropriate pins of the split block. (See TABLE 2 and Figure 10 for Extension Connectors)
- b) Plug the 50-pin connector of the split block to the extension port on the main unit.

**NOTE:** The 25-pair amphenol connector which leads to the split block is held in place by a plastic tie. The tie can be attached to two hooks on either side of the connector. (See Figure 9 below)

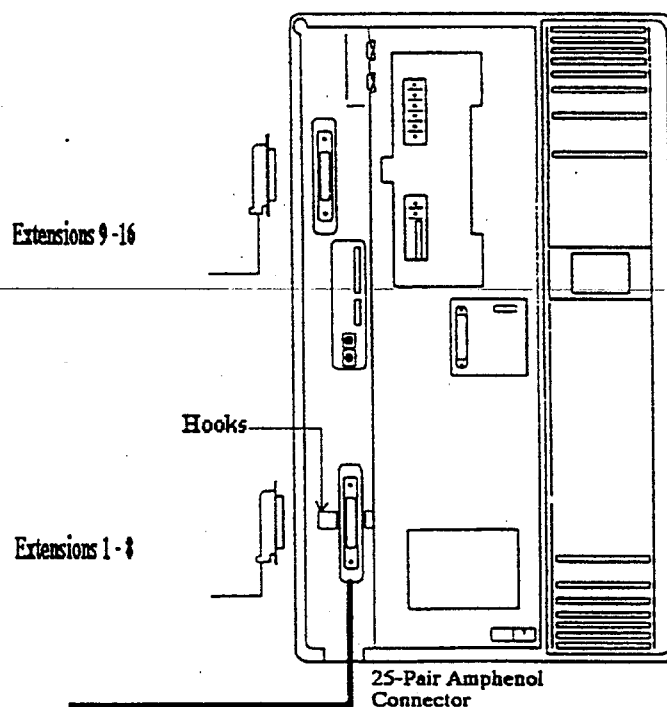

Figure 9

**TABLE 2. Extension Connector for S-DBS 308/616**

Color Cable Code	Pin#	EXT 1-8	Clip	Station Cord
WH-BL BL-WH	26 1	K-TEL 1 (24V) K-TEL 1 GND	1 2	Green Red
WH-OR OR-WH	27 2	N/C N/C	3 4	Black Yellow
WH-GN GN-WH	28 3	K-TEL 2 (24V) K-TEL 2 GND	5 6	Green Red
WH-BR BR-WH	29 4	N/C N/C	7 8	Black Yellow
WH-SL SL-WH	30 5	K-TEL 3 (24V) K-TEL 3 GND	9 10	Green Red
RD-BL BL-RD	31 6	SLT 3 (24V) SLT 3 GND	11 12	Black Yellow
RD-OR OR-RD	32 7	K-TEL 4 (24V) K-TEL 4 GND	13 14	Green Red
RD-GN GN-RD	33 8	SLT 4 (24V) SLT 4 GND	15 16	Black Yellow
RD-BR BR-RD	34 9	K-TEL 5 (24V) K-TEL 5 GND	17 18	Green Red
RD-SL SL-RD	35 10	SLT 5 (24V) SLT 5 GND	19 20	Black Yellow
BK-BL BL-BK	36 11	K-TEL 6 (24V) K-TEL 6 GND	21 22	Green Red
BK-OR OR-BK	37 12	SLT 6 (24V) SLT 6 GND	23 24	Black Yellow
BK-GN GN-BK	38 13	K-TEL 7 (24V) K-TEL 7 GND	25 26	Green Red
BK-BR BR-BK	39 14	SLT 7 (24V) SLT 7 GND	27 28	Black Yellow
BK-SL SL-BK	40 15	K-TEL 8 (24V) K-TEL 8 GND	29 30	Green Red
YL-BL BL-YL	41 16	SLT 8 (24V) SLT 8 GND	31 32	Black Yellow

**TABLE 2. Extension Connector for S-DBS 308/616 (continued)**

Color Cable Code	Pin#	EXT 1-8	Clip	Station Cord
YL-OR	42	N/C	33	Green
OR-YL	17	N/C	34	Red
YL-GN	43	N/C	35	Black
GN-YL	18	N/C	36	Yellow
YL-BR	44	N/C	37	Green
BR-YL	19	N/C	38	Red
YL-SL	45	DHP 1 (24V)	39	Black
SL-YL	20	DHP 1 GND	40	Yellow
VI-BL	46	DHP <sup>2</sup> (24V)	41	Green
BL-VI	21	DHP 2 GND	42	Red
VI-OR	47	N/C	43	Black
OR-VI	22	N/C	44	Yellow
VI-GN	48	+24V to PFU	45	Green
GN-VI	23	+24V to PFU	46	Red
VI-BR	49	N/C	47	Black
BR-VI	24	N/C	48	Yellow
VI-SL	50	GND to PFU	49	-
SL-VI	25	GND to PFU	50	-

**NOTE:** N/C = No connection

**TABLE 2A. Extension Connector for S-DBS 616**

Color Cable Code	Pin#	EXT 9-16	Clip	Station Cord
WH-BL	26	K-TEL 9 (24V)	1	Green
BL-WH	1	K-TEL 9 GND	2	Red
WH-OR	27	SLT 9 (24V)	3	Black
OR-WH	2	SLT 9 GND	4	Yellow
WH-GN	28	K-TEL 10 (24V)	5	Green
GN-WH	3	K-TEL 10 GND	6	Red
WH-BR	29	SLT 10 (24V)	7	Black
BR-WH	4	SLT 10 GND	8	Yellow
WH-SL	30	K-TEL #1 (24V)	9	Green
SL-WH	5	K-TEL 11 GND	10	Red
RD-BL	31	SLT 11 (24V)	11	Black
BL-RD	6	SLT 11 GND	12	Yellow
RD-OR	32	K-TEL 12 (24V)	13	Green
OR-BD	7	K-TEL 12 GND	14	Red
RD-GN	33	SLT 12 (24V)	15	Black
GN-RD	8	SLT 12 GND	16	Yellow
RD-BR	34	K-TEL 13 (24V)	17	Green
BR-RD	9	K-TEL 13 GND	18	Red
RD-SL	35	SLT 13 (24V)	19	Black
SL-RD	10	SLT 13 GND	20	Yellow
BK-BL	36	K-TEL 14 (24V)	21	Green
BL-BK	11	K-TEL 14 GND	22	Red
BK-OR	37	SLT 14 (24V)	23	Black
OR-BK	12	SLT 14 GND	24	Yellow
BK-GN	38	K-TEL 15 (24V)	25	Green
GN-BK	13	K-TEL 15 (24V)	26	Red
BK-BR	39	SLT 15 (24V)	27	Black
BR-BK	14	SLT 15 (GND)	28	Yellow
BK-SL	40	K-TEL 16 (24V)	29	Green
SL-BK	15	K-TEL 16 GND	30	Red
YL-BL	41	SLT 16 (24V)	31	Black
BL-YL	16	SLT 16 GND	32	Yellow

**TABLE 2A. Extension Connector for S-DBS 616** (continued)

Color Cable Code	Pin#	EXT 9-16	Clip	Station Cord
YL-OR	42	N/C	33	Green
OR-YL	17	N/C	34	Red
YL-GN	43	N/C	35	Black
GN-YL	18	N/C	36	Yellow
YL-BR	44	N/C	37	Green
BR-YL	19	N/C	38	Red
YL-SL	45	N/C	39	Black
SL-YL	20	N/C	40	Yellow
VI-BL	46	N/C	41	Green
BL-VI	21	N/C	42	Red
VI-OR	47	N/C	43	Black
OR-VI	22	N/C	44	Yellow
VI-GN	48	N/C	45	Green
GN-VI	23	N/C	46	Red
VI-BR	49	N/C	47	Black
BR-VI	24	N/C	48	Yellow
VI-SL	50	N/C	49	-
SL-VI	25	N/C	50	-

**NOTE:** N/C = No connection



66 SPLIT BLOCK				308/616	616
V-BL	1		1	K-TEL 1	K-TEL 2
BL-V	2		2	N/C	SLT 9
W-O	3		3	K-TEL 2	K-TEL 10
O-W	4		4	N/C	SLT 10
W-ON	5		5	K-TEL 3	K-TEL 11
ON-W	6		6	SLT 3	SLT 11
V-BR	7		7	K-TEL 4	K-TEL 12
BR-V	8		8	SLT 4	SLT 12
W-S	9		9	K-TEL 5	K-TEL 13
S-W	10		10	SLT 5	SLT 13
B-BL	11		11	K-TEL 6	K-TEL 14
BL-B	12		12	SLT 6	SLT 14
R-O	13		13	K-TEL 7	K-TEL 15
O-R	14		14	SLT 7	SLT 15
R-ON	15		15	K-TEL 8	K-TEL 16
ON-R	16		16	SLT 8	SLT 16
R-BR	17		17	N/C	N/C
BR-R	18		18	N/C	N/C
R-S	19		19	N/C	N/C
S-R	20		20	DPH 1	N/C
BR-BL	21		21	DHP 2	N/C
BL-BR	22		22	N/C	N/C
MK O	23		23	+24 to PFU	N/C
O-BK	24		24	N/C	N/C
BK-ON	25		25	GND to PFU	N/C
ON-BK	26		26		
BK-BR	27		27		
BR-BK	28		28		
BK-S	29		29		
S-BK	30		30		
Y-BL	31		31		
BL-Y	32		32		
Y-O	33		33		
O-Y	34		34		
Y-ON	35		35		
ON-Y	36		36		
Y-BR	37		37		
BR-Y	38		38		
Y-S	39		39		
S-Y	40		40		
V-BL	41		41		
BL-V	42		42		
V-O	43		43		
O-V	44		44		
V-ON	45		45		
ON-V	46		46		
V-BR	47		47		
BR-V	48		48		
V-S	49		49		
S-V	50		50		

Figure 10

## SMDR INTERFACE CARD

### Features Package "B"

The main unit is provided with an SMDR Interface Card connector which requires Feature Package B, VB-42411. Place the VB-42411 cartridge in the area on the KSU marked "Feature Package". (See Figure 11 below)

The Card provides an RS-232C port interface which is compatible with customer-provided serial printers or call-accounting devices capable of generating detailed reports for call information, on time, duration and phone number.

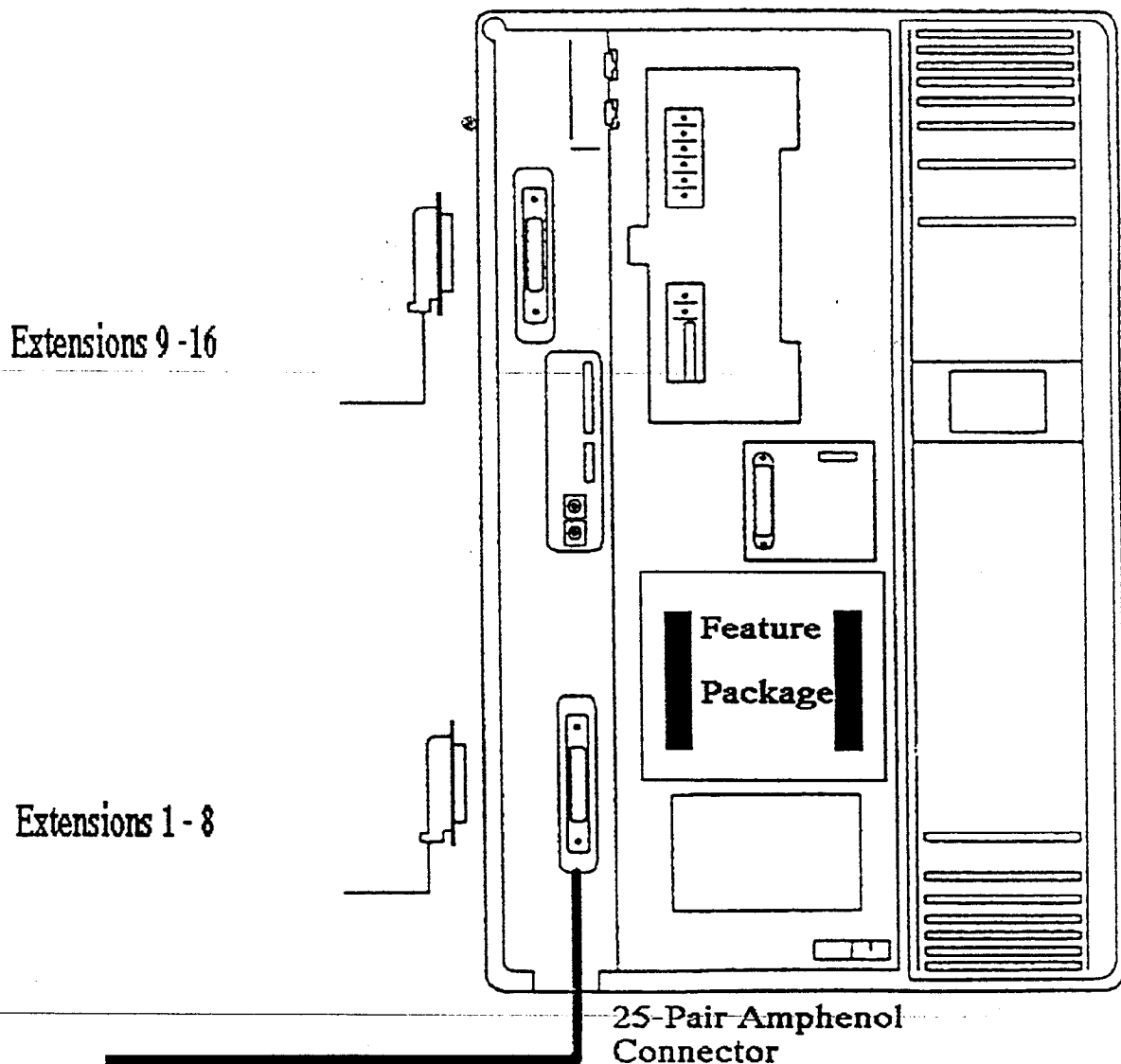

Figure 11

**SMDR INTERFACE CARD** (continued)

**1. Installing the SMDR Card** (See Figure 12 on page 21)

- a) Place the SMDR card in the area on the main unit marked "SMDR I/F". Push the card forward to lock it in place.
- b) Use the ribbon cable attached to the SMDR card to connect the card to the SMDR pin connector.

**NOTE:** When connecting a printer to this system, see Table 3 below for correct pin configuration.

**TABLE 3. Printer Connection**

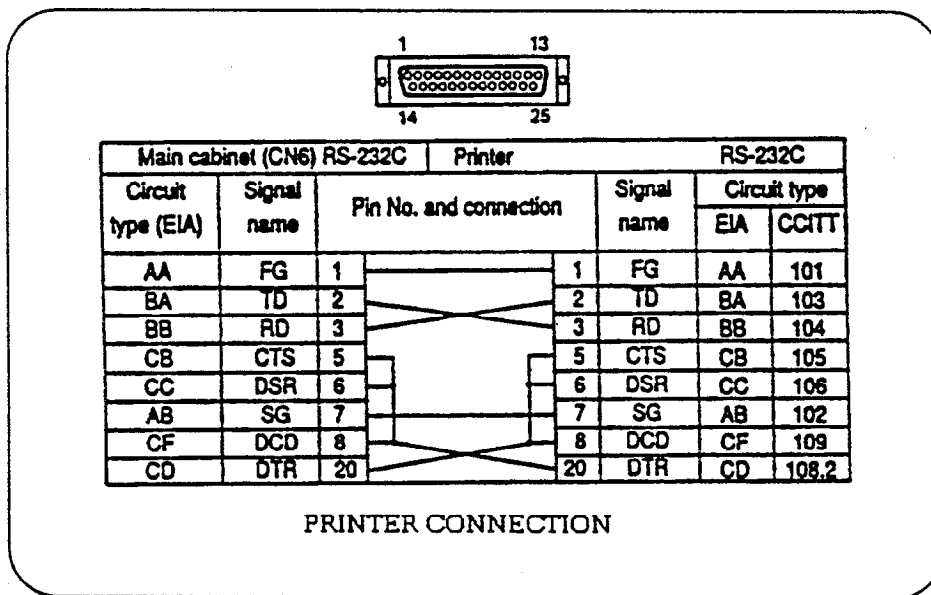

**SMDR INTERFACE CARD (continued)**

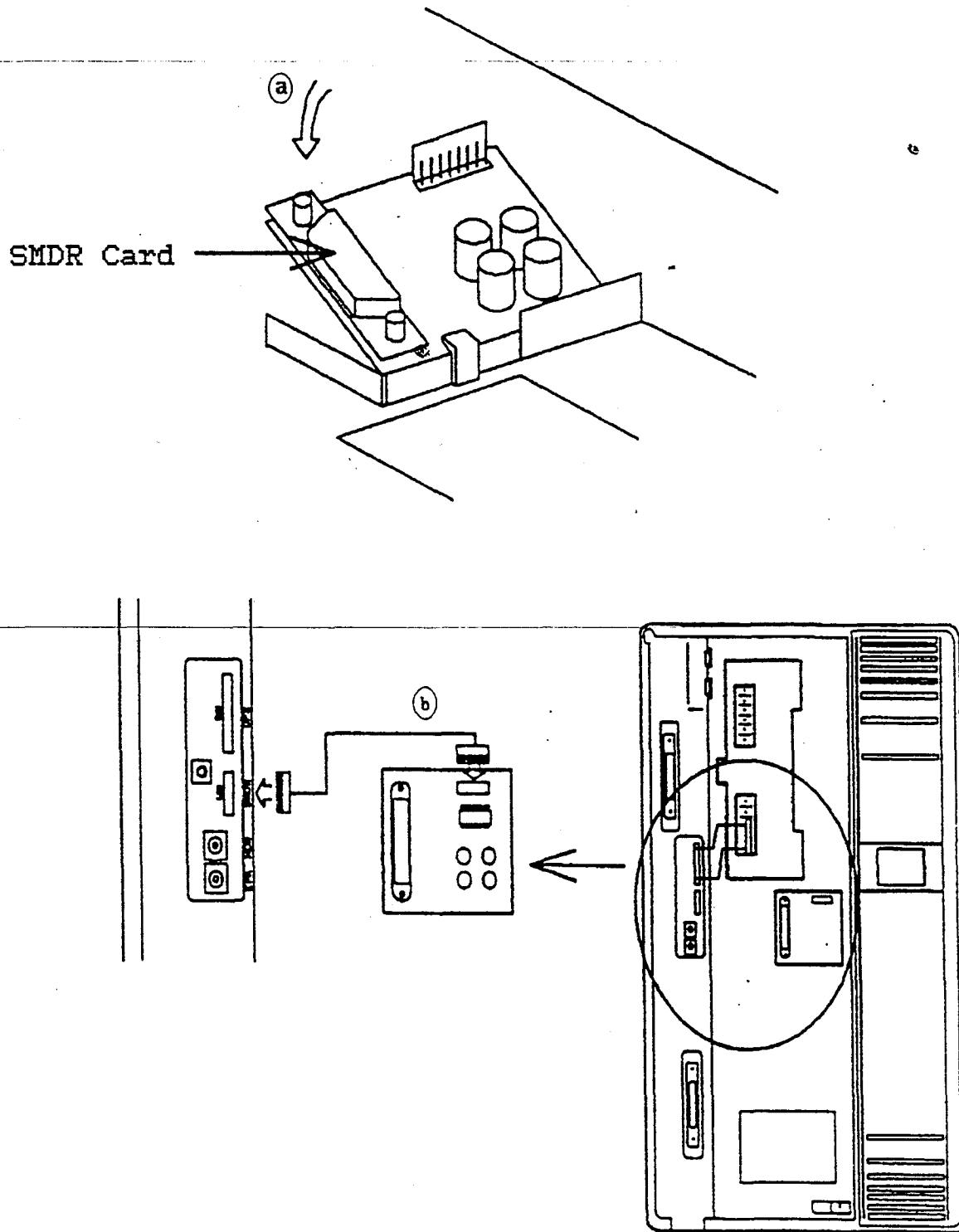

**Figure 12**

## DOORPHONE ADAPTOR INTERFACE CARD

The doorphone interface card supports two door boxes, provides alarm sensor input terminals and accommodates two multi-purpose external relays.

**Relay 1** has only **one function**: a multi-purpose relay that can be programmed to operate on either a continual or timed basis.

**Relay 2** has **two functions**: multi-purpose and incoming ring signal. The multi-purpose function can be programmed to operate on either a continual or timed basis.

Relay 1 and 2 remain in the idle state until activated by a two-digit telephone code.

### 1. Installing the Doorphone Card (See Figure 13 on page 23)

- a) Slide the doorphone card to the right inside the grooves on the main unit.
- b) Use a ribbon cable to connect the doorphone card to the DPH outlet on the main unit.
- c) Connect wires for the sensor devices and relays to the doorphone card.

**DOORPHONE ADAPTOR INTERFACE CARD (continued)**

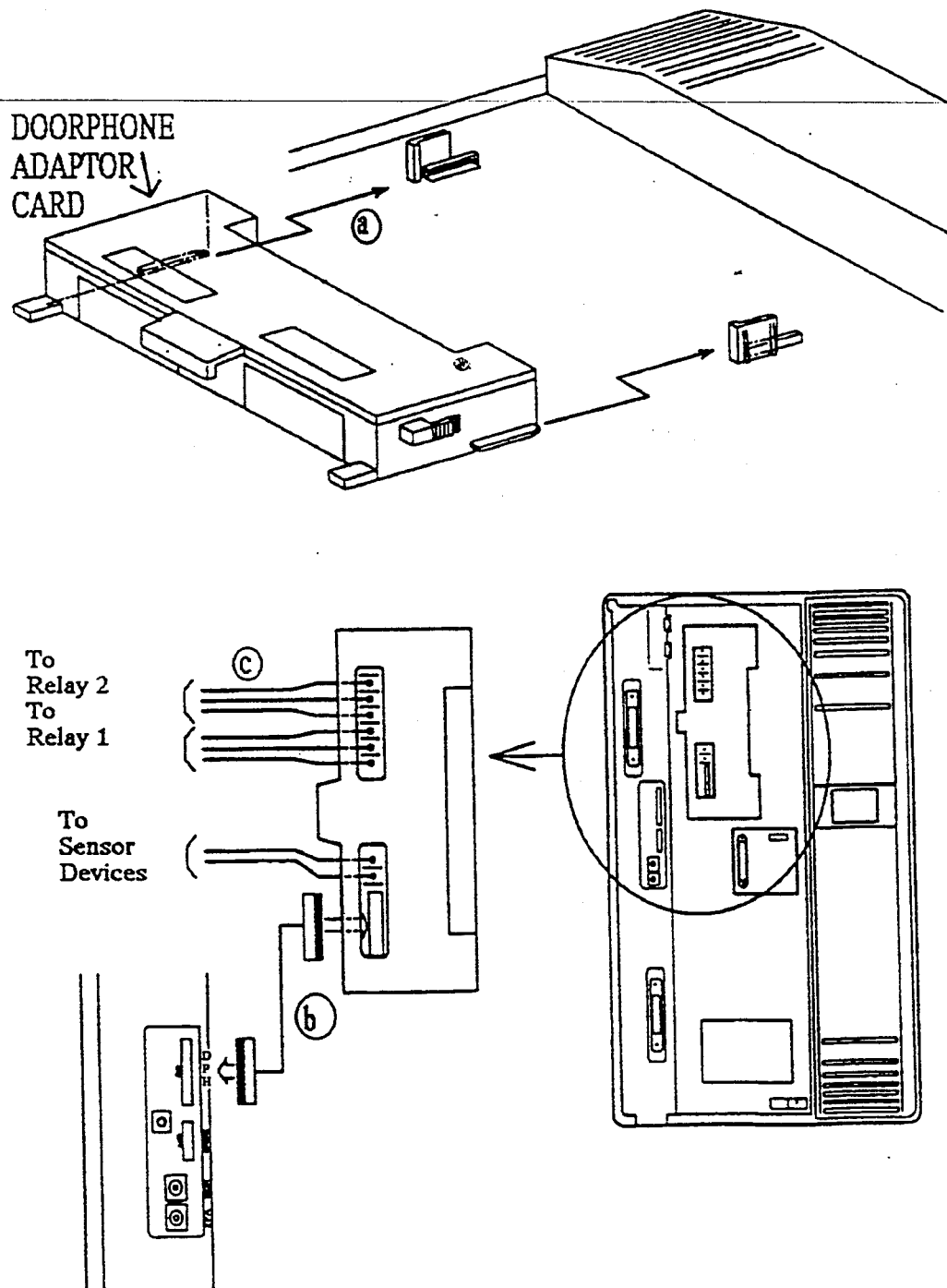

**Figure 13**

## DOOR BOX

The door box associated with a customer-provided electrical door opener is usually mounted outside the building beside the front door. By pressing a button on the door box a visitor alerts the person inside the building who controls the door opener by dialing an access code from a programmed telephone.

### 1. Connecting the Door Box

Each door box connects two wires to a 25-pair extension cable. (See TABLE 2, page 15) Choose the appropriate wire gauge from the table below:

TABLE 4. Wire Gauges

Wire Gauge	Maximum Range	Resistance
26 AWG	230 Feet	20 $\Omega$ (Ohms)
24 AWG	370 Feet	20 $\Omega$ (Ohms)
22 AWG	590 Feet	20 $\Omega$ (Ohms)

Figure 14

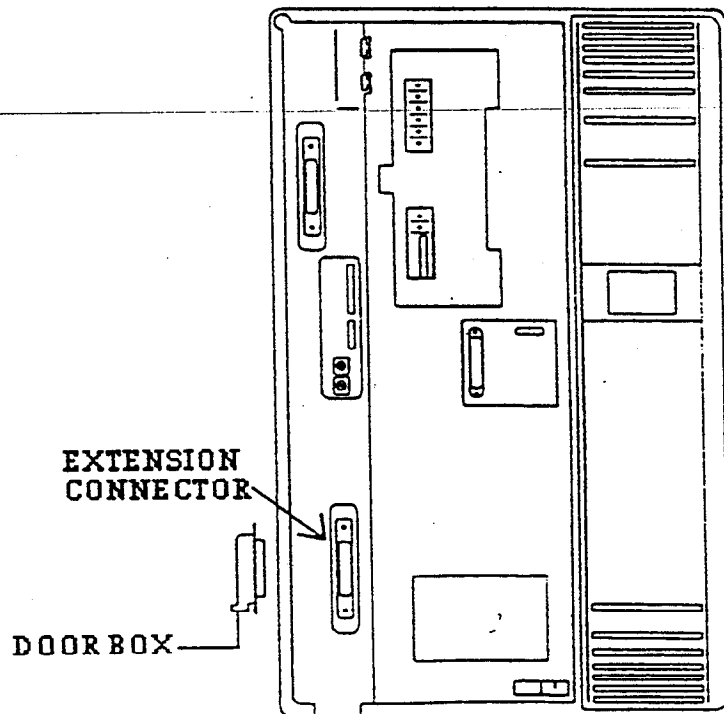

## **POWER FAILURE UNIT**

The Power Failure Unit (PFU) supports up to four CO PBX lines in case of power failure. The lines are switched directly to dedicated SLTs (type 500/2500 telephone) for incoming and outgoing calls.

When power is restored the system will automatically return to normal service.

### **1. Wall-Mounting Procedure (See Figure 15 on page 27)**

- a) Remove the two screws from the PFU module and lift off the upper case.
- b) Use the provided wood screw to mount the PFU onto the wall. The wood screw should stick out from the wall about 5/16th of an inch.
- c) Hook the PFU onto the wood screw and tighten the screw.
- d) Screw the wood screws into the holes at the bottom of the lower case.
- e) Cut the knockout parts from the bottom of the lower case with pliers and remove the clamp plate.



## **POWER FAILURE UNIT (continued)**

### **2. Connecting the Power Failure Unit (PFU) (See Figure 15 on page 27)**

- 1) Use the modular plugs to connect each trunk line from the CO/PBX to the "FROM COL (COL A to D)" jacks on the PFU. Up to four trunk lines can be connected to the PFU.
- 2) Connect the trunk lines from the "TO COL (KSU)" jacks on the PFU to the "COL" port on the main unit by using the modular plugs.
- 3) Connect the EXT lines from the main unit to the "FROM SLT-LC (KSU)" jacks.
- 4) Connect each SLT line to the "TO SLT" jacks on the PFU.
- 5) Connect two wires from the power supply terminals on the PFU parallel to any EXT port.
- 6) Gather the wires back into the PFU and bring out through the underside of the PFU and attach the wires by clamp plate. (See (e) on Figure 15)



## MUSIC-ON-HOLD (MOH)

### 1. Connecting Music Source to the MOH Connector

The MOH RCA connector is the input terminal for music-on-hold (MOH). Connect the music source to the MOH connector on the main unit with an RCA jack.

**NOTE:** If a tape recorder is connected to the MOH connector, place the recorder five meters or more away from the main unit to prevent interference.

**TABLE 5. MOH Input Impedance**

<p><b>MOH terminal input impedance: 1.5k ohms maximum</b></p> <p><b>input level: 150mV maximum</b></p>
--

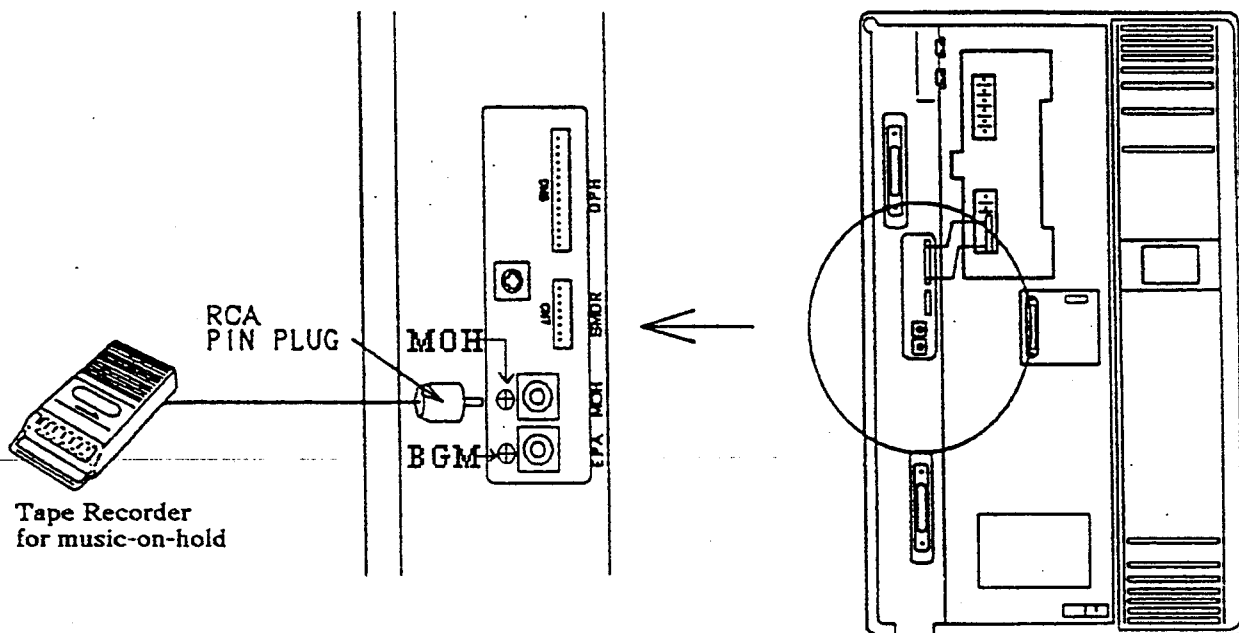

**Figure 16**

## EXTERNAL PAGING

### 1. Connecting the Paging Speaker to the Amplifier

The External Paging Amplifier (EPA) connector is the output terminal for external paging.

- a) Connect the EPA terminal to the amplifier input terminal.
- b) Connect the paging speaker to the amplifier output terminal.

**TABLE 6. EPA Output Impedance (Varies)**

<b>EPA terminal output impedance: 600 ohms</b>
<b>output level: -20dB</b>

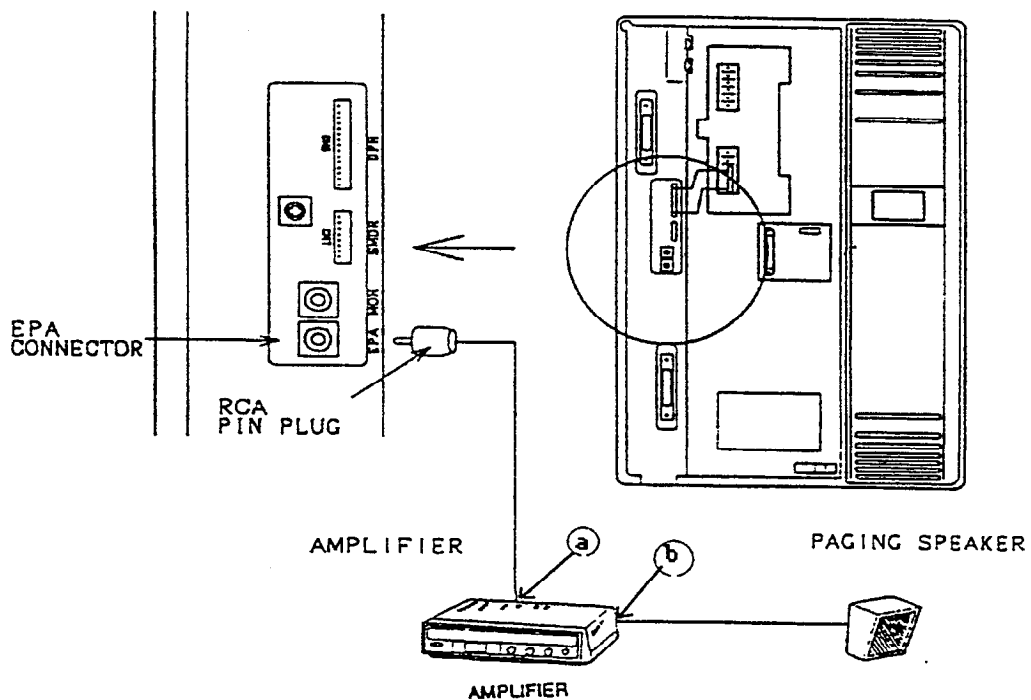

**Figure 17**



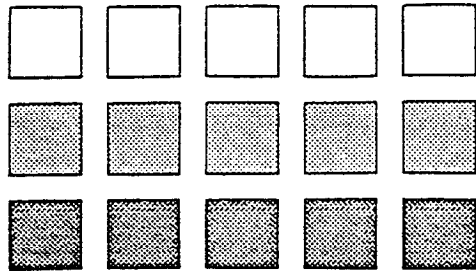

Section 400  
Issue 1  
July 1990  
S-DBS 308/616 (V1.0)

# Programming Instructions

Small Digital Business System  
308/616

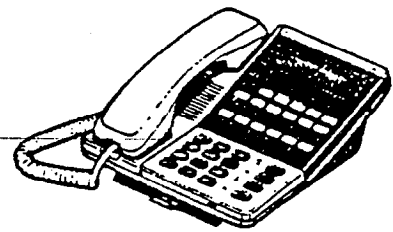
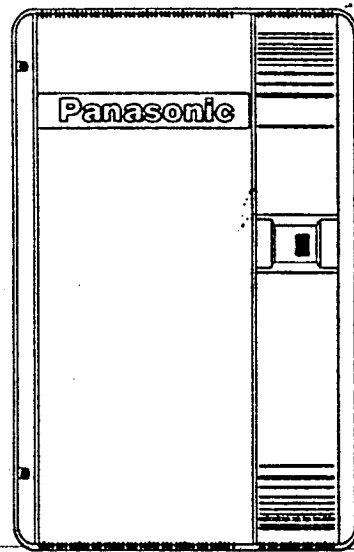
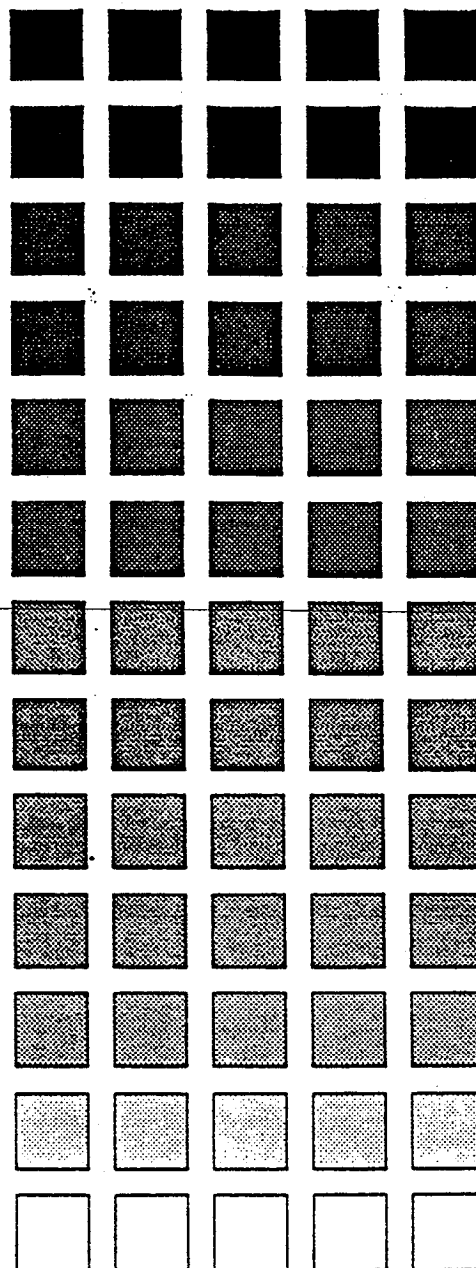

**Panasonic DBS Small**

For Models:

DB-42010 & 42020

See other Section 400 for other Models

**Panasonic®**

The information in this document is subject to change without notice and should not be construed as a commitment by the Panasonic Communications & Systems Company (PCSC). Furthermore, PCSC reserves the right, without notice, to make changes to equipment design as advance in engineering and manufacturing methods warrant.

## **FCC RULES AND REGULATIONS (Part 68)**

In compliance with the requirements of Part 68 of the FCC Rules and Regulations for connection of terminal equipment to the telephone network, and for your convenience, the following information is presented.

### **Notifying the Telephone Company**

When connecting or disconnecting the terminal equipment to the telephone network, inform the telephone company of the particular line (s) for connection, the FCC registration number and ringer equivalence number of the registered terminal equipment.

### **FCC Registration Numbers**

<b>Model Numbers</b>	<b>Key System</b>	<b>Hybrid System</b>
<b>VB-42010 (DBS308)</b>	<b>ACKUSA-61853-KF-E</b>	<b>ACKUSA-61855-MF-E</b>
<b>VB-42020 (DBS616)</b>	<b>ACKUSA-61854-KF-E</b>	<b>ACKUSA-61856-MF-E</b>

When enabling Pooled Trunk Access, inform the telephone company or a Panasonic service center of the MF-E FCC Registration number. According to FCC rules, Pooled Trunk Access is regarded as one of the distinguishing features of a PBX as opposed to a key telephone system.

### **RINGER EQUIVALENCE NUMBER (REN) 0.5 B**

The REN determines the number of devices you may connect to your telephone line and still have all those devices ring when your telephone number is called. In most, but not all areas, the sum of the REN's of all devices connected to one line should not exceed five (5.0). You should contact your local telephone company to determine the maximum REN for your calling area.

Service order code	9.0F
Network address signaling code	E
Facility interface code	02LS2 (2 wire/Loop start)
Required network interface code	RJ25C

### **Connection to a Party Line or Coin Operated Telephone Line**

**Direct Connection to a Party Line or Coin Operated Telephone Line Is Prohibited.**

If you are on a party line, check with your local telephone company for further information.



### **Incidence of Harm to the Telephone Lines**

Should terminal equipment cause harm to the telephone network, the telephone company shall, where practical, notify the customer that temporary discontinuance of service may be required. However, where prior notice is not practical, the telephone company may temporarily discontinue service forthwith, if such action is reasonable in the circumstances. In case of un-notified temporary discontinuance of service, the telephone company shall:

- (A) Promptly notify the customer of such temporary discontinuance of service.
- (B) Afford the customer the opportunity to correct the situation which gave rise to the temporary discontinuance.
- (C) Inform the customer of the right to bring a complaint to the Commission pursuant to the procedures set out in Part 68 of the FCC Rules and Regulations.

### **Compatibility of the Telephone Network and Terminal Equipment**

- (A) Availability of telephone information

Technical information on interface parameters and specifications not set by FCC Rules, including the number of ringers which may be connected to a particular telephone line to permit terminal equipment to operate in a manner compatible with telephone company communications facilities, shall be provided by the telephone company upon customer's request.

- (B) Changes in telephone company communications facilities, equipment, operations and procedures.

The telephone company may make changes in its communications facilities, equipment, operations or procedures, where such action is reasonably required in the operation of its business and is not inconsistent with the rules and regulations in FCC Part 68. If such changes can be reasonably expected to render any customer's terminal equipment incompatible with telephone company communications facilities or require modification or alteration of such terminal equipment or otherwise materially affect its use or performance, the customer shall be given adequate notice in writing to allow the customer an opportunity to maintain un-interrupted service.

### **Hearing Aid Compatibility**

This system is hearing-aid compatible.

### **Automatic Dialers**

#### **When Programming Emergency Numbers or Making Test Calls to Emergency Numbers:**

- (A) Remain on the line and briefly explain to the dispatcher the reason for the call.
- (B) Perform such activities in the off-peak hours, such as early morning or late evening.

## **Responsibility of Grantee (Manufacturer) of Registered Equipment**

**The Grantee or its agent shall provide the user of the registered equipment with the following:**

- (A) Instructions concerning installation, operation and repair procedures, where applicable.
- (B) Notification that the registered terminal equipment may not be used with party lines or coin lines.
- (C) Instruction indicating that when trouble is experienced the customer shall disconnect the registered equipment from the telephone line to determine whether it is malfunctioning. If so, the use of such equipment shall be discontinued until the problem has been corrected.
- (D) If connections other than RJ25C are needed, contact the local telephone company.

## **Product Safety**

**Please Observe the Following Guidelines to Assure the Safe Use of Your Telephone**

- (A) This product is an electrical device and can be hazardous if immersed in water.
- (B) To avoid the risk of electrical shock, do not use this unit while in the bathtub, shower, or when wet. If you accidentally drop the unit into water, unplug it first, then retrieve it by pulling the cord.
- (C) The telephone should not be exposed to heat sources, direct sunlight, extreme temperatures, moisture, strong vibrations, greasy or dusty environments.
- (D) Never attempt to insert wires, pins or similar objects in the vents or openings of the telephone.
- (E) Never clean the telephone with benzol, paint thinner or other solvent materials.
- (F) Never install telephone wiring during a lightning storm.
- (G) Never install telephone jacks in a wet area unless they are specifically designed for that purpose.
- (H) Never touch un-insulated telephone wires or terminals unless the telephone line has been disconnected at the network interface.

## **Radio Interference (Part 15)**

**Warning** - This unit generates, uses and can radiate radio frequency energy. If not installed and used in accordance with the instructions manual, the unit may cause radio interference. The Unit has been tested and found to comply with the limits for a Class A digital device pursuant to Part 15 of FCC Rules, which are designed to provide reasonable protection against such interference when operated in a commercial environment.

Operation of this equipment in a residential area is likely to cause harmful interference in which case the user at his own expense will be required to take whatever measures necessary to correct the interference.

If necessary, the user should consult the dealer or an experienced radio/television technician for additional suggestions.

The user may find the following booklet prepared by the Federal Communications Commission helpful:

### **Something about Interference**

This booklet is available from the FCC local regional offices.

# Table of Contents

FCC RULES AND REGULATIONS (Part 68) .....	iii
Notifying the Telephone Company .....	iii
RINGER EQUIVALENCE NUMBER (REN) 0.5 B .....	iii
Connection to a Party Line or Coin Operated Telephone Line .....	iii
Incidence of Harm to the Telephone Lines .....	iv
Compatibility of the Telephone Network and Terminal Equipment .....	iv
Hearing Aid Compatibility .....	iv
Automatic Dialers .....	iv
Responsibility of Grantee (Manufacturer) of Registered Equipment .....	v
Product Safety .....	v
Radio Interference (Part 15) .....	v
PROGRAMMING GUIDELINES .....	1
Before programming the small DBS system .....	1
PROGRAMMING DATA TABLE FORMS .....	2
INITIALIZING THE SYSTEM BEFORE PROGRAMMING .....	3
Before programming for the first time .....	3
SMALL DIGITAL BUSINESS SYSTEM PSD KEY SETTINGS .....	4
PSD 1 Key - System setting .....	4
PSD 2 Key - Trunk setting .....	4
PSD 3 Key - Extension and ring setting .....	4
PSD 4 Key - Feature assignment .....	4
PSD 5 Key - Toll restriction setting .....	4
PSD 6 Key - TTY setting .....	4
SMALL-DBS KEY TELEPHONE .....	5
PROGRAMMING KEYS .....	6

HOW TO ENTER THE PROGRAM MODE .....	7
Attendant's phone .....	7
ON/OFF key or POWER SETTING .....	7
HOW TO PROGRAM .....	8
DATA TERMINAL PROGRAMMING .....	9
ENTERING THE DATA TERMINAL PROGRAMMING MODE.....	9
Program the key telephone for data terminal programming .....	9
Access data terminal programming.....	9
DATA TERMINAL KEYBOARD PROGRAMMING KEYS .....	10
Key telephone .....	10
Data terminal .....	10
HOW TO PROGRAM WITH A DATA TERMINAL .....	11
FEATURES .....	12,13
DEFAULT DATA TABLES .....	14
PSD 1 Key - System setting.....	14
PSD 2 Key - Trunk setting .....	15
PSD 3 Key - Extension setting .....	16
PSD 4 Key - FF Key assignment setting.....	17
Flexible function (FF) key assignments .....	17
How to program the FF keys for individual telephones .....	18
PSD 5 Key - Toll restrictions .....	19
PSD 6 Key - TTY setting .....	20
PROGRAMMING SYSTEM FEATURES .....	21
PSD 1 Key - System setting.....	21
PSD 2 Key - Trunk setting .....	37
PSD 3 Key - Extension setting .....	44
PSD 4 Key - FF key assignment .....	49
PSD 5 Key - Toll restrictions .....	51
PSD 6 Key - TTY setting .....	61
Index .....	63

## PROGRAMMING GUIDELINES

### Before programming the small DBS system:

- a) Make certain all connections to the main unit have been properly installed and tested. See the **Installation Instructions** manual, **Section 300**.
- b) Complete the programming table form with all necessary information obtained from the end user. See page 2.
- c) Perform the initialization procedure **before** programming. See page 3.

## PROGRAMMING DATA TABLE FORMS

Enter features and installation specifications in a programming table form.  
See the **Programming Table** manual, **Section 450**.

---

## INITIALIZING THE SYSTEM BEFORE PROGRAMMING

Before programming for the first time, reset the system as follows:

1. Turn off the power for the Main Cabinet.
2. Set the **RAM** switch to "**CLEAR**".
3. Turn the power for the Main Cabinet back on.
4. Set the **RAM** switch to "**HOLD**".

**NOTE:** This is a one-time operation. If the procedure is repeated at the next programming session, all previously programmed data will be erased.

## **SMALL DIGITAL BUSINESS SYSTEM PSD KEY SETTINGS**

---

The system consists of the following 6 modes. Each of these modes is represented by personal speed dial (PSD) keys 1-6. See figure I on page 5 of this section.

1. **PSD 1 Key - System Setting:**  
Contains all of the feature options which are system-wide based.
2. **PSD 2 Key - Trunk Setting:**  
Contains all of the feature options on a per line basis.
3. **PSD 3 Key - Extension and Ring Setting:**  
Contains all of the feature options on a per station basis.
4. **PSD 4 Key - Feature Assignment:**  
~~Contains all of the feature options on a per key per station basis.~~
5. **PSD 5 Key - Toll Restriction Setting:**  
Contains all of the program steps for performing toll restrictions on a per line per station basis.
6. **PSD 6 Key - TTY Setting:**  
Contains all of the features on the TTY port.



**SMALL-DBS KEY TELEPHONE**

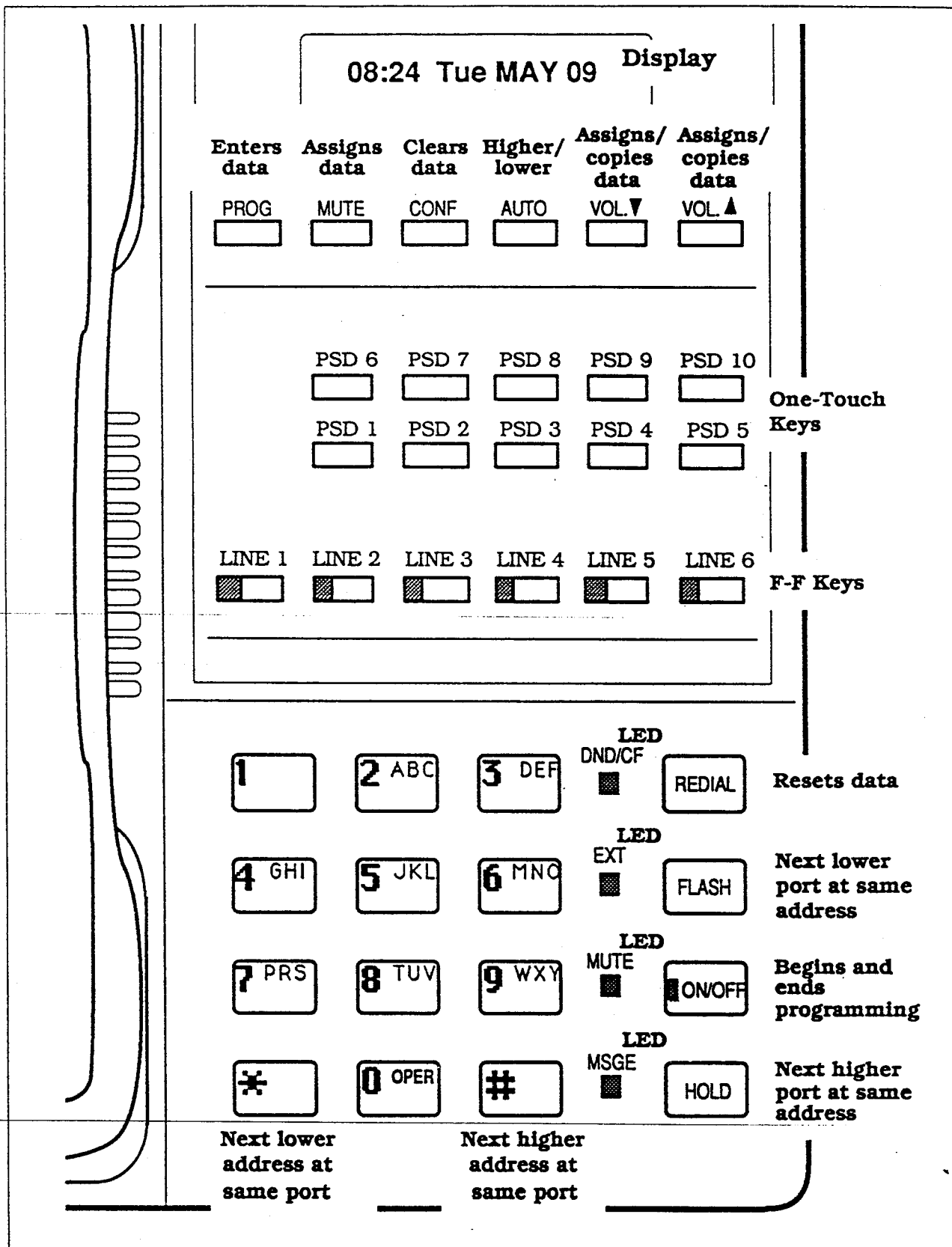

**FIGURE I**

## PROGRAMMING KEYS

---

**HOLD** - Assigns data and advances to the next higher port at the same address.

**FLASH** - Assigns data and returns to the previous port at the same address.

**#** - Assigns data and advances to the next higher address at the same port.

**\*** - Assigns data and returns to the previous address at the same port.

**AUTO** - Moves to a higher or lower address at the same port by pressing **AUTO** and entering the new address.

**CONF** - Clears data

**REDIAL** - Resets data

**VOL ▲ PROG** - Moves to higher ports either assigning data to a port or copying data from one port to another.

**NOTE:** Some data **cannot be copied** from port to port. Text under each address in this manual is noted accordingly.

**VOL ▼ PROG** - Moves to lower ports either assigning data to a port or copying data from one port to another.

**NOTE:** Some data **cannot be copied** from port to port. Text under each address in this manual is noted accordingly.

---

**MUTE** - Carries new data to the next higher port by pressing the **MUTE** key. Press the **MUTE** key again to enter the new data and advance to the next higher port.

## HOW TO ENTER THE PROGRAM MODE

### Attendant's Phone:

Easy access programming is performed from an attendant's telephone as follows:

1. **ON/OFF**
2. **PROG**
3. **# #**
4. One-touch key (PSD Key)

An attendant's telephone is connected to extension ports 1 and 2 (extensions 10 or 11).

### ON/OFF Key or POWER SETTING:

There are three exceptions to programming from the attendant's telephone. The following addresses can **only** be programmed using the **POWER SETTING**:

---

**PSD 1** - addresses:      0005 (Outside lines)  
                                 0035 (SLT on-hook detection timer).

**PSD 3** - address:        (10-25) 13 **C** (Hybrid system/dual port operation).

1. Power **ON**
2. Enter data
3. Power **OFF**
4. Power **ON**

**NOTE:** **C** = Can be copied from port to port.

## HOW TO PROGRAM

Following is an **example** of how to program using the system's **DATE** feature:

- a) Using the attendant's telephone at extensions 10 and 11, program the **DATE** as follows:

1. **ON/OFF**
2. **PROG**
3. **# #**

The system is now in **Program Mode**.

- b) The date feature is a system-wide setting, so press the **PSD 1** key to program a change of date.

**PSD 1 - System setting**

**PSD 2 - Trunk setting**

**PSD 3 - Extension and ring setting**

**PSD 4 - Feature assignment**

**PSD 5 - Toll restriction setting**

**PSD 6 - TTY setting**

- c) Enter the following **PSD 1** address for the date:

**0001 #**

The system is now in **Date Set Mode**. To set the date enter the Year (YY), Month (MM) and Day (DD) as follows:

**YYMMDD #**

- d) To exit programming press the **ON/OFF** key.

## **DATA TERMINAL PROGRAMMING**

You can also program the system using a data terminal which gives you the advantage of checking the programming steps on the display screen before making final changes. At every stage in the programming there are help screens available by pressing the "H" key on the terminal keyboard.

---

### **ENTERING THE DATA TERMINAL PROGRAMMING MODE**

Program the access code from the key telephone for Data Terminal Programming as follows:

1. **CONF**
2. **#**
3. **6**
4. Program 4-digit ID code from the attendant's phone.
5. Press **HOLD**

**Access Data Terminal Programming as follows:**

1. Press **ON/OFF** key
2. **#**
3. Enter **99**
4. Enter programmed 4-digit ID code

**NOTE:** The optional Station Message Detail Recorder (SMDR) interface is required.

## DATA TERMINAL KEYBOARD PROGRAMMING KEYS

The programming keys for the telephone are the equivalent of the following control keys on the data terminal keyboard.

KEY TELEPHONE		DATA TERMINAL	
HOLD	=	CONTROL D	(Next port)
FLASH	=	CONTROL S	(Previous port)
#	=	CONTROL X	(Next address)
*	=	CONTROL E	(Previous address)
AUTO	=	ESCAPE	(Program set mode)
CONF	=	DELETE	(Clears data)
REDIAL	=	CONTROL R	(Resets data)
VOL ▲ PROG	=	CONTROL T	(Moves to next port with data)
VOL ▼ PROG	=	CONTROL V	(Moves to previous port with data.)
MUTE	=	CONTROL U	(Carries new data to the next port)
ON/OFF	=	CONTROL Z	(Exit)

**NOTE:** In Small DBS V.1.0 Control D and Control S are incorrectly defined in the terminal.  
Both are correct as stated above.

## HOW TO PROGRAM WITH A DATA TERMINAL

At the **REMT>** prompt press "**H**" for help.

The screen will prompt you to select from the Maintenance Mode menu:

**P** = Program Set

**S** = Speed Dial Set

**Control Z** = Exit

If you enter "**P**" (**P** plus return) the screen will display the following:

```
REMT> P
DBS System Prog
Prog>
```

At the **Prog>** prompt press "**H**". The screen will display the **PSD Key settings menu** and the **Prog>** prompt again. At the **Prog>** prompt press the Tilde key (~) followed by number of the setting, for example, "~01" for System programming and press return.

At the **01 Sys>** prompt press return again. The first address in the system (the date) will appear on the screen:

---

S0001 900809 (YYMMDD)

The screen will advance to the next address every time you press return or you can change the date in address "0001" from August 8, 1990 to August 10, 1990, for example, by entering (press return) 900810.

The screen will advance to the next address. To check that the date is entered correctly press "**Control E**" to bring you back to the previous address which in our example is "0001".

Pressing "**H**" for help at any stage will access control key menus and other information to help you move from port to port or address to address, access a menu, return to a previous operation or exit.

SETTINGS	SYSTEM	TRUNK
<b>FEATURES</b>		
Answering Calls (Automatic)		
Busy Override		
Call Waiting		
Data Security	0032	
Delayed Ring		(01-06)18,19,20C
Dial Tone Stop/Internal		
Door Boxes A and B	0039	
FLASH Key	0019	
Headset Mode		
Hybrid System/Dual Port Operation		
Outside Line Off-Hook Signal	0029 (Alert Tone)	
Paging		
Pooled Trunk Access		(01-06) 11 C
Sensor	0040, 0041	
Station Lockout Capability		
Station Lockout Types		
Toll Restriction System		
Transfer On-Hook (Automatic)	0025	
Voice Announce Off-Hook (Manual)		

**NOTE: C = Can be copied from port to port.**



EXTENSIONS	FF KEYS	TRS	TTY
(10-25) 03 C			
(10-25) 09,10 C			
(10-25) 04 C			
(10-25) 11 C			
(10-25) 17 C			
(10-25) 07 C			
(10-25) 16 C			
(10-25) 13 C			
(10-25) 05 C			
		0007	
		(10-25) 01 C	
		0018	
(10-25) 12 C			

## DEFAULT DATA TABLES

### PSD 1 Key - System Setting

ADDRESS	FEATURE	DEFAULT	PAGE
0001	Date	-	21
0002	Time Display	12-hour system	21
0003	Time	1200001	21
0004	Days of Week	Monday	22
0005 P	Outside Lines	3 lines/6 lines	22
0006-0015	(Auto) Pause-Digits 1-9,0	No pause	23-26
0016	(Auto) Pause Timer	3 seconds	26
0017	SMDR Timer	15 seconds	27
0018	FLASH-REDIAL (Auto)	Auto FLASH	27
0019	CO FLASH Timer Off-Hook	1 second	27
0020	SSD CO FLASH Timer	0.5 second	28
0021	Dial Pause Timer	0.75 second	28
0022	CO Line Guard Timer	0.75 second	28
0023	Pulse Dial/Minimum Pause	640 ms	29
0024	Switch Time/Night (Auto)	Day mode	29
0025	Transfer On-Hook (Auto)	Disable	29
0026	One-Touch Key	One-touch call	30
0027	Background Music (BGM)	Disable	30
0028	Information Tone	Voice calls and paging calls	30
0029	CO Line Off-Hook Signal	No alert tone	30
0030	Station Lockout ID Code	Not displayed	31
0031	SSD Display Restriction	Not displayed	31
0032	Data Security	Cannot interrupt	31
0033	Ext. HOLD Recall Timer	150 seconds	32
0034	Transfer Recall Timer	150 seconds	32
0035 P	SLT Detect. Timer/On-Hook	Less than 250 ms	33
0036	SLT CO HOLD	System HOLD	33
0037	SLT Intercom Ring Pattern	Internal ring signal pattern	33
0038	CPC Signal Timer	No signal	34
0039	Door Box Speech Path	No speech path	34
0040	Sensor Detecting Signal	Make signal	34
0041	Sensor Alarm Ring Stop	Signal stops alarm	34
0042	Multi-Purpose Relay 2 Function	Multi-purpose relay 2	34
0043	Multi-Purpose Relay 1 Operation	Relay as programmed time	35
0044	Multi-Purpose Relay 2 Operation	Relay as programmed time	35
0045	Multi-Purpose Relay 1 Operation Timer	3 seconds	35
0046	Multi-Purpose Relay 2 Operation Timer	3 seconds	35

**NOTE:** P = Power Setting; CPC = Calling Party Control

## DEFAULT DATA TABLES

### PSD 2 Key - Trunk Setting

ADDRESS	FEATURE	DEFAULT	PAGE
(01-06) 01M	Dial Signal/CO Line	10 pps pulse dial	36
02 C	DTMF Signal Sending Time	80 ms ON/80 ms OFF	36
03 C	Connected Phone Line	CO line	36
04 C	(Auto) Pause PBX Line	No pause	36
05 C	DTMF Signal Conver.(Auto)	Disable	37
06 C	DTMF Conversion (Manual)	Enable	37
07 C	DTMF Signal Time	No change	37
08 C	DTMF Signal Time Table	160 ms	37
09 C	CO Line Disconnect CPC Signal Detection	No detection of CPC Signal	38
10 C	CPC Detecting Timer	More than 304 ms	38
11 C	Pooled Trunk Access Dial 9	Pooled trunk access dial 9	38
12 M	Pooled Trunk Access (PTA) Group	Not subject to PTA	39
13 C	Incoming Ring Tone Pattern	Synchronized ring tone	39
14 C	Incoming Ring Signal Detection Time	More than 350 ms	39
15 C	Incoming Ring Pattern Detection Timer	6 seconds	40
16 C	External Ringer Oper.	Disable	40
17 C	Incoming Call Forwarding	Call forwarding	40
18 C	Delayed Ring Function Operation	Disable	40
19 C	Delayed Ring Transferring Time	Disable	41
20 C	Delayed Ring Transfer to Extension Numbers	Clear	41

**NOTE:** C = Can be copied from port to port

**M** = Can be copied **only** with the **MUTE** Key; copy mode will change in future version of S-DBS.

CPC = Calling Party Control

## DEFAULT DATA TABLES

### PSD 3 Key - Extension Setting

ADDRESS	FEATURE	DEFAULT	PAGE
(10-25) 01 C	Day Incoming Ring	Clear (12-25) Trunks 1-6 (10,11)	42
02 C	Night Incoming Ring	Clear (12-25) Trunks 1-6 (10,11)	42
03 C	Answer (Automatic)	No pickup	43
04 C	Call Waiting	Accepts internal calls (12-25) Outside/Internal calls (10,11)	43
05 C	Paging Groups	Clear	43
06 C	Sensor Alarm Ring	No ring (12-25) Ring (10,11)	43
07 C	Door Box Calls	No door box calls (12-25) Door Box A and B calls (10,11)	44
08 C	Call Duration Display	Time displayed	44
09 C	Busy Override	Impossible	44
10 C	Busy Override Rejection	Accepted	44
11 C	Data Security	Disable	45
12 C	Voice Announce Off-Hook (Manual)	Rejection	45
13 P C	Hybrid System/Dual Port	Hybrid operation	45
14 C (See below)	Key Telephone Extension Lockout in Night Mode	Functioning	45
15 C	SLT CO Line Dial	DTMF signal	45
16	Headset Mode	Not connected	46
17	Dial Tone Stop-Internal	Disable	46

**NOTE:** P = Power Setting; C = Can be copied from port to port.

~~14 C = Attendant's phone, ports 1 and 2, cannot be changed to another port.~~

**DEFAULT DATA TABLES**

**PSD 4 Key - FF Key Assignment Setting**

ADDRESS	FEATURE	DEFAULT	PAGE
0002	FF Key - 2	CO Line 2	47
0003	FF Key - 3	CO Line 3	47
0004	FF Key - 4	CO Line 4	47
0005	FF Key - 5	CO Line 5	47
0006	FF Key - 6	CO Line 6	48

**Flexible Function (FF) Key Assignments**

FEATURES	KEY OPERATION
Attendant .....	0
Call Forwarding .....	72
Call Pickup Directed .....	79
Call Pickup Group .....	70
Call Waiting .....	3
Data Security .....	AUTO, AUTO, #
Dial CO Access.....	88N
Dial Tone Stop/Internal .....	#50
Display Contrast .....	#
Do-Not-Disturb .....	73
Door Box .....	61, 62
Headset .....	#51
Meet-Me Answer .....	77
Message Waiting .....	2
Mode A-B Change .....	69
Night Key .....	#52
Paging Zone 1 .....	#01
Paging Zone 2 .....	#02
Paging Zone 3 .....	#03
All-Zone Paging .....	#00
Pooled Trunk Access .....	9 or 81-83
Repeat .....	AUTO, *
Save .....	AUTO, AUTO, *
SMDR.....	#93
Station Lockout .....	74
Tone Calls .....	1
Trunk Queuing .....	2
Voice Announce .....	5
Voice Announce Answer .....	*3

**NOTE:** The FF keys are a system-wide setting. Every telephone is assigned the same code. See page 18 for instructions on how to program individual telephones.

---

## HOW TO PROGRAM THE FF KEYS FOR INDIVIDUAL TELEPHONES

1. Press **ON/OFF** key
  2. Press **PROG** key
  3. Press **FF** Key
  4. Enter 4-digit code (maximum)
  5. Press **HOLD** key
-

## DEFAULT DATA TABLES

### PSD 5 Key - Toll Restrictions

ADDRESS	FEATURE	DEFAULT	PAGE
0001	System Installation Area Code	Area code only	49
0002	PBX Internal Call Restriction	PBX intercom calls	49
0003	PBX Incoming Calls Prohibited	PBX incoming calls	49
0004	Maximum Number Of Digits Dialed	No restrictions	49
0005	Dialing Restriction during Incoming Calls	No restrictions	50
0006	# and * Keys Dial Restriction	Restricted	50
0007	Station Lockout Types	Type 0	50
0008-0017	PBX Digits 1-9, 0	No digits dialed	50-53
0018	SSD Toll Restrictions Override	-	54
0101-0116	Cancelling 6-Digit Restriction Types 2 and 3	-	54
0201-0216	Cancelling 6-Digit Restriction Type 3	-	54
(10-25) 01 C	Station Lockout Capabil.	Disabled	55
02 C	SSD Toll Restrictions Cancelled	Restricted	55
03-08 C	Day Restriction Types- Trunks 1-6	Type 4	55-56
09-14 C	Night Restriction Types- Trunks 1-6	Type 4	57-58

**NOTE:** C = Can be copied from port to port.

---

## DEFAULT DATA TABLES

### PSD 6 Key - TTY Setting

ADDRESS	FEATURE	DEFAULT	PAGE
0101	SMDR Printing Mode 1	Outgoing	59
0102	SMDR Printing Mode 2	Data titles and data	59
0103	Transmission Speed- Baud Rate	1200 bps	59
0104	Stop Bit Length	1 bit	59
0105	Data Length	8 bits	59
0106	Parity Check	No parity check	60
0107	Even/Odd Parity	Even number parity	60



---

## PROGRAMMING SYSTEM FEATURES

### PSD 1 KEY - SYSTEM SETTING

<Address#-(data)#>

**0001#-(YYMMDD)#**

#### DATE

To set the date to February 25, 1995, enter the Year (YY), Month (MM) and Day (DD) as follows:

**950225#**

**NOTE:** The date is also recorded during Station Message Detail Recording (SMDR).

---

**0002#-(0 or 1)#**

#### TIME DISPLAY

0#:12-Hour System  
1#:24-Hour System

**0003#-(HHMMSSN)#**

#### TIME

HH=Hours; MM=Minutes; SS=Seconds, N=1 or 2.

To set the time to 3:28 P.M. and display it, enter the hour and minutes followed by 1 for A.M. or 2 for P.M.:

**03282#**

To return to the default value 12:00"00 A.M enter as follows:

**1200001#**

0004#-(1-7)#

**DAYS OF THE WEEK**

The day of the week is automatically set at the same time the date is set using address 0001#.

- 1#: Sunday
- 2#: Monday
- 3#: Tuesday
- 4#: Wednesday
- 5#: Thursday
- 6#: Friday
- 7#: Saturday

**NOTE:** The days of the week are also recorded during SMDR.

0005#-(1-7)#

**SETTING OUTSIDE LINES**

- 1#: 1 line
- 2#: 2 lines
- 3#: 3 lines (308 initial)
- 4#: 4 lines
- 5#: 5 lines
- 6#: 6 lines (616 initial)

**NOTE:** Outside lines can **only** be set using the **POWER SETTING**.  
See page 7 in this manual for instructions.

0006#-(1-8)#

---

**AUTOMATIC PAUSE - DIAL 1**

Automatically inserts a pause during dialing. When accessing a CO line through a PBX, it can take several seconds from the time the line is accessed to when it connects with a CO (outside) line.

CONF: No automatic pause after dialing digit 1

- 1#: Automatic pause before the 1st digit after dialing 1
- 2#: Automatic pause before the 2nd digit after dialing 1
- 3#: Automatic pause before the 3rd digit after dialing 1
- 4#: Automatic pause before the 4th digit after dialing 1
- 5#: Automatic pause before the 5th digit after dialing 1
- 6#: Automatic pause before the 6th digit after dialing 1
- 7#: Automatic pause before the 7th digit after dialing 1
- 8#: Automatic pause before the 8th digit after dialing 1

Numbers dialed before the connection is made result in a wrong number.

This setting also affects dialing SSD and PSD numbers.

Pause time is set with the Automatic Pause Timer at:

0016#-(0,1-7)#

**NOTE:** Each trunk must be set for automatic pause in PSD 2 as follows:

**PSD 2 Key, Address (01-06)-04#-(0 or 1)#**

0007#-(1-8)#

**AUTOMATIC PAUSE - DIAL 2**

CONF: No automatic pause after dialing digit 2

- 1#: Automatic pause before the 1st digit after dialing 2
- 2#: Automatic pause before the 2nd digit after dialing 2
- 3#: Automatic pause before the 3rd digit after dialing 2
- 4#: Automatic pause before the 4th digit after dialing 2
- 5#: Automatic pause before the 5th digit after dialing 2
- 6#: Automatic pause before the 6th digit after dialing 2
- 7#: Automatic pause before the 7th digit after dialing 2
- 8#: Automatic pause before the 8th digit after dialing 2

0008#-(1-8)#

**AUTOMATIC PAUSE - DIAL 3**

CONF: No automatic pause after dialing digit 3

- 1#: Automatic pause before the 1st digit after dialing 3
- 2#: Automatic pause before the 2nd digit after dialing 3
- 3#: Automatic pause before the 3rd digit after dialing 3
- 4#: Automatic pause before the 4th digit after dialing 3
- 5#: Automatic pause before the 5th digit after dialing 3
- 6#: Automatic pause before the 6th digit after dialing 3
- 7#: Automatic pause before the 7th digit after dialing 3
- 8#: Automatic pause before the 8th digit after dialing 3

0009#-(1-8)#

**AUTOMATIC PAUSE - DIAL 4**

CONF: No automatic pause after dialing digit 4

- 1#: Automatic pause before the 1st digit after dialing 4
- 2#: Automatic pause before the 2nd digit after dialing 4
- 3#: Automatic pause before the 3rd digit after dialing 4
- 4#: Automatic pause before the 4th digit after dialing 4
- 5#: Automatic pause before the 5th digit after dialing 4
- 6#: Automatic pause before the 6th digit after dialing 4
- 7#: Automatic pause before the 7th digit after dialing 4
- 8#: Automatic pause before the 8th digit after dialing 4

0010#-(1-8)#

**AUTOMATIC PAUSE - DIAL 5**

CONF: No automatic pause after dialing digit 5

- 1#: Automatic pause before the 1st digit after dialing 5
- 2#: Automatic pause before the 2nd digit after dialing 5
- 3#: Automatic pause before the 3rd digit after dialing 5
- 4#: Automatic pause before the 4th digit after dialing 5
- 5#: Automatic pause before the 5th digit after dialing 5
- 6#: Automatic pause before the 6th digit after dialing 5
- 7#: Automatic pause before the 7th digit after dialing 5
- 8#: Automatic pause before the 8th digit after dialing 5

**0011#-(1-8)#**

**AUTOMATIC PAUSE - DIAL 6**

CONF: No automatic pause after dialing digit 6

- 1#: Automatic pause before the 1st digit after dialing 6
- 2#: Automatic pause before the 2nd digit after dialing 6
- 3#: Automatic pause before the 3rd digit after dialing 6
- 4#: Automatic pause before the 4th digit after dialing 6
- 5#: Automatic pause before the 5th digit after dialing 6
- 6#: Automatic pause before the 6th digit after dialing 6
- 7#: Automatic pause before the 7th digit after dialing 6
- 8#: Automatic pause before the 8th digit after dialing 6

**0012#-(1-8)#**

**AUTOMATIC PAUSE - DIAL 7**

CONF: No automatic pause after dialing digit 7

- 1#: Automatic pause before the 1st digit after dialing 7
- 2#: Automatic pause before the 2nd digit after dialing 7
- 3#: Automatic pause before the 3rd digit after dialing 7
- 4#: Automatic pause before the 4th digit after dialing 7
- 5#: Automatic pause before the 5th digit after dialing 7
- 6#: Automatic pause before the 6th digit after dialing 7
- 7#: Automatic pause before the 7th digit after dialing 7
- 8#: Automatic pause before the 8th digit after dialing 7

**0013#-(1-8)#**

**AUTOMATIC PAUSE - DIAL 8**

CONF: No automatic pause after dialing digit 8

- 1#: Automatic pause before the 1st digit after dialing 8
- 2#: Automatic pause before the 2nd digit after dialing 8
- 3#: Automatic pause before the 3rd digit after dialing 8
- 4#: Automatic pause before the 4th digit after dialing 8
- 5#: Automatic pause before the 5th digit after dialing 8
- 6#: Automatic pause before the 6th digit after dialing 8
- 7#: Automatic pause before the 7th digit after dialing 8
- 8#: Automatic pause before the 8th digit after dialing 8

0014#-(1-8)#

**AUTOMATIC PAUSE - DIAL 9**

CONF: No automatic pause after dialing digit 9

- 1#: Automatic pause before the 1st digit after dialing 9
- 2#: Automatic pause before the 2nd digit after dialing 9
- 3#: Automatic pause before the 3rd digit after dialing 9
- 4#: Automatic pause before the 4th digit after dialing 9
- 5#: Automatic pause before the 5th digit after dialing 9
- 6#: Automatic pause before the 6th digit after dialing 9
- 7#: Automatic pause before the 7th digit after dialing 9
- 8#: Automatic pause before the 8th digit after dialing 9

0015#-(1-8)#

**AUTOMATIC PAUSE - DIAL 0**

CONF: No automatic pause after dialing digit 0

- 1#: Automatic pause before the 1st digit after dialing 0
- 2#: Automatic pause before the 2nd digit after dialing 0
- 3#: Automatic pause before the 3rd digit after dialing 0
- 4#: Automatic pause before the 4th digit after dialing 0
- 5#: Automatic pause before the 5th digit after dialing 0
- 6#: Automatic pause before the 6th digit after dialing 0
- 7#: Automatic pause before the 7th digit after dialing 0
- 8#: Automatic pause before the 8th digit after dialing 0

0016#-(0,1-7)#

**AUTOMATIC PAUSE TIMER**

The pause timer can be set within a range of 2 to 9 seconds.

- 0#: 2-second pause
- 1#: 3-second pause
- 2#: 4-second pause
- 3#: 5-second pause
- 4#: 6-second pause
- 5#: 7-second pause
- 6#: 8-second pause
- 7#: 9-second pause

**NOTE:** Set the pause timer at the automatic pause position.  
See **PSD 1** key addresses 0006-001.  
When **REDIAL** is stored in SSD and PSD a pause is automatically inserted during dialing.

0017#-(0 or 1)#

**SMDR TIMER - STARTING TIME DISPLAY FOR OUTSIDE CALLS**

The start time for an outside call appears on the display 15 seconds after the dial signal is sent out. The 15-second default can be reset to 30 seconds.

The start time for an incoming call appears on the display immediately after the call is answered.

0#: 15 seconds

1#: 30 seconds

0018#-(0 or 1)#

**FLASH - REDIAL (AUTOMATIC)**

The **REDIAL** key can automatically cut off an outside line after one or more digits have been dialed and then redial the same numbers again.

However, if the system is connected to a PBX, re-program for No Automatic **FLASH** or the PBX will go into ON-HOLD status when the **REDIAL** key is pressed.

0#: No automatic **FLASH**

1#: Automatic **FLASH**

0019#-(0, 1-4)#

**OUTSIDE LINE FLASH TIMER - OFF-HOOK (MANUAL)**

Sets the timer to temporarily release the outside line by pressing the **FLASH** or **REDIAL** key.

0#: 0.5 second

1#: 1 second

2#: 1.5 seconds

3#: 2 seconds

4#: 3 seconds

**0020#-(0,1-4)#**

**SSD STORED OUTSIDE LINE FLASH TIMER**

Sets the timer to temporarily release the outside line by pressing the **FLASH** key.

- 0#: 0.5 second
- 1#: 1 second
- 2#: 1.5 seconds
- 3#: 2 seconds
- 4#: 3 seconds

**0021#-(0,1-7)#**

**DIAL PAUSE TIMER - OUTSIDE LINE**

After making an outside line call and hanging up there is a timed pause before you can dial out to make a second call.

- 0#: 0.75 second
- 1#: 1 second
- 2#: 2 seconds
- 3#: 4 seconds
- 4#: 6 seconds
- 5#: 8 seconds
- 6#: 12 seconds
- 7#: 16 seconds

**0022#-(0,1-7)#**

**OUTSIDE LINE GUARD TIMER - INCOMING CALLS**

After answering an incoming call and hanging up there is a timed pause before you can access another outside line.

- 0#: 0.75 second
- 1#: 1 second
- 2#: 2 seconds
- 3#: 4 seconds
- 4#: 6 seconds
- 5#: 8 seconds
- 6#: 12 seconds
- 7#: 16 seconds



**0023#-(0,1 or 2)#**

**PULSE DIAL MINIMUM PAUSE**

Sets a pause between digits dialed during pulse dialing.

0#: 640 ms  
1#: 752 ms  
2#: 896 ms

---

**0024#-(HHMMN)#**

**SWITCHING TIME FOR NIGHT MODE (AUTOMATIC)**

You can set the system, so that it switches automatically from day mode to night.

Enter the time using the 12-hour system followed by 1 for A.M. or 2 for P.M.:

**8:02 P.M. = 08022**  
**12:00 A.M. = 12001**  
**11:59 A.M. = 11591**

CONF #: Remains in day mode

HHMMN#: Automatically switches to night mode. 01-12 (HH), 00-59 (MM), 00-59 (SS), N=1 (A.M.) or 2 (P.M.)

**0025#-(0 or 1)#**

**TRANSFER ON-HOOK (AUTOMATIC)**

An incoming call can be transferred to another extension by entering the extension number and replacing the receiver. The extension at the other end receives an incoming call tone.

If automatic transfer is not programmed, see **Operating Instructions, Section 700** for information on manual transfer.

0#: On-Hook transfer disable  
1#: On-Hook transfer enable

0026#-(0 or 1)#

**ONE-TOUCH KEY**

You can dial stored telephone numbers and SPD codes by pressing a single key if the system is programmed for One-Touch Call.

0#: One-touch call not possible  
1#: One-touch call

0027#-(0 or 1)#

**BACKGROUND MUSIC (BGM)**

0#: BGM disabled  
1#: BGM enabled

0028#-(0,1-3)#

**INFORMATION TONE FOR VOICE CALLING**

Sets the information or splash tone for extensions called by voice. The tone is sounded for 0.5 second before the caller's voice is heard.

0#: Tone for voice call and paging call  
1#: Tone for voice call  
2#: Tone for paging call  
3#: No information tone

0029#-(0 or 1)#

**CO SIGNAL - OFF-HOOK - ALERT TONE**

An alert tone will sound to announce a second call.

0#: No alert tone  
1#: Alert tone

**0030#-(0 or 1)#**

**STATION LOCKOUT ID CODE**

Displays the ID code on an LCD telephone.

0#: ID code not displayed  
1#: ID code displayed

**0031#-(0 or 1)#**

**SSD DISPLAY RESTRICTION (80-89)**

Sets the system to display telephone numbers during an SSD call and REDIAL. If SSD calls are programmed not to display, then redialed telephone numbers are not displayed either.

0#: Number not displayed  
1#: Number displayed

**NOTE:** AUTO (00-79) SSD numbers are always displayed.

**0032#-(0 or 1)#**

**DATA SECURITY**

Prohibits interrupting conversations or data transmissions.

0#: Can interrupt  
1#: Cannot interrupt

0033#-(0,1-7)#

**EXTENSION HOLD RECALL TIMER**

A recall warning tone sounds to indicate that an outside line call has not been answered within a specified time after being put on **HOLD** from an extension other than the attendant's phone.

Set the hold recall timer at between 20-180 seconds.

- 0#: No recall
- 1#: Recall 20 seconds
- 2#: Recall 40 seconds
- 3#: Recall 60 seconds
- 4#: Recall 90 seconds
- 5#: Recall 120 seconds
- 6#: Recall 150 seconds
- 7#: Recall 180 seconds

0034#-(0,1-7)#

**TRANSFER RECALL TIMER**

If an outside line call is not answered within a specified time after being transferred, the call will revert back to the original extension.

Set the extension transfer recall timer at between 20-180 seconds.

- 0#: No recall
- 1#: Recall 20 seconds
- 2#: Recall 40 seconds
- 3#: Recall 60 seconds
- 4#: Recall 90 seconds
- 5#: Recall 120 seconds
- 6#: Recall 150 seconds
- 7#: Recall 180 seconds

0035#-(0,1-5)#

**SLT ON-HOOK (AUTOMATIC) DETECTION TIMER**

Set the line flash on an SLT to either line **FLASH** or disconnect when the hook button is pressed longer or less than the time set for a line **FLASH**. (referred to as the hooking operation).

No Detection	Line Flash	Disconnect
0#: No detection		
1#: <u>Less than 250ms</u>	250 - 500 ms	<u>Over 500 ms</u>
2#: Less than 250ms	250 - 1000 ms	Over 1000 ms
3#: Less than 250ms	250 - 1500 ms	Over 1500 ms
4#: Less than 250ms	250 - 2000 ms	Over 2000 ms
5#: Less than 250ms	250 - 3000 ms	Over 3000 ms

**NOTE:** Can **only** be set using the **POWER SETTING**. See page 7 in this manual for instructions.

0036#-(0 or 1)#

**SLT OUTSIDE LINE HOLD**

An outside line call on your extension can be put on System Hold or Exclusive Hold.

0#: System hold  
1#: Exclusive hold

0037#-(0 or 1)#

**SLT INTERCOM CALL RING PATTERN**

0#: Internal ring signal pattern  
1#: Same as incoming call signal pattern

0038#-(0,1-4)#

**CPC SIGNAL TIMER - SLT EXTENSION LINE**

The CPC signal is a disconnect signal sent to the SLT.

- 0#: No signal
- 1#: 0.25 second
- 2#: 0.50 second
- 3#: 0.75 second
- 4#: 1 second

---

0039#-(0 or 1)#

**DOOR BOX SPEECH PATH**

The 308 system has 2 analog speech paths and the 616 system has 4 analog speech paths. One of these speech paths for each system can be set aside for the door box only.

- 0#: No door box speech path
- 1#: Door box speech path

0040#-(0 or 1)#

**SENSOR DETECTING SIGNAL**

- 0#: Detects a make signal
- 1#: Detects a break signal

0041#-(0 or 1)#

**SENSOR SIGNAL ALARM RING STOP**

- 0#: Sensor detecting signal stops the alarm ring
- 1#: Picking up the receiver stops the alarm ring

**0042#-(0 or 1)#**

**MULTI-PURPOSE RELAY 2 FUNCTION**

0#: Multi-purpose relay 2  
1#: Incoming ring signal

**0043#-(0 or 1)#**

**MULTI-PURPOSE RELAY 1 OPERATION**

0#: Relay operated as programmed time  
1#: Relay operated continually

**0044#-(0 or 1)#**

**MULTI-PURPOSE RELAY 2 OPERATION**

0#: Relay operated as programmed time  
1#: Relay operated continually

**0045#-(0,1-7)#**

**MULTI-PURPOSE RELAY 1 OPERATION TIMER**

0#: 0.125 second  
1#: 1 second  
2#: 2 seconds  
3#: 3 seconds  
4#: 4 seconds  
5#: 5 seconds  
6#: 6 seconds  
7#: 7 seconds

0046#-(0,1-7)#

**MULTI-PURPOSE RELAY 2 OPERATION TIMER**

0#: 0.125 second

1#: 1 second

2#: 2 seconds

3#: 3 seconds

4#: 4 seconds

5#: 5 seconds

6#: 6 seconds

7#: 7 seconds



**PSD 2 KEY - TRUNK SETTING**

<(Outside line) address#-(data)#>

(01-06) 01#-(0 or 1)#

**DIAL SIGNAL - OUTSIDE LINE**

0#: 10 pps pulse dial  
1#: DTMF signal dial

(01-06) 02#-(0, 1 or 2)#

**DTMF SIGNAL SENDING TIME**

0#: 80 ms ON/ 80 ms OFF  
1#: 125 ms ON/125 ms OFF  
2#: 250 ms ON/150 ms OFF

(01-06) 03#-(0 or 1)#

**CONNECTED PHONE LINE**

0#: CO line  
1#: PBX line

(01-06) 04#-(0 or 1)#

**PAUSE FUNCTION FOR PBX LINE (AUTOMATIC)**

0#: No pause  
1#: Automatic pause

(01-06) 05#-(0 or 1)#

**DTMF SIGNAL CONVERSION (AUTOMATIC)**

The dial signal automatically converts to a DTMF signal within 15 seconds after pulse dialing. Pressing # or \* is not required.

However, during incoming calls the dial signal automatically converts immediately without a 15-second interval.

0#: Automatic conversion disable

1#: Automatic conversion enable

(01-06) 06#-(0 or 1)#

**DTMF SIGNAL CONVERSION (MANUAL)**

Press # or \* to convert the dial signal to a DTMF signal after pulse dialing.

0#: Conversion disable

1#: Conversion enable

(01-06) 07#-(0 or 1)#

**DTMF SIGNAL SENDING TIME (AFTER DIALING)**

When you change from pulse dialing to a DTMF signal during dialing the sending time of the DTMF signal can also be changed.

0#: No change

1#: Changes length of the DTMF signal sending time

---

**NOTE:** See **Installation Instructions, Section 300** for information on how to cut the jumper cable on the Key System Unit.

---

**(01-06) 08#-(0, 1 or 2)#**

**DTMF SIGNAL SENDING TIME TABLE (AFTER DIALING)**

0#: 160 ms  
1#: 320 ms  
2#: 480 ms

**NOTE:** See also address (01-06) 07# on page 38.

**(01-06) 09#-(0, 1 or 2)#**

**OUTSIDE LINE DISCONNECT CPC SIGNAL DETECTION**

The system automatically cancels a CO line call if a disconnect signal is received.

0#: No detection of CPC signal  
1#: Detection only while on HOLD  
2#: Detection anytime

**(01-06) 10#-(0,1-7)#**

**OUTSIDE LINE DISCONNECT CPC DETECTING TIMER**

The disconnect timer can be set within a range of 48 ms to 704 ms.

0#: More than 48 ms  
1#: More than 96 ms  
2#: More than 192 ms  
3#: More than 304 ms  
4#: More than 400 ms  
5#: More than 496 ms  
6#: More than 592 ms  
7#: More than 704 ms

(01-06) 11#-(0 or 1)#

**POOLED TRUNK ACCESS DIAL 9**

When 9 is dialed there is an automatic connection to a vacant line in the group.

0#: Not assigned to pooled trunk access dial 9

1#: Pooled trunk access dial 9

**NOTE:** See **Installation Instructions, Section 300** for information on how to cut the jumper cable on the Key System Unit.

(01-06) 12#-(CONF,1-3)#

**POOLED TRUNK ACCESS GROUP**

When 81-83 is dialed there is an automatic connection to a vacant line in the trunk group. A maximum of three groups can be assigned in the system in any combination.

CONF: Not subject to pooled trunk access group

- 1#: Pooled trunk access group 81
- 2#: Pooled trunk access group 82
- 3#: Pooled trunk access group 83
- 1,2#: Pooled trunk access groups 81 and 82
- 1,2,3#: Pooled trunk access groups 81, 82 and 83
- 1, 3#: Pooled trunk access groups 81 and 83
- 2, 3#: Pooled trunk access groups 82 and 83

(01-06) 13#-(0,1-8)#

### INCOMING RING TONE PATTERN

The ring tone pattern can be changed for each trunk port.

- 0#: Synchronized incoming ring tone
- 1#: 3 seconds ON/1 second OFF
- 2#: 2 seconds ON/2 seconds OFF
- 3#: 1 second ON/1 second OFF
- 4#: 1 second ON/3 seconds OFF
- 5#: 0.5 second ON/0.5 second OFF
- 6#: 0.5 second ON/0.5 second OFF,  
0.5 second ON/2.5 seconds OFF
- 7#: 0.5 second ON/3.5 seconds OFF
- 8#: 1 second ON/7 seconds OFF

(01-06) 14#-(0,1-7)#

### INCOMING RING SIGNAL DETECTION TIME

Detects an incoming ring signal when the signal is longer than the time programmed for an incoming ring signal.

- 0#: More than 50 ms
- 1#: More than 100 ms
- 2#: More than 150 ms
- 3#: More than 200 ms
- 4#: More than 250 ms
- 5#: More than 300 ms
- 6#: More than 350 ms
- 7#: More than 400 ms

(01-06) 15#-(0,1-7)#

**INCOMING RING PATTERN DETECTION TIMER**

Because incoming call ring patterns sometimes vary, the timer can be set up to a maximum of 14 seconds to ensure that the ring cycle on incoming calls is not cut off prematurely.

- 0#: 3 seconds
- 1#: 4 seconds
- 2#: 5 seconds
- 3#: 6 seconds
- 4#: 8 seconds
- 5#: 10 seconds
- 6#: 12 seconds
- 7#: 14 seconds

(01-06) 16#-(0,1-3)#

**EXTERNAL RINGER OPERATION**

Use with multi-purpose relay 2.

- 0#: Disable
- 1#: Day ringer
- 2#: Night ringer
- 3#: Day and night ringer

(01-06) 17#-(0 or 1)#

**INCOMING CALL FORWARDING**

- 0#: Cannot accept call forwarding
- 1#: Call forwarding

(01-06) 18#-(0,1-3)#

**DELAYED RING FUNCTION OPERATION**

---

0#: Disable

1#: Day delayed ring

2#: Night delayed ring

3#: Day and night delayed ring

(01-06) 19#-(0,1-4)#

**DELAYED RING TRANSFERRING TIME**

0#: Disable

1#: After 15 seconds

2#: After 30 seconds

3#: After 45 seconds

4#: After 60 seconds

---

(01-06) 20#-(10-25)#

**DELAYED RING TRANSFER TO EXTENSION NUMBERS**

CONF: Clear

(10-25)#: Extension numbers

### PSD 3 KEY - EXTENSION SETTING

<(Extension number) address#-(data)#>

(10-25) 01#-(CONF,1-6)#

### DAY INCOMING RING SETTING

Sets the ring assignment in the day mode on a per line per extension basis.

#### CONF: Clear (12-25)

1#: Trunk 1  
2#: Trunk 2  
3#: Trunk 3  
4#: Trunk 4  
5#: Trunk 5  
6#: Trunk 6

**NOTE:** Trunks 1-6 are the default settings for the attendant's phone.

(10-25) 02#-(CONF,1-6)#

### NIGHT INCOMING RING SETTING

Sets the ring assignment in night mode on a per line per extension basis.

#### CONF: Clear (12-25)

1#: Trunk 1  
2#: Trunk 2  
3#: Trunk 3  
4#: Trunk 4  
5#: Trunk 5  
6#: Trunk 6

**NOTE:** Trunks 1-6 are the default settings for the attendant's phone.



(10-25) 03#-(0,1 or 2)#

### ANSWERING CALLS (AUTOMATIC)

Incoming calls assigned to ring can be answered in the order received by simply picking up the receiver.

---

0#: No pickup  
1#: Receiver only  
2#: Receiver and ON/OFF key

(10-25) 04#-(0,1-3)#

### CALL WAITING

A busy tone is sent from one extension to another if the called extension is on another call.

0#: Cannot accept call waiting  
1#: Accepts outside calls  
2#: Accepts internal calls (12-25)  
3#: Accepts outside and internal calls (attendant-ext.10,11)

(10-25) 05#-(CONF,1-3)#

### PAGING GROUPS

Sets an extension for paging groups 1, 2 or 3.

CONF: Clear  
1#: Paging group 1  
2#: Paging group 2  
3#: Paging group 3

(10-25) 06#-(0 or 1)#

### SENSOR ALARM RING

0#: No ring (12-25)  
1#: Ring (attendant-ext.10,11)

(10-25) 07#-(0,1-3)#

### DOOR BOX CALLS

Sets an extension to receive door box calls.

0#: No door box calls (12-25)

1#: Door box A calls only

2#: Door box B calls only

3#: Door box A and B calls (attendant-ext.10,11)

---

(10-25) 08#-(0 or 1)#

### CALL DURATION DISPLAY

Displays conversation time on an LCD telephone.

0#: Time not displayed

1#: Time displayed

(10-25) 09#-(0 or 1)#

### BUSY OVERRIDE

Allows an extension to override a busy port.

---

0#: Busy override impossible

1#: Busy override possible

(10-25) 10#-(0 or 1)#

### BUSY OVERRIDE REJECTION

Busy override is not possible when an extension is set for rejecting it.

0#: Busy override rejected

1#: Busy override accepted

**NOTE:** Conference calls cannot be interrupted.

(10-25) 11#-(0 or 1)#

**DATA SECURITY**

0#: Disable  
1#: Enable

(10-25) 12#-(0 or 1)#

**VOICE ANNOUNCE OFF-HOOK (MANUAL)**

0#: Rejection  
1#: Acceptance

(10-25) 13#-(0 or 1)#

**HYBRID SYSTEM/DUAL PORT OPERATION**

Connect either the key telephone or SLT to a port for Hybrid operation. For Dual Port operation both the key telephone and the SLT must be connected to the same port.

0#: Hybrid operation  
1#: Dual port operation

---

**NOTE:** Can only be set using the **POWER SETTING**. See page 7 in this manual for instructions.

(10-25) 14#-(0 or 1)#

**KEY TELEPHONE EXTENSION LOCKOUT IN NIGHT MODE**

0#: Functioning  
1#: Locked out

(10-25) 15#-(0 or 1)#

**SLT OUTSIDE LINE DIAL**

0#: Pulse  
1#: DTMF signal

(10-25) 16#-(0 or 1)#

**HEADSET MODE**

---

0#: Not connected  
1#: Connected

(10-25) 17#-(0 or 1)#

**DIAL TONE DISABLE**

0#: Disable  
1#: Enable

**PSD 4 KEY - FF KEY ASSIGNMENT**

<Address#-(data)HOLD>

**0002#-(4-digit number)HOLD**

**CO LINE 2**

Sets trunk port number 2 for the FF key for every telephone and DSS.

CONF: Clear  
(4-digit number)HOLD

**0003#-(4-digit number)HOLD**

**CO Line 3**

Sets trunk port number 3 for the FF key for every telephone and DSS.

CONF: Clear  
(4-digit number)HOLD

**0004#-(4-digit number)HOLD**

**CO LINE 4**

Sets trunk port number 4 for the FF key for every telephone and DSS.

CONF: Clear  
(4-digit number)HOLD

**0005#-(4-digit number)HOLD**

**CO Line 5**

Sets trunk port number 5 for the FF key for every telephone and DSS.

CONF: Clear  
(4-digit number)HOLD

**0006#-(4-digit number)HOLD**

**CO LINE 6**

Sets trunk port number 6 for the FF key for every telephone and DSS.

**CONF: Clear**  
**(4-digit number)HOLD**

**NOTE:** The FF Keys are a system-wide setting. Every telephone is assigned the same code; see page 17.

<Address#-(data)#>

0001#-(0 or 1)#

**SYSTEM INSTALLATION AREA CODE**

Sets whether it is necessary to dial 1 before an area code when making long distance calls.

0#: Area code only

1#: 1 + area code

---

0002#-(0 or 1)#

**PBX INTERNAL CALL RESTRICTION**

0#: PBX intercom calls prohibited

1#: PBX intercom calls

0003#-(0 or 1)#

**PBX INCOMING CALL RESTRICTION**

0#: PBX incoming calls prohibited

1#: PBX incoming calls

0004#-(0 or 7-32)#

**MAXIMUM NUMBER OF DIGITS DIALED**

Sets the maximum number of digits dialed from an extension.

0#: Dial any number of digits

7#-32#: Dial signal restricted after 7th-32nd digit

**DIALING RESTRICTION DURING INCOMING CALLS**

Dial signal can not be sent to outside lines.

0#: Dialing during incoming calls not restricted

1#: Programmed TRS type restrictions

2#: Dialing during conversation restricted

**0006#-(0 or 1)#**

**# AND \* KEYS DIAL RESTRICTION**

0#: Not restricted

1#: Restricted

**0007#-(0 or 1)#**

**STATION LOCKOUT TYPE 1**

An extension can answer incoming calls, but cannot place outgoing calls.

**0008#-(0,1-9)#**

**PBX DIAL 1**

Determines dialing when there are TRS call restrictions.

0#: No digits dialed

1#: 1 digit

2#: 2 digits

3#: 3 digits

4#: 4 digits

5#: 5 digits

6#: 6 digits

7#: 7 digits

8#: 8 digits

9#: 9 digits



**PBX DIAL 2**

0#: No digits dialed

- 1#: 1 digit
- 2#: 2 digits
- 3#: 3 digits
- 4#: 4 digits
- 5#: 5 digits
- 6#: 6 digits
- 7#: 7 digits
- 8#: 8 digits
- 9#: 9 digits

0010#-(0,1-9)#

**PBX DIAL 3**

0#: No digits dialed

- 1#: 1 digit
- 2#: 2 digits
- 3#: 3 digits
- 4#: 4 digits
- 5#: 5 digits
- 6#: 6 digits
- 7#: 7 digits
- 8#: 8 digits
- 9#: 9 digits

0011#-(0,1-9)#

**PBX DIAL 4**

0#: No digits dialed

- 1#: 1 digit
- 2#: 2 digits
- 3#: 3 digits
- 4#: 4 digits
- 5#: 5 digits
- 6#: 6 digits
- 7#: 7 digits
- 8#: 8 digits
- 9#: 9 digits

~~V1.0~~  
~~0012#-(0,1-9)#~~

**PBX DIAL 5**

0#: No digits dialed

- 1#: 1 digit
- 2#: 2 digits
- 3#: 3 digits
- 4#: 4 digits
- 5#: 5 digits
- 6#: 6 digits
- 7#: 7 digits
- 8#: 8 digits
- 9#: 9 digits

0013#-(0,1-9)#

**PBX DIAL 6**

0#: No digits dialed

- 1#: 1 digit
- 2#: 2 digits
- 3#: 3 digits
- 4#: 4 digits
- 5#: 5 digits
- 6#: 6 digits
- 7#: 7 digits
- 8#: 8 digits
- 9#: 9 digits

0014#-(0,1-9)#

**PBX DIAL 7**

0#: No digits dialed

- 1#: 1 digit
- 2#: 2 digits
- 3#: 3 digits
- 4#: 4 digits
- 5#: 5 digits
- 6#: 6 digits
- 7#: 7 digits
- 8#: 8 digits
- 9#: 9 digits

**PBX DIAL 8**

0#: No digits dialed

- 1#: 1 digit
- 2#: 2 digits
- 3#: 3 digits
- 4#: 4 digits
- 5#: 5 digits
- 6#: 6 digits
- 7#: 7 digits
- 8#: 8 digits
- 9#: 9 digits

0016#-(0,1-9)#

**PBX DIAL 9**

0#: No digits dialed

- 1#: 1 digit
- 2#: 2 digits
- 3#: 3 digits
- 4#: 4 digits
- 5#: 5 digits
- 6#: 6 digits
- 7#: 7 digits
- 8#: 8 digits
- 9#: 9 digits

0017#-(0,1-9)#

**PBX DIAL 0**

0#: No digits dialed

- 1#: 1 digit
- 2#: 2 digits
- 3#: 3 digits
- 4#: 4 digits
- 5#: 5 digits
- 6#: 6 digits
- 7#: 7 digits
- 8#: 8 digits
- 9#: 9 digits

V1.0  
0018#-(00-89)#**SSD TOLL RESTRICTIONS OVERRIDE**

Calls from specified SSD numbers are not restricted even on telephones set for toll restriction **Types 0-3**.

(00-89)#: Calls can be made by SSD code 00-89 despite restrictions.

**AREA AND OFFICE CODE TABLES - MAJOR ACCESS LEVELS**

- Type 0:** Cannot place or receive outside calls. Only intercom calls are possible.
- Type 1:** Cannot place outside calls, but can receive incoming calls.
- Type 2:** Can make only local calls and programmed special area code table 1 calls and 1-800 or 800 calls. Cannot make 411, 555 or 976 calls.
- Type 3:** Can make only local calls and programmed special area code table 1 and table 2 calls.
- Type 4:** No restrictions.

**Table 1 Cancelling 6-digit restriction for **Types 2 and 3****

0101-0116#-(maximum 6-digit numbers)#.

**Table 2 Cancelling 6-digit restriction for **Type 3**.**

0201-0216#-(maximum 6-digit numbers)#.

The following Toll Restrictions in PSD 5 can be copied from port to port.

---

<(Ext.)Address#-(data)#>

(10-25) 01#-(0 or 1)#

**STATION LOCKOUT CAPABILITY**

Restricts outside line calls on an unattended telephone.

0#: Disabled  
1#: Enabled

(10-25) 02#-(0 or 1)#

**SSD TOLL RESTRICTIONS CANCELLED**

---

0#: SSD number restricted  
1#: SSD number not restricted

(10-25) 03#-(0,1-4)#

**DAY RESTRICTION TYPES - TRUNK 1**

0#: Type 0  
1#: Type 1  
2#: Type 2  
3#: Type 3  
4#: Type 4

(10-25) 04#-(0,1-4)#

**DAY RESTRICTION TYPES - TRUNK 2**

0#: Type 0  
1#: Type 1  
2#: Type 2  
3#: Type 3  
4#: Type 4

**DAY RESTRICTION TYPES - TRUNK 3**

- 0#: Type 0
- 1#: Type 1
- 2#: Type 2
- 3#: Type 3
- 4#: Type 4

**(10-25) 06#-(0,1-4)#**

**DAY RESTRICTION TYPES - TRUNK 4**

- 0#: Type 0
- 1#: Type 1
- 2#: Type 2
- 3#: Type 3
- 4#: Type 4

**(10-25) 07#-(0,1-4)#**

**DAY RESTRICTION TYPES - TRUNK 5**

- 0#: Type 0
- 1#: Type 1
- 2#: Type 2
- 3#: Type 3
- 4#: Type 4

**(10-25) 08#-(0,1-4)#**

**DAY RESTRICTION TYPES - TRUNK 6**

- 0#: Type 0
- 1#: Type 1
- 2#: Type 2
- 3#: Type 3
- 4#: Type 4

**NIGHT RESTRICTION TYPES - TRUNK 1**

0#: Type 0  
1#: Type 1  
2#: Type 2  
3#: Type 3  
4#: Type 4

**(10-25) 10#-(0,1-4)#**

**NIGHT RESTRICTION TYPES - TRUNK 2**

0#: Type 0  
1#: Type 1  
2#: Type 2  
3#: Type 3  
4#: Type 4

**(10-25) 11#-(0,1-4)#**

**NIGHT RESTRICTION TYPES - TRUNK 3**

0#: Type 0  
1#: Type 1  
2#: Type 2  
3#: Type 3  
4#: Type 4

**(10-25) 12#-(0,1-4)#**

**NIGHT RESTRICTION TYPES - TRUNK 4**

0#: Type 0  
1#: Type 1  
2#: Type 2  
3#: Type 3  
4#: Type 4

V1.0  
(10-25) 13# (0,1-4)#

**NIGHT RESTRICTION TYPES - TRUNK 5**

- 0#: Type 0
- 1#: Type 1
- 2#: Type 2
- 3#: Type 3
- 4#: Type 4

(10-25) 14#-(0,1-4)#

**NIGHT RESTRICTION TYPES - TRUNK 6**

- 0#: Type 0
- 1#: Type 1
- 2#: Type 2
- 3#: Type 3
- 4#: Type 4



<Address#-(data)#>

**0101#-(0 or 1)#**

**SMDR PRINTING MODE 1**

0#: Prints outgoing calls only  
1#: Prints incoming/outgoing calls

**0102#-(0 or 1)#**

**SMDR PRINTING MODE 2**

0#: Prints data only  
1#: Prints titles and data

**0103#-(0 or 1)#**

**DATA TRANSMISSION SPEED/BAUD RATE**

0#: 4800 bps  
1#: 1200 bps

**0104#-(0 or 1)#**

**STOP BIT LENGTH**

0#: 1 bit  
1#: 2 bits

**DATA LENGTH**

0#: 7 bits

1#: 8 bits

---

0106#-(0 or 1)#

**PARITY CHECK**

Checks for errors during printing by aligning data protocol specifications between the S-DBS and the SMDR printer or when carrying out on-site maintenance through the RS-232-C connector. The sent data is totaled and the resulting odd/even value is referred to as a parity check.

0#: No parity check

1#: Parity check

0107#-(0 or 1)#

**EVEN/ODD NUMBER PARITY**

0#: Odd number parity

1#: Even number parity

# Index

## A

- # and \* Keys Dial Restriction 52
- Answering Calls (Automatic) 45
- Automatic Pause
  - Dial 0 26
  - Dial 1 23
  - Dial 2 23
  - Dial 3 24
  - Dial 4 24
  - Dial 5 24
  - Dial 6 25
  - Dial 7 25
  - Dial 8 25
  - Dial 9 26
- Timer 26

## B

- Background Music (BGM) 30
- Busy Override 46
  - Rejection 46

## C

- Call Duration Display 46
- Call Waiting 45
- CO Line 2 49
- CO Line 3 49
- CO Line 4 49
- CO Line 5 49
- CO Line 6 50
- CO Signal - Off-Hook - Alert Tone 30
- Connected Phone Line 37
- CPC Signal Timer - SLT Port 3

## D

- Data
  - Length 62
  - Security 31, 47
  - Transmission Speed/Baud Rate 61
- Date 21

## Day

- Incoming Ring Setting 44
- Restriction Types
  - Trunk 1 57
  - Trunk 2 57
  - Trunk 3 58
  - Trunk 4 58
  - Trunk 5 58
  - Trunk 6 58
- Days of the Week 22
- Delayed Ring
  - Function Operation 43
  - Transfer to Extension Numbers 43
  - Transferring Time 43
- Dial
  - Pause Timer - Outside Line 28
  - Signal - Outside Line 37
  - Tone Disable 48
- Dialing Restriction during Incoming Calls 52

## Door Box

- Calls 46
- Speech Path 34
- DTMF Signal
  - Conversion (Automatic) 38
  - Conversion (Manual) 38
  - Sending Time 37, 38
  - Sending Time Table 39
- Dual-Port Operation 47

## E

- Even/Odd Number Parity 62
- Extension HOLD Recall Timer 32
- External Ringer Operation 42

## F

- FF Key
  - CO Line 2 17
  - CO Line 3 17
  - CO Line 4 17
  - CO Line 5 17
  - CO Line 6 17
- FLASH REDIAL (Automatic) 27

## G, H

- Headset Mode 48
- Hybrid System/Dual Port Operation 47

## I, J

Incoming  
  Call Forwarding 42  
  Ring Pattern Detection Timer 42  
  Ring Signal Detection Time 41  
  Ring Tone Pattern 41  
Information Tone for Voice Calling 30

## K

Key Telephone Extension Lockout in  
  Night Mode 47

## L, M

Maximum Number of Digits Dialed 51  
Multi-Purpose  
  Relay 1  
    Operation 35  
    Operation Timer 35  
  Relay 2  
    Function 35  
    Operation 35  
    Operation Timer 3

## N

Night Incoming Ring Setting 44  
Night Restriction Types  
  - Trunk 1 59  
  - Trunk 2 59  
  - Trunk 3 59  
  - Trunk 4 59  
  - Trunk 5 60  
  - Trunk 6 60

## O

One-Touch Key 30  
Outside Line  
  Disconnect CPC  
    Detecting Timer 39  
    Signal Detection 39  
  FLASH Timer - Off-Hook (Manual)  
    27  
  Guard Timer - Incoming Calls 28  
  Setting 22

## P, Q, R

Paging Groups 45  
Parity Check 62  
Pause Function for PBX Line (Auto-  
  matic) 37  
PBX  
  Dial 0 55  
  Dial 1 52  
  Dial 2 53  
  Dial 3 53  
  Dial 4 53  
  Dial 5 54  
  Dial 6 54  
  Dial 7 54  
  Dial 8 55  
  Dial 9 55  
  Incoming Call Restriction 51  
  Internal Call Restriction 51  
Pooled Trunk Access  
  Dial 9 40  
  Group 40  
Pulse Dial Minimum Pause 29

## S

Sensor  
  Alarm Ring 45  
  Detecting Signal 35  
  Signal Alarm Ring Stop 34

## SLT

Intercom Call Ring Pattern 33  
On-Hook Detection Timer 33  
Outside Line Dial 48  
Outside Line HOLD 33

## SMDR

Printing  
  Mode 1 61  
  Mode 2 61  
Timer - Starting Time Display for  
  Outside Calls 27

## SSD

Display Restriction (80-89) 31  
Stored Outside Line FLASH Timer 28  
Toll Restrictions Cancelled 57  
Toll Restrictions Override 56

Station Lockout  
  Capability 57  
  ID Code 31  
  Type 1 52  
Stop Bit Length 61  
Switching Time for Night Mode  
  (Automatic) 29  
System Installation Area Code 51

**T, U**

---

Time 21  
  Display 21  
Transfer  
  On-Hook (Automatic) 29  
  Recall Timer 32

**V**

Voice Announce Off-Hook (Manual) 47

**W, X, Y, Z**

**DIGITAL**

Digital Business System

Programming Guidance Manual

Section 400

Issue 1. January 1990

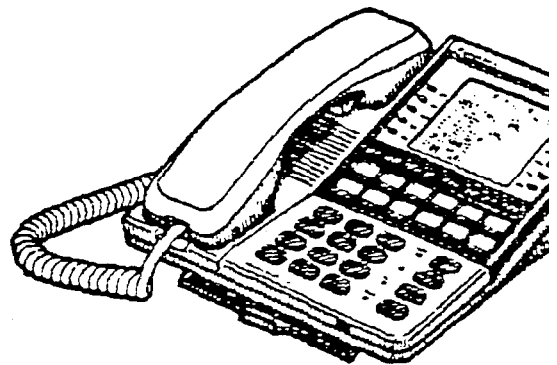

Panasonic DBS Small  
For Models:

Notification to your local telephone company

Before connecting or disconnecting, inform the following to the telephone company:

COL 1:	( )	COL 2:	( )	COL 3:	( )
COL 4:	( )	COL 5:	( )	COL 6:	( )
COL 7:	( )	COL 8:	( )	COL 9:	( )
COL10:	( )	COL11:	( )	COL12:	( )
COL13:	( )	COL14:	( )	COL15:	( )
COL16:	( )	COL17:	( )	COL18:	( )
COL19:	( )	COL20:	( )	COL21:	( )
COL22:	( )	COL23:	( )	COL24:	( )
COL25:	( )	COL26:	( )	COL27:	( )
COL28:	( )	COL29:	( )	COL30:	( )
COL31:	( )	COL32:	( )	COL33:	( )
COL34:	( )	COL35:	( )	COL36:	( )
COL37:	( )	COL38:	( )	COL39:	( )
COL40:	( )	COL41:	( )	COL42:	( )
COL43:	( )	COL44:	( )	COL45:	( )
COL46:	( )	COL47:	( )	COL48:	( )
COL49:	( )	COL50:	( )	COL51:	( )
COL52:	( )	COL53:	( )	COL54:	( )
COL55:	( )	COL56:	( )	COL57:	( )
COL58:	( )	COL59:	( )	COL60:	( )
COL61:	( )	COL62:	( )	COL63:	( )
COL64:	( )				

Model numbers ..... Panasonic: VB-43030/43050/43060  
 FCC registration number for ..... ACK4A4-60490-KF-E  
 Note. 1 ..... ACK4A4-60489-MF-E

- Check that the FCC registration No. on the nameplate on the side panel of the main cabinet is the same as the number listed above.

Finger equivalence ..... 0.5B  
 Service order code ..... 9.0F  
 Network address signaling code ..... E  
 Facility interface code ..... 02LS2  
 Required network interface code ..... RJ21X

Note 1: When enabling automatic line selection to use, contact the telephone installer or a Panasonic service center. In this case, please inform your telephone company of FCC Registration number MF-E. The FCC registration number is found on the key service unit. According to FCC rules, this function is regarded as one of the distinguishing features of a PBX as opposed to a key telephone system.

Direct connection to a Party-line or Coin-operated telephone line is prohibited. If you are on a party line, check with your local telephone company. To assure the safe use of your telephone, please observe the following guide lines for installation and use.

This product is an electrical device and can be hazardous if immersed in water. To avoid the risk of electrical shock, do not use this unit while in the bathtub, shower, or when wet. If you accidentally drop the unit into water, unplug it first, then retrieve it by pulling it out by the cord.

Do not use the telephone near the sources of electric "noise" such as fluorescent lamps, air conditioner, washing machine, TV sets or radios.

The telephone should not be exposed to heat sources, direct sunlight, extreme temperatures, moisture, strong vibrations, greasy or dusty environments.

Never clean the telephone with benzene, paint thinner or other solvents.

Do not change the unit installation location without consulting the dealer or installer.

## Chapter 1 Program Outline

### 1 - 1 Order of Program Setting

Set the program according to the following procedure.

**Step:1**

Be sure you understand functions and working of the program as described in this manual and the operating instruction.

**Step:2**

Prepare the program setting data table to comply with the users requirements.

**Step:3**

Confirm the makeup of the system to be installed and prepare LCD telephone for program setting.

**Step:4**

Reset the system to the initial status and set the programming data.

**Step:5**

Call back the program number on the LCD of the telephone and confirm the contents to be set.

**Step:6**

Correct the setting and confirm the change, then complete the program setting.

### 1-2 Structure and Working of Program

The program for this system comprises the following 10 modes (FF1 - 10), each of which in the 10 respective FF keys (Flexible Function Keys; see Fig. 2 - 4).

At the time of setting the FF keys, whose functions it is required to change are pressed, and after entering the program mode as shown in the diagram below the address numbers are input and the data is set.

The diagram below illustrates the reciprocal relationships between the program modes.

**FF1. System setting**

Setting the basic operations for the system

**FF2. Trunk setting**

Specification setting for each outside line port

**FF3. Extension setting**

Specification setting for each extension port

**FF4. Incoming ring**

Assigning outside line calls to each extension

**FF5. FF key assignment**

Assigning outside lines to each extension FF key

**FF6. Name storing**

Storing the names and absence messages for the extension and SSD

**FF7. Toll restriction**

Setting the outside line calls from extension

**FF8. LCR mode**

Setting the lowest cost outside line

**FF9. Copy mode**

Copying the TRUNK,EXT setting to another port

**FF10. Spd number setting**

Setting SSD number and PSD number



## Chapter 2 Programming Method

### 2 - 1 Preparing Programming Data Table

Before setting a program, the data schedule is prepared. Hand the questionnaire (found in the Section 450 programming table) about the programming specifications for the telephone to the customer and enter the necessary functions and installation specifications in the programming table based on the details recorded therein.

#### Cautions when Preparing Data Table

- A. Keep the trunk lines, extensions and connected equipment not being used in the initial set status without including them in the programming.
- B. Be sure to record the fact every time changes are made to the programming data table. This will be necessary in the future for maintenance purposes and when extra telephones and outside lines are added.
- C. The functions of those items marked by \*\* in the setting data table cannot be set or changed during operation. Do the programming when the functions are no longer being used.

Address number	Feature name	Setting data number and initial data	Setting data	Relate program number
Address No.	Feature	Option selected	Setting data	Related setting
** 1-1#	Date Setting.	0-5 MONTH		

Fig. 2 - 1 Example of Section 450 Programming Table

## 2 - 2 System Necessary for Program

Programming is performed from an attendant's display telephone. An attendant's telephone is one connected to extension port No. 1 or No. 2. In addition, programming is also possible from another extension by means of a programmed ID code for programming. While programming is possible in some cases while the system is functioning, in others the program may not allow for this when, for example, extension numbers cannot be changed during use. Refer to the separate explanation about programs which cannot be set. When setting from a telephone connected to the test terminal (CN3) of the main cabinet, do so with reference to the diagram below.

### Setting from attendant's telephone

(Extension port number 1 or 2)

For entering the programming mode, ON/OFF → PROG → ## is input from the attendant's telephone.

### Setting from general telephone

When programming from a telephone other than the attendant's, ON/OFF → #98 → (4-9999 digit code number) → PROG → ## is input.

TEST SET ALSO  
9999

### Cautions when programming

- A. After having set DSS and EM124, turn off the main power source or unplug the DSS or EM124 once. If this is not done, DSS and EM124 will not operate.
- B. If the setting for the paging group is changed during a page call, this call cannot be answered.
- C. When a telephone is not connected to extension port 2 and extension number 101, the system is in the nighttime mode after commencing the programming from the attendant's telephone. So, after the setting manually, put it into the daytime mode.
- D. The name setting can only be programmed from the attendant's telephone.

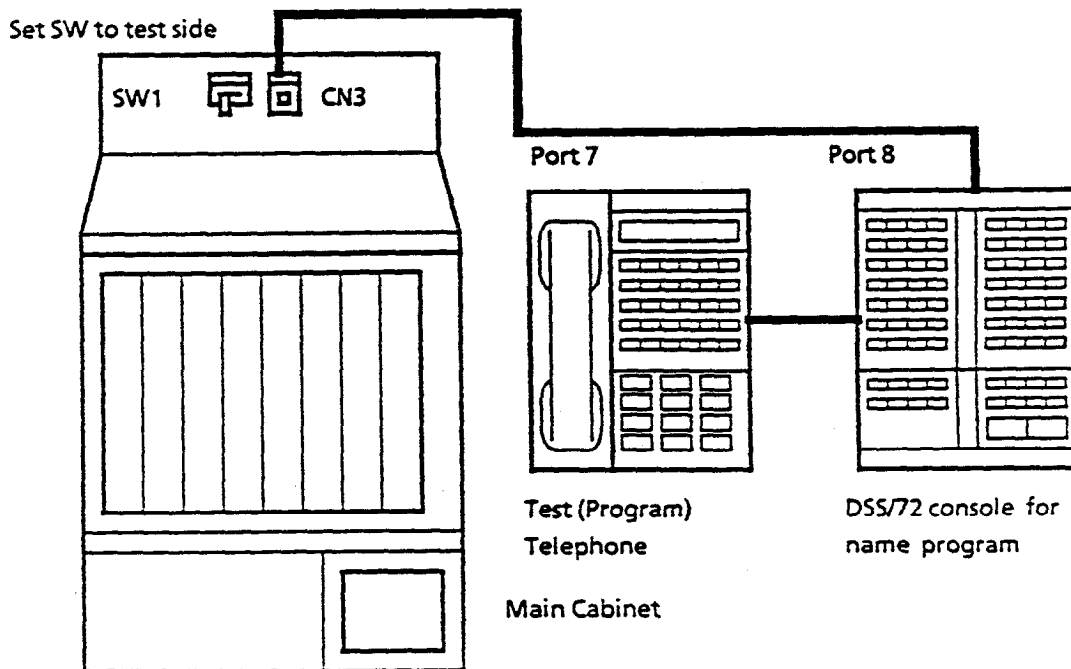

Fig. 2-2 Test terminal

### 2-3 Initial Set

Before setting when programming for the first time, be sure to initialize the RAM data for the CPC card for the main cabinet.

The operation is as follows.

1. With the power for the main cabinet turned off, clear the CPC RAM switch.
2. Turn on the power for the main cabinet. After flickering for about 10 seconds, the CPC lamp goes off.
3. Put the CPC RAM switch to HOLD.
4. The LED lamp flickers and system mode is reset to the initial status.

This operation is not necessary when programming the next time.

Note that if this operation is repeated for each programming, all the data programmed up until be erased.

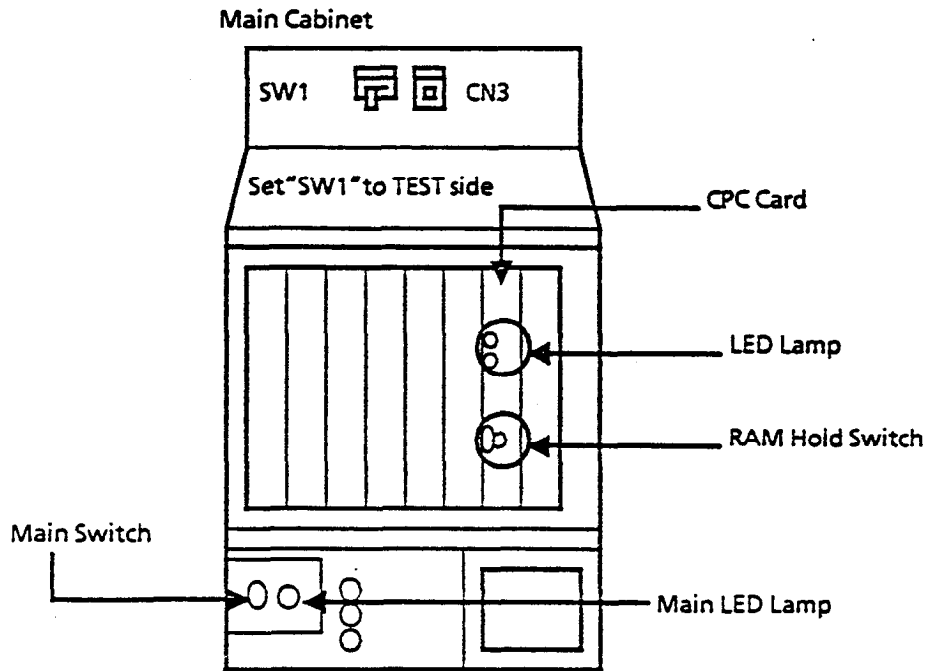

Fig. 2-3 Initial set for main cabinet

### 2 - 4 Explanation about Keys Used for Programming

The keys used when programming and their operations are as shown below.

**Note :** Changing the input mode from numerical to alphabetical with the CONF key, together with back spacing with the AUTO key and the alphabetical data of each 10 key are only effective in the cases stated below.

In cases other than these the numbers and letters are input from the DSS console. (DSS / 72)

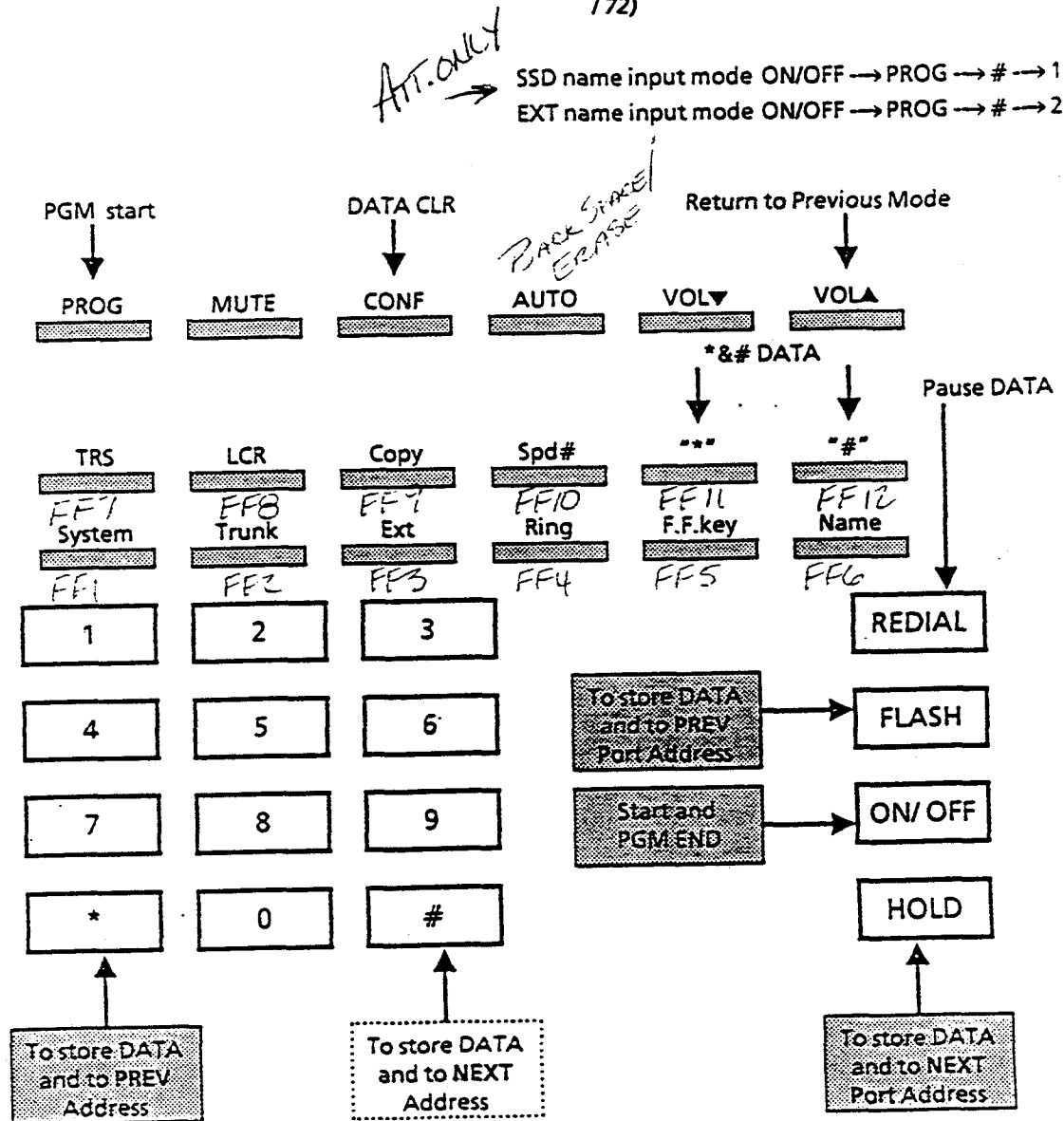

Fig. 2-4 Structure of PGM Keys

## 2 - 5 Programming Method

While programming be sure to confirm the details on the telephone display.  
"[]" in the table indicates the name of the key being used.

<u>Operation contents</u>	<u>LCD contents</u>
---------------------------	---------------------

1. The current date is set from extension number 100.  
Press [ON/OFF] key    Current date and time  
                                 display is deleted  
Press [PROG] key    "F" is displayed  
Press [#] key    "F#" is displayed  
Press [#] key    "Program Mode  
                                 MAIN MODE" is  
                                 displayed  
Now in program mode
2. The FF key corresponding to the necessary function is input.  
Press [FF1]    "system program  
                                 SELECT SUB MODE" is  
                                 displayed  
Now in system program mode
3. The group number corresponding to the necessary function is input.  
Press [1] key    "1" is displayed  
Press [#] key    "SELECT TIME MODE  
                                 1:DATE 2:TIME" is  
                                 displayed  
Press [1 #] key    "DATE SET MODE  
                                 MONTH/DAY/YEAR  
Now in date set mode
4. The setting values are input.  
Press month MM    "MM" is displayed  
Press date DD    "MMDD" is displayed  
Press year YY    "MMDDYY" is displayed  
Press [#] key    Next address is displayed

The date input with the [#] key is registered.

5. The setting values are completed.  
Press [ON/OFF] key    Input date is displayed

## 2 - 6 Initial Set Data Table

<u>Address Number</u>	<u>Function</u>	<u>Initial</u>	<u>Page</u>
1-1-1	DATE SET MODE	JAN.1.1989	11
1-1-2	TIME SET MODE	12:00	11
1-2-1-1	CALL DURATION	Time displayed	11
1-2-1-2	SMDR TIMER 30/16	Starting from 16 sec.	11
1-2-1-3	LCR FUNCTION	Pooled trunk access call	11
1-2-1-4	OVERRIDE TRS	Toll restriction type 2 - 6	12
1-2-1-5	DENY SPD - DIAL	Displayed	12
1-2-1-6	AUTO FLASH CONT.	Auto flash	12
1-2-1-7	ONE - TOUCH DIAL	One - touch call possible	12
1-2-1-8	ON-HOOK TRANSFER	On-hook transfer possible	12
1-2-1-9	KEY BANK HOLD	No automatic hold	13
1-2-1-10	NON - AP. HOLD MODE	System hold	13
1-2-1-11	SLT FLASH CONT.	Hold release	13
1-2-1-12	DIGIT OF EXT.#	3 digits	13
1-2-1-13	ALT. ATT MODE	Alternate mode	14
1-2-1-14	ATT CALL MODE	Voice call	14
1-2-1-15	EXT CALL MODE	Voice call	14
1-2-1-16	SPT ON V - CALL	Information tone sound	14
1-2-1-17	SPT ON OVERRIDE	No sound	14
1-2-1-18	SYSTEM LOCATION	1 + Area	14
1-2-1-19	SSD DISP MODE	1 SSD name on 1 large display line	14
1-2-1-20	API card assignment	(PCAS only. Read PCAS manuals)	15
1-2-1-21	VOICE MAIL TONE	Internal busy tone	15
1-2-2-1	TTY PARITY	No parity check	15
1-2-2-2	TTY PARITY MODE	Even Parity	15
1-2-2-3	TTY BAUD RATE	1200bps	15
1-2-2-4	TTY STOP BIT	1 bit	15
1-2-2-5	TTY DATA LENGTH	8 bits	15
1-2-2-6	SMDR OUT/INCOME	Printing for income / outgoing	16
1-2-2-7	SMDR LONG/LOCAL	Local call and long distance call	16
1-2-2-8	SMDR TITLE CONT	Without titles	16
1-2-2-9	TTY X ON/X OFF	No control	16
1-2-3-1	PBX DIAL 1		16
1-2-3-2	PBX DIAL 2		17
1-2-3-3	PBX DIAL 3		17
1-2-3-4	PBX DIAL 4		17
1-2-3-5	PBX DIAL 5		17
1-2-3-6	PBX DIAL 6		17
1-2-3-7	PBX DIAL 7		17
1-2-3-8	PBX DIAL 8		17
1-2-3-9	PAUSE POSITION 1	No auto pause	17
1-2-3-10	PAUSE POSITION 2	No auto pause	18
1-2-3-11	PAUSE POSITION 3	No auto pause	18
1-2-3-12	PAUSE POSITION 4	No auto pause	18
1-2-3-13	PAUSE POSITION 5	No auto pause	18
1-2-3-14	PAUSE POSITION 6	No auto pause	18
1-2-3-15	PAUSE POSITION 7	No auto pause	18
1-2-3-16	PAUSE POSITION 8	No auto pause	19
1-2-3-17	PAUSE POSITION 9	No auto pause	19
1-2-3-18	PAUSE POSITION 0	No auto pause	19
1-2-4-1	RING PATTERN	CM (1sec, on/3sec.off) BM (3sec, on/1sec.off)	19

<u>Address Number</u>	<u>Function</u>	<u>Initial</u>	<u>Page</u>
1-2-4-2	PAGE GROUP (#0)	No EPI relay operation	19
1-2-4-3	PAGE GROUP (#1)	No EPI relay operation	20
1-2-4-4	PAGE GROUP (#2)	No EPI relay operation	20
1-2-4-5	PAGE GROUP (#3)	No EPI relay operation	20
1-2-4-6	PAGE GROUP (#4)	No EPI relay operation	20
1-2-4-7	PAGE GROUP (#5)	No EPI relay operation	20
1-2-4-8	PAGE GROUP (#6)	No EPI relay operation	20
1-2-4-9	PAGE GROUP (#7)	No EPI relay operation	20
1-3-1	NIGHT START TIME	No auto switching	21
1-3-2	RECALL TIME - ATT	After 20 sec.	21
1-3-3	RECALL TIME - EXT	After 140 sec.	21
1-3-4	TRF - RECALL ATT	After 20 sec.	21
1-3-5	TRF - RECALL EXT	After 140 sec.	22
1-3-6	HNT - RECALL ATT	After 20 sec.	22
1-3-7	HNT - RECALL EXT	After 140 sec.	22
1-3-8	PARK - RECALL ATT	After 20 sec.	22
1-3-9	PARK - RECALL EXT	After 140 sec.	23
1-3-10	REVERSION TIMER	After 180 sec.	23
1-3-11	CO - CO TALK TIME	While 10 min.	23
1-3-12	PAUSE TIMER	3.5 sec.	24
1-3-13	CO FLASH TIMER	1.2 sec.	24
1-3-14	SLT ON-HOOK/FLASH	No func. $\leq$ 200ms: flash: 1500ms $\leq$ Disc,	24
1-3-15	RINGING TIMER	Less than 6sec.	25
1-3-16	RING DELAY TIMER	350ms	25
1-3-17	DIAL SEND TIMER	1.0sec.	26
1-3-18	PBX FLASH TIMER	0.8sec.	26
1-3-19	CFWD NO - ANS TIN	12sec.	27
1-4	REMOTE MAINT. ID	9999	27
1-5	DISA INCOME ID	No ID is required	28
1-6-1#	DISA OUT - GOING ID#1	9999	28
1-6-2#	DISA OUT - GOING ID#2	9999	28
1-7	PROGRAMMING ID	9999	28
2-(1-32)-1	DENY TRUNK USE	All functions ope.	29
2-(1-32)-2	DIAL SEND TYPE	DTMF signal	29
2-(1-32)-3	TRUNK GROUP "9"	Accessible	29
2-(1-32)-4	TRUNK GROUP "81"	No access	29
2-(1-32)-5	TRUNK GROUP "82"	No access	29
2-(1-32)-6	TRUNK GROUP "83"	No access	29
2-(1-32)-7	TRUNK GROUP "84"	No access	29
2-(1-32)-8	TRUNK GROUP "85"	No access	29
2-(1-32)-9	TRUNK GROUP "86"	No access	29
2-(1-32)-10	TRUNK TYPE	CO line	30
2-(1-32)-11	ENABLE DISA	Disable	30
2-(1-32)-12	PRIVATE PORT	No private line	30
2-(1-32)-13	AUTO PAUSE	Yes	30
2-(1-32)-14	D/T DETECTION	DT detection	30
2-(1-32)-15	TONE SEND TIME	75ms on/50ms off	30
2-(1-32)-16	CALL DIVERSION	Not possible	31
2-(1-32)-17	INCOME TONE PTN	Income ring synchronized	31
2-(1-32)-18	DISCONNECT TIME	After 350ms	31
2-(1-32)-19	DISA START TIME	00:00 to 24:00	32
2-(1-32)-20	DISA END TIME	00:00 to 24:00	32

*HUNTING  
TURN OFF  
OFF HOOK  
SIGNALING*

<u>Address Number</u>	<u>Function</u>	<u>Initial</u>	<u>Page</u>
3-(1-72)-1	EXT LOGICAL NO.	100 to 699(10 to 69)	33
3-(1-72)-2	TEL SET TYPE	Auto set	33
3-(1-72)-3	USED BLF PORT#	Not connected	34
3-(1-72)-4	FORCED LCR MODE	Not connected	34
3-(1-72)-5	FORCED ACCT. CODE	LCR call only	34
3-(1-72)-6	LOCK OUT CODE	No function	34
3-(1-72)-7	CO OFF-HOOK SIGNAL	Sound	34
3-(1-72)-8	CALL WAITING	Accept	35
3-(1-72)-9	BUSY OVERRIDE	Not possible	35
3-(1-72)-10	BUSY OVERRIDDEN	Not accept	35
3-(1-72)-11	PRIME LINE	No function	35
3-(1-72)-12	RING LINE PREF	Enable	35
3-(1-72)-13	MAKE CO CONF.	Not possible	35
3-(1-72)-14	SMDR PRINT Y/N	Print	36
3-(1-72)-15	ALERT TONE VOL	Lower Medium	36
3-(1-72)-16	OFF-HOOK SIG PTN	Continuous	36
3-(1-72)-17	PSD DISP. MODE	1 PSD name on 1 large display line	
3-(1-72)-18	PAGE GROUP #00	No	36
3-(1-72)-19	PAGE GROUP #01	No	36
3-(1-72)-20	PAGE GROUP #02	No	36
3-(1-72)-21	PAGE GROUP #03	No	36
3-(1-72)-22	PAGE GROUP #04	No	36
3-(1-72)-23	PAGE GROUP #05	No	36
3-(1-72)-24	PAGE GROUP #06	No	36
3-(1-72)-25	PAGE GROUP #07	No	36
3-(1-72)-26	DISPLAY ON IDLE	No change	37
3-(1-72)-27	DISPLAY ON IDT	No change	38
3-(1-72)-28	DISPLAY ON INT	No change	39
3-(1-72)-29	DISPLAY ON CO - 1	No change	40
3-(1-72)-30	DISPLAY ON CO - 2	No change	41
3-(1-72)-31	DISPLAY ON PAGE	No change	42
3-(1-72)-31	DISPLAY ON WAIT	No change	43
3-(1-72)-30	DISPLAY ON BUSY	No change	44
4-1-(1-73)-(1-32)	DAY RING PROG.		46
4-2-(1-73)-(1-32)	NIGHT RING PROG.		47
4-3-(1-8)-1	HUNTING GROUP		48
4-3-(1-8)-2	NEXT HUNT GROUP		49
4-3-1-(3-10)	HUNT-G.01 PROGRAM		50
4-3-8-(3-10)	HUNT - G.08 PROGRAM		50
4-4-(1-16)-(1-8)	CALL COVERAGE GROUP		51
5-(1-72)-(1-24)	FUNCTION ASSIGN		52
5-(73-76)-(1-24)	DSS FUNCTION ASSIGN		53
6-1	EXT. NAME MODE		55
6-2	SYS. SPD NAME MODE		55
6-3	PERSONAL SPD NAME MODE		55
6-4	ABSENCE MESSAGE.		55
7-1-1	INT CALL TRS	Restricted	56
7-1-2	DIALING AT INCOMING	Dial possible	56
7-1-3	DIGITS TRS DATA	No restriction	57
7-1-4	211 TRS Y/N	Impossible	57
7-1-5	311 TRS Y/N	Impossible	57
7-1-6	411 TRS Y/N	Impossible	57

*FF3*

*FF4*

*FF5*

*FF6*

*FF7*



FF 7

FF 8

FF 9

FF 10

<u>Address</u>	<u>Function</u>	<u>Initial</u>	<u>Page</u>
7-1-7	511 TRS Y/N	Impossible	57
7-1-8	611 TRS Y/N	Impossible	57
7-1-9	711 TRS Y/N	Impossible	57
7-1-10	811 TRS Y/N	Impossible	57
7-1-11	911 TRS Y/N	Impossible	57
7-1-12	7 DIGIT TRS Y/N	Restriction	58
7-1-13	7 DIGIT TRS Y/N	Restriction	58
7-1-14	7 DIGIT TRS Y/N	Restriction	58
7-1-15	7 DIGIT TRS Y/N	Restriction	58
7-1-16	7 DIGIT TRS Y/N	Restriction	58
7-2-(3-6)	SET AREA CODE		59
7-3-(3-6)	SET OFFICE CODE		59
7-4-(1-4)	SPECIAL AREA CODE		60
7-5-(1-4)	SPECIAL OFFICE CODE		61
7-6-(1-50)	SET 7 DIGITS TRS NUMBER		62
7-7-(1-72)-(1-32)	DAY TRS TYPE	Type 7(No restriction)	63
7-7-(1-72)-33	DAY TRS TYPE		63
7-8-(1-72)-(1-32)	NIGHT TRS TYPE	Type 7(No restriction)	64
7-8-(1-72)-33	NIGHT TRS TYPE		64
7-9-(1-4)	AREA CODE TYPE (3-6)		65
7-9-(5-8)	OFFICE CODE TYPE (3-6)		65
7-9-(9-12)	AREA & OFFICE TYPE (3-6)		65
7-9-(13-16)	OFFICE CODE SP - AR (1-4)		65
8-1-(1-15)-(000-999)-(0 or 1)	SET AREA CODE		67
8-2-(1-15)-(000-999)-(0 or 1)	SET OFFICE CODE		67
8-3-(1-4)	SPECIAL AREA CODE		68
8-4-(1-4)	SPECIAL OFFICE CODE		69
8-5-(1-15)-(1-8)	TIME PRIORITY TABLE		70
8-6-(1-8)-(1-8)	TRUNK GROUP TABLE		71
8-7-1	TRUNK GROUP #1 (DIAL DEL)		71
8-7-2	TRUNK GROUP #2 (DIAL DEL)		71
8-7-3	TRUNK GROUP #3 (DIAL DEL)		71
8-7-4	TRUNK GROUP #4 (DIAL DEL)		71
8-7-5	TRUNK GROUP #5 (DIAL DEL)		71
8-7-6	TRUNK GROUP #6 (DIAL DEL)		71
8-7-7	TRUNK GROUP #7 (DIAL DEL)		71
8-7-8	TRUNK GROUP #8 (DIAL DEL)		71
8-8-1	TRUNK GROUP #1 (DIAL ADD.)		72
8-8-2	TRUNK GROUP #2(DIAL ADD.)		72
8-8-3	TRUNK GROUP #3(DIAL ADD.)		72
8-8-4	TRUNK GROUP #4(DIAL ADD.)		72
8-8-5	TRUNK GROUP #5(DIAL ADD.)		72
8-8-6	TRUNK GROUP #6(DIAL ADD.)		72
8-8-7	TRUNK GROUP #7(DIAL ADD.)		72
8-8-8	TRUNK GROUP #8(DIAL ADD.)		72
9-1-(1-32)-(1-32)	COPY TRK MODE		73
9-2-(1-32)-(1-32)	COPY TEL MODE		73
9-3-(1-32)-(1-32)	COPY FF MODE		73
10-1-(00-89)	SYSTEM SPD MODE		75
10-2-(01-72)-(90-99)	PERSONAL SPD MODE		75

## Chapter 3 Programming Explanation

### 3 - 1 System (System pivotal program) mode

Construction of explanation is as follows.

Title	Introduce the title of each function.
Address number	Describe the order of key press.
Contents	Explanation setting data and specification.
Initial set	Indicate the initial setting data with underline.

#### 3 - 1 - 1 Calendar and Time Setting mode

FF1-1#-1#( Month -Day - Year(Low 2 digits))

##### **Date Setting**

With this setting the date is stored in the clock within the system.

The current day and date are displayed on telephones equipped with LCDs, while the date and day are also recorded during SMDR printing, etc. The day is automatically calculated and displayed on the system.

MM (01-12)

DD (01-31)

YY (89-99) (00-20)

For aligning the time to February 25, 1995, input as follows.

022595#

[CONF]-#:01:01

FF1-1#-2#(Hour(24H-format) - Minute )#

##### **Time Setting**

With this setting the time is stored in the clock within the system.

The current time is displayed on telephones equipped with LCDs, while the time is also recorded during SMDR printing, etc.

HH (00-23)

MM (00-59)

For aligning the time to 3:28pm, input as follows.

1528#

[CONF]-#:01:01

#### 3 - 1 - 2 System Program Setting mode

FF1-2#-1#-1#-(0 or 1)#

##### **Call duration display**

The time a telephone conversation with an outside line is taking can be displayed on a telephone with an LCD. Whether or not this display is required is specified. If it is set so that it is not displayed, the conversation time for incoming calls from when they are answered is not displayed either.

0#: Telephone conversation time not displayed

1#: Telephone conversation time displayed

FF1-2#-1#-2#-(0 - 1)#

##### **SMDR Timer / Starting time display for outside call**

In cases where the time taken for a outside call is to be displayed, it is specified whether it will start 16 seconds or 30 seconds after the dialing signal has been sent out.

This setting only functions if the outside call duration display in 1-2-1 has been specified. This setting notwithstanding, for incoming calls will start immediately, and display 16 seconds after they are answered.

0#: Starting from 16 sec.

1#: Starting from 30 sec.

FF1-2#-1#-3#-(0 or 1)#

##### **LCR (Least Cost Routing) call**

This is set for using the LCR call function. It is specified whether or not LCR is to be used when making an outside call by dial key 9. In either case it is necessary to cut the jumper wire on the CPU card in the main cabinet. See Section 300 the "Installation Manual" about this. It is also necessary to set "FF2-N#3#" and "Pooled Trunk Access Group 9" of "2. Trunk Mode".

0#: Pooled Trunk Access call when 9 keyed in

1#: Least Cost Routing call when 9 keyed in

FF1-2#-1#-4#(89-00)#

**SSD (System Speed Dial) toll restriction Canceling (Override TRS)**

It can be set so that calls from specified SSD numbers are not restricted even on telephones set for toll restriction types from 2 to 6. For example, it is set so that calls can be made from telephones subject to restrictions such as those at distant branches, fire station, etc. When a 2 digit Auto-(00 - 89) number is stored for the SSD code, when a call is made, from 89 to the number stored are not restricted. For example, when 80 is specified, calls can be made with the 10 SSD codes comprising Auto-(80 - 89) despite restrictions.

(00 - 89)#: Calls can be made by SSD code 00 - 89 despite restrictions

[CONF]-#: Toll restriction types 2 - 6 also applied during SSD calls

FF1-2#-1#-5#-(0 or 1)#

**Dial display restriction during system speed dial call**

It is specified whether the telephone number is to be indicated on the LCD during dialing when making a call by SSD (80 - 89). If set not to display, redialing after an SSD call and dialing with an LCR call are also not displayed. However, the names stored for SSD are displayed at such times.

0#: Dialing displayed during Auto-(80 - 89) call  
1#: Dialing not displayed during Auto-(80 - 89) call

Note: Auto (00 - 79) are displayed all the time.

FF1-2#-1#-6#-(0 - 1)#

**Auto - flash redial**

This setting is for automatically cutting of an outside line by pressing the redial key after one or more digits have been dialed and automatically dialing the same number again. In the case of the system is connected to the PBX, sometimes the PBX becomes on - hold status by the operation of "Automatically cutting of an outside line" using Redial key. At this time, Please set for "NO Auto Flash"

0#: No auto flash  
1#: Auto flash

Note 1: When setting this function, check that it is aligned with the setting for the outside line flash time as they are related.

Note 2: There is no flash if the dial is not input.

~~FF1-2#-1#-7#-(0 or 1)#~~

~~**One - touch outside dial call**~~

~~0#: One - touch call not possible  
1#: One - touch call possible~~

~~Note: Cannot be set for "One - touch call not possible."~~

FF1-2#-1#-8#-(0 or 1)#

**On-hook transfer**

A outside call can be transferred to another extension simply by pressing that extension's number and placing the handset on hook. The party to which the call is being transferred can talk with the party on the outside line simply by lifting his/her handset when the incoming call tone sounds. If this is not set, see operating instructions to how to transfer.

0#: On-hook transfer disable  
1#: On-hook transfer enable

FF1-2#-1#-9#-(0 or 1)#

**Outside line automatic hold  
(Key Bank Hold)**

It is possible to set an extension for putting an outside call on hold temporarily while making a call on another outside line.

In this case the initial call is automatically put on hold by pressing the FF key for the outside line you intend to use for the other call without the need for pressing the HOLD key.

A telephone call put on hold by this method is on system hold.

0#: No automatic hold

1#: Automatic hold

FF1-2#-1#-10#-(0 or 1)#

**Non - appearance outside line hold**

This setting is for specifying whether a call on an outside line not assigned to an FF key on your extension is to be put on system hold or exclusive hold.

This setting notwithstanding, it is not possible to obtain another outside line during non - appearance outside line hold.

0#: Exclusive hold

1#: System hold

*Note 1: During non - appearance outside line put on hold, the other outside line cannot to be held.*

*Note 2: This function applies to Single Line Telephone.*

FF1-2#-1#-11#-(0 - 1)#

**SLT Flash control**

During a telephone call by SLT the outside line can be put on hold by lightly tapping the hook button (hooking operation), and another outside line or extension can then be telephoned.

This setting is for specifying whether to wait for the intercom dial tone again or to release hold and resume the initial outside call.

0#: Get new IDT to another TRF

1#: Retrieve held CO line

*Note: Setting 0# here is related to setting the SLT hooking flash timer.*

FF1-2#-1#-12#-(0 or 1)#

**Extension number digit setting**

This is for specifying whether the extension number is to comprise 2 digits (Ext. 10 - 69) or 3 digits (Ext. 100 - 699). When over 60 extensions are installed, the setting for 3 digits should be done, before carrying out other settings.

By effecting this setting, the settings related to extension groups and settings involving other extension numbers all become invalid.

In addition, all the extension numbers and functions assigned to the FF keys of each extension are reset to their initial status.

At this time it is necessary to cut off the power for the main cabinet once.

Warn enough when this setting will be done.

0##: 2 digits (Extension numbers 10 - 69)

1##: 3 digits (Extension numbers 100 - 699)

## FF1-2#-1#-13#-(0 or 1)#

**Alternate attendants mode setting**

This setting is for when 2 attendants phones have been installed in the system.

When setting in the alternate mode, first call the attendant's phone connected to extension port No. 1.

If this is busy, call the attendant's connected to extension port No. 2.

0#: No alternate mode

1#: Alternate mode

## FF1-2#-1#-14#-(0 or 1)#

**Attendant calling mode**

This specifies if the attendant's intercom call is voice or tone. In addition, the attendant can switch this setting on individual calls by dialing [1] after establishing an intercom call

0#: Tone call from attendant

1#: Voice call from attendant

## FF1-2#-1#-15#-(0 or 1)#

**Extension calling mode**

This specifies if the extension's (except attendant's) intercom call is voice or tone. In addition, the attendant can switch this setting on individual calls by dialing [1] after establishing an intercom call

0#: Tone call

1#: Voice call

## FF1-2#-1#-16#-(0 or 1)#

**Information tone setting for voice calling**

When extension calling by voice, the information tone (Splash tone "Pu..!") can first be sounded for 0.5 seconds from the extension of the party being called.

This is specified when the extension calling mode is set to voice call.

0#: No Information tone with in voice call

1#: Information tone sounds for voice call

## FF1-2#-1#-17#-(0 or 1)#

**Information tone setting for busy override**

When the conversation on an extension has been interrupted, the information one is sent out to the extension of the party being overridden to indicate the fact.

This setting notwithstanding, busy override cannot be implemented for an extension involved in a conference call.

It is necessary to have a setting regarding busy override for each extension.

0#: No Information tone with in busy override

1#: Information tone sent out for busy override

## FF1-2#-1#-18#-(0 or 1)#

**System installation area setting**

This specifies if necessary or not to the dial 1 before the area code when making calls to places outside the area where the system is installed. If 1 is necessary when making calls to just some of the areas, set 1 + Area. Calls o other areas for which 1 is not necessary are regarded as local calls and so restricted by office codes, etc.

0#: No + 1 Area code location

1#: Necessary the 1 + Area code location

## FF1-2#-1#-19#-(0 or 1)#

**SSD name display mode**

This specifies the quantity of names displayed on the large display. The option is for 5 names or 10 names. When displaying 10 names the maximum length shown will be 7 characters.

0#: Display 5 names in large display

1#: Display 10 names in large display

FF1-2#-1#-20#-(0 or 1-9)#

**Application interface card assignment**

This specifies the extension card slot number for the API card to be used.

Assign this only when using the optional software.

0#: No API card assigned

1# : Extension card slot 1 is API card

2# : Extension card slot 2 is API card

3# : Extension card slot 3 is API card

4# : Extension card slot 4 is API card

5# : Extension card slot 5 is API card

6# : Extension card slot 6 is API card

7# : Extension card slot 7 is API card

8# : Extension card slot 8 is API card

9# : Extension card slot 9 is API card

FF1-2#-1#-21#-(0 or 1-9)#

**Voice mail busy tone mode**

This specifies if the DBS will send busy tone or silence to the voice mail ports after an internal conversation has ended.

0#: Silence to voice mail DEFAULT

1#: DBS internal busy tone to voice mail

FF1-2#-2#-1#-(0 or 1)#

**Parity check**

This is for aligning the data protocol specifications between the machines when connecting an SMDR printer to the system or carrying out remote maintenance through the telephone circuit, for example. Here it is specified whether to check for the occurrence of errors during the communication of data. The method of checking involves adding up the data sent and determining whether this constitutes an odd or even value. This is referred to as a parity check.

0#: No parity check

1# : Parity check

FF1-2#-2#-2#-(0 or 1)#

**Even/odd number parity**

The mode of the parity check for the communication data is set.

0# : Odd number parity

1#: Even number parity

FF1-2#-2#-3#-(1-4)#

**Data transmission speed (baud rate)**

The baud rate for data transmission is set between 300 bps and 9600 bps. However, whatever the setting may be usually, it is 300 bps when carrying out remote maintenance through the telephone circuit.

1# : 300 bps

2#: 1200 bps

3# : 4800 bps

4# : 9600 bps

DEFAULT

3.0 ↑

FF1-2#-2#-4#-(1-3)#

**Stop bit length**

The length of the stop bit for transmitted data is set.

1#: 1 bit

2# : 1.5 bits (Less than 90 port system only)

3# : 2 bits

FF1-2#-2#-5#-(1-4)#

**Data length**

The length of the transmitted data is set between 5 and 8 bits.

1# : 5 bits (Less than 90 port system only)

2# : 6 bits (Less than 90 port system only)

3# : 7 bits

4#: 8 bits

FF1-2#-2#-6#-(0 or 1)#

**SMDR printing mode 1 (Outgoing / Incoming)**

This is for specifying whether to have the contents recorded with the SMDR printer when making outside calls only, or to have the contents when answering incoming calls printed in addition to the former.

- 0#: SMDR printing the outgoing calls only
- 1#: SMDR printing incoming and outgoing calls

*Note: For the SMDR printer to operate, as well as specifying printing in the system program it is necessary to set the following from the attendant's phone.*

- [On/Off]-[#]-[9]-[0]-[On/Off] Bus data print mode
- [On/Off]-[#]-[9]-[1]-[On/Off] Bus data resist mode
- [On/Off]-[#]-[9]-[2]-[On/Off] Bus data accumulate
- [On/Off]-[#]-[9]-[3]-[On/Off] SMDR printout

STAKT  
PRINT  
→

FF1-2#-2#-7#-(0 or 1)#

**SMDR printing mode 2 (Long / Local)**

This is for specifying whether to have the contents recorded with the SMDR printer when making toll calls only, or to have the contents when making local calls printed in addition to the former.

- 0#: SMDR printing the long distance calls only
- 1#: SMDR printing all outgoing calls

*Note 1: The long distance calls is as follows.*

(N = 2-9, P = 0.1, X = 0-9)  
 Non + 1 Area NPX-NNX-XXXX  
 + 1 Area 1-NPX-NNX-XXXX

*NPX is the area number, NNX the office number, and XXXX the phone number.*

*If the dialing starts with 1 or 0, it is deemed to be a long distance calls.*

FF1-2#-2#-8#-(0 or 1)#

**SMDR printing mode 3 (Title)**

It is specified whether to include titles such as "TIME", "DURAT" and "CO#" on the top line for making the data easy to read off, or to have the data only when using the SMDR printer. If there are titles, they are printed every 60 lines.

- 0#: SMDR printing of communication data only
- 1#: SMDR printing of data titles in addition to communication data

FF1-2#-2#-9#-(0 or 1)#

**Program data dump mode (X on/X off)**

This is to specify whether or not to control the X on/X off code should the data buffer overflow when connecting the data terminal for carrying out maintenance to the RS-232C interface for connecting the SMDR.

- 0#: X on/X off no control
- 1#: X on/X off controlled

FF1-2#-3#-1#-(0-999 or 0\* - 99\*)#

**PBX Dial 1**

The access numbers are set for when using the PBX circuit on the premises for as the systems outside lines, or for connecting from a WATT line, etc. to a line of a telephone central office.

This setting is used for determining the dialing when there are call restrictions for TRS, etc. In addition, "\*" can be stored as the wild card setting here.

When 7\* is set, for example, 70 to 79 are taken as PBX dialing. To clear the stored data, press [CONF] key.

(0-9, 00-99, 000-999 or 0\*-9\*, 00\*-99\*)#:  
Access numbers

*Note: To store wild card(\*), use FF11 instead of \* key.*

FF2 (TRK) = 10 = 2

LOH 02

FF1 2 = 3 = 1992

FF1-2#-3#-2#-(0-999,or 0\* - 99\*)#

**PBX Dial 2**

Same as PBX Dial 1.

(0-9,00-99,000-999 or 0\* - 9\*, 00\* - 99\*)#:  
Co access numbers

FF1-2#-3#-3#-(0-999,or 0\* - 99\*)#

**PBX Dial 3**

Same as PBX Dial 1.

(0-9,00-99,000-999 or 0\* - 9\*, 00\* - 99\*)#:  
Co access numbers

FF1-2#-3#-4#-(0-999,or 0\* - 99\*)#

**PBX Dial 4**

Same as PBX Dial 1.

(0-9,00-99,000-999 or 0\* - 9\*, 00\* - 99\*)#:  
Co access numbers

FF1-2#-3#-5#-(0-999,or 0\* - 99\*)#

**PBX Dial 5**

Same as PBX Dial 1.

(0-9,00-99,000-999 or 0\* - 9\*, 00\* - 99\*)#:  
Co access numbers

FF1-2#-3#-6#-(0-999,or 0\* - 99\*)#

**PBX Dial 6**

Same as PBX Dial 1.

(0-9,00-99,000-999 or 0\* - 9\*, 00\* - 99\*)#:  
Co access numbers

FF1-2#-3#-7#-(0-999,or 0\* - 99\*)#

**PBX Dial 7**

Same as PBX Dial 1.

(0-9,00-99,000-999 or 0\* - 9\*, 00\* - 99\*)#:  
Co access numbers

FF1-2#-3#-8#-(0-999,or 0\* - 99\*)#

**PBX Dial 8**

Same as PBX Dial 1.

(0-9,00-99,000-999 or 0\* - 9\*, 00\* - 99\*)#:  
Co access numbers

FF1-2#-3#-9#-(1-3)#

**Automatic pause position for each dial - Dial 1**

This is the setting for automatically inserting a pause during the dialing. When the PBX, etc. is accessed for making a call, several seconds are required from when the PBX receives the access number to when the connection is made with a telephone central office line.

Dialing sent out before this connection is made will be invalid and may result in a wrong connection.

With this setting completely trouble free dialing is enabled. Moreover, this setting is also effective for dialing from SSD and PSD.

The actual pause time is set separately (pause timer. FF1-3#-7#)

It is specified after which digit dialed there should be a pause having made a connection with an outside line of the system and then dialing 1.

**[CONF]#: No automatic pause after dialing 1**

1#: Automatic pause on 1st digit after dialing 1 at first.

2#: Automatic pause on 2nd digit after dialing 1 at first.

3#: Automatic pause on 3rd digit after dialing 1 at first.

Note: Automatic pause can't activate without setting pause for each trunk(FF2-(1~32)#-13#)



**FF1-2#-3#-10#-(1-3)#**

**Automatic pause position for each dial -  
Dial 2**

Same as (FF1-2#-3#-(1-3)#). It is specified after which digit dialed there should be a pause having made a connection with an outside line of the system and then dialing 2.

**[CONF]#: No automatic pause after dialing 2**

- 1#: Automatic pause at 1st digit after dialing 2
- 2#: Automatic pause at 2nd digit after dialing 2
- 3#: Automatic pause at 3rd digit after dialing 2

**FF1-2#-3#-11#-(1-3)#**

**Automatic pause position for each dial -  
Dial 3**

Same as (FF1-2#-3#-(1-3)#). It is specified after which digit dialed there should be a pause having made a connection with an outside line of the system and then dialing 3.

**[CONF]#: No automatic pause after dialing 3**

- 1#: Automatic pause on 1st digit after dialing 3
- 2#: Automatic pause on 2nd digit after dialing 3
- 3#: Automatic pause on 3rd digit after dialing 3

**FF1-2#-3#-12#-(1-3)#**

**Automatic pause position for each dial -  
Dial 4**

Same as (FF1-2#-3#-(1-3)#). It is specified after which digit dialed there should be a pause having made a connection with an outside line of the system and then dialing 4.

**[CONF]#: No automatic pause after dialing 4**

- 1#: Automatic pause at 1st digit after dialing 4
- 2#: Automatic pause at 2nd digit after dialing 4
- 3#: Automatic pause at 3rd digit after dialing 4

**FF1-2#-3#-13#-(1-3)#**

**Automatic pause position for each dial -  
Dial 5**

Same as (FF1-2#-3#-(1-3)#). It is specified after which digit dialed there should be a pause having made a connection with an outside line of the system and then dialing 5.

**[CONF]#: No automatic pause after dialing 5**

- 1#: Automatic pause at 1st digit after dialing 5
- 2#: Automatic pause at 2nd digit after dialing 5
- 3#: Automatic pause at 3rd digit after dialing 5

**FF1-2#-3#-14#-(1-3)#**

**Automatic pause position for each dial -  
Dial 6**

Same as (FF1-2#-3#-(1-3)#). It is specified after which digit dialed there should be a pause having made a connection with an outside line of the system and then dialing 6.

**[CONF]#: No automatic pause after dialing 6**

- 1#: Automatic pause at 1st digit after dialing 6
- 2#: Automatic pause at 2nd digit after dialing 6
- 3#: Automatic pause at 3rd digit after dialing 6

**FF1-2#-3#-15#-(1-3)#**

**Automatic pause position for each dial -  
Dial 7**

Same as (FF1-2#-3#-(1-3)#). It is specified after which digit dialed there should be a pause having made a connection with an outside line of the system and then dialing 7.

**[CONF]#: No automatic pause after dialing 7**

- 1#: Automatic pause at 1st digit after dialing 7
- 2#: Automatic pause at 2nd digit after dialing 7
- 3#: Automatic pause at 3rd digit after dialing 7

FF1-2#-3#-16#-(1-3)#

**Automatic pause position for each dial -  
Dial 8**

Same as (FF1-2#-3#-(1-3)#). It is specified after which digit dialed there should be a pause having made a connection with an outside line of the system and then dialing 8.

[CONF]#: No automatic pause after dialing 8

- 1#: Automatic pause at 1st digit after dialing 8
- 2#: Automatic pause at 2nd digit after dialing 8
- 3#: Automatic pause at 3rd digit after dialing 8

FF1-2#-3#-17#-(1-3)#

**Automatic pause position for each dial -  
Dial 9**

Same as (FF1-2#-3#-(1-3)#). It is specified after which digit dialed there should be a pause having made a connection with an outside line of the system and then dialing 9.

[CONF]#: No automatic pause after dialing 9

- 1#: Automatic pause at 1st digit after dialing 9
- 2#: Automatic pause at 2nd digit after dialing 9
- 3#: Automatic pause at 3rd digit after dialing 9

FF1-2#-3#-18#-(1-3)#

**Automatic pause position for each dial -  
Dial 0**

Same as (FF1-2#-3#-(1-3)#). It is specified after which digit dialed there should be a pause having made a connection with an outside line of the system and then dialing 0.

[CONF]#: No automatic pause after dialing 0

- 1#: Automatic pause at 1st digit after dialing 0
- 2#: Automatic pause at 2nd digit after dialing 0
- 3#: Automatic pause at 3rd digit after dialing 0

FF1-2#-4#-1#-(0 or 1)#

**Control ring patterns for UNA control  
terminals (M, C, B)**

When using UNA (Universal Night Answer), the operating specifications for each of the relay controlled terminals are determined. When utilizing a sound source for the buzzer, etc., "1 sec on/3 sec off" is selected.

When operating with the pattern set, it is connected from terminal C to terminal M or released from terminal C to terminal B. This setting is only effective when UNA is operating for incoming calls on outside lines.

Note : Ext port 73 is ringing assignment for UNA terminal (FF4-1#, FF4-2#)

0#: 3 sec / 1 sec interval

- 1#: Continuously

FF1-2#-4#-2#-(0 or 1)#

**EPI control when paging - #00**

It is set whether the EPI (External Page Interface) is to be used when calling paging group #00.

0#: No EPI relay operation when calling paging  
group 00

- 1#: EPI relay operation when calling paging  
group 00

FF1-2#-4#-3#-(0 or 1)#

**EPI control when paging - #01**

It is set whether the EPI (External Page Interface) is to be used when calling paging group #01.

0#: No EPI relay operation when calling paging  
group 01

- 1#: EPI relay operation when calling paging  
group 01

FF1-2#-4#-4#-(0 or 1)#

**EPI control when paging - #02**

It is set whether the EPI (External Page Interface) is to be used when calling paging group #02.

0#: No EPI relay operation when calling paging group 02

1#: EPI relay operation when calling paging group 02

FF1-2#-4#-5#-(0 or 1)#

**EPI control when paging - #03**

It is set whether the EPI (External Page Interface) is to be used when calling paging group #03.

0#: No EPI relay operation when calling paging group 03

1#: EPI relay operation when calling paging group 03

FF1-2#-4#-6#-(0 or 1)#

**EPI control when paging - #04**

It is set whether the EPI (External Page Interface) is to be used when calling paging group #04.

0#: No EPI relay operation when calling paging group 04

1#: EPI relay operation when calling paging group 04

FF1-2#-4#-7#-(0 or 1)#

**EPI control when paging - #05**

It is set whether the EPI (External Page Interface) is to be used when calling paging group #05.

0#: No EPI relay operation when calling paging group 05

1#: EPI relay operation when calling paging group 05

FF1-2#-4#-8#-(0 or 1)#

**EPI control when paging - #06**

It is set whether the EPI (External Page Interface) is to be used when calling paging group #06.

0#: No EPI relay operation when calling paging group 06

1#: EPI relay operation when calling paging group 06

FF1-2#-4#-9#-(0 or 1)#

**EPI control when paging - #07**

It is set whether the EPI (External Page Interface) is to be used when calling paging group #07.

0#: No EPI relay operation when calling paging group 07

1#: EPI relay operation when calling paging group 07

**3 - 1 - 3 System Timer Setting Mode**

*Here the settings relating to time are made for operating the system.*

*The appropriate settings should be specified according to the users preferences and actual method of use, while also taking into account the specifications for the outside lines connected.*

FF1-3#-1#-(0000 - 2359)#

**Automatic switching time for nighttime call mode**

The time for switching from daytime call mode to nighttime call mode is set so that the system does it automatically without the attendant performing the operation.

It is specified using the 24 hour system. For example, when the system is to switch to the nighttime mode at 8:02pm, 2002 is input.  
(00:00am - 0000 / 11:59pm - 2359)

[CONF]#: No automatic switching to nighttime call mode

(0000 - 2359)#: Automatic switching to nighttime mode

*Note: The day and nigh TRS modes can be set to different types. Confirm the TRS modes.*

FF1-3#-2#-(1 - 12)#

**Attendant's hold recall timer**

If an outside line call is not answered within the specified time after having been put on hold by the attendant's phone [by the attendant], the recall warning tone starts to sound to indicate that the time has been exceeded.

0#:No recall

1#:Recall after 20 seconds

2#:Recall after 40 seconds

3#:Recall after 60 seconds

4#:Recall after 80 seconds

5#:Recall after 100seconds

6#:Recall after 120 seconds

7#:Recall after 140 seconds

8#:Recall after 160 seconds

9#:Recall after 180 seconds

10#:Recall after 200 seconds

11#:Recall after 220 seconds

12#:Recall after 240 seconds

FF1-3#-3#-(1 - 12)#

**Extensions hold recall timer**

If outside line call is not answered within the specified time after having been put on hold from an extension other than the attendant's phone, the recall warning tone starts to sound to indicate that the time has been exceeded.

0#:No recall

1#:Recall after 20 seconds

2#:Recall after 40 seconds

3#:Recall after 60 seconds

4#:Recall after 80 seconds

5#:Recall after 100 seconds

6#:Recall after 120 seconds

7#:Recall after 140 seconds

8#:Recall after 160 seconds

9#:Recall after 180 seconds

10#:Recall after 200 seconds

11#:Recall after 220 seconds

12#:Recall after 240 seconds

FF1-3#-4#-(1 - 12)#

**Attendant's transfer recall timer**

This specifies if an outside line is transferred to another extension and is left unanswered for the length equal to or greater then this timer the call will recall to the attendant.

0#:No recall

1#:Recall after 20 seconds

2#:Recall after 40 seconds

3#:Recall after 60 seconds

4#:Recall after 80 seconds

5#:Recall after 100 seconds

6#:Recall after 120 seconds

7#:Recall after 140 seconds

8#:Recall after 160 seconds

9#:Recall after 180 seconds

10#:Recall after 200 seconds

11#:Recall after 220 seconds

12#:Recall after 240 seconds

FF1-3#-5#-(1-12)#

**Extension Transfer recall timer**

This specifies if an outside line is transferred to another extension and is left unanswered for the length equal to or greater than this timer the call will recall to the original extension which established the transfer.

- 0#:No recall
- 1#:Recall after 20 seconds
- 2#:Recall after 40 seconds
- 3#:Recall after 60 seconds
- 4#:Recall after 80 seconds
- 5#:Recall after 100 seconds
- 6#:Recall after 120 seconds
- 7#:Recall after 140 seconds
- 8#:Recall after 160 seconds
- 9#:Recall after 180 seconds
- 10#:Recall after 200 seconds
- 11#:Recall after 220 seconds
- 12#:Recall after 240 seconds

FF1-3#-6#-(1-12)#

**Attendant's hunting recall timer**

Calls which are transferred to a hunt group by any extension within the hunt group will recall to the attendant after the specified time of this recall timer.

- 0#:No recall
- 1#:Recall after 20 seconds
- 2#:Recall after 40 seconds
- 3#:Recall after 60 seconds
- 4#:Recall after 80 seconds
- 5#:Recall after 100 seconds
- 6#:Recall after 120 seconds
- 7#:Recall after 140 seconds
- 8#:Recall after 160 seconds
- 9#:Recall after 180 seconds
- 10#:Recall after 200 seconds
- 11#:Recall after 220 seconds
- 12#:Recall after 240 seconds

FF1-3#-7#-(1-12)#

**EXT. Hunting recall timer**

If a transferred incoming call is not answer by any hunting group member within the specified time after having been put on hold from an extension, the call rings back to the transferor extension.

- 0#:No recall
- 1#:Recall after 20 seconds
- 2#:Recall after 40 seconds
- 3#:Recall after 60 seconds
- 4#:Recall after 80 seconds
- 5#:Recall after 100 seconds
- 6#:Recall after 120 seconds
- 7#:Recall after 140 seconds
- 8#:Recall after 160 seconds
- 9#:Recall after 180 seconds
- 10#:Recall after 200 seconds
- 11#:Recall after 220 seconds
- 12#:Recall after 240 seconds

FF1-3#-8#-(1-12)#

**Attendant park hold recall timer**

If an attendant place a call in any of the 10 system park orbits, and leaves the call there for longer than the specified time, the call will recall to the attendant.

- 0#:No recall
- 1#:Recall after 20 seconds
- 2#:Recall after 40 seconds
- 3#:Recall after 60 seconds
- 4#:Recall after 80 seconds
- 5#:Recall after 100 seconds
- 6#:Recall after 120 seconds
- 7#:Recall after 140 seconds
- 8#:Recall after 160 seconds
- 9#:Recall after 180 seconds
- 10#:Recall after 200 seconds
- 11#:Recall after 220 seconds
- 12#:Recall after 240 seconds

FF1-3#-9#-(1 - 12)#

**Extension park hold recall timer**

If an extension place a call in their park orbits, and leaves the call there for longer than the specified time, the call will recall to the extension.

- 0#:No recall
- 1#:Recall after 20 seconds
- 2#:Recall after 40 seconds
- 3#:Recall after 60 seconds
- 4#:Recall after 80 seconds
- 5#:Recall after 100 seconds
- 6#:Recall after 120 seconds
- 7#:Recall after 140 seconds
- 8#:Recall after 160 seconds
- 9#:Recall after 180 seconds
- 10#:Recall after 200 seconds
- 11#:Recall after 220 seconds
- 12#:Recall after 240 seconds

FF1-3#-10#-(1 - 12)#

**Call reversion timer for attendant**

If an outside line call which has been put on hold by the attendant's phone is not answered by an extension other than the attendant's phone within the specified time, it is transferred to the attendant's phone and the extension's recall timer does not function. This function is not possible when the system is in the night mode.

- 0#:No Reversion call
- 1#:Reversion call after 20 seconds
- 2#:Reversion call after 40 seconds
- 3#:Reversion call after 60 seconds
- 4#:Reversion call after 80 seconds
- 5#:Reversion call after 100 seconds
- 6#:Reversion call after 120 seconds
- 7#:Reversion call after 140 seconds
- 8#:Reversion call after 160 seconds
- 9#:Reversion call after 180 seconds
- 10#:Reversion call after 200 seconds
- 11#:Reversion call after 220 seconds
- 12#:Reversion call after 240 seconds

FF1-3#-11#-(1 - 15)#

**Unsupervised conference monitor time (CO - CO conference monitoring timer)**

The time for which a call is enabled through an outside line when made from DISA or when conducted through outside lines only can be restricted within the range of 0 to 75 minutes. If the specified time is exceeded, the outside lines are automatically cut off.

- 0#:Disable
- 1#:Up to 5 min.
- 2#:Up to 10 min.
- 3#:Up to 15 min.
- 4#:Up to 20 min.
- 5#:Up to 25 min.
- 6#:Up to 30 min.
- 7#:Up to 35 min.
- 8#:Up to 40 min.
- 9#:Up to 45 min.
- 10#:Up to 50 min.
- 11#:Up to 55 min.
- 12#:Up to 60 min.
- 13#:Up to 65 min.
- 14#:Up to 70 min.
- 15#:Up to 75 min.

*Note: It is necessary to set for outside calls made from DISA and calls through outside lines only separately.*

FF1-3#-12#-(1 - 15)#

**Auto pause timer**

When PBX lines and WATT lines are accommodated as outside lines of the system and connected to the telephone central office, it is necessary to have a pause in the dialing until the dialing signal from the DBS is received and until the dial tone is sent out from the connected C.O. line. If this is neglected, the wrong party may be contacted or the connection may not be made. This pause time can be automatically set while dialing, and it is also possible to store a pause for stored dialing to SSD, PSD, etc. if necessary. Generally speaking it is sufficient to specify a standby time comprising one pause. But if an extremely long pause time is required, you can accommodate this by pressing the required number while storing the [REDIAL] key.

- 0#: No pause time
- 1#: One pause time of 0.5 seconds
- 2#: One pause time of 1.0 seconds
- 3#: One pause time of 1.5 seconds
- 4#: One pause time of 2.0 seconds
- 5#: One pause time of 2.5 seconds
- 6#: One pause time of 3.0 seconds
- 7#: One pause time of 3.5 seconds
- 8#: One pause time of 4.0 seconds
- 9#: One pause time of 4.5 seconds
- 10#: One pause time of 5.0 seconds
- 11#: One pause time of 5.0 seconds
- 12#: One pause time of 5.0 seconds
- 13#: One pause time of 5.0 seconds
- 14#: One pause time of 5.0 seconds
- 15#: One pause time of 5.0 seconds

*Note 1: The position at which the pause time is inserted while dialing is specified according to the system setting for each dial number.*

*Note 2: When [REDIAL] is stored for SSD and PSD, a pause for the set time only is inserted during the dialing. But even when it is not set, if there are specified dial numbers as in Note 1, a pause is automatically inserted.*

FF1-3#-13#-(0 - 10)#

**Outside line flash timer**

The time for which the outside line is temporarily released (flash time) when the [FLASH] key or [REDIAL] key has been pressed is set. The outside line is released while the [FLASH] key is pressed, even though this may be longer than the time set for it.

- 0#: No flash
- 1#: Minimum line flash time of 0.2 seconds
- 2#: Minimum line flash time of 0.3 seconds
- 3#: Minimum line flash time of 0.4 seconds
- 4#: Minimum line flash time of 0.5 seconds
- 5#: Minimum line flash time of 0.6 seconds
- 6#: Minimum line flash time of 0.7 seconds
- 7#: Minimum line flash time of 0.8 seconds
- 8#: Minimum line flash time of 0.9 seconds
- 9#: Minimum line flash time of 1.0 seconds
- 10#: Minimum line flash time of 1.1 seconds

*Note: This setting is not effective when operating from SLT.*

FF1-3#-14#-(0 - 6)#

**SLT on-hook detection timer**

It is specified as to whether the line flash is to function or the line is to be disconnected when the hook button is pressed lightly (referred to as the hooking operation) with SLT.

	No detect	Line flash	Disconnect
0#:	Less than 200	200 - 500 ms	Over 500 ms
1#:	Less than 200	200 - 750 ms	Over 750 ms
2#:	Less than 200	200 - 1000 ms	Over 1000 ms
3#:	Less than 200	200 - 1200 ms	Over 1200 ms
<u>4#:</u>	<u>Less than 200</u>	<u>200 - 1500 ms</u>	<u>Over 1500 ms</u>
5#:	Less than 200		Over 200 ms
6#:	Less than 200	30 - 140 ms	Over 500 ms

*HARD RESET  
TO CHANGE*

FF1-3#-15#-(0-3)#

**Outside incoming ring signal detection timer**

The auto answer function for incoming calls is set to function normally. The continuous time for the incoming call signal can be set within the range of 4 - 10 seconds. Even if the telephone has already been cut off by the party making it and the incoming call signal from the telephone line is discontinued, the system still treats it as an incoming call during the time set. This is because there are cases when there is a long cycle depending on the incoming call signal and in such cases the system deems that the incoming call has ended. So this is to prevent any error in the operation of the auto answer function and to ensure that the incoming call can be answered on the outside line from which it originates.

- 0#:Keep to 4 second of the ringing status
- 1#:Keep to 6 second of the ringing status
- 2#:Keep to 8 second of the ringing status
- 3#:Keep to 10 second of the ringing status

FF1-3#-16#-(0-15)#

**Incoming ring signal expand timer  
(First ring signal delay timer)**

An incoming ring tone is prepared for sending out to extensions in the system to synchronizing to the incoming call signal from outside lines. If the first incoming call signal from the outside line is too short when the incoming call tone sent out is set to synchronize with the incoming call signal, the time for which the call tone sounds is also short. Hence it is always possible to receive a regular incoming call tone without it being controlled by the length of time for the incoming call signal. In this case also the incoming call tone is synchronized with the incoming call signal from the outside line. The setting is for when using an answer phone for which an incoming call tone to the SLT terminal, etc. of a fixed length is necessary.

- 0#:Synchronizing to the incoming call signal
- 1#:Expand to 50ms
- 2#:Expand to 100ms
- 3#:Expand to 150ms
- 4#:Expand to 200ms
- 5#:Expand to 250ms
- 6#:Expand to 300ms
- 7#:Expand to 350ms
- 8#:Expand to 400ms
- 9#:Expand to 450ms
- 10#:Expand to 500ms
- 11#:Expand to 550ms
- 12#:Expand to 600ms
- 13#:Expand to 650ms
- 14#:Expand to 700ms
- 15#:Expand to 750ms



## FF1-3#-17#-(0-15)#

**Dial pause timer for after obtaining outside line**

The time to when sending out the number dialed starts after a connection with an outside line has been made is set.

For example, even if you start dialing immediately after pressing the line key, the dial signal is sent out to the outside line only after the specified time has elapsed.

This setting is for when there is a risk of the dialing tone from the switchboard of the connected C.O., etc. being delayed or of a wrong connection being made.

0#: 1.2 second after obtaining outside line

1#: 1.2 second after obtaining outside line

2#: 2 seconds after obtaining outside line

3#: 3 seconds after obtaining outside line

4#: 4 seconds after obtaining outside line

5#: 5 seconds after obtaining outside line

6#: 6 seconds after obtaining outside line

7#: 7 seconds after obtaining outside line

8#: 8 seconds after obtaining outside line

9#: 9 seconds after obtaining outside line

10#: 10 seconds after obtaining outside line

11#: 11 seconds after obtaining outside line

12#: 12 seconds after obtaining outside line

13#: 13 seconds after obtaining outside line

14#: 14 seconds after obtaining outside line

15#: 15 seconds after obtaining outside line

## FF1-3#-18#-(0-10)#

**PBX connecting line flash time**

The time (flash time) is set for temporarily releasing the outside line when the [FLASH] key or [REDIAL] key has been pressed upon using a PBX line for the outside line.

This is only effective when the outside line is set as the PBX line.

The outside line is released while the [FLASH] key is pressed, even though this may be longer than the time set for it.

The time can be set within in range of 0 - 1.1 seconds.

0#: No flash

1#: Minimum line flash time of 0.2 seconds

2#: Minimum line flash time of 0.3 seconds

3#: Minimum line flash time of 0.4 seconds

4#: Minimum line flash time of 0.5 seconds

5#: Minimum line flash time of 0.6 seconds

6#: Minimum line flash time of 0.7 seconds

7#: Minimum line flash time of 0.8 seconds

8#: Minimum line flash time of 0.9 seconds

9#: Minimum line flash time of 1.0 seconds

10#: Minimum line flash time of 1.1 seconds

(ATT.) ON/OFF CONF. # 6 (DISPLAY #) DBS  
FF-1 System mode

FF1-3#-19#-(0 - 15)#

**Call forward No answer timer**

If a call is not answered by an extension which has call forward no answer set within the specified time period, the call will be diverted to a predetermined extension. The call forward no answer timer can be set from 4 to 64 seconds.

- 0#: Call forward after 4 Seconds
- 1#: Call forward after 8 Seconds
- 2#: Call forward after 12 Seconds
- 3#: Call forward after 16 Seconds
- 4#: Call forward after 20 Seconds
- 5#: Call forward after 24 Seconds
- 6#: Call forward after 32 Seconds
- 7#: Call forward after 36 Seconds
- 8#: Call forward after 40 Seconds
- 9#: Call forward after 44 Seconds
- 10#: Call forward after 52 Seconds

**3-1-4 Remote Maintenance Code mode**

FF1 - 4#-(0000 - 9999)#

**Storing the ID for remote maintenance**

Remote controlled maintenance for the system can be done through a telephone circuit. An 4 digit code is stored for this purpose.

The system first automatically answers a call coming in on the exclusive DISA line.

Then, after the intercom dialing tone has been sent out by the system, the stored code is input and the remote maintenance starts.

For actually effecting the remote maintenance, in addition to this setting it is also necessary to store the DISA code.

For remote maintenance 3 of the following operations indicated are possible.

- A: Remote programming:  
Set remotely as with normal programming.
- B: Program data list out:  
The programmed data are checked when irregularities in the operation occur.
- C: System installation list:  
The terminals connected to the system together with the types and number of mounted cards are checked.

[CONF]#: Clear to DATA (Initial = 9999)

(0000 - 9999)#: Remote maintenance can be done according to stored code.

**Note:** To enable the use of the DISA function it is necessary to set the exclusive DISA line to an outside line port separately.

### 3 - 1 - 5 DISA ID Code mode

FF1-5#-(0000 - 9999)#

#### **DISA ID code storing (Direct Inward System Access)**

Use of the DISA function allows for DID (Direct in dialing) from outside the system and DISA outgoing call (making a call on a different line via the system from outside).

If this ID code is not set then system accept the DISA call without the input ID code. It also enables remote maintenance through a telephone circuit by the installer of the system.

For these operations it is necessary to input the exclusive DISA code followed by the remote maintenance code, DISA outgoing call code, etc.

[CONF]#: Clear data

(0000 - 9999)#: The DISA function can be used according to the stored code.

*Note: To enable the use of the DISA function it is necessary to set the exclusive DISA line to an outside line port separately.*

### 3 - 1 - 6 DISA Outgoing Call ID mode

FF1-6#-1#-(0000 - 9999)#

#### **DISA Outgoing call ID code 1 storing**

By inputting the stored code when DISA is operating, it is possible to make a call from a different line via the system from outside.

For using this function an code is stored.

[CONF]#: Clear to data (Initial = 1111).

(0000- 9999)#: To enable the use of the DISA function it is necessary to set the exclusive DISA line to an outside line port separately.

FF1-6#-2#-(0000 - 9999)#

#### **DISA Outgoing call ID code 2 storing**

By inputting the stored code when DISA is operating, it is possible to make a call from a different line via the system from outside. For using this function an code is stored.

[CONF]#: Clear to data (Initial = 9999).

(0000- 9999)#: To enable the use of the DISA function it is necessary to set the exclusive DISA line to an outside line port separately.

### 3 - 1 - 7 System program ID code mode

FF1-7#-(0000 - 9999)#

#### **System programming ID code storing**

Normally system programming is only possible from the attendant's phone.

But by inputting this code, the system can also be programmed from another extension.

The code is stored for the system. As the program is the most part of the system, always be sure to record it in the setting table (Section 450) and pay sufficient attention when dealing with the codes. The codes already set can be deleted with the [CONF] key.

[CONF]#: Clear to data (Initial = 9999).

(0000 9999)#: System can be programmed according to the stored code.

*Note: Another extension telephone can't program before the extension telephone which programmed cancel the programming mode.*

**3-2 Trunk mode**  
**(Outside line port specification)**

FF2-(1 - 32)#-1#-(0 or 1)#

i-32

**Trunk prohibition**

This is set for when an outside line port connected to the system has been damaged or for when it is desired to stop functioning to specific outside lines for some reason.

0#: Operate (Default)

1#: Stop Operation

FF2-(1 - 32)#-2#-(0 or 1)#

**Dialing signal type set for outside line**

Dialing is done by pressing the 10 keys. But it is also possible to specify whether it is to be pulse dialing or DTMF signal dialing for each outside line port in conformity with the specifications for the line connected to the ports.

0#: DTMF signal dial

1#: 10pps pulse dial

FF2-(1 - 32)#-3#-(0 or 1)#

**Pooled trunk access Group 9**

When using the function for obtaining an outside line automatically, a line belonging to the trunk group to be accessed is set. When 9 is dialed, connection is automatically made with a vacant line in the set group.

0#: Not subject to Pooled trunk access dial 9

1#: Accessible through Pooled trunk access dial 9

*Note : For using this function it is necessary to set for the pooled trunk access as opposed to the LCR call in the system program. Even with the LCR call set, however, if all the trunk lines for LCR calls are busy, it becomes an pooled trunk access.*

FF2-(1 - 32)#-4#-(0 or 1)#

**Pooled trunk access Group 81**

When using the function for obtaining an outside line automatically, a line belonging to the trunk group to be accessed is set. When 81 is dialed, connection is automatically made with a vacant line in the set group.

0#: Not subject to Pooled trunk access Group 81

1#: Accessible through Group 81

FF2-(1 - 32)#-5#-(0 or 1)#

**Pooled trunk access Group 82**

Same as group 81

0#: Not subject to Pooled trunk access Group 82

1#: Accessible through Group 82

FF2-(1 - 32)#-6#-(0 or 1)#

**Pooled trunk access Group 83**

Same as group 81

0#: Not subject to Pooled trunk access Group 83

1#: Accessible through Group 83

FF2-(1 - 32)#-7#-(0 or 1)#

**Pooled trunk access Group 84**

Same as group 81

0#: Not subject to Pooled trunk access Group 84

1#: Accessible through Group 84

FF2-(1 - 32)#-8#-(0 or 1)#

**Pooled trunk access Group 85**

Same as group 81

0#: Not subject to Pooled trunk access Group 85

1#: Accessible through Group 85

FF2-(1 - 32)#-9#-(0 or 1)#

**Pooled trunk access Group 86**

Same as group 81

0#: Not subject to Pooled trunk access Group 86

1#: Accessible through Group 86

FF2-(1 - 32)#- 10#-(0 or 1)#

(1 or 2)

**Connected phone line type setting**

As the dialing decision for TRS and the like is affected if the system is connected to a PBX, either a PBX line or a C.O. line is set for each trunk port.

1#: C.O. line

2#: PBX line (Need to access number to CO line)

FF2-(1 - 32)#-11#-(0 or 1)#

**DISA line setting  
(Automatic DISA answer)**

This setting is each trunk port to receive incoming calls using the DISA function. However you may need to set DISA start and end times to each trunk.

0#: Does not answer DISA incoming calls

1#: Answers DISA incoming calls and also accommodates outgoing calls from DISA

FF2-(1 - 32)#-12#-(01 - 72)#

**Private line setting (Private outside line)**

Each extension can have an exclusive private line which can be set when programming.

An incoming call from a trunk line set for private use rings on the extension to which that line belongs only.

While there can be a number of private lines belonging to one telephone, a single private line cannot belong in common to a number of telephones.

Once set, other extensions can not make calls to or receive calls from that trunk port number, and even if the private trunk line setting is canceled it is not make calls or receive calls automatically. In this case set TRS and RING separately.

[CONF]#: No private line

(01 - 72)#: Private line for set extension port

FF2-(1 - 32)#-13#-(0 - 1)#

**Auto pause function setting for PBX line**

It is set whether or not a auto pause for each dialing done with the system setting is necessary or not.

0#: Auto pause for each dialing not necessary

1#: Auto pause function for each dialing

FF2-(1 - 32)#-14#-(0 or 1)#

**Dialing tone detection setting**

It is set whether or not the dialing tone is to be detected when making an outside call.

If it is set, the number dialed is not transmitted to the out- side line until the dialing tone has been detected.

If it is not set, the number dialing is out in accordance with the setting for the system timer.

0#:Need the dialing tone for the dial out

1#:No dial tone detection (Free dial)

FF2-(1 - 32)#- 15#-(1 - 3)#

**DTMF dial signal sending time**

The length of time for sending the signal is changed in cases where a DTMF dialing signal is sent to an outside line, and where the sending time for the DTMF signal is short and it does not operate when receiving the MCI or SPRINT line or various services.

1#: 75ms ON / 50ms OFF

2#: 125ms ON / 125ms OFF

3#: 250ms ON / 250ms OFF

FF2-(1 - 32)#-16#-(0 or 1)#

### Call Diversion

(Trunk to trunk connection trunk setting)

It is set whether or not an outside line can make a trunk to trunk connection.

This function can be used at an extension where trunk to trunk connection has been set in the extension mode.

In addition, if the time set with the call monitoring timer is exceeded, the call is automatically cut off.

0#: Trunk to trunk connection not possible

1#: Trunk to trunk connection possible

FF2-(1 - 32)#-17#-(0 - 9)#

### Incoming ring signal pattern setting

The ring tone pattern for incoming calls can be changed for each trunk port.

If outside lines are assigned for use to each individual, they will know who the call is for by the ring tone pattern and this will facilitate answering.

0#: Incoming ring tone synchronized

1#: 3 sec ON / 1 sec OFF

2#: 2 sec ON / 2 sec OFF

3#: 1 sec ON / 1 sec OFF

4#: 1 sec ON / 2 sec OFF

5#: 1 sec ON / 3 sec OFF

6#: 0.5 sec ON / 0.5 sec OFF

> 7#: 0.5 sec ON / 0.5 sec OFF

and 0.5sec ON / 2.5 sec OFF

8#: 0.5 sec ON / 3.5 sec OFF

9#: 1 sec ON / 7 sec OFF

FF2-(1 - 32)#-18#-(1 - 15)#

### Outside line disconnect signal detection timer

If the signal indicating that an outside line has been disconnected during a outside call or while it is on hold is received, or if the outside line has been cut off, the system automatically cancels the outside line call. However, as the call ends automatically when the outside line is instantly cut due to the conditions for the connected PBX, it is accommodated by this setting.

The time from when it is determined that the call has been disconnected or that it has been disabled to when the outside line call status is automatically canceled can be set within the range of 50 - 750ms.

0#: No detection (Keep the connection)

1#: Disconnection by the more than 50ms signal

2#: Disconnection by the more than 100ms signal

3#: Disconnection by the more than 150ms signal

4#: Disconnection by the more than 200ms signal

5#: Disconnection by the more than 250ms signal

6#: Disconnection by the more than 300ms signal

7#: Disconnection by the more than 350ms signal

8#: Disconnection by the more than 400ms signal

9#: Disconnection by the more than 450ms signal

10#: Disconnection by the more than 500ms signal

11#: Disconnection by the more than 550ms signal

12#: Disconnection by the more than 600ms signal

13#: Disconnection by the more than 650ms signal

14#: Disconnection by the more than 700ms signal

15#: Disconnection by the more than 750ms signal

FF2-(1 - 32)#-19#-(Hour - Minute)#

**DISA start time setting**

A CO line can be assigned as a DISA (direct inward system access) line for a specific period of time. When the outside line is not activated by this timer as a DISA line it can be used as a normal outside line. This timer specifies the starting time for DISA. The time entered is in 24 hour format with no spaces between hour and minute.

[CONF]#: No starting time (DATA reset)  
HHMM#:(00-23,00-59) Enter the time

FF2-(1 - 32)#-20#-(0 or 1)#

**DISA end time setting**

This timer specifies the ending time for DISA. A normal CO line can be assigned as a DISA (direct inward system access) line for a specific period of time. When the outside line is not activated as a DISA line it can be used as a normal outside line. The time entered is in 24 hour format with no spaces between hour and minute.

[CONF]#: No end time (DATA reset)  
HHMM#:(00-23,00-59) Enter the time

**3 - 3 Extension mode**

General operating specifications are set for the extensions, and these specifications are set for each port number in the main cabinet with regard to each extension.

*Stn. Port.*  
 FF3-(1-72)#-1#-(100-699)#

**Extension number**

Extension numbers are stored for the extension ports.

The extension numbers set in the system program are stored separately according to the number of digits (2 or 3 digits).

If there are more than 60 extension units connected to the system, it is necessary to have extension numbers with 3 digits. But if EM/24 and DSS units are included among those connected, it is not necessary to store extension numbers for them.

If alternate attendant mode is set, the extension numbers 100 (or 10) is attendant phone 1 and 101 (or 11) is attendant phone 2. If they have not been specially stored, the system automatically stores extensions 100, 101 and 102 from extension port number 1.

[CONF]: DATA reset  
 (100-699)#: 100 to 699 (if 2 digits: 10 to 69)

FF3-(1-72)#-2#-(1-14)#

**Terminal type**

The types of terminal (telephones, etc.) connected to the extension ports are stored. When the power source for the system is turned on after installation, except for OPX and DSS/72 terminals connected to the system are already automatically set and OPX and DSS/72 terminals connected to the system need initial setting.

DSS1, DSS2 for 1st attendant and DSS3, DSS4 for 2nd attendant.

1#:	Analog tone telephone (2500type)	Auto set
2#:	6 FF key digital key telephone	Auto set
3#:	12 FF key digital key telephone	Auto set
4#:	24 FF key digital key telephone	Auto set
5#:	Reserved	
6#:	Reserved	
7#:	EM/24 VB-43310	Auto set
8#:	OPX (Pulse dial detection)	Manual set
9#:	OPX (Tone dial detection)	Manual set
10#:	Voice mail (with AEC)	Manual set
11#:	DSS1 for ext. # 100 or 10	Manual set
12#:	DSS2 for ext. # 100 or 10	Manual set
13#:	DSS3 for ext. # 101 or 11	Manual set
14#:	DSS4 for ext. # 101 or 11	Manual set
15#:	Voice mail (with OPX) (16 to 20 is Reserved)	Manual set
21#:	ACD / PC (21 to 28 is ACD / PC)	
28#:	ACD / PC	
29#:	Reserved	
30#:	Reserved	
31#:	A.A. / PC (16 to 20 is A.A. / PC)	
28#:	A.A. / PC	

Note : As regards DSS/72 and EM/24, after they have been stored, it is necessary either to turn the system power off and then turn it on again, or to disconnect the module jacks for DSS, EM24 and then insert them once more.



FF3-(1-72)#-3#-(01-72)#

**EM/24 user port number**

Extension ports are stored for operating extensions connected to them and for the connected EM/24 console and stored.

[CONF]#: EM/24 not connected

(01-72)#: Operates as EM/24 for stored extension

*Note:* As regards EM/24, after they have been stored, it is necessary either to turn the system power off and then turn it on again, or to disconnect the module jacks for EM/24 and then insert them once more.

FF3-(1-72)#-4#-(0 or 1)#

**Forced Least Cost Routing restriction**

This setting is for specifying that outside calls made from extensions must be through LCR. The setting is such that, while managers and the like can use another line when the LCR line is busy, other staff members must use LCR for making calls at all times. When LCR calls are made from set extensions by dialing 9, it is possible to restrict them.

0#: Outside calls need not be made by LCR

1#: Outside calls must be made by LCR

FF3-(1-72)#-5#-(0 or 1)#

**Account code TRS setting**

This setting is so that outside calls cannot be made from the extensions programmed for this if the account code is not entered.

0#: No account code TRS function

1#: Order to ID code for making outside line call

FF3-(1-72)#-6#-(0001-9999)#

**Station lockout key code storing**

If you do not want other people to make outside calls from your extension when you leave at your extension, this function can be prevented.

A key code is stored for each extension, and this key code is input to cancel the station lockout function upon returning to one's desk.

Key codes can be stored within the range of 0000 - 9999 and deleted by inputting [CONF].

[CONF]#: No station lockout function

(0000-9999)#: Storing station lockout key code

FF3-(1-72)#-7#-(0 or 1)#

**Off-hook signal setting**

It is stored for each extension whether a signal indicating an incoming call on an outside line is to be sent while the extension is busy. Even if set for this, however, this signal will not be sent during a conference call, while the extension is on hold, or during a call on an outside line for which there is no Line key on the telephone.

**Extension Port 1, 2 (Attendant tel)**

0#: No incoming ring when phone is busy

1#: Have the incoming ring when phone is busy

**Another port**

0#: No incoming ring when phone is busy

1#: Have the incoming ring when phone is busy

*Note 1.:* For the incoming call signal, the off-hook signal volume and off-hook signaling pattern are set separately.



*Note 2.:* When off-hook signal setting is done, hunting function is not available.

FF3-(1 - 72)#-8#-(0 or 1)#

**Call waiting accept setting**

When a call is received from another extension while the extension is busy, the busy tone is sent to the former.

However, this sets whether call waiting is to be accepted or not when the [3] key has been input again and call waiting effected. If set for accepting, the incoming call signal is sent from the extension. But call waiting cannot be accepted by an extension which is set for absence, on hold, receiving a call or involved in a conference call.

- 0#: Not accepting call waiting
- 1#: Accepting call waiting

FF3-(1 - 72)#-9#-(0 or 1)#

**Busy override call possibility setting**

This sets for each extension whether busy override is possible while it is in use.

Note that busy override is not possible when an extension is set for rejecting it or by an extension involved in a conference call.

- 0#: Busy override call impossible
- 1#: Busy override call possible

FF3-(1 - 72)#-10#-(0 or 1)#

**Busy override rejection setting**

(Busy overridden)

This sets to accept busy override from another extension or to reject it.

- 0#: Busy override call rejected
- 1#: Busy override call accepted

*Note : It is possible to have the setting so that the signal will sound during busy override to indicate another busy override call.*

*FOR CONF.  
SET FOR TALK  
CONFERENCE  
DURING  
CONFERENCE*

FF3-(1 - 72)#-11#-(0 or 1)#

**Prime line pick-up setting**

It is possible to have a setting for when making an outside call to automatically pick up an outside line stored in the FF1 key simply by lifting the handset. However, this function will not operate if the outside line has not been stored in the FF1 key. If Polled trunk access function has been set in the FF1 key, an available line is automatically accessed by moving down in order from the extension port with the largest number. As intercom calls cannot be made with this setting however, "#8" [intercom call key] should be stored in another FF key beforehand.

- 0#: No prime line function
- 1#: To pick up prime line

FF3-(1 - 72)#-12#-(0 or 1)#

**Automatic incoming ring trunk pickup**

By simply lifting the handset, the first of a number of incoming trunk calls made is selected and answered.

The setting can also be such that hold recall and transferred calls can also be answered simply by lifting the handset.

- 0#: No automatic selection to ringing trunk
- 1#: Automatically select the ringing trunk

FF3-(1 - 72)#-13#-(0 or 1)#

**Trunk to trunk connection**

(Make no attended conference)

This specifies whether to allow for a trunk to trunk connection between the two parties on outside lines during a three - party conference call by pressing the line key for either of the outside lines.

- 0#: Trunk to trunk connection not possible
- 1#: Trunk to trunk connection possible

*Note: This function should be set to enable trunk to trunk connection on outside lines beforehand.*

*WHICH  
DTR.*

FF3-(1 - 72)#-14#-(0 or 1)#

### SMDR printout setting

This sets whether information from outside calls is to be printed out by the SMDR (Station Message Dial Recorder) printer.

- OUTGOING  
0#: Incoming call is not printed out  
OUTGOING  
1#: Incoming call is printed out

*Note: For SMDR printing it is necessary to set the protocol between the system and SMDR and the control data beforehand.*

FF3-(1 - 72)#-15#-(0 or 4)#

### Off-hook signal volume

The off-hook signal can be set at 4 types.

- 1#: Off-hook signal volume minimum  
2#: Off-hook signal volume lower medium  
3#: Off-hook signal volume higher medium  
4#: Off-hook signal volume maximum

FF3-(1 - 72)#-16#-(0 or 1)#

### Off-hook signal pattern

The off-hook signal pattern is set.

- 0#: Continuity  
1#: Incoming call signal is sent out once only

FF3-(1 - 72)#-17#-(0 or 1)#

### Personal speed dial display mode

This specifies the quantity of names displayed on the Large display phone. The option is for 5 names or 10 names the maximum length displayed will be 7 characters.

- 0#: Display 5 names (1 line have 1 names)  
1#: Display 10 names (1 line have 2 names)

FF3-(1 - 72)#-18#-(0 or 1)#

### Paging group 00 affiliation

This sets to paging group 00 or not.

- 0#: Does not belong to paging group 00  
1#: Belongs to paging group 00

FF3-(1 - 72)#-19#-(0 or 1)#

### Paging group 01 affiliation

This sets to paging group 01 or not.

- 0#: Does not belong to paging group 01  
1#: Belongs to paging group 01

FF3-(1 - 72)#-20#-(0 or 1)#

### Paging group 02 affiliation

This sets to paging group 02 or not.

- 0#: Does not belong to paging group 02  
1#: Belongs to paging group 02

FF3-(1 - 72)#-21#-(0 or 1)#

### Paging group 03 affiliation

This sets to paging group 03 or not.

- 0#: Does not belong to paging group 03  
1#: Belongs to paging group 03

FF3-(1 - 72)#-22#-(0 or 1)#

### Paging group 04 affiliation

This sets to paging group 04 or not.

- 0#: Does not belong to paging group 04  
1#: Belongs to paging group 04

FF3-(1 - 72)#-23#-(0 or 1)#

### Paging group 05 affiliation

This sets to paging group 05 or not.

- 0#: Does not belong to paging group 05  
1#: Belongs to paging group 05

FF3-(1 - 72)#-24#-(0 or 1)#

### Paging group 06 affiliation

This sets to paging group 06 or not.

- 0#: Does not belong to paging group 06  
1#: Belongs to paging group 06

FF3-(1 - 72)#-25#-(0 or 1)#

### Paging group 07 affiliation

This sets to paging group 07 or not.

- 0#: Does not belong to paging group 07  
1#: Belongs to paging group 07

## FF3-(1-72)#-26#-(0-13)#

**Large LCD information condition on the idle status (Idol)**

The contents are set for display on a large LCD when the extension is in the idle (On hook) status.

0#: No change

1#: Change to menu information

2#: Change to personal speed dial index

3#: Change to system speed dial index

4#: Change to extension index

5#: Change to guidance menu 1

(ABSES, AC-CODE, LKOUT, REMDR, FF-Key)

6#: Change to guidance menu 2

(PSD, CFWD/All call/No ans/On busy/Out side)

7#: Change to guidance menu 3

(PGM, PKHLD, DND, SVDI, BGM)

8#: Change to guidance menu 4 (Attendant only)

(Timer set, Timer adjust,  
Attendant cancel, Day / Night)

9#: Change to guidance menu 5 (Attendant only)

(SSD name number, EXT name number  
Maintenance code, Key code, DISA code)

10#: Change to guidance menu 6 (Attendant only)

(Program mode, Outgoing amount  
Incoming amount, Use SSD amount)

11#: Change to function 1

(BGM, DND, REMDR, ABSES, CFWD, MUTE,  
LKOUT, MAIL, BROD, ABS-CSL)

12#: Change to function 2

(DT, HS, MSGE-CSL, MSGE-CSL, CONF)

13#: Change to function 3

(PGANS, Page-Z/1/2/3/4/5/6/7, All Zone)

14#: Change to function 4

(CONF, TONE, Set MSG, TRFR, RLSE)

15#: Change to function 5

(SADI, REDI, DTMFCV, RLSE, AC-CODE, MUTE)

16#: Change to function 6

(C-WATNG, MSGE, CO-QNG, OVRDE, RLSE)

17#: Change to function 7

(AC-CODE, LCR, TRK-G/81/82/83/84/85/86)

18#: Change to function 8

(UNA-PUP/Group/Direct/Page)

19#: Change to function 9

(MCO, LCR, PSD, SSD, EXT, MUTE, PAGE, TONE)

20#: Change to function 10

(MSGE, TRFR, RLSE, CONF, MUTE, DND, TONE,  
PKHLD)

21#: Change to function 11

(REDI, DTMFCV,  
AC-CODE, SSD, PSD, RLSE, MUTE, EXT)

22#: Change to function 12

(SADI, PSD, SSD, CONF,  
AC-CODE, MUTE, RLSE, TRFR, REMDR)

23#: Change to function 13

(PGANS, HS, TONE, MUTE, UNA, EXT, PSD, SSD)

24#: Change to function 14

(TAKBK, RLSE, CONF, TRFR, DND, PKHLD)

FF3-(1 - 72)#-27#- (0 - 13)#

**Large LCD information on the intercom dial tone status (IDT)**

The contents are set for display on a large LCD when the extension is involved in an intercom dial tone (off hook) status.

0#: No change

1#: Change to menu information

2#: Change to personal speed dial index

3#: Change to system speed dial index

4#: Change to extension index

5#: Change to guidance menu 1  
(ABSES, AC-CODE, LKOUT, REMDR, FF-Key)

6#: Change to guidance menu 2  
(PSD, CFWD/All call/No ans/On busy/Out side)

7#: Change to guidance menu 3  
(PGM, PKHLD, DND, SVDI, BGM)

8#: Change to guidance menu 4 (Attendant only)  
(Timer set, Timer adjust,  
Attendant cancel, Day / Night)

9#: Change to guidance menu 5 (Attendant only)  
(SSD name number, EXT name number  
Maintenance code, Key code, DISA code)

10#: Change to guidance menu 6 (Attendant only)  
(Program mode, Outgoing amount  
Incoming amount, Use SSD amount)

11#: Change to function 1  
(BGM, DND, REMDR, ABSES, CFWD, MUTE,  
LKOUT, MAIL, BROD, ABS-CSL)

12#: Change to function 2  
(DT, HS, MSGE-CSL, MSGE-CSL, CONF)

13#: Change to function 3  
(PGANS, Page-Z/1/2/3/4/5/6/7, All Zone)

14#: Change to function 4  
(CONF, TONE, Set MSG, TRFR, RLSE)

15#: Change to function 5  
(SADI, REDI, DTMFCV, RLSE, AC-CODE, MUTE)

16#: Change to function 6  
(C-WATNG, MSGE, CO-QNG, OVRDE, RLSE)

17#: Change to function 7  
(AC-CODE, LCR, TRK-G/81/82/83/84/85/86)

18#: Change to function 8  
(UNA-PUP /Group/Direct/Page)

19#: Change to function 9  
(MCO, LCR, PSD, SSD, EXT, MUTE, PAGE, TONE)

20#: Change to function 10  
(MSGE, TRFR, RLSE, CONF, MUTE, DND, TONE,  
PKHLD)

21#: Change to function 11  
(REDI, DTMFCV,  
AC-CODE, SSD, PSD, RLSE, MUTE, EXT)

22#: Change to function 12  
(SADI, PSD, SSD, CONF,  
AC-CODE, MUTE, RLSE, TRFR, REMDR)

23#: Change to function 13  
(PGANS, HS, TONE, MUTE, UNA, EXT, PSD, SSD)

24#: Change to function 14  
(TAKBK, RLSE, CONF, TRFR, DND, PKHLD)

FF3-(1 - 72)#-28#-(0 - 13)#

**Large LCD information on the intercom  
call status (INT Talk)**

The contents are set for display on a large LCD  
when the extension is involved in an intercom call  
(Calling,Receiving call,On the  
conversation,Making the call waiting) status.

0#: No change

- 1#: Change to menu information
- 2#: Change to personal speed dial index
- 3#: Change to system speed dial index
- 4#: Change to extension index
- 5#: Change to guidance menu 1  
(ABSES, AC-CODE,LKOUT,REMDR,FF-Key)
- 6#: Change to guidance menu 2  
(PSD,CFWD/All call/No ans/On busy/Out side)
- 7#: Change to guidance menu 3  
(PGM,PKHLD,DND,SVDI,BGM)
- 8#: Change to guidance menu 4 (Attendant only)  
(Timer set,Timer adjust,  
Attendant cancel,Day / Night)
- 9#: Change to guidance menu 5 (Attendant only)  
(SSD name number,EXT name number  
Maintenance code,Key code,DISA code)
- 10#: Change to guidance menu 6 (Attendant only)  
(Program mode,Outgoing amount  
Incoming amount,Use SSD amount)

- 11#: Change to function 1  
(BGM,DND, REMDR,ABSES,CFWD,MUTE,  
LKOUT,MAIL,BROD,ABS-CSL)
- 12#: Change to function 2  
(DT,HS, MSGE-CSL,MSGE-CSL, CONF)
- 13#: Change to function 3  
(PGANS,Page-Z/1/2/3/4/5/6/7, All Zone)
- 14#: Change to function 4  
(CONF,TONE,Set MSG,TRFR,RLSE,MUTE)
- 15#: Change to function 5  
(SADI/REDI/DTMFVCV/RLSE,AC-CODE,MUTE)
- 16#: Change to function 6  
(C-WATNG,MSGE,CO-QNG,OVRDE,RLSE)
- 17#: Change to function 7  
(AC-CODE,LCR,TRK-G/81/82/83/84/85/86)
- 18#: Change to function 8  
(UNA-PUP/Group/Direct/Page)
- 19#: Change to function 9  
(MCO, LCR, PSD, SSD, EXT,MUTE,PAGE,TONE)
- 20#: Change to function 10  
(MSGE,TRFR,RLSE,CONF,MUTE,DND,TONE,  
PKHLD)
- 21#: Change to function 11  
(REDI,DTMFVCV,  
AC-CODE,SSD,PSD,RLSE,MUTE,EXT)
- 22#: Change to function 12  
(SADI,PSD,SSD,CONF,  
AC-CODE,MUTE,RLSE,TRFR,REMDR)
- 23#: Change to function 13  
(PGANS,HS,TONE,MUTE,UNA,EXT,PSD,SSD)
- 24#: Change to function 14  
(TAKBK,RLSE,CONF,TRFR,DND,PKHLD)

FF3-(1 - 72)#- 29#-(0 - 13)#

**Large LCD information on the outside line conversation (In dialing) status**

The contents are set for display on a large LCD when the extension is get the outside line.

0#: No change

1#: Change to menu information

2#: Change to personal speed dial index

3#: Change to system speed dial index

4#: Change to extension index

5#: Change to guidance menu 1

(ABSES, AC-CODE, LKOUT, REMDR, FF-Key)

6#: Change to guidance menu 2

(PSD, CFWD/All call/No ans/On busy/Out side)

7#: Change to guidance menu 3

(PGM, PKHLD, DND, SVDI, BGM)

8#: Change to guidance menu 4 (Attendant only)

(Timer set, Timer adjust,  
Attendant cancel, Day / Night)

9#: Change to guidance menu 5 (Attendant only)

(SSD name number, EXT name number  
Maintenance code, Key code, DISA code)

10#: Change to guidance menu 6 (Attendant only)

(Program mode, Outgoing amount  
Incoming amount, Use SSD amount)

11#: Change to function 1

(BGM, DND, REMDR, ABSES, CFWD, MUTE,  
LKOUT, MAIL, BROD, ABS-CSL)

12#: Change to function 2

(DT, HS, MSGE-CSL, MSGE-CSL, CONF)

13#: Change to function 3

(PGANS, Page-Z/1/2/3/4/5/6/7, All Zone)

14#: Change to function 4

(CONF, TONE, Set MSG, TRFR, RLSE, MUTE)

15#: Change to function 5

(SADI/REDI/DTMFVCV/RLSE, AC-CODE, MUTE)

16#: Change to function 6

(C-WATNG, MSGE, CO-QNG, OVRDE, RLSE)

17#: Change to function 7

(AC-CODE, LCR, TRK-G/81/82/83/84/85/86)

18#: Change to function 8

(UNA-PUP/Group/Direct/Page)

19#: Change to function 9

(MCO, LCR, PSD, SSD, EXT, MUTE, PAGE, TONE)

20#: Change to function 10

(MSGE, TRFR, RLSE, CONF, MUTE, DND, TONE,  
PKHLD)

21#: Change to function 11

(REDI, DTMFVCV,  
AC-CODE, SSD, PSD, RLSE, MUTE, EXT)

22#: Change to function 12

(SADI, PSD, SSD, CONF,  
AC-CODE, MUTE, RLSE, TRFR, REMDR)

23#: Change to function 13

(PGANS, HS, TONE, MUTE, UNA, EXT, PSD, SSD)

24#: Change to function 14

(TAKBK, RLSE, CONF, TRFR, DND, PKHLD)

FF3-(1 - 72)#- 30#-(0 - 13)#

**Large LCD information on the outside line conversation (After dialing) status**

The contents are set for display on a large LCD when the extension started the outside line conversation.

**0#: No change**

1#: Change to menu information

2#: Change to personal speed dial index

3#: Change to system speed dial index

4#: Change to extension index

5#: Change to guidance menu 1

(ABSES, AC-CODE, LKOUT, REMDR, FF-Key)

6#: Change to guidance menu 2

(PSD, CFWD/All call/No ans/On busy/Out side)

7#: Change to guidance menu 3

(PGM, PKHLD, DND, SVDI, BGM)

8#: Change to guidance menu 4 (Attendant only)

(Timer set, Timer adjust,  
Attendant cancel, Day / Night)

9#: Change to guidance menu 5 (Attendant only)

(SSD name number, EXT name number  
Maintenance code, Key code, DISA code)

10#: Change to guidance menu 6 (Attendant only)

(Program mode, Outgoing amount  
Incoming amount, Use SSD amount)

11#: Change to function 1

(BGM, DND, REMDR, ABSES, CFWD, MUTE,  
LKOUT, MAIL, BROD, ABS-CSL)

12#: Change to function 2

(DT, HS, MSGE-CSL, MSGE-CSL, CONF)

13#: Change to function 3

(PGANS, Page-Z/1/2/3/4/5/6/7, All Zone)

14#: Change to function 4

(CONF, TONE, Set MSG, TRFR, RLSE, MUTE)

15#: Change to function 5

(SADI/REDI/DTMFCV/RLSE, AC-CODE, MUTE)

16#: Change to function 6

(C-WATNG, MSGE, CO-QNG, OVRDE, RLSE)

17#: Change to function 7

(AC-CODE, LCR, TRK-G/81/82/83/84/85/86)

18#: Change to function 8

(UNA-PUP./Group/Direct/Page)

19#: Change to function 9

(MCO, LCR, PSD, SSD, EXT, MUTE, PAGE, TONE)

20#: Change to function 10

(MSGE, TRFR, RLSE, CONF, MUTE, DND, TONE,  
PKHLD)

21#: Change to function 11

(REDI, DTMFCV,  
AC-CODE, SSD, PSD, RLSE, MUTE, EXT)

22#: Change to function 12

(SADI, PSD, SSD, CONF,  
AC-CODE, MUTE, RLSE, TRFR, REMDR)

23#: Change to function 13

(PGANS, HS, TONE, MUTE, UNA, EXT, PSD, SSD)

24#: Change to function 14

(TAKBK, RLSE, CONF, TRFR, DND, PKHLD)



FF3-(1 - 72)#-31#-(0 - 13)#

**Large LCD information on the receiving  
page call status**

The contents are set for display on a large LCD  
when the extension is receiving the page call.

0#: No change

1#: Change to menu information

2#: Change to personal speed dial index

3#: Change to system speed dial index

4#: Change to extension index

5#: Change to guidance menu 1  
(ABSES, AC-CODE, LKOUT, REMDR, FF-Key)

6#: Change to guidance menu 2  
(PSD, CFWD/All call/No ans/On busy/Out side)

7#: Change to guidance menu 3  
(PGM, PKHLD, DND, SVDI, BGM)

8#: Change to guidance menu 4 (Attendant only)  
(Timer set, Timer adjust,  
Attendant cancel, Day / Night)

9#: Change to guidance menu 5 (Attendant only)  
(SSD name number, EXT name number  
Maintenance code, Key code, DISA code)

10#: Change to guidance menu 6 (Attendant only)  
(Program mode, Outgoing amount  
Incoming amount, Use SSD amount)

11#: Change to function 1  
(BGM, DND, REMDR, ABSES, CFWD, MUTE,  
LKOUT, MAIL, BROD, ABS-CSL)

12#: Change to function 2  
(DT, HS, MSGE-CSL, MSGE-CSL, CONF)

13#: Change to function 3  
(PGANS, Page-Z/1/2/3/4/5/6/7, All Zone)

14#: Change to function 4  
(CONF, TONE, Set MSG, TRFR, RLSE, MUTE)

15#: Change to function 5  
(SADI, REDI, DTMFCV, RLSE, AC-CODE, MUTE)

16#: Change to function 6  
(C-WATNG, MSGE, CO-QNG, OVRDE, RLSE)

17#: Change to function 7  
(AC-CODE, LCR, TRK-G/81/82/83/84/85/86)

18#: Change to function 8  
(UNA-PUP, Group/Direct/Page)

19#: Change to function 9  
(MCO, LCR, PSD, SSD, EXT, MUTE, PAGE, TONE)

20#: Change to function 10  
(MSGE, TRFR, RLSE, CONF, MUTE, DND, TONE,  
PKHLD)

21#: Change to function 11  
(REDI, DTMFCV,  
AC-CODE, SSD, PSD, RLSE, MUTE, EXT)

22#: Change to function 12  
(SADI, PSD, SSD, CONF,  
AC-CODE, MUTE, RLSE, TRFR, REMDR)

23#: Change to function 13  
(PGANS, HS, TONE, MUTE, UNA, EXT, PSD, SSD)

24#: Change to function 14  
(TAKBK, RLSE, CONF, TRFR, DND, PKHLD)

## FF3-(1 - 72)#- 32#-(0 - 13)#

**Large LCD information on the receiving call wait status**

The contents are set for display on a large LCD when the extension is receiving the call waiting.

**0#:** No change

**1#:** Change to menu information

**2#:** Change to personal speed dial index

**3#:** Change to system speed dial index

**4#:** Change to extension index

**5#:** Change to guidance menu 1

(ABSES, AC-CODE, LKOUT, REMDR, FF-Key)

**6#:** Change to guidance menu 2

(PSD, CFWD/All call/No ans/On busy/Out side)

**7#:** Change to guidance menu 3

(PGM, PKHLD, DND, SVDI, BGM)

**8#:** Change to guidance menu 4 (Attendant only)

(Timer set, Timer adjust,  
Attendant cancel, Day / Night)

**9#:** Change to guidance menu 5 (Attendant only)

(SSD name number, EXT name number  
Maintenance code, Key code, DISA code)

**10#:** Change to guidance menu 6 (Attendant only)

(Program mode, Outgoing amount  
Incoming amount, Use SSD amount)

**11#:** Change to function 1

(BGM, DND, REMDR, ABSES, CFWD, MUTE,  
LKOUT, MAIL, BROD, ABS-CSL)

**12#:** Change to function 2

(DT, HS, MSGE-CSL, MSGE-CSL, CONF)

**13#:** Change to function 3

(PGANS, Page-Z/1/2/3/4/5/6/7, All Zone)

**14#:** Change to function 4

(CONF, TONE, Set MSG, TRFR, RLSE, MUTE)

**15#:** Change to function 5

(SADI/REDI/DTMFVCV/RLSE, AC-CODE, MUTE)

**16#:** Change to function 6

(C-WATNG, MSGE, CO-QNG, OVRDE, RLSE)

**17#:** Change to function 7

(AC-CODE, LCR, TRK-G/81/82/83/84/85/86)

**18#:** Change to function 8

(UNA-PUP/Group/Direct/Page)

**19#:** Change to function 9

(MCO, LCR, PSD, SSD, EXT, MUTE, PAGE, TONE)

**20#:** Change to function 10

(MSGE, TRFR, RLSE, CONF, MUTE, DND, TONE,  
PKHLD)

**21#:** Change to function 11

(REDI, DTMFCV,  
AC-CODE, SSD, PSD, RLSE, MUTE, EXT)

**22#:** Change to function 12

(SADI, PSD, SSD, CONF,  
AC-CODE, MUTE, RLSE, TRFR, REMDR)

**23#:** Change to function 13

(PGANS, HS, TONE, MUTE, UNA, EXT, PSD, SSD)

**24#:** Change to function 14

(TAKBK, RLSE, CONF, TRFR, DND, PKHLD)

FF3-(1 - 72)#- 33#-(0 - 13)#

**Large LCD information on the busy tone receiving status**

The contents are set for display on a large LCD when the extension is receiving the intercom busy tone.

**0#:** No change**1#:** Change to menu information**2#:** Change to personal speed dial index**3#:** Change to system speed dial index**4#:** Change to extension index**5#:** Change to guidance menu 1  
(ABSES, AC-CODE, LKOUT, REMDR, FF-Key)**6#:** Change to guidance menu 2  
(PSD, CFWD/All call/No ans/On busy/Out side)**7#:** Change to guidance menu 3  
(PGM, PKHLD, DND, SVDI, BGM)**8#:** Change to guidance menu 4 (Attendant only)  
(Timer set, Timer adjust,  
Attendant cancel, Day / Night)**9#:** Change to guidance menu 5 (Attendant only)  
(SSD name number, EXT name number  
Maintenance code, Key code, DISA code)**10#:** Change to guidance menu 6 (Attendant only)  
(Program mode, Outgoing amount  
Incoming amount, Use SSD amount)**11#:** Change to function 1  
(BGM, DND, REMDR, ABSES, CFWD, MUTE,  
LKOUT, MAIL, BROD, ABS-CSL)**12#:** Change to function 2  
(DT, HS, MSGE-CSL, MSGE-CSL, CONF)**13#:** Change to function 3  
(PGANS, Page-Z/1/2/3/4/5/6/7, All Zone)**14#:** Change to function 4  
(CONF, TONE, Set MSG, TRFR, RLSE, MUTE)**15#:** Change to function 5  
(SADI, REDI, DTMFCV, RLSE, AC-CODE, MUTE)**16#:** Change to function 6  
(C-WATNG, MSGE, CO-QNG, OVRDE, RLSE)**17#:** Change to function 7  
(AC-CODE, LCR, TRK-G/81/82/83/84/85/86)**18#:** Change to function 8  
(UNA-PUP./Group/Direct/Page)**19#:** Change to function 9  
(MCO, LCR, PSD, SSD, EXT, MUTE, PAGE, TONE)**20#:** Change to function 10  
(MSGE, TRFR, RLSE, CONF, MUTE, DND, TONE,  
PKHLD)**21#:** Change to function 11  
(REDI, DTMFCV,  
AC-CODE, SSD, PSD, RLSE, MUTE, EXT)**22#:** Change to function 12  
(SADI, PSD, SSD, CONF,  
AC-CODE, MUTE, RLSE, TRFR, REMDR)**23#:** Change to function 13  
(PGANS, HS, TONE, MUTE, UNA, EXT, PSD, SSD)**24#:** Change to function 14  
(TAKBK, RLSE, CONF, TRFR, DND, PKHLD)

**3 - 4 Ring (Incoming ring assignment)  
mode**

*Specifications are made with regard to incoming outside calls and incoming intercom call groups for each extension.*

*In the case of outside lines it is set which incoming calls each extension is to receive.*

*The settings for daytime and nighttime can be done separately.*

*There are the following two group settings for incoming intercom calls.*

***A: Call hunting group setting***

*Extensions are set in groups for answering incoming calls.*

*The specifications for group processing after incoming calls are also set.*

*A maximum of 8 groups each with 8 extensions can be programmed.*

***B: Call coverage group setting***

*Extension groups are set for the substitute answering of incoming calls.*

*Each group comprises 8 extensions, 2 of which can be programmed as secretary telephones for substitute answering.*

*There can be a maximum of 16 groups.*

**3-4-1 Day Time Incoming Call Setting mode**

1-145 FOR (CFCB)

(CFCB)

FF4-1#-(1-73)#-(1-32)#-(0 or 1)#

**Daytime incoming outside line call setting table**

It is set which incoming outside line call tones are to sound for each extension during the day. While it is possible to make calls from an extension port not programmed for incoming calls, it is not possible to use the auto answering function for incoming calls. Incoming calls are answered by pressing the relevant line key or utilizing the function for accessing the set outside line.

Extensions not stored in this table are not used for incoming outside line calls.

Setting step 1.

Select Extension port number: (1-73)#

Setting step 2.

Trunk port number: (1-32)#

Setting step 3.

Setting Data to ring 1 or no ring 0: (1/0)#

The structure of the data storing in the table is as follows.

Extension port number 1# to 72#

↓

Trunk port number 1# to 32#

↓

Ringing for set incoming outside line calls in daytime (Yes: 1 or No: 0)#

And

Number (for UNA Relay Terminal input) 73#

↓

Trunk port number 1# to 32#

↓

Ringing for set incoming outside line calls in daytime (Yes: 1 or No: 0)#

*Note1. When program Extension port number 73 in the setting step 2 that make to set the data for all other ports extension by automatically.*

*Note2. Initially Extension port number 1 and 2 is set to ring for attendant telephone.*

### 3 - 4 - 2 Night Time Incoming Call Setting mode

1-145 FOR (CPDTS)  
FF4-2#-(1-73)#-(1-32)#-(0 or 1)#

(CPDCA)

#### Nighttime incoming outside line call setting table

It is set which incoming outside line call tones are to sound for each extension during the night and on holidays.

While it is possible to make calls from an extension port not programmed for incoming calls, it is not possible to use the auto answering function for incoming calls.

Incoming calls are answered by pressing the relevant line key or utilizing the function for accessing the set outside line.

Extensions not stored in this table are not used for incoming outside line calls.

#### Setting step 1.

Select Extension port number: (1-73)#

#### Setting step 2.

Trunk port number: (1-32)#

#### Setting step 3.

Setting Data to ring 1 or no ring 0: (1/0)#

The structure of the data storing in the table is as follows.

Extension port number 1# to 72#

↓

Trunk port number 1# to 32#

↓

Ring for set incoming outside line calls in daytime (Yes: 1 or No: 0)#

And

Number (for UNA Relay Terminal input) 73#

↓

Trunk port number 1# to 32#

↓

Ring for set incoming outside line calls in daytime (Yes: 1 or No: 0)#

Note1. When program Extension port number 73 in the setting step 2 that make to set the data for all other ports extension by automatically.

Note2. Initially Extension port number 1 and 2 is set to ring for attendant telephone.

TURN OFF OFF HOOK  
SIGNALING FOR  
ANY HUNT  
MEMBER.

### 3 - 4 - 3 Hunting group setting mode

When there is an incoming call to a group for a work unit within the company, if the extension which has received it is busy, it is automatically transferred to another extension in the group. With this setting extensions are stored for each hunting group number for allowing incoming calls to be automatically transferred between them when they are busy.

For the registered extensions incoming calls are transferred within the group according to the order set.

There are 8 hunting groups and up to 8 extensions can be stored in each group.

However, when the extension called is set for absence transfer, the incoming call is transferred to the other extension set regardless of the order set in this program.

If an extension receiving a hunting group transfer is set for absence transfer, absence or DND, it is no longer available and the call is transferred to the next extension within the group.

### FF4-3#-(1-8)#-1#-(1-0)#

#### Hunting group mode type

When there is an incoming call to an extension within the hunting group which is busy, it is automatically transferred according to the order laid down in the hunting group table. This setting is for specifying, if the last extension stored in the table is also busy and cannot receive the transferred call, whether the transfer process is to be implemented once more from the first extension in the table (hereafter called the circular mode), or in the case of an incoming intercom call on member 1 is transferred in order and when the last extension is also busy and cannot receive the transferred call whether to busy tone is to be sent to the extension making the call and the transfer process within the hunting group thereby terminated (hereafter called the terminate mode). This is the same for incoming outside line calls except that the busy tone is not sent out in this case.

The incoming call tone is sent from the busy extension which has received the call.

- 1#-1#-(0-1)#: Call hunting group 1 is  
(0: Terminal, 1: Circular)
- 2#-1#-(0-1)#: Incoming call hunting group 2 is  
(0: Terminal, 1: Circular)
- 3#-1#-(0-1)#: Incoming call hunting group 3 is  
(0: Terminal, 1: Circular)
- 4#-1#-(0-1)#: Incoming call hunting group 4 is  
(0: Terminal, 1: Circular)
- 5#-1#-(0-1)#: Incoming call hunting group 5 is  
(0: Terminal, 1: Circular)
- 6#-1#-(0-1)#: Incoming call hunting group 6 is  
(0: Terminal, 1: Circular)
- 7#-1#-(0-1)#: Incoming call hunting group 7 is  
(0: Terminal, 1: Circular)
- 8#-1#-(0-1)#: Incoming call hunting group 8 is  
(0: Terminal, 1: Circular)

FF4-3#-(1-8)#-2#-(1-8)#

**Next call hunting group**

If all the extensions in one hunting group cannot receive an incoming call, it can be automatically transferred to another hunting group. However, a hunting group in which automatic transfer is actually operating at the time cannot be set for this. It has to be set after that operation has finished.

A hunting group number for the transferee is set for each transferring hunting group. This setting can be canceled by inputting the [CONF] key.

1#-2#-(1-8)# Transfer from group 1 to set group  
Group (1 to 8)# :CONF (clear)

2#-2#-(1-8)# Transfer from group 2 to set group  
Group (1 to 8)# :CONF (clear)

3#-2#-(1-8)# Transfer from group 3 to set group  
Group (1 to 8)# :CONF (clear)

4#-2#-(1-8)# Transfer from group 4 to set group  
Group (1 to 8)# :CONF (clear)

5#-2#-(1-8)# Transfer from group 5 to set group  
Group (1 to 8)# :CONF (clear)

6#-2#-(1-8)# Transfer from group 6 to set group  
Group (1 to 8)# :CONF (clear)

7#-2#-(1-8)# Transfer from group 7 to set group  
Group (1 to 8)# :CONF (clear)

8#-2#-(1-8)# Transfer from group 8 to set group  
Group (1 to 8)# :CONF (clear)



**FF4-3#-1#-(3-10)#-(Extension number)#**

**Hunting group 1 member table**

A maximum of 8 extensions can belong to group 1.  
When there is an incoming call to the group, it is automatically transferred according to the order 1 - 8 as stored.

Extension numbers already stored can be erased by inputting the [CONF] key.

A maximum of 8 extensions can be stored as belonging to hunting group 1.

3#-(Extension number)#: Member No.1	First
4#-(Extension number)#: Member No.2	↓
5#-(Extension number)#: Member No.3	↓
6#-(Extension number)#: Member No.4	↓
7#-(Extension number)#: Member No.5	↓
8#-(Extension number)#: Member No.6	↓
9#-(Extension number)#: Member No.7	↓
10#-(Extension number)#: Member No.8	End

**FF4-3#-2#-(3-10)#-(Extension number)#**

**Hunting group 2 member table**

Same as group 1

3#-(Extension number)#: Member No.1	First
4#-(Extension number)#: Member No.2	↓
5#-(Extension number)#: Member No.3	↓
6#-(Extension number)#: Member No.4	↓
7#-(Extension number)#: Member No.5	↓
8#-(Extension number)#: Member No.6	↓
9#-(Extension number)#: Member No.7	↓
10#-(Extension number)#: Member No.8	End

**FF4-3#-3#-(3-10)#-(Extension number)#**

**Hunting group 3 member table**

Same as group 1

3#-(Extension number)#: Member No.1	First
4#-(Extension number)#: Member No.2	↓
5#-(Extension number)#: Member No.3	↓
6#-(Extension number)#: Member No.4	↓
7#-(Extension number)#: Member No.5	↓
8#-(Extension number)#: Member No.6	↓
9#-(Extension number)#: Member No.7	↓
10#-(Extension number)#: Member No.8	End

**FF4-3#-4#-(3-10)#-(Extension number)#**

**Hunting group 4 member table**

Same as group 1

3#-(Extension number)#: Member No.1	First
4#-(Extension number)#: Member No.2	↓
5#-(Extension number)#: Member No.3	↓
6#-(Extension number)#: Member No.4	↓
7#-(Extension number)#: Member No.5	↓
8#-(Extension number)#: Member No.6	↓
9#-(Extension number)#: Member No.7	↓
10#-(Extension number)#: Member No.8	End

**FF4-3#-5#-(3-10)#-(Extension number)#**

**Hunting group 5 member table**

Same as group 1

Abbreviated

**FF4-3#-6#-(3-10)#-(Extension number)#**

**Hunting group 6 member table**

Same as group 1

Abbreviated

**FF4-3#-7#-(3-10)#-(Extension number)#**

**Hunting group 7 member table**

Same as group 1

Abbreviated

**FF4-3#-8#-(3-10)#-(Extension number)#**

**Hunting group 8 member table**

Same as group 1

3#-(Extension number)#: Member No.1	First
4#-(Extension number)#: Member No.2	↓
5#-(Extension number)#: Member No.3	↓
6#-(Extension number)#: Member No.4	↓
7#-(Extension number)#: Member No.5	↓
8#-(Extension number)#: Member No.6	↓
9#-(Extension number)#: Member No.7	↓
10#-(Extension number)#: Member No.8	End

### 3 - 4 - 4 Call Coverage Group setting mode

FF4-4#-1#-(1 - 8)#-(extension number)#

#### Call coverage group 1 member table

Call coverage groups comprise those for management personnel and the like separated into work units for example, and secretaries are stored for each group. A group is composed of 6 member extensions and 2 secretaries. A maximum of 16 groups can be stored in the system.

Secretaries and member extensions already stored can be erased by inputting the [CONF] key. An extension stored in this table cannot become a member of a hunting group, neither can it be a member of two call coverage groups.

The structure for the extension numbers in the table is as follows.

A maximum of 8 extensions can be stored as belonging to coverage group 1.

1#-(Extension number)#: Group secretary No.1

2#-(Extension number)#: Group secretary No.2

3#-(Extension number)#: Member No.1 ↑

4#-(Extension number)#: Member No.2 ↑

5#-(Extension number)#: Member No.3 ↑

6#-(Extension number)#: Member No.4 ↑

7#-(Extension number)#: Member No.5 ↑

8#-(Extension number)#: Member No.6 ↑

FF4-4#-2#-(1 - 8)#-(extension number)#

#### Call coverage group 2 member table

Same as group 1

Abbreviated

FF4-4#-3#-(1 - 8)#-(extension number)#

#### Call coverage group 3 member table

Same as group 1

Abbreviated

FF4-4#-4#-(1 - 8)#-(extension number)#

#### Call coverage group 4 member table

Same as group 1

Abbreviated

FF4-4#-5#-(1 - 8)#-(extension number)#

#### Call coverage group 5 member table

Same as group 1

Abbreviated

FF4-4#-6#-(1 - 8)#-(extension number)#

#### Call coverage group 6 member table

Same as group 1

Abbreviated

FF4-4#-7#-(1 - 8)#-(extension number)#

#### Call coverage group 7 member table

Same as group 1

Abbreviated

FF4-4#-8#-(1 - 8)#-(extension number)#

#### Call coverage group 8 member table

Same as group 1

Abbreviated

FF4-4#-9#-(1 - 8)#-(extension number)#

#### Call coverage group 9 member table

Same as group 1

Abbreviated

FF4-4#-10#-(1 - 8)#-(extension number)#

#### Call coverage group 10 member table

Same as group 1

Abbreviated

FF4-4#-11#-(1 - 8)#-(extension number)# to

FF4-4#-15#-(1 - 8)#-(extension number)#

is abbreviated

FF4-4#-16#-(1 - 8)#-(extension number)#

#### Call coverage group 16 member table

Same as group 1

1#-(Extension number)#: Group secretary No.1

2#-(Extension number)#: Group secretary No.2

3#-(Extension number)#: Member No.1 ↑

4#-(Extension number)#: Member No.2 ↑

5#-(Extension number)#: Member No.3 ↑

6#-(Extension number)#: Member No.4 ↑

7#-(Extension number)#: Member No.5 ↑

8#-(Extension number)#: Member No.6 ↑

**3 - 5 FF key (Function assignment) mode**

*CONF. TO CLEAR FIRST.*

FF5-(1 - 72)#-(1 - 24)#-(code)#

**FF key function assignment for extensions**

The features listed on this page can be entered by the associated code for each LED type key on any extension. CO appearances direct or pooled must first be removed by pressing the conf key on a particular key appearance prior to entering new data. For programming several phones with the same or comparable key layout see FF key copy mode page.

*Note: Since the \* and # keys on the dial pad are used for entering data these symbols for feature codes are stored under FF key 11 (\*) and FF key 12 (#). When entering these symbols the display will not indicate that any data was entered.*

*ATT. CALL HAVE*

	<u>Setting contents</u>	<u>Setting method</u>
Trunk port number	Trunk (1-32)	(1-32)#
Extension number (2 digits)	Ext. (10-69)	[PROG]-.(10-69)#
Extension number (3 digits)	Ext. (100-699)	[PROG]-.(100-699)#
Direct CO access	Trunk (1-32)	(8801-8832)#
Group call pick up	70	70#
Absence message code	71	71#
Call forward code	72	72#
DND set code	73	73#
Station lockout code	74	74#
Park hold	75	75#
Meet me answer	77	77#
UNA pick up	78	78#
Direct pick up	79	79#
Pooled trunk access	Group(81-86,9)	(81-86, 9)#
LCR call	9	9#
Page call (Zone 1-7)	#(1-7)	(FF 12 Key)-(00-07)#
Alarm setting	#4	[FF 12 Key]-4#
IDT stop/reset	#50	[FF 12 Key]-50#
Headset / handset mode	#51	[FF 12 Key]-51#
Night mood set	#52	[FF 12 Key]-52#
BGM on/off	#53	[FF 12 Key]-53#
Account code	#7	[FF 12 Key]-7#
Intercom key	#8	[FF 12 Key]-8#
Answer key	*1	[FF 11 Key]-1#
Release key	*2	[FF 11 Key]-2#
Talk back key	*3	[FF 11 Key]-3#
System / personal speed dial	(AUTO)-(00-99)	AUTO-(00-99) #

*DISPLAY FEATURE OF KEY ON/OFF CONF & KEY*

*DSS CODES* *BTNS*  
FF5-(73-76)#-(1-72)#-(code)#

### FF key function assignment for DSS consoles

The features listed on this page can be entered by the associated code for each LED type per each console. CO appearances direct or pooled must first be removed by pressing the conf key on a particular key appearance prior to entering new data.

*Note: Since the \* and # keys on the dial pad are used for entering data these symbols for feature codes are stored under FF key 11 (\*) and FF key 12 (#). When entering these symbols the display will not indicate that any data was entered.*

	<u>Setting contents</u>	<u>Setting method</u>
Trunk port number	Trunk (1-32)	(1-32)#
Extension number (2 digits)	Ext. (10-69)	[PROG]-.(10-69)#
Extension number (3 digits)	Ext. (100-699)	[PROG]-.(100-699)#
Direct CO access	Trunk (1-32)	(8801-8832)#
Group call pick up	70	70#
Absence message code	71	71#
Call forward code	72	72#
DND set code	73	73#
Station lockout code	74	74#
Park hold	75	75#
Meet me answer	77	77#
UNA pick up	78	78#
Direct pick up	79	79#
Pooled trunk access	Group(81-86,9)	(81-86, 9)#
LCR call	9	9#
Page call (Zone 1-7)	*(1-7)	(FF 12 Key)-(00-07)#
Alarm setting	#4	[FF 12 Key]-4#
!DT stop/reset	#50	[FF 12 Key]-50#
Headset / handset mode	#51	[FF 12 Key]-51#
Night mood set	#52	[FF 12 Key]-52#
BGM on/off	#53	[FF 12 Key]-53#
Account code	#7	[FF 12 Key]-7#
Intercom key	#8	[FF 12 Key]-8#
Answer key	*1	[FF 11 Key]-1#
Release key	*2	[FF 11 Key]-2#
Talk back key	*3	[FF 11 Key]-3#
System / personal speed dial	(AUTO)-(00-99)	AUTO-(00-99) #

3 - 6 Name (Name and message storing) mode

Each extension, SSD and PSD name, and absence message is stored.

For storing the keys assigned by alphabetical letters and symbols of the DSS 172 (DSS console)(VB-43320) connected to the attendant's telephone are used.

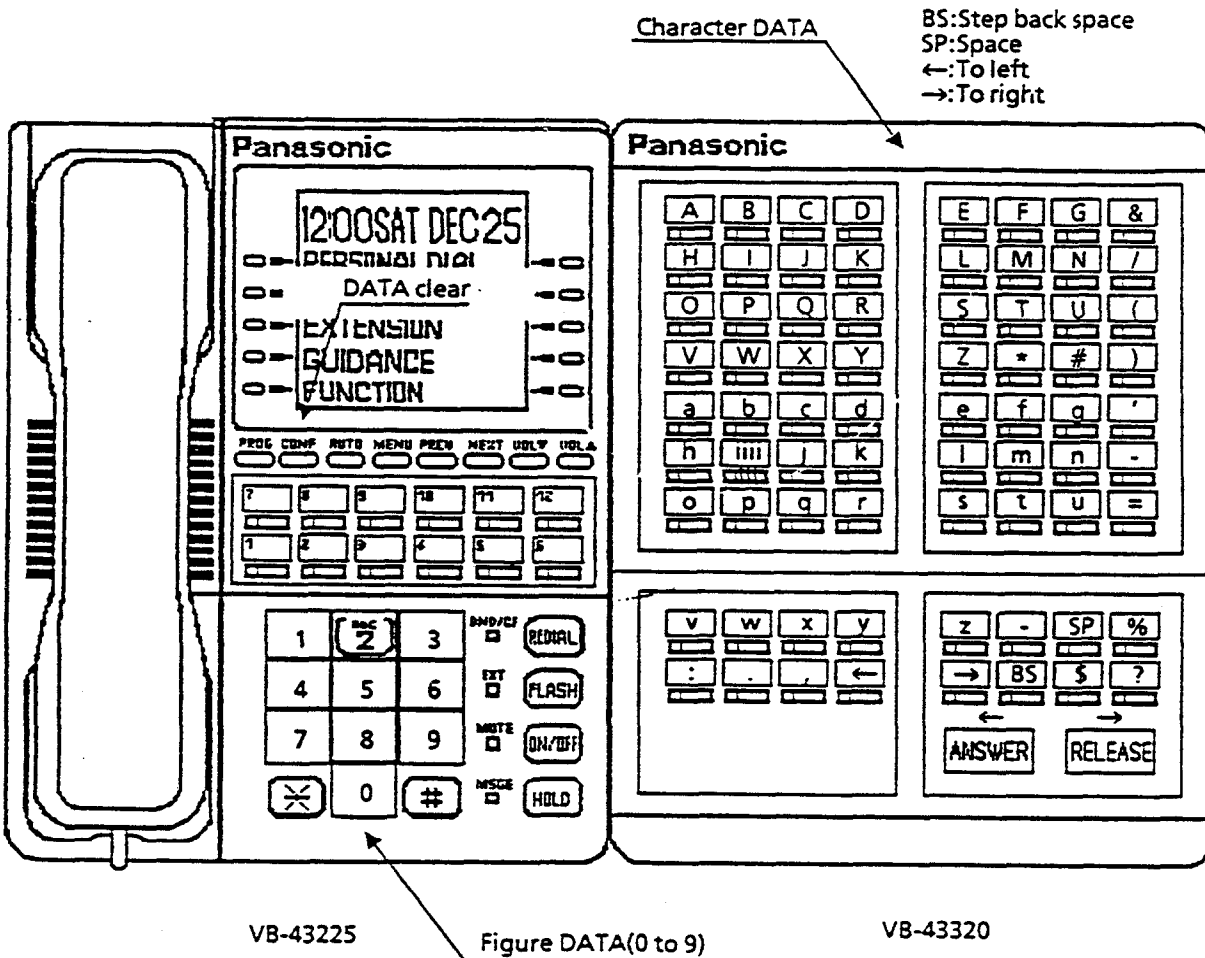

Fig 3-1 VB-43225 and VB-43320

## FF6-1#-(1 - 72)#-(Name)#

**Assigning names extensions**

Names are stored for each of the extension ports from 1 to 72. By having the names stored for each of the extensions, it is possible for the two parties to confirm each others name while making an intercom call.

This is particularly useful when receiving a call from another extension in that you can see the name of the callers extension at a glance.

In addition, the names stored are normally shown on the LCD of a registered extension.

A name consists of a maximum of 10 letters.

## FF6-1#-NN(1 - 72)#-(Name)#

NN#: Extension port number it is desired to store (the extension number is automatically displayed).

[CONF]#: For clear previous data

Nick#: When it is desired to store Nick for example.

## FF6-2#-(00 - 89)#- (Name)#

**Assigning names to SSD code**

Names are stored for each of the SSD (System speed dial) codes from 00 to 89. By having names stored for each of the SSD codes, the name can be confirmed when dialing using SSD.

This is particularly useful for SSD numbers on a telephone having a large display because the stored names are clearly arranged alphabetically and the name of the party you intend to call can be seen at a glance.

In addition, the stored name is indicated on the LCD during a call made using the stored SSD.

## FF6-2#-NN(00 - 89)#- (Name)#

NN#: Special speed dial code it is desired to store

[CONF]#: For clear previous data

Panasonic Co.. #: (When it is desired to store Panasonic Industrial for example)

## FF6-3#-(1 - 72)#-(90 - 99)#-(Name)#

**Assigning names to PSD codes**

Names are stored for PSD (Personal speed dial) codes 90 - 99 of each of the extension ports from 1 to 72.

This function is the same as Assigning names to SSD code (FF6-2#-(00 - 89)#).

The names consist of a maximum of 16 letters.

## FF6-3#-NN(1 - 72)#-SS(90 - 99)#-(Name)#

NN#: Extension port number it is desired to store

SS#: PSD code it is desired to store

[CONF]#: For clear previous data

Panasonic Service #: (When it is desired to store Panasonic Service for example)

## FF6-4#-(5 - 9)#- (Message)#

**Assigning absence message**

An absence message can be conveyed to a party who calls while you are out.

With this setting the contents are stored in message codes 5 - 9. Message codes 0 - 4 have been stored beforehand and cannot be changed.

A message consists of a maximum of 15 letters.

## FF6-4#-(5 - 9)#- (Message)#

(5~9)#: Customized Absence Message to be stored

[CONF]#: For clear previous data

At Panasonic #: (When it is desired to store, "I left to Panasonic" for example)

### 3 - 7 TRS (Toll restriction system) mode

*This is to set toll restriction for a telephone. There are 7 types of setting for each outside line connected to the system in the case of each telephone.*

*In that restrictions can be set for daytime and nighttime separately, it is also possible to control expensive telephone charges.*

*Toll restriction implemented here is done by determining whether or not the call is allowed depending on the number dialed by means of the code table in the main memory (toll number - area number - telephone number).*

*Below is shown the structure of a simple TRS system.*

FF7-1#- 1#-(0 or 1)#

#### **Setting restriction determining method for Long distance calls**

It is specified which of the following restrictions is determined depending on whether the first digit dialed from extensions set as types 3 - 6 is 1 or 0.

(X = 0-9, P = 0 or 1, N = 2-9)

0#: 0PX-XXXXX Restrict (Not determined by table)

0NX-XXXXX Allow (Not determined by table)

1#: 0XX-XXXXX Determined by office code table

*Note 1: For the system installation area it is necessary to specify either + 1 Area or Non + 1 Area.*

FF7- 1#-2#-(0 or 1)#

#### **Dialing restriction during incoming call**

It is specified whether the dial signal can be sent out to outside lines which has received an incoming calls from extensions set as types 3 - 6. The dial signal is sent out while the call is in progress after it has been answered, and at such times the call sent is not restricted according to the dialing contents [set functions].

The call sent is subject to restriction irrespective of the setting when the FLASH key is pressed down after the telephone conversation.

0#: Not possible to dial during conversation after incoming call answered

1#: Possible to dial during conversation after incoming call answered.

<sup>1 or 15</sup>  
FF7-1#-3#-(0 or 1)#

**Restriction for maximum number of digits dialed when making call**

The maximum number of digits which can be sent out for the dialing signal from extensions set as types 3 - 6 is specified.

The setting is within the range of 15 - 29 digits, and it is also possible to specify that the number of digits not be restricted.

[CONF]#: Number of digits not restricted

- 1#: Dialing not sent out after 15th digit dialed
- 2#: Dialing not sent out after 16th digit dialed
- 3#: Dialing not sent out after 17th digit dialed
- 4#: Dialing not sent out after 18th digit dialed
- 5#: Dialing not sent out after 19th digit dialed
- 6#: Dialing not sent out after 20th digit dialed
- 7#: Dialing not sent out after 21st digit dialed
- 8#: Dialing not sent out after 22nd digit dialed
- 9#: Dialing not sent out after 23rd digit dialed
- 10#: Dialing not sent out after 24th digit dialed
- 11#: Dialing not sent out after 25th digit dialed
- 12#: Dialing not sent out after 26th digit dialed
- 13#: Dialing not sent out after 27th digit dialed
- 14#: Dialing not sent out after 28th digit dialed
- 15#: Dialing not sent out after 29th digit dialed

FF7-1#-4#-(0 or 1)#

**211 dial restriction**

It is specified whether the 211 dial signal can be sent out from extensions set as types 2 - 6.

- 0#: 211 dial calls possible
- 1#: No 211 dial calls possible

FF7-1#-5#-(0 or 1)#

**311 dial restriction**

It is 311 dial restriction, to types 2 to 6.

- 0#: 311 dial calls possible
- 1#: No 311 dial calls possible

FF7-1#-6#-(0 or 1)#

**411 dial restriction**

It is 311 dial restriction, to types 2 to 6.

- 0#: 411 dial calls possible
- 1#: No 411 dial calls possible

FF7-1#-7#-(0 or 1)#

**511 dial restriction**

It is 311 dial restriction, to types 2 to 6.

- 0#: 511 dial calls possible
- 1#: No 511 dial calls possible

FF7-1#-8#-(0 or 1)#

**611 dial restriction**

It is 311 dial restriction, to types 2 to 6.

- 0#: 611 dial calls possible
- 1#: No 611 dial calls possible

FF7-1#-9#-(0 or 1)#

**711 dial restriction**

It is 311 dial restriction, to types 2 to 6.

- 0#: 711 dial calls possible
- 1#: No 711 dial calls possible

FF7-1#-10#-(0 or 1)#

**811 dial restriction**

It is 311 dial restriction, to types 2 to 6.

- 0#: 811 dial calls possible
- 1#: No 811 dial calls possible

FF7-1#-11#-(0 or 1)#

**911 dial restriction**

It is 311 dial restriction, to types 2 to 6.

- 0#: 911 dial calls possible
- 1#: No 911 dial calls possible

*0 ARE  
DEFAULT*



FF7-1# 12#-(0 or 1)#

**Setting 7 digit dial restriction from Type 2 extension**

It is specified whether to have a 7 digit dial restriction for the signal from an extension set as Type 2.

0#: Signal from Type 2 not subject to 7 digit dial restriction

1#: Signal from Type 2 subject to 7 digit dial restriction

FF7-1# 13#-(0 or 1)#

**Setting 7 digit dial restriction from Type 3 extension**

It is specified whether to have a 7 digit dial restriction for the signal from an extension set as Type 3.

0#: Signal from Type 3 not subject to 7 digit dial restriction

1#: Signal from Type 3 subject to 7 digit dial restriction

FF7-1# 14#-(0 or 1)#

**Setting 7 digit dial restriction from Type 4 extension**

It is specified whether to have a 7 digit dial restriction for the signal from an extension set as Type 4.

0#: Signal from Type 4 not subject to 7 digit dial restriction

1#: Signal from Type 4 subject to 7 digit dial restriction

FF7-1# 15#-(0 or 1)#

**Setting 7 digit dial restriction from Type 5 extension**

It is specified whether to have a 7 digit dial restriction for the signal from an extension set as Type 5.

0#: Signal from Type 5 not subject to 7 digit dial restriction

1#: Signal from Type 5 subject to 7 digit dial restriction

FF7-1# 16#-(0 or 1)#

**Setting 7 digit dial restriction from Type 6 extension**

It is specified whether to have a 7 digit dial restriction for the signal from an extension set as Type 6.

0#: Signal from Type 6 not subject to 7 digit dial restriction

1#: Signal from Type 6 subject to 7 digit dial restriction

FF7-2#-(3-6)#-(000-999)#-0 or 1#

### Area code table storing

The area code table for determining the restrictions on calls from extensions of types 3 - 6 is stored.

The area code (000 - 999) for each of types 3 - 6 is registered, so that when the area code number dialed conforms with that stored, the outside call is subject to restriction.

When the call is determined as such, as the outside line is released the intercom busy tone is sent to the extension which has made the call and "Restricted" appears on the LCD.

The dialing numbers determined from the area code table are the 3 underlined digits as indicated below. (X = 0 - 9)

1 + Area code location:

1-XXX-XXX-XXXX

1-0-XXX-XXX-XXX-XXXX

Non 1 + Area code location:

1-XXX-XXX-XXXX

1-0-XXX-XXX-XXX-XXXX

Area codes not stored in this table are not subject to toll restriction.

The structure for data storing in the table is as followed.

TRS type Number 3# DENY "1"

Area code DATA:

(000-999)#-(Deny:1 or Allow:0)#

TRS type Number 4# DENY "1"

Area code DATA:

(000-999)#-(Deny:1 or Allow:0)#

TRS type Number 5# ALLOW "0"

Area code DATA:

(000-999)#-(Deny:1 or Allow:0)#

TRS type Number 6# ALLOW "0"

Area code DATA:

(000-999)#-(Deny:1 or Allow:0)#

Note : For the system installation area it is necessary to specify either 1 + Area or Non 1 + Area.

FF7-3#-(3-6)#-(000-999)#-(0 or 1)#

### Office code table storing

The office code table for determining the restrictions on calls from extensions of types 3 - 6 is stored. The office code (000 - 999) for each of types 3 - 6 is stored, so that when the office code number dialed conforms with that stored, the outside call is subject to restriction.

When the call is determined as such, as the outside line is released the intercom busy tone is sent to the extension which has made the call and "Restricted" appears on the LCD.

The dialing numbers determined are the 3 underlined digits as indicated below. (X = 0 - 9)

1 + Area code location:

1-XXX-XXXX

Non 1 + Area code location:

XXX-XXXX

1-XXX-XXX

Office codes not stored in this table are not subject to call restriction.

The structure for data storing in the table is as followed.

TRS type Number 3# DENY "1"

Office code DATA:

(000-999)#-(Deny:1 or Allow:0)#

TRS type Number 4# ALLOW "0"

Office code DATA:

(000-999)#-(Deny:1 or Allow:0)#

TRS type Number 5# ALLOW "0"

Office code DATA:

(000-999)#-(Deny:1 or Allow:0)#

TRS type Number 6# ALLOW "0"

Office code DATA:

(000-999)#-(Deny:1 or Allow:0)#

Note : For the system installation area it is necessary to specify either 1 + Area or Non 1 + Area.

FF7-4#-(1 - 4)#- ((000 - 999) or [CONF])#

**Special area code table storing**

The special area code table for determining the restrictions on calls from extensions of types 3 - 6 is stored.

The special area code (000 - 999) for each of types 3 - 6 is stored, so that when the area code number dialed conforms with that stored, it is confirmed by the special office code table corresponding to the respective special area code table and subject to restriction if the office code conforms.

When the call is determined as such, as the outside line is released the intercom busy tone is sent to the extension which has made the call and "Restricted" appears on the LCD. That is to say, rather than determining the area code or office code separately, a telephone number headed by 6 digits combining the special area code and special office code is determined. In this table are stored 4 special area code (000 - 999) tables, and special area codes already stored are deleted by inputting [CONF].

The dialing numbers determined are the 3 underlined digits as indicated below. (X = 0 - 9)

1 + Area code location:

1-XXX-XXX-XXXX  
1-0-XXX-XXX-XXX-XXXX

Non 1 + Area code location:

1-XXX-XXX-XXXX  
1-0-XXX-XXX-XXX-XXXX

Special area codes not stored in this is not subject to call restriction.

The structure for data storing in the table is as followed.

- Special area code Number 1#  
Special area code DATA:  
(000-999)#/Clear: [CONF]
- Special area code Number 2#  
Special area code DATA:  
(000-999)#/Clear: [CONF]
- Special area code Number 3#  
Special area code DATA:  
(000-999)#/Clear: [CONF]
- Special area code Number 4#  
Special area code DATA:  
(000-999)#/Clear: [CONF]

FF7-5#-(1 - 4)#-(0 or 1)#

*(000-999) Off. Code.*

**Special office code table storing**

The special office code table for determining the restrictions on calls from extensions of types 3 - 6 is stored.

The special area code (000 - 999) for each of types 3 - 6 is stored, so that when the area code number dialed conforms with that stored, it is confirmed by the special office code table corresponding to the respective special area code table and subject to restriction if the office code conforms.

When the call is determined as such, as the outside line is released the intercom busy tone is sent to the extension which has made the call and "Restricted" appears on the LCD.

That is to say, rather than determining the area code or office code separately, a telephone number headed by 6 digits combining the special area code and special office code is determined. In this table are stored 4 special area code (000 - 999) tables, and special office codes already stored are deleted by inputting [CONF].

The dialing numbers determined are the 3 underlined digits as indicated below. (X = 0 - 9)

1 + Area code location:

- 1-XXX-XXX-XXXX
- 1-0-XXX-XXX-XXX-XXXX

Non 1 + Area code location:

- 1-XXX-XXX-XXXX
- 1-0-XXX-XXX-XXX-XXXX

Special office codes not stored in this table are not subject to call restriction. The structure for data storing in the table is as followed.

Special office code Number 1#  
 Special area code DATA : DENY "1"  
 (000-999)#-(Deny:1 or Allow:0)#

Special office code Number 2#  
 Special area code DATA : DENY "1"  
 (000-999)#-(Deny:1 or Allow:0)#

Special office code Number 3#  
 Special area code DATA : ALLOW "0"  
 (000-999)#-(Deny:1 or Allow:0)#

Special office code Number 4#  
 Special area code DATA : ALLOW "0"  
 (000-999)#-(Deny:1 or Allow:0)#

FF7-6#-(1 - 50)#-(0000000 - 9999999)#

**7digit call restriction table storing**

Calls sent from extensions set as types 2 - 6 are determined by the area/office codes or special area/office codes and it is confirmed that they have been dialed.

Then they are verified against the 7 digit dial numbers already stored, and if they conform [to one of these numbers] the sending of the dial signal is restricted.

A maximum of 50 7 digit dial numbers can be stored, and special area codes already stored are deleted by inputting [CONF].

[CONF]#: Reset programed data  
(0000000 - 9999999)#: 7 digit dial numbers

Note: "\*" and "#" cannot be input.

TRS TYPE SETTINGS

TYPE  
SETTING

CALLING ACCESS

- 0 ICM only, NO outgoing calls , can only answer calls ringing to that extension
- 1 ICM only, NO outgoing calls, can answer calls ringing anywhere
- 2 7 Digit numbers and 1-800 numbers ONLY allowed . *No 0*

	AREA CODES	<del>OFFICE</del> CODES	SPECIAL AREA CODES	SPECIAL OFFICE CODES	
	UP TO 1000	UP TO 1000	UP TO FOUR	UP TO 1000/ONE SPA	
3	Deny	Deny	1-4	Deny	<i>No 0</i>
4	Deny	Allow	1-4	Deny	"
5	Allow	Allow	1-4	Deny	"
6	Allow	Allow	1-4	Deny	"
7	DEFAULT= FULL ACCESS, COMPLETELY UNRESTRICTED				

*11.0*  
*0590*

Values 0,1,2 are controlled restrictions

Values 3,4,5,6 are flexible, programmable restrictions

Types 3,4,5,6, above setting are default in the system and are changeable (Deny/Allow)

STN TRK RES.  
 FF7-7#-(1-72)#-(1-32)#-(0-7)#

### Day time TRS type setting

The toll restriction type (0 - 7) for the daytime band is set for each outside line port number in the case of each extension.

- 0#: Type 0: No outside calls can be made. Apart from answering calls coming in on your outside line, or putting another telephone on hold and transferring, it is also not possible to get an outside line. After a conversation on an outside line has finished, the lamp flashes and the busy tone sounds.
- 1#: Type 1: No outside calls can be made. Apart from answering calls coming in on an outside line, or putting another telephone on hold and transferring, it is also not possible to get an outside line. After a conversation on an outside line has finished, the lamp flashes and the busy tone sounds.
- 2#: Type 2: Apart from talk - free dialing, trunk calls cannot be made. Below are shown the relevant details about the call restrictions.
- A. Restriction on number of dialing digits (Max. 7 digits)
  - B. Timing between dialing digits (Max. 6 sec.)
  - C. Specific 3 digit dialing restriction (Dial: (2 - 9)-1-1)
  - D. Operator call restriction (Dial: 0)
  - E. SSD restriction override (Dial: Auto (NN - 89))
  - F. 7 digit restriction (Stored phone number)
- 3#: Type 3: Restrictions are made based on the specifications set for each type (3 - 6). When the lamp flashes, after the telephone conversation is finished, the extension is in the call status with the specified restrictions. Below are shown the relevant details about the call restrictions.
- B. Timing between dialing digits (Max. 6 sec.)
  - C. Specific 3 digit dialing restriction (Dial: (2 - 9)-1-1)
  - E. SSD restriction override (Dial: Auto (NN - 89))
  - F. 3 digit restriction (stored area or office code)
  - G. 6 digit restriction (stored special area and special office codes)
  - H. Restriction on number of dialing digits (Max. (15 - 30) digits)
- \*NN : System setting
- 4#: Type 4: Restrictions are made based on the specifications for each type (3 - 6).
- 5#: Type 5: Restrictions are same as Type 4.
- 6#: Type 6: Restrictions are same as Type 4.
- 7#: Type 7: Not applicable to any of the restrictions.

FF7-7#-(1-72)#-33#-(0-7)#

### Day time all TRS setting

When data(0~7)# is set for address No. FF7-7#-(1~72)#-33, same setting of all CO for desired extension done automatically

FF7-8#-X(1-72)#-(1-32)#-(0-7)#

### Night time TRS type setting

The toll restriction type (0-7) for the nighttime band is set for each out-side line port number in the case of each extension.

0#: Type 0: No outside calls can be made. Apart from answering calls coming in on an outside line, or putting another telephone on hold and transferring, it is also not possible to get an outside line. After a conversation on an outside line has finished, the lamp flashes and the busy tone sounds.

1#: Type 1: No outside calls can be made. Apart from answering calls coming in on an outside line, or putting another telephone on hold and transferring, it is also not possible to get an outside line. After a conversation on an outside line has finished, the lamp flashes and the busy tone sounds.

2#: Type 2: Apart from talk - free dialing, trunk calls cannot be made. Below are shown the relevant details about the call restrictions.

- A. Restriction on number of dialing digits (Max. 6 digits)
- B. Timing between dialing digits (Max. 6 sec.)
- C. Specific 3 digit dialing restriction (Dial: (2-9)-1-1)
- D. Operator call restriction (Dial: 0)
- E. SSD restriction override (Dial: Auto (NN - 89))
- F. 7 digit restriction (stored phone number)

3#: Type 3: Restrictions are made based on the specifications set for each type (3-6). When the lamp flashes after the telephone conversation is finished, the extension is in the call status with the specified restrictions. Below are shown the relevant details about the call restrictions.

- B. Timing between dialing digits (Max. 6 sec.)
- C. Specific 3 digit dialing restriction (Dial : (2-9) - 1 - 1)
- E. SSD restriction override (Dial: Auto (NN - 89))
- F. 3 digit restriction (stored area or office code)
- G. 6 digit restriction (stored special area and special office codes)
- H. Restriction on number of dialing digits (Max. (15 - 30) digits)

\*NN: System setting

4#: Type 4: Restrictions are made based on the specifications for each type (3-6).

5#: Type 5: Restrictions are same as Type 4.

6#: Type 6: Restrictions are same as Type 4.

7#: Type 7: Not applicable to any of the restrictions.

*Note : Change to the nighttime mode is either done by the attendant by a key operation or automatically by the system. In this case it works from the time specified by the system.*

FF7-8#-X(1-72)#-33#-(0-7)#

### Night time all TRS setting

When data(0~7)# is set for address No. FF7-7#-(1~72)#-33, same setting of all CO for desired extension done automatically.



~~FF7-9#-X(1-4)#-(0 or 1)#~~

**Area Code Type Block setting mode**

The area codes (000 - 999) can be globally replaced so that they are the same TRS mode for each type (3 - 6).

- M = 1: Changing area code mode of Type 3  
Area code DATA :  
(000 - 000)# - (Restrict : 1 or Allow : 0)#
- M = 2: Changing area code mode of Type 4  
Area code DATA :  
(000 - 000)# - (Restrict : 1 or Allow : 0)#
- M = 3: Changing area code mode of Type 5  
Area code DATA :  
(000 - 000)# - (Restrict : 1 or Allow : 0)#
- M = 4: Changing area code mode of Type 6  
Area code DATA :  
(000 - 000)# - (Restrict : 1 or Allow : 0)#

~~FF7-9#-X(5-8)#-(0 or 1)#~~

**Office Code Type Block setting mode**

The office codes (000 - 999) can be globally replaced so that they are the same TRS mode for each type (3 - 6).

- M = 5: Changing office code mode of Type 3  
Office code DATA :  
(000 - 000)# - (Restrict : 1 or Allow : 0)#
- M = 6: Changing office code mode of Type 4  
Office code DATA :  
(000 - 000)# - (Restrict : 1 or Allow : 0)#
- M = 7: Changing office code mode of Type 5  
Office code DATA :  
(000 - 000)# - (Restrict : 1 or Allow : 0)#
- M = 8: Changing office code mode of Type 6  
Office code DATA :  
(000 - 000)# - (Restrict : 1 or Allow : 0)#

~~FF7-9#-X(9-12)#-(0 or 1)#~~

**Area & Office Code Type Block setting mode**

The area/office codes (000 - 999) can be globally replaced so that they are the same TRS mode for each type (3 - 6).

- M = 9: Changing area & office code mode of Type 3  
Area & office code DATA :  
(000 - 000)# - (Restrict : 1 or Allow : 0)#
- M = 10: Changing area & office code mode of Type 4  
Area & office code DATA :  
(000 - 000)# - (Restrict : 1 or Allow : 0)#
- M = 11: Changing area & office code mode of Type 5  
Area & office code DATA :  
(000 - 000)# - (Restrict : 1 or Allow : 0)#
- M = 12: Changing area & office code mode of Type 6  
Area & office code DATA :  
(000 - 000)# - (Restrict : 1 or Allow : 0)#

~~FF7-9#-X(13-16)#-(0 or 1)#~~

**Special Area Code for Office Code Type Block setting mode**

The special area codes (000 - 999) can be globally replaced so that they are the same TRS mode for each type (3 - 6).

- M = 13: Changing special area code mode of Type 3  
Special area code DATA :  
(000 - 000)# - (Restrict : 1 or Allow : 0)#
- M = 14: Changing special area code mode of Type 4  
Special area code DATA :  
(000 - 000)# - (Restrict : 1 or Allow : 0)#
- M = 15: Changing special area code mode of Type 5  
Special area code DATA :  
(000 - 000)# - (Restrict : 1 or Allow : 0)#
- M = 16: Changing special area code mode of Type 6  
Special area code DATA :  
(000 - 000)# - (Restrict : 1 or Allow : 0)#

### 3 - 8 LCR (Least cost routing) mode

*Outside calls can be made at less cost by using MCI, SPRINT, etc. than through the ordinary ATT lines.*

*The LCR (Least Cost Routing) function has been devised to enable the automatic use of the cheapest line when dialing out.*

*A table is prepared according to the programming and the line is automatically selected by the system searching this table when calls are made.*

*With this function telephone charges can be substantially reduced, particularly in that there is a tendency to make outside calls without being conscious of the fact.*

*The procedure for setting the LCR mode involves firstly checking the cheapest trunk number when calling at each time and in each outside line group based on the telephone numbers of the parties to be called. Then the order of priority from the point telephone call costs is determined and stored in the table.*

*The following is a description of a structure for a simple LCR system.*

FF8-1#-(1-15)#-(000-999)#-(0 or 1)#

**Area code table storing**

In order to use the cheapest outside line group from among the 3 digit numbers when making an LCR call, the system searches the time priority table and refers to the specified area code table. The area code (000 - 999) table for the dialing corresponding to the time priority table number (1 - 15) call is stored.

The dial decided on comprises 3 digits for NPX as shown below.

(N = 2-9, P = 0-1, X = 0-9)

1 + Area code : 1 - NPX - XXX - XXXX

NON 1 + Area code : NPX - XXX - XXXX

Area codes not stored in this table cannot be used for LCR calls. The structure for the data storing in the table is as follows.

Time Priority Table Number 1#

Area code DATA:

(000-999)#-(Store:1 or Delete:0)#

⌋ (Time Priority Table number 1-15)

Time Priority Table number 15#

Area code DATA:

(000-999)#-(Store:1 or Delete:0)#

**NOTE 1:** For the system installation area it is necessary to set either 1 + Area or Non 1 + Area.

**NOTE 2:** LCR calls cannot be made from outside lines connected to a PBX.

FF8-2#-(1-15)#-(000-999)#-(0 or 1)#

**Office code table storing**

In order to use the cheapest outside line group from among the 3 digit numbers when making an LCR call, the system searches the time priority table and refers to the specified office code table. The office code (000 - 999) table for the dialing corresponding to the time priority table number (1 - 15) is stored.

The dial decided on comprises 3 digits for NNX and NPX as shown below.

(N = 2-9, P = 0-1, X = 0-9)

1 + Area code : 1 - NNX - XXXX

NPX-XXXX

NON 1 + Area code : NPX - XXXX

Office codes not stored in this table cannot be used for LCR calls. The structure for the data storing in the table is as follows.

Time Priority Table Number 1#

Office code DATA:

(000-999)#-(Store:1 or Delete:0)#

⌋ (Time priority table number 1-15)

Time priority table number 15#

Office code DATA:

(000-999)#-(Store:1 or Delete:0)#

**NOTE 1:** For the system installation area it is necessary to set either 1 + Area or Non 1 + Area.

**NOTE 2:** LCR calls cannot be made from outside lines connected to a PBX.

FF8-3#-(1-4)#- (000-999 or [CONF])#

**Special area code table storing**

In order to find the cheapest outside line group to be used from among the numbers starting with 6 digits when making an LCR call, the call is made in accordance with the special office code for each special area code specified by the time priority table.

Rather than the area code or office code being determined individually, a telephone number of 6 digits combining the special area code and special office code is stored.

In this table are stored 4 special area code (000-999) tables, and special area codes already stored are deleted by inputting [CONF].

The dial decided on for the special area code for NPX as shown below.

(N = 2-9, P = 0-1, X = 0-9)

1 + Area code : 1 - NPX - XXX - XXXX

NON 1 + Area code : NPX - XXX - XXXX

Special area codes not stored in this table cannot be used for LCR calls. The structure for the data storing in the table is as follows.

Special Area code Table Number 1#

Special area code DATA:

(000-999)# or Delete:[CONF]

Special Area code Table Number 2#

Special area code DATA:

(000-999)# or Delete:[CONF]

Special Area code Table Number 3#

Special area code DATA:

(000-999)# or Delete:[CONF]

Special Area code Table Number 4#

Special area code DATA:

(000-999)# or Delete:[CONF]

**NOTE 1:** For the system installation area it is necessary to set either 1 + Area or Non 1 + Area.

**NOTE 2:** LCR calls cannot be made from outside lines connected to a PBX.

FF8-4#-(1 - 4)#- (1 - 15)#-(000 - 999)#-(0 or 1)#

**Special office code table storing**

In order to find the cheapest outside line group to be used from among the numbers starting with 6 digits when making an LCR call, the call is made in accordance with the special office code for each special area code specified by the time priority table.

Rather than the area code or office code being determined individually, a telephone number of 6 digits combining the special area code and special office code is stored.

In this table are stored 4 special office code (000 - 999) tables corresponding to the 4 special area codes.

The dial decided on for the special office code is derived from XXX as shown below.

(N = 2 - 9, P = 0 - 1, X = 0 - 9)

1 + Area code : 1 - NPX - XXX - XXXX

NON 1 + Area code : NPX - XXX - XXXX

Special office codes not stored in this table cannot be used for LCR calls. The structure for the data storing in the table is as follows.

} (Time priority table number 1-15)

Time priority table number 15#

} (Special Office code number 1-4)

Special Office code Table Number 4#

Time priority table number 1#

Special office code DATA:

(000-999)#-(Store:1 or Delete:0)#

} (Time priority table number 1-15)

Time priority table number 15#

Special office code DATA:

(000-999)#-(Store:1 or Delete:0)#

*NOTE 1: For the system installation area it is necessary to set either 1 + Area or Non 1 + Area.*

*NOTE 2: LCR calls cannot be made from outside lines connected to a PBX.*

Special Office code Table Number 1#

Time priority table number 1#

Special office code DATA:

(000-999)#-(Store:1 or Delete:0)#

FF8-5#-(1-15)#-(1-48)#-(1-8)#

*PRIORITY  
TABLE*

*TRUNK  
GROUP*

### Time Priority Table setting

The time priority table is combined with the trunk group table and is devised for making calls from the cheapest trunk group within the designated time band.

There are 15 time priority tables and for each of them 8 trunk groups can be set for the 6 time bands. In addition, as the order or priority can be fixed within the programmed trunk groups, it is possible to divide them up even more precisely.

The data are set according to the programming of the LCR trunk group numbers, and for cancellations the CONF key is input as data.

#### Time Priority Table number 1#

1-8#: (7:00AM-8:00AM)  
 1# 2 2# 1 3# \_\_\_ 4# \_\_\_ 5# \_\_\_ 6# \_\_\_ 7# \_\_\_ 8# \_\_\_

9-16#: (8:00AM-5:00PM)  
 9# 2 10# 1 11# \_\_\_ 12# \_\_\_ 13# \_\_\_ 14# \_\_\_ 15# \_\_\_ 16# \_\_\_

17-24#: (5:00PM-8:00PM)  
 17# 1 18# 2 19# \_\_\_ 20# \_\_\_ 21# \_\_\_ 22# \_\_\_ 23# \_\_\_ 24# \_\_\_

25-32#: (8:00PM-12:00PM)  
 25# \_\_\_ 26# \_\_\_ 27# \_\_\_ 28# \_\_\_ 29# \_\_\_ 30# \_\_\_ 31# \_\_\_ 32# \_\_\_

33-40#: (0:00AM-7:00AM)  
 33# \_\_\_ 34# \_\_\_ 35# \_\_\_ 36# \_\_\_ 37# \_\_\_ 38# \_\_\_ 39# \_\_\_ 40# \_\_\_

41-48#: (Weekend)  
 41# \_\_\_ 42# \_\_\_ 43# \_\_\_ 44# \_\_\_ 45# \_\_\_ 46# \_\_\_ 47# \_\_\_ 48# \_\_\_

High ← PRIORITY → Low

5

#### (Time Priority Table number 1~15)

#### Time Priority Table number 15#

1-8#: (7:00AM-8:00AM)  
 1# \_\_\_ 2# \_\_\_ 3# \_\_\_ 4# \_\_\_ 5# \_\_\_ 6# \_\_\_ 7# \_\_\_ 8# \_\_\_

9-16#: (8:00AM-5:00PM)  
 9# \_\_\_ 10# \_\_\_ 11# \_\_\_ 12# \_\_\_ 13# \_\_\_ 14# \_\_\_ 15# \_\_\_ 16# \_\_\_

17-24#: (5:00PM-8:00PM)  
 17# \_\_\_ 18# \_\_\_ 19# \_\_\_ 20# \_\_\_ 21# \_\_\_ 22# \_\_\_ 23# \_\_\_ 24# \_\_\_

25-32#: (8:00PM-12:00PM)  
 25# \_\_\_ 26# \_\_\_ 27# \_\_\_ 28# \_\_\_ 29# \_\_\_ 30# \_\_\_ 31# \_\_\_ 32# \_\_\_

33-40#: (0:00AM-7:00AM)  
 33# \_\_\_ 34# \_\_\_ 35# \_\_\_ 36# \_\_\_ 37# \_\_\_ 38# \_\_\_ 39# \_\_\_ 40# \_\_\_

41-48#: (Weekend)  
 41# \_\_\_ 42# \_\_\_ 43# \_\_\_ 44# \_\_\_ 45# \_\_\_ 46# \_\_\_ 47# \_\_\_ 48# \_\_\_

High ← PRIORITY → Low

LCR PROGRAMING STEPS

CWT STRAP

STEP

1. ADDRESS: FF8-6# TRUNK GROUP TABLE SETTING  
Set up trunk groups first, they are used in the time priority tables
2. ADDRESS: FF8-5# TIME PRIORITY TABLE SETTING  
Set this 2nd, it will be used in the Area & Office tables
3. ADDRESS: FF8-1# AREA CODE TABLES  
Area Code tables require the Time Priority Tables
4. ADDRESS: FF8-2# OFFICE CODE TABLES  
Office Code tables require the Time Priority tables
5. ADDRESS: FF8-3# SPECIAL AREA CODES  
1-4, One Area Code per table
6. ADDRESS: FF8-4# SPECIAL OFFICE CODES  
Up to 1000 Office Codes per one Special Area Code, Special Office Codes - require the Time Priority Tables

OPTIONS:

ADDRESS: FF8-7# DIAL DELETE TABLE STORING

ADDRESS: FF8-8# DIAL ADD TABLE STORING

- NOTE:
- A. BE SURE TO PROGRAM THE DIAL "9" TO BE LCR (pg. 11)
  - B. VERIFY ON Pg. 34 - IF YOU DO or DO NOT WANT ALL STATIONS RESTRICTED TO LCR

C. Check Page 34 for more information

FX LIN TO DEL-1 ✓ DBS  
FF-8 LCR mode

FF8-6#-(1-8)#-(1-8)#-(1-32)#

**Trunk Group Table Setting**

When making an LCR call the line within the cheapest trunk group table at the time of calling is used.

There are a total of 8 trunk group tables in each of which 8 lines can be set.

The order of priority for a trunk group is determined by the time priority table.

There is also an order of priority for the lines within each table so that they can be divided up even more precisely.

Normally they are put together in trunk groups of the same type as with MCI and SPRINT.

Trunk Group table

LCR trunk group

Data: Trunk port number (1 - 32)

1# (Group 1):

1# 6 2# 5 3# 4 4# 3 5# 2 6# 1 7#    8#   

2# (Group 2):

1# 8 2# 7 3#    4#    5#    6#    7#    8#   

3# (Group 3):

1#    2#    3#    4#    5#    6#    7#    8#   

4# (Group 4):

1#    2#    3#    4#    5#    6#    7#    8#   

5# (Group 5):

1#    2#    3#    4#    5#    6#    7#    8#   

6# (Group 6):

1#    2#    3#    4#    5#    6#    7#    8#   

7# (Group 7):

1#    2#    3#    4#    5#    6#    7#    8#   

8# (Group 8):

1#    2#    3#    4#    5#    6#    7#    8#   

FF8-7#-(1-8)#-(Max. 10 digit numbers)#

**Dial delete table storing**

The numbers it is desired to delete from the heads of the numbers input into each LCR trunk group are stored. Up to a maximum of 16 digits can be deleted.

These digits are deleted from the heads of numbers only when the dialed number and the number stored correspond and are not dialed out to the trunk line.

Numbers already stored are canceled by inputting CONF.

LCR trunk group number: 1#

(Dial delete number/Max 16 digits)#

↳ (Special area code table number 1-15)

LCR trunk group number: 8#

(Dial delete number/Max 16 digits)#

NOTE: May not storing "\*" and "#" data, that even use the FF11 and FF12 keys.



FF8-8#-(1 - 8)#-(Max. 16 digit numbers)#

**Dial add table storing**

The numbers it is desired to add to the heads of the dial numbers input into each LCR trunk group are stored.

Up to a maximum of 16 digits can be added for dialing. When dialing using a stored LCR trunk group, the stored numbers are sent out first. Numbers already stored are canceled by inputting CONF.

In addition, "\*" and "#" are stored by using the FF11 and FF12 keys.

And pause data are stored by using the [REDIAL] Key.

LCR trunk group number: 1#

(Dial add number/Max 16 digits)#

› (Special area code table number 1-15)

LCR trunk group number: 8#

(Dial add number/Max 16 digits)#

3 - 9 Copy mode (Trunk and extension specification copy mode)

*When programming it is necessary to set the same items for a large number of telephones.*

*This is likewise the case when setting for outside lines.*

*Therefore the trunk setting mode and extension mode are provided with a copying function so that the contents set for one telephone can be copied into other extensions.*

*The same is also the case when copying programmed specifications for outside lines.*

FF9-1#-(1 - 32)#-(1 - 32)#-#

**Trunk specification copy mode**

The contents which have already been programmed for one trunk port are copied into another trunk port.

After this reprogramming is easily done by simply changing the points which are different from the contents in the original.

All the items programmed are copied with the exception of the private port number.

NN#: Trunk port number originating copy (1 - 32)

NN##: Trunk port number receiving copy (1 - 32)

#: Copy implementation

FF9-2#-(1 - 72)#-(1 - 72)#-#

**Extension specification copy mode**

The contents which have already been programmed for one extension are copied into another extension.

After this reprogramming is easily done by simply changing the points which are different from the contents in the original.

All the items programmed are copied with the exception of the extension number, terminal classification, BLF port number and lock out code.

NN#: Ext. port No. originating copy (1 - 72) - #

NN##: Ext. port No. receiving copy (1 - 72) - #

#: Copy implementation

FF9-3#-(1 - 72)#-(1 - 72)#-#

**FF Key function copy mode**

The programmed data entered in FF5 mode for an extension can be copied to other extensions. Only the data for LED type keys will be copied. After you have entered the source extension port number (FROM) the DBS requests the destination port number (TO).

At this point DBS verifies that the port numbers entered are correct and you are given the choice to abort the copy mode if you so choose.

If the port numbers you have entered are incorrect you can step backwards by pressing the volume up key repeatedly until you are at the entry point which needs correction.

NN#: Ext. port No. originating copy (1 - 72) - #

NN##: Ext. port No. receiving copy (1 - 72) - #

#: Copy implementation

TO 3C COPY  
COPY 2

**3 - 10 Spd number mode (Speed dial number setting mode)**

For storing the system speed number or personal speed number, the DSS 172 (DSS console)(VB-43320) connected to the attendant's telephone are used.

Remote Maintenance

Input	Input character for Remote Maintenance
0-9	0-9
*, #	*, #
Pause "-"	P -
Start Account	B
Auto	A
Conf.	C

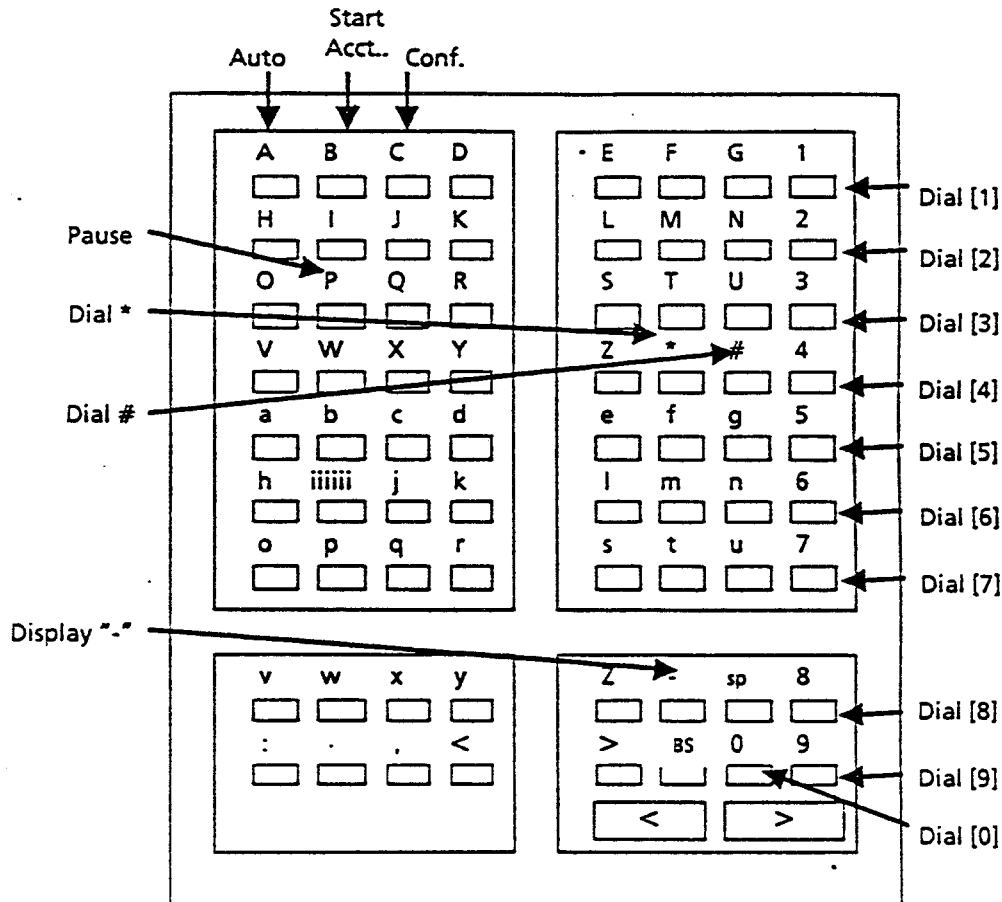

Fig 10-1 DSS/72 console(VB-43320)

FF10-1#-(00 - 89)#

**System SPD mode**

System Speed Dial numbers 00 - 89 can be programmed from the attendant telephone.

It is also possible to enter names of up to 16 characters in each SPD numbers using FF6 key (See Page, 52)

FF10-1#-NN(00 - 89)#-(Telephone Number)#

NN# : System SPD Dial number

[CONF]# : For clear previous data

FF10-2#-(01 - 72)#

**Personal SPD mode**

Personal Speed dial number 90 - 99 can be programmed from the attendant telephone.

FF10-2#-NN(01 - 72)#-SS#(90-99)#-(Telephone Number)#

NN# : Port number

SS# : Personal SPD dial number

[CONF]# : For clear previous data

## Chapter 4 Remote Maintenance

### 4-1 Remote Maintenance Outline

Programming can be done from outside the system through telephone lines other than the attendant's telephone. In such a case the programming is done from data terminals available on the market and the like. In addition to the normal programming when operating from outside, it is also possible to check all the set DATA by memory dumping.

### 4-2 Starting Remote Maintenance

There are two methods for starting remote maintenance. The first method is to do the operation completely from outside by using the DISA function for achieving the remote maintenance status after having telephoned the system from outside. The second method is to put the system in hold with the attendant's telephone to achieve the remote maintenance status.

#### A. Remote maintenance mode with DISA

After the system has answered the call made to the trunk line specified in the systems DISA, the DISA function can be used by inputting the DISA code (not necessary with some system settings). Then the remote maintenance processing is made possible having input the special remote maintenance number (#6) and the 4 digit code for remote controlled maintenance (code 9999 when not set).

#### B. Remote maintenance mode by attendant's telephone

Having put on hold after calling the party which is to carry out the remote maintenance with the attendant's telephone, the remote maintenance processing is enabled by having the special remote maintenance number input.

The remote maintenance processing is then made possible by inputting the special remote maintenance number (#6) and the 4 digit code.

In either of the above cases the following message is output on the remote side to indicate that it is now in the remote maintenance mode.

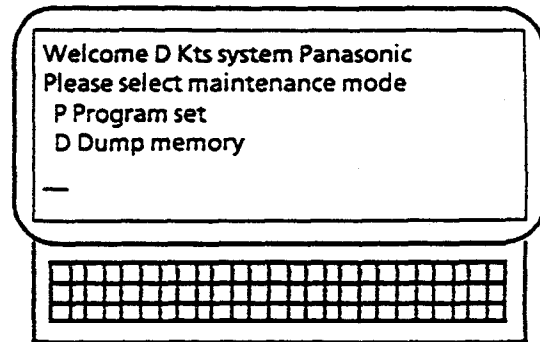

### 4-3 Remote Maintenance Processing

There are 3 modes for the remote maintenance processing.

When the remote maintenance mode starts, it enters each of the following processing modes.

INPUT "[P]"      Programming  
INPUT "[D]"      Memory dumping  
INPUT "Ctrl [Z]" Remote maintenance complete

#### 4-4 Effective Number of Digits for Input Data

When the number input is less than 3 digits, 0 is entered to make a number of 3 digits.  
When it is more than 3 digits, the last 3 digits only are taken while the rest are disregarded.

1 → → → 001,      10 → → → 010  
1000 → → → 000,    12345 → → → 345

This restriction is common to all the remote maintenance modes.

#### 4-5 Outline of Memory Dump Function

During maintenance and the like the systems software data can be confirmed from outside. This is extremely useful when a breakdown occurs for example.

By means of memory dump data can be output to the data terminal CRT or printer when the table name for the memory area you want displayed and the number of display bytes are specified.

#### 4-6 Starting Memory Dump Function

When the D command is input on the initial screen for remote maintenance, the following message is output to the remote side.

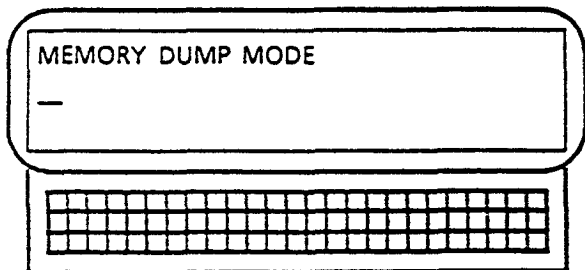

After the message has been displayed, the following prompt is displayed while waiting for data input.

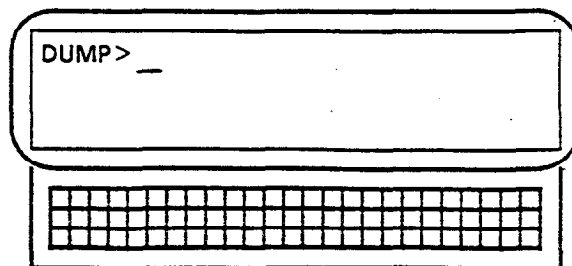

The memory dump area is specified in accordance with the table number and the number of display bytes. If the number of bytes is not specified, 100(H) bytes are automatically displayed.

DUMP > table name + offset address - number of bytes output <CR> 4 letters : 0 - 10, A - F(H) 4 letters : 0 - 10, A - F(H)

If the specified table name is intended for something other than memory dump, the error message is displayed.

#### 4-7 Completion of Memory Dump

The memory dump operation is completed by inputting "[Ctrl] + [C]" to return to the remote maintenance mode.

#### 4-8 Completion of Remote Maintenance

The remote maintenance operation is completed by inputting "[Ctrl] + [Z]". If "[Ctrl] + [Z]" is input while programs are being selected or data are being entered, it becomes the remote maintenance start mode. So when "[Ctrl] + [Z]" is input again in this status, the outside line being used for the remote maintenance is released and the remote maintenance is completed. In the following cases also the outside line is

- A. When data have not been input for more than 16 minutes
- B. When the outside line is cut off automatically released to complete the remote maintenance operation.

Section 700

Issue 1

July 1990

S-DBS 308/616 (V1.0)

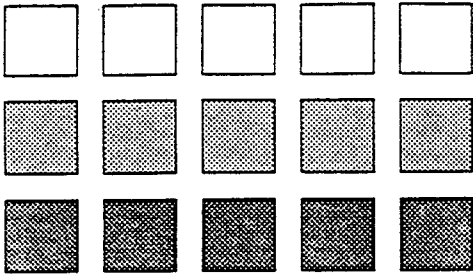

# Operating Instructions

Small Digital Business System  
308/616

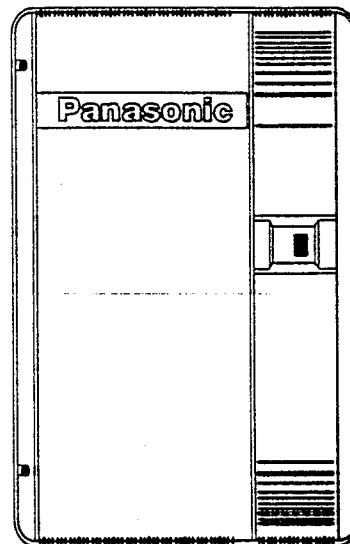
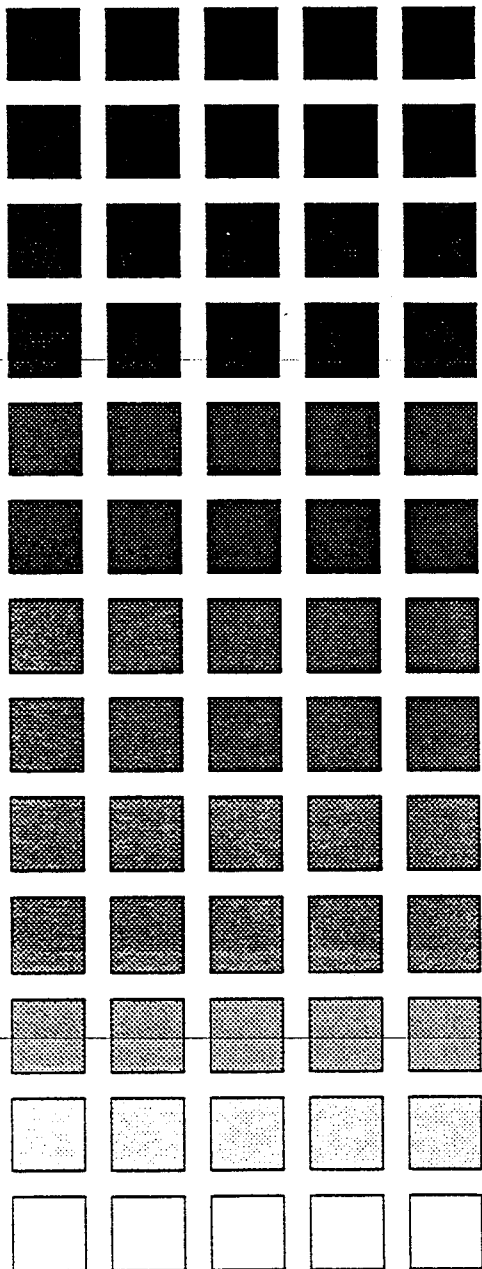

**Panasonic®**

---

The information in this document is subject to change without notice and should not be construed as a commitment by the Panasonic Communications & Systems Company (PCSC). Furthermore, PCSC reserves the right, without notice, to make changes to equipment design as advance in engineering and manufacturing methods warrant.

7



## **FCC RULES AND REGULATIONS (Part 68)**

In compliance with the requirements of Part 68 of the FCC Rules and Regulations for connection of terminal equipment to the telephone network, and for your convenience, the following information is presented.

### **Notifying the Telephone Company**

When connecting or disconnecting the terminal equipment to the telephone network, inform the telephone company of the particular line (s) for connection, the FCC registration number and ringer equivalence number of the registered terminal equipment.

### **FCC Registration Numbers**

<b>Model Numbers</b>	<b>Key System</b>	<b>Hybrid System</b>
<b>VB-42010 (DBS308)</b>	<b>ACKUSA-61853-KF-E</b>	<b>ACKUSA-61855-MF-E</b>
<b>VB-42020 (DBS616)</b>	<b>ACKUSA-61854-KF-E</b>	<b>ACKUSA-61856-MF-E</b>

When enabling Pooled Trunk Access, inform the telephone company or a Panasonic service center of the MF-E FCC Registration number. According to FCC rules, Pooled Trunk Access is regarded as one of the distinguishing features of a PBX as opposed to a key telephone system.

### **RINGER EQUIVALENCE NUMBER (REN) 0.5 B**

The REN determines the number of devices you may connect to your telephone line and still have all those devices ring when your telephone number is called. In most, but not all areas, the sum of the REN's of all devices connected to one line should not exceed five (5.0). You should contact your local telephone company to determine the maximum REN for your calling area.

Service order code	9.0F
Network address signaling code	E
Facility interface code	02LS2 (2 wire/Loop start)
Required network interface code	RJ25C

### **Connection to a Party Line or Coin Operated Telephone Line**

**Direct Connection to a Party Line or Coin Operated Telephone Line Is Prohibited.**

If you are on a party line, check with your local telephone company for further information.

### **Incidence of Harm to the Telephone Lines**

Should terminal equipment cause harm to the telephone network, the telephone company shall, where practical, notify the customer that temporary discontinuance of service may be required. However, where prior notice is not practical, the telephone company may temporarily discontinue service forthwith, if such action is reasonable in the circumstances. In case of un-notified temporary discontinuance of service, the telephone company shall:

- (A) Promptly notify the customer of such temporary discontinuance of service.
- (B) Afford the customer the opportunity to correct the situation which gave rise to the temporary discontinuance.
- (C) Inform the customer of the right to bring a complaint to the Commission pursuant to the procedures set out in Part 68 of the FCC Rules and Regulations.

### **Compatibility of the Telephone Network and Terminal Equipment**

- (A) Availability of telephone information

Technical information on interface parameters and specifications not set by FCC Rules, including the number of ringers which may be connected to a particular telephone line to permit terminal equipment to operate in a manner compatible with telephone company communications facilities, shall be provided by the telephone company upon customer's request.

- (B) Changes in telephone company communications facilities, equipment, operations and procedures.

The telephone company may make changes in its communications facilities, equipment, operations or procedures, where such action is reasonably required in the operation of its business and is not inconsistent with the rules and regulations in FCC Part 68. If such changes can be reasonably expected to render any customer's terminal equipment incompatible with telephone company communications facilities or require modification or alteration of such terminal equipment or otherwise materially affect its use or performance, the customer shall be given adequate notice in writing to allow the customer an opportunity to maintain un-interrupted service.

### **Hearing Aid Compatibility**

This system is hearing-aid compatible.

### **Automatic Dialers**

#### **When Programming Emergency Numbers or Making Test Calls to Emergency Numbers:**

- (A) Remain on the line and briefly explain to the dispatcher the reason for the call.
- (B) Perform such activities in the off-peak hours, such as early morning or late evening.

### **Responsibility of Grantee (Manufacturer) of Registered Equipment**

**The Grantee or its agent shall provide the user of the registered equipment with the following:**

- (A) Instructions concerning installation, operation and repair procedures, where applicable.
- (B) Notification that the registered terminal equipment may not be used with party lines or coin lines.
- (C) Instruction indicating that when trouble is experienced the customer shall disconnect the registered equipment from the telephone line to determine whether it is malfunctioning. If so, the use of such equipment shall be discontinued until the problem has been corrected.
- (D) If connections other than RJ25C are needed, contact the local telephone company.

### **Product Safety**

**Please Observe the Following Guidelines to Assure the Safe Use of Your Telephone**

- (A) This product is an electrical device and can be hazardous if immersed in water.
- (B) To avoid the risk of electrical shock, do not use this unit while in the bathtub, shower, or when wet. If you accidentally drop the unit into water, unplug it first, then retrieve it by pulling the cord.
- (C) The telephone should not be exposed to heat sources, direct sunlight, extreme temperatures, moisture, strong vibrations, greasy or dusty environments.
- (D) Never attempt to insert wires, pins or similar objects in the vents or openings of the telephone.
- (E) Never clean the telephone with benzol, paint thinner or other solvent materials.
- (F) Never install telephone wiring during a lightning storm.
- (G) Never install telephone jacks in a wet area unless they are specifically designed for that purpose.
- (H) Never touch un-insulated telephone wires or terminals unless the telephone line has been disconnected at the network interface.

### **Radio Interference (Part 15)**

**Warning** - This unit generates, uses and can radiate radio frequency energy. If not installed and used in accordance with the instructions manual, the unit may cause radio interference. The Unit has been tested and found to comply with the limits for a Class A digital device pursuant to Part 15 of FCC Rules, which are designed to provide reasonable protection against such interference when operated in a commercial environment.

Operation of this equipment in a residential area is likely to cause harmful interference in which case the user at his own expense will be required to take whatever measures necessary to correct the interference.

If necessary, the user should consult the dealer or an experienced radio/television technician for additional suggestions.

The user may find the following booklet prepared by the Federal Communications Commission helpful:

#### **Something about Interference**

This booklet is available from the FCC local regional offices.

# Table of Contents

FCC RULES AND REGULATIONS (Part 68) .....	iii
Notifying the Telephone Company .....	iii
RINGER EQUIVALENCE NUMBER (REN) 0.5 B.....	iii
Connection to a Party Line or Coin Operated Telephone Line .....	iii
Incidence of Harm to the Telephone Lines .....	iv
Compatibility of the Telephone Network and Terminal Equipment.....	iv
Hearing Aid Compatibility .....	iv
Automatic Dialers .....	iv
Responsibility of Grantee (Manufacturer) of Registered Equipment.....	v
Product Safety .....	v
Radio Interference (Part 15) .....	v
INTRODUCTION .....	1
S-DBS HYBRID SYSTEM * <Programming Required> .....	2
DATA TERMINAL PROGRAMMING .....	3
PARTS AND FEATURES .....	4
SYSTEM CONFIGURATION .....	5
FLEXIBLE FUNCTION (FF) KEYS .....	6
How to program the FF keys .....	7
How to program the One-Touch keys .....	7
ADJUSTING DISPLAY CONTRAST AND VOLUME LEVEL .....	8
POOLED TRUNK ACCESS GROUP .....	9
HEADSET MODE * <Programming Required> .....	10
INTERNAL DIAL TONE STOP * <Programming Required> .....	10
PAGING ZONES .....	10
PLACING OUTSIDE LINE CALLS .....	11
Making a Call .....	11
Dial CO (Outside Line) Access .....	11

To access a direct dial outside line .....	11
Pooled Trunk Access * <Programming Required> .....	12
To access a pooled trunk group line with a one-touch key .....	12
Flash Key * <Programming Required> .....	12
<b>INTERCOM CALLS</b> .....	<b>13</b>
Attendant Calls .....	13
Other Extensions .....	13
To make a voice call .....	13
To change to a tone call .....	13
Answering Calls from Other Extensions .....	14
Hands-Free Answer Back .....	14
To answer a Voice call without picking up the receiver .....	14
Intercom Hold .....	14
To place a call on Hold .....	14
To release a call on Hold .....	15
Call Waiting * <Programming Required> .....	15
To set Call Waiting .....	15
To answer Call Waiting during an outside line/internal call .....	15
<b>ANSWERING OUTSIDE LINE CALLS</b> .....	<b>16</b>
Automatic Answer .....	16
To answer an outside line call on a ringing telephone .....	16
To answer an outside call on a telephone that is not ringing .....	16
Call Pickup Directed .....	16
Call Pickup Group .....	17
<b>HOLDING CALLS</b> .....	<b>18</b>
Outside Line Hold .....	18
To place a call on Exclusive Hold .....	18
To release a call from Exclusive Hold .....	18
To place a call on System Hold .....	18
To release a call from System Hold .....	18
<b>CONFERENCE CALLS</b> .....	<b>19</b>
To add on an outside line .....	19
To add on an extension .....	19
To exit a conference call .....	19
Privacy Release .....	20

NIGHT KEY * <Use the attendant's phone> .....	20
To change from day mode to night mode .....	20
TRANSFERRING CALLS .....	21
On-Hook (Automatic) Transfer * <Programming Required> .....	21
To transfer a screened call .....	21
To transfer an unscreened call .....	21
Manual Transfer .....	22
BUSY/NO ANSWER MODE .....	23
Busy Override * <Programming Required> .....	23
Call Forwarding .....	23
To set Call Forwarding .....	23
To cancel Call Forwarding .....	24
Do-Not-Disturb .....	24
To set Do-Not-Disturb .....	24
To cancel Do-Not-Disturb .....	24
Message Waiting/Call Back Request .....	25
To leave a Message Waiting/Call Back Request .....	25
To answer a Call Back request .....	25
Trunk Queuing .....	26
To set Trunk Queuing .....	26
To respond to a Trunk Queuing alert tone .....	26
Off-Hook Voice Announce * <Programming Required> .....	27
To make a Voice Announcement .....	27
To answer a Voice Announcement (Talk-Back Key) .....	27
AUDIBLE FEATURES .....	28
Alarm .....	28
To set the Alarm .....	28
To cancel the Alarm .....	28
Delayed Ring/No Answer * <Programming Required> .....	28
Paging * <Programming Required> .....	29
Zone Paging .....	29
All-Zone Paging .....	30
Background Music (BGM) .....	30
Meet-Me Answer .....	30
To answer a paged call .....	30

Outside Line Off-Hook Signal * <Programming Required> .....	30
<b>DIALING ALTERNATIVES</b> .....	<b>31</b>
Redial .....	31
To check a redialed number .....	31
Save/Repeat Dial .....	32
To save a dialed number .....	32
To check a saved number .....	32
To repeat a dialed number .....	32
Personal Speed Dial (PSD) .....	33
To store PSD Numbers to a One-Touch key .....	33
To access a stored PSD number .....	34
To check a stored PSD number .....	34
To cancel a stored PSD number .....	34
System Speed Dial (SSD) .....	35
To store SSD Numbers * <Available only on extensions 10 and 11> .....	35
To access a stored SSD number .....	36
To check an SSD number * <Available on all extensions> .....	36
To cancel a stored SSD number .....	36
Assigning Two SSD Codes to a Single One-Touch Key .....	37
DTMF Signal Conversion .....	38
<b>DATA SECURITY * &lt;Programming Required&gt;</b> .....	<b>38</b>
<b>ACCOUNT CODES/SMDR</b> .....	<b>39</b>
Account Code Station Message Detail Recorder (SMDR) .....	39
To enter an Account Code before dialing out .....	39
To enter an Account Code during an outside call .....	40
<b>TOLL RESTRICTIONS</b> .....	<b>41</b>
Toll Restriction System * <Programming Required> .....	41
Station Lockout * <Programming Required> .....	41
To set or reset Station Lockout .....	41
To program Station Lockout code * <Available only on extensions 10, 11> .....	42
<b>DOOR BOX</b> .....	<b>43</b>
Door Boxes A and B * <Programming Required> .....	43
To call a door box .....	43
To answer a door box call .....	43

Door Opener.....43  
    Speaking to a door box caller.....43  
    Opening a door box without speaking to caller .....43  
Sensor \* <Programming Required> .....44  
    Cancelling a warning tone from an extension.....44  
Index.....46

---



## INTRODUCTION

The Panasonic S-DBS 308/616 has a smaller, compact KSU, 19" L x 4 1/2" H x 12 1/2" W, that can be hung on a wall or placed in an out-of-the-way space. Despite its convenient size the S-DBS has many of the features of a larger KSU, in addition to a Hybrid telephone system that gives you the capability of a dual port operation using a key telephone and single line devices.

The S-DBS is also hearing-aid compatible with a proprietary telephone.

There are four models of S-DBS telephones:

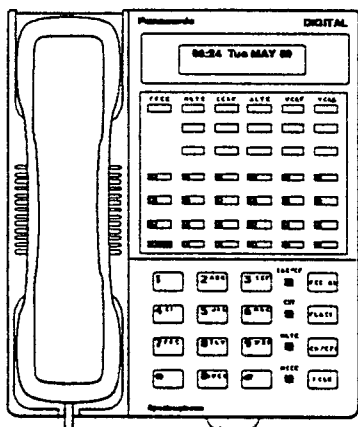

VB-43233  
34 Key Speakerphone w/LCD  
Used for Extensions 10, 11

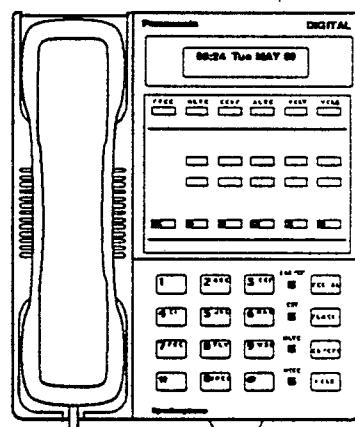

VB-42213  
16 Key Speakerphone w/LCD

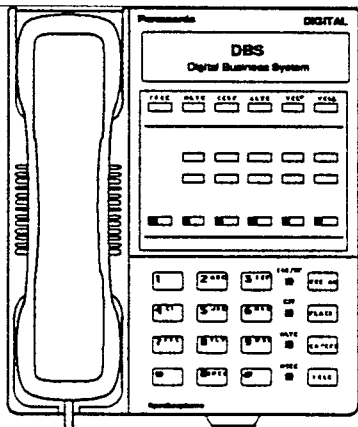

VB-42211  
16 Key Speakerphone

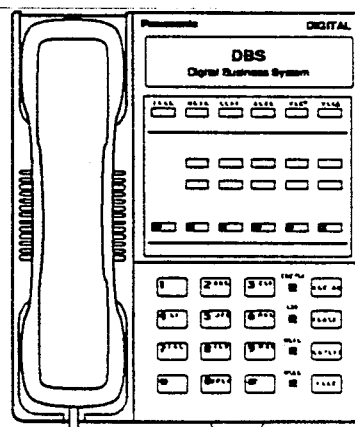

VB-42210  
16 Key Basic Phone w/HFAB

## **S-DBS HYBRID SYSTEM \* <Programming Required>**

The small DBS introduces a brand new feature in telephone systems: A dual port connection. The S-DBS Hybrid System allows you to connect both a digital telephone and a single line device to the same extension port at the same time. A cordless telephone, answering machine or Fax machine can be used alternatively with a key telephone once the system is set in one of three modes as follows:

**A mode:** Both the key telephone and the single line device are operable which means that you have the option of transferring calls from your key telephone to your cordless phone and back again by pressing the **HOLD** key on the key (proprietary) telephone or hook flashing on the SLT and dialing **60**. Only the key telephone rings and on the SLT the intercom dial tone is a stutter tone.

**B mode:** In B mode you can leave the system unattended in either day or night mode because the key telephone does not operate. The blinking Do-Not-Disturb LED on the key telephone indicates that there is no dial tone. Only the single line device is operable.

For example, you can set up an answering machine to take calls for the system or for each telephone. To go from A to B mode and have an answering machine record your calls for the system, put the system on night mode from the attendant's telephone by pressing the **ON/OFF** key, # key and entering **52**. During the day you have the option, among others, of switching operation from your stationary single line telephone to a cordless phone by entering **69** from your extension.

**C mode:** In C mode you can set the dual extension port for a single line device only to set up a Fax machine, for example, or a single line telephone.

**Redial -** See instructions for the key telephone in this manual. For the SLT see instructions in the Station User Guide, Section 750 under Single Line Telephone.

**Station lockout -**

See instructions in this manual.

**Programming extension features -**

Ask your authorized dealer.

## **DATA TERMINAL PROGRAMMING**

In addition to programming from the key terminal you can also program the system using a data terminal. A computer gives you the advantage of checking the programming steps on the display before making final changes. At every stage in the programming there are help screens available by pressing the "H" key on the terminal. Ask your authorized dealer for more details.

## PARTS AND FEATURES

1. Receiver
2. Speaker for ringing, tone and voice
3. Dialing Keys
4. **REDIAL** Key
5. **FLASH** Key
6. **ON/OFF** Key & LED
7. **HOLD** Key

### Fixed Function Keys:

8. -DND/CF LED
9. -EXT LED
10. -MUTE LED
11. -MSGE LED
12. Line/FF Keys
13. Line LED
14. One-Touch Keys
15. Display
16. **PROG** Key
17. **MUTE** Key
18. **CONF** Key
19. **AUTO** Key
20. **VOL ▼** Key, **VOL ▲** Key

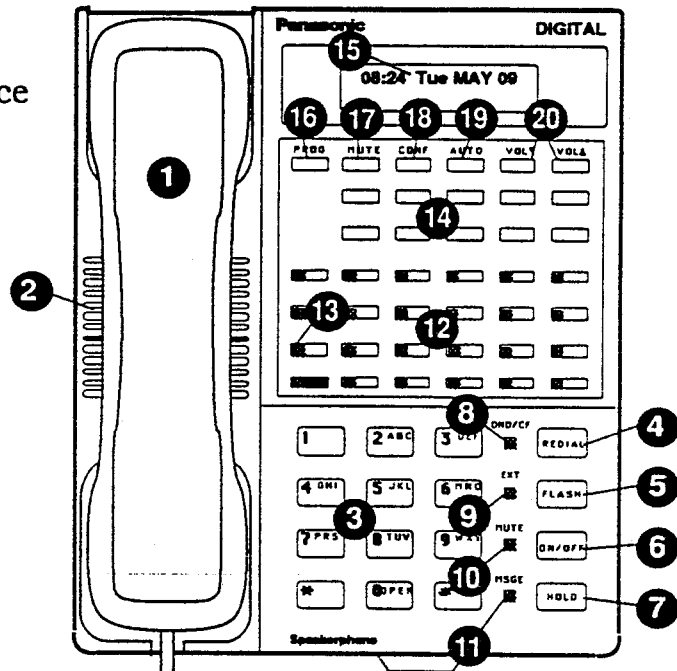

Model shown above: VB-43233  
DSS Telephone for Extensions 10 and 11

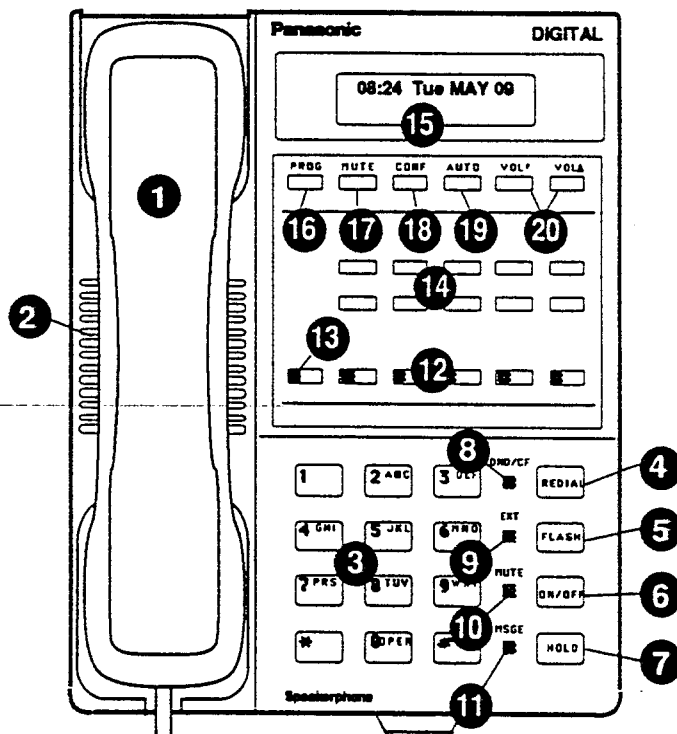

Model shown above: VB-42213

## SYSTEM CONFIGURATION

You can connect four types of DBS extensions to the two main cabinets 308 and 616.

System	Number of outside lines (Trunk port)	Number of Telephones (Extension ports)		DSS Extension	Door Phone
		Digital	Analog (SLT)		
DBS308	3	8	6	2	2
DBS616	6	16	14	2	2

\* Each system accommodates up to 2 DSS telephones VB-43233.

\*\* Outside lines are divided into 4 groups: 9, 81, 82 and 83.

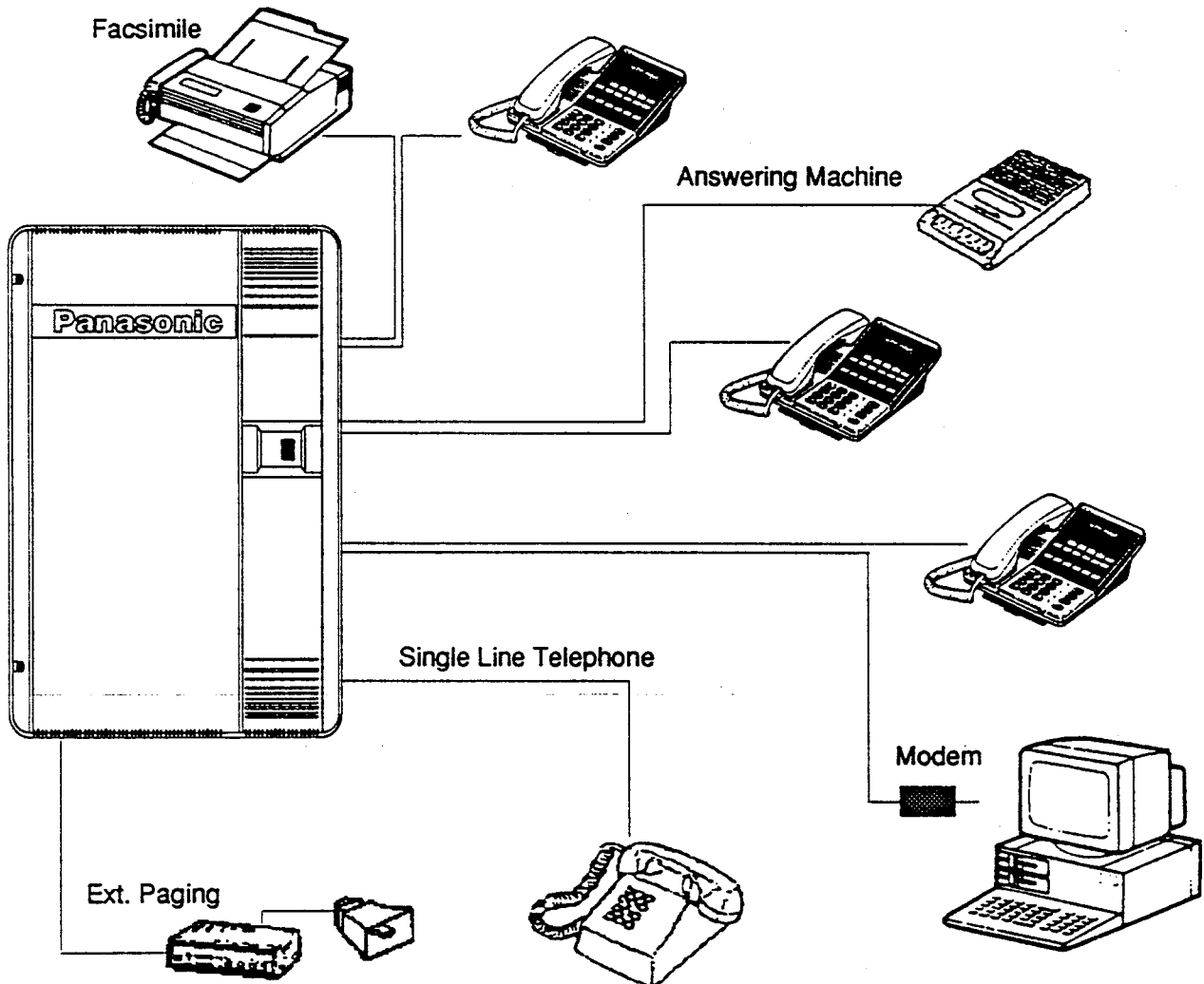

## FLEXIBLE FUNCTION (FF) KEYS

The DSS telephone has a total of 24 keys. Keys 1-6 are generally assigned as CO (outside) lines. However, if all six keys are not assigned as CO lines, some of them can be used as additional FF keys. Keys 7-21 are extension numbers, key 22 is Call Pickup Group, key 23 is All-zone Paging and key 24 is the night key.

The LED functions on the CO line keys, but does not light on the FF keys.

Some of the following FF key features can also be programmed on One-Touch keys and are noted as such.

FEATURES	KEY OPERATION	ONE-TOUCH KEY	PAGE
Attendant	0	X	13
Call Forwarding	72	X	23
Call Pickup Directed	79	X	16
Call Pickup Group	70	X	17
Call waiting	3	X	12
Data Security	AUTO, AUTO, #		38
Dial CO Access	88N	X	11
Dial Tone Stop/Internal	#50	X	10
Display Contrast	#	X	8
Do-Not-Disturb	73	X	24
Door Box	61 or 62	X	43
Headset	#51	X	10
Meet-Me Answer	77	X	30
Message Waiting	2	X	25
Mode A-B Change	69	X	2
Night Key	#52	X	20
Paging Zone 1	#01	X	29
Paging Zone 2	#02	X	29
Paging Zone 3	#03	X	29
All-Zone Page	#00	X	30
Pooled Trunk Access	9 or 81 - 83	X	9
Repeat	AUTO, *		32
Save	AUTO, AUTO, *		32
SMDR	#93	X	39
Station Lockiout	74	X	41
Tone Calls	1	X	13
Trunk Queuing	2	X	26
Off-Hook Voice Announce	5	X	27
Off-Hook Voice Announce Answer	*3	X	27

**How to program the FF keys:**

1. Press **ON/OFF** key
2. Press **PROG** key
3. Press **FF** key
4. Enter key code (4 digits maximum)
5. Press **HOLD** key
6. Press **ON/OFF** key

**How to program the One-Touch keys:**

1. Press **ON/OFF** key
2. Press **PROG** key
3. Press One-Touch key (each telephone has 10 One-Touch keys).
4. Dial number (16 digits maximum)
5. Press **HOLD** key
6. Press **ON/OFF** key

## **ADJUSTING DISPLAY CONTRAST AND VOLUME LEVEL**

### **Display Contrast**

---

You can adjust the contrast to 16 different levels.

1. With receiver in place press # key.
2. Press VOL ▼ to dim the display.
3. Press VOL ▲ to brighten the display.

### **Volume Levels**

You can adjust the volume to five different levels.

#### **Ring Volume**

While the phone is ringing

1. Press VOL ▼ to lower the sound level of the ring.
2. Press VOL ▲ to raise the sound level of the ring.

#### **Dial Tone Volume**

While sound is coming from the speaker

1. Press VOL ▼ to lower the voice level of the speaker.
2. Press VOL ▲ to raise the voice level of the speaker.

#### **Receiver Volume**

While talking on the telephone

1. Press VOL ▼ to lower the level of your voice.
2. Press VOL ▲ to raise the level of your voice.

**NOTE:** Voice level on the receiver will return to the normal level after you hang up.



## **POOLED TRUNK ACCESS GROUP**

You can install from 1-3 or 1-6 outside lines in the system and then divide the lines into four groups: local calls; low-cost; long distance; and data communications.

Each group has a fixed code, **9** or **81**, **82** and **83**, to access lines in that group. Entering one of these codes automatically opens a line within the Pooled Trunk Access Group.

Or you can store the group code (Pooled Trunk Access Code) in an FF key or on a One-Touch key and access the feature that way.

**NOTE:** To operate this phone system as a Hybrid System, modifications must be made by a qualified dealer for proper re-configuration and registration procedures.

## **HEADSET MODE \* <Programming Required>**

A headset can be connected to any phone in the system and the intercom dial tone can be turned off so that it cannot be heard through the headset.

To set or cancel headset mode:

1. Connect Headset to telephone
2. Press **ON/OFF** key
3. Dial # **51**
4. Press **ON/OFF** key

**NOTE:** Use only an electret Headset.

## **INTERNAL DIAL TONE STOP \* <Programming Required>**

To set or cancel intercom dial tone stop:

1. Press **ON/OFF** key
2. Dial # **50**
3. Press **ON/OFF** key

Ask your authorized dealer for more details.

## **PAGING ZONES**

Internal paging uses the speakers in the extension phones.

While one extension can belong to several paging zones, only 3 paging zones are allowed in each system.

You can use the telephone speakers for all the paging groups. If the location is noisy and requires higher volume, you can add peripheral equipment to the system.

## **PLACING OUTSIDE LINE CALLS**

### **Making a Call**

1. Press a line key. The **ON/OFF** key will light
2. Dial the telephone number
3. Pick up receiver

### **Dial CO (Outside Line) Access**

#### **To access a direct dial outside line**

1. Pick up the receiver  
OR  
Press **ON/OFF** key
2. Listen for intercom dial tone
3. Get external dial tone by dialing the access code **88** plus the line number.
4. Dial the telephone number. The dialed number will appear on the display.

**Pooled Trunk Access \* <Programming Required>**

**To access a pooled trunk group line with a one-touch key**

1. Pick up receiver

OR

Press **ON/OFF** key

2. Get outside dial tone by dialing access code **9** or **81, 82** or **83**.
3. Dial the telephone number. The dialed number will appear on the display.

**NOTE:** To operate this phone system as a Hybrid System, modifications must be made by a qualified dealer for proper re-configuration and registration procedures.

**Flash Key \* <Programming Required>**

To make another call without either replacing the receiver or pressing the **ON/OFF** key to get new dial tone.

1. Get dial tone by briefly pressing the **FLASH** key. To disconnect from PBX lines press the **FLASH** key for more than one second.

## INTERCOM CALLS

### Attendant Calls

You can call the attendant on extension 10 from any other extension by pressing the 0 (OPER) key.

1. Pick up the receiver

OR

Press **ON/OFF** key

2. Press **0**

### Other Extensions

Calls to other extensions can be either voice or tone. The system is set for voice call, but you may change to tone by pressing 1 after dialing an extension number. Once changed the only way you can revert back to voice is to hang up and redial the extension number. On an SLT only tone calls are possible.

### To make a voice call

1. Pick up the receiver

OR

Press **ON/OFF** key

2. Key in the extension number. For the 308 the extension range is 10 to 17. For the 616 the extension range is 10 to 25. The EXT LED will light red on the phone of the person you call and a splash tone will be heard followed by your voice.

### To change to a tone call

1. Press **1** during an intercom voice call. The EXT LED will blink red on your phone and a ring pattern will begin on the called extension.

**NOTE:** Mute key of the person you call must be set to **ON**.

### Answering Calls from Other Extensions

1. Pick up the receiver

OR

Press the **ON/OFF** key

2. The EXT LED lights red

3. The number of the calling extension will appear on display.

### Hands-Free Answer Back

#### To answer a Voice call without picking up the receiver

1. The MUTE LED must be off to talk without picking up the receiver.

2. If the MUTE LED is on, press the **MUTE** key to turn it off.

### Intercom Hold

You can answer one other intercom call by placing your original call on HOLD. You can, then, toggle back and forth between the two calls creating a broker's hold.

#### To place a call on Hold

1. Press **HOLD** key

2. The EXT LED will flash red and the extension number of the first call will be replaced on the display by the extension number of the second call.

**To release a call on Hold**

1. Press **HOLD** key.
2. The **EXT LED** will stop flashing.

**NOTE:** There is no Hold recall for Intercom Hold.

**Call Waiting \* <Programming Required>**

**To set Call Waiting**

1. Press **ON/OFF** key
2. Dial the extension number and wait for the busy signal.
3. To send the Call-Wait tone to the extension, press 3 while you can still hear the busy signal. The **EXT LED** of the called party will flash red.

**To answer Call Waiting during an outside line/internal call**

1. Press **HOLD** key
2. The first call is held and you are automatically connected to the waiting caller. The new extension number will appear on the display.

**NOTE:** Call Waiting is automatically canceled once you replace the receiver. This feature is not active if the called extension is set to DND; already has a call on hold; is ringing or is on a conference call. An alert tone will signal that Call Waiting is not in effect.

## **ANSWERING OUTSIDE LINE CALLS**

### **Automatic Answer**

#### **To answer an outside line call on a ringing telephone**

1. Pick up the receiver when the line LED blinks red. The LED will light green.

OR

Press **ON/OFF** key. The key will then light green

---

#### **To answer an outside call on a telephone that is not ringing**

1. Pick up the receiver
2. Press the line key that is slowly flashing red. It will light green.

**NOTE:** A rapidly flashing red LED indicates that the outside call has been answered and placed on hold by another telephone.

### **Call Pickup Directed**

You can answer incoming calls such as intercom tone calls, call waiting, paging, transferred calls, recall and call reversion at other extensions outside your paging group with directed call pickup. Directed call pickup can also be programmed on a one-touch key.

1. Pick up receiver

OR

Press **ON/OFF** key

2. Dial **79**
3. Dial number of the ringing extension



### Call Pickup Group

You can answer incoming calls or intercom tone calls to other extensions in your paging group without entering the number of the ringing extension. The lowest port number is answered first if there are several calls at one time.

1. Pick up the receiver

OR

Press **ON/OFF** key

2. Dial **70**

3. The EXT LED lights red

**NOTE:** You cannot use this feature during paging, alarm ring, talk-back ring or call-back requests.

## HOLDING CALLS

### Outside Line Hold

There are two methods of placing an outside caller on hold. Exclusive hold restricts the release of a hold only to the extension that put the call on hold. System hold is not restricted and the call can be picked up at any extension.

#### To place a call on Exclusive Hold

1. Press the green line key, it will flash rapidly and you will hear a continuous tone.
2. Press **ON/OFF** key

OR

Replace the receiver

#### To release a call from Exclusive Hold

1. Press the rapidly flashing green LED line key, it will stop flashing and blink green.

#### To place a call on System Hold

Not restricted - any extension can release a system hold.

1. Press **HOLD** key. The green LED line will flash rapidly and you will hear a continuous dial tone.
2. Press **ON/OFF** key.

OR

Replace the receiver

#### To release a call from System Hold

1. Press the rapidly flashing LED line, it will blink green.

**NOTE:** If a call on hold is not answered within a specific time, a hold recall tone will sound. **<Programming Required>**

## CONFERENCE CALLS

You can add on an outside line to either an outside line call or an intercom call for a three-party conference. The system can accommodate up to three conference calls at the same time.

### To add on an outside line

1. Pressing the **HOLD** key or the line key will put the current call on hold.
2. Press a line key not in use. It will blink green and you will hear a dial tone.
3. Dial telephone number
4. Press **CONF** key when the called party answers.

### To add on an extension

1. Pressing either the **HOLD** key or the line key will put the current call on hold.
2. Dial extension number.
3. Press **CONF** key when the extension answers by either picking up the receiver or pressing the **ON/OFF** key.

### To exit a conference call

1. Press **FLASH** key

### **Privacy Release**

To allow a three-party conference call you have to release the privacy restriction on your phone.

1. Press **CONF** key
2. Give the third party your line number.
3. The third party must press the same line number to join the conference call.

### **NIGHT KEY \* <Use the attendant's phone>**

---

**To change from day mode to night mode:**

1. Press **ON/OFF** key
2. Dial # **52**
3. Press **ON/OFF** key

On the DSS telephone FF key 24 is the night key.

Ask your authorized dealer for more details to set the system to automatically switch to night mode.

## TRANSFERRING CALLS

### On-Hook (Automatic) Transfer \* <Programming Required>

#### To transfer a screened call

1. Press **HOLD** to put the outside call on hold. The line LED will flash green and you will hear a continuous dial tone.
2. Dial the extension number and call by voice.
3. If not answered, press 1 to change to tone.
4. Once the call is answered and the extension user is informed of the transfer, hang up. The line LED for the call on hold lights red.

#### To transfer an unscreened call

You can transfer calls directly to another extension without screening them.

1. Press **HOLD** key. The line LED will flash green and you will hear a continuous dial tone.
2. Dial the extension number.
3. Hang up. The line LED of the held call blinks red.

**NOTE:** You cannot transfer a call to an extension set for DND. The transferred call will revert back to you if it is not answered within a specific time.

---

**Manual Transfer**

1. Press **HOLD** key. The line LED will flash green.
  2. Key in the extension number and call by voice.
  3. If not answered, press 1 to change to tone.
  4. When the call is answered announce the call.
  5. Press **PROG** key
  6. Hang up
-

## **BUSY/NO ANSWER MODE**

### **Busy Override \* <Programming Required>**

To access a busy outside line you can program the system to allow another station to enter an existing conversation preceded by a warning tone.

1. Press the line key in use
2. An alert tone sounds to warn the user of the interruption.

**NOTE:** Both your extension and the busy extension must belong to the same paging group to activate this feature.

### **Call Forwarding**

If a station is unattended, all incoming calls are automatically forwarded to another extension.

#### **To set Call Forwarding**

1. Press **ON/OFF** key
2. Dial **72**
3. Dial extension number
4. Press **ON/OFF** key The DND/CF LED lights red

### **To cancel Call Forwarding**

---

1. Press **ON/OFF** key
2. Dial **72**
3. Press **ON/OFF** key. The DND/CF LED goes off

### **Do-Not-Disturb**

Do-Not-Disturb allows you to temporarily block most incoming calls to your extension. Only Call-Back queuing and recalls are not blocked. Once DND is set, the Call Forwarding feature is cancelled.

### **To set Do-Not-Disturb**

1. Press **ON/OFF** key
2. Dial **73**
3. Press **ON/OFF** key. The DND/CF LED will light red

### **To cancel Do-Not-Disturb**

1. Press **ON/OFF** key
2. Dial **73**
3. Press **ON/OFF** key. The DND/CF LED goes out



### **Message Waiting/Call Back Request**

You can leave a message at another extension requesting a return call.

---

#### **To leave a Message Waiting/Call Back Request**

1. Press **ON/OFF** key
2. Dial the extension number
3. Dial **2** at the sound of the busy signal or while the phone is still ringing.
4. Press **ON/OFF** key
5. **MSGE LED** will blink red on the busy extension.

#### **To answer a Call Back request**

- 
1. Pick up receiver
  2. Press **AUTO** key
  3. Press **REDIAL** key to automatically dial the extension which left the Call Back request.

OR

4. Press **FLASH** key to cancel **MSGE LED**.

### **Trunk Queuing**

You can set a system alert tone to signal you when a line becomes free if all the outside lines or trunk groups are busy.

#### **To set Trunk Queuing**

1. Press **ON/OFF** key
2. Press busy line key
3. Dial **2**
4. When you hear a continuous dial tone the line is set for an alert tone.

#### **To respond to a Trunk Queuing alert tone**

1. Pick up the receiver within 16 seconds or Trunk Queuing is cancelled.
2. Listen for the outside dial tone
3. Begin dialing

**NOTE:** If an incoming call rings on the line key set for Trunk Queuing it is suspended for the duration of the incoming call. It is also cancelled after 20 minutes if not used within that time.

This feature is also available on an SLT.

### **Off-Hook Voice Announce \* <Programming Required>**

If you try to make an intercom call to a busy extension, you can interrupt the call and make an announcement that can be heard only by the called party.

---

#### **To make a Voice Announcement**

1. Press **ON/OFF** key
2. Dial the extension number
3. Press **5** at the sound of a busy signal.
4. Make your announcement. Your voice will be heard only on the extension not the outside line.

#### **To answer a Voice Announcement**

1. Press the **Talk Back** key (if programmed), or dial **\* 3**. The first call can still be heard but your speech path is only to the internal caller.
2. Press the **Talk Back** key or dial **\* 3** again to return your speech path to the first call and to automatically disconnect the Voice Announce caller.

**NOTE:** The **Talk Back** key (**\* 3**) can be stored under an FF key or One-touch key to activate this feature.  
During Off-Hook Voice Announce you can not go back and forth between the first and second call.

## AUDIBLE FEATURES

### Alarm

A 16-second alarm will sound at a set time. If you are on a call at the set time, the alarm will not sound until you hang up.

#### To set the Alarm

1. Press **ON/OFF** key
  2. Dial # **4**
  3. Key in the time using a 12-hour format followed by code 1 or 2.
  4. Press **1** for A.M.
- OR
5. Press **2** for P.M.  
For example, 3:35 P.M. = 03352.  
A 16-second alarm will sound at 3:35 P.M.

- 
6. Press **ON/OFF** key

#### To cancel the Alarm

1. Press **ON/OFF** key
2. Dial # **4**
3. Press **ON/OFF** key

#### Delayed Ring/No Answer \* <Programming Required>

Normally, if an incoming call to your extension is not answered within a set time, the extension programmed with Delayed Ring will receive the incoming call. Both extensions will continue to ring until the call is answered.

**Paging \* <Programming Required>**

Paging lets you contact people who are temporarily away from their phones, give instructions to the entire staff, or communicate with several staff members at once. Internal paging is possible through the speakers of other phones and through the speakers of external paging systems.

There are a maximum of three paging zones. Programming determines which telephones are included in these zones. The chart below will help to keep track of the telephones assigned to each zone.

In zones 1 and 2 you can make an announcement only through the speaker of the telephone. In zone 3 you can make an announcement through the telephone and the external paging system.

Extension	10	11	12	13	14	15	16	17	18	19	20	21	22	23	24	25
Zone 1																
Zone 2																
Zone 3																

**Zone Paging**

1. Pick up the receiver
2. Press # **01** to page Zone 01. The EXT LED will light red
3. Make your announcement by speaking through the receiver.
4. Hang up

### **All-Zone Paging**

You can make an announcement through the speakers of all the telephones in every zone as well as the external paging system.

1. Pick up receiver
  2. Key in # **00**
- 
3. Make announcement.

### **Background Music (BGM)**

You can play background music through an external paging system. When a paging call is established, BGM will go off automatically.

### **Meet-Me Answer**

You can answer a paging call at any nearby extension, even if the extension is not within the same paging group.

### **To answer a paged call**

1. Pick up receiver at any nearby extension.  
OR  
Press **ON/OFF** key
2. Press **77**. Paging will stop, allowing you to speak with the pager. The **EXT LED lights** red.

### **Outside Line Off-Hook Signal \* <Programming Required>**

You can program an alert tone to signal a second incoming call while you are on another intercom or outside line call with certain exceptions.

You cannot receive outside line calls: during conference calls, while the phone is ringing on an incoming call or while using an outside line other than an assigned one.

## **DIALING ALTERNATIVES**

### **Redial**

The **REDIAL** key repeats the last number dialed up to a maximum of 16 digits. A maximum of five speed dialing codes can also be redialed.

1. Press a line key
2. Listen for the outside line dial tone
3. Press **REDIAL** key
4. If the number is still busy, you can press **REDIAL** key again only if the system is programmed for Auto-Flash-Redial. The outside line is flashed once automatically and the last number is redialed.

### **To check a redialed number:**

1. Press **ON/OFF** key
2. Press **CONF** key
3. Press **REDIAL** key

### **Save/Repeat Dial**

Redials a previously dialed outside line number. Unlike redial, the number will not be lost, even if you dial another number.

#### **To save a dialed number (During outside line call)**

1. Press **AUTO** key twice
2. Press **\***

---

3. Hang up

**NOTE:** Saved numbers are erased when a new number is saved.

#### **To check a saved number:**

1. Press **ON/OFF** key
2. Press **CONF** key
3. Press **AUTO** key

---

4. Press **\***

#### **To repeat a dialed number**

1. Press a line key
2. Press **AUTO** key
3. Press **\***



### **Personal Speed Dial (PSD)**

You can store frequently dialed numbers in a PSD key, thereby, reducing the possibility of dialing wrong numbers and allowing instant dialing at the touch of a key.

#### **To store PSD Numbers on a One-Touch key**

1. Press **ON/OFF** key
2. Press **PROG** key
3. Press One-Touch key (each telephone has 10 One-touch keys).
4. Dial number
5. Press **HOLD** key
6. Press **ON/OFF** key

**NOTE:** You can also store a number in PSD using: **AUTO** key and 90-99

**To access a stored PSD number**

1. Press the line key
2. Press One-Touch key

**To check a stored PSD number**

1. Press **ON/OFF** key
  2. Press **CONF** key
- 

3. Press One-Touch key

**To cancel a stored PSD number**

1. Press **ON/OFF** key
2. Press **PROG** key
3. Press One-Touch key
4. Press **HOLD** key

### **System Speed Dial (SSD)**

You can store frequently dialed numbers in an SSD key allowing instant dialing at the touch of a key. Numbers entered in the SSD memory can only be entered from extensions 10 and 11.

#### **To store SSD Numbers \* <Available only on extensions 10 and 11>**

1. Press **ON/OFF** key
2. Press **PROG** key
3. Press **AUTO** key

---

4. Key in SSD code (00 - 89)
5. Dial number
6. Press **HOLD** key
7. Press **ON/OFF** key

**To access a stored SSD number**

1. Press a line key
2. Press **AUTO** key
3. Enter the SSD code (00-89)

**To check an SSD number \* <Available on all extensions>**

1. Press **ON/OFF** key
2. Press **CONF** key
3. Press **AUTO** key
4. Enter SSD code (00 - 89)

**To cancel a stored SSD number**

1. Press **ON/OFF** key
2. Press **PROG** key
3. Press **AUTO** key
4. Enter SSD code (00 - 89)
5. Press **HOLD** key

### **Assigning Two SSD Codes to a Single One-Touch Key**

If you assign a frequently used access code to one SSD code and a telephone number to a second SSD code, you can dial the telephone number by entering the first SSD code followed by the second SSD code. However, both SSD codes can be programmed on a One-Touch key.

1. Press **ON/OFF** key
2. Press **PROG** key
3. Press the One-Touch key
4. Press **AUTO** key
5. Key in the first SSD code for the access code.
6. Press **REDIAL** key to insert a pause between the access code and the telephone number if necessary. Repeat for a longer pause.
8. Key in the second SSD code for the telephone number.
9. Press **HOLD** key
10. Press **ON/OFF** key

### DTMF Signal Conversion

You can change from pulse to tone dialing, even on a rotary telephone. However, once you make the change to tone you cannot change back to pulse on the same call. Also, you cannot send tone signals either during a call or while you are dialing.

1. Press line key
2. Press \* or # key
3. Replacing the receiver returns the line to pulse.

**NOTE:** You can program the \* or # key in speed dialing.

### DATA SECURITY \* <Programming Required>

Prevents interruptions by other extensions during data transmission or conversation. During conversation press the **AUTO** key twice followed by the # key. For data transmission security, ask your authorized dealer for more details:

Prog. System Prog. Telephone	NO	YES
NO	Data security not possible	AUTO, AUTO, # to active data security
YES	Data security	Data security

## **ACCOUNT CODES/SMDR**

### **Account Code Station Message Detail Recorder (SMDR)**

When a serial interface printer is connected to S-DBS, information such as call dates and times, numbers called, outside line numbers used, etcetera, can be printed for each account by entering its code number.

Separate account numbers can be assigned to different clients for preparing bills. Each account code can be a maximum of ten digits. Enter the code either before dialing or during the call.

Before data can be sent from the S-DBS to the SMDR printer you must enter # **93** from the attendant's telephone. This is a one-time operation. The S-DBS will continue to send data to the printer, even if the printer is disconnected.

#### **To enter an Account Code before dialing out**

1. Pick up the receiver

OR

Press **ON/OFF** key

2. Press **AUTO** key OR (# 7 if using a DTMF SLT)
3. Press #
4. Key in the account code (up to 10 digits)
5. Press #
6. Press a line key
7. Key in the telephone number.

**To enter an Account Code during an outside call**

1. Press **AUTO** key

---

2. Press #
3. Key in the account code (up to 10 digits).
4. Press #

**NOTE:** Not available on SLT.



## **TOLL RESTRICTIONS**

### **Toll Restriction System \* <Programming Required>**

You can assign access levels to specific extensions or outside lines which force long distance calls to particular lines or prevent after hours calls.

**The five major access levels are as follows:**

**Type 0:** Cannot place or receive outside calls. Only intercom calls are possible.

**Type 1:** Cannot place outside calls, but can receive incoming calls.

**Type 2:** Can make only local calls and programmed special area code table 1 calls and 1-800 or 800 calls. Cannot make 411, 555 or 976 calls.

**Type 3:** Can make only local calls and programmed special area code table 1 and table 2 calls.

**Type 4:** No restrictions

**Note:** The station lockout key code restriction is also available. You can also program the system to allow system speed dialing.

### **Station Lockout \* <Programming Required>**

You can prevent others from using your phone to place outside line calls by dialing a four-digit code which has been programmed from the attendant's phone. However, the locked-out phone can still be used for intercom calls.

#### **To set or reset Station Lockout**

1. Press **ON/OFF** key
2. Key in **74** to lockout the station.
3. Key in the four-digit code
4. Press **ON/OFF** key

**To program Station Lockout code \* <Available only on extensions 10, 11>**

1. Press **ON/OFF** key
2. Press **PROG** key
3. Dial # **8**
4. Enter extension port number - 2 digits
5. Enter 4-digit code (any)
6. Press **HOLD** key.

## **DOOR BOX**

### **Door Boxes A and B \* <Programming Required>**

You can screen callers without opening the door. The system supports two door boxes, A and B. Use code 61 for door box A and code 62 for door box B.

---

#### **To call a door box**

1. Pick up receiver
2. Key in code 61 for door box A or code 62 for door box B.
3. Speak to caller (you cannot signal the caller)

#### **To answer a door box call**

1. Pick up receiver

#### **Door Opener**

A door opener will activate the system at the touch of a dial key.

#### **Speaking to a door box caller**

1. Dial **66**
2. A or B will open depending on which door you address.

**OR**

#### **Opening a door box without speaking to caller**

1. Dial **67** to open Door Box A
2. Dial **68** to open Door Box B

**NOTE:** If the door opener does not function, re-dial **66**.

**Sensor \* <Programming Required>**

The sensor has a sensor detecting terminal. If heat or water leakage sensors are installed, a warning tone will be sent to the extensions upon detecting abnormal conditions.

**Cancelling a warning tone from an extension**

1. Lift receiver
2. Replace receiver



# Index

## A

Account Code 39  
Alarm 28  
Answering Calls 14  
ALTO Key 4, 25, 32, 35, 36, 37, 38, 39, 40  
Automatic Answer 16

## B

Background Music 30  
Busy Override 23

## C

Call Back Request 25  
Call Forwarding 23  
Call Pickup 16  
    Directed 16  
    Group 17  
Call Waiting 15  
CONF Key 4, 19, 20, 31, 32, 34, 36  
Conference Calls 19  
    Add-On Conference 19  
    Extension 19  
    Outside Line 19

## D

Data Security 38  
Delayed Ring 28  
Dial CO Access 11  
Dial Tone Stop 10  
Dimension 1  
Directed Call Pickup 16  
Display Contrast 8  
Do-Not-Disturb 24  
Door Box 43  
Door Opener 43  
DSS Telephone 4  
DTMF Signal Conversion 38  
Dual Port System. See Hybrid System

## E

External Paging 29

## F

FCC iii  
    Registration Number iii  
FLASH Key 4, 12, 19, 25  
Flexible Function Key 6

## G

Group Call Pickup 17

## H

Hands-Free Answer Back 14  
Headset 10  
Hearing Aid iv  
Hold Recall 18  
Holding Calls 14, 18  
    Exclusive Hold 18  
    Hold Recall 18  
    Intercom Hold 14  
    Outside Line Hold 18  
    System Hold 18  
Hybrid System 2

## I, J, K, L

Intercom Calls 13  
    Attendant Call 13  
    Extension Call 13  
    Tone Call 13  
    Voice Call 13

## M

Making an Outside Call 11  
Meet-Me Answer 30  
Message Waiting 25  
MUTE Key 4, 14

## N

Night Key 20

## O

Off-Hook Signal 30  
Off-Hook Voice Announce 27  
One-Touch Key 7, 33, 37

## **P, Q**

Paging 10, 29  
  All Zone Paging 30  
  External Page 29  
  Meet-Me Answer 30  
Personal Speed Dial 33  
Pooled Trunk 9, 12  
Privacy Release 20  
PROG Key 4, 7, 22, 33, 34, 35, 37, 42  
Programming 3  
PSD 33

---

## **R**

Radio Interference v  
REDIAL Key 4, 25, 31, 37  
Repeat Dial 32  
Ringer Equivalence iii

## **S**

Save Dial 32  
Sensor 44  
SMDR 39  
SSD 35  
Station Lockout 41  
System Configuration 5  
System Speed Dial 35

## **T, U**

Toll Restriction 41  
Tone Call 13  
Transfer 21  
  Automatic Transfer 21  
    Screened 21  
    Unscreened 21  
  On-Hook Transfer 21  
Trunk Queuing 26

## **V, W, X, Y**

Voice Call 13  
Volume 8  
  Dial Tone Volume 8  
  Display Contrast 8  
  Receiver Volume 8  
  Ring Volume 8

## **Z**

Zone Paging 29, 30