



DBS Release Notes



CPC-AII/B Version 8.0

Document Number: DBS-80-705

Part Number: 550X1 0101

April 18, 1996

Introduction

CPC-AII/B Version 8.0 offers support for the new Panasonic 44-Series telephones (**VB-44xxx**), as well as Computer Telephony Integration (CTI) through the **Windows™** Telephony Applications Processing Interface (TAPI).

Contents

Topic	Page
Introduction	3
44-Series Phone Support	4
New Phone Features	5
Directory Mode	9
Variable Mode	10
Handset Mute	12
Off-Hook Monitoring	13
Separate Speaker Volumes for Internal vs. CO calls	13
Analog Adapter	14
MSG (Message) Key	16
DSS/72 Console - Key Arrangement	18
EM/24 - Key Arrangement	22
Modification to Toll Restriction Service	24
TAPI Support	27
Key Telephone Installation Notes	28

44-Series Phone Support

CPC-AII/B Version 8.0 provides full support for Panasonic's 44-Series phones (VB-44xxx). Table 1 below lists all 44-Series phone models and their part numbers. Most models are available in two colors: gray and black.

Table 1. 44-Series Phones

16-Key Phone (gray)	VB-4421 OG
16-Key Phone (black)	VB-4421 OB
16-Key Speakerphone (gray only)	VB-44211 G
22-Key Phone (gray only)	VB-44220G
22-Key Small-Display Speakerphone (gray)	VB-44223G
22-Key Small-Display Speakerphone (black)	VB-442238
34-Key Small-Display Phone (gray only)	VB-44230G
34-Key Small-Display Speakerphone (gray)	VB-44233G
34-Key Small-Display Speakerphone (black)	VB-442338
22-Key Large-Display Speakerphone (gray)	VB-44225G
22-Key Large-Display Speakerphone (black)	VB-442258
DSS/72 Console (gray)	VB-44320G
DSS/72 Console (black)	VB-443208
EM/24 Unit (gray)	VB-4431 OG
EM/24 Unit. (black)	VB-44310B

New Phone Features

New DBS features that can be executed on the **44-Series** phones are described below.

Note: The new features introduced with these phones are supported by **CPC-AII/B** Version 8.0, **CPC-S/M** Version 2.0, and **CPC-EX** Version 1.0. You can also use the 44-series phones with previous DBS versions, but the new features won't be supported.

Figure 1. 44-Series Small-Display Phone

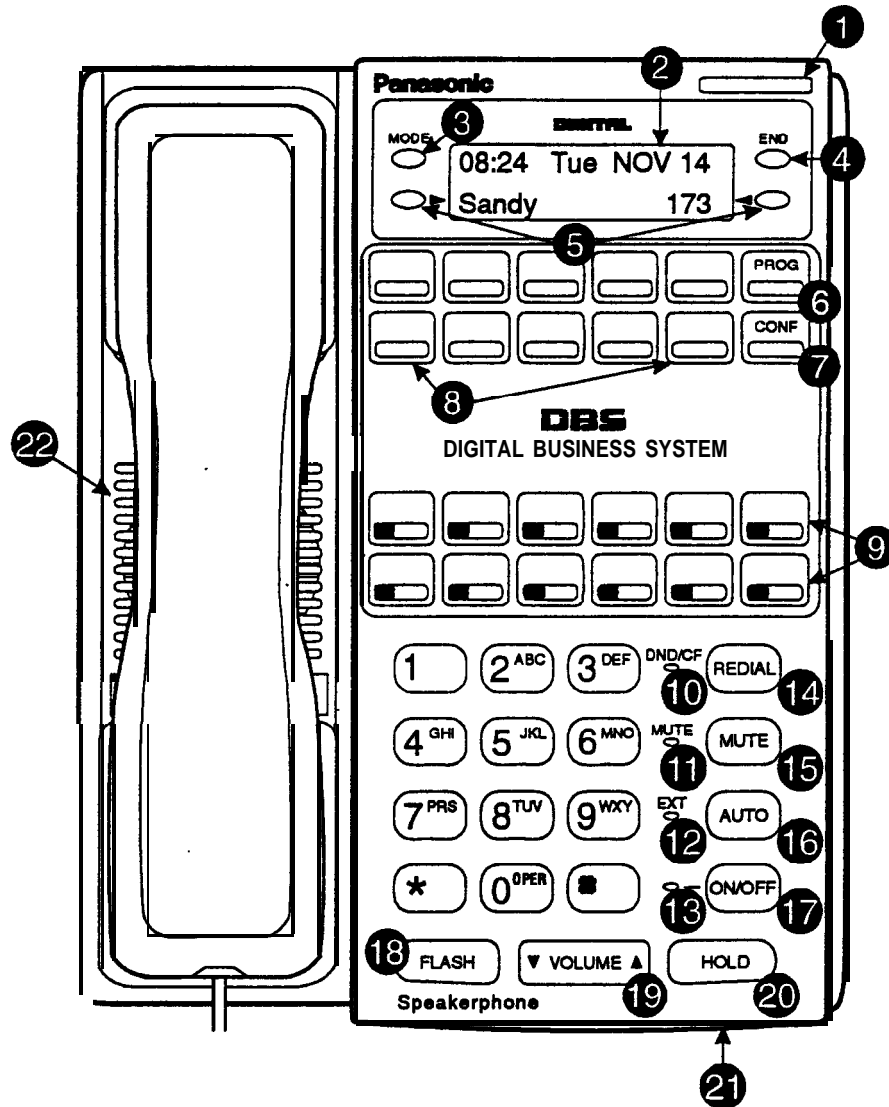

Table 2. Key to 44-Series Small-Display Phone

#	Feature	Description
1	Message Indicator	Indicates that you have a message.
2	Display	Displays information about phone's status, menus, dialing directories, and text message information.
3	Mode Key	Used to change display modes from default to directory mode.
4	End Key	Used to exit directory mode and return display to default mode.
5	Select Keys	Used to select and dial a System Speed Dial, Personal Speed Dial, or Extension number from a directory.
6	PROG Key	Used to program FF and one-touch keys and to adjust ringer volume. Depending on the setup of your system, may also be used to transfer calls.
7	CONF Key	Used to establish conference calls, check FF key and one-touch features, and scroll through messages.
8	One-Touch Keys	Used to make outside calls or to access call-handling features.
9	Flexible Function (FF) Keys	Used to access outside lines or to access call-handling features.
10	DND/CF Indicator	Indicates that Do-Not-Disturb, Call Forwarding, or Absence Message is set.
11	MUTE Indicator	Indicates that your voice is muted - i.e., party on the other end cannot hear you. Lights solid when your hands-free microphone is muted and flashes when your handset is muted.
12	EXT Indicator	Lights when you are on a call; flashes when you hold a call.
13	ON/OFF Indicator	Lights when ON/OFF key has been pressed.
14	REDIAL Key	Used to redial last outside number dialed.
15	MUTE Key	Used to activate/deactivate MUTE function. When activated, the party on the other end cannot hear you. (See item 11, MUTE Indicator.)
16	AUTO Key	Used to access speed dialing, enter account codes, or for message waiting answer/cancel.
17	ON/OFF Key	Used to make a call without lifting handset.
18	FLASH Key	Used to end an outside call and to restore dial tone without hanging up receiver.
19	VOLUME Key	Used to adjust level of tones, background music, ringing, receiver volume, and display contrast.
20	HOLD Key	Used to hold calls, to retrieve held calls, and to complete FF key programming.
21	Microphone	Used to talk with other party without using the handset.
22	Speaker	Outputs tones and voice at your extension.

Figure 2. 44-Series Large-Display Phone

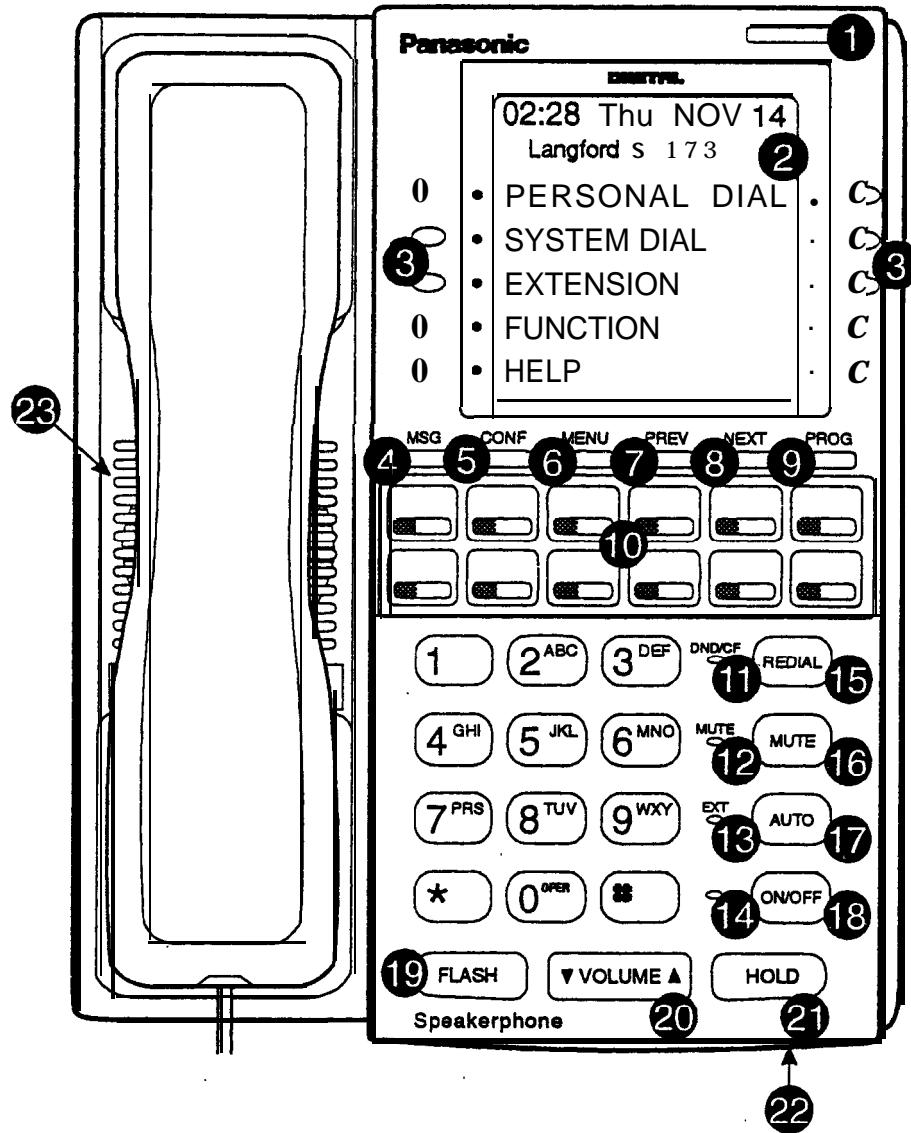

Table 3. Key to 44-Series Large-Display Phone

#	Feature	Description
1	Message Indicator	Indicates that you have a message.
2	Display	Displays information about phone's status, menus, dialing directories, and text message information.
3	Soft Keys	Used to make outside calls or to access call-handling features.

#	Feature	Description
4	MSG Key	Used for Auto-CallBack to a telephone which has left a text message or to access voice messages.
5	CONF Key	Used to establish conference calls, check FF and one-touch key settings, and scroll through messages.
6	MENU Key	Used to return to the Main Menu screen. The default Main Menu screen contains the following items: <ul style="list-style-type: none"> • PERSONAL DIAL • SYSTEMDIAL • EXTENSION • FUNCTION • HELP
7	PREV Key	Used to return to the previous menu.
8	NEXT Key	Used to advance to the next menu.
9	PROG Key	Used to program FF and one-touch keys and to adjust ringer volume. Depending on the setup of your system, may also be used to transfer calls.
10	Flexible Function (FF) Keys	Used to access outside lines or to access call-handling features .
11	DND/CF Indicator	Indicates that Do-Not-Disturb, Call Forwarding, or Absence Message is set.
12	MUTE Indicator	Indicates that your voice is muted - i.e., party on the other end cannot hear you. Lights solid when your hands-free microphone is muted and flashes when your handset is muted.
13	EXT Indicator	Lights when you are on a call ; flashes when you hold a call.
14	ON/OFF Indicator	Lights when ON/OFF key has been pressed.
15	REDIAL Key	Used to redial last outside number dialed.
16	MUTE Key	Used to activate/deactivate MUTE function. When activated, the party on the other end cannot hear you. (See item 12, MUTE Indicator.)
17	AUTO Key	Used to access speed dialing, enter account codes, or for message waiting answer/cancel.
18	ON/OFF Key	Used to make a call without lifting handset.
19	FLASH Key	Used to end an outside call and to restore dial tone without hanging up receiver.
20	VOLUME Key	Used to adjust level of tones, background music, ringing, receiver volume, and display contrast.
21	HOLD Key	Used to hold calls, to retrieve held calls, and to complete FF key programming.
22	Microphone	Used to talk with other party without using the handset.
23	Speaker	Outputs tones and voice at your extension.

Directory Mode

#-Series phones only

CPC-AII/B Version 8.0, CPC-S/M Version 2.0, or CPC-EX Version 1.0 only

Description

On the new small-display phones, you can use the phone's select keys (as well as other keys) to scroll through a directory of existing System Speed Dial (SSD) names, Personal Speed Dial (PSD) names, or extension names -- and select one to dial. For example, if you can't remember the party's extension number or speed-dial number to which you want to transfer a call on hold, you can use Directory Mode to **find** the number and execute the transfer.

Note: This new feature applies to the **44-series** small-display phone only (i.e., phones with a **2-line** LCD display).

Operation

The select keys on the 44-series small-display phone are located next to the display's 2nd line. Pressing select key 1 ("**>**" on the left) or select key 2 ("**<**" on the right) will access the displayed directory.

To use Directory Mode:

1. Press the MODE key to turn Directory Mode on. The 2nd line of the LCD will display "**SSD**" on the left and "**PSD**" on the right.
 - Press the MODE key again to access the directory for extension names. The 2nd line of the LCD will display "EXT" on the left.
2. Press the **>** select key to access the directory of existing SSD or EXT names; or the **<** select key to access the PSD directory. The 2nd line will show two speed-dial or extension names at a time (the first 7 characters of each name), beginning with the A's.
3. To scroll through the names (two at a time), press the **#** key. To back-scroll, press the ***** key.
4. To jump to another letter in the directory, press the numeric key for it. For example, press the "**6**" key to jump to the M's, N's, and O's. The M's will appear first. Press "**6**" again to jump to the N's, and again to jump to the O's. (**Note:** This doesn't work for PSD names unless the system is a DBS 824 CPC-M Version 2.0 or higher, which allows up to 40 PSDs.)
 - For names beginning with Q or Z, use the 1 key.
5. When the correct speed-dial or extension name is displayed, you can execute the dialing of its speed-dial or extension number by pressing the select key that points to it (**>** if the name is displayed on the left; or **<** if the name is on the right).
 - Or, to exit the directory without selecting a number to dial, press the END key or go on-hook.

Notes

Available on small-display phones only. This new feature applies to the 44-series small-display phone only (i.e., phones with a **2-line** LCD display).

Incompatibility with older phone versions. Directory Mode is available on the new **44-Series** phones only.

Hot Dial Pad and Directory Mode. The Hot Dial Pad feature (FF3 ExtPort# 48#) will not work on an extension in Directory Mode.

Variable Mode

44-Series phones only

CPC-AII/B Version 8.0, CPC-S/M Version 2.0, or CPC-EX Version '7.0 only

Description

This new feature applies to the 44-series small-display phone only (i.e., phones with a **2-line** LCD display).

When the phone is in Variable Mode, the features for Flexible Function Screen select keys 1 and 2 will display during each of the following call states:

C a l l	<u>Existing Prooram Address*</u>
• During an intercom call	FF3 (ExtPort)# 28# (25-39)#
• During CO dial tone	FF3 (ExtPort)# 29# (25-39)#
• Duringatrunkcall	FF3 (ExtPort)# 30# (25-39)#
• After dialing a busy extension	FF3 (ExtPort)# 33# (25-39)#

* In these addresses, you assign a Flexible Function Screen (25-39) to appear on the extension while it is in the call state.

Operation

The select keys on the 44-series small-display phone are labeled “>” and “<” to the left and right of the display’s 2nd line. Pressing select key 1 (“>” on the left) or select key 2 (“<” on the right) will perform the displayed feature.

To use Variable Mode:

1. Activate Variable Mode by pressing **ON/OFF *61 ON/OFF**.
 - When you dial ● 61 in the above sequence, the 1st line of the LCD will display “Variable md ON”. The display will return to normal when you press the second ON/OFF.
 - Use existing addresses **FF1 2# 7# 2#** to assign screen text.
 - The ***61** code toggles Variable Mode on and off. Press **ON/OFF *61 ON/OFF** again to turn Variable Mode off.
2. While the extension is engaged in an intercom call, the 2nd line will display select key 1 and 2 features from the Flexible Function Screen

assigned to display in FF3 ExtPort# 28#. The same applies when the extension receives CO dial tone (FF3 ExtPort# 29#); during a trunk call (FF3 ExtPort# 30#); and after dialing a busy extension (FF3 ExtPort# 33#).

- Use existing addresses FF1 2# 7# 1# thru 4# to assign select key features to Flexible Function Screens.
 - Select key features for **Fixed** Function Screens will not appear on small-display phones.
3. While the select key feature is displayed, you can execute the feature by pressing the > or < select key.

Notes

Toggling Variable Mode On/Off with an FF-Key. You can program the ● 61 code into an FF-key: In programming mode, press FF5 (ExtPort)# (KeyNo.)# (*61)#. The FF-key will toggle Variable Mode on/off while the extension is idle or in an off-hook/dial-tone state. The FF-key LED will remain lit (red) while Variable Mode is “On”. (You can also use a one-touch key to toggle Variable Mode on and off; however, one-touch keys do not contain an LED to indicate when Variable Mode is on.)

Variable Mode After Power-cycling. If Variable Mode is “On”, the extension will stay in Variable Mode even after power-cycling (system is powered down, then powered back up).

Incompatibility with older phone versions. Variable Mode is available on the new 44-Series phones only.

Conditions under which Variable Mode does not work. Variable Mode will be temporarily overridden under the following conditions: during an incoming message state, hold state, message-waiting state, or call-waiting state. Incoming messages include:

- CO Queuing
- Incoming [trunk no.]
- REV.[extension no.]
- TRF. [trunk no.]
- H-Recall
- Call wait
- REC.[trunk no.]
- Recall Hnt [Hunt Group no.]
- DISA Incoming
- Call [extension no.]
- Transf [extension no.]
- Recall [trunk no.]
- HOLD Recall

Handset Mute

44-Series phones only

CPC-AII/B Version 8.0, CPC-S/M Version 2.0, or CPC-EX Version 1.0 only

Description

While using the handset (not on speaker) during a phone conversation, you can press the MUTE key to block audio to the other party -- you can still hear them, but they can't hear you. This feature is called "Handset Mute."

Operation

1. To turn on Handset Mute while using the handset, press the MUTE key.
 - The MUTE indicator lamp (LED next to MUTE key) will flash.
 - The handset transmitter will be muted. You will still be able to hear the other party, but they can't hear you.
2. To turn off Handset Mute, do one of the following:
 - press the MUTE key again;
 - press HOLD to place the call on hold;
 - replace the handset on-hook; or
 - press the flashing FF-key to answer another call,
 - Note: This will drop the first call unless Key Bank Hold is enabled (FF1 2# 1# 9#).
 - The MUTE indicator lamp will stop flashing.

Notes

Headset Use. The Handset Mute feature also works if you are using a headset on the phone to handle calls (#51 activates Headset mode).

Speakerphone Use. The MUTE key works the same as before (mutes the microphone) when you are on speaker. The MUTE lamp lights steadily when the microphone is muted, and flashes when the handset is muted.

Handsfree Answerback. The MUTE key enables or disables Handsfree Answerback the same as before. (Handsfree Answerback allows you to answer intercom calls on speaker, without picking up the handset. While the phone is idle, press the MUTE key to toggle between Handsfree Answerback On and Off. When the MUTE indicator lamp is unlit, Handsfree Answerback is ON. When the lamp is lit, Handsfree Answerback is OFF.)

Offhook Monitoring. This new feature and Handset Mute can both be ON simultaneously, so that both the speaker and handset transmitters are muted (but the speaker and handset receivers still operate). For more information about Offhook Monitoring, see page 13 of these Release Notes.

Barge-Zns During Handset Mute. If another phone barges in on your call while Handset Mute is ON, and you change to conference talk (but not by pressing HOLD), Handset Mute will remain ON.

FF-Key/One-Touch Key Restriction. Handset Mute cannot be assigned to an FF-key or a one-touch (soft) key.

Off-Hook Monitoring

M-Series phones only

CPC-AII/B Version 8.0, CPC-S/M Version 2.0, or CPC-EX Version 1.0 only

Description

Off-Hook Monitoring lets you put a call on speaker while the handset is off-hook. You can still communicate with the outside party via the handset, but you will also be able to hear him on the phone's speaker. He will only be able to hear what is spoken through your handset, however - audio will not be transmitted through your microphone.

Operation

1. During a handset call, press the ON/OFF key.
 - Another receiver path is established on the phone's speaker -- you can now hear the outside party on the speaker as well as in the handset.
 - Your phone's microphone is muted so that the outside party hears only what is spoken through your handset. (To mute handset transmission, press MUTE.)
2. To disable Off-Hook Monitor ("kill" the speaker but stay on the line with the outside party through the handset), press ON/OFF again.

Separate Speaker Volumes for Internal vs. CO calls

44-Series phones only

CPC-AII/B Version 8.0, CPC-S/M Version 2.0, or CPC-EX Version 1.0 only

Description

You can now establish separate speaker volumes for internal (intercom) and external (CO) calls.

Operation

To adjust volume levels, press the VOLUME key (A or ▼) during the appropriate call state.

Notes

Adjusting speaker volume will affect only the speaker (i.e., not the handset), and vice-versa.

Analog Adapter

44-Series phones only

CPC-AII/B Version 8.0, CPC-S//U Version 2.0, or CPC-EX Version 1.0 only

Description

The Analog Adapter (**VB-44100**) consists of a base adapter and PC board which is installed on the underside of the phone. It is used to connect the **44-series** large-display phone to an analog device such as an SLT telephone, cordless phone, FAX machine, or modem. This allows the same phone line to be used to alternate between normal phone calls and analog communications. (*To install, see the instructions supplied with VB-44100*).

Programming

to register the installation of the Analog Adapter on an extension...

FF3 (ExtPort)# 51# (0 or 1)#

Extension Port where
VB-44225 Large-Display
Phone is installed

**0=Analog Adapter is not
installed on this extension.**

**1=Analog Adapter is
installed on this extension.**

to implement data security measures (interrupt tones, overrides)
for the Analog Port...

FF3 (ExtPort)# 52# (0 or 1)#

Extension Port where
VB-44225 Large-Display
Phone is installed

**0=Disable data security on the
Analog Adapter.**

**1=Enable data security on the
Analog Adapter.**

NOTE: This address will affect only the Analog Adapter, not the
Large-Display phone itself.

Operation

The first device to go off-hook will seize the line (off-hook is either lifting the handset or pressing the ON/OFF key). If the analog device goes off-hook first, the large-display phone will be unable to dial or go off-hook.

You can choose which device will ring by going off-hook at either the digital key telephone or the analog device and dialing ***71**. The digital key telephone display will reflect "Analog port RING" or "Key Tel RING", depending on which device is selected - the default is "Key Tel RING".

You can still *answer* an incoming call from either device, regardless of which device is ringing. For example, if the analog device is ringing, you can pick up the call on the digital key telephone by going off-hook before the analog device does. Similarly, if the digital key telephone is ringing or has not answered a voice call, the analog device can pick up the call by going off-hook first.

You can program the ***71** ring select comand into an FF key. Pressing the key toggles between "Analog Port RING" and "Key Tel RING". When the analog port is set to ring, the FF key LED lights red. When the key telephone is set to ring, the LED is off.

Notes

Phone Restrictions

- The Analog Adapter will work on the large-display phone only (VB-44225).
- A dial-pulse SLT will not function on the analog port.
- Stutter Dial Tone' (indicating Call-Forwarding mode, Do-Not-Disturb mode, etc.) will not function on an SLT connected to the Analog Adapter.
- An analog phone connected to the Analog Adapter cannot program or access speed dials.

Incoming Calls

- You cannot program both devices to ring simultaneously.
- The "***71**" code will not work if the other device is in use.
- The "***7 1**" code will not work if FF3 (ExtPort)# **51#** is set to "0".
- If set to "Analog port RING", the large-display phone will work like an SLT/OPX (no page announcements, no voice calls from other extensions, etc.).
- If the phone is in **CF/DND** (Call-Forward or Do Not Disturb), the phone will remain in **CF/DND** even if the ringing device is changed via the ***71** code.
- The incoming ring pattern for the analog device is the same as for the digital key telephone (determined by the Extension Ring Pattern in FF3 (ExtPort)# **39# (0-9#)**). If this address is set to "0" (determined by CO), the analog device will automatically default to "1 second ON, 3 seconds OFF."

Ring Patterns Not Applicable to Analog Device. The following ring pattern addresses **will not** affect the analog device:

Analog Transfer Ring Pattern	FF1 2# 1# 31# (0-6)#
SLT DISA Ring Pattern	FF1 2# 1# 34# (0 or 1)#
Inbound Ring Pattern	FF2 (Trunk)# 17# (0-9)#

Flash Interaction. Any disconnect signal sent to the analog port must be greater than the SLT Flash Control; otherwise the disconnect signal will be interpreted as a flash and the **call** will be placed on hold.

Programming Addresses That Affect the Analog Device. The following addresses will control the analog device, but will not affect the digital key telephone:

AEC Disconnect Duration	FF1 2# 1# 35# (0-15)#
SLT Flash Control	FF1 2# 1# 1 1# (0 or 1)#
SLT Onhook Flash Timer	FF1 3# 14# (0-6)#
AEC Disconnect	FF3 (ExtPort)# 46# (0 or 1)#
Analog Port on Large-Display Phone (new)	FF3 (ExtPort)# 51# (0 or 1)#
Data Security on Analog Port (new)	FF3 (ExtPort)# 52# (0 or 1)#

MSG (Message) Key

44-Series phones only

CPC-AI/B Version 8.0, CPC-S/M Version 2.0; or CPC-EX Version 1.0 only

Description

The new MSG key on the VB-44225 Large-Display Phone adds the following functionality to the phone:

- **Auto-Callback.** If a callback message has been left by another extension, you can press the MSG key to place an automatic callback to the extension that sent the message. If more than one callback message has been received, pressing the MSG key will perform auto-callback in the order received.
- **Auto-Answer Voice Message.** You can press the MSG key to automatically access your voice mailbox. The phone will dial your voice mailbox and send access codes (if programmed) for retrieving new messages.

Programming

Auto-Callback is always enabled for large display phones. Use the following to enable the MSG key for Auto-Answer Voice Message.

to enable the MSG key for Auto-Answer Voice Message...

FF3 (ExtPort)# 53# (0 or 1)#

Extension Port where
VB-44225 Large-Display
Phone is installed

**0=Disable MSG key from returning
a "Message Waiting".**

**1=Enable MSG key for returning
a "Message Waiting".**

Operation

To Program Voice Mailbox Access Codes into the MSG Key:

Press PROG MSG [16-digit number] HOLD

The display will reflect "Regist Data".

To Confirm a Voice Mailbox Access Code Programmed into the Message Key..

Press CONF MSG.

The programmed access code will be displayed.

Notes

Operation With Message Waiting Indicator. The Message Waiting Indicator on the phone's upper right corner will flash whenever a callback message or voice message has been received.

Operation During Call States. The MSG key will work only when the phone is idle, receiving dial tone, or in Directory Mode (via select key).

Operation If Phone Has Both a Callback Message from another Extension and a Voice Message. Messages are accessed in a First In, First Out order. If the callback message was received before the voice message, then pressing the MSG key will activate Auto-Callback first. Likewise, if the voice message was received before the callback message, pressing the MSG key will access your Voice Mailbox.

Interaction with Tone-Calling Mode. If an Auto-Callback is placed to a phone that is in tone-calling mode (i.e., not voice-calling), that phone must answer or the message canceled before another message can be accessed.

FF-Key Restriction. These new MSG features cannot be assigned to an FF-key.

Reprogramming the MSG key if Extension Number Digits is changed. If the DBS is reprogrammed to use a different extension numbering plan (i.e., changed from 2-digit to 3-digit extensions, 3-digit to 4-digit extensions, etc.), the Voice Mailbox Access Code must be reprogrammed into the MSG key.

DSS/72 Console - Key Arrangement

#-Series phones only

CPC-AII/B Version 8.0, CPC-S/M Version 2.0, or CPC-EX Version 1.0 only

Description

The keys on the new DSS/72 Console (VB-44320) are arranged differently from the XI-43320 model. The new DSS console has 6 columns x 12 rows of keys (not 8 columns x 9 rows as in the previous version). This affects the following:

- **Name and Message Assignments (FF6 addresses).** The alphabetical arrangement of the keys is different.
- **FF-Keys.** The FF-keys on the DSS/72 console are numbered left-to-right, bottom row first.
- **DSS #1 Defaults.** The default extension number assignments on DSS #1 are different.

The new arrangement for the DSS keys is shown in Figures 3 & 4.

Figure 3. DSS/72 Console (VB-44320) key layout

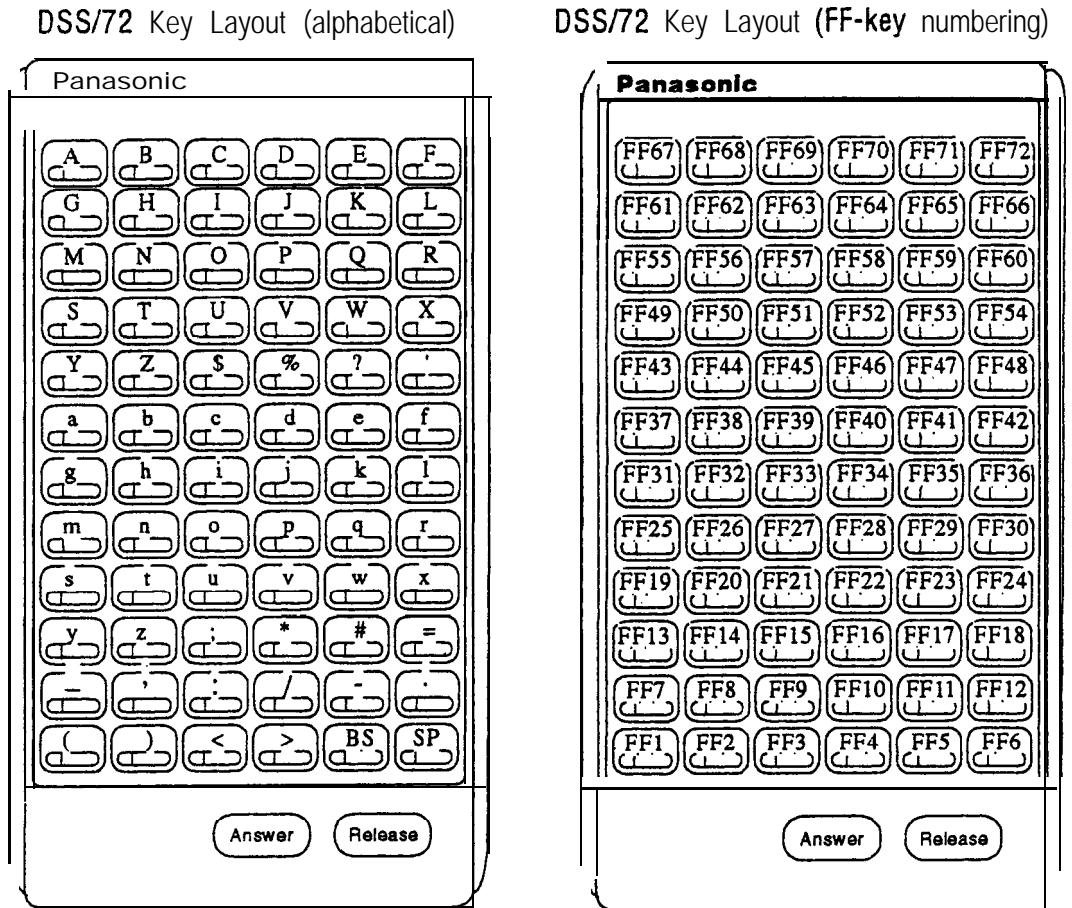
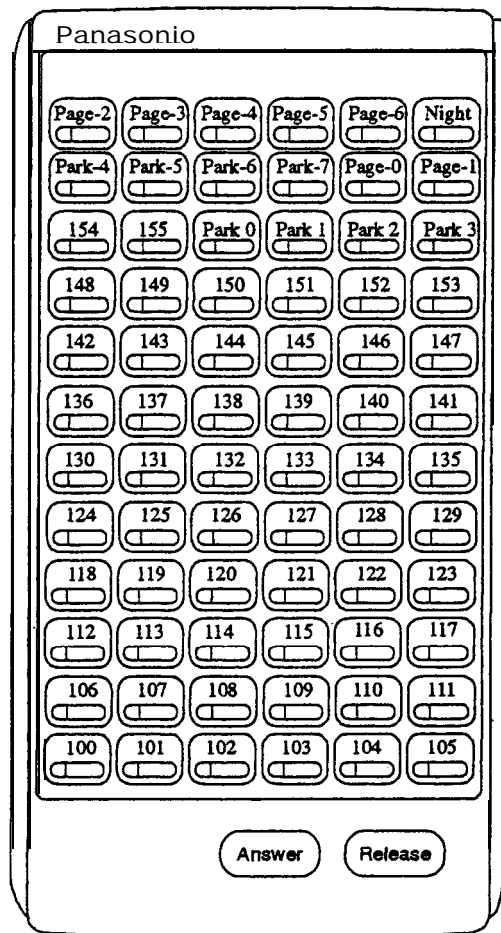

Figure 4. DSS/72 #1 Default Extension Numbers

DSS #1 Default Extension Numbers



Programming

The DSS/72 console (DSS #1 . . . DSS #4) is assigned to its extension number in the same manner as before:

Terminal Type: FF3 (ExtPort)# 2# (11-14)#

where..,

- 11 is the first DSS console for the first attendant
- 12 is the second DSS console for the first attendant
- 13 is the first DSS console for the second attendant
- 14 is the second DSS console for the second attendant

The **DSS/72** console's **FF-keys** are assigned feature codes in the same manner as before (the only difference is the numbering arrangement of FF-keys 1-72):

FF Key Assignments: FF5 (**DSSPort**)# CONF (1-72)# (Code)#

The Name and Message Assignment addresses are the same as before on the **DSS/72** console (the only difference is the placement of the keys when entering the characters of the text):

Extension Name: FF6 1# (**ExtPort**)# CONF (10 char.)#

SSD Name: FF6 2# (**SSD**)# CONF (16 char.)#

PSD Name: FF6 3# (**ExtPort**)# (**PSD**)# CONF (16 **char.**)#

Absence **Message**: FF6 4# (**5-9**)# CONF (15 **char.**)#

Trunk Name: FF6 5# (**Trunk**)# CONF (6 char.)#

Hunt Group Name: FF6 6# (**HuntGrp**)# CONF (10 char.)#

CW/OHVA Reply: FF6 7# (**1-5**)# CONF (15 char.)#

DID Name: FF6 8# (**1-200**)# (**1/2**)# (**0000-9999**)# (6 char.)#

DNIS Name: FF6 9# (**1-200**)# (**1/2**)# (**0000-9999**)# (6 char.)#

Note: If you use the 44-Series **DSS/72** for Name and Message assignment, you should use the **44-Series** phone for the attendant.

Operation

The 44-Series **DSS/72** operates the same as previous models.

EM/24 - Key Arrangement

44-Series phones only

CPC-All/B Version 8.0, CPC-S/M Version 2.0, or CPC-EX Version 1.0 only

Description

The keys on the new EM/24 unit (VB-443 10) are arranged differently from the VB-433 10 model. The new **EM/24** unit has 2 columns x 12 rows of keys (not 3 columns x 8 rows as in the previous version). This affects the following:

- **FF-Keys.** The FF-keys on the EM/24 are numbered bottom-to-top, left column first.

The new arrangement for the EM/24 keys is shown in Figure 5.

Figure 5. EM/24 Unit (VB-44310) keys

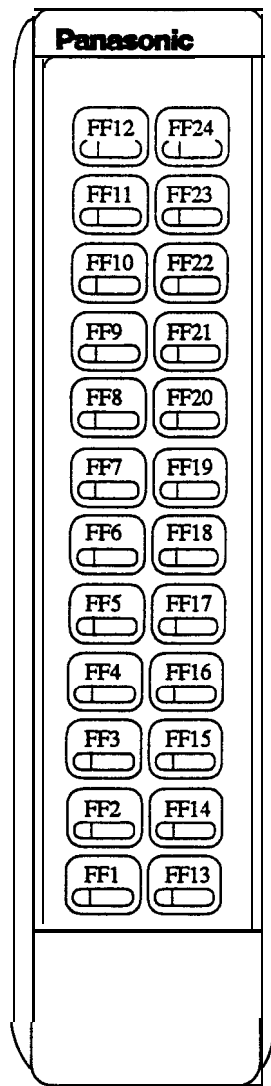

Programming

The terminal type for the EM/24 is specified in the same manner as before:

Terminal Type: FF3 (EM/24 ExtPort)# 2# (1-48)

The EM/24 unit is linked to its extension phone in the same manner as before:

EM/24 Port Assignment: FF3 (EM/24 ExtPort)# 3# (phone ExtPort)#

The EM/24's FF-keys are assigned feature codes in the same manner as before (the only difference is the numbering arrangement of FF-keys 1-24):

FF Key Assignments: FF5 (ExtPort)# (1-24)# CONF (Code)#

Operation

The 44-Series EM/24 operates the same as previous models.

Modification to Toll Restriction Service

Description The program address for TRS Operator Access (FF7 1# 18#...) has been modified to allow an extension to dial "O+NXX" phone numbers, even if "O-only" dialing is denied.

Four settings are possible. See Table 4 for descriptions.

Programming

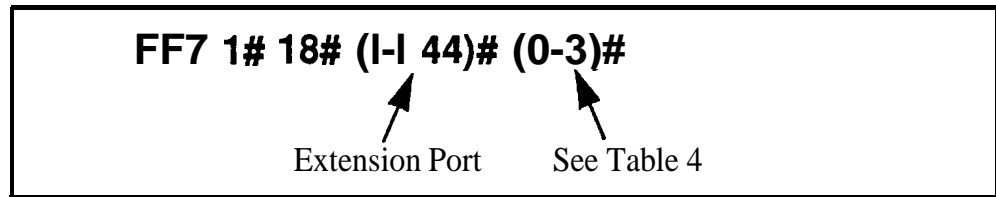

Table 4. TRS Operator Access settings

IF EQUAL ACCESS CODE FORMAT IS: 0 = Old Format (10XXX ONLY)			IF EQUAL ACCESS CODE FORMAT IS: 1 = New Format (101XXXX ONLY)		
Setting	Action	Type of Call	Setting	Action	Type of Call
0 (default)	Restrict	"O-only" and "00-only" calls. "10XXX0-only" calls.	0 (default)	Restrict	"O-only" and "00-only" calls. "101XXXX0-only" calls.
	Allow/Deny	"0" + additional digits per TRS tables. "00" + additional digits per TRS tables "01" + additional digits per TRS tables, Overseas Access Switch, and International Calls Switch. "10XXX0" + additional digits per TRS tables. "10XXX01" + additional digits per TRS tables, Overseas Access Switch, and International Calls Switch.		Allow/Deny	"0" + additional digits per TRS tables. "00" + additional digits per TRS tables "01" + additional digits per TRS tables, Overseas Access Switch, and International Calls Switch. "101XXXX0" + additional digits per TRS tables. "101XXXX01" + additional digits per TRS tables, Overseas Access Switch, and International Calls Switch.
continued					

IF EQUAL ACCESS CODE FORMAT IS: 0 = Old Format (10XXX ONLY)			IF EQUAL ACCESS CODE FORMAT IS: 1 = New For nat (101XXXX ONLY)		
Setting	Action	Type of Call	Setting	Action	Type of Call
1	Allow Allow/Deny	“O-only” and “OO-only” only calls. “10XXX0-only” calls. “0” + additional digits per TRS tables. “00” + additional digits per TRS tables “01” + additional digits per TRS tables Overseas Access Switch, and International Calls Switch. “10XXX0” + additional digits per TRS tables. “10XXX01” + additional digits per TRS tables, Overseas Access Switch, and International Calls Switch.	1	Allow Allow/Deny	“O-only” and “00-only” calls. “101XXXX0-only” calls. “0” + additional digits per TRS tables. “00” + additional digits per TRS tables “01” + additional digits per TRS tables Overseas Access Switch, and International Calls Switch. “101XXXX0” + additional digits per TRS tables. “101XXXX01” + additional digits per TRS tables, Overseas Access Switch, and International Calls Switch.
2	Restrict Allow Allow/Deny	“O-only” and “OO-only” calls. “10XXX0-only” calls. “0” + additional digits. “00” + additional digits. “10XXX0” + additional digits. “01” + additional digits per Overseas Access Switch and International Calls Switch. “10XXX01” + additional digits per Overseas Access Switch and International Calls Switch.	2	Restrict Allow Allow/Deny	“O-only” and “00-only” calls. “101XXXX0-only” calls. “0” + additional digits. “00” + additional digits. “101XXXX0” + additional digits. “01” + additional digits per Overseas Access Switch and International Calls Switch. “101XXXX01” + additional digits per Overseas Access Switch and International Calls Switch.
3	Allow Allow/Deny	“O-only” and “OO-only” calls. “10XXX0-only” calls. “0” + additional digits. “00” + additional digits. “10XXX0” + additional digits. “01” + additional digits per Overseas Access Switch and International Calls Switch. “10XXX01” + additional digits per Overseas Access Switch and International Calls Switch.	3	Allow Allow/Deny	“O-only” and “00-only” calls. “101XXXX0-only” calls. “0” + additional digits. “00” + additional digits. “101XXXX0” + additional digits. “01” + additional digits per Overseas Access Switch and International Calls Switch. “101XXXX01” + additional digits per Overseas Access Switch and International Calls Switch.

Notes

- The Operator Access address applies only to DBS systems using the new (1995) NANP dialing plan (**FF7 1# 17# 1#**), and to TRS types 2-6 (TRS types C1 and 1 do not allow outbound dialing; TRS type 7 allows all dialing).
- If “O-only”, “OO-only”, “10XXX0-only”, or “101XXXX0-only” calls are restricted (settings 0 or 2), the system will wait 6 seconds before automatically disconnecting the call. However, if the user dials additional digits within 6 seconds, the DBS will check other switches to determine whether to allow or deny the call.
- For all settings (0-3), the system will check the **Equal** Access Code Format switch (FM 1# 21#...) if a CIC (carrier identification code) is dialed to reach a preferred inter-exchange carrier.
- For all settings (0-3), the system will check the international calls switches (**FF7 1# 1#** and **FF7 1# 19#**) if “01”, “10XXX01”, or “10XXXX01” is dialed.
- For settings 2 and 3, the system will not consider TRS settings for the trunk.

TAPI Support

CPC-AII/B offers full support for the Panasonic Telephony Applications Processing Interface (TAPI). TAPI is a Windows™ application which allows a PC to be connected to a telephone extension and used to control incoming and outgoing calls through that extension. Typical PC applications that might be used with TAPI include Contact Managers and Personal Organizers.

The Panasonic TAPI product (VB-43720) provides the necessary interface between a DBS and a PC-based TAPI application. This product consists of a TAPI Adapter and the Panasonic TAPI Service Provider (SP) software which resides on the PC. The TAPI Adapter provides the physical connection between a PC, a DBS extension, and the DBS itself. Its purpose is to intercept telephone and call control signaling messages from the DBS and telephone extension and then forward a copy of those messages to the Service Provider software on the PC. After interpreting the messages, the Service Provider software passes them on to the TAPI application.

No special programming of the DBS is required for TAPI. For detailed information, see the *TAPI Installation Guide, Part Number 575X00201, Section 570*.

Key Telephone Installation Notes

Desi Strip Cover

The 44-Series Key Telephones are shipped with a thin green protective film over the Desi strip cover. Be sure to remove this film from both sides of the Desi cover before placing the phone in service.

Key Telephone Wall Mounting Instructions

The following procedures apply to 44-Series Key Telephones only. Please be sure to follow these procedures exactly. Removing the desk stand incorrectly can result in damage to the telephone and/or desk stand.

1. Place the telephone face down on a flat surface.
2. Grasp the top of the desk stand (at the **>ABS<** label) and pull up the end to 90° vertical (refer to Step 2 in Figure 6). The stand will click as it releases from the plastic securing latches.
3. Lift the desk stand as shown in Step 3 of Figure 6.

Figure 6. Desk Stand Removal.

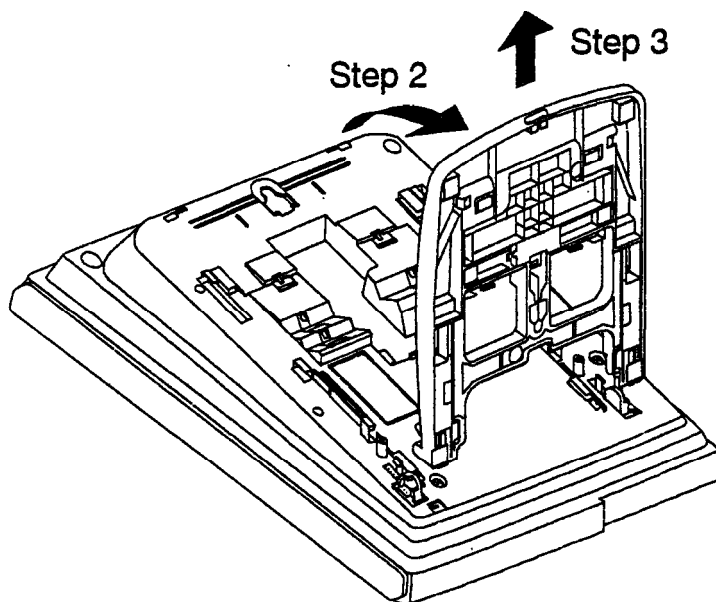

4. Rotate the desk stand 180°. In this position it doubles as a wall mount bracket.
5. Insert the wall mount bracket into the mounting guides as shown in Figure 7.
6. Slide the wall mount bracket onto the telephone.

Figure 7. Inserting the wall mount bracket (rotated desk stand)

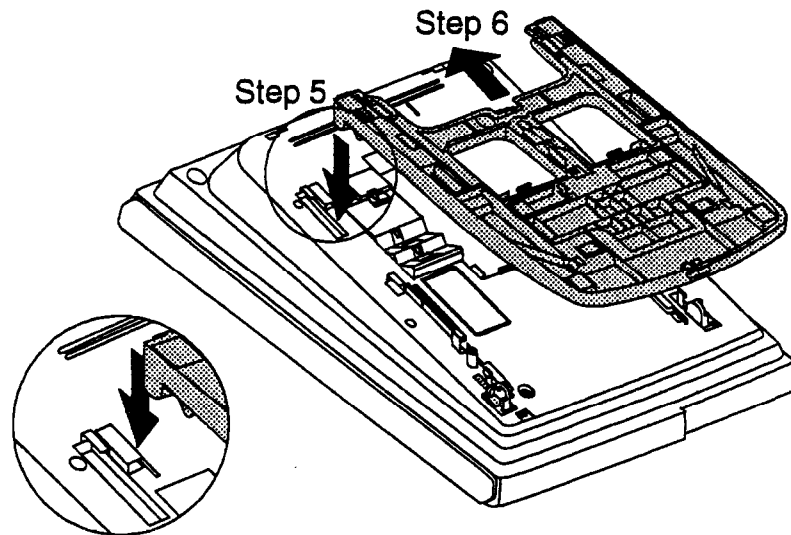

7. While viewing the front of the telephone, find the handset guide located just below the hookswitch (see Figure 8).
8. Slide the handset guide out, rotate 180° so that the holding clip is exposed, and reinsert.

Figure 8. Handset guide insertion for wall mounting, key telephone

