

Panasonic®

**DBS**  
Digital Business System

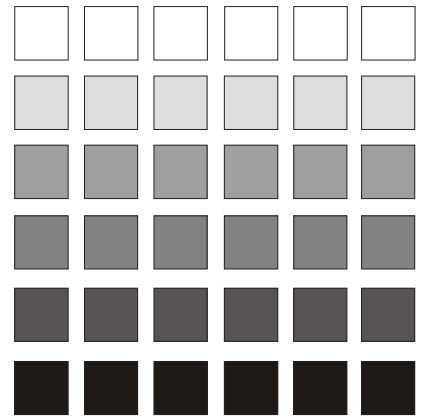

**(Applies to CPC-All/B Version 9.2  
and CPC-EX Version 2.3)**



**Section 700  
Feature  
Operation**

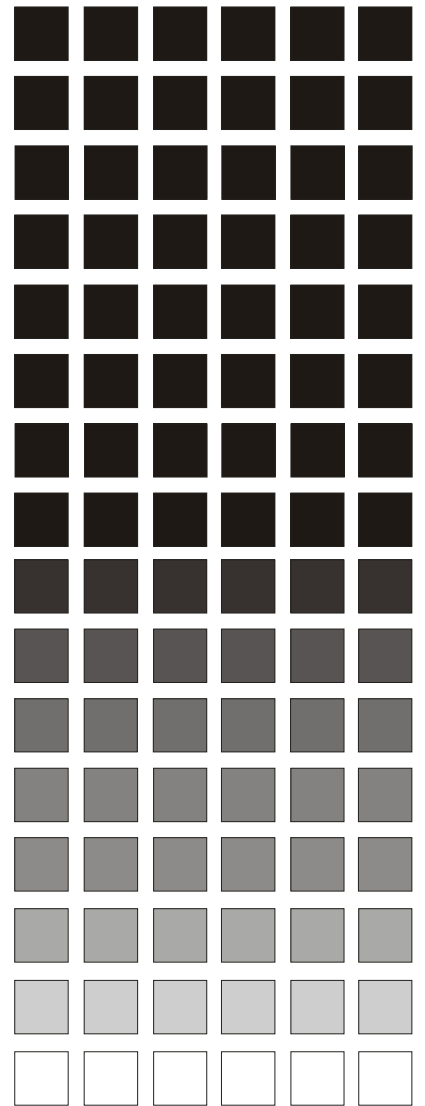



---

**Warning:** This service information is designed for experienced repair technicians only and is not designed for use by the general public. It does not contain warnings or cautions to advise non-technical individuals of potential dangers in attempting to service a product. Products powered by electricity should be serviced or repaired only by experienced professional technicians. Any attempt to service or repair the product or products dealt with in this service information by anyone else could result in serious injury or death.

---

## FCC Warning

This equipment generates, uses, and can radiate radio frequency energy, and, if not installed and used in accordance with the instruction manual, may cause interference to radio communications. This equipment has been tested and found to comply with the limits for a Class A digital device pursuant to Part 15 of FCC Rules, which are designed to provide reasonable protection against such interference when operated in a commercial environment. Operation of this equipment in a residential area is likely to cause interference, in which case the user at his own expense will be required to take necessary measures to correct the interference.

## Battery Recycling Statement

The following statement applies if you purchased backup batteries with your system.

The product you have purchased contains rechargeable batteries. The batteries are recyclable. At the end of their useful life, under various state and local laws, it may be illegal to dispose of these batteries into the municipal waste stream. Check with your local solid waste officials for details on recycling options or proper disposal.

The information contained in this document is subject to change without notice and should not be construed as a commitment by the Panasonic Telecommunication Systems Company (PTSC). PTSC reserves the right, without notice, to make changes to equipment design as advances in engineering and manufacturing methods warrant.

The software and hardware described in this document may be used or copied only in accordance with the terms of the license pertaining to said software or hardware.

Reproduction, publication, or duplication of this manual, or any part thereof, in any manner, mechanically, electronically, or photographically, is prohibited without permission of the Panasonic Telecommunication Systems Company (PTSC).

©Copyright 1995 by Panasonic Telecommunication Systems Company

Revised April 2000

All rights reserved.

---

# Contents

About This Manual. . . . .	x
----------------------------	---

---

<b>Chapter 1. List of Features . . . . .</b>	<b>1-1</b>
--	------------

---

<b>Chapter 2. Attendant Features . . . . .</b>	<b>2-1</b>
--	------------

Alternate Attendant . . . . .	2-3
Attendant Assignment of Speed Dialing . . . . .	2-3
Attendant Busy Override. . . . .	2-4
Attendant Call Park . . . . .	2-5
Attendant Control of Absence Messages,. . . . .	2-7
Attendant-Controlled Text Assignment. . . . .	2-8
Attendant Feature Package. . . . .	2-10
Attendant Groups . . . . .	2-11
Dial Tone Disable. . . . .	2-12
DSS/72. . . . .	2-13
Headset Operation. . . . .	2-17
Key Bank Hold . . . . .	2-18
One-Touch VM Transfer . . . . .	2-18
Station Lockout Code Assignment . . . . .	2-21
System Time and Date Control. . . . .	2-22
Traffic Measurement . . . . .	2-24
Walking COS Confirmation. . . . .	2-25

---

<b>Chapter 3. System Features . . . . .</b>	<b>3-1</b>
---	------------

Account Codes. . . . .	3-3
Non-Verified Account Codes . . . . .	3-3
Verified Account Codes . . . . .	3-4
Answer Supervision for Voice Mail . . . . .	3-6
Auto Day Mode. . . . .	3-7
Auto Day Mode. . . . .	3-8
Auto Set Relocation. . . . .	3-9
Background Music. . . . .	3-11
Battery Backup. . . . .	3-12
Call Forward ID Code for Voice Mail . . . . .	3-13
Caller ID . . . . .	3-14
Caller ID Auto DISA . . . . .	3-15
Centrex/PBX Compatibility . . . . .	3-16
Direct Inward Dialing (DID) . . . . .	3-16
DID Night Ringing Assignment . . . . .	3-17
DID Delayed Ringing . . . . .	3-18
DID/DNIS Flexible Ring Assignments . . . . .	3-18

---

<b>DID/DNIS Text Name Assignment</b> .....	<b>3-19</b>
<b>DID/DNIS to a Voice Mailbox</b> .....	<b>3-20</b>
<b>Direct Inward System Access (DISA)</b> .....	<b>3-22</b>
<b>Direct Trunk Access</b> .....	<b>3-24</b>
<b>Distinctive Ringing</b> .....	<b>3-24</b>
<b>Door Box (Using Extension Adaptor)</b> .....	<b>3-25</b>
<b>Door Box (Using Trunk Adaptor)</b> .....	<b>3-27</b>
Sensor .....	3-28
<b>DP/DTMF Stations</b> .....	<b>3-29</b>
<b>DP to DTMF Signal Conversion</b> .....	<b>3-29</b>
<b>Hunting Priority for VAUs</b> .....	<b>3-30</b>
<b>Independent Timers</b> .....	<b>3-32</b>
<b>Internal Hold Tone</b> .....	<b>3-32</b>
<b>Least Cost Routing (LCR)</b> .....	<b>3-33</b>
<b>Music-on-Hold</b> .....	<b>3-34</b>
<b>Night Service</b> .....	<b>3-35</b>
<b>Night Service</b> .....	<b>3-37</b>
<b>Off-Premises Extension</b> .....	<b>3-39</b>
<b>Paging</b> .....	<b>3-39</b>
<b>Power Failure Transfer</b> .....	<b>3-41</b>
<b>Remote Maintenance</b> .....	<b>3-42</b>
Remote Programming Mode .....	3-42
Remote Programming Using PCAS or DBS Manager .....	3-44
<b>Station Class of Service</b> .....	<b>3-45</b>
<b>Station Hunting</b> .....	<b>3-46</b>
Terminal and Circular Hunting .....	3-47
Terminal, Distributed and Longest Idle Hunting .....	3-49
<b>Station Message Detail Recording (SMDR)</b> .....	<b>3-51</b>
<b>T1 Interface</b> .....	<b>3-54</b>
<b>Telephony Services</b> .....	<b>3-56</b>
<b>Toll Restriction</b> .....	<b>3-58</b>
<b>Trunk Groups</b> .....	<b>3-61</b>
<b>Trunk Name Assignment</b> .....	<b>3-62</b>
<b>Trunk Queuing</b> .....	<b>3-63</b>
<b>Universal Night Answer</b> .....	<b>3-64</b>
<b>Voice Mail Ringing</b> .....	<b>3-65</b>
<b>VAU</b> .....	<b>3-66</b>
Recording and Playing Messages .....	3-66
<b>VAU Port Assignment</b> .....	<b>3-67</b>
<b>Walking TRS Class of Service</b> .....	<b>3-68</b>

---

**Chapter 4. Key Telephone Features** .....

<b>Key Phone</b> .....	<b>4-3</b>
<b>Absence Message</b> .....	<b>4-3</b>
<b>Auto Redial</b> .....	<b>4-6</b>

<b>Barge-In for Direct Lines</b> .....	<b>4-6</b>
<b>Busy Override</b> .....	<b>4-7</b>
<b>Call Coverage Groups</b> .....	<b>4-8</b>
<b>Call Duration Display</b> .....	<b>4-9</b>
<b>Call Forwarding</b> .....	<b>4-11</b>
<b>Call Hold</b> .....	<b>4-17</b>
Exclusive Hold .....	4-17
System Hold .....	4-18
<b>Call Park</b> .....	<b>4-21</b>
<b>Call Pickup</b> .....	<b>4-22</b>
Group Call Pickup .....	4-24
<b>Call Transfer</b> .....	<b>4-25</b>
Blind Transfer .....	4-25
Screened Transfer .....	4-27
<b>Call Waiting</b> .....	<b>4-29</b>
<b>Call Waiting/OHVA Text Reply</b> .....	<b>4-32</b>
<b>Caller ID Call Log</b> .....	<b>4-33</b>
<b>Camp-on</b> .....	<b>4-37</b>
<b>CO Line Key Trunk Access</b> .....	<b>4-38</b>
<b>Conference Calls</b> .....	<b>4-39</b>
<b>Delayed Ringing</b> .....	<b>4-42</b>
<b>Dial "0" for Attendant</b> .....	<b>4-42</b>
<b>Dial Tone Disable</b> .....	<b>4-44</b>
<b>Do-Not-Disturb (DND)</b> .....	<b>4-45</b>
<b>EM/24 Console</b> .....	<b>4-47</b>
<b>Flexible Function (FF) Keys</b> .....	<b>4-47</b>
<b>Handsfree Answerback</b> .....	<b>4-54</b>
<b>Handsfree Operation</b> .....	<b>4-55</b>
<b>Headset Operation</b> .....	<b>4-55</b>
<b>Hot Dial Pad</b> .....	<b>4-56</b>
Considerations .....	4-56
<b>Intercom Calling</b> .....	<b>4-56</b>
<b>Last Number Redial</b> .....	<b>4-59</b>
<b>Line Appearances</b> .....	<b>4-60</b>
<b>DSS/BLF Appearances</b> .....	<b>4-61</b>
Multi-CO (MCO) Appearances .....	4-63
Multi-Line (ML) Appearances .....	4-65
<b>ML/MCO Separation</b> .....	<b>4-66</b>
<b>Meet-Me Answer</b> .....	<b>4-67</b>
<b>Message Waiting/Callback Request</b> .....	<b>4-68</b>
<b>Non-Appearing Outside Lines</b> .....	<b>4-70</b>
<b>Offhook Signaling</b> .....	<b>4-71</b>
<b>Offhook Voice Announce (OHVA)</b> .....	<b>4-72</b>
<b>One-Touch Keys</b> .....	<b>4-74</b>
<b>One-Touch VM Access</b> .....	<b>4-78</b>
<b>Onhook Dialing</b> .....	<b>4-81</b>
<b>Pooled Trunk Access</b> .....	<b>4-81</b>

<b>Prime Line Preference</b> .....	<b>4-83</b>
<b>Private Line</b> .....	<b>4-84</b>
<b>Reminder Call</b> .....	<b>4-85</b>
<b>Ringling Line Preference</b> .....	<b>4-87</b>
<b>Saved Number Redial</b> .....	<b>4-87</b>
<b>Speed Dialing</b> .....	<b>4-88</b>
System Speed Dial .....	4-92
Speed Dial Linking .....	4-94
<b>Station Lockout</b> .....	<b>4-96</b>
<b>Trunk-to-Trunk Transfer</b> .....	<b>4-97</b>
<b>Voice Mail Transfer Key</b> .....	<b>4-98</b>

---

<b>Chapter 5. DSLT Features</b> .....	<b>5-1</b>
<b>DSLT</b> .....	<b>5-3</b>
<b>Absence Message</b> .....	<b>5-4</b>
<b>Auto Redial</b> .....	<b>5-6</b>
<b>Busy Override</b> .....	<b>5-6</b>
<b>Call Forwarding</b> .....	<b>5-7</b>
<b>Call Hold</b> .....	<b>5-11</b>
<b>Call Park</b> .....	<b>5-12</b>
<b>Call Pickup</b> .....	<b>5-14</b>
Direct Call Pickup .....	5-14
Group Call Pickup .....	5-15
<b>Call Transfer</b> .....	<b>5-16</b>
Blind Transfer .....	5-16
Screened Transfer .....	5-17
<b>Call Waiting</b> .....	<b>5-19</b>
<b>Camp-on</b> .....	<b>5-21</b>
<b>Conference Calls</b> .....	<b>5-22</b>
<b>Dial "0" for Attendant</b> .....	<b>5-23</b>
<b>Dial Tone Disable</b> .....	<b>5-24</b>
<b>Direct Trunk Access</b> .....	<b>5-24</b>
<b>Do-Not-Disturb (DND)</b> .....	<b>5-25</b>
<b>Intercom Calling</b> .....	<b>5-26</b>
<b>Last Number Redial</b> .....	<b>5-27</b>
<b>Meet-Me Answer</b> .....	<b>5-28</b>
<b>Message Waiting/Callback Request</b> .....	<b>5-29</b>
<b>Off-Hook Voice Announce (OHVA)</b> .....	<b>5-30</b>
<b>Onhook Dialing</b> .....	<b>5-32</b>
<b>Pooled Trunk Access</b> .....	<b>5-32</b>
<b>Reminder Call</b> .....	<b>5-33</b>
<b>Saved Number Redial</b> .....	<b>5-34</b>
<b>Speed Dialing</b> .....	<b>5-35</b>
Personal Speed Dialing .....	5-35
System Speed Dial .....	5-37

<b>Station Lockout</b> .....	<b>5-37</b>
------------------------------	-------------

---

<b>Chapter 6. SLT Features</b> .....	<b>6-1</b>
<b>Absence Message</b> .....	<b>6-3</b>
<b>Busy Override</b> .....	<b>6-5</b>
<b>Call Forwarding</b> .....	<b>6-6</b>
<b>Call Hold</b> .....	<b>6-10</b>
<b>Call Park</b> .....	<b>6-11</b>
<b>Call Pickup</b> .....	<b>6-12</b>
Direct Call Pickup .....	6-12
Group Call Pickup .....	6-13
<b>Call Transfer</b> .....	<b>6-14</b>
Blind Transfer .....	6-14
Screened Transfer .....	6-15
<b>Call Waiting</b> .....	<b>6-17</b>
<b>Camp-on</b> .....	<b>6-19</b>
<b>Conference Calls</b> .....	<b>6-20</b>
<b>Dial "0" for Attendant</b> .....	<b>6-21</b>
<b>Dial Tone Disable</b> .....	<b>6-22</b>
<b>Direct Trunk Access</b> .....	<b>6-23</b>
<b>Do-Not-Disturb (DND)</b> .....	<b>6-23</b>
<b>Intercom Calling</b> .....	<b>6-25</b>
<b>Last Number Redial</b> .....	<b>6-26</b>
<b>Meet-Me Answer</b> .....	<b>6-27</b>
<b>Message Waiting/Callback Request</b> .....	<b>6-28</b>
<b>Off-Hook Voice Announce (OHVA)</b> .....	<b>6-29</b>
<b>Pooled Trunk Access</b> .....	<b>6-30</b>
<b>Speed Dialing</b> .....	<b>6-31</b>
Personal Speed Dialing .....	6-31
<b>Station Lockout</b> .....	<b>6-33</b>

---

<b>Appendix A: CPC-EX 1.0 Updates</b> .....	<b>A-1</b>
<b>Compatibility</b> .....	<b>A-1</b>
<b>44-Series Phone Support</b> .....	<b>A-1</b>
Directory Mode .....	A-2
Variable Mode .....	A-2
Handset Mute .....	A-2
Off-Hook Monitoring .....	A-2
Analog Adapter .....	A-2
MSG (Message) Key .....	A-2
DSS/72 and EM/24 - Key Arrangement .....	A-2
<b>FF-Key Programming</b> .....	<b>A-3</b>
<b>Speed Dial Enhancements</b> .....	<b>A-3</b>
<b>Additional Serial Port</b> .....	<b>A-3</b>

<b>T1 Networking Capability</b> .....	<b>A-3</b>
<b>Modification to Toll Restriction Service</b> .....	<b>A-3</b>
<b>Maximum Time Priority Route Tables</b> .....	<b>A-3</b>
<b>SMDR Modifications</b> .....	<b>A-4</b>
<b>ISDN Support</b> .....	<b>A-4</b>
<b>Modification to T1 Signaling Types</b> .....	<b>A-4</b>
<b>Installation Notes</b> .....	<b>A-4</b>
CPC-EX Installation .....	A-4
<b>44-Series Enhanced Phone Features</b> .....	<b>A-7</b>
Directory Mode .....	A-12
Variable Mode .....	A-13
Handset Mute .....	A-15
Off-Hook Monitoring .....	A-16
Analog Adapter .....	A-16
MSG (Message) Key .....	A-18
DSS/72 Console - Key Arrangement .....	A-19
EM/24 - Key Arrangement .....	A-21
<b>Speed-Dial Enhancements</b> .....	<b>A-22</b>
<b>Additional Serial Port on CPC Card</b> .....	<b>A-24</b>
<b>T1 Networking</b> .....	<b>A-25</b>
Hardware Requirements .....	A-25
Network Extension to Extension Calling .....	A-26
Call Forwarding to Network Extensions .....	A-27
Paging Across Network Nodes .....	A-27
Network Route Selection .....	A-27
Remote CO Access .....	A-27
SMDR Network Support .....	A-28
Independent Node Attendant Assignment .....	A-28
<b>Settings Modified for Networking</b> .....	<b>A-28</b>
Extension Number Digits .....	A-28
SMDR Printing Mode 1: Outbound and Inbound .....	A-29
T1 Trunk Type .....	A-29
Extension Numbers .....	A-29
Forced LCR/NRS .....	A-29
<b>Other Changes to Programming Addresses</b> .....	<b>A-29</b>
Enhanced Programming Addresses .....	A-30
<b>Modification to Toll Restriction Service</b> .....	<b>A-30</b>
<b>Maximum Time Priority Route Tables</b> .....	<b>A-31</b>
<b>ISDN Support</b> .....	<b>A-31</b>
Hardware Requirements .....	A-31
Setting Modified for ISDN .....	A-32
<b>Modifications to SMDR</b> .....	<b>A-32</b>
Setting Modified for SMDR .....	A-33
<b>Modification to T1 Signaling Types</b> .....	<b>A-35</b>
Outgoing Signaling Type .....	A-35
Incoming Signaling Type .....	A-35



<b>Appendix B: CPC-All/B 8.0 Updates</b> .....	<b>B-1</b>
<b>Contents</b> .....	<b>B-2</b>
<b>44-Series Phone Support</b> .....	<b>B-3</b>
<b>Enhanced Phone Features</b> .....	<b>B-4</b>
Directory Mode .....	B-8
Variable Mode .....	B-9
Handset Mute .....	B-11
Off-Hook Monitoring .....	B-12
Separate Speaker Volumes for Internal vs. CO calls .....	B-12
Analog Adapter .....	B-13
MSG (Message) Key .....	B-15
DSS/72 Console - Key Arrangement .....	B-16
EM/24 - Key Arrangement .....	B-19
<b>Modification to Toll Restriction Service</b> .....	<b>B-20</b>
<b>TAPI Support</b> .....	<b>B-21</b>
<b>Key Telephone Installation Notes</b> .....	<b>B-21</b>
Desi Strip Cover .....	B-21
Key Telephone Wall Mounting Instructions .....	B-21

---

**Appendix C: CPC-All/B 9.0 Updates** .....

**C-1**

---

**Appendix D: CPC-All/B 9.1 Updates** .....

**D-1**

**Call Record** .....

**D-1**

---

**Appendix E: CPC-EX 2.0 Updates** .....

**E-1**

---

**Appendix F: CPC-EX 2.1 Updates** .....

**F-1**

**Call Record** .....

**F-1**

---

**Appendix G: CPC-M 3.2 Updates** .....

**G-1**

**Enhanced Features** .....

**G-1**

**Software Corrections** .....

**G-1**

        Off-Hook Voice Announce (OHVA) via API .....

**G-1**

        Small LCD Soft Key Support via API .....

**G-2**

        Call Record (OHVA) via API .....

**G-2**

---

**Appendix H: CPC-All/B 9.2 Updates** .....

**H-1**

**New Features** .....

**H-1**

**Software Corrections** .....

**H-1**

16-Port Voice Mail Support via API .....	H-1
Off-Hook Voice Announce (OHVA) via API .....	H-2
Small LCD Softkey Support via API .....	H-3
Call Record (OHVA) via API .....	H-3

---

**Appendix I: CPC-EX 2.3 Updates .....** **I-1**

New Features .....	I-1
Software Corrections .....	I-2
16-Port Voice Mail Support via API .....	I-3
Off-Hook Voice Announce (OHVA) via API .....	I-4
Small LCD Soft Key Support via API .....	I-4
Call Record (OHVA) via API .....	I-5
<b>Special Features .....</b>	<b>I-6</b>
*UNA Transfer .....	I-6
*UNA Call Reversion .....	I-7
*Forwarding to UNA for CO Held Call .....	I-8
*All Ring Group .....	I-10
*Private Password .....	I-11
*Additional RAI Access Method .....	I-14
ISDN Programming Flexibility .....	I-16
<b>CPC-EX Version 2.3.2 .....</b>	<b>I-20</b>
Affected Items .....	I-20
Feature Changes .....	I-20

---

**Index .....** **Index-1**

# About This Manual

## ***Software Versions Covered by This Manual***

This manual covers all versions of CPC-A, all versions of CPC-AII software through Version 7.0 and CPC-B software through Version 7.0.

Differences in feature availability or operation are noted within each feature description.

If you are using this manual for a single DBS system, make note of its software version in the following table. This note may be referenced by technicians or owners of the system.

<b>Software version information for systems shipped with this document</b>	
CPC Model:	Software Version:

## ***Organization***

This manual contains detailed descriptions of DBS features. The feature descriptions are organized according to the following categories:

<b>Feature Categories</b>	<b>Description</b>
System Features	System Features are either available on a system-wide basis or aid in the overall administration of the DBS.
Attendant Features	Attendant Features assist the attendant in serving as a central answering point. In addition, attendant features also provide special capabilities for monitoring and programming extensions.
Key Telephone Features	Key Telephone Features are available to DBS key phones. DBS key phones are proprietary digital sets that provide feature access through a combination of feature keys and access codes.
Digital Single-Line Telephone (DSLTL) Features	DSLTL Features are available to Digital Single-Line Telephones. DSLTLs provide digital audio quality and limited feature key access in a single-line set.
Single Line Telephone Features	SLT Features are available to industry-standard 2500 sets. Since SLTs are not equipped with feature keys, most features are accessed by using the dialpad and/or the switchhook.

## ***Purpose***

The purpose of this manual is to provide an overview of feature operation and requirements. Where applicable, the following types of information are provided for each feature.

<b>Types of information</b>	<b>Purpose</b>
Description	The Description section provides an overview of how the feature works and, in some cases, what it is typically used for.
Operation	The Operation section includes step-by-step instructions on how to use the feature.
Hardware Requirements	This section lists any special hardware that is required to use the feature.
Related Programming	The Related Programming section lists the programming subsystems associated with the feature.
Considerations	This section provides details on feature interactions and limitations.

---

# Chapter 1: List of Features

The following tables list the features available with the DBS. **Additional features are listed in the Appendix, which starts on page A-1 in the back of this manual.**

The following tables are included in this chapter:

<b>Topic</b>	<b>Page</b>
System Features	1-3
Attendant Features	1-5
Extension Features	1-6



Table 1-1. System Features

Feature	CPC-A				CPC-AII			CPC-B							
	3.0	3.1	3.2	3.3	6	6.1	7	1	2	3.1	4	5	6	6.1	7
Account Codes: Non-verified	x	x	x	x	x	x	x	x	x				x	x	x
Account Codes: Verified					x	x	x			x	x	x	x	x	x
Answer Supervision for Voice Mail					x	x	x					x	x	x	x
Auto Day Mode					x	x	x				x	x	x	x	x
Auto Set Relocation					x	x	x			x	x	x	x	x	x
Background Music	x	x	x	x	x	x	x	x	x	x	x	x	x	x	x
Battery Backup	x	x	x	x	x	x	x	x	x	x	x	x	x	x	x
Call Forward ID Code for Voice Mail		x	x	x	x	x	x	x	x	x	x	x	x	x	x
Caller ID						x	x							x	x
Caller ID Auto DISA						x	x							x	x
Centrex/PBX Compatibility			x	x	x	x	x		x	x	x	x	x	x	x
DID (Direct Inward Dialing)									x	x	x	x	x	x	x
DID Night Ringing Assignment												x	x	x	x
DID Delayed Ringing												x	x	x	x
DID/DNIS Flex. Ring Assign.												x	x	x	x
DID/DNIS Text Name Assign.												x	x	x	x
DID/DNIS To a Voice Mailbox													x	x	x
DISA	x	x	x	x	x	x	x	x	x	x	x	x	x	x	x
Direct Trunk Access	x	x	x	x	x	x	x	x	x	x	x	x	x	x	x
Distinctive Ringing					x	x	x			x	x	x	x	x	x
Door Box (Extension Port)							x								x
Door Box (Trunk Port)	x	x	x	x	x	x	x	x	x	x	x	x	x	x	x
DP/DTMF Stations	x	x	x	x	x	x	x	x	x	x	x	x	x	x	x
DP to DTMF Signal Conversion	x	x	x	x	x	x	x	x	x	x	x	x	x	x	x
Hunting Priority for VAUs					x	x	x					x	x	x	x
Independent Timers					x	x	x			x	x	x	x	x	x
Internal Hold Tone							x								x
Key Bank Hold	x	x	x	x	x	x	x	x	x	x	x	x	x	x	x
Least Cost Routing	x	x	x	x	x	x	x	x	x	x	x	x	x	x	x
Music-on-Hold	x	x	x	x	x	x	x	x	x	x	x	x	x	x	x
Night Service	x	x	x	x	x	x	x	x	x	x	x	x	x	x	x
Night Service (2 Modes)							x								x
Off-Premises Extension	x	x	x	x	x	x	x	x	x	x	x	x	x	x	x
Paging	x	x	x	x	x	x	x	x	x	x	x	x	x	x	x

Feature	CPC-A				CPC-AII			CPC-B							
	3.0	3.1	3.2	3.3	6.6	6.1	7	1	2	3.1	4	5	6	6.1	7
Power Failure Transfer	x	x	x	x	x	x	x	x	x	x	x	x	x	x	x
Remote Maintenance	x	x	x	x	x	x	x	x	x	x	x	x	x	x	x
Sensor	x	x	x	x	x	x	x	x	x	x	x	x	x	x	x
Station Class of Service					x	x	x			x	x	x	x	x	x
Station Hunting: Terminal and Circular	x	x	x	x				x							
Station Hunting: Terminal, Distributed, Longest Idle					x	x	x		x	x	x	x	x	x	x
Station Message Detail Recording (SMDR)	x	x	x	x	x	x	x	x	x	x	x	x	x	x	x
T1 Interface											x	x	x	x	x
Telephony Services							x								x
Toll Restriction	x	x	x	x	x	x	x	x	x	x	x	x	x	x	x
Trunk Groups	x	x	x	x	x	x	x	x	x	x	x	x	x	x	x
Trunk Name Assignment					x	x	x		x	x	x	x	x	x	x
Trunk Queuing	x	x	x	x	x	x	x	x	x	x	x	x	x	x	x
Universal Night Answer	x	x	x	x	x	x	x	x	x	x	x	x	x	x	x
Voice Mail Ringing					x	x	x			x	x	x	x	x	x
VAU (Voice Announce Unit)	x	x	x	x	x	x	x	x	x	x	x	x	x	x	x
VAU Port Assignment					x	x	x					x	x	x	x
Walking TRS Class of Service					x	x	x			x	x	x	x	x	x



**Table 1-2. Attendant Features**

Feature	CPC-A				CPC-A II			CPC-B							
	3.0	3.1	3.2	3.3	6	6.1	7	1	2	3.1	4	5	6	6.1	7
Alternate Attendant	x	x	x	x				x							
Attendant Assignment of Speed Dialing	x	x	x	x	x	x	x	x	x	x	x	x	x	x	x
Attendant Busy Override					x	x	x		x	x	x	x	x	x	x
Attendant Call Park	x	x	x	x	x	x	x	x	x	x	x	x	x	x	x
Attendant Control of Absence Messages, Call Forwarding, and DND	x	x	x	x	x	x	x	x	x	x	x	x	x	x	x
Attendant-Controlled Text Assignment	x	x	x	x	x	x	x	x	x	x	x	x	x	x	x
Attendant Feature Package									x	x	x				
Attendant Groups					x	x	x		x	x	x	x	x	x	x
Dial Tone Disable	x	x	x	x	x	x	x	x	x	x	x	x	x	x	x
DSS/72	x	x	x	x	x	x	x	x	x	x	x	x	x	x	x
Headset Operation	x	x	x	x	x	x	x	x	x	x	x	x	x	x	x
One-Touch VM Transfer					x	x	x					x	x	x	x
Station Lockout Code Assignment	x	x	x	x	x	x	x	x	x	x	x	x	x	x	x
System Time and Date Control	x	x	x	x	x	x	x	x	x	x	x	x	x	x	x
Traffic Measurement	x	x	x	x	x	x	x	x	x	x	x	x	x	x	x
Voice Mail Transfer Key					x	x	x						x	x	x
Walking COS Confirmation					x	x	x			x	x	x	x	x	x

Table 1-3. Extension Features

Feature	CPC-A				CPC-A II			CPC-B							
	3.0	3.1	3.2	3.3	6	6.1	7	1	2	3.1	4	5	6	6.1	7
Absence Message	x	x	x	x	x	x	x	x	x	x	x	x	x	x	x
Auto Redial							x								x
Barge-In for Direct Lines					x	x	x					x	x	x	x
Busy Override	x	x	x	x	x	x	x	x	x	x	x	x	x	x	x
Call Coverage Groups	x	x	x	x	x	x	x	x	x	x	x	x	x	x	x
Call Duration Display	x	x	x	x	x	x	x	x	x	x	x	x	x	x	x
Call Forwarding	x	x	x	x	x	x	x	x	x	x	x	x	x	x	x
Call Hold: Exclusive and System	x	x	x	x	x	x	x	x	x	x	x	x	x	x	x
Call Park	x	x	x	x	x	x	x	x	x	x	x	x	x	x	x
Call Pickup: Direct and Group	x	x	x	x	x	x	x	x	x	x	x	x	x	x	x
Call Transfer: Blind and Screened	x	x	x	x	x	x	x	x	x	x	x	x	x	x	x
Call Waiting	x	x	x	x	x	x	x	x	x	x	x	x	x	x	x
Call Waiting/OHVA Text Reply					x	x	x				x	x	x	x	x
Caller ID Call Log						x	x							x	x
Camp-on	x	x	x	x	x	x	x	x	x	x	x	x	x	x	x
CO Line Key Trunk Access	x	x	x	x	x	x	x	x	x	x	x	x	x	x	x
Conference Calls	x	x	x	x	x	x	x	x	x	x	x	x	x	x	x
Delayed Ringing					x	x	x		x	x	x	x	x	x	x
Dial "0" for Attendant	x	x	x	x	x	x	x	x	x	x	x	x	x	x	x
Direct Trunk Access	x	x	x	x	x	x	x	x	x	x	x	x	x	x	x
Do-Not-Disturb (DND)	x	x	x	x	x	x	x	x	x	x	x	x	x	x	x
EM/24 Console	x	x	x	x	x	x	x	x	x	x	x	x	x	x	x
Flexible Function (FF) Keys	x	x	x	x	x	x	x	x	x	x	x	x	x	x	x
Handsfree Answerback	x	x	x	x	x	x	x	x	x	x	x	x	x	x	x
Handsfree Operation	x	x	x	x	x	x	x	x	x	x	x	x	x	x	x
Headset Operation	x	x	x	x	x	x	x	x	x	x	x	x	x	x	x
Hot Dial Pad					x	x	x						x	x	x
Intercom Calling	x	x	x	x	x	x	x	x	x	x	x	x	x	x	x
Last Number Redial	x	x	x	x	x	x	x	x	x	x	x	x	x	x	x
Line Appearances	x	x	x	x	x	x	x	x	x	x	x	x	x	x	x
DSS/BLF Appearances: Direct Line (DL)					x	x	x		x	x	x	x	x	x	x
DSS/BLF Appearances: Multi-CO (MCO)	x	x	x	x	x	x	x	x			x	x	x	x	x

Feature	CPC-A				CPC-A II			CPC-B							
	3.0	3.1	3.2	3.3	6	6.1	7	1	2	3.1	4	5	6	6.1	7
DSS/BLF Appearances: Multi-Line (ML) Appearances					x	x	x		x	x	x	x	x	x	x
ML/MCO Separation					x	x	x				x	x	x	x	x
Meet-Me Answer	x	x	x	x	x	x	x	x	x	x	x	x	x	x	x
Message Waiting/Callback Request	x	x	x	x	x	x	x	x	x	x	x	x	x	x	x
Non-appearing Outside Line	x	x	x	x	x	x	x	x	x	x	x	x	x	x	x
Offhook Signaling	x	x	x	x	x	x	x	x	x	x	x	x	x	x	x
Off-Hook Voice Announce (OHVA)	x	x	x	x	x	x	x	x	x	x	x	x	x	x	x
One-Touch Keys	x	x	x	x	x	x	x	x	x	x	x	x	x	x	x
One-Touch VM Access					x	x	x					x	x	x	x
Onhook Dialing	x	x	x	x	x	x	x	x	x	x	x	x	x	x	x
Pooled Trunk Access	x	x	x	x	x	x	x	x	x	x	x	x	x	x	x
Prime Line Preference	x	x	x	x	x	x	x	x	x	x	x	x	x	x	x
Private Line	x	x	x	x	x	x	x	x	x	x	x	x	x	x	x
Reminder Call	x	x	x	x	x	x	x	x	x	x	x	x	x	x	x
Ringling Line Preference	x	x	x	x	x	x	x	x	x	x	x	x	x	x	x
Saved Number Redial	x	x	x	x	x	x	x	x	x	x	x	x	x	x	x
Speed Dial Linking	x	x	x	x	x	x	x	x	x	x	x	x	x	x	x
Speed Dialing: System and Personal	x	x	x	x	x	x	x	x	x	x	x	x	x	x	x
Station Lockout	x	x	x	x	x	x	x	x	x	x	x	x	x	x	x
Trunk-to-Trunk Transfer (Unsupervised Conference)	x	x	x	x	x	x	x	x	x	x	x	x	x	x	x



---

# Chapter 2. Attendant Features

This chapter describes features that are available to an attendant phone.

In addition to functioning as a central answering point, an attendant phone also has special capabilities for monitoring and programming other phones.

This chapter covers the following topics:

<b>Topic</b>	<b>Page</b>
Alternate Attendant	2-3
Attendant Assignment of Speed Dialing	2-3
Attendant Busy Override	2-4
Attendant Call Park	2-5
Attendant Control of Absence Messages,	2-7
Attendant-Controlled Text Assignment	2-8
Attendant Feature Package	2-10
Attendant Groups	2-11
Dial Tone Disable	2-12
DSS/72	2-13
Headset Operation	2-17
Key Bank Hold	2-18
One-Touch VM Transfer	2-18
Station Lockout Code Assignment	2-21
System Time and Date Control	2-22
Traffic Measurement	2-24
Walking COS Confirmation	2-25



---

# Alternate Attendant

(CPC-A and CPC-B Versions Prior to 2.0)

## **Description**

The alternate attendant receives intercom calls directed to the primary attendant if the primary attendant is busy or out of service.

In addition to receiving overflow intercom calls, the alternate attendant has full access to attendant features.

With CPC-B 2.0 and above, the “Alternate Attendant” program is replaced by the Second, Third, and Fourth Attendant Positions.

## **Considerations**

**Alternate Attendant Extension Number.** The alternate attendant is always extension number 11 or 101. By default, extension 11 or 101 is assigned to port 2. To assign another port as an alternate attendant, you must assign extension number 11 or 101 to that port.

---

# Attendant Assignment of Speed Dialing

(All Versions)

## **Description**

The attendant can assign system speed dialing numbers. System speed dialing numbers are shared by all DBS extensions.

## **Operation**

1. Press the **ON/OFF** key.
  - The phone issues intercom dial tone.
  - The **ON/OFF** LED lights.
2. Press the **PROG** key.

“F” appears on the display.
3. Press **AUTO**.

“FA” appears on the display.

4. Enter the Speed Dial code (00-89 or 000-199).  
“Enter SSD XX” appears on the display (where “XX” is the System Speed Dial code).
5. To select pooled trunk access, press **CONF** followed by the last digit of the pooled trunk number (9, 1-6).
6. Dial the telephone number to be stored.  
  
For each pause required, press **REDIAL**. (An **R** appears on the display when **REDIAL** is pressed . If the Speed Dial number is later displayed, a **P** appears.)  
  
The number appears on the display.
7. Press the **HOLD** key.  
  
“SSD XX” (where “XX” is the Speed Dial code) and the stored telephone number appear on the display.
8. Repeat steps 2 to 7 to store additional numbers.

### **Considerations**

- Storing a new number erases any previously stored data.
- To delete a System Speed Dial number, perform the programming steps, but do not enter a number before pressing **HOLD**.
- Names for System Speed Dialing can also be stored using a DSS console connected to the attendant phone.

---

## **Attendant Busy Override**

(CPC-AII and CPC-B Version 2.0 or higher)

### **Description**

The Attendant Busy Override feature allows the attendant to break in on an Intercom Call or a CO Call that is already in progress.

Attendant Busy Override can break into any extension, even if the extension has “Busy Overridden” turned off. (The extension feature “Busy Override” cannot break into an extension that has “Busy Overridden” turned off.)

System programming determines whether the override is preceded by an alert tone. By default, Attendant Override does not sound an alert tone.



## **Operation**

### **To override a busy extension:**

Press “4.”

“CONF XXX YYY” (where “XXX” and “YYY” are the extension numbers) appears on the display.

## **Related Programming**

- FF1 (System): Attendant Override
- FF1 (System): Alert Tone for Busy Override & OHVA

## **Considerations**

- Replace the handset to exit the three-party conference call.
- The alert tone can be turned on or off through system programming.

---

# **Attendant Call Park**

(All Versions)

## **Description**

Using the Attendant Call Park feature, the Attendant may park an outside call until the called party can be found. The attendant can then use the Paging feature to inform the called party of the call’s Park Number. The parked call can then be retrieved from any extension by dialing the Park Number.

The attendant phone is equipped with ten outside line Park Numbers (00-09). Programming a Call Park key into an FF key on a telephone or a DSS console makes one-touch Call Park possible.

## **Operation**

### **To park an outside call:**

1. Press the **HOLD** key.

- The outside call is placed on hold.
  - “CO HOLD #XX” (where “XX” is the trunk number) appears on the display.
2. Dial “75.”  
“PARK HOLD” appears on the display.
  3. Enter desired Park Number (00-09).  
“PARK HOLD 01” appears on the display if you selected Park Number 01.

**To retrieve a call parked by the attendant (after receiving the Park Number from the Attendant):**

1. Pick up the handset.  
The phone issues intercom dial toned.
2. Dial “76.”
3. Enter the Park Number assigned to the call.  
“PARK PICK XX” (where “XX” is the park number) appears, and then  
“CO TALK #XX” (where “XX” is the trunk number of the call) appears.

### ***Related Programming***

- FF1 (System): Attendant Park Hold Recall Timer

### ***Considerations***

- With CPC-A and CPC-B Versions prior to 3.1, an FF key assigned to Call Park does not indicate when a call is parked. Beginning with CPC-B Version 3.1, the FF key lights red to indicate a call is parked.
- If a parked call is not answered before the Attendant Park Hold Recall Timer expires, the parked call recalls to the attendant.
- Intercom calls cannot be parked.

---

# Attendant Control of Absence Messages, Call Forwarding, and DND

(All Versions)

## *Description*

An attendant phone can cancel the Absence Message, Call Forwarding, and Do-Not-Disturb (DND) features activated on any extension.

## *Operation*

### To cancel an Absence Message, Call Forwarding, or DND:

1. Press the **ON/OFF** key.
  - The phone issues intercom dial tone.
  - The **ON/OFF** LED lights.
2. Press the **CONF** key.
3. Dial the extension number.
4. Press “\*.”
5. Press the **ON/OFF** key.

The **ON/OFF** LED goes off.

## *Considerations*

- On DSS consoles equipped with DSS keys, the indicator for an extension that has Absence Message, Call Forwarding, or DND activated lights green. This indicator goes off when the feature is canceled. The indicator does not light for Permanent Call Forwarding.

---

# Attendant-Controlled Text Assignment

(All Versions)

## ***Description***

The attendant can assign text to extensions, system speed dial numbers, and Call Waiting/OHVA text replies without using a DSS/72 or entering the programming mode.

Text is assigned through the dial pad on the attendant phone.

## ***Operation***

### **To assign names to extensions:**

1. Pick up the receiver or press the **ON/OFF** key.
2. Press **PROG**.
3. Dial #2.
4. Enter the extension's port number. (This must be entered as a 3-digit number if CPC-B is used or a 2-digit number if CPC-A or CPC-AII is used. If necessary add leading zeros.)
5. Press **AUTO** to backspace and erase the existing name.
6. Use the dialpad sequences shown in Table 2-1 on page 2-10 to enter letters and/or numbers.

Press **FLASH** after each letter or number.

Press **CONF** to switch between numbers and letters.

7. To store your entry, press **HOLD**.

### **To assign names to System Speed Dial numbers:**

1. Pick up the receiver or press the **ON/OFF** key.
2. Press **PROG**.
3. Dial #1
4. Press **AUTO**.
5. Dial the desired of system speed dial number (00-89).

6. Press **AUTO** to backspace and erase the existing name.
7. Use the dialpad sequences shown in Table 2-1 on page 2-10 to enter letters and/or numbers.

Press **FLASH** after each letter or number.

Press **CONF** to switch between numbers and letters.

8. To store your entry, press **HOLD**.

**Note:** The name does not change on the extension until the extension goes off hook.

**To assign text to Call Waiting/OHVA Text Replies (CPC-All and CPC-B Version 4.0 or higher):**

1. Pick up the handset or press **ON/OFF**.
2. Press **PROG**.
3. Dial #5
4. Dial 1-5, depending on which text message you want to change.
5. Press **AUTO** to backspace and erase the existing name.
6. Use the dialpad sequences shown in Table 2-1 on page 2-10 to enter letters and/or numbers.

Press **FLASH** after each letter.

Press **CONF** to switch between numbers and letters.

7. To store your entry, press **HOLD**.

*Table 2-1. Key sequences for text assignment.*

Key	Number of Key Presses					
	Once	Twice	Three times	Four times	Five times	Six times
1	Space	Q	Z	Space	q	z
2	A	B	C	a	b	c
3	D	E	F	d	e	f
4	G	H	I	g	h	i
5	J	K	L	j	k	l
6	M	N	O	m	n	o
7	P	R	S	p	r	s
8	T	U	V	t	u	v
9	W	X	Y	w	x	y
0	.	:	.	:	.	:
*	*	-	?	*	-	?
#	#	/	!	#	/	!

---

## Attendant Feature Package

(CPC-B Version 2.0 - 4.0)

### *Description*

The Attendant Feature Package (AFP) software affects the attendant's DSS console.

**Note:** The Attendant Feature Package was discontinued in CPC-B Version 5.0.

When the AFP is installed, the DSS console provides the following pre-configured features:

- Z 0-7 (Paging Zones)
- P 0-9 (Park keys)
- **NIGHT** key
- **BUSY** key

- **WAIT** key
- **OHVA** key
- **EXT** key
- **SSD** key
- **STATE** key
- **RESET** key
- **ALM** key
- **MSG** key
- **CNCT** (connect) key
- **CNCL** (Cancel) key
- Configuration of line/loop keys on large display as multiline
- Ability to assign line/loop keys to FF keys
- 26 search keys for extensions
- 2 arrow keys.

---

## Attendant Groups

(CPC-AII and CPC-B Version 2.0 or higher)

### *Description*

The DBS can accommodate up to four attendant positions. The first attendant is fixed at port 1, extension 100. The other Attendants can be set to any port or extension. When there is more than one attendant in a system, you can create an Attendant Group with a pilot number of 0.

When all Multi-Line keys on the first attendant phone are busy, internal calls are forwarded to the second, third, and fourth attendant phones, in that order.

### *Related Programming*

- FF1 (System): Second Attendant Position
- FF1 (System): Third Attendant Position

- FF1 (System): Fourth Attendant Position
- FF1 (System): Attendant Transfer Extension

## **Considerations**

- If all ML keys on all attendants are busy, internal calls are transferred to a preset destination, which must be a real extension number. The forwarding destination cannot be the pilot number of a hunt group.
- The third and fourth attendants cannot have a DSS/72.
- Prior to CPC-B Version 2.0, the DBS supported a maximum of two attendant positions.
- In previous software releases, if a user dialed “0” for the attendant group but the first attendant had call forwarding activated, the call would skip to the next attendant in the group. For example, if the first attendant activated call forwarding--busy/no answer, the dial “0” call would skip to the second attendant. If all attendants in the group activated call forwarding, dial “0” calls did not reach the group.

Beginning with CPC-B Version 5.0, dial “0” calls ring the first attendant, even if the first attendant has call forwarding activated. However, if a call is unanswered, it does not skip to the next attendant. The call continues to ring the first attendant until the caller hangs up.

- DSLTs and SLTs cannot be used for attendant positions.
- Ringing assignments will be required for all attendants other than Attendant Position 1 (Port 1) and Attendant Position 2 (when assigned to port 2).

---

## **Dial Tone Disable**

(All Versions)

### **Description**

The intercom dial tone can be turned off at an attendant phone. Dial tone is turned off when a headset is used.



## **Operation**

### **To disable the intercom dial tone:**

1. Press the **ON/OFF** key.
  - The phone issues intercom dial tone.
  - The **ON/OFF** LED lights.
2. Press “#50.”
3. Press the **ON/OFF** key.

The **ON/OFF** LED goes off.

### **To reactivate dial tone:**

Repeat the preceding steps.

---

## **DSS/72**

(All Versions)

### **Description**

The DSS/72 is a 72-key console that can be attached to the attendant phone.

The 72 keys of the DSS can be programmed as Direct Station Select (DSS) keys for internal lines. In addition to providing direct station selection, the DSS keys also provide busy lamp fields to assist the attendant in monitoring the status of extensions.

The attendant can perform a simplified call transfer by pressing a DSS key while connected to an outside line. The outside line is placed on hold and the extension is dialed automatically.

When the attendant is placed in the programming mode, the DSS can be used for inputting text names. Figure 1-1 shows which keys are pressed for text input.

Figure 1-1. VB-43225 with a DSS/72

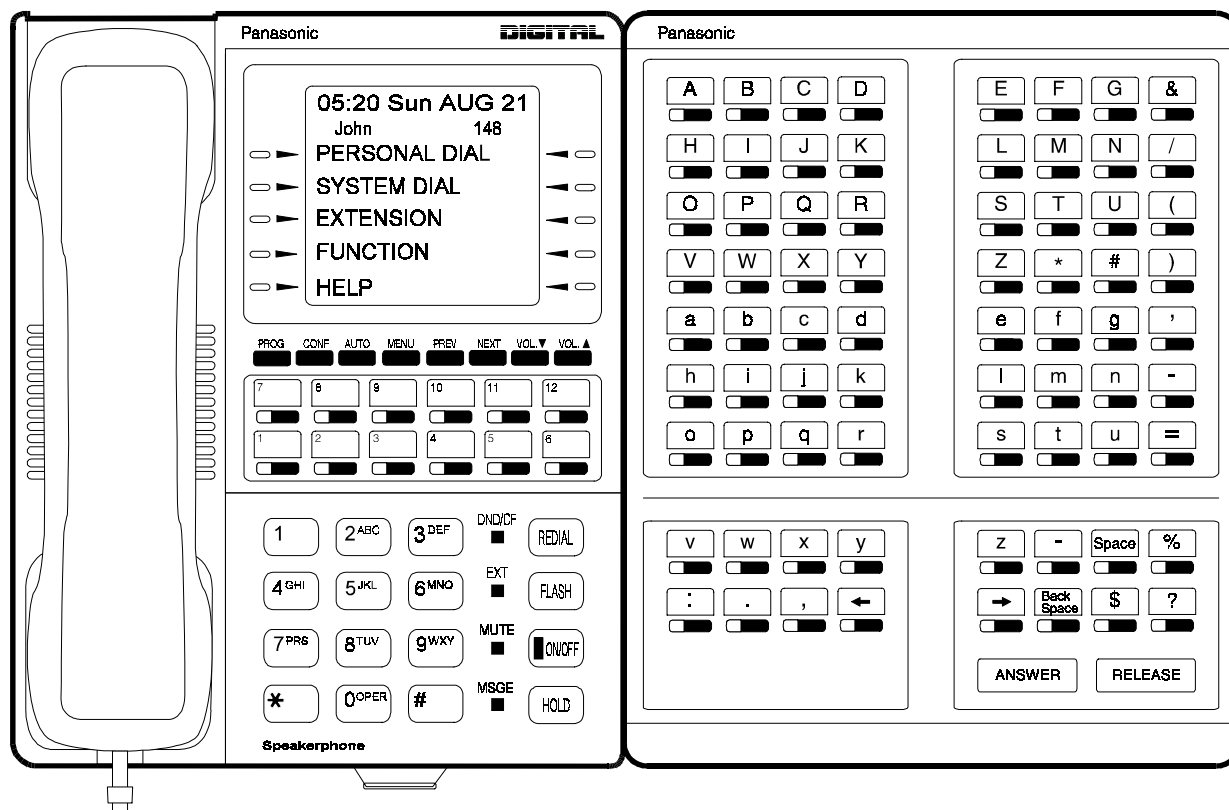

When the Attendant Feature Package (VB-43330) is installed, the DSS/72 can be used as an Attendant Console. The attendant console provides station monitoring and call transfer by name for large systems, even if a large display phone is not used.

Please refer to “Appendix A: CPC-EX 1.0 Updates” and “Appendix B: CPC-All/B 8.0 Updates” for additional information on the new telephones and DSS/72 available for the DBS system.

**Note:** Beginning with CPC-B Version 5.0, the Attendant Feature Package (AFP) is no longer available.

As Figure 1-2 illustrates, the Attendant Console includes preassigned keys for attendant functions, such as Call Park, Zone Paging, and alarm monitoring.

For a detailed description of the Attendant Console, see the *Attendant Console User’s Guide* (Section 760).

Figure 1-2. VB-43225 with a DSS/72 configured as an Attendant Console

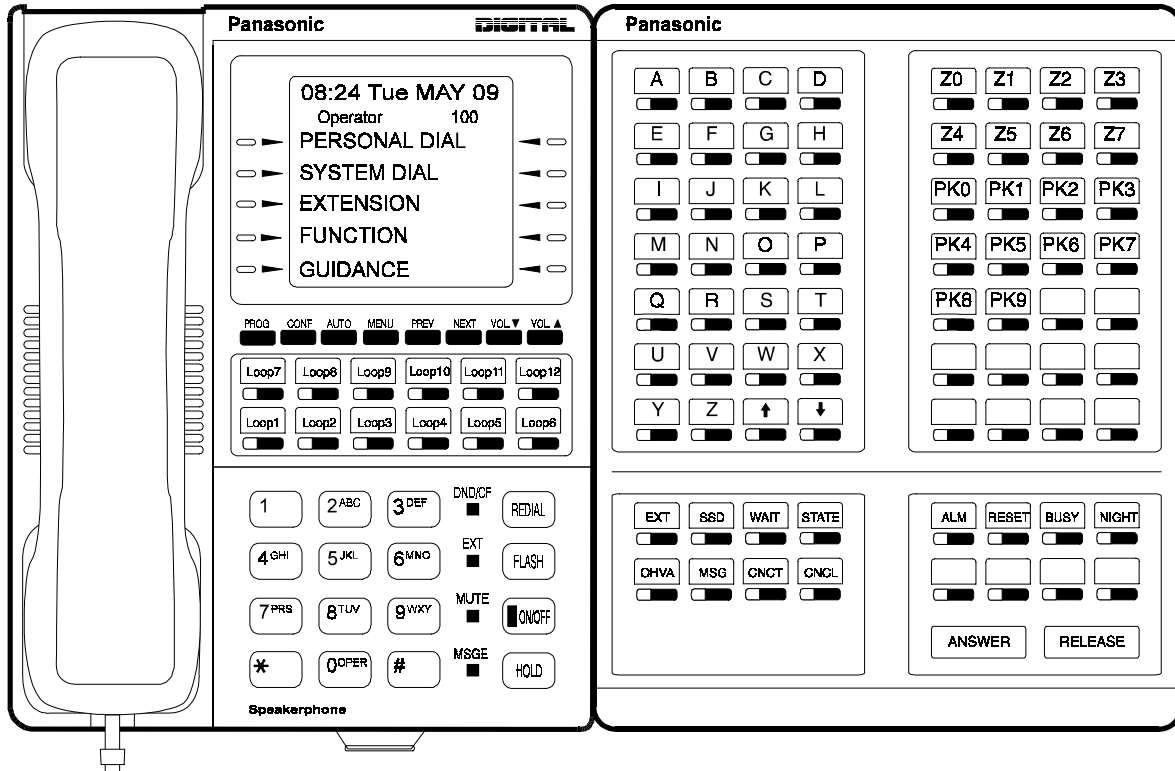

## Related Programming

- FF1 (System): Attendant Feature Package Settings

**Note:** Beginning with CPC-B Version 5.0, the Attendant Feature Package (AFP) is no longer provided.

- FF3 (Extensions): Terminal Type

## Hardware Requirements

- The “Attendant Feature Package” is required to configure the DSS/72 as an Attendant Console. The “Attendant Feature Package” is contained on a special EPROM chip that replaces an EPROM on the CPC-B card.

**Note:** Beginning with CPC-B Version 5.0, the Attendant Feature Package (AFP) is no longer provided.

- The following table shows the number of DSS/72s and or Attendant Consoles that can be used.

Table 2-2. DSS/72 maximums

Release	Attendant Position	DSS/72 Assignments				
CPC-A CPC-AII and CPC-B without the AFP	Attendant 1	Ext 100 Port 1	DSS/72 Type 11	DSS/72 Type 12		
	Attendant 2	Ext 101 Port 2 or other	DSS/72 Type 13	DSS/72 Type 14		
	Attendant 3 (CPC-AII and CPC-B 2.0 or higher)	The DSS/72 cannot be assigned.				
	Attendant 4 (CPC-AII and CPC-B 2.0 or higher)	The DSS/72 cannot be assigned.				
CPC-B 2.0 to 4.0 with the AFP	Attendant 1	Ext 100 Port 1	Att. Console Type 16	or	DSS/72 Type 11	DSS/72 Type 12
	Attendant 2	Ext 101 Port 2 or other	Att. Console Type 17	or	DSS/72 Type 13	DSS/72 Type 14
	Attendant 3		Att. Console Type 18			
	Attendant 4		Att. Console Type 19			

- The DSS key LED informs the attendant of the status of assigned extensions. The LED lights red when the extension is busy and green when Absence Message, Call Forwarding, or DND is activated.
- Pressing a DSS key while connected to an outside line places the line on hold.

---

## Headset Operation

(All Versions)

### *Description*

A headset can be connected to attendant or non-attendant phones. (Dial tone is normally turned off when the headset is connected.)

### *Operation*

#### **To use a headset:**

1. Connect a headset to the telephone.
2. Press the **ON/OFF** key.
3. Press “#51.”

The **ON/OFF** LED remains lit.

#### **To stop using a headset:**

Repeat the preceding steps.

### *Hardware Requirements*

- Headsets are not provided with the DBS; they must be purchased separately.
- Most commercially available headsets (with ECM mike transducers) can be used.

### *Considerations*

- Headset Operation is not available with SLT telephones.

---

# Key Bank Hold

(All Versions)

## *Description*

Key bank hold allows a user on a trunk call to initiate another trunk call by simply pressing an FF key for another trunk. When the user presses the FF key, the first trunk call is automatically placed on system hold.

In addition, the attendant can use key bank hold with DSS/BLF keys to provide one-touch call transfer to an extension. For example, if the attendant phone has a DSS/BLF key assigned for extension 200, the attendant can answer an incoming trunk call and then press the DSS/BLF key to automatically transfer the call to 200.

If key bank hold is turned off, the user must press **HOLD** before accessing a second trunk or transferring a call.

## *Related Programming*

- FF1 (System): Trunk Line Automatic Hold (Key Bank Hold)

---

# One-Touch VM Transfer

(CPC-AII and CPC-B Version 5.0 or higher)

## *Description*

The VM key can be used by attendants to easily transfer incoming callers to an extension's voice mailbox. Beginning with CPC-B Version 5, when a user presses a voice mail key and then presses a DSS/BLF key, the digits programmed for the DSS/BLF key are transmitted to the voice mail system.

For example, if an attendant receives an incoming call for station 200 and the attendant knows that station 200 is busy because the DSS/BLF key is lit red, the attendant can press the VM key and then press the DSS/BLF key to automatically transfer the caller to 200's voice mailbox.

For a general description of the VM key as well as instructions on using the key for personal message retrieval, see "One-Touch VM Access" on page 4-78.

**Note:** See "Voice Mail Transfer Key" on page 4-98 for a similar transfer key. The Voice Mail Transfer Key provides faster operation but may not work with some voice mail systems since you do not wait for the Voice Mail system to

answer before pressing the DSS/BLF key. The One-Touch VM Access works with virtually every voice mail systems.

**Note:** The VM key is assigned differently, depending on whether it is used for personal message retrieval or attendant transfer. See the following “Operation” section for instructions.

## Operation

### To assign a voice mail key:

**Note:** You cannot program this feature if trunks are assigned to the key. First clear the FF assignments, then use the following procedures to assign the VM key.

1. Press the **ON/OFF** key.
  - The phone issues intercom dial tone.
  - The **ON/OFF** LED lights.
2. Press the **PROG** key.
3. Press the FF key, DSS key, or One-Touch key.
4. Press the **CONF** key.
5. Press the **AUTO** key.
6. Dial the voice mail extension number.
7. If the key is for personal message retrieval, enter a password (XXX or AUTO followed by a speed dial number) if desired. If the key is for attendant transfer to voice mail, do not enter a password but include any special codes (\* or #, for example) if they are required by the voice mail system.

**Note:** The length of the password and the VM extension number cannot exceed six digits. If the VM number and the password total more than six digits, assign the password to a personal or system speed dial number (00-99, 000-199 or 900-909). If you are accessing the Panasonic Voice Mail, it is best to include a # sign at the end of the password.

8. Press the **HOLD** key.

### Attendant Transfer to Voice Mail

1. Answer an incoming call.

The incoming caller asks to be transferred to an extension number.

2. Check the DSS/BLF key for the extension. If the light is red, press the VM key followed by the DSS/BLF key.

The incoming caller is transferred to the extension's mailbox.

### **Related Programming**

- FF5 (Keys): FF Key Assignment for Extensions
- FF5 (Keys): FF Key Assignments for DSS Consoles

### **Considerations**

- The VM key can be used with the Panasonic Voice Mail or with third-party voice mail systems.
- Once an extension is connected to voice mail, pressing a DSS/BLF key will transmit the extension number stored on the DSS/BLF key to the voice mail system, regardless of what state the DSS/BLF key is in. In other words, the extension number is transmitted whether the key is idle, ringing, or busy.

**Note:** DSS/BLF keys on the DSS/72 always light red when an extension is active; they do not flash red when an extension is ringing. The keys light green when an extension is forwarded.

- If the Panasonic Voice Mail is used, the extension number is transmitted through the API link and DTMF digits. If a third-party voice mail is used, the extension number is transmitted through DTMF digits only.
- With Panasonic Voice Mail, most attendants use port group scheduling that accesses a menu that asks for a mail box number. This port group scheduling is used so attendants can quickly dial the mailbox numbers of other users. To assign a personal VM key for an attendant using this port group scheduling, use a speed dial number to store the voice mail extension number, followed by an asterisk (\*), followed by the password . The asterisk causes Voice Mail to revert to the menu that connects the user to his or her personal mailbox.

**Note:** If an attendant wants one VM key for a personal mailbox and one for transferring to voice mail, the personal VM key must be assigned to the lowest-numbered FF key.

For example, if DSS keys 60 and 61 are assigned as VM keys, key 60 should be used for the attendant's personal mailbox. If VM keys are assigned to both the phone FF keys and the DSS keys, the lowest-numbered FF key on the phone should be used for the attendant's personal mailbox. If



the personal VM key is not assigned to the lowest-numbered key, it will not flash to indicate VM messages.

---

# Station Lockout Code Assignment

(All Versions)

## *Description*

The Station Lockout feature allows users to dial a Station Lockout code to restrict their phone from being used for outside calls.

Station Lockout codes can be assigned through the attendant phone.

## *Operation*

### To program a Station Lockout code:

1. Press the **ON/OFF** key.
  - The phone issues intercom dial tone.
  - The **ON/OFF** LED lights.
2. Press the **CONF** key.
3. Dial “#8.”
4. Dial the extension number.
5. Enter the desired key code (four digits).
6. Press the **HOLD** key.

“STORE XXXX” (where “XXXX” is the key code) appears on the display.
7. Press the **ON/OFF** key.

The **ON/OFF** LED goes off.

## *Considerations*

- A locked extension can be used for Intercom Calls.
- Station Lockout key codes can also be set through system programming.

---

# System Time and Date Control

(All Versions)

## *Description*

The date and time displayed on all system extensions are set from an attendant phone.

## *Operation*

### To set the date and time:

1. Press the **ON/OFF** key.
  - The phone issues intercom dial tone.
  - The current date and time are displayed on your LCD.
2. Press the **PROG** key.

“F” appears on the display.
3. Dial “##.”

“Program Mode:” appears on the first line of the display; “MAIN MODE” appears on the second line.
4. Press the FF1 key.

“SELECT SUB MODE” appears on the second line of the display.
5. Dial “1#.”

“1:DATE 2:TIME” appears.
6. Dial “1#.”

“MONTH/DAY/YEAR” appears.
7. Enter six digits for the month, day, and year.

For example, to set the date to March 3, 1993, enter “030393.”
8. Press #.

“TIME SET MODE” appears on the display.
9. Enter four digits for hours and minutes (24-hr. time).

For example, for 11:00 a.m., enter “1100.”

10. Press #.
11. Press the **ON/OFF** key.

The new date and time appear on the display.

### **To reset the minutes display to “00:”**

If the clock is five minutes slow or fast, you can re-synchronize the minutes setting to “00,” provided the current minutes display is between “:55” and “:05.”

1. Press the **ON/OFF** key.
  - The phone issues intercom dial tone.
  - The **ON/OFF** LED lights.
2. Press the **PROG** key.

“F” appears on the display.
3. Dial “#4.”

“Time Adjusted” appears on the display.
4. Press the **ON/OFF** key.

The **ON/OFF** LED goes off.

### **Considerations**

- The month is entered in numeric form, but is displayed as the name of the month.
- The day of the week is calculated automatically.

# Traffic Measurement

(All Versions)

## Description

An attendant phone can track the number of outgoing and incoming calls for each outside line number, as well as the number of times each System Speed Dial number is used. This information can be used to evaluate trunk usage and control costs.

### To view traffic measurements:

1. Press the **ON/OFF** key.
  - The phone issues intercom dial tone.
  - The **ON/OFF** LED lights.
2. Press the **CONF** key.
 

“C” appears on the display.
3. Dial the traffic measurement code from the table below.

For example, to check the number of outgoing calls made on an outside line 01, enter “#90,” then “01”. If 1234 outgoing calls have been made, “Outgoing01 1234” appears on the display.

Pressing the # key steps through the trunk and system speed dial numbers.

4. Press the **ON/OFF** key.
 

The **ON/OFF** LED goes off.

*Table 2-3. Traffic measurement options*

Operation	Code	Display
Check the number of outgoing calls made on an outside line	#90NN	“OutgoingNN”
Check the number of incoming calls to a specific trunk	#91NN	“Incoming NN”
Check the number of times a System Speed Dial number was used:	#92SS	“SYS-SPD SS”
Delete usage data:	#93	“Clear All Inform”
<b>Notes:</b>		
NN = CO line number (01-64); SS = System Speed Dial number (00-89 or 000-199)		

## **Considerations**

- The Traffic Measurement feature can be accessed from any display phone.
- Usage data cannot be cleared item by item.
- All data is retained until it is deleted, until 65,536 entries are made (at which point the figures are reset to zero) or a RAMCLEAR is performed.
- A backup battery protects memory contents in case of power failure.
- The System Speed Dial traffic measurement only includes outside calls.

---

# **Walking COS Confirmation**

(CPC-AII and CPC-B Version 3.1 or higher)

## **Description**

The attendant can check the Walking TRS Class of Service ID code of any extension.

For information on Walking TRS Class of Service, see “Walking TRS Class of Service” on page 3-68.

## **Operation**

1. Press **ON/OFF**.
2. Press **CONF**.
3. Dial #12 plus the extension number.

The Walking Class of Service ID code appears on the display.



---

# Chapter 3. System Features

This chapter contains detailed descriptions of DBS System Features. System Features are either available on a system-wide basis or aid in the overall administration of the DBS.

Please see the Appendices in the back of this manual for additional features.

This chapter covers the following topics:

Topic	Page
Account Codes	3-3
Answer Supervision for Voice Mail	3-6
Auto Day Mode	3-7
Auto Set Relocation	3-9
Background Music	3-11
Battery Backup	3-12
Call Forward ID Code for Voice Mail	3-13
Caller ID	3-14
Caller ID Auto DISA	3-15
Centrex/PBX Compatibility	3-16
Direct Inward Dialing (DID)	3-16
DID/DNIS Flexible Ring Assignments	3-18
DID/DNIS Text Name Assignment	3-19
DID/DNIS to a Voice Mailbox	3-20
Direct Inward System Access (DISA)	3-22
Direct Trunk Access	3-24
Distinctive Ringing	3-24
Door Box (Using Extension Adaptor)	3-25
Door Box (Using Trunk Adaptor)	3-27
DP/DTMF Stations	3-29
DP to DTMF Signal Conversion	3-29
Hunting Priority for VAUs	3-30
Independent Timers	3-32
Internal Hold Tone	3-32
Least Cost Routing (LCR)	3-33
Music-on-Hold	3-34
Night Service	3-35

<b>Topic</b>	<b>Page</b>
Off-Premises Extension	3-39
Paging	3-39
Power Failure Transfer	3-41
Remote Maintenance	3-42
Station Class of Service	3-45
Station Hunting	3-46
Station Message Detail Recording (SMDR)	3-51
T1 Interface	3-54
Telephony Services	3-56
Toll Restriction	3-58
Trunk Groups	3-61
Trunk Name Assignment	3-62
Trunk Queuing	3-63
Universal Night Answer	3-64
Voice Mail Ringing	3-65
VAU	3-66
VAU Port Assignment	3-67
Walking TRS Class of Service	3-68



---

# Account Codes

You can assign account codes to clients to facilitate billing and to track call dates and times, numbers called, and outside line numbers used. This information is printed for each account on the SMDR record.

## Non-Verified Account Codes

(CPC-A, CPC-AII, and CPC-B Versions prior to 3.1 and 6.0 and higher)

### *Description*

In CPC-A and CPC-B Versions prior to 3.1, account codes are not verified. With CPC-AII and with CPC-B Versions 6.0 and higher, account codes may be verified or non-verified depending on system programming.

Non-verified account codes can be *forced* or *voluntary*, depending on extension programming.

With voluntary account codes, the user is not forced to enter an account code before making a call. With forced account codes, the user must enter an account code before accessing an outside line.

Non-verified account codes can be assigned to incoming and outgoing calls. To assign an account code to an outgoing call, the user enters the account code before making the call or during the call. To assign an account code to an incoming call, the user enters the account code during the call.

### **To enter an Account Code before dialing:**

1. Press the **ON/OFF** key.
  - The phone issues intercom dial tone.
  - The **ON/OFF** LED lights.
2. Press the **AUTO** key, then press “#.”
  - “Enter Account #” appears on the display.
  - If you are using a Single Line Telephone (SLT) or Digital Single Line Telephone (DSLTL), dial “#7.”
3. Enter the Account Code (up to 10 digits).
4. Press “#.”

“Entered Account #” appears on the display.

5. Press a vacant CO key or dial a trunk access code.
6. Dial the telephone number.

#### **To enter an Account Code during an outside call:**

1. Press the **AUTO** key.
2. Press “#.”

“Enter Account #” appears on the display.

3. Enter the Account Code (up to 10 digits).

The Account Code entered appears on the display.

4. Press “#.”

### ***Hardware Requirements***

- An SMDR printer or external call accounting system is required to collect account code records.

### ***Related Programming***

- FF3 (Extension): Forced Account Codes

### ***Considerations***

- SLTs cannot assign account codes during a call.

## **Verified Account Codes**

(CPC-AII and CPC-B, Version 3.1 or higher)

### ***Description***

Extensions with the Verified Account Codes feature *enabled* are restricted from making outside calls without the user first entering a valid Account Code. After a valid Account Code is entered, the Toll Restriction Service (TRS) type assigned to the code is substituted for the extension TRS type, thus temporarily allowing calls based on the new TRS type.

Extensions with the Verified Account Codes feature *disabled* can place outside calls based on the TRS type assigned to the extension. If a user wishes to place a call that would normally be restricted at the extension, the user can enter a valid Verified Account Code to upgrade the TRS type assigned to the extension.

## **Operation**

1. Pick up the handset.

The phone issues intercom dial tone.

2. Dial “#11.”

3. Enter the four-digit Account Code.

4. Press “#.”

The phone issues intercom dial tone.

5. Press an available CO key or dial a trunk access code.

The phone issues outside dial tone.

6. Dial the telephone number.

The Verified Account Code TRS type remains in effect until the call is completed.

## **Related Programming**

- FF1 (System): Verified Forced Account Codes
- FF1 (System): Toll Restriction for Verified Forced Account Codes
- FF3 (Extension): Verified Forced Account Codes
- FF7 (TRS): Toll Restrictions

## **Hardware Requirements**

- An SMDR printer or external call accounting system is required to collect account code records.

## **Considerations**

- Verified account codes are for outgoing calls only.

- The maximum number of verified account codes is 100.
- Each verified account code must consist of 4 digits.
- “0000” cannot be used for a verified account code.
- Verified account codes do not override station lockout.
- Verified account codes do not override Least Cost Routing (LCR) settings.
- With CPC-AII and CPC-B Version 3.1 to 5.04, non-verified account codes can be used. However, they can only be used on a voluntary basis. Forced *non-verified* account codes are not available with CPC-B 3.1 to 5.04.

---

## Answer Supervision for Voice Mail

(CPC-AII and CPC-B Version 5.0 or higher)

### ***Description***

This feature allows the DBS to send an answer signal to third-party voice mail systems.

In previous releases, a third-party voice mail did not receive a signal to indicate that a DBS extension had answered. To determine that the extension had answered, the voice mail system had to wait until it stopped receiving ringback tone. Waiting for the ringback to stop often delayed connection times for calls from voice mail to extensions. Sending an answer signal provides quicker response time between the DBS and the voice mail system.

### ***Operation***

The following programming can be performed from an attendant phone or any other phone that has entered the programming access code.

#### **To assign an answer signal code:**

1. Press the **ON/OFF** key.
  - The phone issues intercom dial tone.
  - The **ON/OFF** LED lights.
2. Press the **PROG** key.
3. Dial “**#94.**”

4. Enter the Answer Signal Code (1 to 5 digits).
5. Press the **HOLD** key.

**To view an answer signal code:**

1. Press the **ON/OFF** key.
2. Press the **CONF** key.
3. Dial “#94.”

### **Considerations**

- The digits used for the answer signal code are determined by the requirements of the voice mail system.
- If the called extension does not answer and is forwarded to voice mail, the DBS sends a call forward ID code back to the voice mail system.
- During transmission of the answer signal code, other DTMF digits and functions from the DBS extension are ignored.

---

## **Auto Day Mode**

(CPC-AII prior to 7.0 and CPC-B Version 4.0 to 6.11)

### **Description**

Auto Day Mode allows the DBS to go into day mode automatically.

The DBS can also be programmed to go into night mode automatically (see “Night Service,” page 3-35).

If only one of the auto modes is turned on, the **NIGHT** key is used to turn off the auto mode. For instance, if night mode has been activated automatically, the attendant must press the **NIGHT** key to go into day mode.

If only one of the auto modes is turned on, the **NIGHT** key can also be used to go into an auto mode before the scheduled time.

If both auto day and auto night modes are turned on, the attendant **NIGHT** key **cannot** be used.

## ***Related Programming***

- FF1 (System): Automatic Day Mode Start Time
- FF1 (System): Automatic Night Mode Start Time

## ***Considerations***

- If both auto modes are set, the starting times must differ by at least one hour.
- When one auto mode is turned on, the mode cannot be reset by the **NIGHT** key until 3 minutes after the auto mode is activated. (When both auto modes are set, the **NIGHT** key cannot be used.)
- If a **NIGHT** key is not assigned, the access code #52 can be used instead.

---

# **Auto Day Mode**

(CPC-B Version 7.0 or higher and CPC-A II Version 7.0 and higher)

## ***Description***

Auto Day Mode allows the DBS to go into day mode automatically.

The DBS can also be programmed to go into night mode automatically (see “Night Service,” page 3-37).

If only one of the auto modes is turned on, the **DAY/NIGHT1/NIGHT2** toggle key or the **DAY**, **NIGHT1**, or **NIGHT2** is used to turn off the auto mode. For instance, if **NIGHT1** mode has been activated automatically, the attendant must press the **DAY/NIGHT1/NIGHT2** toggle key or the **DAY** key to go into day mode. (Note: You must wait at least 3 minutes after the automatic mode is activated before manually changing the mode. Otherwise the system will immediately revert back to the automatic mode.)

If only one of the auto modes is turned on, the **DAY/NIGHT1/NIGHT2** toggle key or the **DAY**, **NIGHT1**, or **NIGHT2** key can also be used to go into an auto mode before the scheduled time. If auto day and both auto night modes are turned on, the manual mode keys **can** be used.

## ***Related Programming***

- FF1 (System): Auto Day Mode Start Timer
- FF1 (System): Auto Night1 Mode Start Timer

- FF1 (System): Auto Night2 Mode Start Timer

## **Considerations**

- If all auto modes are set, the starting times must differ by at least one hour.
- When one auto mode is turned on, the mode cannot be reset by the NIGHT key until 3 minutes after the auto mode is activated. (When all auto modes are set, the mode keys cannot be used.)
- If mode keys are not set, the access codes #520 (DAY/NIGHT1/NIGHT2 toggle), #521 (DAY), #522 (Night1) or #523 (Night2) can be used instead.

---

# **Auto Set Relocation**

(CPC-AII and CPC-B Version 3.1 or higher)

## **Description**

Auto Set Relocation can be used to relocate the program settings of one extension to another extension.

Auto Set Relocation is commonly used when extension users want to trade work areas. For example, if Extensions “A” and “B” are going to switch office locations, Auto Set Relocation enables them to switch telephone settings without re-programming.

## **Operation**

Before a phone can be relocated, it must be assigned an Auto Set Relocation code. See “Related Programming” for the program address used to set up the Auto Set Relocation Code.

The following example illustrates how the program settings for extensions 200 and 300 could be switched.

### **To Transfer Extension Settings from 200 to 300:**

1. At extension 300, pick up the handset.
2. Press “#10.”
3. Dial extension number 200.

4. Enter the four-digit auto set relocation code assigned to extension 200.
5. Replace the handset.
  - All programmed extension features and TRS settings from 200 are transferred to 300.
  - Extension 300 are placed out of service.

#### **To Reactivate Extension 300:**

1. Unplug the extension cable from 300.
2. Reconnect the cable.

Extension 300 assumes all extension features, TRS, and LCR settings that were initially assigned to 200.

### ***Related Programming***

- FF3 (Extension): Auto Set Relocation Code

### ***Considerations***

- The following types of data can be transferred using this feature:
  - TRS type settings
  - Ring settings (trunk line, remote ringing, day/night, DID)
  - FF key data
  - Extension numbers and names
  - System call forward settings
  - All settings and data defined by programming.
- Settings may not be transferred between extensions of different types. In other words, an SLT and a KTEL cannot exchange program settings.
- Attendant 1 is excluded from this feature.



---

# Background Music

(All Versions)

## *Description*

If your system is set up to provide Background Music, music can be played from the speakers of idle telephones. If a call is made to an extension receiving Background Music, the music stops and the phone rings. Background Music is also interrupted when the phone goes offhook.

The system can also provide music-on-hold using the Background Music source or a separate music source. If Music-on-Hold is provided, callers automatically hear music when they are placed on hold. (See page 3-34 for more information on Music-on-Hold.)

## *Operation*

### **To turn Background Music on:**

1. Press the **ON/OFF** key.
  - The phone issues intercom dial tone.
  - The **ON/OFF** LED lights.
2. Dial “#53.”

“BGM ON” appears on the display.
3. Press the **ON/OFF** key.

The **ON/OFF** LED goes off.

### **To turn Background Music off:**

1. Press the **ON/OFF** key.
  - The phone issues intercom dial tone.
  - The **ON/OFF** LED lights.
2. Dial “#53.”

“BGM OFF” appears on the display.
3. Press the **ON/OFF** key.

- The **ON/OFF** LED goes off.
- The date and time appear on the display.

### **Related Programming**

- FF1 (System) Extension Class of Service Setting (CPC-AII and CPC-B 3.1 or higher)
- FF3 (Extension) Extension Class of Service Assignment (CPC-AII CPC-B 3.1 or higher)

### **Hardware Requirements**

- The music source must be purchased separately. It is not provided with the DBS.
- If a single music source is used for both Music-on-Hold and Background Music, the music source connects to the CN5 on the DBS. If a separate music source is used for background music, it connects directly to the SCC card. See *Installation (Section 300)* for instructions. Be sure to correctly set the option straps.
- The input impedance for the music source is 10k ohms.
- The maximum input level is 10 dB.



---

**Important:** A license may be required from the American Society of Composers, Authors, and Publishers (ASCAP) or similar organizations to transmit radio or recorded music through the Music-On-Hold feature. Panasonic Communications & Systems Company, its distributors, and affiliates assume no liability should users of Panasonic equipment fail to obtain such a license.

---

---

## **Battery Backup**

(All Versions)

### **Description**

The DBS two 12-volt batteries for battery backup. (Some DBS 72 and 96 systems use four older-style 6-volt batteries.) The backup batteries are connected in a series circuit, using cables provided with the DBS. With maximum traffic, the backup batteries last up to 40 minutes for the DBS 40 and 72, and up to 30 minutes for the DBS 96. The backup batteries should be replaced about every 3 years.

---

# Call Forward ID Code for Voice Mail

(CPC-A Version 3.1, CPC-AII, and all CPC-B Versions)

## *Description*

Call Forward ID Code for Voice Mail allows users to call forward to a third-party voice mail system. The ID Code sends the digits that are required by the voice mail to identify the DBS extension and allow it to retrieve messages.

With CPC-A or CPC-B Version 1.0, you can only set the ID Code from the phone to be forwarded. Beginning with CPC-B Version 2.0, ID Codes can be set from any key phone; this is also true of CPC-AII.

## *Operation*

### **To set a Call Forward ID Code for Voice Mail:**

1. Press the **PROG** key.
2. Press the **AUTO** key.
3. Press “\*.”
4. If you are using CPC-AII or CPC-B Version 2.0 or later, enter the extension number to be forwarded. If you are using CPC-A or CPC-B Version 1.0, go to Step 5.
5. Enter up to 16 digits (0-9) for the mail box ID code. (Press the **REDIAL** key to insert a pause.)
6. Press the **HOLD** key.

### **To clear the ID Code:**

1. Press the **PROG** key.
2. Press the **AUTO** key.
3. Press “\*.”
4. Enter the extension number.
5. Press the **HOLD** key.

## Considerations

- In CPC-A 3.1 and CPC-B Versions prior to 5.0, callers could hear the tones as the ID code was transmitted to the voice mail system. Beginning with CPC-A Version 3.3, CPC-AII and CPC-B Version 5.0, external callers do not hear the tones.
- The Extension Copy program (FF9 2# 1-144# 1-144##) should **not** be used to copy extension settings that include a Call Forward ID Code. Copying extension settings in this manner allows the copy “destination” to retrieve the messages of the copy “source.” For example, if you copy extension settings from extension 200 to extension 300, extension 300 can retrieve 200’s messages. Extension 300 can retrieve 200’s messages because the Call Forward ID Code for 200 is also assigned to 300.

---

## Caller ID

(CPC-A II Version 6.1 or higher and CPC-B Version 6.1 or higher)

### Description

A properly equipped DBS supports Caller ID (CID), a service offered by the network telephone service provider. The CO sends calling number information to the DBS after the first ring. Users who have display telephones can see CID information as incoming calls ring at their extension and can have access to previous calls via the Caller ID Call Log feature. The CID number is recorded in SMDR.

### Related Programming

- FF1 (System Programming): Call Duration Display
- FF1 (System Programming): Call Duration Timer
- FF5 (Key Assignments): FF Key Assignments for Extensions
- FF2 (Trunk): Trunk Type

### Hardware Requirements

- Loop-start trunk card (VB-43511A)
- Caller ID circuit card (VB-43511)
- MFR card (for Caller ID Auto DISA)

## **Considerations**

- Caller ID service must be ordered from the local telephone operating company or the interexchange carrier.

---

# **Caller ID Auto DISA**

(CPC-A II Version 6.1 or higher and CPC-B Version 6.1 or higher)

## **Description**

A DBS equipped for Caller ID (CID) can provide automatic DISA dial tone based on Caller ID information. This allows up to 10 predetermined users to access the DISA feature without requiring a trunk be left in the DISA mode.

When a CID call is sent to the DBS, the CID number is checked against the table. If the number is found, the caller will automatically be connected to DISA dial tone.

## **Related Programming**

- FF1 (System Programming): Automatic DISA

## **Hardware Requirements**

- Loop-start trunk card (VB-43511A)
- Caller ID circuit card (VB-43511)
- MFR card (Caller ID Auto DISA)

## **Considerations**

- Caller ID feature must be enabled.

---

# Centrex/PBX Compatibility

(CPC-A Version 3.2 or higher, CPC-AII, and CPC-B Version 2.1 or higher)

## *Description*

Centrex/PBX Compatibility allows the DBS to be connected to centrex or PBX lines.

The DBS supports up to 8 access codes for dialing centrex or a PBX. These access codes allow the DBS SMDR output to exclude the number dialed to reach a centrex or PBX line.

The DBS also supports transmission of a flash signal over the centrex or PBX link.

## *Related Programming*

- FF1 (System): PBX Access Code(s)
- FF2 (Trunks): Trunk Type
- FF8 (Least Cost Routing): LCR Add Tables

## *Considerations*

- The LCR Add Table can be used to prefix digits for outgoing calls through Centrex.

---

# Direct Inward Dialing (DID)

(CPC-B Version 2.0 or higher)

## *Description*

The Direct Inward Dialing (DID) feature allows an extension to have a dedicated direct number. The dedicated number allows calls to be made directly to the extension, without the caller going through the attendant.

Prior to CPC-B Version 3.1, only one DID number could be assigned to an extension. Beginning with CPC-B Version 3.1, one DID number can be assigned to several extensions, and one extension can have more than one DID number; this is also true of CPC-AII.

If a DID number is assigned to more than one extension, incoming calls to the DID number ring at all the assigned extensions simultaneously.

## ***Related Programming***

- FF1 (System): Multiple DID (CPC-B Version 3.1 or higher)
- FF3 (Extension): Inbound DID Dial Number (CPC-B Version 2.0 to 2.16)
- FF4 (Ring): DID, Delayed, Night , Delayed Night, Night 2, and Delayed Night 2 Ring Assignments

## ***Hardware Requirements***

- Either the T-1 Card or DID trunk card is required. Each DID trunk card provides 8 ports.
- The DID trunk card requires an external 48V power supply. See *Installation (Section 300)* for instructions.

## ***Considerations***

- The DID Trunk card supports 4-digit, dial-pulse DID.
- The T1 card supports 4-digit, dial-pulse or DTMF DID.
- DID numbers must be between 0000 and 9999.
- Beginning with CPC-B Version 3.1, a maximum of 500 DID/extension settings is allowed.

# **DID Night Ringing Assignment**

(CPC-B Version 5.0 or higher)

## ***Description***

For a description of this feature, see “DID/DNIS Flexible Ring Assignments” on page 3-18.

## DID Delayed Ringing

(CPC-B Version 5.0 or higher)

### *Description*

For a description of this feature, see “DID/DNIS Flexible Ring Assignments” on page 3-18.

---

## DID/DNIS Flexible Ring Assignments

(CPC-B Version 5.0 or higher)

### *Description*

DID/DNIS Flexible Ring Assignments allow night ringing and delayed ringing for specific DID/DNIS numbers.

### *Related Programming*

- FF1 (System): Delayed Ring
- FF1 (System): Central Office Delayed Ring Timer
- FF1 (System): Inbound DID Dial Numbers
- FF1 (System): DNIS Number Setting

### *Considerations*

- Timing for DID/DNIS delayed ringing is controlled by the Central Office Delayed Ring Timer.
- The system uses a DID Numbers Table for DID assignment. The DID Numbers Table allows up to 500 DID assignments. Each assignment consists of the DID number and an associated extension.
- The system uses a separate DNIS Numbers Table for DNIS assignment. The DNIS Numbers Table allows up to 500 DNIS assignments, with each assignment consisting of the DNIS number and an associated extension.
- When multiple extensions are assigned delayed ringing for the same DID/DNIS number, unanswered delay ringing forwards based on the extension with the lowest port number.

For example, if port numbers 125 and 126 both have delayed ringing for the



same DNIS number and both ports do not answer a delayed ringing call, the call follows the call forwarding settings of port 125.

---

## DID/DNIS Text Name Assignment

(CPC-B Version 5.0 or higher)

### *Description*

DID/DNIS Text Name Assignment allows the assignment of text names to specific DID/DNIS numbers. The text name can include up to six characters.

Text name assignments are especially useful when multiple DID or DNIS lines terminate to the same extension or group. For example, a call center may handle inquiries for three different companies. To easily identify which customer is being called, individual DID or DNIS numbers can be assigned for each customer, and then corresponding text names can be assigned to the DID or DNIS trunks.

Up to 200 DID text names and 200 DNIS text names can be assigned.

### *Related Programming*

- FF1 (System): Inbound DID Dial Numbers
- FF1 (System): DNIS Number Setting

### *Considerations*

- A DSS/72 is required to assign text names to DID/DNIS trunks.
- If text is assigned to a DID/DNIS number that rings at multiple extensions, all of the extensions will receive the text display.
- The text display follows forwarded calls and transferred calls.
- If text is not assigned to a DID/DNIS line, the number will display.

---

# DID/DNIS to a Voice Mailbox

(CPC-B Version 6.0 and higher)

## *Description*

DID/DNIS to a voice mailbox allows DID/DNIS calls to be routed to a voice mailbox that is not connected to a physical extension.

To implement this feature, the DID/DNIS trunks must be assigned to ring at the voice mail system. Once voice mail answers, the DBS sends a DID/DNIS Answer Code required by the voice mail system plus the final DID/DNIS digits to the voice mail system. The DID/DNIS Answer Code signals the voice mail system to open with a greeting and the DID/DNIS digits specify the appropriate mailbox.

## *Operation*

### **To assign a DID/DNIS Answer Code:**

1. Pick up the receiver or press the ON/OFF key.
2. Press **PROG**.
3. Dial **#95**.
4. Enter the DID/DNIS Answer code required by the voice mail system (1 to 6 digits).
5. Press **HOLD**.
6. Press the **ON/OFF** key.

The **ON/OFF** LED goes off.

### **To display a DID/DNIS Answer Code:**

1. Pick up the receiver or press the ON/OFF key.
2. Press **CONF**.
3. Dial **#95**.
4. Press the **ON/OFF** key.

The **ON/OFF** LED goes off.

**To delete a DID/DNIS Answer Code:**

1. Pick up the receiver or press the ON/OFF key.
2. Press **PROG**.
3. Dial **#95**.
4. Press **HOLD**.
5. Press the **ON/OFF** key.

The **ON/OFF** LED goes off.

**Related Programming**

- FF1 (System): Number of DID/DNIS Digits to Voice Mail
- FF1 (System): DID/DNIS Flexible Ringing Assignments

**Considerations**

**DID/DNIS digit transmission.** The DID/DNIS digits are only sent to ports that are assigned as voice mail.

**Answer code entry.** The DID/DNIS Answer Code can be entered from an attendant phone or a key phone that has entered the programming access code.

**VM ports and hunt groups.** The DID/DNIS digits can be sent to a specific voice mail port or a voice mail hunt group.

**Second hunt group.** If the DID/DNIS call rings into a hunt group that in turn transfers the call to a second hunt group, the DID/DNIS calls are not transmitted to the second hunt group.

**Third-party VM.** This feature can be used with third-party voice mail systems. If the feature is used with third-party voice mail systems, the voice mail can be connected through analog extension ports or OPX ports.

**Call forward ID.** When DID/DNIS calls are forwarded to voice mail, the Call Forward ID Code is transmitted to the voice mail. The DID/DNIS digits are not.

**DID/DNIS data transmission.** The DID/DNIS digits are transmitted over the API link using the existing API key code packet.

---

# Direct Inward System Access (DISA)

(All Versions)

## ***Description***

Direct Inward System Access (DISA) gives off-site users dial-in access to the DBS. Users access DISA by dialing a 7-digit number assigned to a DISA trunk.

For security reasons, one incoming DISA code and two outgoing DISA codes can be assigned. If an incoming code is assigned, it must be entered as soon as the DISA trunk answers. An outgoing code must be entered before the user dials an outgoing call.

## ***Operation***

### **To make a DISA call to an extension:**

1. Dial the DISA trunk number.
2. Once you hear DISA dial tone from the DBS, enter the 4-digit DISA code (if an incoming DISA code is assigned). If the incoming DISA code is not programmed, you can proceed to the next step.
3. Dial the extension number.

### **To make a DISA call to an outside number:**

1. Dial the DISA trunk number.
2. Once you hear DISA dial tone from the DBS, enter the 4-digit DISA code (if an incoming DISA code is assigned). If the incoming DISA code is not programmed, you can proceed to the next step.
3. Dial #7 plus the 4-digit Outgoing DISA Code.

Two outgoing DISA codes are assigned. Either may be used after the #7.

4. Dial the trunk group number you want to use (81-86 or 9).
5. Dial the desired telephone number.

## ***Related Programming***

- FF1 (System): Direct Inward System Access (DISA) ID Code

- FF1 (System): DISA Outbound Call ID Code 1
- FF1 (System): DISA Outbound Call ID Code 2
- FF2 (Trunk): DISA Auto Answer
- FF2 (Trunk): DISA Start Time
- FF2 (Trunk): DISA End Time

### To program an incoming code from an attendant phone:

In addition to the DISA ID Setting in FF1, the following procedure can be used to program an incoming code.

1. Press the **ON/OFF** key.
  - The phone issues intercom dial tone.
  - The **ON/OFF** LED lights.
2. Press the **CONF** key.
3. Dial “#7.”
4. Enter the DISA code.
5. Press the **HOLD** key.
6. Press the **ON/OFF** key.

The **ON/OFF** LED goes off.

### **Hardware Requirements**

- An MFR card is required for DISA. The MFR card is required to detect DTMF tones entered via the DISA connection.

### **Considerations**

- DISA can be used to access extensions as well as outside numbers.
- Once an incoming DISA code is entered, you cannot blank it out without entering the programming mode.
- Busy override cannot be used for a DISA line.
- With CPC-A and CPC-B Versions 2.0 to 2.1, DISA calls cannot access hunt groups.

---

# Direct Trunk Access

(All Versions)

## *Description*

Extensions can access a specific trunk for outgoing calls. Extensions can also use Direct Trunk Access to test trunks or to access data trunks.

## *Operation*

1. Press the **ON/OFF** key:
  - The phone issues intercom dial tone.
  - The **ON/OFF** LED lights.
2. Dial “88,” then enter the desired line number (01-64).
  - The phone issues outside dial tone.
  - “CO TALK #XX” (where “XX” is the line number) appears on the display.
3. Dial the telephone number.

The number appears on the display.
4. Complete the call and replace the handset.

---

# Distinctive Ringing

(CPC-AII and CPC-B Version 3.1 or higher)

## *Description*

Distinctive trunk call ringing patterns can be set up for each extension using the Distinctive Ringing feature. Distinctive Ringing allows users to determine which extension is ringing when several telephones are in the same area. If no distinctive ringing pattern is set, the extension rings based on the incoming ring pattern assigned to the trunk.

## *Related Programming*

- FF3 (Extension): Extension Ring Pattern

## Hardware Requirements

- SCC-B Version 1.2 or higher is required for this feature.

## Considerations

- One of ten ringing patterns can be selected.
- The ringing patterns are different for key phones and SLT/OPX phones.

---

# Door Box (Using Extension Adaptor)

(CPC-B Version 7.0 and higher and CPC-A II Version 7.0 and higher)

## Description

Door boxes (also called door phones) and door openers work together. The door box is an intercom that allows visitors to announce their presence from the office door. The door opener enables a user to unlock the door using a telephone. Door openers are not sold by Panasonic; they can be purchased separately from an electronics dealer.

There are two types of door phone adaptors available for the DBS. The first type (VB-43701) utilizes a trunk connection to connect to the door box. See *Door Box- (Using Trunk Adaptor)* for more information. The second type (VB-43711) utilizes a digital port extension to connect to the door box and door opener and is described below.

## Operation

### To Open a Door When Talking to the Door Box:

1. Answer the Door Box.
2. While still connected to the call, dial:  
  
#3 NNNN \* (where NNNN is the Door Opener Access Code, if required - 9999 by default)
3. The door will unlock. Listen for the person to enter the building before hanging up.

### To Open the Door When Not Talking to the Door Box:

1. Press the **ON/OFF** key (or pick up the handset).

2. While still connected to the call, dial:  
**#3 XXX NNNN \*** (where XXX is the Door Box extension number and NNNN is the Door Opener Access Code, if required - 9999 by default)
3. The door will unlock. Listen for the person to enter the building before hanging up.

### ***Related Programming***

- FF4 (Ringing and Hunt Groups): Ringing Assignments (all)
- FF1 (System Programming): Door Phone Assignments (all)
- FF1 (System Programming): Door Opener ID Requirement

### ***Hardware Requirements***

- The Door Box feature requires a Door Box Adaptor (VB-43711), Door Box (Door Phone) (VA-43705), and door opener. The door opener can be purchased from an electronics dealer.
- One Door Box can be connected to a Door Box Adaptor.
- Each Door Box Adaptor uses one digital extension port.
- Up to 4 Door Boxes may be connected.

### ***Considerations***

- The Door Box extension cannot take part in conference calls or be overridden.
- Door Box calls cannot be call forwarded or be hunting or coverage group members.
- The Door Opener can be set to open for 2 to 12 seconds.



---

# Door Box (Using Trunk Adaptor)

(All Versions)

## ***Description***

Door Boxes (also called door phones) and door openers work together. The door box is an intercom that allows visitors to announce their presence from the office door. The door opener enables a user to unlock the door using a telephone. Door openers are not sold by Panasonic; they can be purchased separately from an electronics dealer.

There are two types of door box adaptors available for the DBS. The first type (VB-43701) utilizes a trunk connection to connect to the door box and is described below. The second type (VB-43711) utilizes a digital port extension to connect to the door phone and door opener. See “Door Box (Using Extension Adaptor)” on page 3-25 for more information.

## ***Operation***

1. Answer the door box. (Door Box calls ring in on a dedicated FF key.)
2. Press “3” while connected to the door box extension.

The door opens automatically.

## ***Related Programming***

- FF4 (Ringing and Hunt Groups): Ringing Assignments (all)
- FF2 (Trunk Programming): DTMF/Pulse Dialing for Trunks

## ***Hardware Requirements***

- The Door Box requires a Door Box Adaptor (VB-43701), Door Box (VA-43705), and door opener. The door opener can be purchased from an electronics dealer.
- Up to two Door boxes can be connected to a Door Box Adaptor and utilize the same trunk.
- The Door Box extension cannot take part in conference calls.
- The Door Opener can be set to open for 15 seconds, 30 seconds, or one minute.

- While the Door Opener is functioning, a call from another Door Box on the same door box adaptor cannot be answered.

### ***Considerations***

- The trunk connected to the Door Box Adaptor must be set to dial pulse.

## **Sensor**

(All Versions)

### ***Description***

The sensor is a device that detects when a circuit is opened or closed. Sensors can be used to detect events such as the opening of windows or doors. When the sensor is tripped, a tone sounds at a designated extension. Sensors are not sold by Panasonic; they can be purchased separately from an electronics dealer.

### ***Hardware Requirements***

The sensor is attached to the Door Box Adaptor (VB-43701).

Trunk lines connected to the Door Box Adaptor signal the designated extension when the sensor is tripped.

### ***Related Programming***

- FF2 (Trunks): DTMF/Pulse Dialing for Trunks
- FF4 (Ring Assignments): CO Day Ring Assignments
- FF4 (Ring Assignments): CO Night Ring Assignments

### ***Considerations***

- The trunk connected to the sensor must be a dial-pulse trunk.

---

# DP/DTMF Stations

(All Versions)

## *Description*

The DBS allows both dial pulse and DTMF extension types.

## *Related Programming*

- FF2 (Trunk): DTMF/Pulse Dialing for Trunks

## *Considerations*

- DP to DTMF Signal Conversion allows DTMF extensions to use either dial pulse or DTMF trunks.

---

# DP to DTMF Signal Conversion

(All Versions)

## *Description*

This feature allows an extension user to switch from DP to DTMF signaling when using a DP trunk.

For instance, if a user dials into a voice mail system using a DP trunk, the user can switch to DTMF signaling to communicate with the voice mail system.

DTMF tones can be sent either during the call or while the call is being dialed.

## *Operation*

To switch from dial pulse to DTMF dialing, press “\*” or “#.”

## *Related Programming*

- FF2 (Trunk): DTMF/Pulse Dialing for Trunks

## *Considerations*

- DTMF dialing remains in effect for the duration of the call. Pulse dialing is restored when the handset is replaced.

- Once DTMF dialing is invoked, the user cannot switch back to pulse dialing without disconnecting the call.
- Changing from dial pulse to DTMF is possible even if the “\*” or “#” key is programmed for speed dialing.

---

## Hunting Priority for VAUs

(CPC-AII and CPC-B Version 5.0 or higher)

### *Description*

This feature allows hunting priority to be assigned to calls that overflow from the hunt group to the VAU. If the caller hears the VAU message and then decides to dial back into the hunt group, he or she is placed before other calls that have just entered the hunt group queue. For an illustration of the flow of calls, see Figure 2-1 on page 3-31.

To further improve VAU operation, DID, DISA, and transferred calls are now routed to the first VAU message. (In previous releases, these calls were routed to the second VAU message.)

In addition, a digital port can now be assigned as a VAU through system programming. In previous releases, VAUs were assigned as standard digital ports. Using the standard digital port assignment required the installer to make the following program changes:

- The CO Offhook Signal option had to be set to “on” (FF3 1-144# 7#).
- The Call Waiting Notification Tone/OHVA option had to be set to “off” (FF3 1-144# 8#).
- Auto Pickup had to be set to “on” (FF3 1-144# 12#).
- All FF keys for the extension port had to be cleared.

The VAU assignment now eliminates the need to make these program changes. Once a port is assigned as a VAU, the system treats that port as if these changes have been made.

**Note:** Though the VAU assignment treats the VAU port as if the program settings have been made, it does not actually change the settings. If the port is later assigned as a standard digital port, the original program settings will still be in effect.

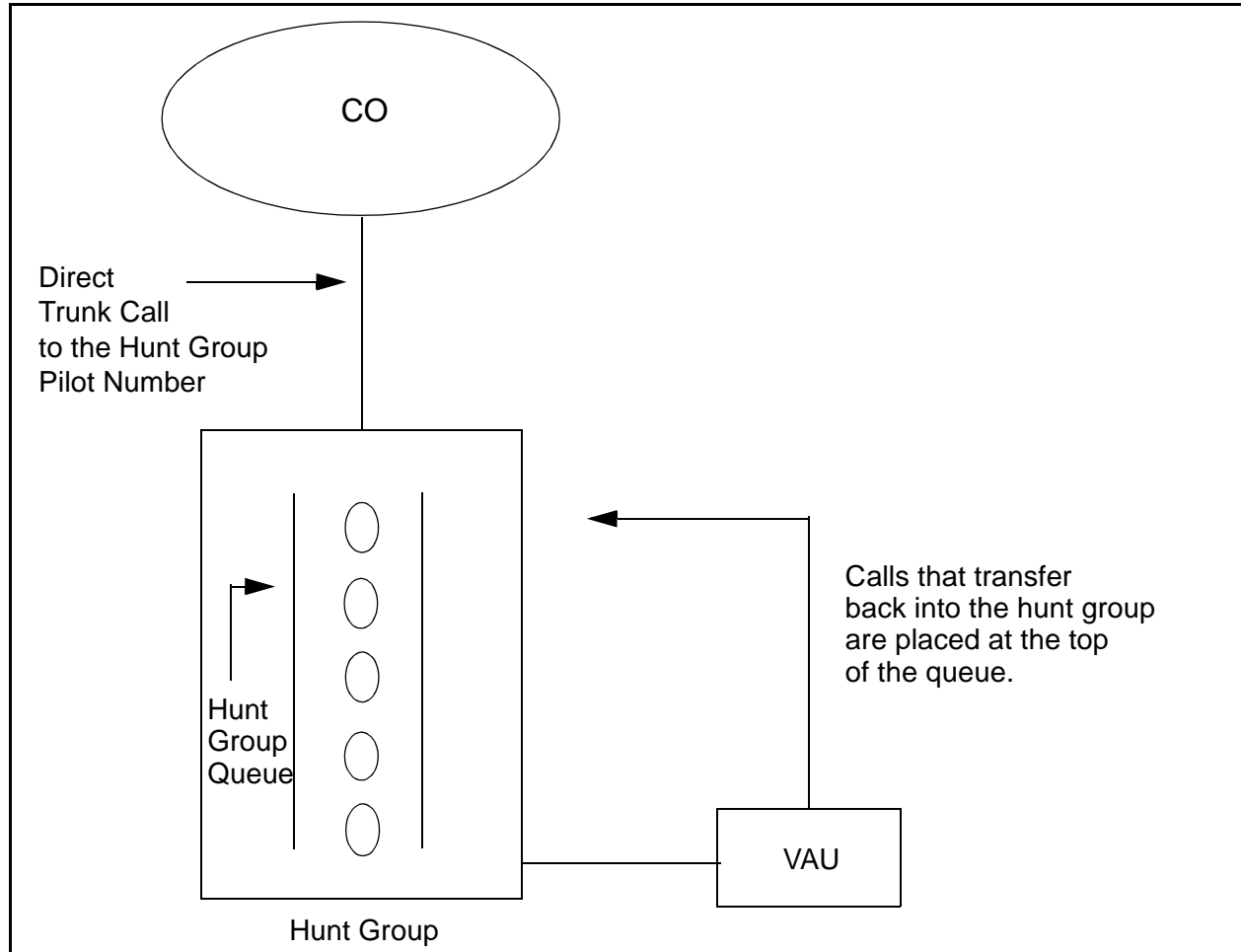
**Figure 2-1. VAU hunting priority**

### **Related Programming**

- FF3 (Extension): VAU Port Assignment
- FF3 (Extension): VAU Hunting Priority

### **Considerations**

- The following call types are routed to the first VAU message:
  - Trunk calls (including DID and DNIS calls)
  - Transferred trunk calls
  - Intercom calls
  - Transferred intercom calls.

All recalls are routed to the second VAU message.

---

# Independent Timers

(CPC-AII and CPC-B, Version 3.1 or higher)

## *Description*

Beginning with CPC-B Version 3.1, the DBS provides separate timers for Call Forwarding-No Answer, CO Delayed Ring, Extension Delayed Ring, and Hunt Group--No Answer.

The Call Forwarding-No Answer timer determines how long a call will ring an extension before forwarding.

The CO Delayed Ring and Extension Delayed Ring timers determine how long a call will ring an extension before ringing other extensions assigned to delayed ringing.

The Hunt Group-No Answer timer determines how long a call will ring an idle member of a hunt group before hunting to the next idle group member.

## *Related Programming*

- FF1 (System): Call Forward--No Answer Timer
- FF1 (System): Central Office Delayed Ring Timer
- FF1 (System): Extension Delayed Ring Timer
- FF1 (System): Hunt Group No Answer Timer

---

# Internal Hold Tone

(CPC-AII Version 7.0 and higher and CPC-B Version 7.0 and higher)

## *Description*

If a music-on-hold sound source is unavailable, a periodic hold tone generated in the DBS can be provided to caller.

## *Related Programming*

- FF1 (System): Internal Hold Tone

---

# Least Cost Routing (LCR)

(All Versions)

## ***Description***

Least cost routing (LCR) automatically selects the least expensive route available for toll calls.

LCR is accessed by dialing “9” before placing a call.

## ***Related Programming***

### **Primary Program Areas:**

- FF1 (System): Least Cost Routing (LCR) Access
- FF3 (Extension): Forced Least Cost Routing
- FF8 (LCR): Time Priority Tables
- FF8 (LCR): LCR Trunk Group Tables
- FF8 (LCR): Least Cost Routing Area Codes
- FF8 (LCR): Special LCR Area Codes
- FF8 (LCR): Least Cost Routing (LCR) Office Codes
- FF8 (LCR): Special LCR Office Codes Tables

### **Other Program Areas:**

- FF8 (LCR): LCR Add Tables
- FF8 (LCR): LCR Delete Tables

## ***Considerations***

- If LCR is enabled, ML and MCO keys can be assigned for trunk group 89. However, the FF keys will not light.
- If the LCR feature is deactivated, Pooled Trunk Access is selected automatically.
- Your system can be programmed to use the LCR feature for *all* outgoing calls.

---

# Music-on-Hold

(All Versions)

## *Description*

The DBS can provide Music-on-Hold to parties on hold on a CO line. The Music-on-Hold feature can also be used to play announcements or advertisements if desired.

The system can provide Music-on-Hold using the background music source or a separate music source. See “Background Music” on page 3-11 for more information.

Beginning with CPC-AII Version 7.0 and CPC-B Version 7.0, if no music-on-hold sound source is available, an internally generated periodic hold tone can be supplied to calls on hold. See “Internal Hold Tone” on page 3-32 for more information.

## *Hardware Requirements*

- The music source must be purchased separately. It is not provided with the DBS.
- If a single music source is used for both Music-on-Hold and background music, the music source connects to the CN5 on the DBS. If a separate music source is used for background music, it is connected directly to the SCC card. See *Installation (Section 300)* for instructions. Make sure the option straps are correctly set.
- The input impedance for the music source is 10k ohms.
- The maximum input level is 10 dB.



---

**Important:** A license may be required from the American Society of Composers, Authors, and Publishers (ASCAP) or similar organizations to transmit radio or recorded music through the Music-On-Hold feature. Panasonic Communications & Systems Company, its distributors, and affiliates assume no liability should users of Panasonic equipment fail to obtain such a license.

---



---

# Night Service

(CPC-AII prior to Version 7.0 and CPC-B Prior to Version 7.0)

## *Description*

The Attendant can switch the system between Day and Night Modes for answering outside calls. It is also possible to program the system to automatically switch between night and day modes. (CPC-AII or CPC-B Version 4.0 or higher is required for automatic day mode settings.)

While in Night Mode (generally used at night or any time when your office is closed), incoming calls can ring at selected extensions (a night watchman's extension, for example), an extension connected to an answering machine, or to a Universal Night Answer point. Universal Night Answer (UNA) is used to allow calls to be picked up from any extension.

See page 3-64 for information on setting a UNA point.

See "Auto Day Mode" (page 3-6) for information on a CPC-B Version 4.0 enhancement (also available in CPC-AII) that allows automatic switching between day and night modes.

## *Operation*

### **To switch to Night Mode:**

1. Press the **ON/OFF** key.
  - The phone issues intercom dial tone.
  - The **ON/OFF** LED lights.
2. Dial "#52."
3. Press the **ON/OFF** key.
  - The **ON/OFF** LED goes off.
  - "NIGHT MODE" appears on the display.

### **To switch to Day Mode:**

1. Press the **ON/OFF** key.
  - The phone issues intercom dial tone.

- The **ON/OFF** LED lights.
2. Dial “#52.”
  3. Press the **ON/OFF** key.
    - The **ON/OFF** LED goes off.
    - “DAY MODE” appears on the display.

### ***Related Programming***

- FF1 (System): Ring Patterns for UNA Terminals (M, C, & B)
- FF4 (Ringing and Hunt Groups): CO Day Ring Assignment
- FF4 (Ringing and Hunt Groups): CO Night Ring Assignment

### ***Hardware Requirements***

- Calls during Night Mode are often directed to external paging speakers or to an external ringing device, such as a night bell. External paging and ringing devices are not provided with the DBS; they must be purchased separately.

### ***Considerations***

- If “#52” is assigned to an FF key on an attendant phone, the attendant can switch between Day and Night Modes simply by pressing the key. The FF key lights red when the system is in night mode.
- If there are two Attendant Phones and both DSS consoles have a **NIGHT** key (programmed on a FF key), both **NIGHT** indicators will light red when Night Mode is activated.
- If the system is programmed to switch between night and day modes automatically, you **cannot** switch between modes by using “#52.”

---

# Night Service

(CPC-AII Version 7.0 and higher and CPC-B Version 7.0 and higher)

## *Description*

The Attendant can switch the system between Day and two Night Modes for answering outside calls. It is also possible to program the system to automatically switch between night and day modes.

While in a Night Mode (generally used at night or any time when your office is closed), incoming calls can ring at selected extensions (a night watchman's extension, for example), an extension connected to an answering machine, or to a Universal Night Answer point. Universal Night Answer (UNA) is used to allow calls to be picked up from any extension.

See page 3-64 for information on setting a UNA point.

See "Auto Day Mode" (page 3-8) for information that allows automatic switching between day and night modes.

## *Operation*

### **To switch to a Night Mode:**

1. Press the **ON/OFF** key.
  - The phone issues intercom dial tone.
  - The **ON/OFF** LED lights.
2. Dial "**#522**" for Night1 mode or "**#523**" for Night 2 mode. (Note: **#520** can be used to toggle between Day, Night1 and Night2 modes.)
3. Press the **ON/OFF** key.
  - The **ON/OFF** LED goes off.
  - "NIGHT MODE" or "NIGHT2 MODE" appears on the display.

### **To switch to Day Mode:**

1. Press the **ON/OFF** key.
  - The phone issues intercom dial tone.

- The **ON/OFF** LED lights.
2. Dial “#521.” (Note: #520 can be used to toggle between modes.)
  3. Press the **ON/OFF** key.
    - The **ON/OFF** LED goes off.
    - “DAY MODE” appears on the display.

### ***Related Programming***

- FF1 (System): Ring Patterns for UNA Terminals (M, C, & B)
- FF4 (Ringing and Hunt Groups): CO Day Ring Assignments
- FF4 (Ringing and Hunt Groups): CO Night Ring Assignments
- FF4 (Ringing and Hunt Groups): CO Night2 Ring Assignments

### ***Hardware Requirements***

- Calls during a Night Mode are often indicated by external paging speakers or an external ringing device, such as a night bell. External paging and ringing devices are not provided with the DBS; they must be purchased separately.

### ***Considerations***

- Day, Night and Night 2 modes can be assigned to FF keys on an attendant phone. The attendant can switch between Day, Night and Night 2 modes simply by pressing the appropriate key. The FF key lights red when the system is in the assigned mode. Alternatively a DAY/NIGHT1/NIGHT2 toggle mode key can be assigned. Pressing the key toggles between modes. When in Day mode, the FF key LED is not lit. When in NIGHT1 mode, the LED lights red. When in NIGHT2 mode, the LED lights green.
- If the same mode key is assigned on different attendant positions, each key indicates the current mode. For instance, if a **NIGHT1** key is assigned for two attendants, both light when in **NIGHT1** mode.
- If the system is programmed to switch between night and day modes automatically, you **can manually switch** between modes by using the “#520/#521/#522/#523.” (This is different than earlier versions of software.)

---

# Off-Premises Extension

(All Versions)

## Description

SLTs that are located in remote locations can be connected to the DBS through the Off-Premises Extension (OPX) Adaptor.

Off-premise phones can be connected through a direct line to the DBS or through the central office, depending on how far they are from the main cabinet. For specifications, see *Installation (Section 300)*.

## Operation

Feature operation for OPX extensions is the same as for local SLTs connected to the DBS.

## Related Programming

- FF3 (Extension): Terminal Type

## Hardware Requirements

- One OPX Adaptor (VB-43702) is required for each OPX extension.
- When OPX extensions are connected through the central office, an external ringer supply may be required. If required, the ringing supply is connected to the OPX Adaptor.

## Considerations

- Up to 8 OPX extensions can be connected to a system.
- The DBS side of the OPX Adaptor is connected to a *digital* extension port.

---

# Paging

(All Versions)

## Description

Internal paging is accomplished through the speakers of your system's key phones. The Paging feature allows you to contact someone temporarily away

from an extension, give instructions to an entire group, or communicate with several people at once. If an external paging system is connected to your system, pages can also be sent through its speakers.

Beginning with CPC-B Version 3.1, the Paging feature can also be programmed to time out after sixty seconds. When a page call times out, a busy tone is sent to the extension that initiated the page.

## ***Operation***

To use the Paging feature:

1. Pick up the handset.
2. Press “#,” then enter the number of the desired Paging Group (00-07).

The **EXT** LED lights.

3. Make your announcement.
4. Replace the handset.

## ***Related Programming***

- FF1 (System): Page Duration (CPC AII and CPC-B Version 3.1 or higher)
- FF1 (System): External Page Interface Control for Paging Groups
- FF3 (Extension): Extension Page Group

## ***Hardware Requirements***

- External relays and an amplifier are required for external paging.

## ***Considerations***

- If an external paging system has been connected to Paging Groups 00-07, pages can be made through the external speakers. Voice Paging can also be heard over the extensions in groups 00-07.
- An extension can belong to more than one paging group.
- A maximum of eight Paging Groups can be assigned to a system.
- Only one page may be performed at a time with one exception. Pages to group 00 always take priority. If you page group 00 while another extension is paging group 01-07, the other page terminates. The other pager receives busy and “Page Overridden” displays on the telephone.

- Paging cannot be heard at busy extensions or at extensions for which the Do Not Disturb, Call Forwarding, or Absence Message feature is activated.
- You can answer Paging from an idle extension by dialing the Meet-Me Answer code (“77”) during a page or if in a call, placing the call on hold and dialing “77.”

---

## Power Failure Transfer

(All Versions)

### *Description*

This feature provides telephone service to a limited number of SLTs during a power failure. The SLTs are connected to the CO via a Power Failure Unit (PFU).

In the event of a power failure, the power failure extensions have dial tone directly from the CO; system features and restrictions do not apply.

### *Hardware Requirements*

- Power Failure Unit (VA-43703)
- An SLT that will be connected to the PFU.

### *Considerations*

- Up to four SLTs can be connected to one Power Failure Unit.
- If a call is in progress through the PFU when the power is restored, the call will be disconnected.
- For added protection against power outages, backup batteries can be installed in the DBS. Backup batteries provide full telephone service and system features to all DBS extensions for a limited amount of time.

With maximum traffic, the backup batteries last up to 40 minutes for the DBS 40 and 72, and up to 30 minutes for the DBS 96.

---

# Remote Maintenance

(All Versions)

## *Description*

The DBS can be programmed from a remote terminal or from a remote PC. Remote programming can be accomplished using the Remote Programming Mode or by using Panasonic's PCAS (Personal Computer Administration System) or DBS Manager software.

## Remote Programming Mode

(All Versions)

## *Description*

Remote Programming Mode uses a "dumb" terminal or a PC to access the DBS. This method of remote maintenance is less sophisticated and more difficult than using PCAS or DBS Manager.

You can enter the Remote Programming Mode through any of these three methods:

- By using a local PC and communications package to connect directly to the DBS serial port
- By dialing into the system through a direct DISA trunk
- By dialing into the system through a regular CO trunk, then requesting the operator to enter the Remote Programming ID Code.

## *Operation*

### **Terminal Programming Through a Direct Connection**

When programming from a terminal connected to the RS-232C (SMDR) port, perform the following steps:

1. Make certain the cables are configured and connected as outlined in Section 300.
2. Make certain the DBS is in the SMDR mode by entering the following code from the attendant port:

**ON/OFF #93**

3. Enter your terminal communications program and make sure your PC's data communications settings match those of the DBS.



4. From your terminal communications program, type the following command:

**#99xxxx** (where xxxx = the site's password)

5. After the DBS responds, type **P** and then press Enter.

Follow the directions on the screen to access the desired program. (See "Terminal Programming Commands.")

### Terminal Programming Through DISA

**Note:** The DBS must be equipped with an MFR card and a RAI card to allow terminal programming using this method.

When programming through a DISA trunk, perform the following steps:

1. Dial into the DBS through a DISA trunk.
2. Once you are connected, type **#69999** from your terminal communications program.
3. After the DBS responds with REMT>, type **P** and then press Enter.

Follow the directions on the screen to access the desired program. (See "Terminal Programming Commands.")

### Terminal Programming Through a CO Trunk and Operator Transfer

**Note:** The DBS must be equipped with an MFR card and a RAI card to allow terminal programming using this method.

When programming through a normal trunk, perform the following steps:

1. Dial into the DBS through a normal trunk.
2. Ask the operator to place you on hold and dial **#69999** to transfer you into remote programming.
3. After the DBS responds with REMT>, type **P** and then press Enter.

Follow the directions on the screen to access the desired program. (See "Terminal Programming Commands.")

## Terminal Programming Commands

Use the following commands to navigate terminal programming:

Command	Description
~01	Access System parameters
~02	Access Trunk parameters
~03	Access Extension parameters
~04	Access Ring assignments
~05	Access FF-key assignments
~06	Access Name assignments
~07	Access Toll Restriction data
~08	Access Least Cost Routing data
~09	Access Copy mode
~10	Access Speed Dial data
~B	Back to previous address
~b	Back to previous port
~F	Forward to next address
~f	Forward to next port
~R	Return to provide mode
Ctrl-Z	Quit

## Remote Programming Using PCAS or DBS Manager

(CPC-A 3.1 and higher, CPC-A II, and CPC-B 1.0 and higher)

### **Description**

PCAS provides a menu-driven interface for remote maintenance. For complete details about using PCAS, see the *PCAS User's Guide*.

Very similar to PCAS but more enhanced is the Windows-based program DBS Manager. For complete details of using DBS Manager, see the *DBS Manager User's Guide*.

The primary function of these programs is to allow you to set up and maintain DBS settings using a PC. Their communications capabilities allow you to maintain the DBS settings while you are on-site with the DBS, or while you are off-site at a remote location.

These programs enable you to perform tasks such as:

- Setting up communications information

- Connecting your PC with a customer's DBS
- Maintaining DBS parameters
- Backing up and restoring customer databases.

## Station Class of Service

(CPC-AII and CPC-B Version 3.1 or higher)

### Description

Station Class of Service provides a way to restrict access to certain extension features. Station Class of Service 0 provides access to all features. By default, all extensions are assigned to this class of service. Classes of Service 1-8 can be modified to allow and restrict access to specific features. The following table shows the features that can be enabled/disabled for station classes of service.

*Table 3-1. Station Classes of Service*

Class of Service Features	
Number	Feature
1	Dial Tone On/Off (#50)
2	Head/Handset Exchange (#51)
3	BGM On/Off (#53)
4	Absence Message Set/Reset (71)
5	Call Forward Set/Reset (72)
6	Do Not Disturb (73)
7	Station Lockout (74)
8	Park Hold (75)
9	Park Pick Up (76)
10	Meet Me Answer (77)
11	UNA Pickup (78)
12	Direct Pickup (79)
13	Group Pickup (70)
14	Tone/Voice Mode (1)
15	Message Waiting Set (2)
16	Busy Override (4)
17	Call Waiting (3)
18	Offhook Voice Announce (5)
19	Central Office Call Queuing (2)

20	SLT Transfer (8)
21	Call Forwarding--Outside (720, 721, 722, 724) (CPC AII and CPC-B Version 7.0 or higher) Call Forwarding--External (723) (CPC-A and CPC-AII/CPC-B Versions prior to 7.0) <b>Note:</b> Call forwarding -- External (723) only allows external call forwarding for internal calls.

### **Related Programming**

- FF1 (System): Extension Class Of Service Setting
- FF3 (Extension): Extension Class of Service Assignment

### **Considerations**

- Some features that are in use at the time they are disabled from the Class of Service cannot be cancelled. For instance, if background music is turned on at a phone at the time background music is disabled from the class of service, the background music at the phone cannot be turned off. Make certain that features are not in use when removed from a class of service. (If a feature is accidentally left active, simply reenables the feature in the class of service and turn off the feature.)

---

## **Station Hunting**

(All Versions)

Station hunting allows calls to be automatically transferred among a preselected group of phones.

When a call terminates to a busy extension in a hunt group, the call automatically transfers to another extension in the group. If the second extension is busy, the call automatically transfers to another member of the group.

Several methods of station hunting are available. The CPC version determines which methods are available.

# Terminal and Circular Hunting

(CPC-A; CPC-B Versions Prior to 2.0)

## *Description*

CPC-A and CPC-B Versions prior to 2.0 provide terminal and circular hunt groups.

### ***Terminal Hunt Groups***

With terminal hunt groups, a call must ring at the first extension in the group in order for hunting to be invoked.

If the first extension of the hunt group is busy, the call automatically transfers to the next extension in the group. If that extension is busy, the call continues to hunt through the group. The order in which the call hunts is determined by how the group is programmed. Up to eight extensions can be placed in the group, and calls will always hunt from member 1, to member 2, to member 3, and so on.

If desired, another hunt group can be designated to receive calls should all the members of the original group be busy or not answer.

A pilot number must be designated as the first extension in a terminal hunt group. A pilot number is a fictitious extension number that, when dialed, starts the hunting process through the group. In CPC-A and CPC-B Versions prior to 2.0, a pilot number can be provided by adding a resistor to an analog port. See “Hardware Requirements” for details.

### ***Circular Hunt Groups***

With circular hunting, hunting is initiated by calling any extension in the group. If the called extension is busy, the call will hunt through the next members of the group until the end of the hunt group is reached. If the call reaches the end of the group without reaching an idle extension, it will transfer back to the first member of the group until one full circle is completed.

If desired, another hunt group can be designated to receive calls should all the members of the original group be busy.

## ***Related Programming***

- FF4 (Ringing and Hunt Groups): Hunt Group Member Table
- FF4 (Ringing and Hunt Group): Call Next Hunt Group

- FF4 (Ringing and Hunt Groups): Terminal/Circular Hunt Groups
- FF4 (Ringing and Hunt Groups): Ringing Assignments (all)

### ***Hardware Requirements***

- A pilot number can be provided by installing a 2 watt 450 Ohm resistor on the analog port that will be dialed to initiate station hunting. The resistor is placed across the tip and ring of the designated analog port.

The resistor will “busy” the port. When the busy pilot number is called, the call will hunt through the other extensions in the group.

### ***Considerations***

- Eight Station Hunt Groups can be programmed; a single Hunt Group can contain up to eight extensions, including the pilot extension.
- If all extensions in a group are busy and an alternate group has not been designated, CO calls will queue, and intercom calls will receive busy tone.
- If the first extension within a hunt group activates an absence message, call forwarding, or DND, the hunt feature will not work.
- If an extension other than the first extension activates an absence message, call forwarding, or DND, the hunt feature will skip that extension, and proceed to the next extension within the group.
- The amount of time a call rings at a hunt group member before transferring to another hunt group member is determined by the Call Forward--No Answer Timer.
- An SLT hunt group member that places a call on hold and then replaces the handset will not receive additional hunt group calls until the held call is released.
- An extension that is a member of a hunt group cannot be a member of another hunt group or a member of call coverage group.
- The offhook signaling option should be removed from members in a hunt group.

## Terminal, Distributed and Longest Idle Hunting

(CPC-AII and CPC-B Version 2.0 or higher)

Beginning with CPC-B Version 2.0, three types of hunt groups are available: Terminal, Distributed, and Longest Idle. In addition, CPC-AII and CPC-B Version 2.0 and higher also provide a software-defined pilot extension number. The software-defined pilot number eliminates the need for the 2 W 450 Ohm resistor required for a pilot number in CPC-A and CPC-B Versions prior to 2.0.

CPC-AII and CPC-B Versions 2.0 or higher also allow calls from busy hunt groups to overflow to a transfer extension. The transfer extension can be the pilot of another hunt group, the pilot (0) of the attendant group, or a single extension number.

### ***Terminal Hunt Groups***

When the Terminal method is selected, a call to the pilot number will repeatedly search hunt group members until the Transfer Timer expires. If none of the members is free when the timer expires, the call is transferred to the transfer extension.

### ***Distributed Hunt Groups***

When the Distributed method is selected, calls are distributed through the pilot number based on which extension in the group received a call in the last search. The incoming call begins its search at the next available extension in the group and then repeatedly searches the group, in sequence, until the Transfer Timer expires. If none of the members is free when the timer expires, the call is transferred to the transfer extension.

### ***Longest Idle Hunt Groups***

With Longest Idle hunting, a call to the pilot number rings the extension in the group that has been available the longest.

As with the other two methods, the search then continues through the Hunt Group until the Transfer Timer expires. If a member does not become available before the timer expires, the call is transferred to the transfer extension.

An extension is not considered idle if it rings.

### ***Related Programming***

- FF4 (Ringing and Hunt Groups): Hunt Group Search Method
- FF4 (Ringing and Hunt Groups): Pilot Extension Number

- FF4 (Ringing and Hunt Groups): Hunt Group Transfer Timer
- FF4 (Ringing and Hunt Groups): Hunt Group Extension Number
- FF4 (Ringing and Hunt Groups): Transfer Extension Number
- FF4 (Ringing and Hunt Groups): CO Delayed Day Ring Assignments for Hunt Group Pilot Numbers
- FF4 (Ringing and Hunt Groups): CO Delayed Night Ring Assignments for Hunt Group Pilot Numbers
- FF4 (Ringing and Hunt Groups): Central Office Day Ring Assignment for Hunt Group Pilot Numbers
- FF4 (Ringing and Hunt Groups): Central Office Night Ring Assignment for Hunt Group Pilot Numbers
- FF4 (Ringing and Hunt Groups): Ringing Assignments (all)
- FF1 (System): Hunt Group No Answer Timer (CPC-AII and CPC-B Version 3.1 or higher)

## **Considerations**

- Eight Station Hunt Groups can be programmed. A single Hunt Group can contain up to sixteen extensions (CPC-AII and CPC-B Version 6.0 or higher) or eight extensions (CPC-B Version 2.0 to 5.04) plus a pilot extension number.
- The transfer destination of any Hunt Group can be set to the pilot number of the next group, the pilot number (0) of the Attendant Group, the pilot number of the same group, or a real extension. The transfer destination cannot be voice mail.
- A Transfer Timer adjusts the transfer time between hunt groups. The transfer time can be set from 0 to 32 seconds. If the timer is set to 0 seconds, CO calls will be queued at the hunt group until a member is available. Intercom calls will also queue.
- Central office trunks can be set to terminate to different hunt group pilot numbers during day and night mode operation.
- With CPC-AII and beginning with CPC-B 3.1, the Hunt Group No Answer Timer determines how long a hunt group member rings before the call is transferred to the next hunt group member. In previous releases, this time was determined by the Call Forwarding--No Answer Timer.
- With CPC-AII and beginning with CPC-B Version 4.0, a call arriving at the the pilot number of a hunt group will hunt to a member that has call



forwarding set, unless call forwarding is set to an outside number. In previous versions, hunting would skip an extension with call forwarding set. The following call types will hunt to a member that has call forwarding set:

- Intercom calls
- Transferred intercom calls
- Incoming CO calls (including DID calls)
- Transferred CO calls
- DISA calls

---

## Station Message Detail Recording (SMDR)

(All Versions)

### *Description*

Station Message Detail Recording (SMDR) provides detailed call records of outgoing calls. SMDR records can be output to a printer or an external call accounting system.

Figure 2-2 shows the SMDR format for CPC-AII and CPC-B Version 3.1 or higher. Figure 2-3 shows the SMDR format for CPC-A and CPC-B Versions prior to 3.1.

Figure 2-2. SMDR Format for CPC-AII and CPC-B Version 3.1 or higher

0	1	2	3	4	5	6	7	
0	1	2	3	4	5	6	7	
01234567890123456789012345678901234567890123456789012345678901234567								
1	2	3	4	5	6	7	8	9
T	MM/DD	HH:MM:SS	HH:MM:SS	NNN	DDDDDDDDDDDDDDDDDDDDDDDDDDDDDDDDDDDDDD	AAAAAAAAAA	VVVVV	NN
1=Call type					5=Extension number			
S=Inbound DISA					10-69, 100-699=extensions			
s=Outbound DISA					CO number=DISA			
I=Incoming								
O=Outgoing					6=Dialed digits or Caller ID			
T=Transfer (See Note 1.)					DD=digits 0-9 or symbols * or #			
N=DNIS					(See Note 2.)			
D=DID					7=Account code			
2=Date					A=0-9999999999			
MM=month					8=Verified account code or walking			
DD=day					COS code			
3=Call start time					V0000-V9999=verified account codes			
HH=hours					W0000-W9999=walking COS codes			
MM=minutes					9=Trunk Number			
SS=seconds					NN=number (01-64)			
4=Call duration								
HH=hours								
MM=minutes								
SS=seconds								
Notes:								
1. Transferred calls include direct and group call pickups and conference calls.								
If a station call is transferred to an outside number, an SMDR record is also created for the station that is transferred.								
2. The * symbol appears as a greater-than sign (>) on the SMDR printout; the # symbol appears as a less-than sign (<). Centrex and PBX codes, as well as LCR access codes, do not appear as dialed digits. If the Caller ID Feature is installed and enabled, "Private" appears with calls that have restricted Caller ID display and "Out of Area" with long distance calls that do not provide Caller ID information.								

**Figure 2-3. SMDR Format for CPC-A and CPC-B Versions Prior to 3.1**

0	1	2	3	4	5	6	7
0123456789012345678901234567890123456789012345678901234567890							
1	2	3	4	5	6	7	8
MM	DD	HH:MM	H:MM.X	C	NN	DDDDD-DDD-DDD-DDDD	NNN AAAAAAAAAA
1=Date MM=month DD=day					5=Trunk number NN=number (01-64)		
2=Call start time HH=hour MM=minute					6=Dialed digits DD=digits 0-9 or symbols * or # (See the Note following item 8.)		
3=Call duration H=hour (0-9) MM=minutes X=1/10th of a minute (0-9)					7=Extension number or DISA number 10-73, 100-699=extensions #01-#64=DISA numbers		
4=Call condition I=incoming i=DISA incoming O=DISA outgoing D=Call longer than 10 hours					8=Account code A=digits 0-9 or symbols * or #		
					Note: The * symbol appears as a greater-than sign (>) on the SMDR printout; the # symbol appears as a less-than sign (<).		

## Related Programming

- FF1 (System): Parity Check
- FF1 (System): Odd/Even Parity
- FF1 (System): Baud Rate
- FF1 (System): Stop Bit Length
- FF1 (System): Data Length
- FF1 (System): Serial Port Flow Control (X On/ X Off)
- FF1 (System): SMDR Display Start Timer for CO Calls
- FF1 (System): SMDR Printing Mode 1: Outbound and Inbound
- FF1 (System): SMDR Printing Mode 2: Long Distance and Local Calls
- FF1 (System): SMDR Printing Mode 3: Header Title
- FF3 (Extension) Station Message Detail Recorder (SMDR) Report

## Hardware Requirements

- A printer or external call accounting system is required to receive SMDR data.

---

# T1 Interface

(CPC-B Version 4.0 or higher)

## *Description*

The T1 Interface is a digital trunk card that provides twenty-four 64 kbps channels, for a total transmission rate of 1.544 Mbps. T1 lines can be leased from local exchange carriers and long-distance carriers.

The DBS T1 Interface supports the following options:

### ***SF or ESF Framing Formats***

Either super frame (SF) or extended super frame (ESF) formats can be used with the DBS T1.

The superframe consists of 12 frames, with each frame including 193 bits. Each frame is separated by a framing bit.

An extended super frame consists of 24 frames, double the length of the super frame (SF) format. ESF also supports monitoring and maintenance capabilities that are not available with the SF format.

### ***Flexible Trunk Signaling Modes***

The T1 Interface provides the following trunk signaling modes. The signaling modes can be assigned on a per-channel basis:

- Loop start
- Ground start
- E&M.

## ***Related Programming***

- FF1 (System): T1 Settings (all)
- FF2 (Trunks): Trunk Type
- FF2 (Trunks): Trunk Port Class
- FF3 (Extension): Station Port Class

## ***Hardware Requirements***

- The following hardware is required to install a T1 in a single cabinet:

- 1 T1 Trunk Card (VB-43561)
- 1 T1 MDF Card (VB-43562)
- 1 Sync Card (VB-43563).

In addition, one T1 Cable (VB-43564) is required to install a T1 in a double cabinet if the T1 card is located in the slave cabinet.

To install two T1s in a double cabinet, you must have 2 T1 Trunk Cards and 2 T1 MDF Cards.

- The installer must provide a Channel Service Unit (CSU) that complies with FCC Part 15 and Part 68. The CSU is installed between the DBS and the public network. The CSU provides alarm, diagnostic, and monitoring functions, as well as network protection.

## Considerations

- *Fractional T1* can be used when fewer than 24 T1 trunks are needed. Fractional T1 allows you to use only a portion of the 24 channels provided on the T1 card.
- Though each T1 Interface provides 24 trunk channels, T1 trunks do not increase the overall trunk capacity of the DBS. Each T1 channel subtracts from the total number of analog trunks that can be installed. Furthermore, the number of analog trunks that can be used may be decremented in quantities of 1 or 8.

For instance, if you are installing a T1 in a DBS 96 and you only want to use 12 T1 channels, the logical number of analog trunks that would be available is 20 ( $32 - 12 = 20$ ).

With CPC-B 5.00 and later, the number of analog trunks available are decremented in quantities of 1. With CPC-B earlier than 5.00, the number of analog trunks must be decremented in quantities of 8; the actual number of analog trunks that can be used is 16:

(32 total trunks - 16 (two 8-trunk increments) = 16.)

- The current version of the T1 supports voice communications only. Data can be transmitted only if it reaches the T1 in analog form. Examples of analog data that can be transmitted over the T1 include fax transmissions and PC files that have been converted into analog form using a modem.

---

# Telephony Services

(CPC-AII Version 7.0 and higher and CPC-B Version 7.0 and higher)

## ***Description***

Computer Telephony Integration (CTI) provides communication and coordination of operation between computers and the telephone system. One of the most significant emerging standards in CTI is the Telephony Services Application Programming Interface from Novell®.

Telephony Services is basically a third party call controller. Applications designed for Telephony Services act on behalf of a group of users. With its group orientation, Telephony Services provides easy operation, distribution and transfer of calls and reporting of call handling among other features.

The DBS talks with the Telephony Server using a serial link from a specially designed Panasonic API Card. There is no physical link between the telephones and the networked computers. However, a logical link is established on the Tserver to relate a telephone to a networked computer.

New applications are currently being developed that will work with DBS Telephony Services. The possibilities for applications are unlimited. For example:

- inbound callers may be routed to the most appropriate customer representative based on the caller's phone number. As the call is answered, the representative's computer screen automatically displays the customer's information.
- a computer-based phone directory may be used to not only look up a phone number but also initiate a call. A corresponding called party database may be automatically accessed when the call is initiated.
- the vast array of PBX features may be more easily utilized using computer screen icons and prompting instead of complicated telephone feature access codes and procedures

In addition to general Telephony Services applications, since the DBS Telephony Services meets a published standard, customized applications may be developed to meet specific needs.

For more information on DBS Telephony Services, see the "*DBS Telephony Services Installation and Feature Description*" in the DBS Section 520. Each application used in conjunction with Telephony Services provides its own user documentation.

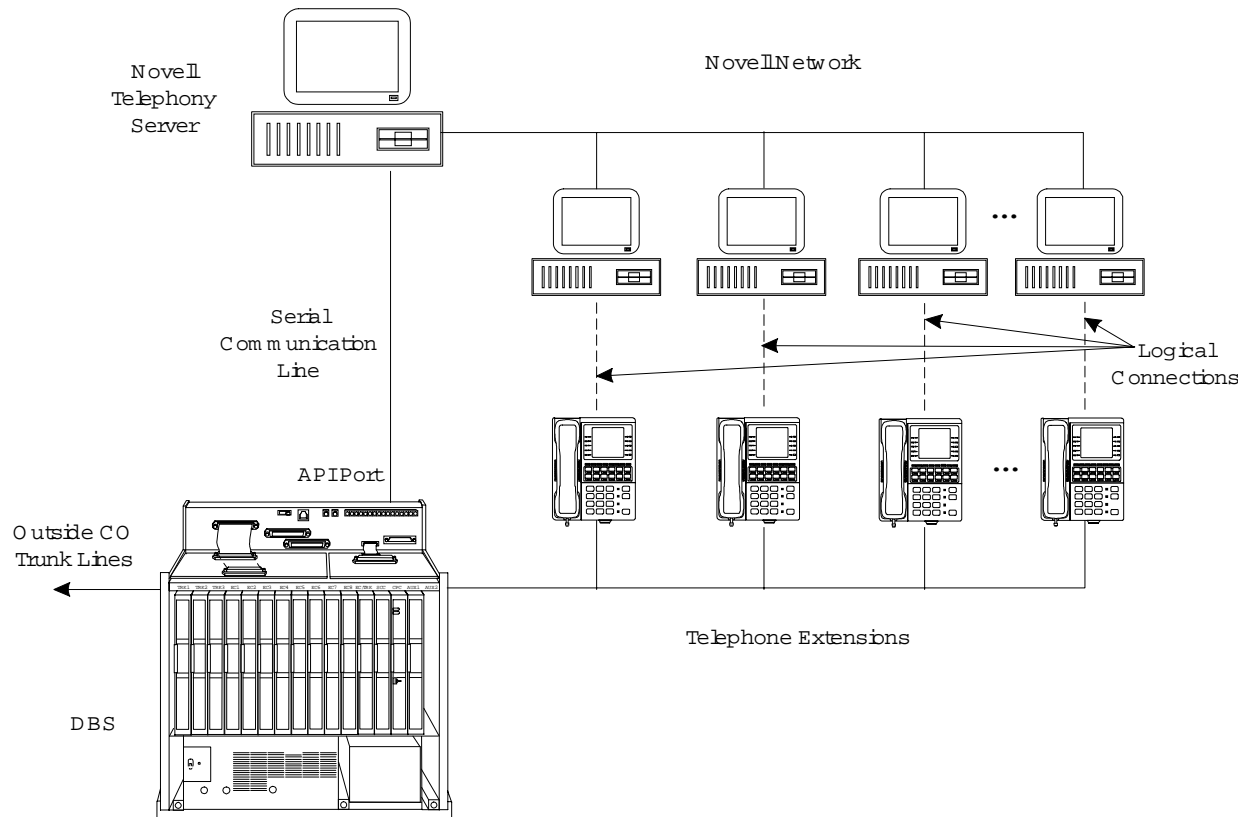

### Related Programming

- FF1 (System): API Port Type
- FF1 (System): API Baud Rate

### Hardware Requirements

- VB-43941 Telephony Services Kit. This kit includes a Panasonic API Card, the API Serial Connector (two ports) and one 3 1/2" floppy disk containing the Telephony Services DBS Driver "Panadrvr."
- A Novell 3.12 (or later), 486 (or greater) server with at least 8 megabytes of RAM and equipped with an available serial port of at least 9600 baud capacity (16550 UART required).
- One customized serial cable (provided). The RS232 limits should not be exceeded (50 feet).

# Toll Restriction

(All Versions)

## Description

Access levels, including the prohibition of long distance calls or after-hours calls, can be assigned to specific extensions or CO lines using the Toll Restriction feature. This minimizes non-business related calls and reduces phone bills by only allowing long distance calls over designated lines.

The following access levels are available:

*Table 3-2. Toll Restriction Types*

Toll Restriction Type	Characteristics
0	Restriction of outbound dialing. (911 Calls allowed with CPC-AII/CPC-B Version 6.0 only.) Inbound ringing trunks can be answered by or transferred to Type 0 extensions. Intercom calls are allowed. Group Call Pickup (intercom calls only)
1	Full restriction of outbound dialing (911 Calls allowed with CPC-AII/CPC-B Version 6.0 only) Inbound trunk calls to all phones can be answered and/or transferred. Intercom calls are allowed. Group call pickup is allowed.
2	Local calls allowed 1-800 calls allowed Inbound trunk calls can be answered and transferred from a Type 2 phone. Full restriction of international calls. Full restriction of operator calls (old numbering plan) Selectable restriction of operator calls (new NANP) - see Notes. Selectable restriction of Speed dial numbers. Selectable restriction of N11 codes (see Notes for 911). Restriction of up to 10 three-digit office codes (new NANP). Restriction of up to 50 seven-digit numbers. Inter-digit timing is set to 6 seconds.



3	<p>Full restriction of operator calls (old dialing plan).</p> <p>Selectable restriction of operator calls (new NANP).</p> <p>Selectable restriction of international calls (defaulted to full restriction - ssee Notes)</p> <p>Selectable restriction of N11 codes (211-911) (see Notes for 911).</p> <p>Selectable restriction of Speed dial numbers.</p> <p>Restriction of up to 50 seven-digit numbers.</p> <p>Trunk calls can be answered and transferred.</p> <p>Defaulted to full restriction of area-code dialing (see Notes).</p> <p>Defaulted to full restriction of office-code dialing (see Notes).</p> <p>Inter-digit timing is set to 6 seconds.</p>
4	<p>Identical to Type 3, except that office-code dialing is allowed by default; type 4 also allows Operator Calls (old dialing plan) (See Notes).</p>
5	<p>Programmable TRS Type; defaulted to no restrictions (see Notes).</p>
6	<p>Programmable TRS Type; defaulted to no restrictions (see Notes).</p>
7	<p>No restriction of outbound dialing.</p>

**Notes:**

For TRS types 3-6 and the old numbering plan, operator calls are allowed if FF7 1# 1# is set to “on.” The office code tables are used to restrict all 0 plus dialing; the next two digits will also be analyzed.

For TRS types 2 to 6 and the new NANP (CPC-AII/CPC-B Version 6.0 and later), operator access is determined by an extension-based operator access switch. TRS Types 0 and 1 are fully restricted and TRS Type 7 is not restricted.

For TRS types 2 to 6 beginning with CPC-AII/CPC-B Version 6.0, 911 is always allowed.

For TRS types 3-6, area code and office code restrictions can be changed using “Area Code Table For TRS Types 3-6,” “Office Code Table For TRS Types 3-6,” “Special Area Code Table For TRS Types 3-6,” and “Special Office Code Table For TRS Types 3-6,” explained in Chapter 8 of *Programming (Section 400)*.

For TRS types 3-6, area and office code restrictions can be further managed using “Special Area Code Table For TRS Types 3-6” and “Special Office Code Table For TRS Types 3-6” found in Chapter 8 of *Programming (Section 400)*. Four area codes can be associated with special area code tables 1-4 (one area code per table). Within each of these tables, the entire range of valid office codes can be individually allowed or restricted. Thus, the Special Area and Office Codes work together to provide specific toll restrictions.

The following calling restrictions are also available:

- Station Lockout Key Code Restriction

A key code must be entered before calling out when the Station Lockout feature is activated.

- Account Code Restriction

An Account Code must be entered before calling out.

- Forced LCR Restriction

The LCR feature controls outside calls.

### ***Related Programming***

- FF1 (System): Override Toll Restrictions with SSD Numbers
- FF3 (Extension) Extension Lockout Code
- FF7 (Toll Restriction): Toll Restriction Settings (all)
- FF8 (LCR): Least Cost Routing

### ***Considerations***

- The dialing restrictions included in this feature help prevent unauthorized outgoing calls. It is possible, however, to program your system to allow System Speed Dialing to override Toll Restrictions.

---

# Trunk Groups

(All Versions)

## *Description*

Trunks can be placed in trunk groups. When a trunk group is accessed, the DBS automatically selects an open trunk from the group.

## *Operation*

To access a trunk group, do one of the following:

- Dial a trunk group access code before dialing the telephone number. Trunk group access codes are 9, 81, 82, 83, 84, 85, and 86.
- Press an FF key that is assigned as a pooled trunk key.

## *Related Programming*

- FF2 (Trunks): Pooled Trunk Access for Group “9”
- FF2 (Trunks): Pooled Trunk Access for Groups “81-86”

## *Considerations*

- Trunks can appear in more than one trunk group.
- If Least Cost Routing is enabled, the trunk group “9” automatically accesses the LCR features.

---

# Trunk Name Assignment

(CPC-AII and CPC-B Version 2.0 or higher)

## ***Description***

You can display a name, number, or message of up to six characters on the LCD in place of your CO trunk line number. The name will appear when a CO call is ringing or connected.

For example, you can assign specific CO lines to different individuals or departments. Then, when an extension rings, the individual's name or the department's name will appear on the display, immediately identifying the person for whom the call is intended.

While you are speaking on the extension, "CO TALK XXXXXX" will appear on the LCD. (XXXXXX represents the six characters of the Trunk Name.) While the extension is ringing, "INCOMING XXXXXX" will appear. While the extension is ringing and you are speaking on the extension at the same time, "INCOMING XXXXXX" will appear on the second line of the display.

## ***Related Programming***

- FF6 (Name and Message): Trunk Name Assignment

## ***Considerations***

- Trunk names can be assigned with a DSS.
- If a text name is assigned to a CO trunk, the trunk number does not appear on the display.

---

# Trunk Queuing

(All Versions)

## ***Description***

If all outside lines in a Trunk Group are busy, the system can call you when a line becomes free. Simply pick up the handset and dial the telephone number when the Trunk Callback alert tone rings.

## ***Operation***

### **To set Trunk Queuing:**

1. Press the **ON/OFF** key.
2. Press the CO line key or dial a trunk access code.  
  
The phone issues busy tone.
3. Press “2.”  
  
“In CO Queuing” appears on the display.
4. Press the **ON/OFF** key.
5. Wait for the Trunk Callback alert tone.

### **To respond to the Trunk Callback alert tone:**

Pick up the handset.

- The outside line is automatically accessed.
- The phone issues dial tone.
- “CO TALK #XX” (where “XX” is the line number) appears on the display.

## ***Related Programming***

- FF1 (System): Extension Class of Service Setting
- FF3 (Extension): Extension Class of Service Assignment

## Considerations

- Response to the Trunk Callback alert tone must be within sixteen seconds or Trunk Queuing will be canceled.
- If a call arrives from an outside line while the Trunk Queuing feature is activated, Trunk Queuing will be suspended for the duration of the incoming call.
- If you are engaged in another call on a different line for more than twenty minutes after the desired outside line becomes available, that outside line's assignment to you will be canceled.
- The Trunk Queuing feature may also be used if you hear a busy tone when trying to make a call using the Pooled Trunk Access feature.
- Trunk Queuing can be used by all telephone types including SLTs and DSLTs.

---

# Universal Night Answer

(All Versions)

## Description

During night mode, Universal Night Answer (UNA) sends incoming calls to an external ringer, such as a night bell.

As an alternative to using a night bell, UNA can also be configured to ring external paging speakers.

Universal Night Answer calls can be picked up from any extension, provided the extension's Class of Service allows UNA answer.

## Operation

### To answer a UNA call:

1. Pick up the handset.

The phone issues intercom dial tone.

2. Dial "78."

"CO TALK #XX" appears on the display (where "XX" = the trunk number).

### ***Related Programming***

- FF1 (System): Extension Class of Service Setting
- FF1 (System): Ring Patterns for UNA Terminals (M, C, & B)
- FF3 (Extension): Extension Class of Service Assignment
- FF4 (Ringing and Hunt Groups): CO Day Ring Assignment
- FF4 (Ringing and Hunt Groups): CO Night Ring Assignment

### ***Hardware Requirements***

- An external ringing device is not provided with the DBS. It can be purchased separately from an electronics dealer.
- External paging speakers are not provided with the DBS; they must be purchased separately.

### ***Considerations***

- With CPC-A and CPC-AII, extension port 73 is used to assign ringing to an external page/UNA interface.
- With CPC-B, extension port 145 is used to assign ringing to an external page/UNA interface.

---

## **Voice Mail Ringing**

(CPC-AII and CPC-B Version 3.1 or higher)

### ***Description***

The Voice Mail Ringing feature allows calls from a DBS Automated Attendant or from an ACD port to ring an extension with the same ring tone as a CO trunk. The ring pattern is selected in the Extension Distinctive Ringing program. If a distinctive ringing pattern is not specified, the ringing pattern will be two seconds on/two seconds off.

### ***Related Programming***

- FF3 (Extension): Extension Ring Pattern

# VAU

(All Versions)

## Description

The Voice Announce Unit (VAU) is a digital answering device that can be connected to the DBS. It provides for the recording and playback of up to two voice messages, along with the ability to transfer incoming calls.

When a call reaches the VAU, it plays a prerecorded voice message. The caller is then allowed to dial a number or is automatically transferred to a predetermined extension.

The VAU is often used to back up operators or hunt groups. Callers overflowing from either of these positions hear a message and can then dial a number or wait to be transferred back to the operator or hunt group.

The VAU can be used to provide a variety of other services to callers, such as a menu of dialing options or transfer to an answering machine.

Please see Appendix C through Appendix E for information on PanaVOICE and Call Record features available with the DBS system.

## Recording and Playing Messages

You can record the VAU messages from either an extension or a trunk.

### Notes:

- You must use a DTMF telephone to record and play VAU messages.
- To change existing messages, record over them.

To record and play messages, complete the following steps.

1. Do one of the following:

<i>If...</i>	<i>Then...</i>
You are recording or playing from an extension	Take your phone off hook. Dial the VAU extension number. (If the intercom is set for Voice, dial <b>1</b> to change from Voice to Tone.)
You are recording or playing from a trunk	Dial the phone number of the VAU, or call in and have the operator transfer you to the VAU extension.



2. After the VAU answers, do one of the following:

<i>If . . .</i>	<i>Then . . .</i>
You want to record the first message	Dial * <b>98 1</b> Wait for a beep. After the beep, record the message.
You want to record the second message	Dial * <b>98 2</b> Wait for a beep. After the beep, record the message.
You want to play the first message	Dial * <b>97 1</b> The VAU plays the message.
You want to play the second message	Dial * <b>97 2</b> The VAU plays the message.

**Notes:**

- You can enter the \*97 codes again to replay messages without ending your call.
  - You can only record one message at a time. To record another message, you must end your call and redial the VAU.
3. When the operation is complete, put the phone on hook.

### **Considerations**

- For more information on the VAU and its operation, see Section 770, “Voice Announce Unit User Guide.”

---

## **VAU Port Assignment**

(CPC-AII and CPC-B Version 5.0 or higher, CPC-A Version 3.3 and higher)

### **Operation**

A digital port can now be assigned as a VAU through system programming. In previous releases, VAUs were assigned as standard digital ports. Using the standard digital port assignment required the installer to make the following program changes:

- The CO Offhook Signal option had to be set to “off” (FF3 1-144# 7#).

- The Call Waiting/OHVA option had to be set to “off.” (FF3 1-144# 8#).
- Auto Pickup had to be set to “on” (FF3 1-144# 12#).
- All FF keys for the extension port had to be cleared.

The VAU assignment now eliminates the need to make these program changes. Once a port is assigned as a VAU, the system treats that port as if these changes have been made.

**Note:** Though the VAU assignment treats the VAU port as if the program settings have been made, it does not actually change the settings. If the port is later assigned as a standard digital port, the original program settings will still be in effect.

To further improve VAU operation, the following call types are now routed to the first VAU message:

- DID calls
- DNIS calls
- DISA calls
- Transferred trunk calls
- Transferred intercom calls.

In previous releases, only intercom and CO trunk calls were routed to the first VAU message.

All recalls are routed to the second message.

### ***Programming***

- FF3 (Extension): VAU Port Assignment
- FF3 (Extension): VAU Hunting Priority

---

## **Walking TRS Class of Service**

(CPC-AII and CPC-B Version 3.1 or higher)

### ***Description***

Walking TRS Class of Service allows an extension user to “carry” his or her toll restrictions to another phone.

Before the Walking TRS Class of Service feature can be used, a Walking Class of Service code must be entered at your extension before using dialing privileges at another extension.

## **Operation**

### **To enter a Walking Class of Service code:**

1. Pick up the handset.  
The phone issues intercom dial tone.
2. Dial “#12.”
3. Enter the four-digit Walking Class of Service code (0001-9999).
4. Press “#.”
5. Replace the handset.

### **To use a Walking Class of Service code:**

1. Pick up the handset of an extension other than your own.  
The phone issues intercom dial tone.
2. Dial “#13.”
3. Enter *your* extension number.
4. Enter your Walking Class of Service code.
5. Press “#.”
6. Enter a trunk access code (88XX, 9, 81-86).  
The phone issues outside dial tone.
7. Dial the telephone number.  
The Walking Class of Service remains in effect until you replace the handset.

### **To clear a Walking Class of Service code:**

1. Pick up the handset.  
The phone issues intercom dial tone.

2. Dial “#12.”
3. Enter the original Walking Class of Service code.
4. Press “#.”
5. Replace the handset.

**To confirm a Walking COS code (Attendant Phone only):**

1. Pick up the handset.  
The phone issues intercom dial tone.
2. Press the **CONF** key.
3. Dial “#12.”
4. Enter the extension number.

The Walking Class of Service code for that extension appears on the display.

***Considerations***

- Walking Class of Service can be used by KTELEs, DSLTs, and SLTs.
- The same Walking Class of Service code can be used on more than one extension.
- If an extension is locked out, the Walking Class of Service feature will override the lockout.
- LCR and TRS dialing privileges follow the Walking Class of Service.
- Before entering a new walking COS code, you must first clear the existing code.

# Chapter 4. Key Telephone Features

This chapter describes DBS key telephone features. DBS key telephones are proprietary digital phones that provide feature access through a combination of feature keys and access codes.

This chapter covers the following topics:

Topic	Page
Key Phone	4-3
Absence Message	4-3
Auto Redial	4-6
Barge-In for Direct Lines	4-6
Busy Override	4-7
Call Coverage Groups	4-8
Call Duration Display	4-9
Call Forwarding	4-11
Call Hold	4-17
Call Park	4-21
Call Pickup	4-22
Call Transfer	4-25
Call Waiting	4-29
Call Waiting/OHVA Text Reply	4-32
Caller ID Call Log	4-33
Camp-on	4-37
CO Line Key Trunk Access	4-38
Conference Calls	4-39
Delayed Ringing	4-42
Dial "0" for Attendant	4-42
Dial Tone Disable	4-44
Do-Not-Disturb (DND)	4-45
EM/24 Console	4-47
Flexible Function (FF) Keys	4-47
Handsfree Answerback	4-54
Handsfree Operation	4-55
Headset Operation	4-55
Hot Dial Pad	4-56
Intercom Calling	4-56

<b>Topic</b>	<b>Page</b>
Last Number Redial	4-59
Line Appearances	4-60
DSS/BLF Appearances	4-61
Meet-Me Answer	4-67
Message Waiting/Callback Request	4-68
Non-Appearing Outside Lines	4-70
Offhook Signaling	4-71
Offhook Voice Announce (OHVA)	4-72
One-Touch Keys	4-74
One-Touch VM Access	4-78
Onhook Dialing	4-81
Pooled Trunk Access	4-81
Prime Line Preference	4-83
Private Line	4-84
Reminder Call	4-85
Ringling Line Preference	4-87
Saved Number Redial	4-87
Speed Dialing	4-88
Station Lockout	4-96
Trunk-to-Trunk Transfer	4-97
Voice Mail Transfer Key	4-98

# Key Phone

As an example of a key phone, Figure 4-1 illustrates the DBS key phone model VB-43225. The VB-43225 provides a large display that includes one-touch access to speed dial numbers, telephone features, and help screens.

Please refer to “Appendix A: CPC-EX 1.0 Updates” and “Appendix B: CPC-All/B 8.0 Updates” for additional information on VB-44xxx Series Large Display Key Telephone features.

Figure 4-1. VB-43225 key phone

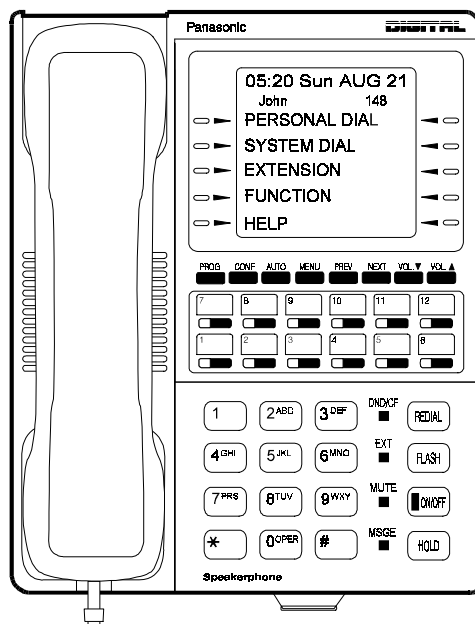

## Absence Message

(All Versions)

### Description

Extension users can leave text messages on their phones when they are away. When the unattended extension is dialed, the text message displays on the caller's phone. Any one of the following messages can be selected. Messages 5 to 9 can be changed through system programming.

Table 4-1. Absence Messages

Message No.	Message Text	Message No.	Message Text
0	In Meeting	5	User Defined
1	At Lunch	6	User Defined

2	Out of Office	7	User Defined
3	Vacation	8	User Defined
4	Another Office	9	User Defined

## Operation

### To set an Absence Message

1. Press the **ON/OFF** key.
  - The phone issues intercom dial tone.
  - The **ON/OFF** LED lights.
2. Dial “71.”

“Enter Msg Code” appears on the display.
3. Enter a message code between 0 and 9 (See Table 4-1).

“Enter Parameter” appears on the display.
4. Enter the time you will return (optional). See Table 4-2 for examples.
5. Press the **ON/OFF** key.
  - The **DND/CF** LED lights.
  - “At Lunch” appears on the display if you selected message code 1.

### To cancel an Absence Message

1. Press the **ON/OFF** key.
  - The phone issues intercom dial tone.
  - The **ON/OFF** LED lights.
2. Dial “71.”

“Enter Msg Code” appears on the display.
3. Press the **ON/OFF** key.
  - The **ON/OFF** LED goes off.
  - The **DND/CF** LED goes off, and the message disappears from the display.



## ***Related Programming***

- FF1 (System): Extension Class of Service Setting (CPC-AII and CPC-B Version 3.1 or higher)
- FF3 (Extension): Extension Class of Service Assignment (CPC-AII and CPC-B Version 3.1 or higher)
- FF6 (Names and Messages): Absence Messages

## ***Considerations***

- Calling parties without a display get a busy signal, rather than the Absence Message.
- If a message code number that has not been programmed is selected, “Absence,” followed by the code number, appears on the display.
- Absence Message return times can be input as shown in the following table:

***Table 4-2. Example Return Times for Absence Messages***

<b>Input</b>	<b>Display</b>
No input	Return
9	Return 9:00
11	Return 11:00
615	Return 6:15
1035	Return 10:35

Four-digit numbers can also be input (0000-9999 = Hours & Minutes or Month & Date).

- When an Absence Message is set on a DID extension, incoming DID calls are routed according to the ringing assignment programmed for the incoming trunk.
- In CPC-A and CPC-B Versions prior to 5.0, DND and Absence Messages cancel Call Forwarding.

Beginning with Version 5.0, calls to an extension with DND or Absence Message turned on are treated differently, depending on whether they are trunk or intercom calls: Intercom calls receive busy tone; trunk calls are routed to the extension defined in permanent call forwarding.

The following types of trunk calls follow permanent call forward settings:

- Direct trunk calls (including DID/DNIS)
- Transferred trunk calls.
- Callback to an incoming CO call on a Private Line is available if the Absence Message feature is activated.

---

## Auto Redial

(CPC-AII and CPC-B Version 7.0 or higher)

### *Description*

If the Redial key is pressed when the extension is idle or receiving dial tone, the last intercom or outside number is automatically redialed.

### *Related Programming*

- FF3 (System): Auto-Redial on Extensions

---

## Barge-In for Direct Lines

(CPC-AII and CPC-B Version 5.0 and higher)

### *Description*

Barge-in for Direct Lines allows users to break into a busy Direct Line (DL) and create a three-party conference.

A direct line is a call appearance used to originate and receive calls over a specific trunk number.

### *Operation*

To barge into a busy Direct Line, press the lit DL key. (The DL key will be lit red.)

### *Related Programming*

Barge-in for Direct Lines is controlled by the program settings for Busy Override. For instance, if an extension with a DL key does not want the DL broken into, that extension must have “Busy Override Receive” turned off.

## **Considerations**

**Paging Groups.** Both extensions must belong to the same paging group (1-7). Paging group 0 does not allow override.

**Override Restrictions.** Barge-in for Direct Lines cannot override a DL under the following conditions:

- When the DL is in a conference call
- When the DL is holding a call
- When the phone that will be barged into is holding a trunk that does not appear on an FF key. For example, if extension 200 wants to barge into a DL that appears on extension 201, extension 200 cannot barge into the DL if 201 is holding a trunk that does not appear on an FF key.

---

# **Busy Override**

(All Versions)

## **Description**

Extensions in the same Paging Group (1-7) can break into one another's outside calls or intercom calls to relay urgent information or to create three-party conference calls.

## **Operation**

1. Pick up the handset.

The phone issues intercom dial tone.

2. Dial the extension number.
3. When you hear busy tone, dial "4."
  - An alert tone sounds to both phones (system programming required).
  - The **EXT** LED lights.

## **Related Programming**

- FF1 (System): Alert Tone for Busy Override and OHVA

- FF1 (System): Extension Class of Service Setting (CPC-AII and CPC-B Version 3.1 or higher)
- FF3 (Extension): Extension Class of Service Assignment (CPC-AII and CPC-B Version 3.1 or higher)
- FF3 (Extension): Busy Override Send
- FF3 (Extension): Busy Override Receive
- FF3 (Extension): Extension Page Group

### **Considerations**

- You cannot break in on three-party conference calls.
- In CPC-A and CPC-B Versions 2.0 or lower, an Attendant Phone can break into any call, independent of system programming.

Beginning with CPC-B Version 2.0, attendants can be prevented from using busy override.

- The default for the override alert tone is “off.” If the override alert tone is enabled, the tone will be sent to both parties when a call is overridden.
- In CPC-A and CPC-B Versions prior to 3.1, overridden extensions display “CONF” when an override is performed. Beginning with CPC-B Version 3.1, “Overridden” does not appear on the display of an extension that has been broken into.

---

## **Call Coverage Groups**

(All Versions)

### **Description**

Call coverage is designed for office workers who almost always want their unanswered calls to be routed to the same secretary or secretaries.

If an extension in a Call Coverage Group is unable to receive a call, the call is automatically routed to a designated phone within the group (the “covering” phone).

Up to two extensions can be designated as covering phones.

For example, if an outside call on line 1 is sent to extension 135, but extension 135 is busy or does not answer, the call will ring at the covering phone and “TRK #01> 135” will appear on the covering phone’s display.

If two extensions are designated as covering phones and one of them is in DND, the second will receive the call.

Call coverage assignments are controlled through system programming, rather than from individual extensions.

For extension-controlled routing of unanswered calls, see “Call Forwarding” on page 4-11.

### ***Related Programming***

- FF3 (Extension): Offhook Signal
- FF4 (Ringing and Hunt Groups): Call Coverage Group Member Table

### ***Considerations***

- Up to sixteen Call Coverage Groups can be programmed into your system. A Call Coverage Group can have up to two covering phones and up to six extensions.
- A member of one Call Coverage Group cannot belong to another Call Coverage Group or to a Hunting Group.
- A Single-line telephone (SLT) or Digital Single Line telephone (DSLTL) can be a member of a coverage group, but cannot be a covering phone.
- Calls to an extension in DND do not cover.
- Calls to an extension with Call Forwarding activated do not cover.
- If the Call Forwarding feature or the Absence Message feature is activated for covering phone No. 1, covering phone No. 2 will “cover” the other extensions in the group.
- Voice intercom calls do not activate call coverage. Only tone intercom calls can activate call coverage.

---

## **Call Duration Display**

(All Versions)

### ***Description***

The length of a conversation on a CO line usually appears on display phones. The duration display shows the number of minutes and seconds the call has lasted.

The display does not begin right away; it begins either 16 or 30 seconds after the call begins, depending on how the DBS is programmed.

### ***Related Programming***

- FF1 (System): Call Duration Display
- FF1 (System): SMDR Display Start Timer for CO Calls

# Call Forwarding

(All Versions)

Call Forwarding allows users to send their calls to another extension, to an outside line, or to voice mail. All versions of the DBS provide call forwarding; however, some call forwarding enhancements are not available with earlier versions. The following table shows the call forwarding features available with each release.

*Table 4-3. DBS Call Forwarding features*

Feature	Availability
Call Forwarding--All Calls	All versions
Call Forwarding--No Answer	CPC-AII and CPC-B Version 2.0 or higher
Call Forwarding--Busy	All versions
Call Forwarding--Busy/No Answer	All versions
Call Forwarding--External	CPC-A, CPC-AII prior to 7.0 and CPC-B prior to 7.0.  (Beginning with CPC-AII/CPC-B Version 7.0, all forwarding types (All Calls, No Answer, Busy, Busy/No Answer) allow call forwarding outside - eliminating the need for the special Call Forwarding - External type 723.)
Permanent Call Forwarding	CPC-AII and CPC-B Version 3.1 or higher

## Descriptions

**Call Forwarding--All Calls.** When the Call Forwarding--All Calls feature is activated, all incoming calls to an extension are immediately forwarded.

**Call Forwarding--No Answer.** When Call Forwarding--No Answer is activated, an unanswered call will ring until the Call Forward No Answer timer expires. When the timer expires, the unanswered call is forwarded.

**Call Forwarding--Busy.** When Call Forwarding--Busy is activated, all incoming calls to a busy extension will be forwarded.

**Call Forwarding--Busy/No Answer.** When Call Forwarding--Busy/No Answer feature is activated, all incoming calls to an extension that is busy or does not answer will be forwarded.

**Call Forwarding--External** (*CPC-A and CPC-AII and CPC-B Versions prior to 7.0*). When Call Forwarding-External is activated, all incoming intercom calls to an extension will be forwarded to an outside number. For calls to be forwarded to an outside number, the trunk access code and telephone number must first be entered as a system or personal speed dial number.

Any system speed dial number can be used to store an outside number for call forwarding. With CPC-A and CPC-B Versions prior to 2.0, only personal speed dial number 99 can be used. With CPC-AII and CPC-B Versions higher than 2.0, any of the personal speed dial numbers can be used.

**Note:** Beginning with CPC-AII and CPC-B Version 7.0, all call types can be forwarded outside eliminating the need for the Call Forwarding External option. The calls forwarded are not limited to internal calls but may include incoming outside calls.

**Permanent Call Forwarding.** Permanent call forwarding is assigned through system programming, rather than by the user. Permanent call forwarding is normally used to forward calls to a voice mail system.

An extension user can invoke other forms of call forwarding (no answer, busy, all calls) to temporarily override the permanent call forwarding destination.

Permanent call forwarding can be used with busy, no answer, or busy/no answer.

When Permanent Call Forwarding is assigned, the **DSS** and/or **BLF** keys are not lit green, the DND/CF LED is off, and the second line of LCD displays do not display the Call Forwarding assignment.

#### **To activate Call Forwarding to another extension:**

1. Press the **ON/OFF** key.
  - The phone issues intercom dial tone.
  - The **ON/OFF** LED lights.
2. Dial “72.”

“ENTER FWD CODE” appears on the display.
3. Dial the appropriate call forwarding code



Call Forward Type	Code
All	0
Busy/no answer	1
Busy	2
No answer	4

“ENTER FWD EXT#” appears on the display.

4. Enter the number of the extension you want to receive your calls.
5. Press the **ON/OFF** key.
  - The **DND/CF** LED lights.
  - “FWD-EXT 135” appears on the 2nd line of the display if extension 135 is selected. If a name is assigned to the extension, the name appears instead of the extension number.

#### To activate Call Forwarding-External (prior to Version 7.0):

**Note:** To forward to an outside number, the trunk selection and forwarding number must first be programmed into personal or system speed dialing. With CPC-A or CPC-B Versions prior to 2.0, you can only forward to an outside number that is programmed into personal speed dial number 99. With CPC-AII and CPC-B 2.0 or higher, you can forward to any speed dial number (system or personal). See “Speed Dialing” on page 4-88 for more information on programming personal speed dial numbers.

1. Press the **ON/OFF** key.
  - The phone issues intercom dial tone.
  - The **ON/OFF** LED lights.
2. Dial “72.”
 

“ENTER FWD CODE” appears on the display.
3. Dial 723.
 

“ENTER FWD EXT#” appears on the display.
4. Press **AUTO** plus the appropriate speed dial number.
5. Press the **ON/OFF** key.

- The **DND/CF** LED lights.
- “FWD OUTSIDE” appears on the 2nd line of the display .

### To activate Call Forwarding to an outside number (CPC-AII/CPC-B Version 7.0 or higher):

**Note:** To forward to an outside number, the trunk selection and forwarding number must first be programmed into personal or system speed dialing. You can forward to any speed dial bin number (system or personal). See “Speed Dialing” on page 4-88 for more information on programming personal speed dial numbers.

1. Press the **ON/OFF** key.
  - The phone issues intercom dial tone.
  - The **ON/OFF** LED lights.
2. Dial “72.”
 

“ENTER FWD CODE” appears on the display.
3. Dial the appropriate call forwarding code.

Call Forward Type	Code
All	0
Busy/no answer	1
Busy	2
No answer	4

“ENTER FWD EXT#” appears on the display.

4. Press **AUTO** plus the appropriate speed dial number.
5. Press the **ON/OFF** key.
  - The **DND/CF** LED lights.
  - “FWD OS AXXX” appears on the 2nd line of the display where XXX is the Speed Dial bin number.

### To cancel Call Forwarding

1. Press **ON/OFF**.
2. Dial “72.”

3. Hang up.

### ***Related Programming***

- FF1 (System): Call Forward No Answer Timer (CPC-AII and CPC-B Version 3.1 or higher)
- FF1 (System): Extension Class of Service Setting (CPC-AII and CPC-B Version 3.1 or higher)
- FF3 (Extension): Extension Class of Service Assignment (CPC-AII and CPC-B Version 3.1 or higher)
- FF3 (Extension): Permanent Call Forward Type (CPC-AII and CPC-B Version 3.1 or higher)
- FF3 (Extension): Permanent Call Forward Extension (CPC-AII and CPC-B Version 3.1 or higher)
- FF10 (Speed Dial): System Speed Dial Numbers
- FF10 (Speed Dial): Personal Speed Dial Numbers

### ***Considerations***

- With CPC-A and CPC-B Versions prior to 2.0, calls cannot be forwarded to an extension that already has call forwarding activated. In other words, phone “A” can only forward to phone “B” if phone “B” is not forwarded.

Beginning with CPC-B Version 2.0, calls can be forwarded to extensions that have call forwarding activated. For example, phone “A” can be forwarded to phone “B,” even if phone “B” is forwarded to voice mail.

- In CPC-A and CPC-B Versions prior to 5.0, DND and Absence Messages cancel Call Forwarding.

Beginning with Version 5.0, calls to an extension with DND or Absence Message turned on are treated differently, depending on whether they are trunk or intercom calls: Intercom calls receive busy tone; trunk calls are routed to the extension defined in permanent call forwarding.

The following types of incoming trunk calls follow permanent call forward settings:

- Direct trunk calls (including DID/DNIS)
- Transferred trunk calls.

- Voice calls do not forward when Call Forwarding--No Answer is used.
- If several calls arrive at once at an extension set for Call Forwarding-No Answer, all of the calls will be queued. (The timing for each call begins with the ringing tone.)
- Extensions for which Call Forwarding-External has been set **cannot**:
  - Be in the middle of an outside call when the feature is activated.
  - Have a toll restriction setting that prohibits outside calls.
- Calls can be forwarded to a third-party voice mail using the “Call Forward ID Code” described on page 3-13.
- Beginning with CPC-AII and CPC-B Version 7.0, all call forwarding types (All Calls, Busy/No Answer, Busy, and No Answer) can be forwarded outside using speed dials. However, if Least Cost Routing is activated, dial “9” trunks cannot be used. Select another trunk group instead (81-86). See “Speed Dialing” on page 4-88 for more information on programming speed dial numbers.
- If Forced Least Cost Routing is activated, trunk groups 81-86 are not available.
- Calls cannot be forwarded to an extension in DND.

---

# Call Hold

(All Versions)

The DBS provides both Exclusive and System Hold.

## Exclusive Hold

### *Description*

With Exclusive Hold, only the extension that held the call can retrieve it.

Exclusive Hold can be used to hold CO calls and intercom calls.

### *Operation*

#### **To place a call on Exclusive Hold:**

Press the line key being used for the call.

The line LED flashes green, and the phone issues intercom dial tone.

“Hold TRK #XX” (where “XX” is the outside line number) appears on the display.

#### **To retrieve a call from Exclusive Hold:**

Press the line key on which the call is held.

The line LED stops flashing and remains green.

“CO TALK TRK #XX” (where “XX” is the outside line number) appears on the display if the call held on the line was released.

### ***Related Programming***

- FF1 (System): Recall Timer for Attendant-Held CO Calls
- FF1 (System): Recall Timer for Attendant-Held Intercom Calls
- FF1 (System): Recall Timer for Extension-Held CO Calls
- FF1 (System): Recall Timer for Extension-Held Intercom Calls
- FF1 (System): Trunk Line Automatic Hold (Key Bank Hold)

- FF1 (System): Non-Appearing Central Office Line Hold

## Considerations

- When using an outside line for which there is no line key on your extension, press the **HOLD** key to place the call on hold, and then press a vacant line key. Release the held call by pressing **HOLD** again. (System programming determines whether the call will be placed on Exclusive Trunk Hold or System Trunk Hold.)
- A held call will recall if it is not retrieved before the Hold Recall Timer expires. “Hold Recall #XX” (where “XX” is the outside line number) appears on the display if a call has been held beyond the time limit.
- If you press the **HOLD** key during a conference with two outside lines, both outside lines will be placed on hold.
- If your system is set for onhook transfer and you have placed an outside call on hold, and you then make an Intercom Call, make sure the other extension hangs up before you do. If you hang up before the other extension, *the held outside line will be transferred to that extension.* (Pressing **FLASH** releases the extension.)
- The DBS can provide music-on-hold to callers placed on hold. See “Music-On-Hold” (page 3-34) for more information.

## System Hold

### Description

Using System Hold, you can place either an outside call or an Intercom Call on hold.

A call placed on System Hold can be retrieved from any extension.

### Operation

#### To place a call on System Hold:

Press the **HOLD** key.

- The line LED being used for the call flashes green.
- The phone issues intercom dial tone.

- “Hold TRK #XX” (where “XX” is the outside line number) appears on the display.

**To release a call placed on System Hold from the extension that placed it there:**

Press the line key that is flashing green.

- The line LED stops flashing and remains lit.
- “CO TALK #XX” (where “XX” is the outside line number) appears on the display.

**To release a call placed on System Trunk Hold from a different extension:**

Press the line key that is flashing red.

- The line LED turns green and stops flashing.
- “CO TALK TRK #XX” (where “XX” is the outside line number) appears on the display.

### ***Related Programming***

- FF1 (System): Recall Timer for Attendant-Held CO Calls
- FF1 (System): Recall Timer for Attendant-Held Intercom Calls
- FF1 (System): Recall Timer for Extension-Held CO Calls
- FF1 (System): Recall Timer for Extension-Held Intercom Calls
- FF1 (System): Trunk Line Automatic Hold
- FF1 (System): Non-Appearing Central Office Line Hold

### ***Considerations***

- When using an outside line for which there is no line key on your extension, press the **HOLD** key to place the call on hold and then press a vacant line key. Release the held call by pressing **HOLD** again. (System programming determines whether the call will be placed on Exclusive Trunk Hold or System Trunk Hold.)

- If the Automatic Outside Line Hold feature is programmed for your system, pressing any other line key will place your original call on System Hold.
- A held call will recall if it is not retrieved before the Hold Recall Timer expires. “Hold Recall #XX” (where “XX” is the outside line number) appears on the display if a call has been held beyond the time limit.
- If you press the **HOLD** key during a conference with two outside lines, both outside lines will be placed on hold.
- If your system is set to onhook transfer and you have placed an outside call on hold, and you then make an Intercom Call, make sure the other extension presses the **FLASH** key or hangs up before you do. If you hang up before the other extension, *the held outside line will be transferred to that extension.*
- If there is no response to the Hold Recall, the tone is issued at the Attendant Phone (extension 100 or 10). However, no tone is issued at the Attendant Phone if Night Mode is activated or if the call is on a Private Line.
- An error tone is issued if you attempt to place more than one intercom call on hold at the same time.
- The DBS can provide Music-on-Hold to callers placed on hold. See “Music-On-Hold” (page 3-34) for more information.



---

# Call Park

(All Versions)

## ***Description***

You can use the Call Park function to transfer a call, even if you cannot locate the intended recipient of the call. Simply park the call, and then page the person you want to transfer to. That person can answer the call from any extension by dialing the Call Park Retrieve Code (76) followed by the number of the extension that parked the call.

## ***Operation***

### **To park a call:**

1. Press the **HOLD** key.
2. Dial “75.”  
  
“Park Hold” appears on the display.
3. If needed, make a page such as “Mr. Jones, please pickup a call parked at 76XXX” where XXX is the extension number where the call is parked.

### **To retrieve a parked call:**

1. Pick up the handset.  
  
The phone issues intercom dial tone.
2. Dial “76.”
3. Dial the number of the extension that parked the call.  
  
“CO TALK TRK #XX” (where “XX” is the line number) appears on the display.

### **To retrieve a call parked by the attendant (after receiving the park number from the attendant):**

1. Pick up the handset.  
  
The phone issues intercom dial toned.
2. Dial “76.”

3. Enter the Park Number assigned to the call.

“PARK PICK XX” (where “XX” is the park number) appears, and then “CO TALK #XX” (where “XX” is the trunk number of the call) appears.

### ***Related Programming***

- FF1 (System): Attendant Park Hold Recall Timer
- FF1 (System): Extension Park Hold Recall Timer

### ***Considerations***

- An alarm tone is issued if a parked call is not released before the Recall Timer expires (determined by system programming). If this happens, the user that parked the call can retrieve it by simply picking up the handset. If no one retrieves the call after the Recall Timer expires, a second alarm will sound at an attendant phone(s).
- You cannot park more than one outside line at a time.
- The Attendant Phone cannot use this feature. The Attendant must use the Attendant Call Park feature.
- The Call Park Recall Timer is similar to the Recall Timer, except that when the Call Park Recall Timer is set for “0” a call is recalled automatically in three minutes.
- You can store “75” on an FF key and use it as a Call Park key. After placing an outside call on hold, press the Call Park key to park the call. The Call Park LED will light while the call is parked and then go off when the call is released.

---

## **Call Pickup**

(All Versions)

The DBS provides both directed and group call pickup.

### **Direct Call Pickup**

#### ***Description***

A call to any extension can be answered from another extension using the Direct Call Pickup feature. The Direct Call Pickup feature can be programmed into a One-Touch key.

## ***Operation***

1. Pick up the handset.

The phone issues intercom dial tone.

2. Dial “79.”

3. Enter the number of the ringing extension.

- The extension number or the outside line number of the caller appears on the display.
- The **EXT** LED lights on the MCO or ML key.

4. Complete the call and replace the handset.

The **EXT** LED goes off.

## ***Related Programming***

- FF1 (System): Extension Class of Service Setting (CPC-AII and CPC-B 3.1 or higher)
- FF3 (Extension): Extension Class of Service Assignment (CPC-AII and CPC-B Version 3.1 or higher)

## ***Considerations***

- If more than one caller is attempting to reach the ringing extension, the Direct Call Pickup feature answers the call that arrives first.

Once the call has been picked up, other extensions that attempt to pick up the call receive busy tone.

- You can answer incoming calls, intercom calls (both tone and voice), call waiting, paging, transferred calls, or recalls using the Direct Call Pickup feature. You cannot answer alarm incoming calls or callbacks with this feature.

## Group Call Pickup

### *Description*

Using the Group Call Pickup feature, you can answer calls to other extensions in your Paging Group without entering the number of the ringing extension. Group Call Pickup can also be programmed into an FF key.

### *Operation*

1. Pick up the handset.

The phone issues intercom dial tone.

2. Dial “70.”

- The extension number or the outside line number of the caller appears on the display.
- The **EXT** LED lights.

3. Complete the call and replace the handset.

The **EXT** LED goes off.

### *Related Programming*

- FF1 (System): Extension Class of Service Setting (CPC-AII and CPC-B Version 3.1 or higher)
- FF3 (Extension): Extension Class of Service Assignment (CPC-AII and CPC-B Version 3.1 or higher)
- FF3 (Extension): Extension Page Group
- FF5 (FF Keys): FF Key Assignments for Extensions

### *Considerations*

- If more than one call is arriving at the Paging Group, the Group Call Pickup feature will answer the call to the lowest port number first.
- If the called extension belongs to more than one Paging Group, the Group Call Pickup Feature will answer the call to the lowest numbered Paging Group first.

- You can answer incoming calls, Intercom Tone Calling, or Intercom Voice Calling using the Group Call Pickup feature. You cannot answer Paging or Callback with this feature.

---

# Call Transfer

(All Versions)

The DBS provides two call transfer methods: blind transfer and screened transfer.

## Blind Transfer

### *Description*

Blind transfer allows the transfer of a call directly to an extension, without waiting for the called extension to answer.

### *Operation*

1. Press the **HOLD** key to place the outside call on hold.
  - The line LED for the outside line on hold flashes green.
  - The phone issues intercom dial tone.
  - “Hold #XX” (where “XX” is the line number) appears on the display.
2. Dial the extension number to which the call is to be transferred.

“Call-EXT XXX” (where “XXX” is the extension number) appears on the display.
3. Replace the handset before the other party answers.
  - You can also replace the handset after the third party answers.
  - The LED for the original outside line turns red when the call has been transferred.
  - “Transf XXX #YY” (where “XXX” is the extension and “YY” is the line) appear on the display.
  - The third party need only pick up the handset to speak to the outside line.

## ***Related Programming***

- FF1 (System): Onhook (Automatic) Transfer
- FF1 (System): Recall Timer for Extension-Transferred CO Calls
- FF1 (System): Recall Timer for Extension-Transferred Intercom Calls
- FF1 (System): Recall Timer for Attendant-Transferred CO Calls
- FF1 (System): Recall Timer for Attendant-Transferred Intercom Calls

## ***Considerations***

- For users to transfer calls by pressing **HOLD**, dialing the extension, and going onhook, the Onhook Transfer feature must be enabled in system programming.
- If Onhook Transfer is disabled, blind transfer is performed by pressing **HOLD**, dialing the extension number, pressing **PROG**, and then going onhook.
- If Onhook Transfer is enabled, users can transfer calls by pressing **PROG** before going onhook.
- The Attendant can transfer calls while the handset is still in place, even if the system is not set for Onhook Transfer.
- You cannot transfer a call to an extension that has Do Not Disturb or Absence Message activated.
- You can transfer a call to an extension that has Call Forwarding activated. The transferred call will follow the call forwarding path of the extension it is transferred to.

For example, if extension “A” is forwarded to extension “B,” calls that are transferred to extension “A” will be forwarded to extension “B.”

- When you transfer a call to an extension that is busy or does not answer and does not have Call Forwarding activated, the transfer will recall to your extension after the Transfer Recall Timer expires. The other extension’s number and the number of the transferred CO line or extension will appear on your display.

(For example, if you transfer an outside call on line 1 to extension 135 and that extension does not answer, the call will return to your extension and “Recall 135 #01” will appear on the display.)

# Screened Transfer

## *Description*

Using the Screened Transfer feature, you can contact a third party and announce the call before the transfer.

## *Operation*

### **To use Screened Transfer when your system is set for Onhook Transfer:**

1. Press the **HOLD** key to place the call on hold.
  - The line LED for the outside line on hold flashes green.
  - The phone issues intercom dial tone.
  - “Hold TRK #XX” (where “XX” is the line number) appears on the display.
2. Dial the extension number to which the call is to be transferred.
3. When your call is answered, inform the third party of the transfer.
  - The **EXT** LED stops flashing and remains lit.
  - “Talk-EXT XXX” (where “XXX” is the extension) appears on the display.
4. Hang up the handset.
  - The line LED for the original outside line turns red.
  - The third party need only pick up the handset to speak to the outside line.

### **To use Screened Transfer when Onhook Transfer is disabled:**

1. Press the **HOLD** key to place the outside call on hold.
  - The line LED for the outside line on hold flashes green.
  - The phone issues intercom dial tone.
  - “Hold TRK #XX” (where “XX” is the line number) appears on the display.

2. Dial the extension number to which the call is to be transferred.
3. When your call is answered, inform the third party of the transfer.
  - The **EXT** LED stops flashing and remains lit.
  - “Talk-EXT XXX” (where “XXX” is the extension) appears on the display.
4. Press the **PROG** key.
  - The line LED for the original outside line turns red.
  - “TRF XXX TRK #YY” (where “XXX” is the extension and “YY” is the line) appears on the display.
  - The third party need only pick up the handset to speak to the outside line.
5. Hang up to complete the transfer.

### ***Related Programming***

- FF1 (System): Onhook (Automatic) Transfer
- FF1 (System): Recall Timer for Extension-Transferred CO Calls
- FF1 (System): Recall Timer for Extension-Transferred Intercom Calls
- FF1 (System): Recall Timer for Attendant-Transferred CO Calls
- FF1 (System): Recall Timer for Attendant-Transferred Intercom Calls

### ***Considerations***

- The Attendant can transfer calls while the handset is still in place, even if the system is not set for Onhook Transfer.
- You cannot transfer a call to an extension that has Do Not Disturb or Absence Message activated.
- You can transfer a call to an extension that has Call Forwarding activated. The transferred call will follow the call forwarding path of the extension it is transferred to.

For example, if phone “A” is covered to phone “B,” calls that are transferred to phone “A” will be forwarded to phone “B.”

- When you transfer a call to an extension that is busy or does not answer and does not have Call Forwarding activated, a call tone is issued at your



extension after Transfer Recall Timer expires. The other extension's number and the number of the transferred CO line or extension then appear on your display and the call is returned to your extension.

(For example, if you transfer an outside call on line 1 to extension 135 and that extension is busy or does not answer, the call will return to your extension and "Recall 135 #01" will appear on the display.)

## Call Waiting

(All Versions)

### Description

You can send a Call Waiting signal, followed by a brief LED message, to a busy extension. The party receiving the message need only replace the handset and then pick it up again to be automatically connected to the message sender's extension.

The following messages can be sent using the Call Waiting feature:

*Table 4-4. Call Waiting Text Messages*

Message Code	Message
5	"Visitor Here"
6	"Need Help"
7	"Important"
8	"Urgent"
9	"Emergency"

Message codes 0-4 are not available.

With CPC-AII and CPC-B Version 4.0 or higher, users can also respond to call waiting by sending a text message. See "Call Waiting/OHVA Text Reply" on page 4-32.

### Operation

#### To set Call Waiting:

1. Press the **ON/OFF** key.
2. Dial the extension number.

The phone issues busy tone.

3. Press “3.”
  - The **EXT** LED flashes.
  - “Call Wait XXX” (where “XXX” is the extension) appears on the display.
4. If you want to send a text message, dial the desired message code (5-9).

The corresponding message displays on the called party’s phone. (If the called party does not have a display, the party continues to hear a call waiting signal.)
5. Remain on the line until the called party picks up.

**To answer Call Waiting:**

1. The **EXT** LED flashes, indicating Call Waiting has been sent.

“Call Wait XXX” (where “XXX” is the extension number) appears on the display.
2. Replace the handset.
  - The current call is disconnected.
  - “Call Wait-XXX” appears on the display.
3. Pick up the handset.
  - You are automatically connected to the extension sending the Call Waiting.
  - “Talk-EXT XXX” appears on the display.

**Note:** To answer a call waiting tone, you may flash the switchhook rather than hang up. If you flash the switchhook, you are immediately connected to the waiting party; the other party is dropped.

**To answer Call Waiting using the Talk Back key:**

A “Talk Back” key (\*3) can be assigned to an FF key. The Talk Back key allows you to answer a waiting call without disconnecting the original call.

1. The LED of the Talk Back key flashes red, indicating Call Waiting has been sent.
2. Press the Talk Back key to answer Call Waiting.

- The LED of the Talk Back key flashes green.
  - The current call is held automatically.
3. Press the Talk Back key again to return to the original call.

The LED of the Talk Back key goes off when the Call Waiting party hangs up.

### ***Related Programming***

- FF1 (System): Extension Class of Service Setting (CPC-AII and CPC-B Version 3.1 or higher)
- FF3 (Extension): Extension Class of Service Assignment (CPC-AII and CPC-B Version 3.1 or higher)
- FF3 (Extension): Call Waiting/OHVA
- FF5 (FF Key Settings): FF Key Assignments for Extensions

### ***Considerations***

- Message code 8 cannot be used from an SLT. (The digit “8” is used to transfer calls on SLTs.)
- Call Waiting can be used without the user entering a message code.
- Call Waiting is cancelled when the sender replaces the handset.
- If the called extension has DND activated, has a call on hold, is ringing (from another call), or is engaged in a conference call, Call Waiting cannot be sent.
- A call on an outside line can be placed on hold before Call Waiting is answered to avoid terminating the original call. An Intercom Call, however, must be terminated before Call Waiting can be answered.
- If Onhook Call Transfer has been enabled and you have placed an outside line on hold to answer Call Waiting, replace the handset after the other extension hangs up. If the caller hangs up first, *the held call will be transferred to the called extension.*
- Call Waiting cannot be sent to an ML key.

# Call Waiting/OHVA Text Reply

(CPC-AII and CPC-B Version 4.0 or higher)

## Description

When a busy party receives an indication of incoming intercom call, the busy party can respond by sending a text message back to the caller.

The text message can be sent after any of these intercom call indications:

- Call waiting tone
- Call waiting tone followed by a text message
- An offhook voice announce.

## Operation

When you are on a call and receive an indication of a incoming intercom call, press **CONF** and then dial 1-5.

The following table shows the default text associated with messages 1-5.

Message Number	Message Definition
1	Take A Message
2	Please Hold
3	Will Call Back
4	Transfer
5	Unavailable

Messages 1-5 can be changed through system programming.

## Programming

- FF6 (Names and Messages): Call Waiting/OHVA Text Reply

## Considerations

- Text messages 1-5 can be changed from an attendant phone or a DSS/72.

# Caller ID Call Log

(CPC-AII Version 6.1 or higher and CPC-B Version 6.1 or higher)

## Description

The Call Log keeps a record of Caller ID calls to individual phones. The Call Log allows users to view Caller ID calls that have been sent to their phone.

Users can assign an FF key (\*6) to flash when there are new entries in the log. When the user presses the key to access the log, the LED turns off.

Call Logs can be assigned to both attendant and non-attendant extensions.

## Operation

The Call Log keeps a record of Caller ID calls to individual phones. The Call Log allows users to view Caller ID calls that have been sent to their phone.

Users can assign an FF key to flash when there are new entries in the log. When the user presses the key to access the log, the LED turns off.

Call Logs can be assigned to both attendant and non-attendant extensions. The following table shows maximums for the number of entries that can be stored for each type of extension. The table also shows the total number of entries that can be stored system wide.

*Table 4-5. Call log maximums*

Call Log Maximums	Maximum
Maximum number of attendant extensions	4
Maximum number of non-attendant extensions	15
Maximum number of all types of extensions	19
Number of log entries that can be stored for an attendant extension. (After the call log fills with 25 entries, each additional entry overwrites the oldest log entry.)	25
Number of log entries that can be stored for a non-attendant extension. (After the call log fills with 10 entries, each additional entry overwrites the oldest log entry.)	10
Number of log entries that can be stored system wide	250

## Types of Calls Included

The call log stores information for Caller ID calls that ring a phone. If the phone does not ring (for instance when Call Forward - All Calls is active), there is no entry in the Call Log for that call.

## Call Log Information

Each Call Log entry includes the following call information:

- Calling number
- Calling name (if provided)
- Time and date
- Whether the call was answered
- How the call was routed.

## Call Log Format

The most recent entries are stored first in the Call Log. When users view the log by pressing the **Call Log Key**, they can select a specific entry by pressing the \* key for the previous entry or the # key for the next entry.

### *Log Format for the Small-Display Phone.*

In addition to viewing the calling number information by pressing the Call Log Key, users can view the detailed information on each entry by pressing the CONF key.

For example, when a Call Log entry is first displayed by pressing the **Call Log Key**, the following information is shown.

*Figure 4-2. Call log format for the small-display phone--calling number and name*

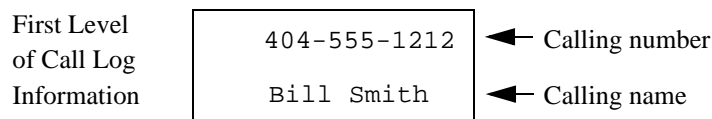

Pressing the CONF key displays the next level of information:

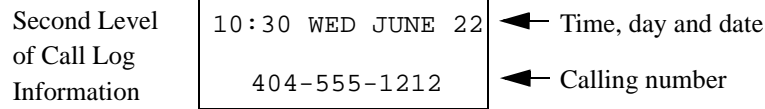
**Figure 4-3. Call log format for the small-display phone--time and date**

Pressing the **CONF** key again displays the next level of information.

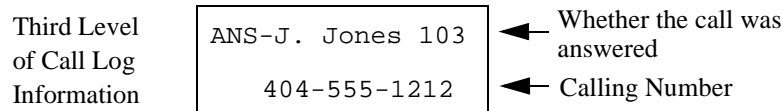
**Figure 4-4. Call log format for small-display phone--answer information**

Pressing the **CONF** key again displays this information.

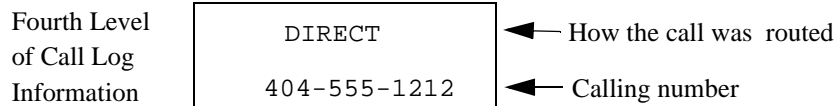
**Figure 4-5. Call log format for small-display phone--routing information**

Pressing the **CONF** key again returns the display to the first level of call log information.

Other call log entries can be viewed by pressing the \* key for the previous entry or the # key for the next entry. A “<” appears beside the oldest entry in the log.

Exit the Call Log display by pressing the **ON/OFF** key.

***Log Format for the Large-Display Phone.***

Large-display phone users can view all four levels of the Call Log on one screen.

For example, when the large-display phone user presses the **Call Log Key**, the following display appears:

***Figure 4-6. Call log format for the large-display phone--calling number***

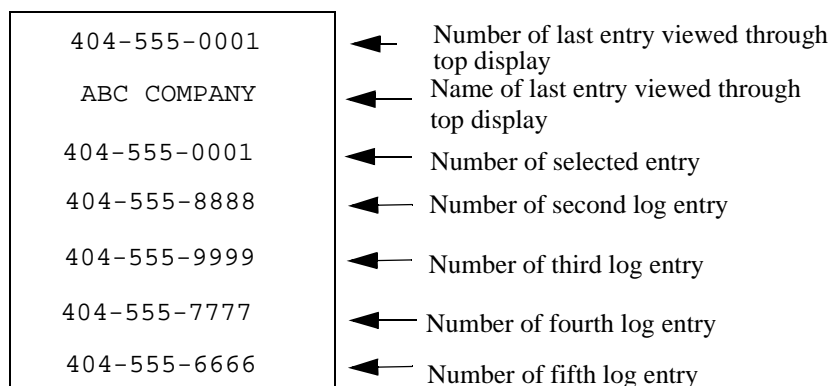

A “<” may appear to the right side of one of the entries. This indicates the oldest entry in the log.

By pressing the soft key next to the desired entry, the user can view the details of a particular call.

***Figure 4-7. Call Log format for the large-display phone--detailed call information***

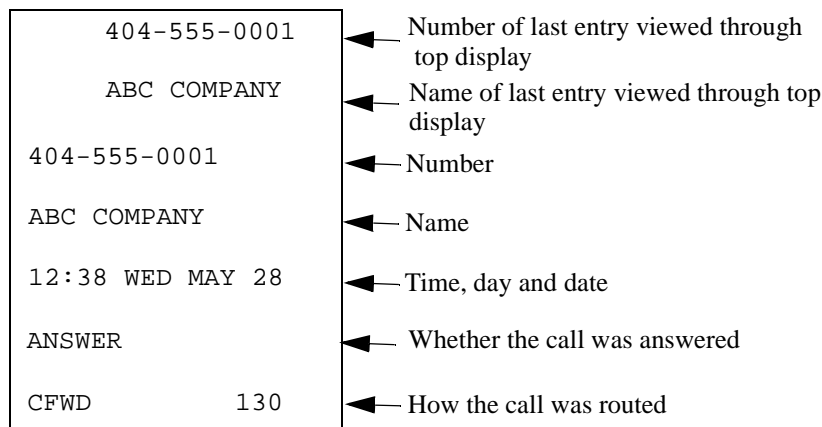

Press any soft key to return to the calling number listing format as shown in Figure 1-6.

Other Call Log entries can be viewed by pressing the \* key for the previous log entry or the # key for the next log entry. If these keys are pressed while



viewing detailed information, the detailed information is displayed for the newly selected log entry.

Exit the Call Log display by pressing the **ON/OFF** key.

### **Considerations**

- Caller ID feature must be installed and enabled. (See “Caller ID” on page 3-14 for more information.)
- To have Caller ID Call log indications, an FF key must be assigned as a Call Log Indication Key (\*6).

---

## **Camp-on**

(All Versions)

### **Description**

If you reach a busy extension, the Camp-on feature will alert you with a ring when the extension becomes free. You will then be able to pick up your handset to automatically dial the extension.

### **Operation**

#### **To activate the Camp-on feature:**

1. Pick up the handset.
2. Dial the desired extension number.

If the extension is busy, your phone issues busy tone.

3. Press “3.”
  - The phone issues ringback tone.
  - If the Camp-on feature cannot be set, the phone continues to issue busy tone.
4. Replace the handset after you hear the ringback tone.
5. Wait for the extension callback ring.

**To answer the callback ring:**

1. Pick up the handset when you hear the callback ring.
  - “Camp-on Call” appears on the display.
  - The **EXT** LED flashes.
  - The system automatically dials the called extension.

**Related Programming**

- FF3 (Extension): Call Waiting/OHVA

**Considerations**

- The callback ring must be answered within sixteen seconds or it will be canceled.
- A Camp-on request will only be accepted *after* Call Waiting status.
- An extension can only have one call camped on at a time. For example, if Extension 152 camps on to Extension 153, another extension cannot camp on to 153, as long as 152 is camped on.
- An extension that has initiated a camp-on cannot receive a camp-on. For instance, if Extension 200 has camped on to Extension 300, another extension cannot camp on to 200.

---

## CO Line Key Trunk Access

(All Versions)

**Description**

You can access an outside line by pressing a CO line key.

**Operation**

1. Press an unlit line key.
  - The phone issues outside dial tone.
  - The line LED lights green.
  - “CO TALK #XX” (where “XX” is the line) appears on the display.

2. Dial the telephone number.

The dialed number appears on the display.

3. Complete the call and replace the handset.
  - The line LED changes from green to red and then goes off.
  - The time and date reappears on the display.

### ***Related Programming***

- FF1 (System): SMDR Display Start Timer for CO Calls
- FF5 (FF Keys): FF Key Assignments for Extensions

### ***Considerations***

- The duration of a call appears on the display while the call is in progress (if enabled in programming).
- In CPC-A and CPC-B Versions prior to 3.1, the SMDR Display Start Timer can be set to start 16 or 30 seconds after the last digit of the telephone number is dialed.

In CPC-AII and CPC-B Version 3.01 or higher, the timer can be set to start at 5, 16, or 30 seconds.

---

## **Conference Calls**

(All Versions)

### ***Description***

Conference Calls allow an extension user to add a party to an existing conversation.

Extension users can create the following types of Conference Calls:

- One outside line and two extensions
- Two outside lines and one extension
- One outside line and three extensions
- Two outside lines and two extensions

- Three extensions
- Four extensions.

## **Operation**

### **To establish a Conference Call:**

1. Press **HOLD** or the line key of your current call to place it on hold.

The extension number, outside line number, or name of the party on hold appears on the display.

2. Press any unlit line key or dial the number of the extension you wish to add to the call.

- The line LED lights green.
- The phone issues outside dial tone.
- “CO TALK #XX” (where “XX” is the line number) appears on the display.

3. If you pressed an unlit line key in step 2, dial the number of the party you wish to add to the call.

The number appears on the display.

4. Press the **CONF** key when your call is answered.

If you are now conducting a three-way Conference Call involving two outside lines, “CONF #XX #YY” (where “XX” is the first line and “YY” is the second line) appears on the display.

5. Repeat steps 1-4 to add a fourth party to a three-party Conference Call.

### **To add an extension to an outside call:**

1. Press the **HOLD** key during the outside call.
2. Dial the additional party.
3. After the extension answers, press **CONF**.

The three parties can now speak to one another.

4. Repeat steps 1-3 to add another extension to a three-party Conference Call.

**To establish an Unsupervised Conference Call:**

1. Press **HOLD** or the line key of your current call to place it on hold.  
  
The outside line number or name of the party on hold appears on the display.
2. Press an unlit line key .
  - The line LED lights green.
  - The phone issues outside dial tone.
  - “CO TALK #XX” (where “XX” is the line number) appears on the display.
3. Dial the number of the party you wish to add to the call.  
  
The number appears on the display.
4. Press the **CONF** key when your call is answered.  
  
“CONF #XX #YY” (where “XX” is the first line and “YY” is the second line) appears on the display.
5. To drop out of the conference and establish the Unsupervised Conference Call, press **HOLD**.
6. To return to the call, press one of the conference line keys.
  - The SCC-A card provides 3 four-party conference circuits. The SCC-B provides 8 four-party conference circuits
  - Press **FLASH** or hang up to exit a Conference Call.
  - The Call Hold feature cannot be used during a four-party Conference Call.

***Related Programming***

- FF1 (System): Unsupervised Conference Timer
- FF2 (Trunk): Unsupervised CO Conference
- FF3 (Extension): Unsupervised Conference

---

# Delayed Ringing

(CPC-AII and CPC 2.0 and higher)

## *Description*

Delayed ringing causes a call that is unanswered at a primary extension to ring at a secondary extension.

CO delayed ringing causes an incoming outside call to ring at a designated extension or extensions if it is not answered within a certain period of time. CO delayed ringing is also available for hunt group pilot numbers.

Extension delayed ringing causes any type of call, outside or intercom, to ring at a designated extension or extensions if it is not answered within a certain period of time. The phones receiving the delayed call must have a DSS/BLF key assigned to the extension originally intended to receive the call.

## *Considerations*

- In CPC-B Versions prior to 3.1, timing for CO and extension delayed ringing was controlled by the Call Forward - No Answer Timer.
- In CPC-AII and CPC-B Versions 3.1 and higher, the following timers have been implemented:
  - The Central Office Delayed Ring Timer controls delayed ringing for outside calls.
  - The Extension Delayed Ring Timer controls delayed ringing for extension calls.

---

# Dial “0” for Attendant

(All Versions)

## *Description*

The Attendant can be called from any extension by simply pressing “0.”

If multiple attendants are assigned, a dial “0” call goes to the first Attendant first. If the first attendant is busy, the call goes to the second Attendant. The call will continue to transfer to the next attendant in the attendant group if necessary.

With CPC-A and CPC-B Version 1.0, a maximum of two attendants can be assigned. Beginning with CPC-B Version 2.0, up to four attendants can be assigned.

## ***Operation***

1. Pick up the handset or press **ON/OFF**.

The phone issues intercom dial tone.

2. Press “0.”
  - “Talk-EXT 100” appears on the display if your extension is set for Voice Calling.
  - “Call-EXT XXX” (where “XXX” is the extension) appears on the display if your extension is set for Tone Calling.

## ***Related Programming***

- FF1 (System): Second Attendant Position
- FF1 (System): Third Attendant Position
- FF1 (System): Fourth Attendant Position
- FF1 (System): Attendant Transfer Extension
- FF6 (Names and Messages): Extension Name

## ***Considerations***

- If the Attendant’s name has been stored it appears on the display instead of the extension number.

---

# Dial Tone Disable

(All Versions)

## *Description*

The intercom dial tone can be turned off at a phone. Dial tone is turned off when a headset is used.

## *Operation*

### **To disable the intercom dial tone:**

1. Press the **ON/OFF** key.
  - The phone issues intercom dial tone.
  - The **ON/OFF** LED lights.
2. Press “#50.”
3. Press the **ON/OFF** key.

The **ON/OFF** LED goes off.

### **To reactivate dial tone:**

Repeat the preceding steps.



---

# Do-Not-Disturb (DND)

(All Versions)

## *Description*

An extension can be made unavailable by activating Do-Not-Disturb (DND). When DND is activated at an extension, calls to that extension receive busy tone.

## *Operation*

### **To activate DND:**

1. Press the **ON/OFF** key:
  - The phone issues intercom dial tone.
  - The **ON/OFF** LED lights.
2. Dial “73.”
  - The **DND/CF** LED lights.
  - “DND Set” appears on the display.
3. Press the **ON/OFF** key.

The **ON/OFF** LED lights.

### **To cancel DND:**

1. Press the **ON/OFF** key:
  - The phone issues intercom dial tone.
  - The **ON/OFF** LED lights.
2. Dial “73.”
  - The **DND/CF** LED lights.
  - “DND Canceled” appears on the display.
3. Press the **ON/OFF** key.

The **ON/OFF** LED goes off.

## ***Related Programming***

- FF1 (System): Extension Class of Service Setting (CPC-AII and CPC-B Version 4.0 or higher)
- FF3 (Extension): Extension Class of Service Assignment (CPC-AII and CPC-B Version 4.0 or higher)

## ***Considerations***

- Callback Queuing will ring an extension in DND.
- A Private Line will ring an extension in DND.
- In CPC-A and CPC-B Versions prior to 5.0, DND and Absence Messages cancel Call Forwarding.

Beginning with Version 5.0, calls to an extension with DND or Absence Message turned on are treated differently, depending on whether they are trunk or intercom calls. Intercom calls receive busy tone; trunk calls are routed to the extension defined in permanent call forwarding.

The following types of incoming trunk calls will follow permanent call forward settings:

- Direct trunk calls (including DID/DNIS)
- Transferred trunk calls.
- With CPC-A and CPC-B Version 1, DND is not available for Attendant Phones. Beginning with CPC-B Version 2.0, Attendant Phones can activate DND.
- The Attendant can activate or cancel this feature on an extension using FF key LEDs on a DSS console.
- The DND feature cannot be activated from an extension selected to receive call forwarding.

---

# EM/24 Console

(All Versions)

## *Description*

Connecting an EM/24 console to your extension adds twenty-four FF keys. By assigning extensions to its FF keys, you can use an EM/24 console as a BLF (Busy Lamp Field).

Please refer to “Appendix A: CPC-EX 1.0 Updates” and “Appendix B: CPC-All/B 8.0 Updates” for additional information on the new telephones, DSS/72, and EM/24 available for the DBS system.

## *Related Programming*

- FF3 (Extension): Terminal Type
- FF3 (Extension): EM/24 Port Assignment

## *Considerations*

- An EM/24 console can be connected to any key phone.

---

# Flexible Function (FF) Keys

(All Versions)

## *Description*

You can assign frequently used functions to programmable keys on key phones, DSS consoles, and EM/24 consoles. All keys not already assigned as line or Speed Dialing keys are available for programming.

Up to six digits can be stored in an FF key. (The LED of the FF key will not light when digits are stored in the key.)

You can also store the **PROG**, **CONF**, **AUTO**, **REDIAL** (for redialing only, not for inserting a pause), and **FLASH** features.

Also, you can assign External Call Forwarding, combined with either a Personal Speed Dial code or a System Speed Dial code, to an FF key. You can also assign a pilot extension number as a Call Forwarding destination by storing Call Forwarding, combined with the pilot extension number (0, 10-69, or 100-699), in an FF key.

**Note:** FF keys assigned as CO lines must be cleared using system programming before new FF assignments can be made.

## **Operation**

### **To assign pre-programmed codes to an FF key:**

1. Press the **ON/OFF** key:
  - The phone issues intercom dial tone.
  - The **ON/OFF** LED lights.
2. Press the **PROG** key.

“F” appears on the display.
3. Press the FF key to be programmed.

“Enter Code” appears on the display.
4. Enter the code to be programmed (see Table 4-6).

The programmed code appears on the display.
5. Press the **HOLD** key.

“Code Stored” appears on the display.
6. Repeat steps 2-5 to program additional keys.
7. Press the **ON/OFF** key.

The **ON/OFF** LED goes off.

### **To assign digits to an FF key:**

1. Press the **ON/OFF** key.
2. Press the **PROG** key.
3. Press the FF key to be programmed.

“Enter Code” appears on the display.
4. Enter up to six digits.
5. Press the **HOLD** key.

**To assign Call Forwarding--External to an FF key (CPC-All/CPC-B prior to 7.0):**

1. Press the **ON/OFF** key.
2. Press the **PROG** key.
3. Press the FF key to be programmed.  
“Enter Code” appears on the display.
4. Enter “72.”
5. Press “3.”
6. Press the **AUTO** key.
7. Enter the Speed Dial code (System Speed dial 00-89 or Personal Speed dial 90-99 or 900-909).

**Note:** The speed dial code must include the **CONF** key (to indicate a trunk call), the appropriate trunk access code, and the outside number.

8. Press the **HOLD** key.

Intercom Calls will now be forwarded. CO incoming calls and transferred CO calls will not be forwarded to an outside line.

**To assign Call Forwarding--Outside to an FF key (CPC-All/CPC-B 7.0 and later):**

1. Press the **ON/OFF** key.
2. Press the **PROG** key.
3. Press the FF key to be programmed.  
“Enter Code” appears on the display.
4. Enter “72.”
5. Dial the appropriate call forwarding code.

Call Forward Type	Code
All	0
Busy/no answer	1
Busy	2
No answer	4

“ENTER FWD EXT#” appears on the display.

6. Press the **AUTO** key.
7. Enter the Speed Dial code (System Speed dial 00-89 or Personal Speed dial 90-99 or 900-909).

**Note:** The speed dial code must include the **CONF** key (to indicate a trunk call), the appropriate trunk access code, and the outside number.

8. Press the **HOLD** key.

Calls will now be forwarded according to the forwarding type selected.

### **To assign Call Forwarding to a Hunt Group pilot number or an extension number to an FF key:**

1. Press the **ON/OFF** key.
2. Press the **PROG** key.
3. Press the FF key to be programmed.

“Enter Code” appears on the display.

4. Enter “72.”
5. Enter the Call Forwarding code (0, 1, 2, or 4).
6. Enter the Hunt Group pilot number or an extension number.
7. Press the **HOLD** key.

### **To erase a code stored in an FF key:**

**Note:** *FF keys assigned as CO lines cannot be cleared using the following procedure. CO line keys can only be cleared through system programming.*

1. Press the **ON/OFF** key.
2. Press the **PROG** key.
3. Press the FF key to be programmed.

“Enter Code” appears on the display.

4. Press the **HOLD** key.

“Code Cleared” appears.

**To check a programmed FF key:**

1. Press the **ON/OFF** key:
  - The phone issues intercom dial tone.
  - The **ON/OFF** LED lights.
2. Press the **CONF** key.
 

“C” appears in the display.
3. Press the FF key to be checked.
 

The programmed data appears on the display.
4. Press the **ON/OFF** key.
  - The **ON/OFF** LED goes off.
  - The date and time appear on the display.

**Related Programming**

- FF5 (FF Keys): FF Key Assignments for Extensions
- FF9 (Copy Program): FF Key Copy

**Considerations**

- The following functions can be assigned to FF keys:

*Table 4-6. Feature access codes for FF key assignments*

<b>Feature</b>	<b>Code to be entered</b>
Call Attendant	0
Intercom Call	Extension number (10-69) or (100-699)
Outside Line	88, outside line number (01-64)
Pooled Trunk Access	Outside line group number (89, 81-86) <b>Note:</b> “9” can be used as an outside line group number if it is not used for LCR.
LCR	89
Paging	#, Paging Group number (00-07)
Call Park	75
Call Park Retrieve	76

<b>Feature</b>	<b>Code to be entered</b>
DND Activate/Cancel	73
Absence Message Activate/Cancel	71
Call Forwarding	72, 720, 721, 722, 723 or 724
Reminder Call Activate/Cancel	#4
Station Lockout	74, lockout code (max. 4 digits)
Dial Tone On/Off	#50
Direct Call Pickup	79
Group Call Pickup	70
Account Code 1	#7, account code (max. 6 digits)
Account Code 2	<b>AUTO</b> , #, account code (max. 6 digits)
Speed Dialing	<b>AUTO</b> , speed dial number (00-99, 000-199 or 900-909)
Night Service On/Off	#52 (Attendant only)
Intercom	#8
Message Clear	<b>AUTO, FLASH</b>
Message Call	<b>AUTO, REDIAL</b>
Headset On/Off	#51
BGM On/Off	#53
Answer Key	*1
Release Key	*2
Talk Back Key	*3
Paging Meet-Me Answer	77
Universal Night Answer Pickup	78
Save Number for Redial	<b>AUTO, AUTO, *</b>
Redial Saved Number	<b>AUTO, *</b>
<b>MUTE</b> Key	*#
<b>FLASH</b> key	FLASH
Caller ID Log Key	*6

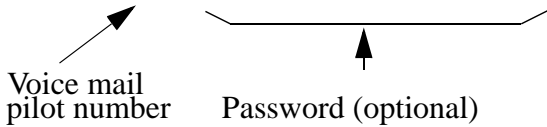
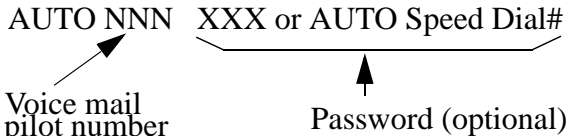

Feature	Code to be entered
Voice Mail Transfer Key (CPC-AII and CPC-B Version 6.0 or higher)	<p style="text-align: center;">  </p> <p><b>Note:</b> If a password is used, it can be from 1 to 3 digits. If the password is over 3 digits, it must be assigned to a personal or system speed dial number . Include an ending # sign in the speed dial number if you are accessing a DBS voice mail system.</p>
One-Touch VM Access (CPC-AII and CPC-B Version 5.0 or higher)	<p style="text-align: center;">  </p> <p><b>Note:</b> If a password is used, it can be from 1 to 3 digits. If the password is over 3 digits, it must be assigned to a personal or system speed dial number . Include an ending # sign in the speed dial number if you are accessing a DBS voice mail system.</p>

- If a new code is programmed into a key, the previously programmed code is erased.
- To erase a code programmed into a key, press the **HOLD** key when the display reads “Enter Code.” “Code Cleared” then appears on the display.
- The system can be programmed so that Pooled Trunk Access calls automatically use LCR when 9 is selected.
- Night Service, DND, and BGM can be activated through FF keys without lifting the handset.
- When you are making a call using the Speed Dialing feature, the **FLASH** key stored in Speed Dialing becomes the PBX flash feature.
- When an extension is assigned to an FF key, the FF key changes colors to indicate the status of the extension as follows:
  - RED (solid) -- extension busy
  - RED (flashing) -- incoming call or receiving call waiting (DSS/72 and EM/24 keys stay solid red instead of flashing red)
  - GREEN -- either DND, call forwarding, or absence message set.

---

# Handsfree Answerback

(All Versions)

## *Description*

Use the Handsfree Answerback feature to answer a call without lifting the handset. The DBS system must be programmed for Voice Calling for you to use this feature. If your system is not set for Voice Calling, the caller must press “1” during a call to switch from Tone Calling to Voice Calling.

## *Operation*

1. Confirm that the **MUTE** LED is off.  
If it is lit, press the **MUTE** key to turn it off.
2. Speak into the microphone.

## *Related Programming*

- FF1 (System): Extension Intercom Calling

## *Considerations*

- Stay within three feet of the microphone.
- The **MUTE** feature controls the handsfree microphone but not the handset.
- The **MUTE** feature can be selected from the Menu screen on large display phones. With other DBS key phones, the **MUTE** function is assigned to a fixed key.

---

# Handsfree Operation

(All Versions)

## *Description*

Handsfree operation is available with all speakerphones (but not the DSLT). This type of operation allows you to use all available DBS features without lifting the handset.

## *Operation*

To initiate handsfree operation, press the **ON/OFF** key. This takes the phone offhook and provides access to the full range of calling features.

## *Considerations*

- Stay within three feet of the microphone.
- The **MUTE** feature controls the handsfree microphone but not the handset.
- The **MUTE** feature can be selected from the Menu screen on large display phones. With other DBS key phones, the **MUTE** function is assigned to a fixed key.

---

# Headset Operation

(All Versions)

## *Description*

Headset operation allows you to handle calls with a headset instead of with the handset or speakerphone.

## *Operation*

1. Pick up the handset or press **ON/OFF**.
2. Dial **#51**.

If headset mode is already on, these steps turn it off; if headset mode is off, these steps turn it on.

---

# Hot Dial Pad

## *Description*

The dial pad on digital key phones can be designated as “hot” on an extension-by-extension basis.

The Hot Dial Pad allows the user to initiate a call without going offhook. Extensions with the Hot Dial Pad enabled can initiate calls by pressing any of the numeric keys (0-9). The “\*” and “#” keys are not hot.

The Dial Pad can be hot under these conditions:

- When the extension is idle
- When the extension is holding a call
- When the extension is receiving a page.

The Dial Pad cannot be hot under these conditions:

- When a call is ringing at the extension (intercom or CO)
- When the extension is on a call.

## *Related Programming*

- FF3 (Extension Programming): Hot Dial Pad

## Considerations

*Paging:* The Hot Dial Pad cannot be used to initiate a page.

---

# Intercom Calling

(All Versions)

## *Descriptions*

The DBS provides two methods of intercom calling: voice calling and tone calling.

**Voice Calling.** With voice calling, intercom calls are connected immediately, without a ringing tone.

**Tone Calling.** With tone calls, a ringing tone is sent to the called extension.

System programming determines whether the DBS uses voice or tone calling as a default. If voice calling is the default, dialing “1” after the extension number changes the call to a tone call. If tone calling is the default, dialing “1” results in a voice call.

## **Operation**

### **To make a Voice Call:**

1. Pick up the handset.

The phone issues intercom dial tone.

**Note:** If you are calling from an extension programmed for Prime Line Preference, press the FF key programmed for intercom operation.

2. Dial the extension number (10-69) or (100-699).
3. If the system default is tone calling, dial “1.”
  - “Talk-EXT XXX” (where “XXX” is the extension) appears on the display. If the extension name has been stored, that name appears on the display after “Talk” instead of “-EXT XX.”
  - The **EXT** LED lights.
4. Complete the call and replace the handset.

The **EXT** LED goes off.

### **To transfer a call using Voice Calling:**

1. Press the **HOLD** key.
  - The **EXT** LED flashes.
  - “Hold-EXT XXX” (where “XXX” is the extension) appears on the display.
2. Dial the number of the extension to which the call will be transferred.
3. If the system default is tone calling, dial “1.”

“Talk-EXT XXX” (where “XXX” is the extension) appears on the display.

4. Replace the handset.

**To make an Tone Call:**

1. Pick up the handset.

The phone issues intercom dial tone.

**Note:** If you are calling from an extension programmed for prime line preference, press the FF key programmed for intercom operation.

2. Dial the extension number.
3. If the system default is voice calling, dial “1.”
  - “Call-EXT XXX” (where “XXX” is the extension) appears on the display. If the extension name has been stored, that name appears, rather than the extension number.
  - The called extension rings and the **EXT** LED flashes.
  - When the call is answered, Talk-EXT XXX” (where “XXX” is the extension) appears on the display. If the extension name has been stored, that name appears on the display after “Talk” instead of “-EXT XXX.”
4. Complete the call and replace the handset.

The **EXT** LED goes off.

**To transfer a call using Tone Calling:**

1. Press the **HOLD** key.
  - The **EXT** LED flashes.
  - “Hold-EXT XXX” (where “XXX” is the extension) appears on the display.
2. Dial the number of the extension to which the call will be transferred.
3. If the system default is voice calling, dial “1.”

“Call-EXT XXX” (where “XXX” is the extension) appears on the display.

4. Replace the handset.

## ***Related Programming***

- FF1 (System): Extension Intercom Calling
- FF1 (System): Alert Tone for Voice Calls
- FF1 (System): Extension Class of Service Setting (CPC-AII and CPC-B Version 4.0 or higher)
- FF3 (Extension): Extension Class of Service Assignment (CPC-AII and CPC-B Version 4.0 or higher)

## ***Considerations***

- When an extension's calling mode is set to voice calling, a "splash" tone can be sent to alert the extension to the voice call. System programming determines if the splash tone is provided.
- If an extension is offhook, it will receive tone calls.
- Calls to OPX and analog SLT extensions are always tone calls, regardless of system programming.
- The voice calling feature is not available for incoming DISA calls.
- Voice calls do not forward if Cover No Answer is turned on.

---

# **Last Number Redial**

(All Versions)

## ***Description***

The last outside number dialed may be redialed automatically by pressing the **REDIAL** key.

## ***Operation***

1. Press an unlit line key.
  - The phone issues outside dial tone.
  - The line LED lights green.
  - "CO TALK #XX" (where "XX" is the line number) appears on the display.

2. Press the **REDIAL** key.

The last number dialed appears on the display.

3. Complete the call and replace the handset.

The line key LED changes from green to red and then goes off.

## Considerations

- If the Auto Flash Redial feature is set, you can flash the outside line once by pressing the **REDIAL** key at the busy tone. You can then redial the last number dialed.
- The Last Number Redial feature can redial a number up to sixteen digits long.
- A maximum of five chained Speed Dialing codes can be redialed. See “One-Touch Keys” on page 4-74 for more information.

---

## Line Appearances

(All Versions)

The DBS provides up to four types of line appearances, depending on the CPC version used.

The following table summarizes how each type of line appearance is used:

*Table 4-7. MCO and ML key definitions*

<b>Key</b>	<b>Definition</b>
DSS/BLF Appearances	DSS/BLF keys provide one-touch dialing, direct station selection (DSS), and busy lamp fields (BLF) for extensions.
Direct Line (DL) Appearances	DL keys are used to originate and receive calls over specific trunk numbers.
Multi-CO (MCO) Appearances	MCO keys are used to originate and receive CO calls.
Multi-Line (ML) Appearances	ML keys are used to originate and receive CO line calls and intercom calls.



---

# DSS/BLF Appearances

(CPC-AII and CPC-B Version 2.0 or higher)

## *Description*

When a DSS/BLF key is programmed, it automatically provides direct station selection and busy lamp field for the assigned extension number. If desired, the DSS/BLF key can also provide ring monitor.

For example, you can set extension A as a DSS/BLF key on extension B. When extension A rings, the LED of the DSS/BLF key on extension B flashes. If extension B answers the call by pressing the DSS/BLF key, the LED on extension A goes off and the call remains only on the DSS/BLF key of extension B.

Ringling can be set on either one or both extensions. If the extensions are not set for ringling, the LED of the DSS/BLF key will flash red. If the extensions are set for ringling, the LED will flash green.

When extension A is in use, the LED of the DSS/BLF key on extension B will light red. If one extension has the Absence Message, Call Forwarding, or Do-Not-Disturb feature activated, the DSS/BLF key will light green.

## *Operation*

### **To assign a DSS/BLF key:**

1. Press the **PROG** key.
2. Press the FF key you want to assign the DSS/BLF appearance to.
3. Dial the extension number.
4. Press the **HOLD** key.

### **To make an intercom call using the DSS/BLF key:**

Press the idle DSS/BLF key.

### **To pick up a call on a DSS/BLF key:**

Press the flashing DSS/BLF key.

## Related Programming

- FF1 (System): Extension (BLF) Delayed Ring
- FF4 (Ringing and Hunt Groups): Extension Ring Table
- FF5 (FF Keys): FF Key Assignments for Extensions

## Considerations

- Ringing assignments for DSS/BLF keys are assigned through system programming.
- If several calls arrive at an Extension Line key, the calls are queued and ring on a first-in, first-out basis.

## Direct Line (DL) Appearances

(CPC-AII and CPC-B Version 2.0 or higher)

### Description

Direct Line keys for making and receiving outside line calls can be assigned to any one of sixty-four CO lines. Direct Line keys have priority over Multi-Line keys for outgoing and incoming outside line calls.

The LED for a Direct Line key will flash green on an incoming call if the CO line is set to ring. It will flash red if the CO line is not set to ring. If another extension answers the call, the LED on the telephone will steadily light red.

### Operation

Operation	Action
To originate a trunk call ...	Press an idle DL key. The key blinks (green) as the call is made.
To place a call on Exclusive Trunk Hold (page 4-37) ...	Press the DL key.
To place a call on System Trunk Hold (page 4-18) ...	Press the <b>HOLD</b> key.
To transfer a call ...	Press <b>HOLD</b> , dial the destination extension, and then press <b>PROG</b> .

## ***Related Programming***

- FF1 (System): Alert Tone for Busy Override and OHVA
- FF3 (Extension): Busy Override Send
- FF3 (Extension): Busy Override Receive
- FF5 (Keys): FF Key Assignment (all)

## ***Considerations***

- Beginning with CPC-B Version 5.0, users can barge into a busy Direct Line (DL) and create a three-party conference. To barge into a busy Direct Line, the user presses the DL key. (The DL key will be lit red.)
- “Barge-in for Direct Lines” is controlled by the program settings for Busy Override. For instance, if an extension with a DL key does not want the DL broken into, that extension must have “Busy Override Receive” turned off.
- Both extensions must belong to the same paging group (1-7). Paging group 0 does not allow override.
- Barge-in for Direct Lines cannot override a DL under the following conditions:
  - When the DL is in a conference call
  - When the DL is holding a call.
  - When the phone that will be barged into is holding a trunk that does not appear on an FF key.

For example, if extension 200 wants to barge into a DL that appears on extension 201, extension 200 cannot barge into the DL if 201 is holding a trunk that does not appear on an FF key.

## **Multi-CO (MCO) Appearances**

(All Versions)

### ***Description***

You can make and receive CO line calls using a Multi-CO (MCO) key. Each extension can have up to 24 MCO keys. The Attendant can have up to 24 MCO keys.

An MCO key can be assigned to any of the pooled trunk groups. See “Pooled Trunk Access” on page 4-81 for more information.

See “ML/MCO Separation” (page 4-65) for information on assigning both ML and MCO keys to the same system (CPC-AII and CPC-B Version 4 or higher).

### **Operation**

<b>Operation</b>	<b>Action</b>
To originate a trunk call	Press an idle MCO key. The key blinks (green) as the call is made.
To place a call on Exclusive Trunk Hold (page 4-37)	Press the MCO key.
To place a call on System Trunk Hold (page 4-18)	Press the <b>HOLD</b> key.
To transfer a call	Press <b>HOLD</b> , dial the destination extension, then press <b>PROG</b> .

### **Related Programming**

- FF1 (System): Least Cost Routing (LCR) Access
- FF2 (Trunks): Pooled Trunk Access for Group “9”
- FF2 (Trunks): Pooled Trunk Access for Groups “81-86”
- FF3 (Extension): Forced Least Cost Routing
- FF5 (Keys): FF Key Assignments (all)
- FF8 (LCR) LCR Settings (all)

### **Considerations**

- When all trunks in a group are busy, the corresponding MCO key lights red.
- If LCR is enabled, MCO keys can be assigned for trunk group 89. However, the FF keys will not light.
- Press the MCO key that flashes red to answer an outside call.
- There are seven groups of outside lines: 9 and 81-86.

## Multi-Line (ML) Appearances

(CPC-AII and CPC-B Version 2.0 or higher)

### Description

You can make and receive both CO line calls and Intercom Calls using a Multi-Line (ML) key. Each extension can have up to 24 Multi-Line keys. The Attendant can have up to 24 Multi-Line keys.

See “ML/MCO Separation” (page 4-66) for information on assigning both ML and MCO keys to the same system (CPC-AII and CPC-B Version 4 or higher).

### Operation

Operation	Action
To originate a trunk call	Press an idle ML key. The key blinks (green) as the call is made.
To place a call on Exclusive Hold (page 4-37)	Press the ML key.
To place a call on System Hold (page 4-18)	Press the <b>HOLD</b> key.
To transfer a call	Press <b>HOLD</b> , dial the destination extension, then press <b>PROG</b> .

### Related Programming

- FF1 (System): Least Cost Routing (LCR) Access
- FF2 (Trunks): Pooled Trunk Access for Group “9”
- FF2 (Trunks): Pooled Trunk Access for Group “81-86”
- FF3 (Extension): Forced Least Cost Routing
- FF5 (Keys): FF Key Assignment (all)
- FF8 (LCR) LCR Settings (all)

### Considerations

- A Multi-Line key will ring for incoming CO calls, Intercom Calls, recall calls, and call-forward calls.

- When a CO call or an Intercom Call arrives, a search begins for a Multi-Line key not in use. The lower numbered FF keys will be searched first. When a free Multi-Line key is found, the LED flashes green and the extension rings.
- If another phone answers an incoming trunk call, the ML LED on your extension goes off and the ringing stops, indicating that the Multi-Line key on your telephone is no longer in use.
- When dialing an extension number, the system automatically selects the free Multi-Line key with the lowest number.
- If the CO line or held extension does not respond before the Recall Timer expires, the extension rings and the Multi-Line key flashes green.
- If LCR is enabled, ML keys can be assigned for trunk group 89. However, the FF keys will not light.

---

## ML/MCO Separation

(CPC-AII and CPC-B Version 4.0 or higher)

### *Description*

Beginning with CPC-B Version 4, each extension can have either MCO or ML keys. In previous software versions, MCO or ML keys were only available on a system-wide basis, and the type of key that was available differed according to the software release. Table 4-7 contains definitions of MCO and ML keys. Table 4-8 shows MCO/ML availability with previous releases.

*Table 4-8. MCO/ML availability*

<b>CPC Version</b>	<b>Type of Key</b>
CPC-A	MCO only
CPC-B 1.0	MCO only
CPC-B 2.0 - 3.1	ML only
CPC-AII and CPC-B 4.0 and above	MCO or ML

### *Related Programming*

- FF3 (Extension): ML/MCO Separation
- FF5 (Keys): FF Key Assignments (all)

## **Considerations**

- The initial setting for all extensions (except the first attendant phone) is MCO.
- The initial setting for the first attendant phone (port 1) is ML.

---

# **Meet-Me Answer**

(All Versions)

## **Description**

You can answer a Paging call from any extension using the Meet-Me Answer feature.

## **Operation**

1. When you hear the Paging call pick up the handset from any idle extension or if you are talking with another party, place the call on hold.

The phone issues intercom dial tone.

2. Press “77.”
  - Paging ceases and you are connected to the party trying to reach you.
  - The **EXT** LED lights.

## **Related Programming**

- FF1 (System): Extension Class of Service Setting (CPC-AII and CPC-B Version 4.0 or higher)
- FF3 (Extension): Extension Class of Service Assignment (CPC-AII and CPC-B Version 4.0 or higher)

## **Considerations**

- If you are at a speakerphone, you can press the **ON/OFF** key instead of picking up the handset to answer the Paging Call. After dialing “77” you can then speak to the party trying to reach you using the phone’s built-in speaker and microphone.

---

# Message Waiting/Callback Request

(All Versions)

## *Description*

If you try to call an extension that is busy or does not answer, you can leave a message requesting a return call.

## *Operation*

### **To leave a Callback Request:**

1. Press the **ON/OFF** key.
2. Dial the extension number.  
  
“Call-EXT XXX,” “Busy-EXT XXX” or “Talk-EXT XXX” (where “XXX” is the extension) appears on the display.
3. Dial “2” at the busy tone or while the telephone is still ringing.  
  
“Accept Message” appears on the display.
4. Press the **ON/OFF** key.

The Message Waiting lamp flashes at the called extension.

### **To answer a Callback Request:**

1. Pick up the handset.  
  
The phone issues intercom dial tone.
2. Press the **AUTO** key.
3. Press the **REDIAL** key.
  - Your telephone automatically dials the extension that left the Callback Request.
  - If extension 135 left the Callback Request and If your extension is set for Tone Calling, “Call-EXT XXX” (where “XXX” is the number of the extension that left the Callback Request) appears on the display.



- If extension 135 left the Callback Request and If you extension is set for Voice Calling, “Talk-EXT XXX” (where “XXX” is the number of the extension that left the Callback Request) appears on the display.
- When your call is answered, the **EXT** LED lights and the Message Waiting lamp goes off.

### To view the most recent Callback Request

Callback Requests are normally viewed in the order received. To view the most recent callbacks first:

1. Press the **ON/OFF** key.
  - The phone issues intercom dial tone.
  - The **ON/OFF** LED lights.

2. Press the **CONF** key twice.

The most recent Callback Request appears on the display.

3. Press the **ON/OFF** key.

The **ON/OFF** LED goes off.

4. Repeat steps 2 and 3 to view other Callback Requests.

### To cancel a Callback Request:

1. Press the **ON/OFF** key.
  - The phone issues intercom dial tone.
  - The **ON/OFF** LED lights.

2. Press the **AUTO** key.

3. Press the **FLASH** key.

“Call Back Cancel” appears on the display.

4. Press the **ON/OFF** key.

The **ON/OFF** LED goes off.

## ***Related Programming***

- FF1 (System) Extension Class of Service Setting (CPC-AII and CPC-B Version 3.01 or higher)
- FF3 (Extension) Extension Class of Service Assignment (CPC-AII and CPC-B Version 3.01 or higher)

## ***Considerations***

- When your extension has received several Callback Requests, the number of requests appears on the left side of the display.
- Up to four Callback Requests can be sent to any one extension. The order of the messages can then be changed by the party receiving the requests.
- If you call the same extension a second time and the party answers, a Callback Request sent earlier will be cancelled.
- If a Callback Request is sent to an extension for which Call Forwarding is set, the Callback Request will be automatically forwarded to the designated extension.
- You can send a Callback Request to an extension that has Do Not Disturb or Absence Message activated.

---

# **Non-Appearing Outside Lines**

(All Versions)

## ***Description***

Non-appearing outside lines are trunks that are not assigned to a dedicated FF key or to a trunk group key on your extension. The DBS allows you to use non-appearing outside lines.

## ***Operation***

### **Answering a Non-Appearing Outside Line Call**

To answer a non-appearing outside line call at your extension, lift the receiver or press **ON/OFF**.

### Selecting a Non-Appearing Outside Line

1. Pick up the receiver or press **ON/OFF**.
2. Dial **88**.
3. Dial the outside line number (01-64).
4. Dial the telephone number.

### Holding a Non-Appearing Outside Line

Instead of an FF key, the EXT indicator flashes when you hold a non-appearing outside line.

---

## Offhook Signaling

(All Versions)

### *Description*

Offhook signaling sends a tone to a busy extension to indicate that another CO call has arrived.

### *Operation*

When you receive an offhook signal during a call, do the following:

1. Put the first call on hold.
2. Press the flashing FF key for the CO line of the incoming call.

For details about handling multiple calls, see “Call Hold” on page 4-17.

### *Related Programming*

- FF3 (Extensions): Offhook Signal
- FF3 (Extensions): Offhook Signal Volume
- FF3 (Extensions): Offhook Signal Pattern

## Considerations

- The system does not send the offhook signal under the following conditions:
  - During a conference call
  - While the called extension is on hold
  - During a call on a CO line for which there is no line key on the called extension.

---

# Offhook Voice Announce (OHVA)

(All Versions)

## Description

You can interrupt a busy extension when making an Intercom Call, and then use the Off-Hook Voice Announce (OHVA) feature make an announcement that only the called party can hear. You can also transfer a held call to a busy extension after making the announcement using this feature.

## Operation

### To make an OHVA:

1. Pick up the handset.
2. Dial the desired extension number.

If the extension is busy, your phone issues busy tone.

3. Press “5.”
  - “CONF XXX YYY” (where “XXX” is the calling extension and “YYY” is the receiving extension) appears on the display if you call a busy extension.
  - “CONF XX YYY” (where “XX” is the line number and “YYY” is the extension) appears on the display if you call an extension that is speaking with an outside line.
  - The **EXT** LED flashes.
  - “Voice Announce” appears on the called extension’s display.

- The Talk Back key flashes red.
4. Make your announcement.

**To answer an OHVA:**

1. Press the Talk Back key (\*3 must be programmed in an FF key).  
The Talk Back key flashes red.
2. To return to the previous call, press the Talk Back key again.

**To transfer a call using OHVA**

1. Press the **HOLD** key to place the call to be transferred on hold.
2. Dial the number of the extension to which the call will be transferred.  
If the extension is already engaged in a call, your phone issues busy tone.
3. Press “5” and announce the call to be transferred.

If the transferred call is not accepted by the called extension, press the **FLASH** key to cancel the transfer.

If the transferred call is accepted, and Onhook Transfer is enabled for your extension, hang up. If OnHook Transfer is not enabled, press **PROG** and then hang up.

**Note:** Attendant console phones transfer by pressing the **RELEASE** key.

**To answer a call after it has been announced using OHVA:**

1. Replace the handset.  
Your extension rings.
2. Pick up the handset.

***Related Programming***

- FF1 (System): Extension Class of Service Setting (CPC-AII and CPC-B 3.1 or higher)
- FF3 (Extension): Extension Class of Service Assignment (CPC-AII and CPC-B 3.1 or higher)
- FF3 (Extension): Call Waiting/OHVA

## Considerations

- The held call is transferred as soon as the extension sending the OHVA hangs up.
- If the transferred call is not answered immediately, it will queue for a set time limit, then return to the extension sending the OHVA. (The recall time can be set in the Transfer-Recall Timer.)
- When receiving an OHVA, an extension's Talk Back key's LED will flash red. When the Talk Back key is pressed to answer an OHVA, the LED will flash green.
- You cannot receive a Call Waiting message during an OHVA. ("Denied" will appear on the display of the extension trying to send the Call Waiting message.)

---

# One-Touch Keys

(All Versions)

## Description

One-Touch Keys can be used to store telephone numbers, speed dial numbers, or feature access codes.

To dial the stored number, the user goes offhook and presses the desired key.

## Operation

### To program a One-Touch key for Pooled Access:

1. Press the **ON/OFF** key.
  - The phone issues intercom dial tone.
  - The **ON/OFF** LED lights.
2. Press the **PROG** key.
3. Press the One-Touch key to be programmed.
4. Press the **CONF** key.
5. Enter the number of the outside line group to be stored. (See Table 4-9.)
6. Enter the telephone number to stored.

7. Press the **HOLD** key.

### To assign System Speed Dial numbers to One-Touch keys:

1. Press the **ON/OFF** key.
  - The phone issues intercom dial tone.
  - The **ON/OFF** LED lights.
2. Press the **PROG** key.
3. Press the One-Touch key to be programmed.
4. Press the **AUTO** key.
5. Enter the System Speed Dial Number to be programmed.
6. Press the **HOLD** key.
7. Press the **ON/OFF** key.

The **ON/OFF** LED goes off.

### To chain two to five System Speed Dial numbers to a single One-Touch key:

1. Press the **ON/OFF** key.
  - The phone issues intercom dial tone.
  - The **ON/OFF** LED lights.
2. Press the **PROG** key.
3. Press the One-Touch key to be programmed.
4. Press the **AUTO** key.
5. Enter the System Speed Dial number for the pooled trunk access code.  
[This preprogrammed System Speed Dial must contain a C (**CONF**) followed by 9, 1-6 for pooled trunk access groups 9, 81-86].]
6. If a pause is required, press the **REDIAL** key.

This inserts a pause between the access code and the telephone number. When **REDIAL** is pressed, an “**R**” displays. If viewed later, a “**P**” displays.

7. Press the **AUTO** key.
8. Enter the Speed Dial number for the telephone number.
9. Repeat steps 7 and 8 for any additional Speed Dials to be chained.
10. Press the **HOLD** key.
11. Press the **ON/OFF** key.

The **ON/OFF** LED goes off.

#### **To assign a DBS Feature Code to a One-Touch key:**

1. Press the **ON/OFF** key.
  - The phone issues intercom dial tone.
  - The **ON/OFF** LED lights.
2. Press the **PROG** key.
3. Press the One-Touch key to be programmed.
4. Enter the feature code.
5. Press the **HOLD** key.
6. Press the **ON/OFF** key.

The **ON/OFF** LED goes off.

#### **To assign an Outside Telephone Number to a One-Touch key:**

1. Press the **ON/OFF** key.
  - The phone issues intercom dial tone.
  - The **ON/OFF** LED lights.
2. Press the **PROG** key.
3. Press the One-Touch key to be programmed.
4. Press **CONF** followed by the Pooled Trunk Access code (9, 81-86).
5. If a pause is required, press the **REDIAL** key.

This inserts a pause between the access code and the telephone number.



6. Enter the telephone number.
7. Press the **HOLD** key.
8. Press the **ON/OFF** key.

The **ON/OFF** LED goes off.

#### **To check a programmed One-Touch key:**

1. Press the **ON/OFF** key.
  - The phone issues intercom dial tone.
  - The **ON/OFF** LED lights.
2. Press the **CONF** key.

“C” appears in the display.
3. Press the One Touch key to be checked.

The programmed data appears on the display.
4. Press the **ON/OFF** key.
  - The **ON/OFF** LED goes off.
  - The date and time appears on the display.

#### **Considerations**

- If the pause following an access code is too short, press the **REDIAL** key more than once.
- A One-Touch key can be programmed to automatically access a CO line before dialing a personal speed dial number.
- Select an outside line group when you program a One-Touch key. A free line is selected from that group when you dial out. (Group 9 can be programmed to select LCR automatically.) The following table shows the available outside line groups and their corresponding code numbers:

**Table 4-9. One-touch access codes for trunk group numbers**

Trunk Group Number	Code Number to be entered
81	1
82	2
83	3
84	4
85	5
86	6
9	9

- One-Touch keys cannot be checked while Station Lockout is set.

---

## One-Touch VM Access

(CPC-AII and CPC-B Version 5.0 or higher)

### **Description**

One-Touch VM Access simplifies voice message retrieval for personal mailboxes as well as attendant transfer of incoming calls to extension mailboxes.

For instructions on attendant usage of the VM key, see “One-Touch VM Access” on page 4-78.

One-Touch VM Access allows a user to program an FF key, DSS key, or One-Touch key to automatically dial voice mail. The extension number for voice mail as well as the user’s password can be stored under the key.

If the voice mail key is assigned to an FF key or DSS key, the voice mail key and the MSGE lamp will flash red when the user has a message. (With a One-Touch key, only the MSGE lamp flashes.) To access his or her mailbox, the user simply presses the voice mail key.

If, for security reasons, the user prefers to manually dial the password, the voice mail key can be used to store the voice mail extension number only. With this option, the user presses the VM key, then dials the password before accessing the mailbox.

**Note:** The VM key is assigned differently, depending on whether it is used for personal message retrieval or attendant transfer. See the following “Operation” section for instructions.

## **Operation**

### **To assign a voice mail key:**

**Note:** You cannot program this feature if trunks are assigned to the key. First clear the trunk assignments, then use the following procedures to assign the VM key.

1. Press the **ON/OFF** key.
  - The phone issues intercom dial tone.
  - The **ON/OFF** LED lights.
2. Press the **PROG** key.
3. Press the FF key, DSS key, or One-Touch key.
4. Press the **CONF** key.
5. Press the **AUTO** key.
6. Dial the voice mail pilot number.
7. If the key is for personal message retrieval, enter a password (XXX or AUTO followed by a speed dial number), if desired. If the key is for attendant transfer to voice mail, do not enter a password, but include any special codes (\* or #, for example) if they are required by the voice mail system.

**Note:** If a password is used, it can be from 1 to 3 digits. If the password is over 3 digits long, it must be assigned to a personal or system speed dial number. If you are accessing the Panasonic Voice Mail, it is best to include a # sign at the end of the password.

8. Press the **HOLD** key.

### **To use a Voice Mail key:**

When the VM key flashes, the user presses it to connect to the mailbox.

## **Related Programming**

- FF5 (Keys): FF Key Assignment for Extensions
- FF5 (Keys): FF Key Assignments for DSS Consoles

## Considerations

- The VM key can be used with the Panasonic Voice Mail or with third-party voice mail systems.
- If the voice mail password is over three digits long, assign the password to a personal or system speed dial number (00-99, 000-199 or 900-909). When you use a speed dial number with the Panasonic Voice Mail, include the pound (#) sign after the password. Excluding the # sign results in a 6-second delay before you are connected to the mailbox.

If you are using 2-digit dialing with a third-party voice mail, the password can be up to 4 digits long before it must be stored as a speed dial number. (Panasonic Voice Mail requires 3-digit dialing.)

- With Panasonic Voice Mail, most attendants use port group scheduling that accesses a menu, which asks for a mailbox number. Port group scheduling is used so attendants can quickly dial the mailbox numbers of other users. To assign a personal VM key for an attendant using port group scheduling, use a speed dial number to store the voice mail extension number followed by an asterisk (\*), followed by the password. The asterisk causes Voice Mail to revert to the menu that connects the user to his or her personal mailbox.
- With Panasonic Voice Mail, the final voice mail channel must be assigned as part of the Voice Mail hunt group in order for the VM key to light. If the final voice mail channel is assigned as the transfer extension for the hunt group, the MSGE lamp will light, but the VM key will not.

With third-party voice mail, you must make sure a voice channel is assigned for message waiting control in order for the MSGE lamp and VM key to light.

- The FF Key Copy program (FF9 3# 1-144# 1-144##) should not be used to copy VM keys that include passwords because the passwords as well as the voice mail extension number will be copied. In addition, pressing a key containing someone else's password will result in an "invalid password" message from voice mail.

---

# Onhook Dialing

(All Versions)

## *Description*

Onhook Dialing is a standard feature for DBS key phones. To dial onhook, the user simply presses the **ON/OFF** key.

Users can dial onhook using the dialpad, one-touch keys, or FF keys.

---

# Pooled Trunk Access

(All Versions)

## *Description*

The DBS system supports up to 64 outside lines. These lines can be divided into seven Pooled Trunk groups. If you assign an FF key as an MCO or ML key, the DBS can automatically select an open line from the Pooled Trunk group assigned to that key.

Even if all the outside lines assigned to an extension are busy, you can access a free line by choosing an outside line group number. Group numbers 9 and 81-86 are available.

## *Operation*

### **To select a Pooled Trunk group using a pre-programmed FF key:**

1. Press the **ON/OFF** key.
  - The phone issues intercom dial tone.
  - The **ON/OFF** LED lights.
2. Press the ML or MCO key.
  - The LED of the Pooled Trunk key lights green.
  - The phone issues outside dial tone.
  - “CO TALK #XX” (where “XX” is the line number) appears.

3. Dial the telephone number.  
The number appears on the display.
4. Complete the call and replace the handset.  
The LED of the ML or MCO key goes off.

**To select a Pooled Trunk group that is not assigned to an FF key:**

1. Press the **ON/OFF** key.
  - The phone issues intercom dial tone.
  - The **ON/OFF** LED lights.
2. Enter the desired group number (81-86, 9).
  - The phone issues outside dial tone.
  - “CO TALK #XX” (Where “XX” is the line number) appears on the display.
3. Dial the telephone number.  
The number appears on the display.
4. Complete the call and replace the handset.

### ***Related Programming***

- FF1 (System): Least Cost Routing (LCR) Access
- FF2 (Trunks): Pooled Trunk Access for Group “9”
- FF2 (Trunks): Pooled Trunk Access for Group “9”
- FF3 (Extension): Forced Least Cost Routing
- FF5 (Keys): FF Key Assignment
- FF8 (LCR) LCR Settings (all)

### ***Considerations***

- The LED of the ML or MCO key lights red and the phone issues busy tone when all lines in the same group are busy. (Those lines cannot be accessed.)

- If a ML or MCO key is assigned line group number 9 and LCR has been activated, LCR is selected automatically.
- Press the ML or MCO key that flashes red to answer incoming calls.
- If one group is set aside for data lines, this feature can be used when a line is needed for operations such as data transmission via modem.

---

## Prime Line Preference

(All Versions)

### *Description*

Prime Line Preference allows a user to place an outside call by simply picking up the handset. When the user goes offhook, the trunk or trunk group assigned to FF1 is automatically accessed. (Be sure to program one of the other FF keys as an intercom key.)

### *Operation*

1. Pick up the handset.
  - The phone issues outside dial tone.
  - The LED of the accessed line key lights green.
  - “CO TALK #XX” (where “XX” is the line number) appears on the display.

2. Dial the telephone number.

The number appears on the display.

### *Related Programming*

- FF1 (System): Least Cost Routing (LCR) Access
- FF2 (Trunks): Pooled Trunk Access for Group “9”
- FF2 (Trunks): Pooled Trunk Access for Groups “81-86”
- FF3 (Extension): Forced Least Cost Routing
- FF5 (Keys): FF Key Assignment
- FF3 (Extension): Prime Line Pickup

## **Considerations**

- To make an Intercom Call, press the FF key programmed as an intercom key and then dial the extension number.
- If a member of the trunk group assigned to FF1 is also assigned to a Direct Line key, Prime Line Pickup will access the Direct Line key instead of FF1.
- Prime line preference should not be assigned to an SLT or DSLT telephone.

---

# **Private Line**

(All Versions)

## **Description**

An outside line can be reserved for exclusive access by one extension, eliminating the need for the extension user to wait for a free outside line during busy periods.

## **Operation**

1. Press the CO line key designated as a Private Line.
  - The phone issues outside dial tone.
  - The line LED lights green.
  - “CO TALK #XX” (where “XX” is the line number) appears on the display.
2. Dial the telephone number.

The number appears on the display.
3. Complete the call and replace the handset.

The line LED goes off.



## ***Related Programming***

- FF2 (Trunks): Private Trunk Line
- FF1 (System): Least Cost Routing (LCR) Access
- FF2 (Trunks): Pooled Trunk Access for Group “9”
- FF2 (Trunks): Pooled Trunk Access for Groups “81-86”
- FF3 (Extension): Forced Least Cost Routing
- FF5 (Keys): FF Key Assignment

## ***Considerations***

- Calls to Private Lines cause extensions to ring even if the DND or the Absence Message feature is activated for them.
- Calls to Private Lines are not forwarded, even if Call Forwarding is activated on the associated extensions.
- No warning tone sounds at the Attendant Phone, no matter how long a call on a Private Line is on hold, even if the overtime warning tone is ignored.
- When a private line is assigned to an extension, the Toll Restriction assignment for the private line changes to “0” for all other extensions. Ringing assignments for the private line are also removed from all other extensions.

---

# **Reminder Call**

(All Versions)

## ***Description***

Your telephone can act as an alarm clock with the Reminder Call feature.

## ***Operation***

### **To set the Reminder Call feature:**

1. Press the **ON/OFF** key.
  - The phone issues intercom dial tone.

- The **ON/OFF** LED lights.
2. Press “#4.”  
“Enter Time HHMM” appears on the display.
  3. Enter the time you wish the Reminder Call to sound. Enter the desired time in 12-hour format, followed by a “1” for a.m. or a “2” for p.m.
  4. Press the **ON/OFF** key.
    - The **ON/OFF** LED goes off.
    - “Alarm XX:XX” (where “XX:XX” is the time) appears on the display, along with an a.m./p.m. indicator.

**To cancel the Reminder Call feature:**

1. Press the **ON/OFF** key.
  - The phone issues intercom dial tone.
  - The **ON/OFF** LED lights.
2. Dial “#4.”  
“Enter Time HHMM” appears on the display.
3. Press the **ON/OFF** key.
  - The **ON/OFF** LED goes off.
  - The time disappears from the bottom line of the display.

**Considerations**

- A sixteen-second alarm tone will be issued at the specified time.
- One Reminder Call may be set for each telephone.
- To change the Reminder Call, simply enter a new time.
- If the extension is in use when the reminder call is scheduled, the reminder call is issued as soon as the extension becomes available.

---

# Ringing Line Preference

(All Versions)

## *Description*

Ringing Line Preference enables an extension to answer an incoming CO call, hold recall, or transfer call by simply picking up the handset or pressing **ON/OFF**.

## *Related Programming*

- FF3 (Extensions): Auto Pickup (Ringing Line Pickup)

---

# Saved Number Redial

(All Versions)

## *Description*

You can save a previously dialed number for later redialing. Unlike the Last Number Redial feature, the Saved Number Redial feature allows you to redial the stored number even if it was not the last number dialed.

Saved Number Redial works for outside numbers, but not for extension numbers.

## *Operation*

### **To save a number:**

1. Press the **AUTO** key twice before replacing the handset.
2. Press “\*.”  
“Dial Stored” will appear on the display and the number will be saved.
3. Replace the handset.

### **To redial a saved number:**

1. Press an unlit line key.
  - The phone issues outside dial tone.

- The line LED lights green.
  - “CO TALK #XX” (where “XX” is the line) appears on the display.
2. Press the **AUTO** key.
  3. Press “\*.”  
  
The dialed number appears on the display.
  4. Complete the call and replace the handset.  
  
The line LED changes from green to red and then goes off.

### ***Considerations***

- Any previously saved number is erased when a new number is saved.
- The Saved Number Redial feature can store a number up to sixteen digits long.
- Up to five Speed Dialing codes can be stored and redialed.

---

## **Speed Dialing**

(All Versions)

### **Personal Speed Dialing**

#### ***Description***

Extension users can store frequently called numbers using the Personal Speed Dial feature. Up to 10 Personal Speed Dial numbers can be stored at each extension.

With all versions prior to Version 7.0, the Personal Speed Dial bins are numbered 90 to 99. With CPC-AII and CPC-B Version 7.0 and higher, the Personal Speed Dial bins are numbered 900 to 909.

Users can also enter names of up to sixteen characters for each of the Speed Dial numbers. This allows Personal Speed Dial numbers to be confirmed by name rather than by number.

Extension users can program their own personal speed dial numbers using One-Touch keys, or they can be programmed from a key phone.

## **Operation**

### **To assign Personal Speed Dialing:**

1. Press **ON/OFF**.
2. Press **PROG**.
3. Press a One-Touch key or press **AUTO** followed by the personal speed dial bin number (90-99 or 900-909).
4. If you want to include a trunk access code in the number, press **CONF** then 9 or 1~6. (1-6 = trunk groups 81-86.)

If you enter a trunk access code in the speed dial number, you do not have to open a trunk before using the number.

5. Dial the number.
6. Press **HOLD**.
7. Press **ON/OFF**.

### **To use a programmed Personal Speed Dial key:**

1. If the Speed Dial key includes a trunk access code, simply press the key.

If the Speed Dial key does not include an access code, press an unlit line key before pressing the Speed Dial key.

- The phone issues outside dial tone.
  - The line LED lights green.
  - “CO TALK #XX” (where “XX” is the line number) appears on the display.
2. Complete your call and replace the handset.

The line LED changes from green to red and then goes off.

### **To check a programmed Personal Speed Dial key:**

1. Press the **ON/OFF** key:
  - The phone issues intercom dial tone.
  - The **ON/OFF** LED lights.

2. Press the **CONF** key.  
“C” appears on the display.
3. Press a Personal Speed Dial key.  
The programmed data appears on the display.
4. Press the **ON/OFF** key.  
The **ON/OFF** LED goes off.

**To assign a name to a Personal Speed Dial number:**

1. Press the **ON/OFF** key.
  - The phone issues intercom dial tone.
  - The **ON/OFF** LED lights.
2. Press the **PROG** key.
3. Press “#1.”  
“Speed Dial Name” appears on the display.
4. Press the **AUTO** key.
5. Enter the Personal Speed Dial bin number (90-99 or 900-909).
6. Press **AUTO** to backspace and erase the existing name.
7. Use the dialpad sequences shown in Table 2-1 on page 2-10 to enter letters and/or numbers.
  - Press **FLASH** after each letter.
  - Press **CONF** to switch between numbers and letters.
8. To complete the entry, press **HOLD**.

**To delete a Personal Speed Dial number:**

1. Press **ON/OFF**.
2. Press **PROG**.
3. Press the One-Touch key.
4. Press **HOLD**.

5. Press **ON/OFF** again.

### ***Related Programming***

- FF10 (Speed Dialing): Personal Speed Dial Numbers
- FF3 (Extensions): PSD Name Display (5 or 10 Names)
- FF6 (Name): PSD Names

### ***Considerations***

- Personal Speed Dial numbers can contain up to sixteen characters, including the “\*,” “#,” “-”, **FLASH**, **PAUSE (REDIAL)**, **CONF**, and **AUTO** keys.
- A dash (“-”) can be displayed in the Personal Speed Dialing number. To display a dash, press the **FF6** key where you want the dash to appear. The dash will not appear during programming but will appear when the number is dialed or checked.
- A flash may be entered by pressing the **FLASH** key.
- If you make a mistake while programming, an alarm tone is issued and “ERROR” appears on the display. If this happens, start again from step 1.
- Storing a new number erases any previously stored data.
- Names for Personal Speed Dialing can be programmed using a DSS console at the Attendant Phone.
- If the called party’s number and name are stored in the Personal Speed Dial code, that information appears on the display when you use the speed dial code.
- Speed Dial numbers cannot be checked while Station Lockout is activated.
- With CPC-AII and CPC-B Version 7.0 and higher, if the Speed Dial is used to forward to an outside number and Least Cost Routing is enabled, the Speed Dial cannot use Trunk Access “9.” Use trunk access 81-86 instead.

# System Speed Dial

## *Description*

Frequently called numbers can be stored using the System Speed Dial feature. System Speed Dial numbers are programmed from the Attendant Phone and can be used by any extension. With all versions, up to 90 System Speed Dial Numbers can be stored. Beginning with CPC-AII and CPC-B Version 7.0 and higher, up to 200 System Speed Dial numbers can be stored when the Speed Dial Add-on mode is selected.

For information on assigning System Speed Dials see “Attendant Assignment of Speed Dialing” on page 2-3.

## *Operation*

### **To use a programmed System Speed Dial key:**

1. Press an unlit line key.
  - The phone issues outside dial tone.
  - The line LED lights green.
  - “CO TALK #XX” (where “XX” is the line number) appears on the display.
2. Press the **AUTO** key.

“A” appears on the display.
3. Enter the System Speed Dial code (00-89 or 000-199).

The number and corresponding name appear on the display.
4. Complete your call and replace the handset.

The line LED changes from green to red and then goes off.

### **To check a programmed System Speed Dial key:**

1. Press the **ON/OFF** key.
  - The phone issues intercom dial tone.
  - The **ON/OFF** LED lights.



2. Press the **CONF** key.  
“C” appears in the display.
3. Press **AUTO**.
4. Press a System Speed Dial key.  
The programmed data appears on the display.
5. Press the **ON/OFF** key.
  - The **ON/OFF** LED goes off.
  - The date and time appear on the display.

### ***Related Programming***

- FF1 (System): Speed Dial Mode Setting (CPC-AII and CPC-B Version 7.0 and higher)
- FF1 (System): Override Toll Restriction With SSD Numbers
- FF10 (Speed Dialing): System Speed Dialing

### ***Considerations***

- If numbers do not appear on the display when you use System Speed Dial codes (00-89 or 000-199), your extension is not programmed to display that data.
- The system can be programmed to allow System Speed Dial Numbers to override toll restrictions.
- You can make outside calls using this feature, even if your extension is assigned toll restriction type 2-6.
- Speed Dial code cannot be checked while Station Lockout is activated.
- With CPC-AII and CPC-B Version 7.0 and higher, if the Speed Dial is used to forward to an outside number and Least Cost Routing is enabled, the Speed Dial cannot use Trunk Access “9.” Use trunk access 81-86 instead.

## Speed Dial Linking

### *Description*

You can automatically link together up to five SSD numbers in one Personal Speed Dial Bin to handle telephone numbers longer than 16 characters. Pressing the one Personal Speed Dial Key dials the entire number.

Alternatively, any combination of Personal Speed Dials and System Speed Dials can be manually linked together by pressing the keys in the desired sequence. This can be useful for prepending account codes or long distance carrier access codes, etc.

For more information on programming Speed Dials, see “Speed Dialing” on page 4-88.

### *Operation*

#### **To automatically link multiple System Speed Dials in a Personal Speed Dial Key:**

1. Determine the System Speed Dial bin numbers to be linked. These must be preprogrammed by the telephone system administrator or the attendant.
2. Pick up the receiver or press **ON/OFF**.
3. Press **PROG**.
4. Press the PSD key to be programmed.
5. Press **AUTO**.
6. Dial the SSD bin number. Remember that the trunk access may be selected in the SSD by **CONF (C)** followed by the trunk access number (9, 1-6 for trunk groups 89, 81-86).
7. Repeat steps 5 and 6 up to 4 more times for all additional SSDs to be dialed.
8. Press **HOLD** when finished.

The telephone will display “Stored PSDXXX.”

### To use a Personal Speed Dial Key that links multiple System Speed Dials:

1. If necessary, select the trunk group (9, 81-86). (Normally the trunk is selected by the Speed Dials.
2. Press the Personal Speed Dial key.

### To manually link speed dial keys together:

1. Pick up the receiver or press **ON/OFF**.
2. If necessary, access an outside line.
3. Do one of the following:

If . . .	Then . . .
You are using a PSD number	Press the one-touch key for the first part of the number
You are using a SSD number	Press <b>AUTO</b> . Dial the SSD bin

4. Use the one-touch keys or press **AUTO** and the system speed dial codes to dial the parts of the phone number until it is completed.

### Considerations

- Before linking, you must enter the parts of the telephone number into one-touch keys or system speed dial codes. For example, program the first part into one-touch key #1, the second part into one-touch key #2, etc.
- If the trunk access is to be programmed into a Speed Dial, press **CONF** then enter the trunk access (9, 1-6 for trunks groups 89, 81-86).

---

# Station Lockout

(All Versions)

## *Description*

Use the Station Lockout feature to dial a Station Lockout code that prevents other users from using your phone.

### **To activate Station Lockout:**

1. Press the **ON/OFF** key.
  - The phone issues intercom dial tone.
  - The **ON/OFF** LED lights.
2. Dial “74.”

“Enter Code #” appears on the display.
3. Dial the Station Lockout code.
4. Press the **ON/OFF** key.

“Set Sta. Lock” appears on the display.

### **To deactivate Station Lockout:**

1. Press the **ON/OFF** key.
  - The phone issues intercom dial tone.
  - The **ON/OFF** LED lights.
2. Dial “74.”

“Enter Code #” appears on the display.
3. Dial the Station Lockout code.
4. Press the **ON/OFF** key.

“Set Sta. Lock” disappears from the display.

## ***Related Programming***

- FF3 (Extensions): Extension Lockout Code

## ***Considerations***

- A locked extension can be used for Intercom Calls.
- Station Lockout key codes can only be set from an attendant phone or a key phone.
- You cannot confirm Speed Dialing or set Speed Dialing while Station Lockout is activated.
- If you enter an incorrect key code and then try to dial, the phone will issue a busy tone.
- If station lockout is set, when **ON/OFF** is pressed, stutter dial tone is heard followed by steady dial tone.

---

# **Trunk-to-Trunk Transfer**

(All Versions)

## ***Description***

Trunk-to-trunk transfer allows an extension to transfer one outside party to another outside party.

Before completing the transfer, the extension can hold a three-way conference with the two outside parties.

## ***Operation***

1. Press the **HOLD** key during an outside call.
  - Your current call is put on hold.
  - “Hold #XX” (where “XX” is the line number) appears on the display.
2. Press an unlit CO key.
  - The phone issues outside dial tone.
  - “Talk #XX” (where “XX” is the selected line number) appears on the display.

3. Dial the telephone number of the party you want to connect to your original call.
4. After the call goes through, press the **CONF** key.
  - A three-party Conference Call is initiated.
  - “Conf #XX #YY” (where “XX” is the first line and “YY” the second line) appears on the display.
5. Press one of the CO keys.
  - The two outside lines are connected.
  - “Hold #XX #YY” (where “XX” is the first line and “YY” the second line) appears on the display.

### ***Related Programming***

- FF1 (System): Unsupervised Conference Timer
- FF2 (Trunks): Supervised Trunk Line Conference
- FF3 (Extensions): Unsupervised Conference

### ***Considerations***

- After the Trunk-to-Trunk Transfer is completed, you cannot add another party to create a three-party Conference Call.
- When the call is finished, the conference information disappears from the display and your extension returns to normal operation.
- When the Unsupervised Conference Timer expires, the call is automatically disconnected.

---

## **Voice Mail Transfer Key**

(CPC-A II and CPC-B 6.0 or higher)

### ***Description***

The Voice Mail Transfer (VM/TRF) key allows transfers to voice mailboxes without waiting for voice mail to answer. Figure 4-8 on page 4-99 illustrates how the system handles voice mail transfers.

**Note:** See “One-Touch VM Transfer” on page 2-18 for a similar transfer key. The Voice Mail Transfer Key provides faster operation than the One Touch Voice Mail Transfer Key but may not work with some voice mail systems since you do not wait for the Voice Mail system to answer before pressing the DSS/BLF key. The One-Touch VM Transfer Key works with virtually every voice mail system.

## Operation

1. Answers an incoming call, then press the VM/TRF key.

The system automatically puts the incoming call on hold.

2. Press a DSS/BLF key or dial an extension number.

3. Complete the transfer by going onhook or pressing **RELEASE**, **ON/OFF**, or **PROG**.

**Figure 4-8. Voice mail transfer key operation**

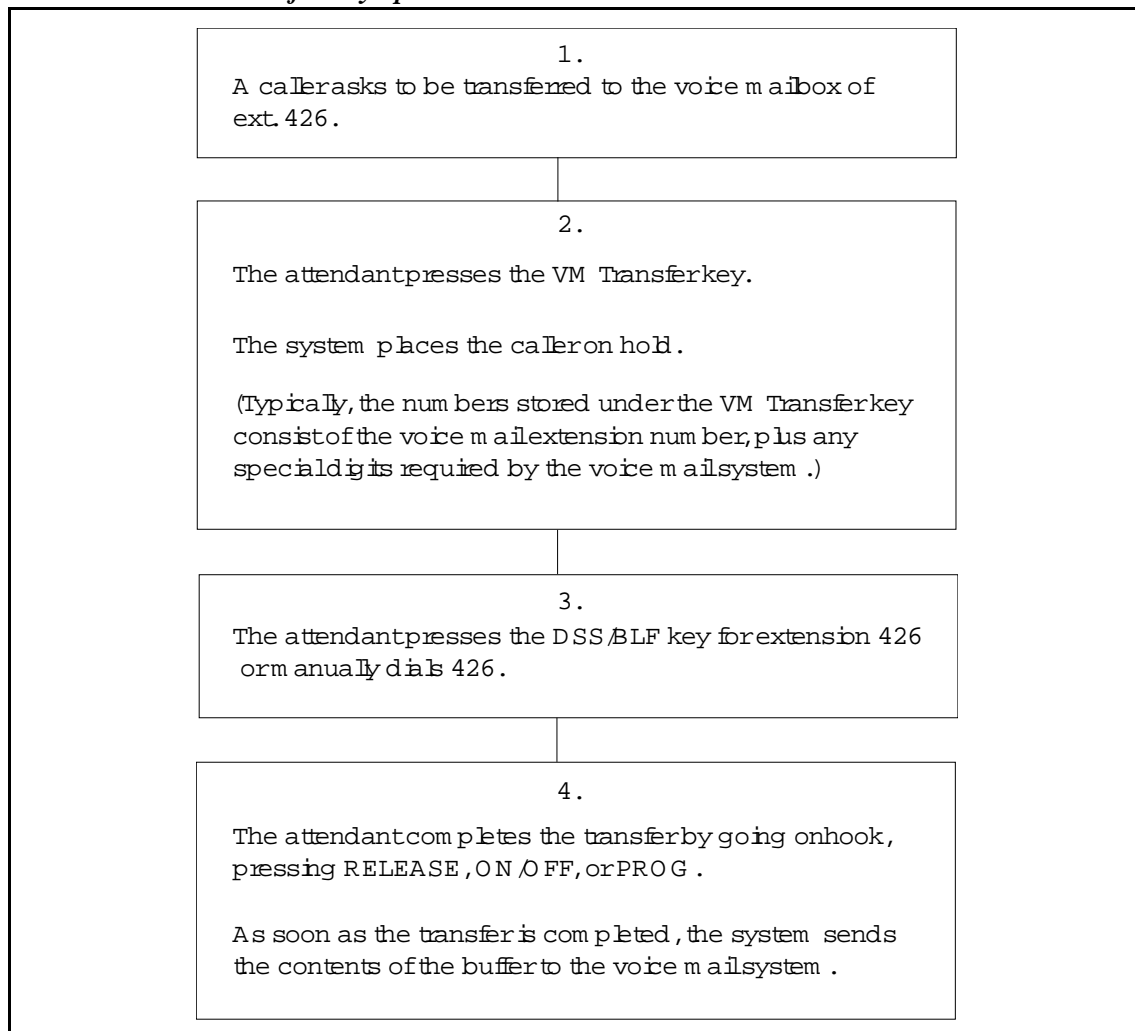

## Programming

The Voice Mail Transfer Key may be assigned from a phone or through system programming.

### To assign a Voice Mail key from a phone:

1. Press the **ON/OFF** key.
  - The phone issues intercom dial tone.
  - The **ON/OFF** LED lights.
2. Press **PROG**.
3. Press the FF key to be assigned as a Voice Mail Transfer Key.
4. Press **CONF AUTO AUTO**.
5. Enter the Voice Mail pilot number.
6. Enter any special codes required by the voice mail system.

**Note:** The length of the Voice Mail pilot number and special codes combined cannot exceed six digits. If the VM number and the special codes require more than six digits, assign the special codes to a personal or system speed dial number and enter **AUTO** followed by the speed dial bin number.

7. Press the **HOLD** key.
8. Press the **ON/OFF** key.
  - The **ON/OFF** LED goes off.

### Related Programming

- FF5 (FF Key Programming): FF Key Assignments

### Considerations

**Key Assignment.** The VM/TRF key can be assigned to any key phone, DSS/72 or EM/24. The VM/TRF key cannot be assigned to a One-Touch key.

**Transfers.** The VM/TRF key can be used to transfer intercom as well as CO calls to a voice mailbox.



**Digit Storage.** Up to six digits can be stored under the VM/TRF key. This total can be comprised of any combination of the voice mail extension number and the special codes. If more than six digits are required, a PSD or SSD number that contains the necessary digits can be stored under the key.

**Key Operations.** The system responds to key operations during the transfer in the following ways:

- Pressing the **FLASH** key cancels the VM/TRF and returns intercom dial tone to the user. When the VM/TRF is cancelled, the incoming call is still connected but is on hold.
- If a valid key (CO key or second DSS key, for example) is pressed, the VM/TRF is cancelled and the operation invoked by the key is performed.
- If an invalid key (**REDIAL**, for example) is pressed, the VM/TRF is cancelled, and the user receives busy tone.

**Number of digits allowed.** Once VM/TRF is pressed, the user can dial up to 10 digits before completing the transfer.

**Holding calls.** If a user begins to perform the voice mail transfer and the extension cannot hold a call (one call is already on non-appearance hold, for example), the system will keep the call in the talk state and will not allow the voice mail transfer to be initiated.

**Non-transmission.** If the VM/TRF key stores a number other than a voice mail extension number, the system does not send DSS/BLF information or the extension number that is dialed after pressing VM/TRF.

**Voice mail data transmission.** The voice mail extension number plus the extension number of the called party's mailbox will be transmitted using a dial code via the API link.



---

# Chapter 5. DSLT Features

This chapter describes features that are available with the Digital Single Line Telephone (DSLST).

This chapter covers the following topics:

<b>Topic</b>	<b>Page</b>
DSLST	5-3
Absence Message	5-4
Auto Redial	5-6
Busy Override	5-6
Call Forwarding	5-7
Call Hold	5-11
Call Park	5-12
Call Pickup	5-14
Call Transfer	5-16
Call Waiting	5-19
Camp-on	5-21
Conference Calls	5-22
Dial "0" for Attendant	5-23
Dial Tone Disable	5-24
Direct Trunk Access	5-24
Do-Not-Disturb (DND)	5-25
Intercom Calling	5-26
Last Number Redial	5-27
Meet-Me Answer	5-28
Message Waiting/Callback Request	5-29
Off-Hook Voice Announce (OHVA)	5-30
Onhook Dialing	5-32
Pooled Trunk Access	5-32
Reminder Call	5-33
Saved Number Redial	5-34
Speed Dialing	5-35
Station Lockout	5-37



# DSLTL

Figure 5-1 illustrates the DSLTL. For more information on DSLTL operation, see the *Digital SLT User's Guide (Section 790)*.

Please refer to “Appendix A: CPC-EX 1.0 Updates” and “Appendix B: CPC-All/B 8.0 Updates” for additional information on VB-44xxx Series Small Display Key Telephone features.

**Note:** The DSLTL can only be used with CPC-AII and CPC-B Version 3.1 or higher.

*Figure 5-1. Digital Single Line Telephone (DSLTL)*

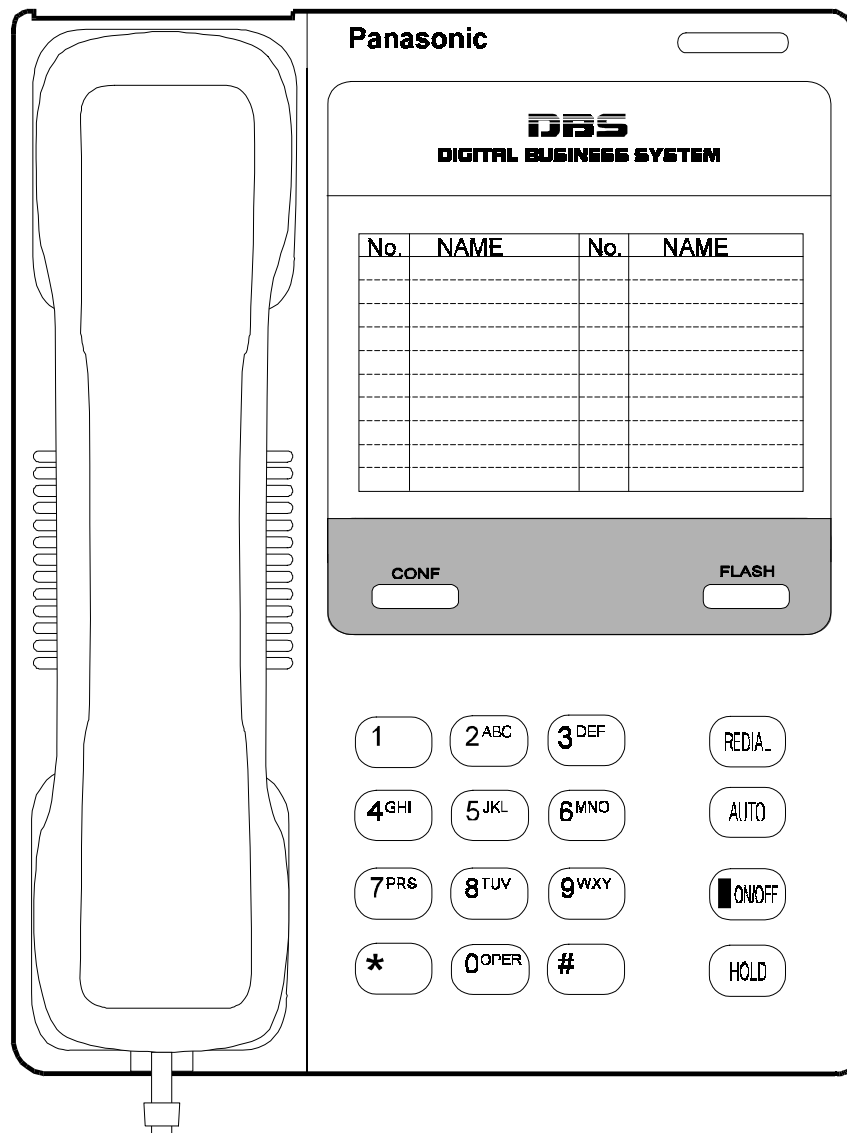

# Absence Message

(All Versions)

## Description

DSLTL users can leave text messages on their phones when they are away.

When the unattended extension is called by a display phone, the text message appears on the caller's phone.

One of the following messages can be selected. Messages 5 to 9 can be changed through system programming.

*Table 5-1. Absence Messages*

Message No.	Message Text
0	In Meeting
1	At Lunch
2	Out of Office
3	Vacation
4	Another Office
5	User Defined
6	User Defined
7	User Defined
8	User Defined
9	User Defined

## Operation

### To Set an Absence Message

1. Lift the handset or press **ON/OFF**.
2. Dial "71."
3. Enter a message code between 0 and 9 (See Table 5-1).
4. Enter the time you will return (optional). See Table 5-2 for examples.
5. Replace the handset or press **ON/OFF**.

### To Cancel an Absence Message

1. Lift the handset or press **ON/OFF**.
2. Dial “71.”
3. Replace the handset or press **ON/OFF**.

### Related Programming

- FF1 (System) Extension Class of Service Setting (CPC-AII and CPC-B Version 3.1 or higher)
- FF3 (Extension) Extension Class of Service Assignment (CPC-AII and CPC-B Version 3.1 or higher)
- FF6 (Names and Messages): Absence Messages

### Considerations

- Extensions without displays get a busy signal, rather than the Absence Message.
- If an extension user selects a message code number 5-9 that has not been set up with a message, “Absence,” followed by the code number, appears on the caller’s display.
- Absence Message return times can be entered as shown in Table 5-2:

*Table 5-2. Example Return Times for Absence Messages*

<b>Input</b>	<b>Display</b>
No input	Return
9	Return 9:00
11	Return 11:00
615	Return 6:15
1035	Return 10:35

Four-digit numbers can also be entered (0000-9999 = Hours & Minutes or Month & Date).

In CPC-A and CPC-B Versions prior to 5.0, DND and Absence Messages cancel Call Forwarding. Beginning with Version 5.0, calls to an extension with DND or Absence Message turned on are treated differently, depending on whether they are trunk or intercom calls. Intercom calls receive busy tone; trunk calls are routed to the extension defined in Permanent Call

Forwarding. In versions prior to 5.0, incoming trunk calls to extensions are routed according to the ringing assignment for the trunk.

The following types of incoming trunk calls follow Permanent Call Forward settings:

- Direct trunk calls (including DID/DNIS)
- Transferred trunk calls.

---

## Auto Redial

(CPC-AII and CPC-B Version 7.0 or higher)

### *Description*

If the Redial key is pressed when the extension is idle or receiving dial tone, the last intercom or outside number is automatically redialed.

### *Related Programming*

- FF3 (System): Auto-Redial on Extensions
- FF1 (System): Extension Class of Service Setting
- FF3 (Extension): Extension Class of Service Assignment

---

## Busy Override

(All Versions)

### *Description*

Extensions in the same Paging Group (1-7) can break into one another's outside or intercom calls to relay information or to create three-party Conference Calls.

### *Operation*

1. Pick up the handset.

The phone issues intercom dial tone.



2. Dial the extension number.
  3. When you hear busy tone, dial “4.”
- Both phones issue an alert tone (system programming required).

### ***Related Programming***

- FF1 (System): Alert Tone for Busy Override and OHVA
- FF1 (System): Extension Class of Service Setting (CPC-AII and CPC-B Version 3.1 or higher)
- FF3 (Extension): Extension Class of Service Assignment (CPC-AII and CPC-B Version 3.1 or higher)
- FF3 (Extension): Busy Override Send
- FF3 (Extension): Busy Override Receive
- FF3 (Extension): Extension Page Group

### ***Considerations***

- You cannot break in on three-party conference calls.
- The default for the override alert tone is “off.” If the override alert tone is enabled, the tone is sent to both parties when a call is overridden.

---

## **Call Forwarding**

(All Versions)

### ***Description***

Call Forwarding allows users to send their calls to another extension, to an outside line, or to voice mail. Some call forwarding enhancements are not available with earlier versions of the DBS. The following table shows the call forwarding features available with each version.

***Table 5-3. DBS Call Forwarding features***

<b>Feature</b>	<b>Availability</b>
Call Forwarding--All Calls	All versions
Call Forwarding--No Answer	CPC-AII and CPC-B Version 2.0 or higher
Call Forwarding--Busy	All versions

Call Forwarding--Busy/No Answer	All versions
Call Forwarding--External	All versions <i>prior</i> to CPC-AII and CPC-B Version 7.0. (Beginning with CPC-AII and CPC-B Version 7.0, all forwarding types (All Calls, No Answer, Busy, Busy/No Answer) allow call forwarding outside -- eliminating the need for Call Forwarding--External.)
Permanent Call Forwarding	CPC-AII and CPC-B Version 3.1 to Version 6.11.

**Call Forwarding--All Calls.** When this feature is activated, all incoming calls to an extension are immediately forwarded.

**Call Forwarding--No Answer.** When this feature is activated, unanswered calls ring until the Call Forward No Answer timer expires. When the timer expires, the unanswered calls are forwarded.

**Call Forwarding--Busy.** When this feature is activated, all incoming calls to a busy extension are forwarded.

**Call Forwarding--Busy/No Answer.** When this feature is activated, all incoming calls to an extension that is busy or does not answer are forwarded.

**Call Forwarding--External.** (*CPC-A and CPC-AII and CPC-B Versions prior to 7.0*). When this feature is activated, all incoming *intercom* calls to an extension are forwarded to an outside number. The outside number must first be entered as a system or personal speed dial number.

Any system speed dial bin or personal speed dial bin can be used to store an outside number for call forwarding.

**Note:** Beginning with CPC-AII and CPC-B Version 7.0, all call types can be forwarded outside. The forwarding is not limited to internal calls but may include incoming outside calls.

**Permanent Call Forwarding.** Permanent call forwarding is assigned through system programming. Permanent call forwarding is usually used to forward calls to a voice mail system.

Extension user can invoke other forms of call forwarding (no answer, busy, all calls) to override the permanent call forwarding destination.

Permanent call forwarding can be used with busy, no answer, or busy/no answer.

## Operation

### To activate Call Forwarding:

1. Lift the handset or press **ON/OFF**.  
The phone issues intercom dial tone.
2. Dial “72.”
3. Dial the appropriate call forwarding code.

Call Forward Type	Code
All	0
Busy/no answer	1
Busy	2
Outside	3
No answer	4

**Note:** Beginning with CPC-AII and CPC-B Version 7.0, all forwarding types (All Calls, No Answer, Busy, Busy/No Answer) allow call forwarding outside eliminating the need for Call Forwarding--External.

4. If you are forwarding to an extension, enter the extension number. If you are forwarding to an outside number, press **AUTO** plus the appropriate speed dial number.

**Note:** Outside numbers used for call forwarding must already be programmed into speed dialing. (See page 5-35 for instructions.)

5. Replace the handset or press **ON/OFF**.

### To cancel Call Forwarding

1. Lift the handset or press **ON/OFF**.
2. Dial “72.”
3. Replace the handset or press **ON/OFF**.

## Related Programming

- FF1 (System): Call Forward No Answer Timer

- FF1 (System): Extension Class of Service Setting (CPC-AII and CPC-B Version 3.1 or higher)
- FF3 (Extension): Extension Class of Service Assignment (CPC-AII and CPC-B Version 3.1 or higher)
- FF3 (Extension): Permanent Call Forward Type (CPC-AII and CPC-B Version 3.1 or higher)
- FF3 (Extension): Permanent Call Forward Extension (CPC-AII and CPC-B Version 3.1 or higher)
- FF10 (Speed Dialing): System Speed Dial Numbers
- FF10 (Speed Dialing): Personal Speed Dial Numbers

### **Considerations**

- Calls can be forwarded to extensions that have call forwarding activated. For example, phone “A” can be forwarded to phone “B,” even if phone “B” is forwarded to voice mail.
- With CPC-B 4.07 and later, extensions receiving forwarded trunk calls display “CFWD NNN XXXXXX,” where “NNN” = the extension that forwarded the call and “XXXXXX” = the trunk name or number.
- In CPC-A and CPC-B Versions prior to 5.0, DND and Absence Messages cancel Call Forwarding.

Beginning with CPC-B Version 5.0, calls to an extension with DND or Absence Message turned on are treated differently, depending on whether they are trunk or intercom calls. Intercom calls receive busy tone; trunk calls are routed to the extension defined in permanent call forwarding.

The following types of incoming trunk calls follow permanent call forward settings:

- Direct trunk calls (including DID/DNIS)
- Transferred trunk calls.
- Voice calls do not forward when Call Forwarding--No Answer is used.
- Extensions for which Call Forwarding-External has been set cannot:
  - Be in the middle of an outside call when the feature is activated.
  - Have a toll restriction setting that prohibits outside calls.

- Calls can be forwarded to a third-party voice mail (a system other than the DBS Voice Mail) by using the “Call Forward ID Code” described on page 3-13.
- Beginning with CPC-AII and CPC-B Version 7.0, all call types can be forwarded outside using speed dials. However, if Least Cost Routing is activated, dial “9” trunks cannot be used. Select another trunk group instead (81-86).

---

## Call Hold

(All Versions)

### *Description*

The **HOLD** key provides either exclusive or system hold, depending on system programming. With Exclusive Hold, only the extension that held the call can retrieve it. With System Hold, another extension can retrieve the call.

### *Operation*

#### **To place a call on Hold:**

Press the **HOLD** key.

#### **To release the call:**

Press the **HOLD** key again.

### *Related Programming*

- FF1 (System): Non-appearing Central Office Line Hold
- FF1 (System): Recall Timer for Extension-Held Intercom Calls
- FF1 (System): Recall Timer for Extension-Held CO Calls
- FF1 (System): Trunk Line Automatic Hold (Key Bank Hold)

### *Considerations*

- A held call will recall if it is not retrieved before the Hold Recall Timer expires.

- If there is no response to the Hold Recall tone, the tone is issued at the Attendant Phone. However, no tone is issued at the Attendant Phone if Night Mode is activated.
- If your system has onhook transfer activated, and you have placed an outside call on hold and then made an Intercom Call, make sure the other extension presses the **FLASH** key or hangs up before you do. If you hang up before the other extension, *the held outside line will be transferred to that extension.*
- An error tone is issued if you attempt to hold more than one call at once.
- The DBS can provide Music-on-Hold to callers placed on hold. See “Music-On-Hold” (page 3-34) for more information.

---

## Call Park

(All Versions)

### *Description*

You can use the Call Park function to transfer a call, even if you cannot locate the intended recipient of the call. Simply park the call and then page the person to whom you want to transfer the call. That person can answer the call from any extension by dialing the number of the extension that parked the call.

### *Operation*

#### **To park a call:**

1. Press the **HOLD** key.
2. Dial “75.”

#### **To retrieve a parked call:**

1. Lift the handset.  
The phone issues intercom dial tone.
2. Dial “76.”
3. Dial the number of the extension that parked the call.

**To retrieve a call parked by the attendant (after receiving the park number from the attendant):**

1. Pick up the handset.

The phone issues intercom dial toned.

2. Dial “76.”

3. Enter the Park Number assigned to the call.

“PARK PICK XX” (where “XX” is the park number) appears, and then “CO TALK #XX” (where “XX” is the trunk number of the call) appears.

***Related Programming***

- FF1 (System): Attendant Park Hold Recall Timer
- FF1 (System): Extension Park Hold Recall Timer

***Considerations***

- An alarm tone is issued if a parked call is not released before the Park Recall Timer expires. If this happens, the user that parked the call can retrieve it by picking up the handset. If no one retrieves the call after the Park Recall Timer expires, a second alarm is issued at the attendant phone(s).
- You cannot park more than one outside line at a time.
- The Call Park Recall Timer is similar to the Recall Timer, except that when the Call Park Recall Timer is set for “0” a call automatically recalls in three minutes.

---

# Call Pickup

(All Versions)

DSLTS can use both directed and group call pickup.

## Direct Call Pickup

### *Description*

A call to an extension can be answered from any other extension with the Direct Call Pickup feature.

### *Operation*

1. Lift the handset.
2. Dial “79.”
3. Enter the number of the ringing extension.

### *Related Programming*

- FF1 (System): Extension Class of Service Setting (CPC-AII and CPC-B 3.1 or higher)
- FF3 (Extension): Extension Class of Service Assignment (CPC-AII and CPC-B Version 3.1 or higher)

### *Considerations*

- If more than one caller is attempting to reach the ringing extension, the Direct Call Pickup feature answers the call that arrives first.

Once the call has been picked up, other extensions that attempt to pick up the call receive busy tone.

- You can answer incoming calls, intercom calls (both tone and voice), call waiting, paging, transferred calls, or recalls using the Direct Call Pickup feature. You cannot answer callbacks with this feature.



# Group Call Pickup

## *Description*

Use the Group Call Pickup feature, to answer calls to other extensions within your Paging Group (01-07) without entering the number of the extension that is ringing.

## *Operation*

1. Lift the handset.
2. Dial “70.”

## *Related Programming*

- FF1 (System): Extension Class of Service Setting (CPC-AII and CPC-B Version 3.1 or higher)
- FF3 (Extension): Extension Class of Service Assignment (CPC-AII and CPC-B Version 3.1 or higher)
- FF3 (Extension): Extension Page Group

## *Considerations*

- If more than one call is arriving at the Paging Group, the Group Call Pickup feature will answer the call to the lowest-numbered port first.
- If the called extension belongs to more than one Paging Group, the Group Call Pickup Feature will answer the call to the lowest-numbered Paging Group first.
- You can answer incoming calls, Intercom Tone Calling, or Intercom Voice Calling using the Group Call Pickup feature. You cannot answer Paging or Callback with this feature.
- Group Call Pickup cannot be used to pick up a ringing phone in Paging Group 00. For example, if an extension is a member of Paging Groups 00 and 06, the extension can use Group Call Pickup to answer ringing calls in Group 06, but not in Group 00.

---

# Call Transfer

(All Versions)

The DBS provides two call transfer methods: blind transfer and screened transfer.

## Blind Transfer

### *Description*

Blind transfer allows the transfer of a call directly to an extension, without waiting for the called extension to answer.

### *Operation*

1. Press the **HOLD** key to place the call on hold.
2. Dial the extension number to which the call is to be transferred.
3. Replace the handset before the other party answers.
  - You can also replace the handset after the third party answers.
  - The third party need only pick up the handset to speak to the outside line.

### *Related Programming*

- FF1 (System): Onhook (Automatic) Transfer
- FF1 (System): Recall Timer for Extension-Transferred CO Calls
- FF1 (System): Recall Timer for Attendant-Transferred CO Calls

### *Considerations*

- For users to transfer calls by pressing **HOLD**, dialing an extension, and going onhook, the Onhook Transfer feature must be enabled.
- You cannot transfer a call to an extension that has Do Not Disturb or Absence Message activated.
- You can transfer a call to an extension that has Call Forwarding activated. The transferred call will follow the call forwarding path of the extension it is transferred to.

For example, if extension “A” is forwarded to extension “B,” calls that are transferred to extension “A” will be forwarded to extension “B.”

- When you transfer a call to an extension that does not answer and does not have Call Forwarding activated, the transfer recalls your extension after the Transfer Recall Timer expires.

## Screened Transfer

### *Description*

Use the Screened Transfer feature to contact a third party and announce the call before transferring it.

#### **To use Screened Transfer when your system is set for Onhook Transfer:**

1. Press the **HOLD** key to place the call on hold.

The phone issues intercom dial tone.

2. Dial the extension number to which the call is to be transferred.
3. When your call is answered, inform the third party of the transfer.
4. Replace the handset.

The third party need only pick up the handset to speak to the outside line.

#### **To use Screened Transfer when Onhook Transfer is disabled:**

1. Press the **HOLD** key to place the outside call on hold.

The phone issues intercom dial tone.

2. Dial the extension number to which the call is to be transferred.
3. When your call is answered, inform the third party of the transfer.

The **EXT** LED stops flashing and remains lit.

4. Dial “8.”

The third party need only pick up the handset to speak to the outside line.

5. Replace the handset.

### ***Related Programming***

- FF1 (System): Onhook (Automatic) Transfer
- FF1 (System): Recall Timer for Extension -Transferred CO Calls
- FF1 (System): Recall Timer for Extension -Transferred CO Calls

### ***Considerations***

- You cannot transfer a call to an extension that has Do Not Disturb or Absence Message activated.
- You can transfer a call to an extension that has Call Forwarding activated. The transferred call will follow the call forwarding path of the extension it is transferred to.

For example, if phone “A” is covered to phone “B,” calls that are transferred to phone “A” will be forwarded to phone “B.”

- When you transfer a call to an extension that does not answer and does not have Call Forwarding activated, the transfer recalls to your extension after the Transfer Recall Timer expires.

# Call Waiting

(All Versions)

## Description

You can send a Call Waiting signal, followed by a brief LCD message, to a busy extension. The party receiving the message need only replace the handset and then pick it up again to be automatically connected to your extension.

The following messages can be sent using the Call Waiting feature:

*Table 5-4. Call Waiting Text Messages*

Message Code	Message
5	“Visitor Here”
6	“Need Help”
7	“Important”
9	“Emergency”

Message codes 0-4 cannot be used.

## Operation

### To Set Call Waiting:

1. Lift the handset.
2. Dial the extension number.
3. Upon hearing busy tone, press “3.”
4. If you wish to send a text message, dial the desired message code (5-7 or 9).

The message appears on the called party’s phone if the called party has a display phone. (If the extension does not have a display, it will continue to issue a call waiting tone.)

5. Remain on the line until the called party picks up.

### To answer Call Waiting (after disconnecting the current call):

1. Replace the handset.

The current call is disconnected.

2. Pick up the handset.

You are automatically connected to the extension sending the Call Waiting.

**To answer Call Waiting (without disconnecting the current call):**

1. Press **HOLD**.
  - The current call is disconnected.
  - The new call is connected automatically.
2. Press **HOLD** again to retrieve the first call.

***Related Programming***

- FF1 (System) Extension Class of Service Setting (CPC-AII and CPC-B Version 3.1 or higher)
- FF3 (Extension): Extension Class of Service Assignment (CPC-AII and CPC-B Version 3.1 or higher)
- FF3 (Extension): Call Waiting/OHVA

***Considerations***

- Call Waiting can be used without entering a message code.
- An extension that has DND activated, has a call on hold, is ringing (from another call), or is engaged in a conference call cannot receive Call Waiting messages.
- An extension that has call forwarding activated cannot receive call waiting messages unless it has an available ML key.

---

# Camp-on

(All Versions)

## ***Description***

If you reach a busy extension, you can use the Camp-on feature to alert you with a ring when the extension becomes free. You can then pick up your handset to automatically dial the extension.

## ***Operation***

### **To activate the Camp-on feature:**

1. Lift the handset.
2. Dial the desired extension number.
3. Upon hearing busy tone, press “3.”
  - The phone issues a ringback tone.
  - If the Camp-on feature is not available, the phone continues to issue busy tone.
4. Replace the handset after you hear the ringback tone.

### **To answer the callback ring:**

Pick up the handset when you hear the callback ring.

The system automatically dials the called extension.

## ***Related Programming***

- FF3 (Extension): Call Waiting/OHVA

## ***Considerations***

- The callback ring must be answered within sixteen seconds or it will be canceled.
- A Camp-on request will only be accepted *after* Call Waiting status.
- Camp-on is not allowed to an extension that has call forwarding activated.

- An extension can only have one call camped on at a time. For example, if Extension 152 camps on to Extension 153, another extension cannot camp on to 153, as long as 152 is camped on.
- An extension that has initiated a camp-on cannot receive a camp-on. For instance, if Extension 200 has camped on to Extension 300, another extension cannot camp on to 200.
- For CPC-B 5.03 and above, callbacks are not forwarded. For example, if Extension 200 is call forwarded to Extension 300, Extension 200 can register a callback request to Extension 400. When the callback request is returned, it will ring Extension 200 and will not follow call forwarding.

---

## Conference Calls

(All Versions)

### *Description*

Conference Calls allow an extension user to add a party to an existing conversation.

DSLTL users can create the following types of Conference Calls:

- One outside line and two extensions (three-party Conference Call)
- Two outside lines and one extension (three-party Conference Call)
- Three extensions (Intercom Conference Call)

### *Operation*

#### **To add an extension:**

1. Press the **HOLD** key to place the current call on hold.
2. Dial the number of the extension you wish to add to the call.
3. Press **CONF** when your call is answered.

#### **To add an outside number:**

1. Press the **HOLD** key to place the current call on hold.
2. Call the outside number.



3. Press **CONF** when your call is answered.

### **Considerations**

- Press the **FLASH** key to exit a Conference Call.
- The Hold feature cannot be used during a three-party conference.

---

## **Dial “0” for Attendant**

(All Versions)

### **Description**

The Attendant can be called from any extension by pressing “0.”

If multiple attendants are assigned, dial “0” calls goes to Attendant “1” first. If attendant “1” is busy, the call then goes to Attendant “2.” The call continues to transfer to the next attendant in the attendant group, if necessary.

A maximum of four attendants can be assigned.

### **Operation**

1. Lift the handset.
2. Press “0.”

### **Related Programming**

- FF1 (System): Second Attendant Position
- FF1 (System): Third Attendant Position
- FF1 (System): Fourth Attendant Position
- FF1 (System): Attendant Transfer Extension

---

# Dial Tone Disable

(All Versions)

## *Description*

The intercom dial tone can be turned off at a phone. Dial tone is turned off when a headset is used.

## *Operation*

### **To disable the intercom dial tone:**

1. Press the **ON/OFF** key.
  - The phone issues intercom dial tone.
2. Press “#50.”
3. Press the **ON/OFF** key.

### **To reactivate dial tone:**

Repeat the preceding steps.

---

# Direct Trunk Access

(All Versions)

## *Description*

Extension users can access specific trunks for outgoing calls. Extension users can also use Direct Trunk Access to test trunks or to access data trunks.

## *Operation*

1. Lift the handset.
2. Dial “88” followed by the desired trunk number (01-64).
3. Dial the outside number.

---

# Do-Not-Disturb (DND)

(All Versions)

## *Description*

An extension can be made unavailable by activating Do-Not-Disturb (DND). Calls to extensions with DND activated receive busy tone.

## *Operation*

### **To activate DND:**

1. Lift the handset or press **ON/OFF**.
2. Dial “73.”
3. Replace the handset or press the **ON/OFF** key.

### **To cancel DND:**

1. Lift the handset or press **ON/OFF**.
2. Dial “73.”
3. Replace the handset or press **ON/OFF**.

## *Related Programming*

- FF1 (System): Extension Class of Service Setting (CPC-AII and CPC-B Version 4.0 or higher)
- FF3 (Extension): Extension Class of Service Assignment (CPC-AII and CPC-B Version 4.0 or higher)

## *Considerations*

- Callback Queuing can ring an extension in DND.
- In CPC-A and CPC-B Versions prior to 5.0, DND and Absence Messages cancel Call Forwarding.

Beginning with Version 5.0, calls to an extension with DND or Absence Message turned on are treated differently, depending on whether they are trunk or intercom calls. Intercom calls receive busy tone; trunk calls are

routed to the extension defined in permanent call forwarding.

The following types of incoming trunk calls will follow permanent call forward settings:

- Direct trunk calls (including DID/DNIS)
- Transferred trunk calls.
- The DND feature cannot be activated at an extension selected to receive Call Forwarding.

---

## Intercom Calling

(All Versions)

### *Descriptions*

The DBS provides two methods of intercom calling: voice calling and tone calling.

**Voice Calling.** With voice calling, intercom calls are connected immediately, without a ringing tone.

**Tone Calling.** With tone calls, a ringing tone is sent to the called extension.

System programming determines whether the DBS uses voice or tone calling as a default. If voice calling is the default, dialing a “1” after the extension number will change the call to a tone call. If tone calling is the default, dialing a “1” will result in a voice call.

### *Operation*

#### **To make a Voice Call:**

1. Lift the handset.
2. Dial the extension number.
3. If the system default is tone calling, dial a “1.”

#### **To make an Tone Call:**

1. Lift the handset.
2. Dial the extension number.

3. If the system default is voice calling, dial a “1.”

The called extension rings.

### ***Related Programming***

- FF1 (System): Extension Intercom Calling
- FF1 (System): Alert Tone for Voice Calls
- FF1 (System): Extension Class of Service Setting (CPC-AII and CPC-B Version 4.0 or higher)
- FF3 (Extension): Extension Class of Service Assignment (CPC-AII and CPC-B Version 4.0 or higher)

### ***Considerations***

- When an extension’s calling mode is set to voice calls, a “splash” tone can be sent to alert the extension to the voice call. System programming determines if the splash tone is provided.
- If an extension is onhook, it will receive tone calls.
- The voice calling feature is not available for DISA incoming calls.
- Voice calls do not forward if Cover No Answer is turned on.

---

## **Last Number Redial**

(All Versions)

### ***Description***

The last outside number dialed may be redialed automatically by pressing the **REDIAL** key.

### ***Operation***

1. Lift the handset.
2. Dial a trunk access code (81-86 or 9).
3. Press the **REDIAL** key.

## **Considerations**

- If the Auto Flash Redial feature is set, you can flash the outside line once by pressing the **REDIAL** key at the busy tone. The last number dialed can then be redialed.
- The Last Number Redial feature can redial a number up to sixteen digits long.
- A maximum of five Speed Dialing codes can be redialed.

---

# **Meet-Me Answer**

(All Versions)

## **Description**

You can answer a Paging call from any extension using the Meet-Me Answer feature.

## **Operation**

1. Pick up the handset from any idle extension at which you hear a Paging call or if you are talking with another party, place the party on hold when you hear the paging call.
2. Press “77.”

Paging ceases and you are connected to the paging party.

## **Related Programming**

- FF1 (System): Extension Class of Service Setting (CPC-AII and CPC-B Version 4.0 or higher)
- FF3 (Extension): Extension Class of Service Assignment (CPC-AII and CPC-B Version 4.0 or higher)

---

# Message Waiting/Callback Request

(All Versions)

## ***Description***

If you call an extension that is busy or does not answer, you can leave a message requesting a return call.

## ***Operation***

### **To leave a Message Waiting/Callback Request:**

1. Lift the handset.
2. Dial the extension number.
3. Dial “2” at the busy tone or while the telephone is still ringing.
4. Replace the handset.

### **To answer a Message Waiting/Callback Request:**

1. Pick up the handset.

The phone issues intercom dial tone.

2. Press the **AUTO** key.
3. Press the **REDIAL** key.

Your telephone automatically dials the extension that left the Callback Request.

### **To cancel a Callback Request:**

1. Lift the handset or press **ON/OFF**.
2. Press the **AUTO** key.
3. Press the **FLASH** key.
4. Replace the handset or press the **ON/OFF** key.

## ***Related Programming***

- FF1 (System): Extension Class of Service Setting (CPC-AII and CPC-B Version 3.01 or higher)
- FF3 (Extension): Extension Class of Service Setting (CPC-AII and CPC-B Version 3.01 or higher)

## ***Considerations***

- Up to four Message Waiting/Callback Requests can be sent to one extension.
- If you call an extension a second time and the party answers, a Message Waiting/Callback Request you sent earlier will be cancelled.
- If a Message Waiting/Callback Request is sent to an extension that has Call Forwarding enabled, the Callback Request is automatically forwarded to the designated extension.
- You can send a Message Waiting/Callback Request to an extension that has Do Not Disturb or Absence Message activated.
- Beginning with CPC-A 3.28, CPC-B 4.07, and CPC-A II 6.0, making a blind transfer to an extension to which you have previously sent a callback request does not cancel your callback request. Earlier CPC versions cancelled your callback request if you transferred a call to the same extension.

---

# **Off-Hook Voice Announce (OHVA)**

(All Versions)

## ***Description***

You can use the Off-Hook Voice Announce (OHVA) feature to interrupt a busy extension and then make an announcement that only the called party can hear. You can also transfer a held call to a busy extension after making the announcement using this feature.

## ***Operation***

### **To make an OHVA:**

1. Lift the handset.



2. Dial the desired extension number.
3. Upon hearing busy tone, press “5.”

### **To transfer a call using OHVA**

1. Press the **HOLD** key.
2. Dial the number of the extension to which the call will be transferred.  
Your phone issues a busy tone if the extension is already on a call.

3. Press “5” and announce the call to be transferred.

If the transferred call is not accepted by the called extension, press the **FLASH** key to cancel the transfer.

4. Press “8.”
5. Replace the handset.

### **To answer the call from a DSLT:**

1. Press **CONF** to speak with the announcing party.
2. Press **CONF** again to disconnect the announcing party and return to the original call.

## ***Related Programming***

- FF1 (System): Onhook (Automatic) Transfer
- FF1 (System): Alert Tone for Busy Override & OHVA
- FF1 (System): Extension Class of Service Setting (CPC-AII and CPC-B 3.1 or higher)
- FF3 (Extension): Extension Class of Service Assignment (CPC-AII and CPC-B 3.1 or higher)
- FF3 (Extension): Call Waiting/OHVA

## ***Considerations***

- If Onhook Transfer is enabled, the held call is transferred as soon as the extension sending the OHVA hangs up.

- If the transferred call is not answered immediately, it will queue for a specified time and then return to the extension sending the OHVA. (The recall time is set in the Transfer-Recall Timer.)
- You cannot receive a Call Waiting message during an OHVA.
- You cannot toggle back and forth between two calls during an OHVA.

---

## Onhook Dialing

(All Versions)

### *Description*

To use onhook dialing, press the **ON/OFF** key.

The DSLT does not have a microphone, so the user must lift the handset to talk.

---

## Pooled Trunk Access

(All Versions)

### *Description*

The DBS system is designed to accept from 8 to 64 outside lines. These lines can be divided into seven Pooled Trunk groups. The groups are numbered 9 and 81-86.

To select a free outside line, choose a pooled trunk group number. The DBS automatically selects a free line from the group.

### *Operation*

1. Lift the handset.

The phone issues an intercom dial tone.

2. Dial the desired trunk group number (81-86 or 9).
3. Dial the outside number.

### *Related Programming*

- FF1 (System): Least Cost Routing (LCR) Access

- FF2 (Trunks): Pooled Trunk Access for Group “9”
- FF2 (Trunks): Pooled Trunk Access for Groups “81-86”
- FF3 (Extension): Forced Least Cost Routing
- FF8 (LCR): LCR Settings (all)

### ***Considerations***

- There are seven groups of outside lines: 9 and 81-86. Some additional outside lines may not be assigned to a group.
- Dialing “9” activates LCR if the LCR option is enabled.

---

## **Reminder Call**

(All Versions)

### ***Description***

With the Reminder Call feature, your telephone can act as an alarm clock.

### ***Operation***

#### **To Set the Reminder Call feature:**

1. Lift the handset or press **ON/OFF**.  
The phone issues intercom dial tone.
2. Press “#4.”
3. Enter the time you wish the Reminder Call to be issued. Enter the desired time in 12-hour format, followed by a “1” for a.m. or a “2” for p.m.
4. Replace the handset or press the **ON/OFF** key.

#### **To Cancel the Reminder Call feature:**

1. Lift the handset or press **ON/OFF**.  
The phone issues intercom dial tone.
2. Dial “#4.”

3. Replace the handset or press **ON/OFF**.

### **Considerations**

- A sixteen-second alarm tone will be issued at the specified time.
- One Reminder Call may be set for each telephone.
- To change the Reminder Call, enter a new time.
- If the extension is in use when the reminder call is scheduled, the reminder call is sent as soon as the extension becomes available.

---

## **Saved Number Redial**

(All Versions)

### **Description**

You can save a previously dialed number for later redialing. Unlike the Last Number Redial feature, the Saved Number Redial feature allows you redial the stored number, even if it is not the last number dialed.

Saved Number Redial can only be used for outside numbers,.

### **Operation**

#### **To save a number:**

1. Press the **AUTO** key twice.
2. Press “\*.”
3. Replace the handset.

#### **To redial a saved number:**

1. Lift the handset.
2. Dial a trunk access code (81-86 or 9).
3. Press the **AUTO** key.
4. Press “\*.”

## **Considerations**

- Any previously saved number is erased when a new number is saved.
- The Saved Number Redial feature can redial a number up to sixteen digits long.
- A maximum of five chained Speed Dialing codes can be stored.

---

# **Speed Dialing**

(All Versions)

## **Personal Speed Dialing**

### ***Description***

Extension users can store frequently called numbers using the Personal Speed Dial feature. Up to 10 Personal Speed Dial numbers can be stored at each extension.

With all versions prior to Version 7.0, the Personal Speed Dial bins are numbered 90 to 99. With CPC-AII/CPC-B Version 7.0 and higher, the Personal Speed Dial bins are numbered 900 to 909.

Extension users can program their own personal speed dial numbers, or they can be programmed from a key phone.

### ***Operation***

#### **To assign Personal Speed Dial Numbers:**

1. Lift the handset or press **ON/OFF**.
2. Press **\***.
3. Dial "80."
4. Dial a personal speed dial bin number (90-99 or 900-909).
5. Dial the number you want to store.
  - To include a trunk access code in the number, press **CONF** then dial 9 or 1-6. (1-6 = trunk groups 81-86.)

- To include a pause, press **REDIAL**.
  - To include a flash, press **FLASH**.
6. Press **HOLD**.
  7. Replace the handset or press **ON/OFF**.

**To delete a Personal Speed Dial number:**

1. Lift the handset or press **ON/OFF**.
2. Press **\***.
3. Dial “80.”
4. Dial the personal speed dial number (90-99 or 900-909).
5. Press **HOLD**.
6. Replace the handset or press **ON/OFF**.
7. To dial a Personal Speed Dial number:

**To dial a Personal Speed Dial number:**

1. Lift the handset or press **ON/OFF**.
2. If necessary, select an outside line.
3. Press **AUTO**.
4. Dial the personal speed dial number (90-99 or 900-909).

***Related Programming***

- FF7 (Toll Restrictions): Toll Restrictions (all)
- FF10 (Speed Dialing): Personal Speed Dial Numbers

***Considerations***

- Personal speed dial numbers for DSLTs can also be entered from an attendant phone.
- Personal Speed Dial numbers can contain up to sixteen digits.
- Storing a new number erases any previously stored data.

- Speed Dialing cannot be checked while Station Lockout is enabled.
- If the Speed Dial is used to forward to an outside number and Least Cost Routing is enabled, the Speed Dial cannot use Trunk Group “9.”

## System Speed Dial

### *Description*

Frequently called numbers can be stored using the System Speed Dial feature. Up to 90 System Speed Dial numbers can be programmed at the Attendant Phone and used by any extension. With CPC-AII/CPC-B Version 7.0 and higher, up to 200 System Speed Dial numbers can be programmed at the Attendant Phone and used by any extension.

### *Operation*

#### **To dial a system speed dial number:**

1. Pick up the handset.
2. If necessary, access an outside line.
3. Press **AUTO**.
4. Dial the system speed dial code (00-89 or 000-199).

### *Related Programming*

- FF1 (System): Override Toll Restriction with SSD Numbers
- FF10 (Speed Dialing): System Speed Dialing

---

## Station Lockout

(All Versions)

### *Description*

Use the Station Lockout feature to dial a Station Lockout code that prevents other users from using your phone.

**To activate Station Lockout:**

1. Press the **ON/OFF** key.
  - The phone issues intercom dial tone.
2. Dial “74.”
3. Dial the Station Lockout code.
4. Press the **ON/OFF** key.

**To deactivate Station Lockout:**

1. Press the **ON/OFF** key.
  - The phone issues intercom dial tone.
2. Dial “74.”
3. Dial the Station Lockout code.
4. Press the **ON/OFF** key.

***Related Programming***

- FF3 (Extensions): Extension Lockout Code

***Considerations***

- A locked extension can be used for Intercom Calls.
- Station Lockout key codes can only be set from an attendant phone or a key phone.
- You cannot confirm Speed Dialing or set Speed Dialing while Station Lockout is activated.
- If you enter an incorrect key code and then try to dial, the phone will issue a busy tone.

If station lockout is set, when **ON/OFF** is pressed, stutter dial tone is heard followed by steady dial tone.



---

# Chapter 6. SLT Features

This chapter describes features that are available with single-line telephones (SLTs).

Single-line telephones are industry-standard 2500 sets. SLTs are not equipped with feature keys or line keys, so basic telephone operations are performed by pressing dialpad keys and/or using the switchhook.

This chapter covers the following topics:

<b>Topic</b>	<b>Page</b>
Absence Message	6-3
Busy Override	6-5
Call Forwarding	6-6
Call Hold	6-10
Call Park	6-11
Call Pickup	6-12
Call Transfer	6-14
Call Waiting	6-17
Camp-on	6-19
Conference Calls	6-20
Dial "0" for Attendant	6-21
Dial Tone Disable	6-22
Direct Trunk Access	6-23
Do-Not-Disturb (DND)	6-23
Intercom Calling	6-25
Last Number Redial	6-26
Meet-Me Answer	6-27
Message Waiting/Callback Request	6-28
Off-Hook Voice Announce (OHVA)	6-29
Pooled Trunk Access	6-30
Speed Dialing	6-31
Station Lockout	6-33



# Absence Message

(All Versions)

## Description

SLT users can leave text messages on their phones when they are away.

When the unattended extension is dialed by a key phone, the text message appears on the caller's phone.

One of the following messages can be selected. Messages 5 to 9 can be changed through system programming.

*Table 6-1. Absence Messages*

Message No.	Message Text
0	In Meeting
1	At Lunch
2	Out of Office
3	Vacation
4	Another Office
5	User Defined
6	User Defined
7	User Defined
8	User Defined
9	User Defined

## Operation

### To Set an Absence Message

1. Lift the handset.
2. Dial "71."
3. Enter a message code between 0 and 9 (See Table 6-1).
4. Enter the time you will return (optional). See Table 6-2 for examples.
5. Replace the handset.

## To Cancel an Absence Message

1. Lift the handset.
2. Dial “71.”
3. Replace the handset.

## Related Programming

- FF1 (System): Extension Class of Service Setting (CPC-AII and CPC-B Version 3.1 or higher)
- FF3 (Extension): Extension Class of Service Assignment (CPC-AII and CPC-B Version 3.1 or higher)
- FF6 (Names and Messages): Absence Messages

## Considerations

- Extensions without displays get a busy signal, rather than the Absence Message.
- If a message code number that has not been assigned a text message is selected, “Absence,” followed by the code number, appears on the caller’s display.
- Absence Message return times can be entered as shown in Table 6-2:

**Table 6-2. Example Return Times for Absence Messages**

<b>Input</b>	<b>Display</b>
No input	Return
9	Return 9:00
11	Return 11:00
615	Return 6:15
1035	Return 10:35

Four-digit numbers can also be entered (0000-9999 = Hours & Minutes or Month & Date).

- In CPC-A and CPC-B Versions prior to 5.0, DND and Absence Messages cancel Call Forwarding.

Beginning with CPC-B Version 5.0, calls to extensions with DND or Absence Message turned on are treated differently, depending on whether they are trunk or intercom calls. Intercom calls receive busy tone; trunk

calls are routed to the extension defined in permanent call forwarding.

The following types of incoming trunk calls follow permanent call forward settings:

- Direct trunk calls (including DID/DNIS)
- Transferred trunk calls.
- When an Absence Message is set on a DID extension, incoming DID calls are routed according to the ringing assignment programmed for the incoming trunk.

---

## Busy Override

(All Versions)

### *Description*

Extensions in the same Paging Group (1-7) can break into one another's outside calls or intercom calls to relay information or to create three-party Conference Calls.

### *Operation*

Press "4" when you hear the busy tone.

An alert tone is issued at both phones.

### *Related Programming*

- FF1 (System): Alert Tone for Busy Override & OHVA
- FF1 (System): Extension Class of Service Setting (CPC-AII and CPC-B Version 3.1 or higher)
- FF3 (Extension): Extension Class of Service Assignment (CPC-AII and CPC-B Version 3.1 or higher)
- FF3 (Extension): Busy Override Send
- FF3 (Extension): Busy Override Receive
- FF3 (Extension): Extension Page Group

## Considerations

- You cannot break in on three-party conference calls.
- The default for the override alert tone is “off.” If the override alert tone is enabled, the tone will be sent to both parties when a call is overridden.

# Call Forwarding

(All Versions)

Call Forwarding allows users to send their calls to another extension, to an outside line, or to voice mail. All versions of the DBS provide call forwarding; however, some call forwarding enhancements are not available with earlier versions. The following table shows the call forwarding features available with each release.

*Table 6-3. DBS Call Forwarding features*

Feature	Availability
Call Forwarding--All Calls	All versions
Call Forwarding--No Answer	CPC-AII and CPC-B Version 2.0 or higher
Call Forwarding--Busy	All versions
Call Forwarding--Busy/No Answer	All versions
Call Forwarding--External	CPC-A, CPC-AII prior to 7.0 and CPC-B prior to 7.0. Beginning with CPC-AII and CPC-B Version 7.0, all forwarding types (All Calls, No Answer, Busy, Busy/No Answer) allow call forwarding outside -- eliminating the need for Call Forwarding--External.
Permanent Call Forwarding	CPC-AII and CPC-B Version 3.1 or higher

**Call Forwarding--All Calls.** When this feature is activated, all incoming calls to an extension are forwarded immediately.

**Call Forwarding--No Answer.** When this feature is activated, an unanswered call rings until the Call Forward No Answer timer expires. When the timer expires, the unanswered call is forwarded.

**Call Forwarding--Busy.** When this feature is activated, all incoming calls to a busy extension are forwarded to a designated extension.

**Call Forwarding--Busy/No Answer.** When this feature is activated, all incoming calls to an extension that is off-hook or does not answer are forwarded to a designated extension. Similarly, if the extension is busy, the calls are forwarded to the designated extension.

**Call Forwarding--External.** (*CPC-A, CPC-AII Versions prior to 7.0 and CPC-B Versions prior to 7.0.*) When this feature is activated, all incoming *intercom* calls to an extension are forwarded to an outside number. The outside number must be entered as a system or personal speed dial number.

Any system speed dial number or personal speed dial number can be used to store an outside number for call forwarding.

**Note:** Beginning with CPC-AII and CPC-B Version 7.0, all call forwarding types (All Calls, Busy/No Answer, Busy, and No Answer) can be forwarded outside eliminating the need for Call Forwarding--External. The forwarding is not limited to internal calls but may include incoming outside calls.

**Permanent Call Forwarding.** Permanent call forwarding is assigned through system programming. Permanent call forwarding is usually used to forward calls to a voice mail system.

Extension users can invoke other forms of call forwarding (no answer, busy, all calls) to override the permanent call forwarding destination.

Permanent call forwarding can be used with busy, no answer, or busy/no answer.

## Operation

### To activate Call Forwarding:

1. Lift the handset.  
The phone issues intercom dial tone.
2. Dial "72."
3. Dial the appropriate call forwarding code.

Call Forward Type	Code
All	0
Busy/no answer	1
Busy	2

Outside	3
No answer	4

**Note:** Beginning with CPC-AII and CPC-B Version 7.0, all forwarding types (All Calls, No Answer, Busy, Busy/No Answer) allow call forwarding outside eliminating the need for Call Forwarding--External.

- If you are forwarding to an extension, enter the number of the extension you want to receive your calls. If you're forwarding to an outside number, dial "\*" plus the appropriate speed dial number.

**Note:** To forward to an outside number, you must have already programmed the number into personal or system speed dialing. With CPC-A or CPC-B Versions prior to 2.0, you can only forward to an outside number that is programmed into personal speed dial number 99. Beginning with CPC-B 2.0, you can forward to any speed dial number (system or personal).

- Replace the handset.

### To cancel Call Forwarding

- Lift the handset.
- Dial "72."
- Replace the handset.

### Related Programming

- FF1 (System): Call Forward--No Answer Timer
- FF1 (System): Extension Class of Service Setting (CPC-AII and CPC-B Version 3.1 or higher)
- FF3 (Extension): Extension Class of Service Assignment (CPC-AII and CPC-B Version 3.1 or higher)
- FF3 (Extension): Permanent Call Forward Type (CPC-AII and CPC-B Version 3.1 or higher)
- FF3 (Extension): Permanent Call Forward Extension (CPC-AII and CPC-B Version 3.1 or higher)
- FF10 (Speed Dialing): System Speed Dial Numbers
- FF10 (Speed Dialing): Personal Speed Dial Numbers



## Considerations

- With CPC-A and CPC-B Versions prior to 2.0, calls cannot be forwarded to an extension that already has call forwarding activated. In other words, phone “A” could only forward to phone “B” if phone “B” was not forwarded.

Beginning with CPC-B Version 2.0, calls can be forwarded to extensions that have call forwarding activated. For example, phone “A” can be forwarded to phone “B,” even if phone “B” is forwarded to voice mail.

- Calls can be forwarded to extensions that have call forwarding activated. For example, phone “A” can be forwarded to phone “B,” even if phone “B” is forwarded to voice mail.
- With CPC-AII and CPC-B 4.07 and later, extensions receiving forwarded trunk calls display “CFWD NNN XXXXXX,” where “NNN” = the extension that forwarded the call and “XXXXXX” = the trunk name or number.
- In CPC-A and CPC-B Versions prior to 5.0, DND and Absence Messages cancel Call Forwarding.

Beginning with CPC-B Version 5.0, calls to an extension with DND or Absence Message turned on are treated differently, depending on whether they are trunk or intercom calls. Intercom calls receive busy tone; trunk calls are routed to the extension defined in permanent call forwarding.

The following types of incoming trunk calls follow permanent call forward settings:

- Direct trunk calls (including DID/DNIS)
- Transferred trunk calls.
- Voice calls do not forward when Call Forwarding--No Answer is used.
- Extensions for which Call Forwarding-External has been set cannot:
  - Be in the middle of an outside call when the feature is activated.
  - Have a toll restriction setting that prohibits outside calls.
- Calls can be forwarded to a third-party voice mail with the “Call Forward ID Code” described on page 3-13.
- Beginning with CPC-AII and CPC-B Version 7.0, all call types can be forwarded outside using speed dials. However, if Least Cost Routing is activated, dial “9” trunks cannot be used. Select another trunk group instead (81-86).

---

# Call Hold

(All Versions)

## ***Description***

Call Hold provides either exclusive or system hold, depending on system programming. With Exclusive Hold, only the extension that held the call can retrieve it. With System Hold, another extension can retrieve the call.

## ***Operation***

### **To place a call on Hold:**

Flash the switchhook.

### **To release the call:**

Flash the switchhook again.

## ***Related Programming***

- FF1 (System): Recall Timer for Extension-Held CO Calls
- FF1 (System): Recall Timer for Extension-Held Intercom Calls
- FF1 (System): SLT Onhook Flash Timer
- FF3 (Extensions): Single Line Telephone Hookflash (Broker's Hold/Conference)
- FF1 (System): Single Line Telephone Flash Control

## ***Considerations***

- A held call recalls if it is not retrieved before the Hold Recall Timer expires.
- If there is no response to the Hold Recall, the call transfers to the Attendant Phone; however, no tone sounds at an Attendant Phone if Night Mode is activated.
- If you flash the switchhook during a conference call, the flash is ignored.
- If your system is set to onhook transfer, and you have placed an outside call on hold and then made an intercom call, make sure the other extension

hangs up before you do. If you hang up before the other extension, *the held outside line will be transferred to that extension.*

- The DBS can provide Music-on-Hold to callers placed on hold. See “Music-On-Hold” (page 3-34) for more information.

---

## Call Park

(All Versions)

### ***Description***

Use the Call Park function to transfer an outside call when you cannot locate the intended recipient of the call. Park the call and then page the person to whom you want to transfer the call. That person can answer the call from any extension by dialing the number of the extension that parked the call.

### ***Operation***

#### **To park a call:**

1. Flash the switchhook.
2. Dial “75.”

#### **To retrieve a parked call:**

1. Lift the handset.  
The phone issues intercom dial tone.
2. Dial “76.”
3. Dial the number of the extension that parked the call.

#### **To retrieve a call parked by the attendant (after receiving the Park Number from the Attendant):**

1. Pick up the handset.  
The phone issues intercom dial toned.
2. Dial “76.”

3. Enter the Park Number assigned to the call.

“PARK PICK XX” (where “XX” is the park number) appears, and then “CO TALK #XX” (where “XX” is the trunk number of the call) appears.

### ***Related Programming***

- FF1 (System): Park Recall Timer

### ***Considerations***

- The parked call recalls if it is not retrieved before the Recall Timer expires. If this happens, the user that parked the call can retrieve it by picking up the handset. If no one retrieves the call after the Park Recall Timer expires, the call reverts to the attendant.
- You cannot park more than one outside line at a time.
- The Park Recall Timer is similar to the Recall Timer, except that when the Park Recall Timer is set for “0” calls are automatically recalled in three minutes.

---

## **Call Pickup**

(All Versions)

SLTs can use both direct and group call pickup.

### **Direct Call Pickup**

#### ***Description***

A call to an extension can be answered from any other extension with the Direct Call Pickup feature.

#### ***Operation***

1. Lift the handset.
2. Dial “79.”
3. Enter the number of the ringing extension.

## ***Related Programming***

- FF1 (System): Extension Class of Service Setting (CPC-AII and CPC-B 3.1 or higher)
- FF3 (Extension): Extension Class of Service Assignment (CPC-AII and CPC-B Version 3.1 or higher)

## ***Considerations***

- If more than one caller is attempting to reach the ringing extension, the Direct Call Pickup feature will answer the call that arrives first.

Once the call has been picked up, other extensions that attempt to pick up the call receive busy tone.

- You can answer incoming calls, intercom calls (both tone and voice), call waiting, paging, transferred calls, or recalls using the Direct Call Pickup feature. You cannot answer camp-on callback rings with this feature.

## **Group Call Pickup**

### ***Description***

Using the Group Call Pickup feature, you can answer calls to other extensions within your Paging Group (01-07) without entering the number of the ringing extension.

### ***Operation***

1. Lift the handset.
2. Dial “70.”

## ***Related Programming***

- FF1 (System): Extension Class of Service Setting (CPC-AII and CPC-B Version 3.1 or higher)
- FF3 (Extension): Extension Class of Service Assignment (CPC-AII and CPC-B Version 3.1 or higher)
- FF3 (Extension): Extension Page Group

## **Considerations**

- If more than one call is arriving at the Paging Group, the Group Call Pickup feature will answer the call to the lowest port number first.
- If the called extension belongs to more than one Paging Group, the Group Call Pickup Feature will answer the call to the lowest-numbered Paging Group first.
- You can answer incoming calls, Intercom Tone Calling, or Intercom Voice Calling using the Group Call Pickup feature.
- Group Call Pickup cannot be used to pick up a ringing phone in Paging Group 00. For example, if an extension is a member of Paging Groups 00 and 06, the extension can use Group Call Pickup to answer ringing calls in Group 06, but not in Group 00.

---

## **Call Transfer**

(All Versions)

The DBS provides two call transfer methods: blind transfer and screened transfer.

With CPC-A and CPC-B Versions prior to 2.0, SLTs can only transfer trunk calls. Beginning with CPC-B Version 2.0, SLTs can transfer trunk and intercom calls.

## **Blind Transfer**

### ***Description***

Blind transfer allows the transfer of a call directly to an extension, without waiting for the called extension to answer.

### ***Operation***

1. Flash the switchhook to place the call on hold.
2. Dial the number of the extension to which the call is to be transferred.
3. Replace the handset before the other party answers.
  - You can also replace the handset after the third party answers.

- The third party need only pick up the handset to speak to the outside line.

### ***Related Programming***

- FF1 (System): Onhook (Automatic) Transfer
- FF1 (System): Recall Timer for Extension-Transferred CO Calls
- FF1 (System): Recall Timer for Extension-Transferred Intercom Calls

### ***Considerations***

- In order for users to transfer calls by flashing the switchhook, dialing the extension, and going onhook, the Onhook Transfer feature must be enabled.
- You cannot transfer a call to an extension that has Do Not Disturb or Absence Message activated.
- You can transfer a call to an extension that has Call Forwarding activated. The transferred call will follow the call forwarding path of the extension it is transferred to.

For example, if extension “A” is covered to extension “B,” calls that are transferred to extension “A” will be forwarded to extension “B.”

- When you transfer a call to an extension that is busy or does not answer and does not have Call Forwarding activated, the transfer will recall your extension after the Transfer Recall Timer expires.

## **Screened Transfer**

### ***Description***

Using the Screened Transfer feature, you can contact a third party via an extension before transferring a call to that party.

### ***Operation***

#### **To use Screened Transfer when your system is set for Onhook Transfer:**

1. Flash the switchhook to place the call on hold.

The phone issues intercom dial tone.

2. Dial the extension number to which the call is to be transferred.
3. When your call is answered, inform the third party of the transfer.
4. Replace the handset.

The third party need only pick up the handset to speak to the outside line.

#### **To use Screened Transfer when Onhook Transfer is disabled:**

1. Flash the switchhook to place the outside call on hold.

The phone issues intercom dial tone.

2. Dial the extension number to which the call is to be transferred.
3. When your call is answered, inform the third party of the transfer.

The **EXT** LED stops flashing and remains lit.

4. Dial “8.”

The third party need only pick up the handset to speak to the outside line.

5. Replace the handset.

### ***Related Programming***

- FF1 (System): Onhook (Automatic) Transfer
- FF1 (System): Recall Timer for Extension-Transferred CO Calls
- FF1 (System): Recall Timer for Extension-Transferred Intercom Calls

### ***Considerations***

- You cannot transfer a call to an extension that has Do Not Disturb or Absence Message activated.
- You can transfer a call to an extension that has Call Forwarding activated. The transferred call will follow the call forwarding path of the extension it is transferred to.

For example, if phone “A” is covered to phone “B,” calls that are transferred to phone “A” will be forwarded to phone “B.”



- When you transfer a call to an extension that is busy or does not answer and does not have Call Forwarding activated, a recall tone sounds at your extension after Transfer Recall Timer expires.

## Call Waiting

(All Versions)

### Description

You can send a Call Waiting signal, followed by a brief LCD message, to a busy extension. The party receiving the message need only replace the handset and then pick it up again to be automatically connected to your extension.

The following messages can be sent using the Call Waiting feature:

**Table 6-4. Call Waiting Text Messages**

Message Code	Message
5	“Visitor Here”
6	“Need Help”
7	“Important”
9	“Emergency”

Message codes 0-4 are not available.

### Operation

#### To Set Call Waiting:

1. Lift the handset.
2. Dial the extension number.
3. Upon hearing busy tone, press “3.”
4. If you wish to send a text message, dial the desired message code (5-7 or 9).

The message displays on the called party’s phone if the called party has a key phone. (If the called party does not have a display, the extension continues to issue a call waiting tone.)

5. Remain on the line until the called party picks up.

**To answer Call Waiting (and disconnect the current call):**

1. Replace the handset.

The current call is disconnected.

2. Pick up the handset.

You are automatically be connected to the extension sending the Call Waiting.

**To answer Call Waiting (without disconnecting the current call):**

1. Flash the switchhook.

- The current call is disconnected.
- The new call is connected automatically.

2. Flash the switchhook again to retrieve the original call.

***Related Programming***

- FF1 (System) Extension Class of Service Setting (CPC-AII and CPC-B Version 3.1 or higher)
- FF3 (Extension): Extension Class of Service Assignment (CPC-AII and CPC-B Version 3.1 or higher)
- FF3 (Extension): Call Waiting/OHVA

***Considerations***

- Call Waiting can be used without entering a message code.
- Extensions that have DND activated, have a call on hold, are ringing (from another call), or are engaged in a conference call cannot receive Call Waiting.
- Call Waiting cannot be sent to an ML key.

---

# Camp-on

(CPC-A 3.1 or higher, CPC-AII, and all Versions of CPC-B)

## ***Description***

If you reach a busy extension, you can use the Camp-on feature to alert you with a ring when the extension becomes free. You can then pick up your handset to automatically dial the extension.

## ***Operation***

### **To activate the Camp-on feature:**

1. Lift the handset.
2. Dial the desired extension number.
3. Upon hearing busy tone, press “3.”
  - The phone issues ringback tone.
  - If the Camp-on feature is not available, the phone continues to issue a busy tone.
4. Replace the handset after you hear the ringback tone.
5. Wait for the callback ring.

### **To answer the callback ring:**

Pick up the handset when you hear the callback ring.

The system automatically dials the called extension.

## ***Related Programming***

- FF3 (Extension): Call Waiting/OHVA Tone
- FF3 (Extension

## ***Considerations***

- The callback ring must be answered within sixteen seconds or it is canceled.

- A Camp-on request will only be accepted *after* Call Waiting status.
- You cannot camp-on to an extension that has call forwarding activated.
- An extension can only have one call camped on at a time. For example, if Extension 152 camps on to Extension 153, another extension cannot camp on to 153, as long as 152 is camped on.
- An extension that has initiated a camp-on cannot receive a camp-on. For instance, if Extension 200 has camped on to Extension 300, another extension cannot camp on to 200.
- With CPC-AII and CPC-B 5.03 and above, callbacks are not forwarded. For example, if Extension 200 is call forwarded to Extension 300, Extension 200 can register a callback request to Extension 400. When the callback request is returned, it rings Extension 200 and does not follow call forwarding.

---

## Conference Calls

(All Versions)

### ***Description***

Conference Calling allows extension users to add a party to an existing conversation.

SLT users can create the following types of Conference Calls:

- One outside line and two extensions
- Two outside lines and one extension (CPC-AII and CPC-B Version 3.1 or later)
- Three extensions.

### ***Operation***

#### **To add an extension:**

1. Flash the switchhook to place the current call on hold.
2. Dial the number of the extension you wish to add to the call.
3. Dial “7” when your call is answered.

**To add an outside number (CPC-AII and CPC-B Version 3.1 or higher):**

1. Flash the switchhook to place the current call on hold.
2. Dial a trunk group number (81-86 or 9).
3. Dial the outside number.
4. Flash the switchhook when your call is answered.

***Related Programming***

- FF3 (Extension): Single Line Telephone Hookflash (Brokers Hold/Conference)

***Considerations***

- Call Waiting tone can be received during conference calls, however, you cannot respond to call waiting until the completion of the conference call because you cannot place the parties in the conference on hold.
- A switchhook flash is ignored during a conference call.
- Calls forwarded externally cannot create a conference.
- The Hold feature cannot be used during a three-party conference.

---

## **Dial “0” for Attendant**

(CPC-AII and CPC-B Version 2.0 or higher)

***Description***

Users can call the Attendant from any extension by pressing “0.”

If multiple attendants are assigned, a dial “0” call goes to Attendant “1” first. If attendant “1” is busy, the call goes to Attendant “2.” The call continues to transfer to the next attendant in the attendant group if necessary.

A maximum of four attendants can be assigned.

***Operation***

1. Lift the handset.

2. Press “0.”

### ***Related Programming***

- FF1 (System): Second Attendant Position
- FF1 (System): Third Attendant Position
- FF1 (System): Fourth Attendant Position
- FF1 (System): Attendant Transfer Extension

---

## **Dial Tone Disable**

(All Versions)

### ***Description***

The intercom dial tone can be turned off at an attendant phone. Dial tone is turned off when a headset is used.

### ***Operation***

#### **To disable the intercom dial tone:**

1. Lift the handset
  - The phone issues intercom dial tone.
2. Press “#50.”
3. Replace the handset.

#### **To reactivate dial tone:**

Repeat the preceding steps.

---

# Direct Trunk Access

(All Versions)

## *Description*

Extensions can access a specific trunk for outgoing calls. Extensions can also use Direct Trunk Access to test trunks or to access data trunks.

## *Operation*

1. Lift the handset.
2. Dial “88” followed by the desired trunk number (01-64).
3. Dial the outside number.
4. Replace the handset.

---

# Do-Not-Disturb (DND)

(All Versions)

## *Description*

An extension can be made unavailable by activating Do-Not-Disturb (DND). When DND is activated at an extension, calls to that extension receive busy tone.

## *Operation*

### **To activate DND:**

1. Lift the handset.
2. Dial “73.”
3. Replace the handset.

DND is indicated by stutter dial tone followed by dial tone when you go off-hook.

**To cancel DND:**

1. Lift the handset.
2. Dial “73.”
3. Replace the handset.

***Related Programming***

- FF1 (System): Extension Class of Service Setting (CPC-AII and CPC-B Version 4.0 or higher)
- FF3 (Extension): Extension Class of Service Assignment (CPC-AII and CPC-B Version 4.0 or higher)

***Considerations***

- In CPC-A and CPC-B Versions prior to 5.0, DND and Absence Messages cancel Call Forwarding.

Beginning with Version 5.0, calls to an extension with DND or Absence Message turned on are treated differently, depending on whether they are trunk or intercom calls. Intercom calls receive busy tone; trunk calls are routed to the extension defined in permanent call forwarding.

The following types of incoming trunk calls will follow permanent call forward settings:

- Direct trunk calls (including DID/DNIS)
- Transferred trunk calls.
- The DND feature cannot be activated at an extension selected to receive Call Forwarding.
- If Message Waiting/Call-Back is applied to an extension in DND, after DND is cancelled then stutter dial tone will still be heard to indicate the callback request. Press “##” to call the party that originated the callback request.



---

# Intercom Calling

(All Versions)

## ***Descriptions***

The DBS provides two methods of intercom calling: voice calling and tone calling.

**Voice Calling.** With voice calling, intercom calls are connected immediately, without a ringing tone.

**Tone Calling.** With tone calls, a ringing tone is sent to the called extension.

System programming determines whether the DBS uses voice or tone calling as a default. If voice calling is the default, dialing a “1” after the extension number changes the call to a tone call. If tone calling is the default, dialing a “1” results in a voice call.

## ***Operation***

### **To make a Voice Call:**

1. Lift the handset.
2. Dial the extension number.
3. If the system default is tone calling, dial a “1.”

### **To make an Tone Call:**

1. Lift the handset.
2. Dial the extension number.
3. If the system default is voice calling, dial a “1.”

The called extension will ring.

## ***Related Programming***

- FF1 (System): Extension Intercom Calling
- FF1 (System): Alert Tone for Voice Calls
- FF1 (System): Extension Class of Service Setting (CPC-AII and CPC-B Version 4.0 or higher)

- FF3 (Extension): Extension Class of Service Assignment (CPC-AII and CPC-B Version 4.0 or higher)

### ***Considerations***

- When an extension's calling mode is set for voice calls, a "splash" tone can be sent to alert the extension to the voice call. System programming determines if the splash tone is provided.
- If an extension is onhook, it will receive tone calls.
- The voice calling feature is not available for DISA incoming calls.
- Voice calls do not forward if Cover No Answer is turned on.

---

## **Last Number Redial**

(All Versions)

### ***Description***

The last outside number dialed may be redialed automatically.

### ***Operation***

1. Lift the handset.
2. Dial a trunk access code (81-86 or 9).
3. Flash the switchhook.
4. Dial "89."

### ***Considerations***

- The Last Number Redial feature can redial a number up to sixteen digits long.
- A maximum of five chained Speed Dialing codes can be redialed.

---

# Meet-Me Answer

(All Versions)

## *Description*

You can answer a Paging call from any extension using the Meet-Me Answer feature.

## *Operation*

1. Pick up the handset from any extension at which you hear the Paging call.
2. Press “77.”

Paging ceases and you are connected to the party trying to reach you.

## *Related Programming*

- FF1 (System): Extension Class of Service Setting (CPC-AII and CPC-B Version 4.0 or higher)
- FF3 (Extension): Extension Class of Service Assignment (CPC-AII and CPC-B Version 4.0 or higher)

## *Considerations*

- You can only use the Meet-Me Answer feature at an extension that does not have an incoming call.
- If an external paging system or a Universal Answer system has been installed, use Group Call Pickup to respond to a Paging call.

---

# Message Waiting/Callback Request

(All Versions)

## ***Description***

If you try to call an extension that is busy or does not answer, you can leave a message requesting a return call.

## ***Operation***

### **To leave a Message Waiting/Callback Request:**

1. Lift the handset.
2. Dial the extension number.
3. Dial “2” at the busy tone or while the telephone is still ringing.
4. Replace the handset.

### **To answer a Message Waiting/Callback Request (CPC All and CPC-B only):**

1. Pick up the handset.

The phone issues a stutter dial tone followed by constant dial tone.

2. Dial “##.”.

Your telephone automatically dials the extension that left the Message Waiting Callback Request.

### **To cancel a Message Waiting/Callback Request (CPC-All and CPC-B only):**

1. Lift the handset.
2. Dial “#\*”.
3. Replace the handset.

## ***Related Programming***

- FF1 (System) Extension Class of Service Setting (CPC-AII and CPC-B Version 3.1 or higher)
- FF3 (Extension) Extension Class of Service Assignment (CPC-AII and CPC-B Version 3.1 or higher)

## ***Considerations***

- With CPC-A, SLTs cannot receive callback requests.
- Up to four Message Waiting/Callback Requests can be sent to any one extension.
- If a Callback Request is sent to an extension for which Call Forwarding is set, the Callback Request is automatically forwarded to the designated extension. The Message Waiting/Callback request is not cleared if a connect is established with the extension forwarded to.
- You can send a Callback Request to an extension that has Do Not Disturb or Absence Message activated.
- Beginning with CPC-A 3.28, CPC-B 4.07, and CPC-A II 6.0, making a blind transfer to an extension to which you have previously sent a callback request will not cancel your callback request. Earlier CPC versions cancelled your callback request if you transferred a call to the same extension.

---

# **Off-Hook Voice Announce (OHVA)**

(CPC-A Version 3.1; All Versions of CPC-A II and CPC-B)

## ***Description***

Use the Off-Hook Voice Announce (OHVA) feature to interrupt a busy extension and then make an announcement that only the called party can hear.

## ***Operation***

### **To make an OHVA:**

1. Lift the handset.

2. Dial the desired extension number.
3. Upon hearing busy tone, press “5.”

### ***Related Programming***

- FF1 (System): Alert Tone for Busy Override & OHVA
- FF1 (System): Extension Class of Service Setting (CPC-AII and CPC-B 3.1 or higher)
- FF3 (Extension): Extension Class of Service Assignment (CPC-AII and CPC-B 3.1 or higher)
- FF3 (Extension): Call Waiting/OHVA (Enable)

### ***Considerations***

- If Onhook Transfer is enabled, the held call is transferred as soon as the extension sending the OHVA hangs up.
- You cannot receive a Call Waiting message during an OHVA.
- You cannot toggle back and forth between two calls while receiving an OHVA.
- If you make an Offhook Voice Announcement to an SLT, the SLT user **and the other party** will hear the announcement.

---

## **Pooled Trunk Access**

(All Versions)

### ***Description***

The DBS system is designed to accept from 8 to 64 outside lines. These lines can be divided into seven Pooled Trunk groups. The groups are numbered 9 and 81-86.

Selecting a pooled trunk access number automatically selects a free trunk from the group.

### ***Operation***

1. Lift the handset.

- The phone issues intercom dial tone.
2. Dial the desired trunk group number (81-86 or 9).
  3. Dial the outside number.

### ***Related Programming***

- FF1 (System): Least Cost Routing (LCR) Access
- FF2 (Trunks): Pooled Trunk Access for Group “9”
- FF2 (Trunks): Pooled Trunk Access for Group “81-86”
- FF3 (Extension): Forced Least Cost Routing
- FF8 (LCR) LCR Settings (all)

### ***Considerations***

- There are seven groups of outside lines: 9 and 81-86.
- Dialing “9” activates LCR if the LCR option is enabled.

---

## **Speed Dialing**

(All Versions)

### **Personal Speed Dialing**

#### ***Description***

Frequently called numbers can be stored using the Personal Speed Dial feature. Personal speed dial numbers are assigned to SLTs from attendant or key phones. Up to 10 Personal Speed Dial numbers can be stored for each SLT.

With all versions prior to Version 7.0, the Personal Speed Dial bins are numbered 90 to 99. With CPC-AII and CPC-B Version 7.0 and higher, the Personal Speed Dial bins are numbered 900 to 909.

## ***Operation***

### **To program a Personal Speed Dial**

1. Pick up the handset
2. Dial **\*80**.
3. Dial the Personal Speed Dial number (90-99 or 900-909)).
4. Dial \* followed by the trunk access number (9, 1-6 for trunk access 89, 81-86).
5. Dial the telephone number.
6. Hang up.

### **To dial a Personal Speed Dial number:**

1. Pick up the handset.
2. If necessary, access an outside line.
3. Dial **"80."**
4. Dial the Personal Speed Dial number(90-99 or 900-909).

## **System Speed Dial**

### ***Description***

Frequently called numbers can be stored using the System Speed Dial feature. Up to 90 System Speed Dial numbers (00-89) can be programmed at the Attendant Phone and can be used by any extension. Beginning with CPC-AII and CPC-B Version 7.0, up to 200 System Speed Dial numbers (000-199) can be stored for each SLT.

### ***Operation***

#### **To dial a system speed dial number:**

1. Pick up the handset.
2. If necessary, access an outside line.



3. Dial “80.”
4. Dial the system speed dial code (00-89 or 000-199).

### ***Related Programming***

- FF1 (System): Override Toll Restriction with SSD Numbers
- FF10 (Speed Dialing): System Speed Numbers

---

## **Station Lockout**

(All Versions)

### ***Description***

Use the Station Lockout feature to dial a Station Lockout code that prevents other users from using your phone.

#### **To activate Station Lockout:**

1. Lift the handset.
  - The phone issues intercom dial tone.
2. Dial “74.”
3. Dial the Station Lockout code.
4. Replace the handset.

#### **To deactivate Station Lockout:**

1. Lift the handset.
  - The phone issues intercom dial tone.
2. Dial “74.”
3. Dial the Station Lockout code.
4. Replace the handset.

### ***Related Programming***

- FF3 (Extensions): Extension Lockout Code

### ***Considerations***

- A locked extension can be used for Intercom Calls.
- Station Lockout key codes can only be set from an attendant phone or a key phone.
- You cannot confirm Speed Dialing or set Speed Dialing while Station Lockout is activated.
- If you enter an incorrect key code and then try to dial, the phone will issue a busy tone.
- If station lockout is set, when **ON/OFF** is pressed, stutter dial tone is heard followed by steady dial tone.

---

# Appendix A: CPC-EX 1.0 Updates

CPC-EX Version 1.0 (and above) offers the following enhancements to the DBS phone system:

---

## Compatibility

CPC-EX Version 1.0 supports all features of CPC-B Version 7.1 (with the exception of TSAPI support). In addition, CPC-EX Version 1.0 adds support for additional features, including the 44-Series phones, T1 Networking, and ISDN.

The CPC-EX card can be installed into an existing DBS cabinet, with no hardware modifications.

CPC-EX software uses existing CPC-B programming addresses, with the same numbering. Additional addresses have been added for CPC-EX features.

**Note:** CPC-EX requires SCC-B.

---

## 44-Series Phone Support

CPC-EX provides full support for Panasonic's 44-Series phones (VB-44xxx). Table 1 below lists all 44-Series phone models and their part numbers. Most models are available in two colors: gray and black.

*Table A-1. 44-Series Phones*

16-Key Phone (gray)	VB-44210G
16-Key Phone (black)	VB-44210B
16-Key Speakerphone (gray only)	VB-44211G
22-Key Phone (gray only)	VB-44220G
22-Key Small-Display Speakerphone (gray)	VB-44223G
22-Key Small-Display Speakerphone (black)	VB-44223B
34-Key Small-Display Phone (gray only)	VB-44230G
34-Key Small-Display Speakerphone (gray)	VB-44233G
34-Key Small-Display Speakerphone (black)	VB-44233B
22-Key Large-Display Speakerphone (gray)	VB-44225G
22-Key Large-Display Speakerphone (black)	VB-44225B
DSS/72 Console (gray)	VB-44320G
DSS/72 Console (black)	VB-44320B
EM/24 Unit (gray)	VB-44310G
EM/24 Unit (black)	VB-44310B

Enhanced DBS features that can be executed on the 44-Series phones are described below:

## Directory Mode

On the small-display phones, you can scroll through SSD names, PSD names, or extension names and select a displayed name for dialing.

## Variable Mode

The small-display phones provide one-touch access to various features displayed during each of the following call states: 1) during an intercom call; 2) during CO dial tone; 3) during a trunk call; and 4) after dialing a busy extension.

## Handset Mute

The large-display phone now contains a MUTE key, and a mute feature is available on all 44-series phones. Pressing the MUTE key during an off-hook call will block audio from the handset transmitter to the outside party. You can still hear them, but they can't hear you.

## Off-Hook Monitoring

If you press the ON/OFF key during an off-hook call on any 44-series speakerphone, the other party's voice will be heard through both the handset and the speaker. This allows a third party to hear both sides of a conversation. **Note:** This feature does not activate your phone's microphone - audio will be transmitted only through your handset.

## Analog Adapter

The large-display phone can be enhanced with an analog port adapter which allows you to connect to an analog device such as a FAX or modem to the phone. This allows the same phone to be alternately used for analog or digital communications.

## MSG (Message) Key

A MSG key on the large-display phone will perform Auto-Callback (automatically dialing the extension that sent a "Message Waiting" to your phone), or Auto-Answer Message (automatically dialing your voice mailbox).

## DSS/72 and EM/24 - Key Arrangement

The keys on the consoles are arranged differently, affecting the text layout and default extension numbers assigned to these keys.

---

## FF-Key Programming

Because T1 Networking adds the capability of 4-digit extension numbering, you can now program up to 8 digits (not 6) into an FF-key.

---

## Speed Dial Enhancements

CPC-EX supports up to 500 System Speed Dial (SSD) numbers. CPC-EX also allows SSD codes to be chained, or “linked”, to another SSD number, and either PSD or SSD codes to be chained to a PSD number.

---

## Additional Serial Port

The CPC-EX card contains an on-board serial port (Serial Port 2) which can be used for Bus Monitor/Maintenance. This allows remote maintenance to be accomplished without disconnecting SMDR cabling.

---

## T1 Networking Capability

Up to 4 DBS's can now be connected together via T1 interface to form a DBS phone network. The DBS's can be located in the same building, in separate buildings in a campus-type environment, or at remote locations in separate states. Networked DBS's use 4-digit extensions, with the first digit of the extension number identifying the DBS site.

Each site requires its own DBS cabinet with a CPC-EX card and a T1 card. Programming addresses are included in CPC-EX software for setting up the T1 Network. (*see the T1 Networking Reference Manual for complete instructions.*)

---

## Modification to Toll Restriction Service

The program address for TRS Operator Access (FF7 1# 18#) has been modified to allow an extension to dial “0+NXX” phone numbers, even if “0-only” dialing is denied.

---

## Maximum Time Priority Route Tables

CPC-EX allows a maximum of 8 Time Priority Route Tables (not 15) to be used during LCR programming. Since few systems use more than 3 Time Priority Route Tables, this change will allow the saved memory space to be used for future enhancements.

---

## SMDR Modifications

SMDR reports contain several additional call types and other parameters due to CPC-EX support of T1 Networking and ISDN calls.

---

## ISDN Support

CPC-EX supports ISDN-PRI (Integrated Services Digital Network -- Primary Rate Interface). The program address for Trunk Circuit Type (FF2 (trunk #)# 21#) has been modified to allow for ISDN. Programming addresses have also been added in CPC-EX to support ISDN. (*See the ISDN Reference Manual for complete instructions.*)

---

## Modification to T1 Signaling Types

To allow easier programming of E&M trunks, CPC-EX uses “Wink Start” (not “Immediate Start”) as the default for T1 Incoming and Outgoing Signal Types.

---

## Installation Notes

### CPC-EX Installation

Use normal installation procedures to install the CPC-EX. The following illustration shows an installed CPC-EX:

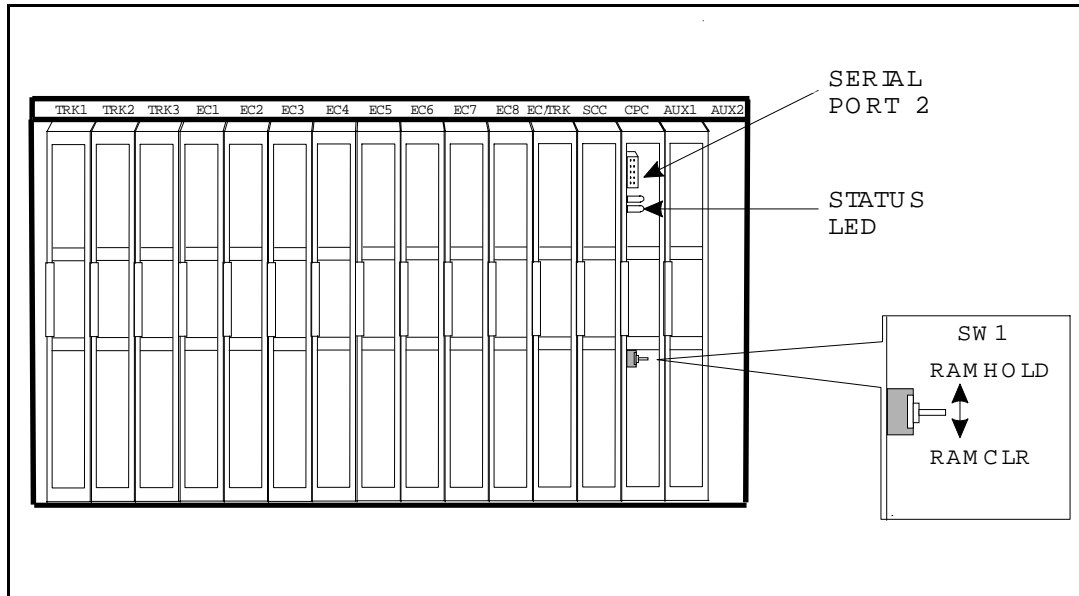
*Figure A-1 CPC-EX*

## Key Telephone Installation

### Desi Strip Cover

The 44-Series Key Telephones are shipped with a thin green protective film over the Desi strip cover. Be sure to remove this film from both sides of the Desi cover before placing the phone in service.

### Key Telephone Wall Mounting Instructions

The following procedures apply to 44-Series Key Telephones only. Please be sure to follow these procedures exactly. Removing the desk stand incorrectly can result in damage to the telephone and/or desk stand.

1. Place the telephone face down on a flat surface.
2. Grasp the top of the desk stand (at the **>ABS<** label) and pull up the end to 90° vertical (refer to Step 2 in Figure A-2). The stand will click as it releases from the plastic securing latches.
3. Lift the desk stand as shown in Step 3 of Figure A-2.

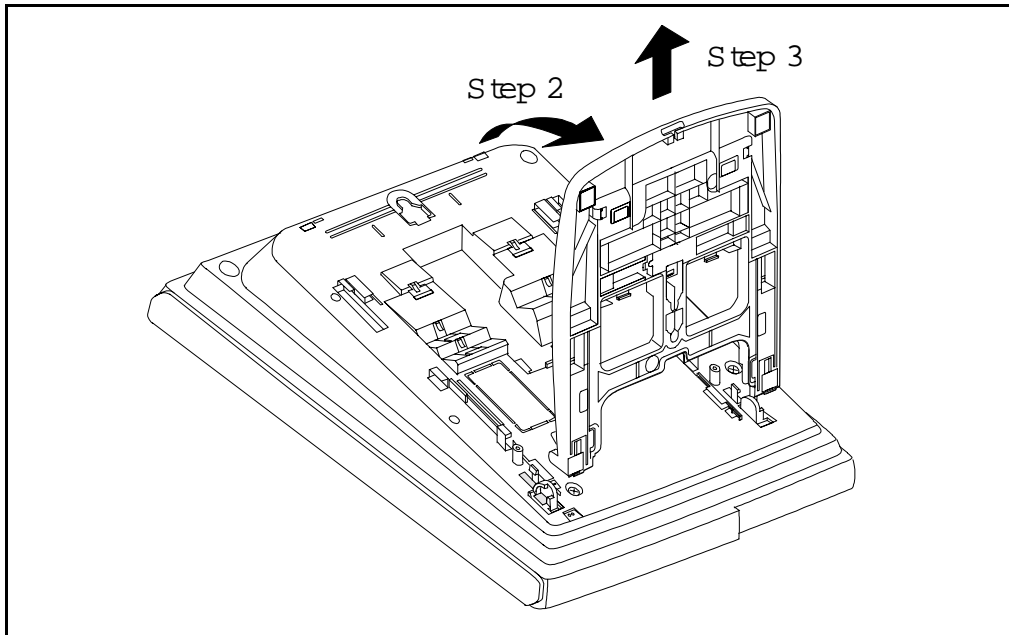
**Figure A-2.Desk Stand Removal.**

4. Rotate the desk stand 180°. In this position it doubles as a wall mount bracket.
5. Insert the wall mount bracket into the mounting guides as shown in Figure A-3.
6. Slide the wall mount bracket onto the telephone.

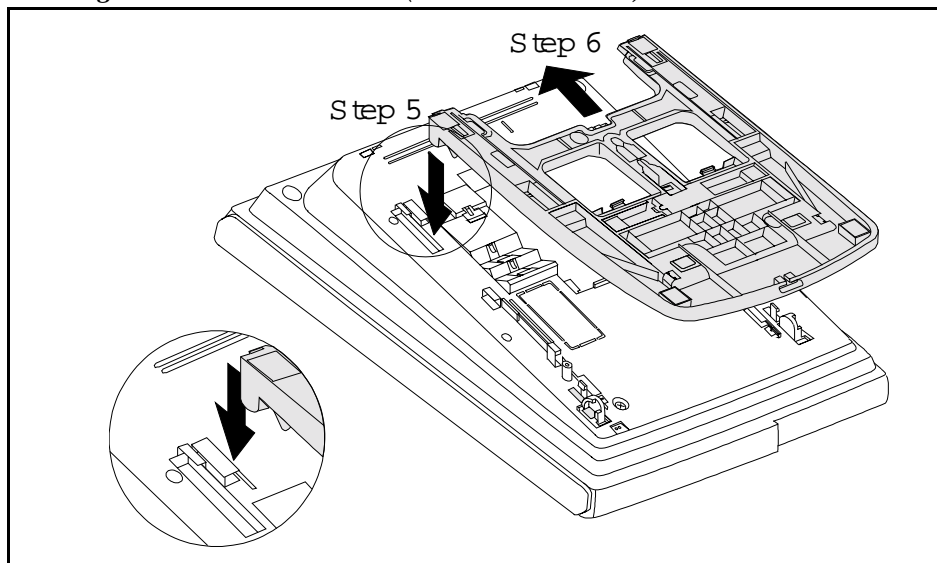
**Figure A-3.Inserting the wall mount bracket (rotated desk stand)**

7. While viewing the front of the telephone, find the handset guide located just below the hookswitch (see Figure A-4).



- Slide the handset guide out, rotate 180° so that the holding clip is exposed, and reinsert.

*Figure A-4. Handset guide insertion for wall mounting, key telephone*

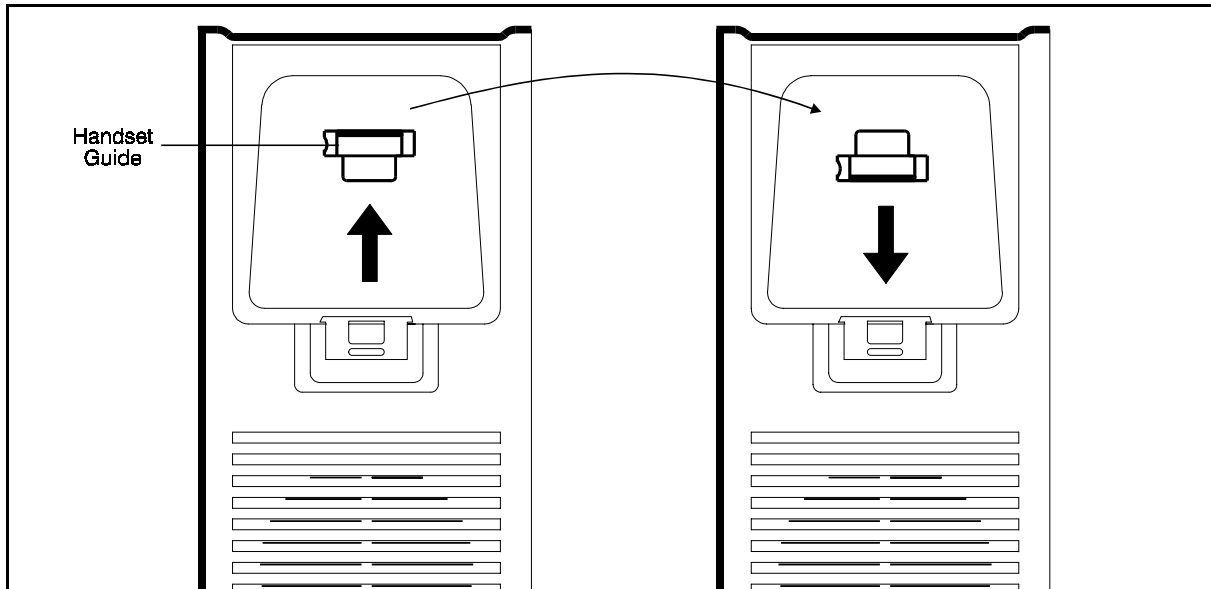

---

## 44-Series Enhanced Phone Features

**Note:** The enhanced features introduced with these phones are supported by CPC-EX Version 1.0, CPC-AII/B Version 8.0, and CPC-S/M Version 2.0. You can also use the 44-Series phones with previous DBS versions, but the enhanced features won't be supported.

Figure A-5.44-Series Small-Display Phone

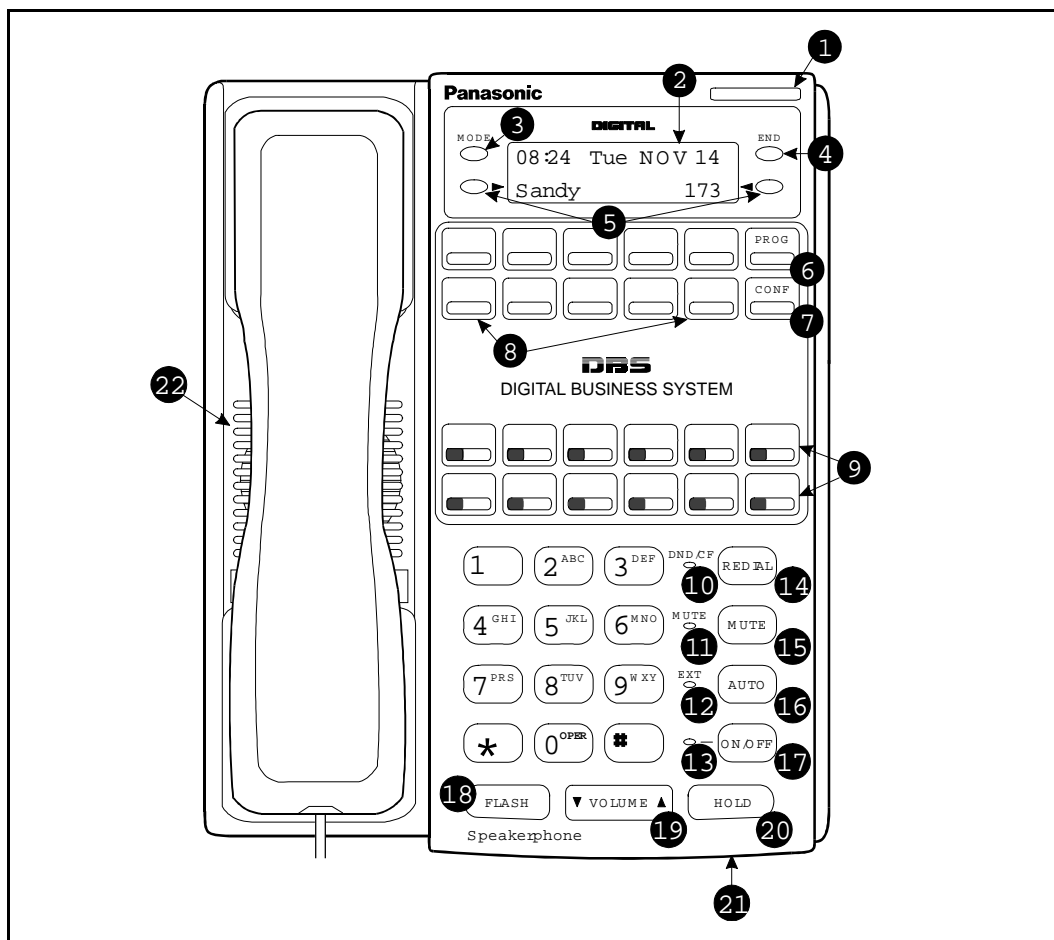

Table A-2. Small-Display Phone Features

#	Feature	Description
1	Message Indicator	Indicates that you have a message.
2	Display	Displays information about phone's status, menus, dialing directories, and text message information.
3	Mode Key	Used to change display modes from default to directory mode.
4	End Key	Used to exit directory mode and return display to default mode.
5	Select Keys	Used to select and dial System Speed Dial, Personal Speed Dial, and Extension numbers from a directory.
6	PROG Key	Used to program FF and one-touch keys and to adjust ringer volume. Depending on the setup of your system, may also be used to transfer calls.
7	CONF Key	Used to establish conference calls, check FF key and one-touch features, and scroll through messages.

#	Feature	Description
8	One-Touch Keys	Used to make outside calls or to access call-handling features.
9	Flexible Function (FF) Keys	Used to access outside lines or to access call-handling features.
10	DND/CF Indicator	Indicates that Do-Not-Disturb, Call Forwarding, or Absence Message is set.
11	MUTE Indicator	Indicates that your voice is muted - i.e., party on the other end cannot hear you. Lights solid when your hands-free microphone is muted and flashes when your handset is muted.
12	EXT Indicator	Lights when you are on a call; flashes when you hold a call.
13	ON/OFF Indicator	Lights when ON/OFF key has been pressed.
14	REDIAL Key	Used to redial last outside number dialed.
15	MUTE Key	Used to activate/deactivate MUTE function. When activated, the party on the other end cannot hear you. (See item 11, MUTE Indicator.)
16	AUTO Key	Used to access speed dialing, enter account codes, or for message waiting answer/cancel.
17	ON/OFF Key	Used to make a call without lifting handset.
18	FLASH Key	Used to end an outside call and to restore dial tone without hanging up receiver.
19	VOLUME Key	Used to adjust level of tones, background music, ringing, receiver volume, and display contrast.
20	HOLD Key	Used to hold calls, to retrieve held calls, and to complete FF key programming.
21	Microphone	Used to talk with other party without using the handset.
22	Speaker	Outputs tones and voice at your extension.

Figure A-6.44-Series Large-Display Phone

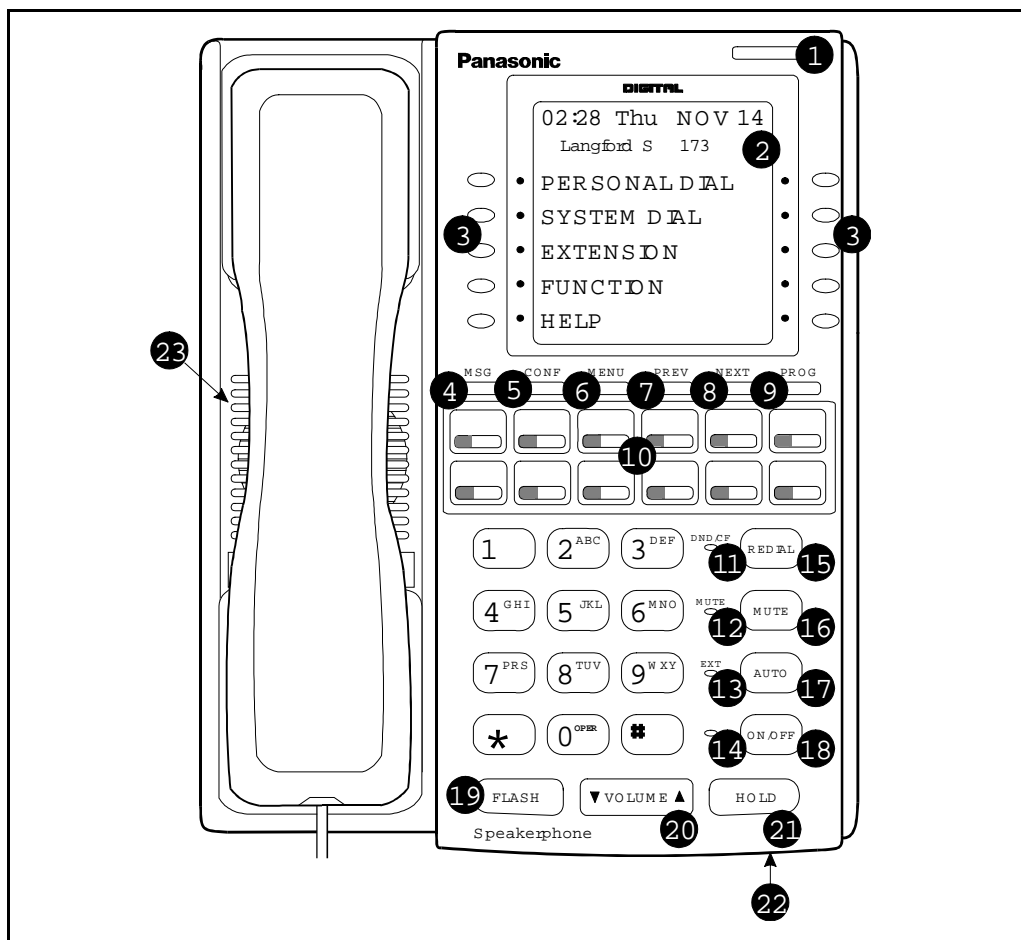

Table A-3. Large-Display Phone Features

#	Feature	Description
1	Message Indicator	Indicates that you have a message.
2	Display	Displays information about phone's status, menus, dialing directories, and text message information.
3	Soft Keys	Used to make outside calls or to access call-handling features.
4	MSG Key	Used for Auto-CallBack to a telephone which has left a text message or to access voice messages.
5	CONF Key	Used to establish conference calls, check FF and one-touch key settings, and scroll through messages.

#	Feature	Description
6	MENU Key	Used to return to the Main Menu screen. The default Main Menu screen contains the following items: <ul style="list-style-type: none"> <li>• PERSONAL DIAL</li> <li>• SYSTEM DIAL</li> <li>• EXTENSION</li> <li>• FUNCTION</li> <li>• HELP</li> </ul>
7	PREV Key	Used to return to the previous menu.
8	NEXT Key	Used to advance to the next menu.
9	PROG Key	Used to program FF and one-touch keys and to adjust ringer volume. Depending on the setup of your system, may also be used to transfer calls.
10	Flexible Function (FF) Keys	Used to access outside lines or to access call-handling features.
11	DND/CF Indicator	Indicates that Do-Not-Disturb, Call Forwarding, or Absence Message is set.
12	MUTE Indicator	Indicates that your voice is muted - i.e., party on the other end cannot hear you. Lights solid when your hands-free microphone is muted and flashes when your handset is muted.
13	EXT Indicator	Lights when you are on a call; flashes when you hold a call.
14	ON/OFF Indicator	Lights when ON/OFF key has been pressed.
15	REDIAL Key	Used to redial last outside number dialed.
16	MUTE Key	Used to activate/deactivate MUTE function. When activated, the party on the other end cannot hear you. (See item 12, MUTE Indicator.)
17	AUTO Key	Used to access speed dialing, enter account codes, or for message waiting answer/cancel.
18	ON/OFF Key	Used to make a call without lifting handset.
19	FLASH Key	Used to end an outside call and to restore dial tone without hanging up receiver.
20	VOLUME Key	Used to adjust level of tones, background music, ringing, receiver volume, and display contrast.
21	HOLD Key	Used to hold calls, to retrieve held calls, and to complete FF key programming.
22	Microphone	Used to talk with other party without using the handset.
23	Speaker	Outputs tones and voice at your extension.

## Directory Mode

### Description

This enhanced feature applies to the 44-Series small-display phone only (i.e., phones with a 2-line LCD display).

In Directory Mode, you can use the phone's select keys (as well as other keys) to scroll through a directory of existing System Speed Dial (SSD) names, Personal Speed Dial (PSD) names, or extension names -- and select one to dial.

- *For example, if you can't remember the party's extension number or speed-dial number to which you want to transfer a call on hold, you can use Directory Mode to find the number and execute the transfer.*

### Operation

The select keys on the 44-Series small-display phone are located next to the display's 2nd line. Pressing select key 1 (“>” on the left) or select key 2 (“<” on the right) will access the displayed directory.

#### To use Directory Mode:

1. Press the MODE key to turn Directory Mode on. The 2nd line of the LCD will display “SSD” on the left and “PSD” on the right.
  - Press the MODE key again to access the directory for extension names. The 2nd line of the LCD will display “EXT” on the left.
2. Press the > select key to access the directory of existing SSD or EXT names; or the < select key to access the PSD directory. The 2nd line will show two speed-dial or extension names at a time (the first 7 characters of each name), beginning with the A's.
3. To scroll through the names (two at a time), press the # key. To back-scroll, press the \* key.
4. To jump to another letter in the directory, press the numeric key for it. For example, press the “6” key to jump to the M's, N's, and O's. The M's will appear first. Press “6” again to jump to the N's, and again to jump to the O's. (**Note:** This doesn't work for PSD names unless the system is a DBS 824 CPC-M Version 2.0 or higher, which allows up to 40 PSDs.)
  - For names beginning with Q or Z, use the 1 key.
5. When the correct speed-dial or extension name is displayed, you can execute the dialing of its speed-dial or extension number by pressing the select key that points to it (> if the name is displayed on the left; or < if the name is on the right).

- Or, to exit the directory without selecting a number to dial, press the END key or go on-hook.

## Notes

***Incompatibility with older phone versions.*** Directory Mode is available on the 44-Series phones only.

***Hot Dial Pad and Directory Mode.*** The Hot Dial Pad feature (FF3 ExtPort# 48#) will not work on an extension in Directory Mode.

## Variable Mode

### Description

This feature applies to the 44-Series small-display phone only (i.e., phones with a 2-line LCD display).

When the phone is in Variable Mode, the features for Flexible Function Screen select keys 1 and 2 will display during each of the following call states:

<u>Call State</u>	<u>Existing Program Address*</u>
• During an intercom call	FF3 (ExtPort)# 28# (25-39)#
• During CO dial tone	FF3 (ExtPort)# 29# (25-39)#
• During a trunk call	FF3 (ExtPort)# 30# (25-39)#
• After dialing a busy extension	FF3 (ExtPort)# 33# (25-39)#

**\* In these addresses, you assign a Flexible Function Screen (25-39) to appear on the extension while it is in the call state.**

## Operation

The select keys on the 44-Series small-display phone are labeled “>” and “<” to the left and right of the display’s 2nd line. Pressing select key 1 (“>” on the left) or select key 2 (“<” on the right) will perform the displayed feature.

### To use Variable Mode:

1. Activate Variable Mode by pressing **ON/OFF \*61 ON/OFF**.
  - When you dial \*61 in the above sequence, the 1st line of the LCD will display “Variable md ON”. The display will return to normal when you press the second ON/OFF.
  - The \*61 code toggles Variable Mode on and off. Press **ON/OFF \*61 ON/OFF** again to turn Variable Mode off.
2. While the extension is engaged in an intercom call, the 2nd line will display select key 1 and 2 features from the Flexible Function Screen assigned to display in FF3 ExtPort# 28#. The same applies when the extension receives CO dial tone (FF3

ExtPort# 29#); during a trunk call (FF3 ExtPort# 30#); and after dialing a busy extension (FF3 ExtPort# 33#).

- Use existing addresses FF1 2# 7# 1# thru 4# to assign select key features to Flexible Function Screens.
  - Use existing addresses FF1 2# 7# 2# to assign screen text.
  - Select key features for *Fixed* Function Screens will not appear on small-display phones.
3. While the select key feature is displayed, you can execute the feature by pressing the > or < select key.

## Notes

***Toggling Variable Mode On/Off with an FF-Key.*** You can program the \*61 code into an FF-key: In programming mode, press FF5 (ExtPort)# (KeyNo.)# (\*61)#. The FF-key will toggle Variable Mode on/off while the extension is idle or in an off-hook/dial-tone state. The FF-key LED will remain lit (red) while Variable Mode is “On”. (You can also use a one-touch key to toggle Variable Mode on and off; however, one-touch keys do not contain an LED to indicate when Variable Mode is on.)

***Variable Mode After Power-Cycling.*** If Variable Mode is “On”, the extension will stay in Variable Mode even after power-cycling (system is powered down, then powered back up).

***Incompatibility with older phone versions.*** Variable Mode is available on the 44-Series phones only.

***Conditions under which Variable Mode does not work.*** Variable Mode will be temporarily overridden under the following conditions: during an incoming message state, hold state, message-waiting state, or call-waiting state. Incoming messages include:

- CO Queuing
- Incoming [trunk no.]
- REV.[extension no.]
- TRF.[trunk no.]
- H-Recall
- Call Wait
- REC.[trunk no.]
- Recall Hnt [Hunt Group no.]
- DISA Incoming
- Call [extension no.]
- Transf [extension no.]
- Recall [trunk no.]
- HOLD Recall



## Handset Mute

### Description

While using the handset (not on speaker) during a phone conversation, you can press the MUTE key to block audio path to the other party -- you can still hear them, but they can't hear you. This feature is called "Handset Mute."

### Operation

1. To turn on Handset Mute while using the handset, press the MUTE key.
  - The MUTE indicator lamp (LED next to MUTE key) will flash.
  - The handset transmitter will be muted. You will still be able to hear the other party, but they can't hear you.
2. To turn off Handset Mute, do one of the following:
  - press the MUTE key again;
  - press HOLD to place the call on hold;
  - replace the handset on-hook; or
  - press the flashing FF-key to answer another call.
    - Note: This will drop the first call unless Key Bank Hold is enabled (FF1 2# 1# 9#).
  - The MUTE indicator lamp will stop flashing.

### Notes

**Headset Use.** The Handset Mute feature also works if you are using a headset on the phone to handle calls (#51 activates Headset mode).

**Speakerphone Use.** The MUTE key works the same as before (mutes the microphone) when you are on speaker. The MUTE lamp lights steadily when the microphone is muted, and flashes when the handset is muted.

**Handsfree Answerback.** The MUTE key enables or disables Handsfree Answerback the same as before. (Handsfree Answerback allows you to answer intercom calls on speaker, without picking up the handset. While the phone is idle, press the MUTE key to toggle between Handsfree Answerback On and Off. When the MUTE indicator lamp is unlit, Handsfree Answerback is ON. When the lamp is lit, Handsfree Answerback is OFF.)

**Offhook Monitoring.** This feature and Handset Mute can both be ON simultaneously, so that both the speaker and handset transmitters are muted (but the speaker and handset receivers still operate). For more information about Offhook Monitoring, see page AAppendix A:-16 of these Release Notes.

***Barge-Ins During Handset Mute.*** If another phone barges in on your call while Handset Mute is ON, and you change to conference talk (but not by pressing HOLD), Handset Mute will remain ON.

***FF-Key/One-Touch Key Restriction.*** Handset Mute cannot be assigned to an FF-key or a one-touch (soft) key.

## Off-Hook Monitoring

### Description

Off-Hook Monitoring lets you put a call on speaker while the handset is off-hook. You can still communicate with the outside party via the handset, but you will also be able to hear the other party on the phone's speaker. He/she will only be able to hear what is spoken through your handset, however - audio will not be transmitted through your microphone.

### Operation

1. During a call, press the ON/OFF key.
  - Another receiver path is established on the phone's speaker -- you can now hear the outside party on the speaker as well as in the handset.
  - Your phone's microphone is muted so that the outside party hears only what is spoken through your handset. (To mute handset transmission, press MUTE.)
2. To turn off Off-Hook Monitor ("kill" the speaker but stay on the line with the outside party through the handset), press ON/OFF again.

## Analog Adapter

### Description

The Analog Adapter (VB-44100) consists of a base adapter and PC board which is installed on the underside of the phone. It is used to connect the 44-Series large-display phone to an analog device such as an SLT telephone, cordless phone, FAX machine, or modem. This allows the same phone line to be used to alternate between normal phone calls and analog communications. (*To install, see the instructions supplied with VB-44100.*)

### Programming

See *Section 400 - Programming (Appendix C)* for more detailed programming information.

### Operation

The first device to go off-hook will seize the line (off-hook is either lifting the handset or pressing the ON/OFF key). If the analog device goes off-hook first, the large-display phone will be unable to dial or go off-hook.

You can choose which device will ring by going off-hook at either the digital key telephone or the analog device and dialing \*71. The digital key telephone display will reflect “Analog port RING” or “Key Tel RING”, depending on which device is selected - the default is “Key Tel RING”.

You can still *answer* an incoming call from either device, regardless of which device is ringing. For example, if the analog device is ringing, you can pick up the call on the digital key telephone by going off-hook before the analog device does. Similarly, if the digital key telephone is ringing or has not answered a voice call, the analog device can pick up the call by going off-hook first.

You can program the \*71 ring select command into an FF key. Pressing the key toggles between “Analog Port RING” and “Key Tel RING”. When the analog port is set to ring, the FF key LED lights red. When the key telephone is set to ring, the LED is off.

## Notes

### *Phone Restrictions*

- The Analog Adapter will work on the large-display phone only (VB-44225).
- A dial-pulse SLT will not function on the analog port.
- Stutter Dial Tone (indicating Call-Forwarding mode, Do-Not-Disturb mode, etc.) will not function on an SLT connected to the Analog Adapter.
- An analog phone connected to the Analog Adapter cannot program or access speed dials.

### *Incoming Calls*

- You cannot program both devices to ring simultaneously.
- The “\*71” code will not work if the other device is in use.
- The “\*71” code will not work if FF3 (ExtPort)# 51# is set to “0”.
- If set to “Analog port RING”, the large-display phone will work like an SLT/OPX (no page announcements, no voice calls from other extensions, etc.).
- If the phone is in CF/DND (Call-Forward or Do Not Disturb), the phone will remain in CF/DND even if the ringing device is changed via the \*71 code.
- The incoming ring pattern for the analog device is the same as for the digital key telephone (determined by the Extension Ring Pattern in FF3 (ExtPort)# 39# (0-9)#). If this address is set to “0” (determined by CO),

the analog device will automatically default to “1 second ON, 3 seconds OFF.”

**Ring Patterns Not Applicable to Analog Device.** The following ring pattern addresses *will not* affect the analog device:

Analog Transfer Ring Pattern	FF1 2# 1# 31# (0-6)#
SLT DISA Ring Pattern	FF1 2# 1# 34# (0 or 1)#
Inbound Ring Pattern	FF2 (Trunk)# 17# (0-9)#

**Flash Interaction.** Any disconnect signal sent to the analog port must be greater than the SLT Flash Control; otherwise the disconnect signal will be interpreted as a flash and the call will be placed on hold.

**Programming Addresses That Affect the Analog Device.** The following addresses will control the analog device, but will not affect the digital key telephone:

AEC Disconnect Duration	FF1 2# 1# 35# (0-15)#
SLT Flash Control	FF1 2# 1# 11# (0 or 1)#
SLT Onhook Flash Timer	FF1 3# 14# (0-6)#
AEC Disconnect or 1)#	FF3 (ExtPort)# 46# (0 or 1)#
Analog Port on Large-Display Phone or 1)#	FF3 (ExtPort)# 51# (0 or 1)#
Data Security on Analog Port or 1)#	FF3 (ExtPort)# 52# (0 or 1)#

## MSG (Message) Key

### Description

The MSG key on the VB-44225 Large-Display Phone adds the following functionality to the phone:

- **Auto-Callback.** If a callback message has been left by another extension, you can press the MSG key to place an automatic callback to the extension that sent the message. If more than one callback message has been received, pressing the MSG key will perform auto-callback in the order received.
- **Auto-Answer Voice Message.** You can press the MSG key to automatically access your voice mailbox. The phone will dial your voice mailbox and send access codes (if programmed) for retrieving messages.

### Programming

See *Section 400 - Programming (Appendix C)* for more detailed programming information.

**Operation To Program Voice Mailbox Access Codes into the MSG Key:**

Press PROG MSG [16-digit number] HOLD

The display will reflect “Regist Data”.

**To Confirm a Voice Mailbox Access Code Programmed into the Message Key..**

Press CONF MSG.

The programmed access code will be displayed.

**Notes**

***Operation With Message Waiting Indicator.*** The Message Waiting Indicator on the phone’s upper right corner will flash whenever a callback message or voice message has been received.

***Operation During Call States.*** The MSG key will work only when the phone is idle, receiving dial tone, or in Directory Mode (via select key).

***Operation If Phone Has Both a Callback Message from another Extension and a Voice Message.*** Messages are accessed in a First In, First Out order. If the callback message was received before the voice message, then pressing the MSG key will activate Auto-Callback first. Likewise, if the voice message was received before the callback message, pressing the MSG key will access your Voice Mailbox.

***Interaction with Tone-Calling Mode.*** If an Auto-Callback is placed to a phone that is in tone-calling mode (i.e., not voice-calling), that phone must answer or the message canceled before another message can be accessed.

***FF-Key Restriction.*** These MSG features cannot be assigned to an FF-key.

***Reprogramming the MSG key if Extension Number Digits is changed.*** If the DBS is reprogrammed to use a different extension numbering plan (i.e., changed from 2-digit to 3-digit extensions, 3-digit to 4-digit extensions, etc.), the Voice Mailbox Access Code must be reprogrammed into the MSG key.

**DSS/72 Console - Key Arrangement****Description**

The keys on the DSS/72 Console (VB-44320) are arranged differently from the VB-43320 model. The DSS console has 6 columns x 12 rows of keys (not 8 columns x 9 rows as in the previous version). This affects the following:

- **Name and Message Assignments (FF6 addresses).** The alphabetical arrangement of the keys is different.
- **FF-Keys.** The FF-keys on the DSS/72 console are numbered left-to-right, bottom row first.
- **DSS #1 Defaults.** The default extension number assignments on DSS #1 are different.

The DSS key arrangement is shown in Figures A-7 & A-8.

Figure A-7.DSS/72 Console (VB-44320) key layout

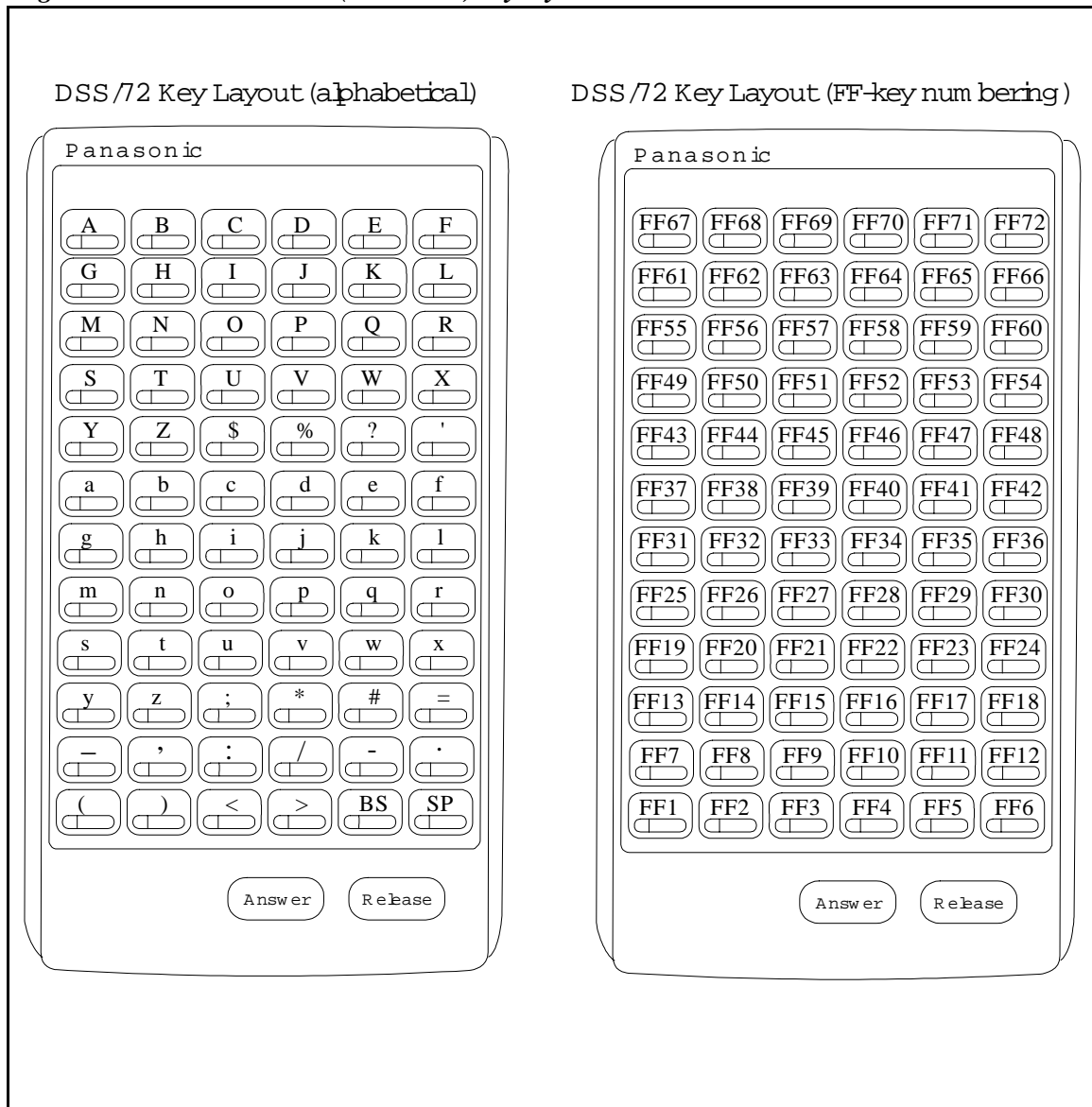

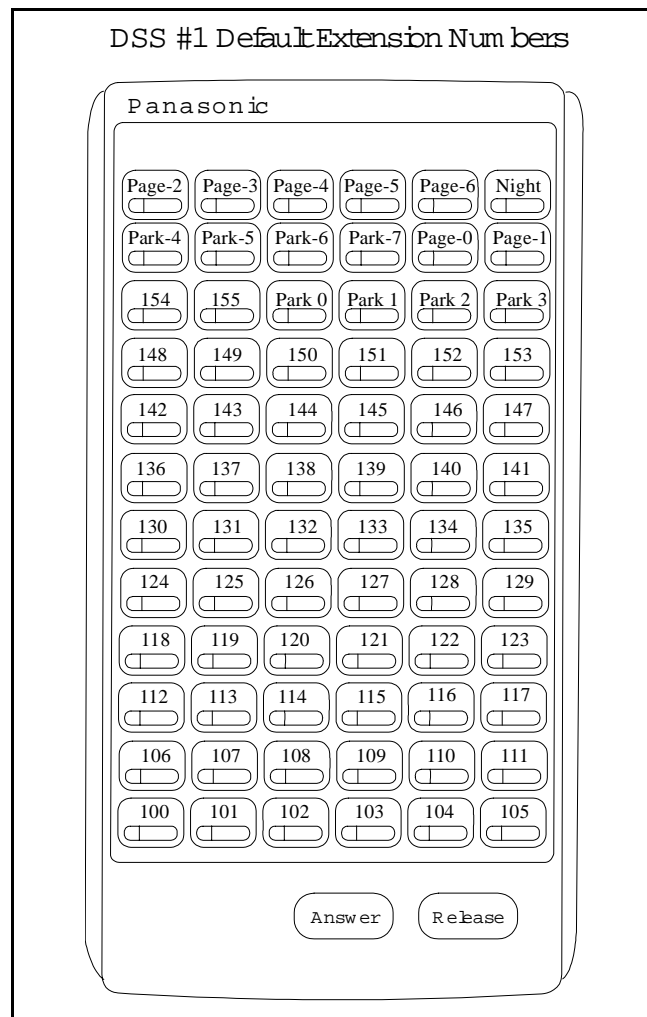
**Figure A-8.DSS/72 #1 Default Extension Numbers**

**Programming** See *Section 400 - Programming (Appendix C)* for more detailed programming information.

**Operation** The 44-Series DSS/72 operates the same as previous models.

### EM/24 - Key Arrangement

**Description** The keys on the EM/24 unit (VB-44310) are arranged differently from the VB-43310 model. The EM/24 unit has 2 columns x 12 rows of keys (not 3 columns x 8 rows as in the previous version). This affects the following:

- **FF-Keys.** The FF-keys on the EM/24 are numbered bottom-to-top, left column first.

The EM/24 key arrangement is shown in Figure A-9.

*Figure A-9.EM/24 Unit (VB-44310) keys*

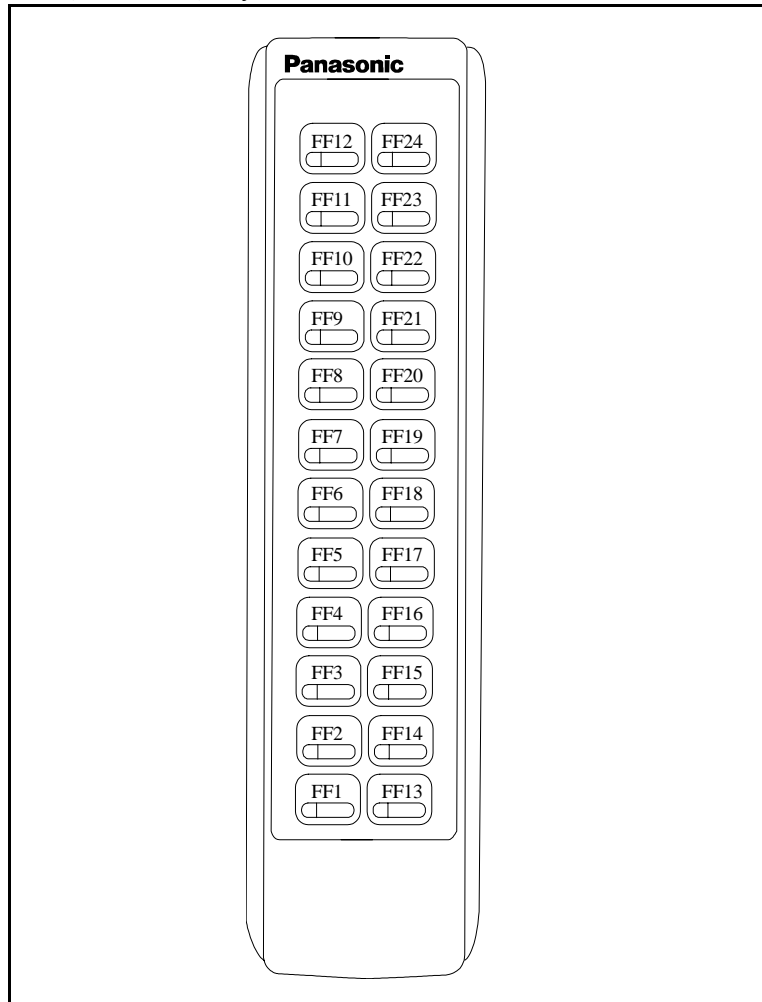

**Programming** See *Section 400 - Programming (Appendix C)* for more detailed programming information.

**Operation** The 44-Series EM/24 operates the same as previous models.

---

## Speed-Dial Enhancements

**Description** The CPC-EX supports up to 500 SSD numbers (code range 000-499) for each system, and up to 10 PSD numbers (code range 900-909) for each extension.



With CPC-EX, you can chain up to 4 SSD codes together within a fifth SSD number. You can also chain up to 4 SSD or PSD codes together within a fifth PSD number. You can include both speed-dial codes and regular dialed numbers into the same speed-dial number.

The maximum length of any speed-dial number is still 16 digits.

## Programming

See *Section 400 - Programming (Appendix C)* for more detailed programming information.

## Notes

### 1) Chain-Dialing Limitations and Restrictions:

- You cannot chain-dial any PSD codes within an SSD number, because the system would not be able to choose which extension to take the PSD code from (the same PSD code might exist on multiple extensions).
- You cannot “chain-within-a-chain”. For example:
  - SSD Code 001 = AUTO 002(will not dial out; returns busy tone instead)
  - SSD Code 002 = AUTO 003(will dial out)
  - SSD Code 003 = 555-1212(will dial out)(the above restriction applies to PSD codes as well)
- You cannot chain-dial PSD or SSD codes if they are both included in each other’s speed-dial number. For example:
  - SSD Code 000 = AUTO 001(will not dial out; returns busy tone instead)
  - SSD Code 001 = AUTO 000(will not dial out; returns busy tone instead)

### 2) The programming address for SSD Display Restriction (FF1 2# 1# 5# [0 or 1]#) affects SSD codes 400-499.

- If disabled (i.e., set to “0”), the numbers assigned to SSD codes 400-499 will display during dialing. The default is “0”.
- If enabled (set to “1”), the numbers assigned to SSD codes 400-499 will not display during dialing.
- Numbers associated with SSD codes 000-399 will always display during dialing.

# Additional Serial Port on CPC Card

## Description

The CPC-EX card contains an on-board serial port (Serial Port 2) which can be used for Bus Monitor/ Remote Maintenance. This serial port (labeled CN5) is located just above the LEDs on the front of the card (see the illustration on Appendix A:-4). This additional serial port allows you to dial directly into the system for remote maintenance, without having to disconnect the SMDR cabling from the backplane serial port (Serial Port 1).

- Serial Port 1 (the backplane port) and Serial Port 2 have separate controls for baud rate, stop bit, parity, and data length

## Installation

Serial Port 2 requires the CPC-EX Serial Port Adapter Cable (VB-43890). This cable connects to Serial Port 2 via a 10-pin connector, and to a programming terminal via a DB25 connector.

Figure A-10.CPC-EX Serial Port 2

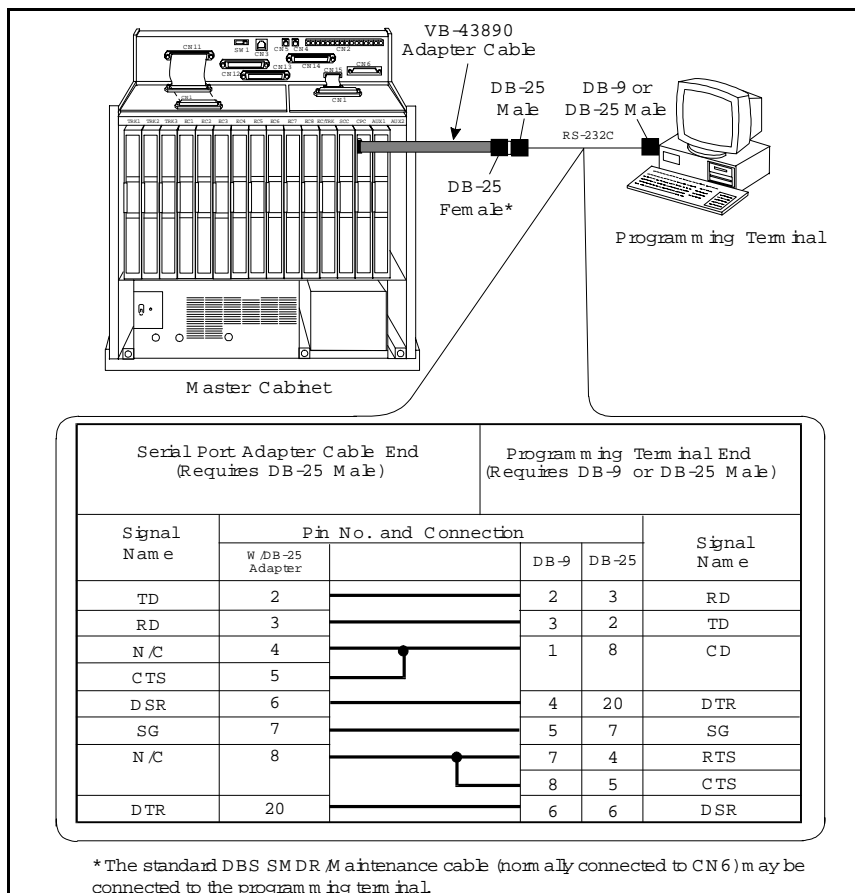

**Programming** See *Section 400 - Programming (Appendix C)* for more detailed programming information.

## Notes

- Serial Port 2 requires a special interface cable.
- Serial Port 2 can be used for Bus Monitor/Maintenance only. You must continue to use the backplane port (Serial Port 1) for SMDR.
- Port selections are made from the Attendant phone as follows:

	<i>to set Serial Port 1 for...</i>	<i>and Serial Port 2 for...</i>
dial #90	Bus Monitor/Maintenance	no output
dial #92	SMDR	Bus Monitor/Maintenance
dial #93	SMDR/Maintenance	no output

- When Serial Port 2 is used (i.e., #92 has been entered), the internal RAI modem cannot be accessed.

## T1 Networking

*NOTE: The following information covers T1 Networking features that directly affect CPC-EX operation. For detailed information regarding T1 Networking, see "T1 Networking Reference Guide", Part No.550X10001, Section 540.*

CPC-EX allows up to 4 DBS's to be connected together via T1 interface to form a DBS phone network. Such a network provides the following features:

- Network Extension to Extension Calling
- Call Forwarding to Network Extensions
- Paging across Network nodes
- Network Route selection
- Remote DBS CO Access
- SMDR Network Support
- Independent Node Attendant Assignment

These feature are described in greater detail in the following sections.

## Hardware Requirements

Each site (node) must contain the following hardware:

- CPC-EX

- SCC-B
- T1 Trunk Card
- T1 MDF
- T1 Sync Unit
- External CSU (not provided by Panasonic)

The maximum number of nodes which can be connected together is 4. Each node can be either a single or double DBS cabinet configuration. The connection between these systems is accomplished via T1 talk paths, with the quantity determined during installation.

## Network Extension to Extension Calling

Networked DBS's use a 4-digit extension numbering plan. The first digit determines the node being called. For example:

- Node 1 - leading digit 1
- Node 2 - leading digit 2
- Node 3 - leading digit 3
- Node 4 - leading digit 4

*Figure A-11. T1 Network Extension Numbering*

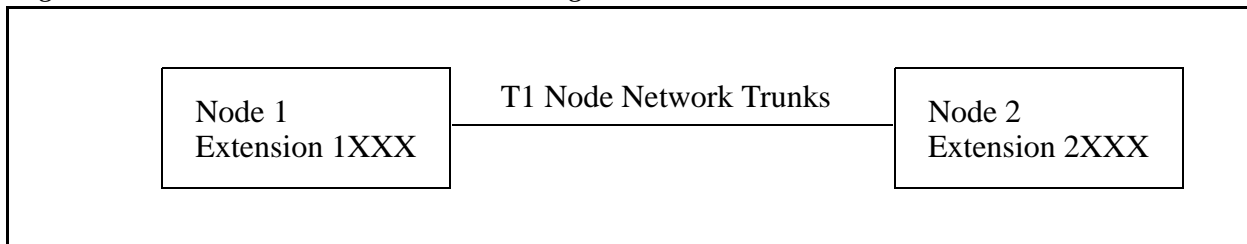

When an extension in one node is called via the intercom from an extension in a different node, the called extension rings - Intercom Voice Calling and OHVA do not work when calling from one node to another.

The DBS determines how to route the calls based on the network trunk group priorities established during programming. To allow optimum flexibility in a 4-node network, up to 3 different trunk group priorities can be established.

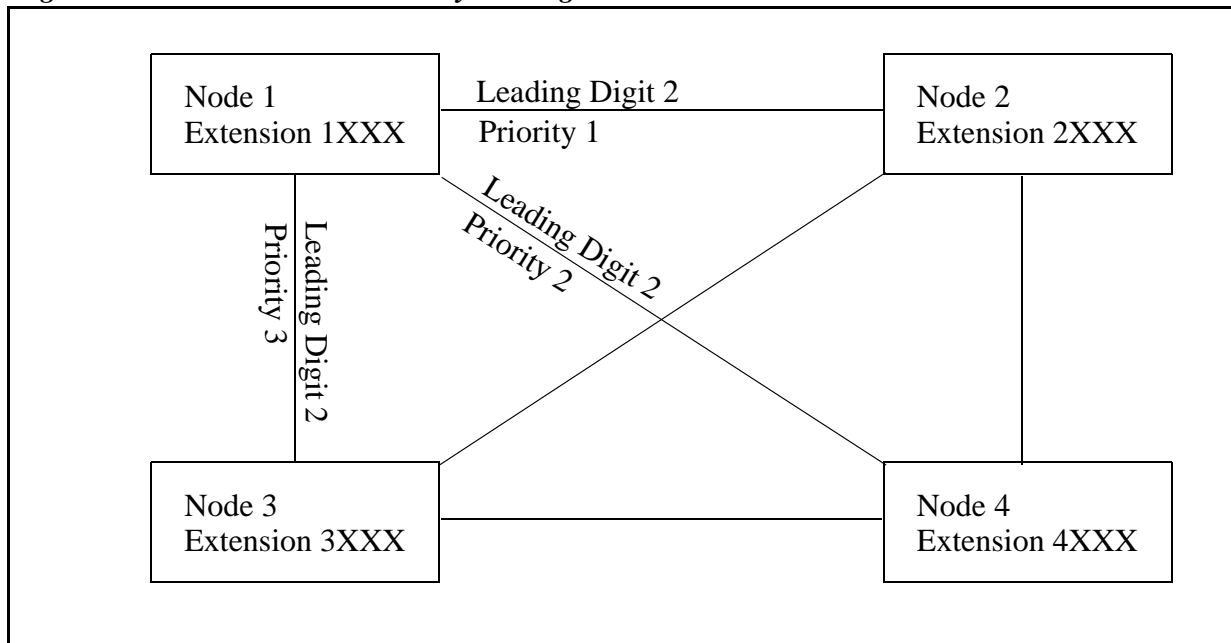
**Figure A-12.T1 Network Call Priority Routing**

## Call Forwarding to Network Extensions

Any call can forward to an extension on any node by assigning the targeted extension number in a Personal Speed Dial bin. To establish the call forward setting, the user follows normal call forwarding settings and uses the (AUTO)XXX personal speed dial number entry.

## Paging Across Network Nodes

Every node can allow or deny network paging for each class of service.

## Network Route Selection

An enhanced option is available for Forced Least Cost Routing to include network route selection. This option provides 50 6-digit entries which determine how dialed numbers are routed through the network for optimal cost performance.

For example, if Node 1 of a networked system is in the 201 area code and Node 2 is in the 212 area code, all calls from Node 1 to the 212 area code or surrounding area codes can be routed through the second node to the public network.

## Remote CO Access

End users in one node can also place calls manually through a distant node by dialing the node number followed by a trunk group (9).

## SMDR Network Support

Enhanced options are available in CPC-EX to support call accounting in networked systems. These options are:

Specifying the call record to be printed. A field has been added:

### **FF1 2# 2# 6# (2#) - Incoming, Outgoing, Network**

In the actual SMDR record output, network traffic will be indicated by the following record types:

W = CO Outgoing to Network  
w = CO Incoming from Network  
t = Network Transfer

The following data output is found in the extension number field:

#01-#64 - Network trunk number

## Independent Node Attendant Assignment

A central network operator can be assigned for Dial 0 access from any node. Each node can independently designate a network attendant. For example, Nodes 1, 2 & 3 can send Dial 0 calls to the attendant on Node 1, while Node 4 sends Dial 0 calls to its local attendant.

---

## Settings Modified for Networking

The following programming addresses have been modified to add parameters necessary for T1 networking. (*See the T1 Networking Reference Manual for complete instructions*)

## Extension Number Digits

### **Description**

The CPC-EX card allows a 4-digit extension numbering plan to be used on networked DBS systems. The first digit of the extension determines on which DBS the extension is located - for example, extension 1321 will be on DBS 1, while extension 2547 will be on DBS 2. Each DBS routes calls based on the leading digit of the dialed extension.

A DBS operating in a network environment must use the 4-digit extension numbering plan. Stand-alone (non-networked) DBS systems, however, must continue to use 2 or 3 digit extensions.

**Programming** See *Section 400 - Programming (Appendix C)* for more detailed programming information.

## SMDR Printing Mode 1: Outbound and Inbound

**Description** SMDR data sent to Serial Port 1 can now include Network Calls also.

**Programming** See *Section 400 - Programming (Appendix C)* for more detailed programming information.

## T1 Trunk Type

**Description** The setting for T1 Trunk Type now includes a parameter for E&M Network.

**Programming** See *Section 400 - Programming (Appendix C)* for more detailed programming information.

## Extension Numbers

**Description** The address for extension number assignments has been modified to allow for 4-digit extensions.

## Forced LCR/NRS

**Description** The address for Forced Least Cost Routing has been modified to include Network Node Route Selection (NRS).

**Programming** See *Section 400 - Programming (Appendix C)* for more detailed programming information.

---

## Other Changes to Programming Addresses

Flexible Function Screen Soft-Key Assignments (FF1 2# 7# 25-39# (1-10)# (xxxxxxx)#) and FF Key Assignments have been modified to allow up to 8-digit entries.

## Enhanced Programming Addresses

Enhanced programming addresses have been added to support T1 Networking. These addresses are applicable only in a networked environment and can be ignored in a stand-alone (non-networked DBS). Refer to the T1 Networking Reference Guide for detailed information.

---

## Modification to Toll Restriction Service

**Description** The program address for TRS Operator Access (FF7 1# 18#...) has been modified to allow an extension to dial “0+NXX” phone numbers, even if “0-only” dialing is denied.

Four settings are possible.

**Programming** See *Section 400 - Programming (Appendix C)* for more detailed programming information.

### Notes

- The Operator Access address applies only to DBS systems using the (1995) NANP dialing plan (FF7 1# 17# 1#), and to TRS types 2-6 (TRS types 0 and 1 do not allow outbound dialing; TRS type 7 allows all dialing).
- If “0-only”, “00-only”, “10XXX0-only”, or “101XXXX0-only” calls are restricted (settings 0 or 2), the system will wait 6 seconds before automatically disconnecting the call. However, if the user dials additional digits within 6 seconds, the DBS will check other switches to determine whether to allow or deny the call.
- For all settings (0-3), the system will check the Equal Access Code Format switch (FF7 1# 21#...) if a CIC (carrier identification code) is dialed to reach a preferred inter-exchange carrier.
- For all settings (0-3), the system will check the international calls switches (FF7 1# 1# and FF7 1# 19#) if “01”, “10XXX01”, or “10XXXX01” is dialed.
- For settings 2 and 3, the system will not consider TRS settings for the trunk.



---

## Maximum Time Priority Route Tables

### Description

CPC-EX allows a maximum of 8 Time Priority Route Tables to be used during LCR programming. (CPC-AII/B allows a maximum of 16 Time Priority Route Tables. This number is reduced with CPC-EX since very few systems require more than 3 of these tables and the saved memory space will allow for a planned future enhancement.)

The DBS uses Time Priority Route Tables to route calls to the least expensive carrier based on the time of day the call is placed. The following program addresses use Time Priority Route Tables:

- FF8 1#...LCR Area Codes
- FF8 2#...LCR Office Codes
- FF8 4#...Special LCR Office Code Tables
- FF8 5#...Time Priority Route Tables

---

## ISDN Support

### Description

CPC-EX supports ISDN-PRI (Integrated Services Digital Network -- Primary Rate Interface). This ISDN Interface provides 23 voice channels ("B" channels) and a control channel ("D" channel) over a 4-wire circuit.

One program address, for Trunk Circuit Type (FF2 (trunk #)# 21#), has been modified to allow for ISDN. This modification is described below. In addition, CPC-EX provides several additional programming addresses to support ISDN. The additional program addresses, as well as additional detail on ISDN, are described in the *ISDN Reference Manual, Part No. 504X00301A, Section 530*.

## Hardware Requirements

The following are the minimum hardware requirements for ISDN support in the DBS:

- ISDN Trunk Card (VB-43571)
- CPC-EX (VB-43415)
- SCC-B (VB-43421) (with ROM 1.3 or later)
- MDF Card (VB-43562)

- Sync Unit (VB-43563)
- External CSU (not provided by Panasonic)

## Setting Modified for ISDN

**Programming** See *Section 400 - Programming (Appendix C)* for more detailed programming information.

---

## Modifications to SMDR

**Description** Station Message Detail Recording (SMDR) provides detailed call records of outgoing calls. SMDR records can be output to a printer or an external call accounting system. Additional call record types have been added to the SMDR feature to support network calls and ISDN calls.

Figure A-13 shows the SMDR format for CPC-EX. Enhanced values added for CPC-EX are shaded.

Figure A-13.SMDR Format for CPC-EX

0	1	2	3	4	5	6	7	
01234567890123456789012345678901234567890123456789012345678901234567								
1	2	3	4	5	6	7	8	9
T	MM/DD	HH:MM:SS	HH:MM:SS	NNN	DDDDDDDDDDDDDDDDDDDDDDDDDDDDDDDDDDDD	AAAAAAAAAA	VVVVV	NN
1=Call type					5=Extension number (or network trunk)			
S=Inbound DISA					10-69, 100-699=extensions			
s=Outbound DISA					CO number=DISA			
I=Incoming					n01-n04=virtual port 1 to 4			
O=Outgoing					#01-#64=network trunk number			
T=Transfer (See Note 1)								
N=DNIS					6=Dialed digits, Caller ID or ANI			
D=DID					DD=digits 0-9 or symbols * or #			
W=CO outgoing to Network					(See Note 2)			
w=CO incoming from network								
t=Network Transfer					7=Account code			
r=ISDN incoming call					A=0-9999999999			
R=ISDN outgoing call								
2=Date					8=Verified account code or walking			
MM=month					COS code			
DD=day					V0000-V9999=verified account codes			
					W0000-W9999=walking COS codes			
3=Call start time					9=Trunk Number			
HH=hours					NN=number (01-64)			
MM=minutes								
SS=seconds								
4=Call duration								
HH=hours								
MM=minutes								
SS=seconds								
Notes:								
1. Transferred calls include direct and group call pickups and conference calls.								
If a station call is transferred to an outside number, an SMDR record is also created for the station that is transferred.								
2. The * symbol appears as a greater-than sign (>) on the SMDR printout; the # symbol appears as a less-than sign (<). Centrex and PBX codes, as well as LCR access codes, do not appear as dialed digits. If the Caller ID Feature is installed and enabled, "Private" appears with calls that have restricted Caller ID display and "Out of Area" with long distance calls that do not provide Caller ID information.								

## Setting Modified for SMDR

Values have been redefined for the SMDR Start Timer. The following table shows the enhanced values.

**Note:** These values apply to CPC-EX only.

**Programming** See *Section 400 - Programming (Appendix C)* for more detailed programming information.

## ***Related Programming***

- FF1 (System): SMDR Print
- FF1 (System): Parity Check
- FF1 (System): Odd/Even Parity
- FF1 (System): Baud Rate
- FF1 (System): Stop Bit Length
- FF1 (System): Data Length
- FF1 (System): Serial Port Flow Control (X On/ X Off)
- FF1 (System): SMDR Display Start Timer for CO Calls
- FF1 (System): SMDR Printing Mode 1: Outbound, Inbound, Network
- FF1 (System): SMDR Printing Mode 2: Long Distance and Local Calls
- FF1 (System): SMDR Printing Mode 3: Header Title
- FF3 (Extension) Station Message Detail Recorder (SMDR) Report

## ***Hardware Requirements***

- A printer or external call accounting system is required to receive SMDR data.

## ***Considerations***

- Unlike other CPC circuit cards, the CPC-EX supports two serial ports. Serial Port 1 is labeled **CN4** and is located on the backplane. Serial Port 2 is labeled **CN5** and is located on the front of the CPC-EX card. Serial Port 2 requires a special interface cable.
- Be sure to select the correct port to output SMDR data. From the Attendant's phone:
  - dial **#90** to set Serial Port 1 (the backplane port) to output Bus Monitor/Maintenance and Serial Port 2 to no output.
  - dial **#92** to set Serial Port 1 to output SMDR and Serial Port 2 to output Bus Monitor/Maintenance data.
  - dial **#93** to set Serial Port 1 to output SMDR data and Serial Port 2 to no output.

---

## Modification to T1 Signaling Types

**Description**      The default values for T1 Incoming and Outgoing Signal Types have been changed to set “Wink Start” as the default. This will allow easier programming of E&M trunks.

### Outgoing Signaling Type

**Programming**      See *Section 400 - Programming (Appendix C)* for more detailed programming information.

### Incoming Signaling Type

**Programming**      See *Section 400 - Programming (Appendix C)* for more detailed programming information.

*(This page left blank intentionally)*

---

## Appendix B: CPC-AII/B 8.0 Updates

CPC-AII/B Version 8.0 offers support for the Panasonic 44-Series telephones (VB-44xxx), as well as Computer Telephony Integration (CTI) through the Windows™ Telephony Applications Processing Interface (TAPI).

---

## Contents

Topic	Page
<b>44-Series Phone Support</b>	B-3
Enhanced Phone Features	B-4
Directory Mode	B-8
Variable Mode	B-9
Handset Mute	B-11
Off-Hook Monitoring	B-12
Separate Speaker Volumes for Internal vs. CO calls	B-12
Analog Adapter	B-13
MSG (Message) Key	B-15
DSS/72 Console - Key Arrangement	B-16
EM/24 - Key Arrangement	B-19
<b>Modification to Toll Restriction Service</b>	<b>B-20</b>
<b>TAPI Support</b>	<b>B-21</b>
<b>Key Telephone Installation Notes</b>	<b>B-21</b>



## 44-Series Phone Support

CPC-AII/B Version 8.0 provides full support for Panasonic's 44-Series phones (VB-44xxx). Table D-1, below, lists all 44-Series phone models and their part numbers. Most models are available in two colors: gray and black.

*Table B-1.44-Series Phones*

16-Key Phone (gray)	VB-44210G
16-Key Phone (black)	VB-44210B
16-Key Speakerphone (gray only)	VB-44211G
22-Key Phone (gray only)	VB-44220G
22-Key Small-Display Speakerphone (gray)	VB-44223G
22-Key Small-Display Speakerphone (black)	VB-44223B
34-Key Small-Display Phone (gray only)	VB-44230G
34-Key Small-Display Speakerphone (gray)	VB-44233G
34-Key Small-Display Speakerphone (black)	VB-44233B
22-Key Large-Display Speakerphone (gray)	VB-44225G
22-Key Large-Display Speakerphone (black)	VB-44225B
DSS/72 Console (gray)	VB-44320G
DSS/72 Console (black)	VB-44320B
EM/24 Unit (gray)	VB-44310G
EM/24 Unit (black)	VB-44310B

# Enhanced Phone Features

Enhanced DBS features that can be executed on the 44-Series phones are described below:

**Note:** The features introduced with these phones are supported by CPC-AII/B Version 8.0, CPC-S/M Version 2.0, and CPC-EX Version 1.0. You can also use the 44-Series phones with previous DBS versions, but the enhanced features won't be supported.

*Figure B-14.44-Series Small-Display Phone*

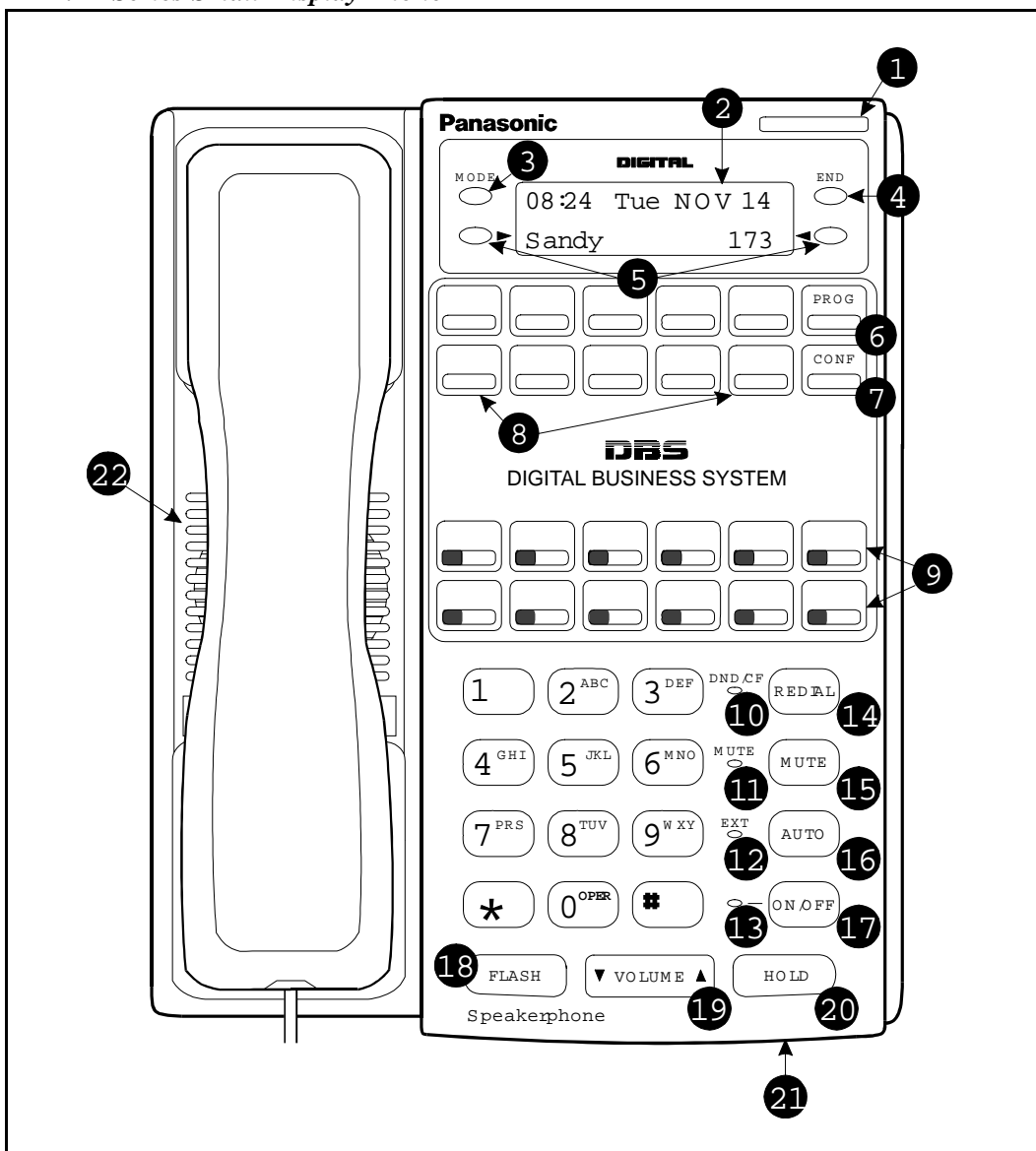

**Table B-2. Key to 44-Series Small-Display Phone**

#	Feature	Description
1	Message Indicator	Indicates that you have a message.
2	Display	Displays information about phone's status, menus, dialing directories, and text message information.
3	Mode Key	Used to change display modes from default to directory mode.
4	End Key	Used to exit directory mode and return display to default mode.
5	Select Keys	Used to select and dial a System Speed Dial, Personal Speed Dial, or Extension number from a directory.
6	PROG Key	Used to program FF and one-touch keys and to adjust ringer volume. Depending on the setup of your system, may also be used to transfer calls.
7	CONF Key	Used to establish conference calls, check FF key and one-touch features, and scroll through messages.
8	One-Touch Keys	Used to make outside calls or to access call-handling features.
9	Flexible Function (FF) Keys	Used to access outside lines or to access call-handling features.
10	DND/CF Indicator	Indicates that Do-Not-Disturb, Call Forwarding, or Absence Message is set.
11	MUTE Indicator	Indicates that your voice is muted - i.e., party on the other end cannot hear you. Lights solid when your hands-free microphone is muted and flashes when your handset is muted.
12	EXT Indicator	Lights when you are on a call; flashes when you hold a call.
13	ON/OFF Indicator	Lights when ON/OFF key has been pressed.
14	REDIAL Key	Used to redial last outside number dialed.
15	MUTE Key	Used to activate/deactivate MUTE function. When activated, the party on the other end cannot hear you. (See item 11, MUTE Indicator.)
16	AUTO Key	Used to access speed dialing, enter account codes, or for message waiting answer/cancel.
17	ON/OFF Key	Used to make a call without lifting handset.
18	FLASH Key	Used to end an outside call and to restore dial tone without hanging up receiver.
19	VOLUME Key	Used to adjust level of tones, background music, ringing, receiver volume, and display contrast.
20	HOLD Key	Used to hold calls, to retrieve held calls, and to complete FF key programming.
21	Microphone	Used to talk with other party without using the handset.
22	Speaker	Outputs tones and voice at your extension.

Figure B-15.44-Series Large-Display Phone

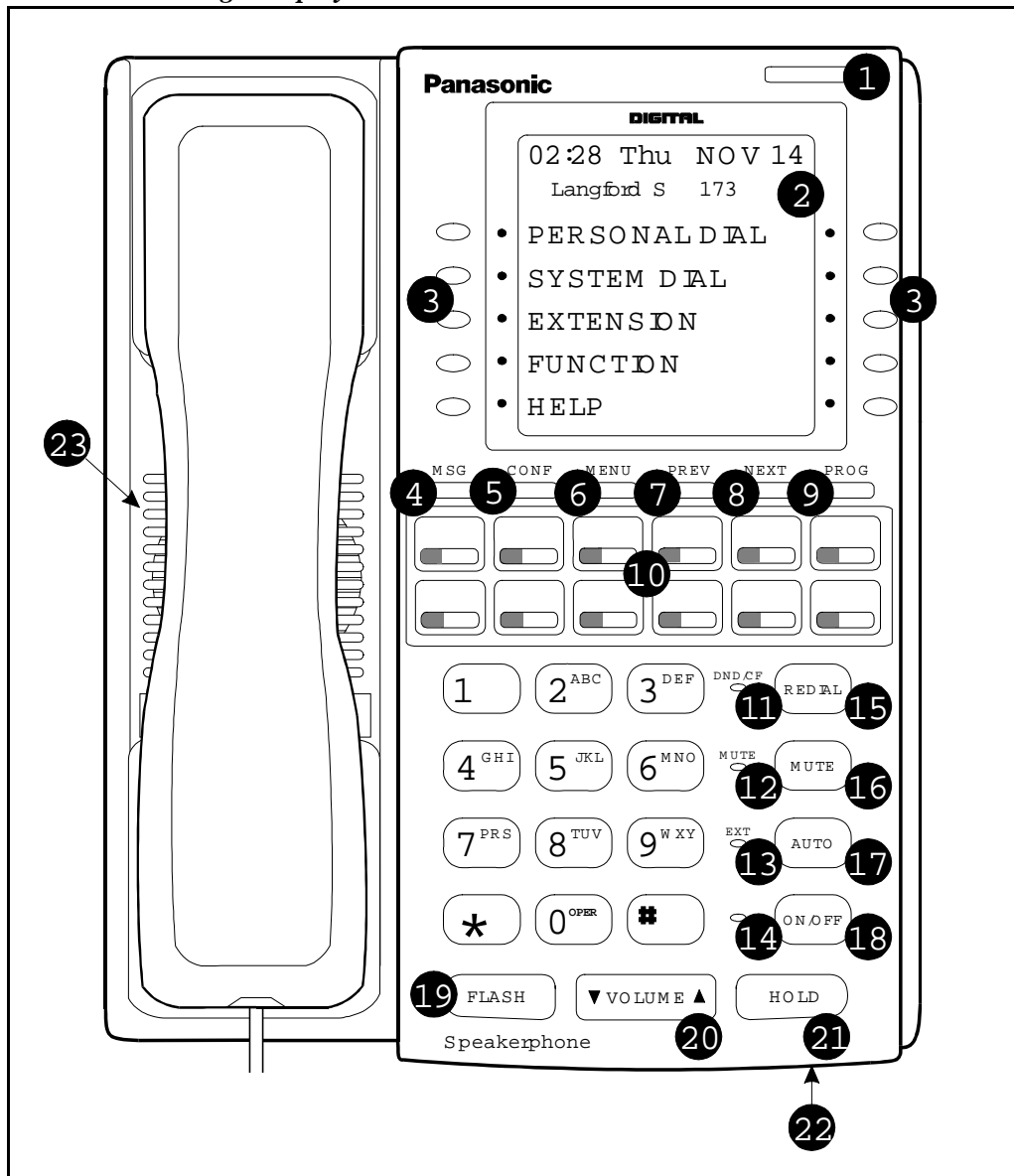

Table B-3.Key to 44-Series Large-Display Phone

#	Feature	Description
1	Message Indicator	Indicates that you have a message.
2	Display	Displays information about phone's status, menus, dialing directories, and text message information.
3	Soft Keys	Used to make outside calls or to access call-handling features.
4	MSG Key	Used for Auto-CallBack to a telephone which has left a text message or to access voice messages.
5	CONF Key	Used to establish conference calls, check FF and one-touch key settings, and scroll through messages.

#	Feature	Description
6	MENU Key	Used to return to the Main Menu screen. The default Main Menu screen contains the following items: <ul style="list-style-type: none"> <li>• PERSONAL DIAL</li> <li>• SYSTEM DIAL</li> <li>• EXTENSION</li> <li>• FUNCTION</li> <li>• HELP</li> </ul>
7	PREV Key	Used to return to the previous menu.
8	NEXT Key	Used to advance to the next menu.
9	PROG Key	Used to program FF and one-touch keys and to adjust ringer volume. Depending on the setup of your system, may also be used to transfer calls.
10	Flexible Function (FF) Keys	Used to access outside lines or to access call-handling features.
11	DND/CF Indicator	Indicates that Do-Not-Disturb, Call Forwarding, or Absence Message is set.
12	MUTE Indicator	Indicates that your voice is muted - i.e., party on the other end cannot hear you. Lights solid when your hands-free microphone is muted and flashes when your handset is muted.
13	EXT Indicator	Lights when you are on a call; flashes when you hold a call.
14	ON/OFF Indicator	Lights when ON/OFF key has been pressed.
15	REDIAL Key	Used to redial last outside number dialed.
16	MUTE Key	Used to activate/deactivate MUTE function. When activated, the party on the other end cannot hear you. (See item 12, MUTE Indicator.)
17	AUTO Key	Used to access speed dialing, enter account codes, or for message waiting answer/cancel.
18	ON/OFF Key	Used to make a call without lifting handset.
19	FLASH Key	Used to end an outside call and to restore dial tone without hanging up receiver.
20	VOLUME Key	Used to adjust level of tones, background music, ringing, receiver volume, and display contrast.
21	HOLD Key	Used to hold calls, to retrieve held calls, and to complete FF key programming.
22	Microphone	Used to talk with other party without using the handset.
23	Speaker	Outputs tones and voice at your extension.

## Directory Mode

*44-Series phones only*

*CPC-AII/B Version 8.0, CPC-S/M Version 2.0, or CPC-EX Version 1.0 only*

### Description

On the small-display phones, you can use the phone's select keys (as well as other keys) to scroll through a directory of existing System Speed Dial (SSD) names, Personal Speed Dial (PSD) names, or extension names -- and select one to dial. For example, if you can't remember the party's extension number or speed-dial number to which you want to transfer a call on hold, you can use Directory Mode to find the number and execute the transfer.

*Note:* This feature applies to the 44-Series small-display phone only (i.e., phones with a 2-line LCD display).

### Operation

The select keys on the 44-Series small-display phone are located next to the display's 2nd line. Pressing select key 1 (“>” on the left) or select key 2 (“<” on the right) will access the displayed directory.

#### To use Directory Mode:

1. Press the MODE key to turn Directory Mode on. The 2nd line of the LCD will display “SSD” on the left and “PSD” on the right.
  - Press the MODE key again to access the directory for extension names. The 2nd line of the LCD will display “EXT” on the left.
2. Press the > select key to access the directory of existing SSD or EXT names; or the < select key to access the PSD directory. The 2nd line will show two speed-dial or extension names at a time (the first 7 characters of each name), beginning with the A's.
3. To scroll through the names (two at a time), press the # key. To back-scroll, press the \* key.
4. To jump to another letter in the directory, press the numeric key for it. For example, press the “6” key to jump to the M's, N's, and O's. The M's will appear first. Press “6” again to jump to the N's, and again to jump to the O's. (*Note:* This doesn't work for PSD names unless the system is a DBS 824 CPC-M Version 2.0 or higher, which allows up to 40 PSDs.)
  - For names beginning with Q or Z, use the 1 key.
5. When the correct speed-dial or extension name is displayed, you can execute the dialing of its speed-dial or extension number by pressing the select key that points to it (> if the name is displayed on the left; or < if the name is on the right).

- Or, to exit the directory without selecting a number to dial, press the END key or go on-hook.

## Notes

**Available on small-display phones only.** This feature applies to the 44-Series small-display phone only (i.e., phones with a 2-line LCD display).

**Incompatibility with older phone versions.** Directory Mode is available on the 44-Series phones only.

**Hot Dial Pad and Directory Mode.** The Hot Dial Pad feature (FF3 ExtPort# 48#) will not work on an extension in Directory Mode.

## Variable Mode

**44-Series phones only**

**CPC-All/B Version 8.0, CPC-S/M Version 2.0, or CPC-EX Version 1.0 only**

## Description

This feature applies to the 44-Series small-display phone only (i.e., phones with a 2-line LCD display).

When the phone is in Variable Mode, the features for Flexible Function Screen select keys 1 and 2 will display during each of the following call states:

<b><u>Call State</u></b>	<b><u>Existing Program Address*</u></b>
• During an intercom call	FF3 (ExtPort)# 28# (25-39)#
• During CO dial tone	FF3 (ExtPort)# 29# (25-39)#
• During a trunk call	FF3 (ExtPort)# 30# (25-39)#
• After dialing a busy extension	FF3 (ExtPort)# 33# (25-39)#

**\* In these addresses, you assign a Flexible Function Screen (25-39) to appear on the extension while it is in the call state.**

## Operation

The select keys on the 44-Series small-display phone are labeled “>” and “<” to the left and right of the display’s 2nd line. Pressing select key 1 (“>” on the left) or select key 2 (“<” on the right) will perform the displayed feature.

### To use Variable Mode:

1. Activate Variable Mode by pressing **ON/OFF \*61 ON/OFF**.
  - When you dial \*61 in the above sequence, the 1st line of the LCD will display “Variable md ON”. The display will return to normal when you press the second ON/OFF.
  - Use existing addresses FF1 2# 7# 2# to assign screen text.

- The \*61 code toggles Variable Mode on and off. Press **ON/OFF \*61 ON/OFF** again to turn Variable Mode off.
2. While the extension is engaged in an intercom call, the 2nd line will display select key 1 and 2 features from the Flexible Function Screen assigned to display in FF3 ExtPort# 28#. The same applies when the extension receives CO dial tone (FF3 ExtPort# 29#); during a trunk call (FF3 ExtPort# 30#); and after dialing a busy extension (FF3 ExtPort# 33#).
    - Use existing addresses FF1 2# 7# 1# thru 4# to assign select key features to Flexible Function Screens.
    - Select key features for *Fixed* Function Screens will not appear on small-display phones.
  3. While the select key feature is displayed, you can execute the feature by pressing the > or < select key.

## Notes

***Toggle Variable Mode On/Off with an FF-Key.*** You can program the \*61 code into an FF-key: In programming mode, press FF5 (ExtPort)# (KeyNo.)# (\*61)#. The FF-key will toggle Variable Mode on/off while the extension is idle or in an off-hook/dial-tone state. The FF-key LED will remain lit (red) while Variable Mode is “On”. (You can also use a one-touch key to toggle Variable Mode on and off; however, one-touch keys do not contain an LED to indicate when Variable Mode is on.)

***Variable Mode After Power-Cycling.*** If Variable Mode is “On”, the extension will stay in Variable Mode even after power-cycling (system is powered down, then powered back up).

***Incompatibility with older phone versions.*** Variable Mode is available on the 44-Series phones only.

***Conditions under which Variable Mode does not work.*** Variable Mode will be temporarily overridden under the following conditions: during an incoming message state, hold state, message-waiting state, or call-waiting state. Incoming messages include:

- CO Queuing
- Incoming [trunk no.]
- REV.[extension no.]
- TRF.[trunk no.]
- H-Recall
- Call Wait
- REC.[trunk no.]
- Recall Hnt [Hunt Group no.]
- DISA Incoming
- Call [extension no.]
- Transf [extension no.]
- Recall [trunk no.]
- HOLD Recall



## Handset Mute

*44-Series phones only*

*CPC-AII/B Version 8.0, CPC-S/M Version 2.0, or CPC-EX Version 1.0 only*

### Description

While using the handset (not on speaker) during a phone conversation, you can press the MUTE key to block audio to the other party -- you can still hear them, but they can't hear you. This feature is called "Handset Mute."

### Operation

1. To turn on Handset Mute while using the handset, press the MUTE key.
  - The MUTE indicator lamp (LED next to MUTE key) will flash.
  - The handset transmitter will be muted. You will still be able to hear the other party, but they can't hear you.
2. To turn off Handset Mute, do one of the following:
  - press the MUTE key again;
  - press HOLD to place the call on hold;
  - replace the handset on-hook; or
  - press the flashing FF-key to answer another call.
    - Note: This will drop the first call unless Key Bank Hold is enabled (FF1 2# 1# 9#).
  - The MUTE indicator lamp will stop flashing.

### Notes

**Headset Use.** The Handset Mute feature also works if you are using a headset on the phone to handle calls (#51 activates Headset mode).

**Speakerphone Use.** The MUTE key works the same as before (mutes the microphone) when you are on speaker. The MUTE lamp lights steadily when the microphone is muted, and flashes when the handset is muted.

**Handsfree Answerback.** The MUTE key enables or disables Handsfree Answerback the same as before. (Handsfree Answerback allows you to answer intercom calls on speaker, without picking up the handset. While the phone is idle, press the MUTE key to toggle between Handsfree Answerback On and Off. When the MUTE indicator lamp is unlit, Handsfree Answerback is ON. When the lamp is lit, Handsfree Answerback is OFF.)

**Offhook Monitoring.** This feature and Handset Mute can both be ON simultaneously, so that both the speaker and handset transmitters are muted (but the speaker and handset receivers still operate). For more information about Offhook Monitoring, see Appendix B:-12 of these Release Notes.

**Barge-Ins During Handset Mute.** If another phone barges in on your call while Handset Mute is ON, and you change to conference talk (but not by pressing HOLD), Handset Mute will remain ON.

***FF-Key/One-Touch Key Restriction.*** Handset Mute cannot be assigned to an FF-key or a one-touch (soft) key.

## **Off-Hook Monitoring**

***44-Series phones only***

***CPC-AII/B Version 8.0, CPC-S/M Version 2.0, or CPC-EX Version 1.0 only***

### **Description**

Off-Hook Monitoring lets you put a call on speaker while the handset is off-hook. You can still communicate with the outside party via the handset, but you will also be able to hear him on the phone's speaker. He will only be able to hear what is spoken through your handset, however - audio will not be transmitted through your microphone.

### **Operation**

1. During a handset call, press the ON/OFF key.
  - Another receiver path is established on the phone's speaker -- you can now hear the outside party on the speaker as well as in the handset.
  - Your phone's microphone is muted so that the outside party hears only what is spoken through your handset. (To mute handset transmission, press MUTE.)
2. To disable Off-Hook Monitor ("kill" the speaker but stay on the line with the outside party through the handset), press ON/OFF again.

## **Separate Speaker Volumes for Internal vs. CO calls**

***44-Series phones only***

***CPC-AII/B Version 8.0, CPC-S/M Version 2.0, or CPC-EX Version 1.0 only***

### **Description**

You can now establish separate speaker volumes for internal (intercom) and external (CO) calls.

### **Operation**

To adjust volume levels, press the VOLUME key (s or t) during the appropriate call state.

### **Notes**

Adjusting speaker volume will affect only the speaker (i.e., not the handset), and vice-versa.

## Analog Adapter

**44-Series phones only**

**CPC-AII/B Version 8.0, CPC-S/M Version 2.0, or CPC-EX Version 1.0 only**

### Description

The Analog Adapter (VB-44100) consists of a base adapter and PC board which is installed on the underside of the phone. It is used to connect the 44-Series large-display phone to an analog device such as an SLT telephone, cordless phone, FAX machine, or modem. This allows the same phone line to be used to alternate between normal phone calls and analog communications. (*To install, see the instructions supplied with VB-44100.*)

### Programming

See *Section 400 - Programming (Appendix D)* for more detailed programming information.

### Operation

The first device to go off-hook will seize the line (off-hook is either lifting the handset or pressing the ON/OFF key). If the analog device goes off-hook first, the large-display phone will be unable to dial or go off-hook.

You can choose which device will ring by going off-hook at either the digital key telephone or the analog device and dialing \*71. The digital key telephone display will reflect "Analog port RING" or "Key Tel RING", depending on which device is selected - the default is "Key Tel RING".

You can still *answer* an incoming call from either device, regardless of which device is ringing. For example, if the analog device is ringing, you can pick up the call on the digital key telephone by going off-hook before the analog device does. Similarly, if the digital key telephone is ringing or has not answered a voice call, the analog device can pick up the call by going off-hook first.

You can program the \*71 ring select command into an FF key. Pressing the key toggles between "Analog Port RING" and "Key Tel RING". When the analog port is set to ring, the FF key LED lights red. When the key telephone is set to ring, the LED is off.

### Notes

#### *Phone Restrictions*

- The Analog Adapter will work on the large-display phone only (VB-44225).
- A dial-pulse SLT will not function on the analog port.
- Stutter Dial Tone (indicating Call-Forwarding mode, Do-Not-Disturb mode, etc.) will not function on an SLT connected to the Analog Adapter.
- An analog phone connected to the Analog Adapter cannot program or access speed dials.

**Incoming Calls**

- You cannot program both devices to ring simultaneously.
- The “\*71” code will not work if the other device is in use.
- The “\*71” code will not work if FF3 (ExtPort)# 51# is set to “0”.
- If set to “Analog port RING”, the large-display phone will work like an SLT/OPX (no page announcements, no voice calls from other extensions, etc.).
- If the phone is in CF/DND (Call-Forward or Do Not Disturb), the phone will remain in CF/DND even if the ringing device is changed via the \*71 code.
- The incoming ring pattern for the analog device is the same as for the digital key telephone (determined by the Extension Ring Pattern in FF3 (ExtPort)# 39# (0-9)#). If this address is set to “0” (determined by CO), the analog device will automatically default to “1 second ON, 3 seconds OFF.”

**Ring Patterns Not Applicable to Analog Device.** The following ring pattern addresses *will not* affect the analog device:

Analog Transfer Ring Pattern	FF1 2# 1# 31# (0-6)#
SLT DISA Ring Pattern	FF1 2# 1# 34# (0 or 1)#
Inbound Ring Pattern	FF2 (Trunk)# 17# (0-9)#

**Flash Interaction.** Any disconnect signal sent to the analog port must be greater than the SLT Flash Control; otherwise the disconnect signal will be interpreted as a flash and the call will be placed on hold.

**Programming Addresses That Affect the Analog Device.** The following addresses will control the analog device, but will not affect the digital key telephone:

AEC Disconnect Duration	FF1 2# 1# 35# (0-15)#
SLT Flash Control	FF1 2# 1# 11# (0 or 1)#
SLT Onhook Flash Timer	FF1 3# 14# (0-6)#
AEC Disconnect or 1)#	FF3 (ExtPort)# 46# (0
Analog Port on Large-Display Phone or 1)#	FF3 (ExtPort)# 51# (0
Data Security on Analog Port or 1)#	FF3 (ExtPort)# 52# (0

## **MSG (Message) Key**

**44-Series phones only**

**CPC-AII/B Version 8.0, CPC-S/M Version 2.0, or CPC-EX Version 1.0 only**

- Description** The MSG key on the VB-44225 Large-Display Phone adds the following functionality to the phone:
- **Auto-Callback.** If a callback message has been left by another extension, you can press the MSG key to place an automatic callback to the extension that sent the message. If more than one callback message has been received, pressing the MSG key will perform auto-callback in the order received.
  - **Auto-Answer Voice Message.** You can press the MSG key to automatically access your voice mailbox. The phone will dial your voice mailbox and send access codes (if programmed) for retrieving new messages.
- Programming** See *Section 400 - Programming (Appendix D)* for more detailed programming information.
- Operation**
- To Program Voice Mailbox Access Codes into the MSG Key:**  
Press PROG MSG [16-digit number] HOLD  
  
The display will reflect “Regist Data”.
- To Confirm a Voice Mailbox Access Code Programmed into the Message Key..**  
Press CONF MSG.  
  
The programmed access code will be displayed.
- Notes**
- Operation With Message Waiting Indicator.** The Message Waiting Indicator on the phone’s upper right corner will flash whenever a callback message or voice message has been received.
- Operation During Call States.** The MSG key will work only when the phone is idle, receiving dial tone, or in Directory Mode (via select key).
- Operation If Phone Has Both a Callback Message from another Extension and a Voice Message.** Messages are accessed in a First In, First Out order. If the callback message was received before the voice message, then pressing the MSG key will activate Auto-Callback first. Likewise, if

the voice message was received before the callback message, pressing the MSG key will access your Voice Mailbox.

**Interaction with Tone-Calling Mode.** If an Auto-Callback is placed to a phone that is in tone-calling mode (i.e., not voice-calling), that phone must answer or the message canceled before another message can be accessed.

**FF-Key Restriction.** These MSG features cannot be assigned to an FF-key.

**Reprogramming the MSG key if Extension Number Digits is changed.** If the DBS is reprogrammed to use a different extension numbering plan (i.e., changed from 2-digit to 3-digit extensions, 3-digit to 4-digit extensions, etc.), the Voice Mailbox Access Code must be reprogrammed into the MSG key.

## **DSS/72 Console - Key Arrangement**

**44-Series phones only**

**CPC-All/B Version 8.0, CPC-S/M Version 2.0, or CPC-EX Version 1.0 only**

### **Description**

The keys on the enhanced DSS/72 Console (VB-44320) are arranged differently from the VB-43320 model. The enhanced DSS console has 6 columns x 12 rows of keys (not 8 columns x 9 rows as in the previous version). This affects the following:

- **Name and Message Assignments (FF6 addresses).** The alphabetical arrangement of the keys is different.
- **FF-Keys.** The FF-keys on the DSS/72 console are numbered left-to-right, bottom row first.
- **DSS #1 Defaults.** The default extension number assignments on DSS #1 are different.

The newer arrangement for the DSS keys is shown in Figures 16 & 17.

**Figure B-16.DSS/72 Console (VB-44320) key layout**

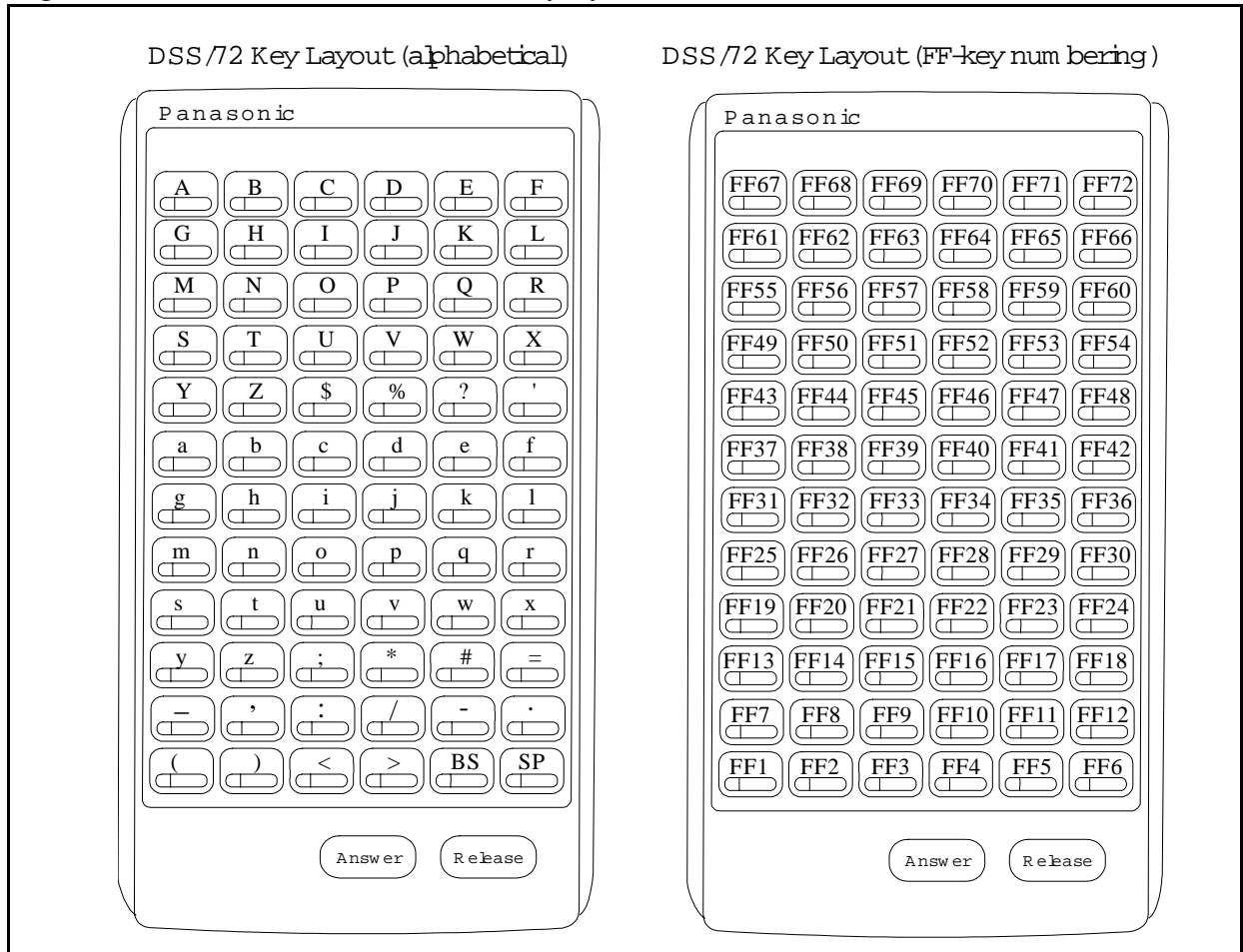

**Figure B-17.DSS/72 #1 Default Extension Numbers**

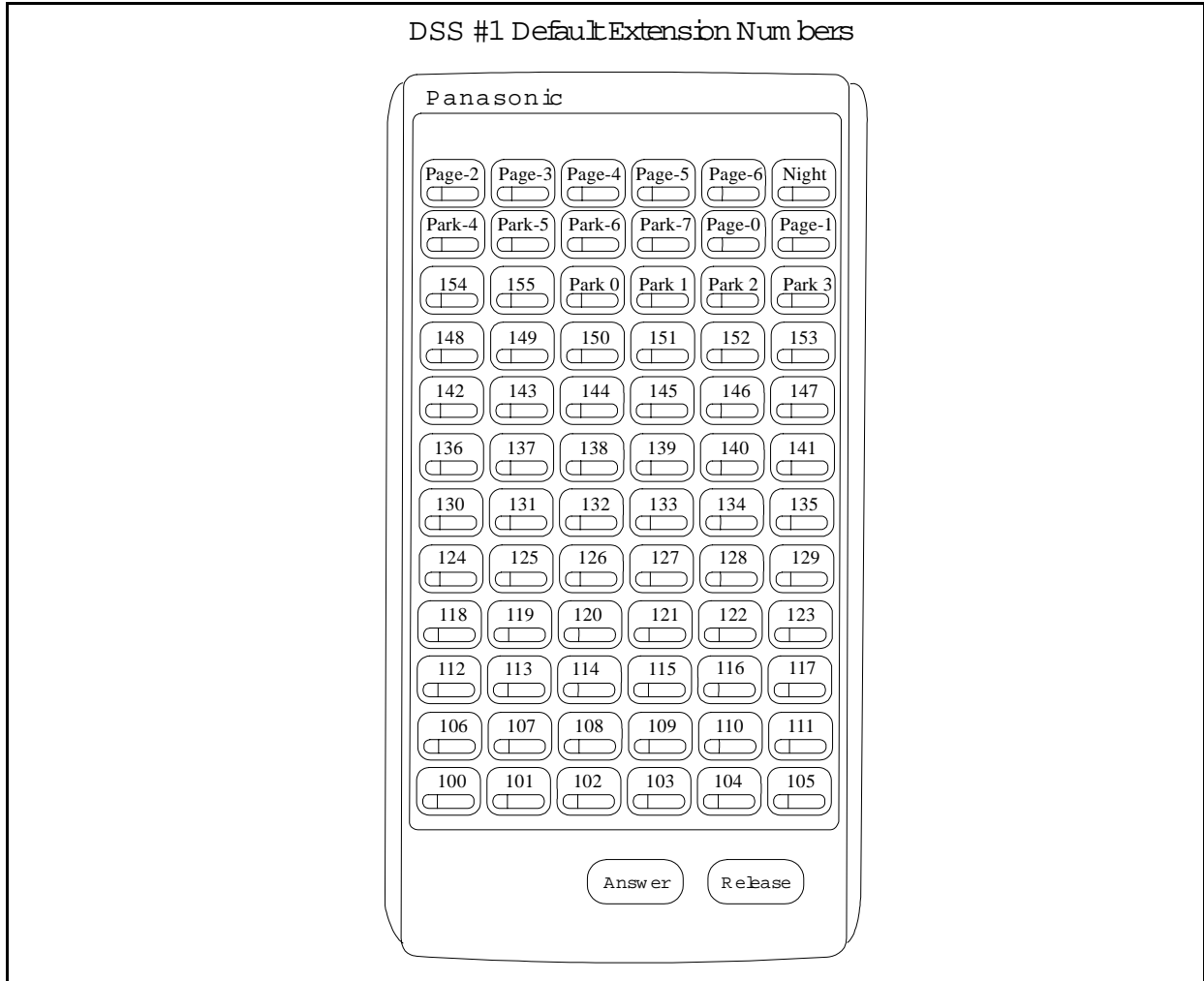

**Programming** See Section 400 - Programming (Appendix D) for more detailed programming information.

**Operation** The 44-Series DSS/72 operates the same as previous models.



## EM/24 - Key Arrangement

44-Series phones only

CPC-AII/B Version 8.0, CPC-S/M Version 2.0, or CPC-EX Version 1.0 only

### Description

The keys on the enhanced EM/24 unit (VB-44310) are arranged differently from the VB-43310 model. The enhanced EM/24 unit has 2 columns x 12 rows of keys (not 3 columns x 8 rows as in the previous version). This affects the following:

- **FF-Keys.** The FF-keys on the EM/24 are numbered bottom-to-top, left column first.

The newer arrangement for the EM/24 keys is shown in Figure 18.

Figure B-18.EM/24 Unit (VB-44310) keys

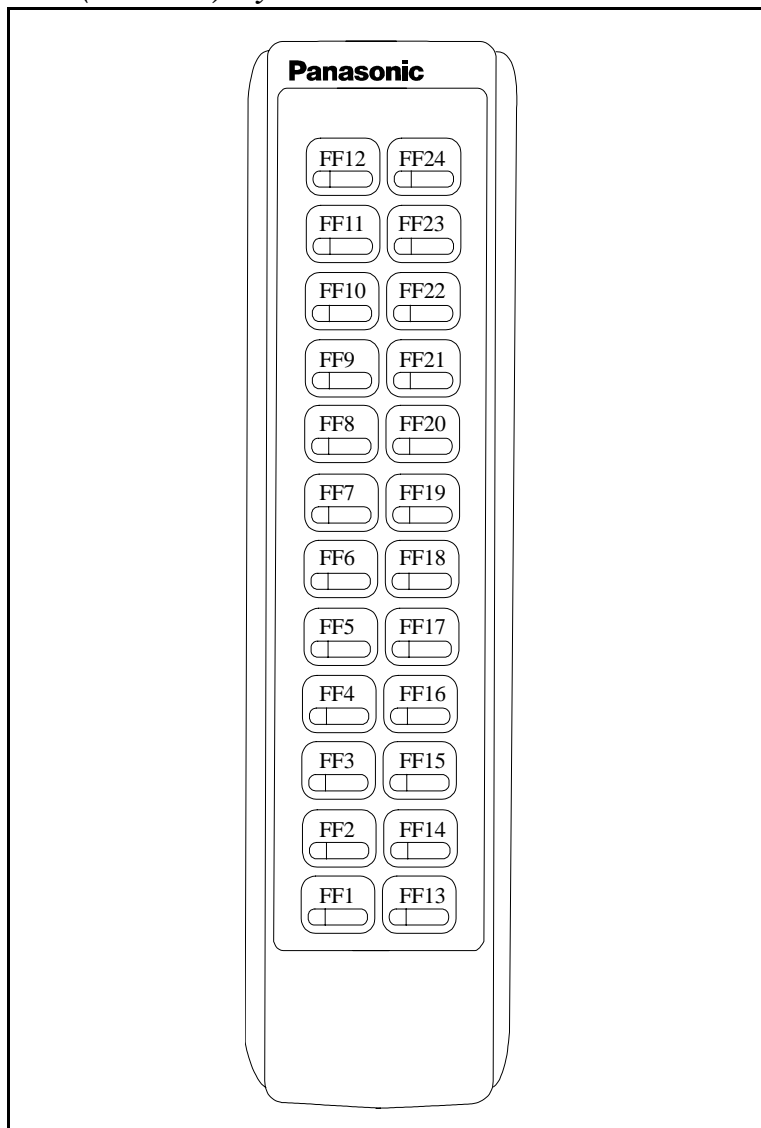

**Programming** See *Section 400 - Programming (Appendix D)* for more detailed programming information.

**Operation** The 44-Series EM/24 operates the same as previous models.

---

## Modification to Toll Restriction Service

**Description** The program address for TRS Operator Access (FF7 1# 18#...) has been modified to allow an extension to dial “0+NXX” phone numbers, even if “0-only” dialing is denied.

Four settings are possible.

**Programming** See *Section 400 - Programming (Appendix D)* for more detailed programming information.

### Notes

- The Operator Access address applies only to DBS systems using the (1995) NANP dialing plan (FF7 1# 17# 1#), and to TRS types 2-6 (TRS types 0 and 1 do not allow outbound dialing; TRS type 7 allows all dialing).
- If “0-only”, “00-only”, “10XXX0-only”, or “101XXXX0-only” calls are restricted (settings 0 or 2), the system will wait 6 seconds before automatically disconnecting the call. However, if the user dials additional digits within 6 seconds, the DBS will check other switches to determine whether to allow or deny the call.
- For all settings (0-3), the system will check the Equal Access Code Format switch (FF7 1# 21#...) if a CIC (carrier identification code) is dialed to reach a preferred inter-exchange carrier.
- For all settings (0-3), the system will check the international calls switches (FF7 1# 1# and FF7 1# 19#) if “01”, “10XXX01”, or “10XXXX01” is dialed.
- For settings 2 and 3, the system will not consider TRS settings for the trunk.

---

## TAPI Support

CPC-AII/B offers full support for the Panasonic Telephony Applications Processing Interface (TAPI). TAPI is a Windows™ application which allows a PC to be connected to a telephone extension and used to control incoming and outgoing calls through that extension. Typical PC applications that might be used with TAPI include Contact Managers and Personal Organizers.

The Panasonic TAPI product (VB-43720) provides the necessary interface between a DBS and a PC-based TAPI application. This product consists of a TAPI Adapter and the Panasonic TAPI Service Provider (SP) software which resides on the PC. The TAPI Adapter provides the physical connection between a PC, a DBS extension, and the DBS itself. Its purpose is to intercept telephone and call control signaling messages from the DBS and telephone extension and then forward a copy of those messages to the Service Provider software on the PC. After interpreting the messages, the Service Provider software passes them on to the TAPI application.

No special programming of the DBS is required for TAPI. For detailed information, see the *TAPI Installation Guide, Part Number 575X00201, Section 570*.

---

## Key Telephone Installation Notes

### *Desi Strip Cover*

The 44-Series Key Telephones are shipped with a thin green protective film over the Desi strip cover. Be sure to remove this film from both sides of the Desi cover before placing the phone in service.

### *Key Telephone Wall Mounting Instructions*

The following procedures apply to 44-Series Key Telephones only. Please be sure to follow these procedures exactly. Removing the desk stand incorrectly can result in damage to the telephone and/or desk stand.

1. Place the telephone face down on a flat surface.
2. Grasp the top of the desk stand (at the >**ABS**< label) and pull up the end to 90° vertical (refer to Step 2 in Figure D-19). The stand will click as it releases from the plastic securing latches.
3. Lift the desk stand as shown in Step 3 of Figure D-19.

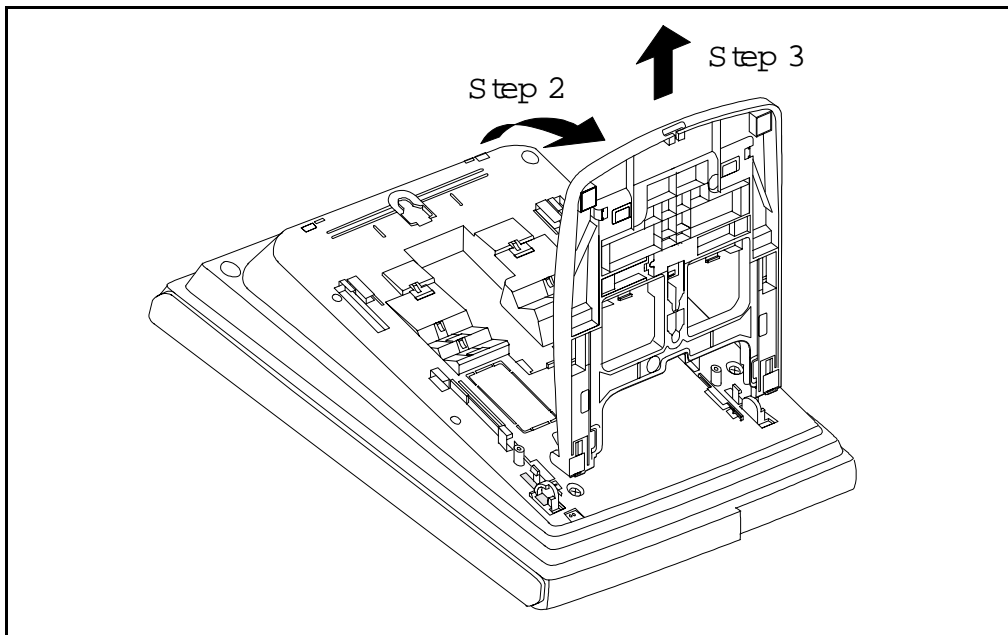
**Figure B-19.Desk Stand Removal.**

4. Rotate the desk stand 180°. In this position it doubles as a wall mount bracket.
5. Insert the wall mount bracket into the mounting guides as shown in Figure D-20.
6. Slide the wall mount bracket onto the telephone.

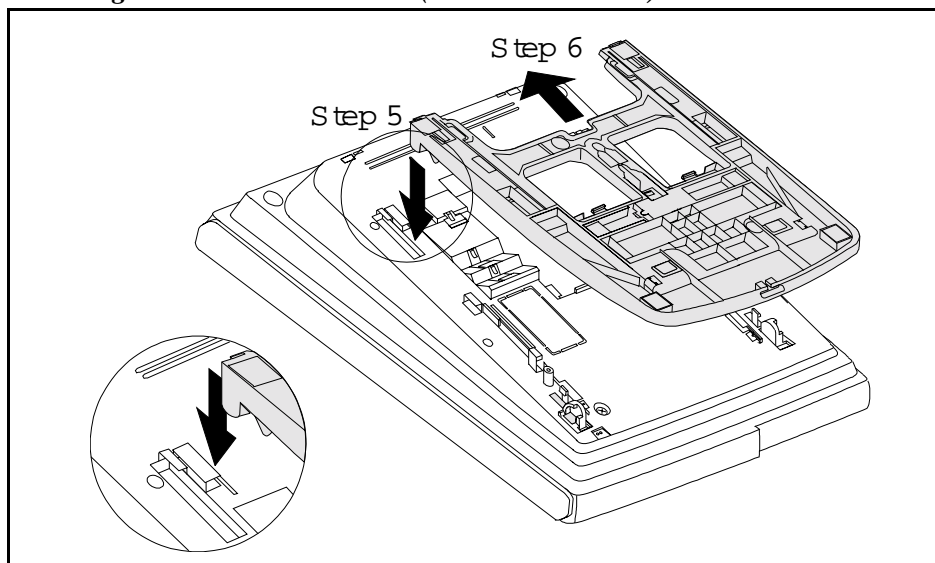
**Figure B-20.Inserting the wall mount bracket (rotated desk stand)**

7. While viewing the front of the telephone, find the handset guide located just below the hookswitch (see Figure D-8).
8. Slide the handset guide out, rotate 180° so that the holding clip is exposed, and reinsert.

*Figure B-21. Handset guide insertion for wall mounting, key telephone*

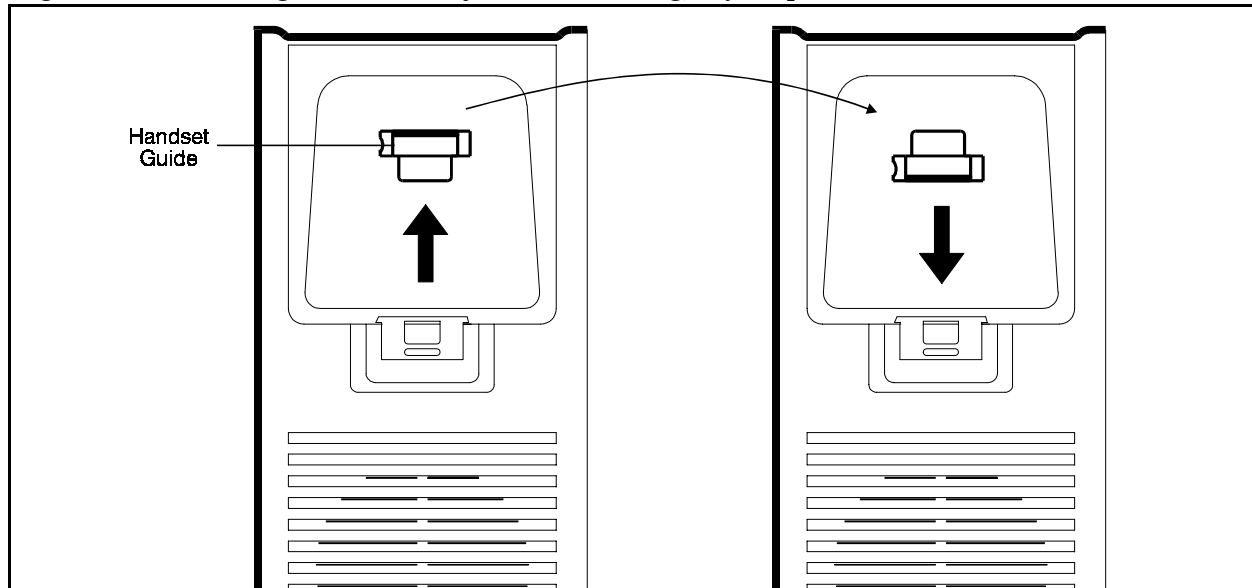



---

# Appendix C: CPC-AII/B 9.0 Updates

The following enhancements are included with CPC AII/B Version 9.0:

- CPC-AII/B Version 9.0 adds support for the PanaVOICE Digital Voice Mail system.

All installation and programming procedures for the PanaVOICE Digital Voice Mail system are covered in the documentation supplied with the PanaVOICE Digital Voice Mail system.

- The VAU port assignment program (FF3 (ExtPort)# 47#) can now be used to configure digital ports connected to the PanaVOICE Voice Mail.
- The user can now dial **\*73** to enable or disable the use of the Off-Hook Monitor feature. When the user dials **\*73** the first time, the display reads **Monitor OFF** and the Off-Hook Monitor feature cannot be used. When the user dials **\*73** a second time, the display reads **Monitor ON** and the Off-Hook Monitor can be used.

*(This page left blank intentionally)*



---

# Appendix D: CPC-AII/B 9.1 Updates

CPC-AII/B Version 9.1 adds support for the “Call Record” feature available with PanaVOICE™ Voice Mail systems. In addition, several quality improvements are incorporated in Version 9.1.

**CAUTION: When using the “Call Record” feature in some states it is illegal to record telephone communications without the consent of all parties. In other states, it is illegal to record without the consent of one party. These laws do not make the Call Record feature on a telephone system illegal. Before activating this feature, please check applicable state and federal laws.**

## Call Record

*Requires PanaVOICE equipped with Software Version 2.1 (Q32136) or later.*

**Description** The call record feature allows a user to record a trunk conversation at the press of preassigned **Call Record** FF key. The conversation is saved to the user’s voice mail box.

**Programming** See *Section 400 - Programming (Appendix F)* for more detailed programming information.

**Operation** **To record a trunk call:**

To record a trunk call, press the **Call Record** key. The LED flashes while the connection to the Voice Mail recording port is being established. This may take a few seconds. When recording begins, the LED lights solid, “**Recording**” appears on the display, and the audio message “Recording” is heard by both parties.

If call record cannot be established (no voice mail port available, no conference circuit available, etc.), the LED extinguishes and a double splash tone sounds.

Recording continues until you hang up, you press the **Call Record** key again or PanaVOICE stops recording due to a PanaVOICE time-out, lack of disk space, etc.

In the event PanaVOICE stops recording during a conversation, a beep tone is issued, the LED extinguishes and “**Recording**” disappears from the display.

If the outside party hangs up first, you may continue recording call follow-up information.

**To retrieve a records:**

Once the call recording is complete, the recording is stored in your voice mail box as a new voice mail message.

PanaVOICE treats the recording message just as it would any other new message (lights the message waiting LED, displays MSG on your telephone, provides off site message notification, etc.).

Retrieve the call recording just as you would any other new voice mail message. (If you are unclear on how to retrieve messages, contact your PanaVOICE system administrator.)

**Notes**

- Recording a call requires a conference circuit. If no conference circuit is available, PanaVOICE cannot record the conversation. Systems equipped with CPC-AII/SCC-Mode A provides 3 conference circuits and the CPC-B/SCC-Mode B provides 8 conference circuits.
- Since a conference circuit is used, when the call being recorded is placed on hold the other party will continue to be recorded and will not hear music-on-hold.
- The call record feature is not designed to support multiple-party conversations. Once recording a call, do not attempt to add other parties. If you need to conference in additional parties, first stop the recording by pressing the **Call Record** key and then initiate the conference. If you are in a multiple party conversation, do not attempt to record the conversation.
- Calls that are in call record mode cannot be transferred. First, stop the recording by pressing the **Call Record** key, then transfer the call.
- Call recording may be stopped and restarted multiple times in a conversation by pressing the **Call Record** key. However, every time call recording is stopped, the recording is saved as a separate message.
- When the system is in the process of establishing a call recording connection, barge-in cannot be performed. However, once recording begins, a barge-in is possible but not recommended. If a barge-in does occur, when the party that barges-in disconnects call recording may be automatically terminated.
- Extension (intercom) calls cannot be recorded. The other party must be a trunk call (including network trunk calls).
- A trunk call must be in progress for the call to be recorded. You cannot initiate a call record before connection is made.

---

# Appendix E: CPC-EX 2.0 Updates

The following enhancements are included with CPC EX Version 2.0:

- CPC-EX Version 2.0 adds support for the PanaVOICE Digital Voice Mail system.

All installation and programming procedures for the PanaVOICE Digital Voice Mail system are covered in the documentation supplied with the PanaVOICE Digital Voice Mail system.

- The VAU port assignment program (FF3 (ExtPort)# 47#) should be used to configure digital ports connected to the PanaVOICE Voice Mail.
- The user can now dial **\*73** to enable or disable the use of the Off-Hook Monitor feature for 44-Series Telephones. When the user dials **\*73** the first time, the display reads **Monitor OFF** and the Off-Hook Monitor feature cannot be used. When the user dials **\*73** a second time, the display reads **Monitor ON** and the Off-Hook Monitor can be used.
- The ISDN Inter-Digit Timer has been changed from a fixed length of 6 seconds to a fixed length of 4 seconds. This decreases the time the system waits to determine if all digits are dialed before outdialing digits.
- The CPC version number display format has been changed to indicate the product ID, version number and release date. For example, this release will display as follows when **ON/OFF CONF 7777** is entered:

**-EX 2.00 09-97**

*(This page left blank intentionally)*

---

# Appendix F: CPC-EX 2.1 Updates

CPC-EX Version 2.1 adds support for the “Call Record” feature available with PanaVOICE™ Voice Mail systems. In addition, several quality improvements are incorporated in Version 2.1.

**CAUTION: When using the “Call Record” feature in some states it is illegal to record telephone communications without the consent of all parties. In other states, it is illegal to record without the consent of one party. These laws do not make the Call Record feature on a telephone system illegal. Before activating this feature, please check applicable state and federal laws.**

## Call Record

*Requires PanaVOICE equipped with Software Version 2.1 (Q32136) or later.*

### Description

The call record feature allows a user to record a trunk conversation at the press of preassigned **Call Record** FF key. The conversation is saved to the user’s voice mail box.

### Programming

See *Section 400 - Programming (Appendix H)* for more detailed programming information.

### Operation

#### To record a trunk call:

To record a trunk call, press the **Call Record** key. The LED flashes while the connection to the Voice Mail recording port is being established. This may take a few seconds. When recording begins, the LED lights solid, “**Recording**” appears on the display, and the audio message “Recording” is heard by both parties.

If call record cannot be established (no voice mail port available, no conference circuit available, etc.), the LED extinguishes and a double splash tone sounds.

Recording continues until you hang up, you press the **Call Record** key again or PanaVOICE stops recording due to a PanaVOICE time-out, lack of disk space, etc.

In the event PanaVOICE stops recording during a conversation, a beep tone is issued, the LED extinguishes and “**Recording**” disappears from the display.

If the outside party hangs up first, you may continue recording call follow-up information.

**To retrieve a records:**

Once the call recording is complete, the recording is stored in your voice mail box as a new voice mail message.

PanaVOICE treats the recording message just as it would any other new message (lights the message waiting LED, displays MSG on your telephone, provides off site message notification, etc.).

Retrieve the call recording just as you would any other new voice mail message. (If you are unclear on how to retrieve messages, contact your PanaVOICE system administrator.)

**Notes**

- Recording a call requires a conference circuit. If no conference circuit is available, PanaVOICE cannot record the conversation. Systems equipped with the CPC-EX/SCC-Mode B provide 8 conference circuits.
- Since a conference circuit is used, when the call being recorded is placed on hold the other party will continue to be recorded and will not hear music-on-hold.
- The call record feature is not designed to support multiple-party conversations. Once recording a call, do not attempt to add other parties. If you need to conference in additional parties, first stop the recording by pressing the **Call Record** key and then initiate the conference. If you are in a multiple party conversation, do not attempt to record the conversation.
- Calls that are in call record mode cannot be transferred. First, stop the recording by pressing the **Call Record** key, then transfer the call.
- Call recording may be stopped and restarted multiple times in a conversation by pressing the **Call Record** key. However, every time call recording is stopped, the recording is saved as a separate message.
- When the system is in the process of establishing a call recording connection, barge-in cannot be performed. However, once recording begins, a barge-in is possible but not recommended. If a barge-in does occur, when the party that barges-in disconnects call recording may be automatically terminated.
- Extension (intercom) calls cannot be recorded. The other party must be a trunk call (including network trunk calls).
- A trunk call must be in progress for the call to be recorded. You cannot initiate a call record before connection is made.

---

# Appendix G: CPC-M 3.2 Updates

CPC-M Version 3.2 adds the following features and software corrections to the DBS phone System:

## Enhanced Features

- **Off-Hook Voice Announce/API Enhancement** - This feature provides support of the DBS Off Hook Voice Announce feature via the API.
- **44 Series Small LCD Key-Telephone Soft Key Support (VB-44XXXX)**  
This enhancement allows the Small Liquid Crystal Display (LCD) K-TEL to use the softkeys when accessing the Voice Mail application.
- **Call Record via API** - This enhancement provides support for the call record feature via the API.

## Software Corrections

- **Previously Unable to restrict 800+ Numbers for TRS types 5 and 6** - In the previous version, if an 800-xxx number was entered in the special area and special office code tables with the new North American Numbering Plan (NANP) activated TRS types 5 and 6, it did not restrict the call. This problem has been corrected in this version.

## Off-Hook Voice Announce (OHVA) via API

### Description

This feature provides support of the DBS Off Hook Voice Announce feature via the API. This API feature addition allows applications that utilize API integration with the DBS to have access to the OHVA feature.

### Programming

N/A

### Operation

N/A

### Note

The OHVA feature via the API has the same feature limitations as listed in the DBS manual.

## Small LCD Soft Key Support via API

### Description

This enhancement allows the 44-Series Small LCD Key-Telephone (VB-44XXXX) K-TEL to use the soft-keys when accessing the Voice Mail application.

### Programming

N/A

### Operation

N/A

### Note

The OHVA feature via the API has the same feature limitations as listed in the DBS manual.

## Call Record (OHVA) via API

### Description

This feature provides support of the DBS Call Record feature via the API. This API feature addition allows applications that utilize API integration with the DBS to have access to the Call Record feature.

### Programming

N/A

### Operation

N/A

### Note

The Call Record feature via the API has the same feature limitations as listed in the DBS CPC-EX ver. 2.1 Release Notes.



---

# Appendix H: CPC-AII/B 9.2 Updates

CPC-A2/B version 9.20 adds the following features and software corrections to the DBS phone System:

## New Features

- **Sixteen-Port Voice Mail/API Enhancement** - In addition to the current 8-port API integration, this software change allows the DBS to support up to sixteen-port API Integration.
- **Off-Hook Voice Announce/API Enhancement** - This new feature provides support of the DBS Off-Hook Voice Announce feature via the API.
- **44-Series Small LCD Key-Telephone Soft Key Support (VB-44XXXX)** This enhancement allows the Small Liquid Crystal Display (LCD) K-TEL to use the softkeys when accessing the Voice Mail application.
- **Call Record via API** - This enhancement provides support for the call record feature via the API.

## Software Corrections

- **Last Digit of Voice Mail One Touch Key Was Truncated** - With earlier versions, if a Voice Mail One-Touch Access key was programmed, when the key was viewed with the Conf. Function the last digit of the programmed information could not be seen.
- **Previously Unable to restrict 800+ Numbers for TRS types 5 and 6** - In the previous version, if an 800-xxx number was entered in the special area and special office code tables with the new North American Numbering Plan (NANP) activated TRS types 5 and 6, it did not restrict the call. This problem has been corrected in this version.
- **DID Call to a Voice Mailbox Received Main Greeting** - In the previous version, in a Non-Integrated Digital PanaVOICE environment, if a DID/DNIS call was directed directly to a voice mail box, the caller was sent to the main greeting instead of the correct voice mail box. This problem has been corrected with this version.

## 16-Port Voice Mail Support via API

### Description

This feature allows up to sixteen (16) voice mail ports via API integration.

**Programming** See *Section 400 - Programming (Appendix J)* for more detailed programming information.

**Operation**

N/A

**Notes**

- All additional voicemail programming must be completed on the entire 16 ports for the voice mail to function properly.
- Voice mail ports should be on consecutive AEC or DEC cards.

## **Off-Hook Voice Announce (OHVA) via API**

**Description**

This feature provides support of the DBS Off-Hook Voice Announce feature via the API. This API feature addition allows applications that utilize API integration with the DBS to have access to the OHVA feature.

**Programming**

N/A

**Operation**

N/A

**Note**

The OHVA feature via the API has the same feature limitations as listed in the DBS manual.

## Small LCD Softkey Support via API

### Description

This enhancement allows the 44-Series Small LCD Key-Telephone (VB-44XXXX) K-TEL to use the softkeys when accessing the Voice Mail application.

### Programming

N/A

### Operation

N/A

### Note

The OHVA feature via the API has the same feature limitations as listed in the DBS manual.

## Call Record (OHVA) via API

### Description

This feature provides support of the DBS Call Record feature via the API. This API feature addition allows applications that utilize API integration with the DBS to have access to the Call Record feature.

### Programming

N/A

### Operation

N/A

### Note

The Call Record feature via the API has the same feature limitations as listed in the DBS CPC-EX ver. 2.1 Appendix.

*(This page left blank intentionally)*

---

# Appendix I: CPC-EX 2.3 Updates

CPC-EX Version 2.3 adds the following features and software corrections to the DBS phone System:

## New Features

- **Bus Monitor Time Print Change** - Bus Monitor now prints the time every one minute.
- **Sixteen-Port Voice Mail/API Enhancement** - In addition to the current 8-port API integration, this software change allows the DBS to support up to sixteen-port API Integration.
- **Off-Hook Voice Announce/API Enhancement** - This feature provides support of the DBS Off-Hook Voice Announce feature via the API.
- **44-Series Small LCD Key Telephone Soft Key Support (VB-44XXXX)** - This enhancement allows the Small Liquid Crystal Display (LCD) K-TEL to use the softkeys when accessing the Voice Mail application.
- **Call Record via API** - This enhancement provides support for the Call Record feature via the API.

**Note:** The following features, UNA Transfer, UNA Call Reversion, Forwarding to UNA for CO Held Calls, All Ring Group, Private Password, Additional RAI Access, and All Ring Group features have been fully tested in our laboratory but not in live Beta trials. These features are to be considered *Beta-level* features. If you have any difficulty with these new features please call the BTSD Hotline in Secaucus, New Jersey, at (800) 822-0909.

\***UNA Transfer** - Adds the ability for a user, automated attendant, etc., to transfer a call to Universal Night Answer (UNA) by dialing the access code \*78. The call may then be retrieved by dialing the UNA pickup code (78).

\***UNA Call Reversion** - Adds the ability for calls, that have reverted to the attendant and are unanswered, to revert to UNA.

\***Forwarding to UNA for CO Held Calls** - An extension can be set so that certain calls are forwarded to UNA. If an inside extension (such as an automated attendant) receives a CO call, places the call on hold and dials the forwarding extension, then the call will forward to UNA.

\***All Ring Group** - A call transferred to an "All Ring Group" rings all phones in the group at the same time. This makes the call available to multiple locations, including UNA, simultaneously.

\***Private Password** - The private password feature allows a user to enter programming and access to all programming parameters including the system

and remote passwords. The private password may always be used to enter the system.

**\*Additional Remote Administration Interface (RAI) Access Method** - In addition to the existing RAI access, a new RAI access method has been added. The RAI access allows an incoming call to be transferred to the RAI (either manually or by Automated Attendant) and then the caller enters the remote or private password.

**ISDN Programming Flexibility** - The existing ISDN programming has been enhanced to allow programming flexibility in the following areas: Network Type, Auto Progress, NSF, ISDN CO Type, ISDN International Dial Code Deduction, ISDN Long Distance Code 1 Deduction, and ISDN Type and Plan Option.

## Software Corrections

**SMDR Stopped Printing** - In earlier versions, the SMDR output from the DBS would stop printing and not reset. This problem has been corrected with this version.

**SMDR Header Printed More Often Than Every 60 Lines** - In earlier versions, the SMDR header printed more than every 60 lines. In this version, the SMDR header now correctly prints out every 60 lines.

**Last Digit of Voice Mail One Touch Key Was Truncated** - In earlier versions, if a Voice Mail One-Touch Access key was programmed when the key was viewed with the Conf. Function, the last digit of the programmed information could not be seen.

**Previously Unable to restrict 800+ Numbers for TRS types 5 and 6** - In the previous version if an 800-xxx number was entered in the special area and special office code tables with the new North American Numbering Plan (NANP) activated TRS types 5 and 6, it did not restrict the call. This problem has been corrected in this version.

**Override Toll Restriction with SSD Numbers Address Was Not Available** - In the previous version, the programming address FF1 2#1#4# could not be accessed. The address is now available in this version.

**DID Call to a Voice Mailbox Received Main Greeting** - In the previous version, in a Non-Integrated Digital PanaVOICE environment, if a DID/DNIS call was directed directly to a voice mail box, the caller was sent to the main greeting instead of the correct voice mail box. This problem has been corrected with this version.

**Unusual First Ring on Incoming ISDN Calls** - Previously incoming calls on ISDN line had a long ringing pattern (6 seconds ON or more, then OFF).

This only occurred on the first ring. After the first ring, the ringing pattern returned to normal. The ringing pattern for incoming ISDN calls now rings as expected.

**Calling Party Could be Heard Between Rings** - In the previous version, when an ISDN call was transferred, the station receiving the call could hear the calling party between rings. This problem has been corrected in this version.

**Dial Tone Received After Placing Call** - Previously, when placing an outgoing call after dialing the number, the caller would receive another dial tone. This problem has been corrected in this version.

**ISDN Calls Disconnected** - Previously if an ISDN-to-ISDN call was attempted, and the called party was busy, instead of receiving CO Busy the call was dropped. This problem has been corrected in this version.

## 16-Port Voice Mail Support via API

### Description

This feature allows up to sixteen (16) voice mail ports via API integration.

### Programming

**Programming** See *Section 400 - Programming (Appendix K)* for more detailed programming information.

### Operation

N/A

### Notes

- All additional voicemail programming must be completed on the entire 16 ports for the voice mail to function properly.
- Voice mail ports should be on consecutive AEC or DEC cards.

## Off-Hook Voice Announce (OHVA) via API

### Description

This feature provides support of the DBS Off-Hook Voice Announce feature via the API. This API feature addition allows applications that utilize API integration with the DBS to have access to the OHVA feature.

### Programming

N/A

### Operation

N/A

### Note

The OHVA feature via the API has the same feature limitations as listed in the DBS manual.

## Small LCD Soft Key Support via API

### Description

This enhancement allows the 44-Series Small LCD Key-Telephone (VB-44XXXX) K-TEL to use the softkeys when accessing the Voice Mail application.

### Programming

N/A

### Operation

N/A

### Note

The OHVA feature via the API has the same feature limitations as listed in the DBS manual.



## Call Record (OHVA) via API

### Description

This feature provides support of the DBS Call Record feature via the API. This API feature addition allows applications that utilize API integration with the DBS to have access to the Call Record feature.

### Programming

N/A

### Operation

N/A

### Notes

- The Call Record feature via the API has the same feature limitations as listed in the DBS CPC-EX ver. 2.1 Release Notes.

---

## Special Features

The following features marked with an “\*”, UNA Transfer, UNA Call Reversion, Forwarding to UNA for CO Held Calls, All Ring Group, Private Password, Additional RAI Access, and All Ring Group features have been fully tested in our laboratory but not in live Beta trials. These features are to be considered as *Beta-level* features. If you have any difficulty with these new features please call the BTSD Hotline in Secaucus, New Jersey, at (800) 822-0909.

### \*UNA Transfer

#### Description

The UNA transfer feature allows a trunk call to be transferred to the UNA. The call may be transferred manually or via a device such as an automated attendant.

#### Programming

N/A

#### Operation

##### To transfer a trunk call to UNA:

1. Hookflash or press **HOLD** to place the trunk call on hold.
2. Dial **\*78**. After **\*78** is dialed, dial tone is heard indicating that the call has successfully been transferred.
3. Hang up.

##### To answer a UNA call:

1. Go offhook.
2. Dial **78**.

or

1. Directly pick up the UNA held trunk by pressing the dedicated trunk key.

## Notes

- When a call is transferred to UNA, the trunk caller hears the selected hold sound source.
- When a call is transferred to UNA, the UNA continues to ring until the call is answered (by dialing **78** or direct trunk access) or the caller hangs up.
- If multiple callers ring the UNA, the UNA calls are picked up on a first-in/first-out method.
- The UNA cannot be a member of a hunt group.
- The UNA can be a member of an All Ring Group. (See “*Forwarding to UNA for CO Held Call*”.)

## \*UNA Call Reversion

### Description

The UNA call reversion feature allows calls that revert to the attendant (but are unanswered) to revert to UNA.

### Programming

*Table I-1 UNA Call Revision Timer Values*

Setting	Value
0	No reversion (default)
1	10 seconds
2	20 seconds
3	30 seconds
4	40 seconds
5	50 seconds
6	60 seconds
7	70 seconds
8	80 seconds
9	90 seconds
10	100 seconds
11	110 seconds
12	120 seconds

## Operation

When the UNA Reversion Timer is set to **0**, a call that reverts to the attendant and is not answered, continues to ring at the attendant. It does not revert to UNA. When the UNA Reversion Timer is set to a value other than 0, a call that reverts to the attendant and is not answered within the specified time reverts to UNA.

To answer a UNA call:

1. Go off-hook.
2. Dial **78**.

or

1. Directly pick up the trunk by pressing the dedicated trunk key.

## Notes

- When a call reverts to UNA, the UNA will continue to ring until the call is answered (by dialing **78** or by direct trunk access) or the caller hangs up.
- If multiple callers ring the UNA, the UNA calls are picked up on a first-in/first-out method.
- The Call Reversion Timer must be set to “revert calls to the attendant” position for unanswered calls to then be reverted to UNA.

## \*Forwarding to UNA for CO Held Call

### Description

An extension can forward certain calls to UNA. If an inside extension (such as an automated attendant) receives a CO call, it places the CO call on hold and dials the forwarding extension. Then, the call will forward to UNA.

Internal calls, direct calls to the forwarding extension, or T1 network calls ring the extension. They do not forward to UNA.

This feature is particularly useful in a situation when calls come into an automated attendant and then, on caller selection, may transfer to an extension such as the attendant. When the extension user goes on break etc., the calls can be forwarded to UNA to ensure that the call is handled.

## Programming

No new programming required. However, the Class of Service for the forwarding station must allow Call Forwarding to be Set/Reset for this feature to operate.

## Operation

### To set UNA forwarding:

1. At the forwarding extension, go off-hook or press **ON/OFF**.
2. Dial **725**.
3. Hang up or press **ON/OFF**.

### To cancel UNA forwarding:

1. At the forwarding extension, go off-hook or press **ON/OFF**.
2. Dial **72**.
3. Hang up or press **ON/OFF**.

### To transfer a CO call to an UNA forwarding extension:

1. Place the CO call on hold by pressing the **HOLD** key or by hookflashing.
2. Dial the UNA forwarding extension. The call immediately forwards, you hear dial tone and the display reads **FWD UNA**.
3. Hang up or press **ON/OFF**.

## Notes

- When a call rings UNA, the UNA will continue to ring until the call is answered (by dialing **78** or by direct trunk access) or the caller hangs up.
- If multiple callers ring the UNA, the UNA calls are picked up on a first-in/first-out method.
- Internal calls, direct calls to the forwarding extension, or T1 network calls ring the extension. They do not forward to UNA.
- A DISA caller will not be forwarded to UNA, but will ring the forwarding extension.
- The held CO will hear the call hold tone until the call is answered.
- If permanent call forwarding is also set in the forwarding extension, CO held calls will forward to UNA. However, all other calls will follow the permanent call forwarding.

- An extension user can only set “Do Not Disturb” or one type of call forwarding at a time including call forwarding to UNA. When the user sets DND or a call forwarding type, the previously set DND or call forwarding type is cleared.
- Call forward to UNA cannot be assigned to an FF-Key.

## \*All Ring Group

### Description

A new type of ringing group has been added - the All Ring Group. A call transferred to an All Ring Group rings all key telephones in the group at the same time. This makes the call available to multiple locations simultaneously. Once the call is answered, all other key telephones in the group stop ringing.

A common use for this feature is to have an Automated Attendant transfer a CO call to an All Ring Group on a selected input by the caller.

Up to four (4) All Ring Groups may be assigned. Up to 16 key telephone members may be in each group. In addition to the 16 key telephone members, the UNA may also be assigned to an All Ring Group.

### Programming

The All Ring Group feature utilizes existing Multiple DID Ringing to set up the All Ring Group. All members of the All Ring Group are set in standard DID programming (FF1 8# 3# (DID No.)# (Ext. No.)#). However, since calls cannot be transferred to a DID number, an All Ring Group Pilot number is first established and this pilot number is then linked to a DID number. In total, four programming addresses must be set for the All Ring Group feature to operate. These include:

### Operation

To transfer a CO call to an All Ring Group:

1. Place the call on hold by pressing **HOLD** (key telephone) or flashing the hookswitch (SLT).
2. Dial the All Ring Group Pilot Number. After the call is transferred to the All Ring Group, dial tone is heard.

When a call is transferred to the All Ring Group, every phone in the All Ring Group rings. When any phone in the group is answered, all phones stop ringing.

### Notes

- The All Ring Group may include the UNA (780).
- The original call must be a CO call. An internal call cannot be transferred to an All Ring Group. If you attempt to transfer an internal call to an All Ring Group, you will receive busy tone.
- A call presented to an All Ring Group will not recall or revert. The call must be answered or the caller must hang up.
- All Ring Groups cannot be chained together. In other words, an All Ring Group Pilot Number cannot be assigned as a member of another All Ring Group.
- Extensions may be a member of multiple All Ring Groups.
- If the DBS is part of a networked system, the All Ring Group members must be extensions on the local node.
- Only one call at a time may ring at a key telephone if non-appearing (lights the EXT LED).

## \*Private Password

### Description

A new private password has been added to allow entry into system programming at any time. This is useful if the normal system and/or remote password is forgotten, lost, mis-entered, or intentionally changed by an unauthorized person.

***SPECIAL NOTICE:*** The private password should be changed from the default setting after system installation, recorded and kept confidential by the system manager.

***SPECIAL NOTICE:*** The system must be entered using the private password to view the private password programming address.

### Programming

Programming Address

**FF1 6# 3# [NNNN]#**

Default Password: **6789**

## Notes

- You must enter programming using the private password to view the private password address. The private password address will not appear and is not accessible if programming is entered using the system or remote password.
- If the system or remote password is set to the same value as the private password, then the private password address will not be accessible. You must first change the system or remote password to another value and then log in again using the private password to have access to the private password address.
- If you are at an attendant key telephone when entering programming, you must first enter **#98** followed by the 4-digit private password before entering programming (*see below*). Otherwise, the private password is not accessible.

## Operation

To access the system using the private password at any display key telephone (including an attendant telephone):

1. Go off-hook or press **ON/OFF** key.
2. Dial **#98** followed by the 4-digit private password.
3. Press **PROG** followed by **##**.
4. To exit system programming, hang up or press the **ON/OFF** key.

## Terminal Programming Through a Direct Connection

When programming from a terminal connected to the RS-232C (SMDR) port, perform the following steps:

1. Make certain the cables are configured and connected as outlined in Section 300.
2. Make certain the DBS is in the SMDR mode by entering the following code from the attendant port:

### **ON/OFF #93**

3. Enter your terminal communications program and make sure your PC's data communications settings match those of the DBS.
4. From your terminal communications program, type the following command:



#99xxxx (where xxxx = the site's private password)

5. After the DBS responds, type **P** and then press **Enter**.
6. Follow the directions on the screen to access the desired program. (See “*Terminal Programming Commands.*”)

### **Terminal Programming Through DISA**

**Note:** The DBS must be equipped with an MFR card and an RAI card to allow terminal programming using this method.

When programming through a DISA trunk, perform the following steps:

1. Dial into the DBS through a DISA trunk.
2. Once you are connected, type #6 followed by the private password from your terminal communications program.
3. After the DBS responds with REMT>, type **P** and then press **Enter**.
4. Follow the directions on the screen to access the desired program. (See “*Terminal Programming Commands.*”)

### **Terminal Programming Through a CO Trunk and Operator Transfer**

**Note:** The DBS must be equipped with an MFR card and an RAI card to allow terminal programming using this method.

*SPECIAL NOTICE:* If you use the following method, the private password must be given to the attendant. Use the new RAI access method instead. (See “*Additional RAI Access Method*”)

When programming through a normal trunk, perform the following steps:

1. Dial into the DBS through a normal trunk.
2. Ask the operator to place you on hold and dial #6 followed by the private password to transfer you into remote programming.
3. After the DBS responds with REMT>, type **P** and then press **Enter**.
4. Follow the directions on the screen to access the desired program. (See “*Terminal Programming Commands.*”)

## Terminal Programming Through Additional RAI Access Method

(See “*Additional RAI Access Method*”.)

### Terminal Programming Commands

Use the following commands to navigate terminal programming:

Command	Description
~01	Access System parameters
~02	Access Trunk parameters
~03	Access Extension parameters
~04	Access Ring assignments
~05	Access FF-key assignments
~06	Access Name assignments
~07	Access Toll Restriction data
~08	Access Least Cost Routing data
~09	Access Copy mode
~10	Access Speed Dial data
~B	Back to previous address
~b	Back to previous port
~F	Forward to next address
~f	Forward to next port
~R	Return to provide mode
~Ctrl-Z	Quit

## \*Additional RAI Access Method

### Description

In addition to the existing RAI access method, a new RAI access method has been added. A new access code, **#97\*\*\*\***, has been added to the DBS. When this code is dialed, a held call is transferred to the RAI modem. The system then sends a <PASSWORD> prompt and the remote or private password must be entered to connect to terminal programming. This allows more security for passwords since the password does not have to be used by the transferring person or device.

## Programming

No additional programming is required for the DBS. However, if an automated attendant or other device performs the transfer, the automated attendant or other device must be set up to transfer your call by dialing **#97\*\*\*\***.

## Operation

To access the system using the new RAI Access method:

**Note:** The following procedure uses a preprogrammed automated attendant to transfer a call to the RAI.

1. At the PC terminal program, dial into the DBS through a normal trunk.
2. Follow the appropriate method to transfer to the RAI modem.

Normally, an automated attendant will be configured to answer your call, play a message prompting a response (dial 1 to access Sales, 2 to ...etc.) where one of the responses will place you on hold and dial the **#97\*\*\*\*** access code to reach the RAI.

3. Wait a few seconds for the RAI modem to return the modem tone and for your terminal program to connect.
4. If **Password>** is not displayed, press the **Enter** key.
5. When **Password>** is displayed, dial the 4-digit remote or private password.
6. After the DBS responds with **REMT>**, type **P** and then press **Enter**.
7. Follow the directions on the screen to access the desired program. (See *“Terminal Programming Commands”*.)

**Note:** The following procedure has the attendant manually transfer a call to the RAI.

1. Start your PC terminal program.
2. With a telephone connected to the modem, manually dial into the DBS through a normal trunk.
3. When the attendant answers, ask the attendant to dial **#97\*\*\*\*** to transfer your call to the RAI modem.
4. When you hear modem tone, enable your terminal program to connect (usually by selecting **Connect**).
5. If after a few seconds **Password>** is not displayed, press the **Enter** key.

6. When **Password>** is displayed, type the 4-digit remote or private password.
7. After the DBS responds with **REMT>**, type **P** and then press **Enter**.
8. Follow the directions on the screen to access the desired program. (See “*Terminal Programming Commands*”.)

## ISDN Programming Flexibility

### Description

The previous versions did not allow the programming flexibility to accommodate certain central office ISDN configurations. This enhancement allows the flexibility in programming to set the DBS parameters to match certain central office provisioning.

### Programming

**Programming** See *Section 400 - Programming (Appendix K)* for more detailed programming information.

### Operation

N/A

### Notes

UNLESS STATED ALL OTHER DEFAULT VALUES ARE CORRECT.

### Typical Central Office Configurations

#### Lucent (AT&T) 4ESS

- CO Type (0) 4ESS
- NSF- None (0) or MegaCom (2) - Depends on service requested from CO.
- ISDN International Code Deduct **0 1 1**
  - Set to (1) to deduct **0 1 1** from the CO Setup message.
- ISDN Long Distance **1** Code Deduction
- Set to (1) to deduct **1** from the CO Setup message.

**Lucent (AT&T) 5ESS**

- CO Type (1) 5ESS
  - ISDN International Code Deduct **0 1 1**
  - Set to (1) to deduct **0 1 1** from the CO Setup message.

**Nortel (NT) DMS100**

CO Type (3) DMS100 (This is the default setting.)

*The ISDN PRI provides a flexible method of providing access to the Public Switched Telephone Network (PSTN). Because of the many ways that the CO can configure an ISDN span, it is essential that the DBS configuration and the provisioning of the CO are compatible. The following tables identify the critical parameters that must be set for proper operation. These tables also provide a list of information that must be gathered on the CO, as well as the type of information that the CO needs to know about the DBS system.*

#	Info Needed from CO	Comments (examples)
1	Manufacture of CO and software load	5E11 (5ESS with load 11), DMS-100 with NA008
2	Is local dialing 7 digits, 10 digits or a combination?	
3	For long distance dialing, does the CO want to see the leading <b>1</b> ?	<b>1-770-555-1212</b> , or <b>770-555-1212</b>
4	For international dialing, does the CO want to see the leading <b>0 1 1</b> ?	<b>0 1 1</b> -(15-digit number) or (15-digit number)

#	Typical Info for CO	Comments (examples)
1	Installation Address	
2	Is this a new installation?	
3	Extended wiring beyond phone room?	
4	Main phone number of installation	
5	Contact person for installation	
	Contact for order information	

#	Typical Info for CO	Comments (examples)
6	Billing name	
7	Billing address	
8	Long distance Carrier InterLATA (PIC)	Identifies the carrier who will provide long distance access.
9	Long distance Carrier (IntraLATA) (LPIC)	Identifies the carrier who provides access for connections that are not local but are still within the local LATA.
10	Request date of installation	
11	Facility type	ISDN PRI
12	Facility quantity	1 or 2 spans
<b>NOTE:</b> The following items must be provided on a per span basis.		
13	Signaling code	DS-1 (1.544 Mbps)
14	Line coding	B8ZS (Binary 8 Zero Substitution)
15	Framing Format	ESF (Extended Superframe)
16	Bearer configuration	Voice or Voice/Data
17	Quantity of B (bearer) channels	23B + 1D - Max. setting (must have 1 D channel) Or XB + 1D where X is 1-23 for a fractional span
18	Call type	Two Way
19	Quantity of phone numbers	A block of 20 numbers is generally assigned.
9		<b>Note:</b> With DID, the total number of telephones will exceed the total number of B channels.
20	Number of incoming digits to CPE (Customer Premise Equipment - DBS)	Select 4 digits. Used with DID
21	ISDN PRI Protocol	5ESS Custom, DMS-100 Custom (NTNAPRI) or 4ESS
22	Glare Resolution	CPE yield to CO
23	Channel selection used by CO	High-to-Low B-channel selection

#	Typical Info for CO	Comments (examples)
2 4	Source of Calling Party Number	The CO must source the Calling Party Number.
2 5	Service Options	ANI - Automatic Numbering Indication Hunt group - MegaCom -only for 4ESS operation

**Note:** If two spans are implemented, each span has a separate D channel (D channel sharing is NOT permitted).

---

## CPC-EX Version 2.3.2

This section contains the CPC-EX Version 2.32 updates for the Panasonic DBS Digital Business System. It provides a description of each of the changes made to the Panasonic DBS Digital Business System software and hardware included in the system.

### Affected Items

The following hardware and software is affected:

VB-43415 with CPC-EX/BPU

VB-43415/A with CPC-EX/NPU

### Feature Changes

#### Summary

- Transfer Ringing heard During External Call Forward - No Answer on ISDN
- Station Message Detail Recording (SMDR) not Printing Long Distance Calls
- Caller-ID Automatic Number Identification (ANI) is not Sent to the Applications Programming Interface (API) when the Incoming Trunk is ISDN
- SLTA Repeating Digits
- Call Forward Outside Call was Recalled After Recall Timer expired
- System Speed Bins 257-500 Unavailable

#### Change Details

##### **Transfer Ringing heard During External Call Forward - No Answer on ISDN**

In the previous versions, if an incoming ISDN call was transferred to a station that was Call Forward Outside, the called party only heard transfer ringing when the outgoing call from the call forwarded station was answered. The calling party heard talking and transfer ringing. This problem is fixed in version 2.32

##### ***Programming Considerations***

None



### **Station Message Detail Recording (SMDR) not Printing Long Distance Calls**

Previously if FF1 2# 2# 7# was set for long distance only, when a long distance call was placed, it was not recorded by SMDR. SMDR now correctly prints out long distance calls.

#### ***Programming Considerations***

FF1 2# 2# 7#

### **Caller-ID Automatic Number Identification (ANI) is not Sent to the Applications Programming Interface (API) when the Incoming Trunk is ISDN**

In previous versions, Caller-ID (ANI) information was not sent to the API when the incoming trunk was ISDN. In this release, the Caller-ID (ANI) information is sent to the API.

#### ***Programming Considerations***

None

### **SLTA Repeating Digits**

Repeating digits were sent when an SLTA was used on a T1 circuit to call another T1-Network node, or to call out of another T1 node to a CO. If an SLTA was used, to call on a T1 circuit, to another node or out of another node to a CO trunk, once the call was established, if digits were sent from the SLTA, the digits would be repeated.

Example: If you dial 12345 from an SLT, the called party receives 1122334455)

This problem is corrected with this release.

#### ***Programming Considerations***

None

### **Call Forward Outside Call was Recalled After Recall Timer expired**

Previously, if an incoming call was transferred from Station A to Station B (which was set for Call Forward Outside), the following events occurred-- when Station A's Call Forward No Answer Timer expired (after the call was established with an outside CO), the outside connection was terminated, and the call was recalled to Station A. This problem is resolved in this version.

#### ***Programming Considerations***

None

**System Speed Bins 257- 500 Unavailable**

Previously, if a System Speed Dial (SSD) number of 257 or greater was used, System Speed Dial numbers 001 through 256 were reprogrammed. System Speed Dial Bins 257 - 500 are now available.

***Programming Considerations***

None

**A**

- Absence message
  - attendant control 3-7
  - DSLTL 5-4
  - key telephone 4-3
  - SLT 6-3
- Account codes
  - non-verified 4-3
  - verified 4-4
- Alarm
  - DSLTL 5-33
  - key telephone 4-85
- Alternate attendant 3-3
- Answer supervision for voice mail 4-6
- Attendant Features
  - Voice Mail Transfer Key 4-98
- Attendant features 3-1
  - absence message control 3-7
  - alternate attendant 3-3
  - assignment of speed dialing 3-3
  - busy override 3-4
  - call park 3-5
  - dial "0" for attendant 4-42, 5-23, 6-21
  - dial tone disable 3-12, 4-44, 5-24, 6-22
  - DND control 3-7
  - DSS/72 3-13
  - feature package 3-10
  - groups of attendants 3-11
  - headset operation 3-17
  - one-touch voice mail transfer 3-18
  - station lockout code assignment 3-21
  - system time and date control 3-22
  - text assignment 3-8
  - traffic measurement 3-24
  - walking class of service confirmation 3-25
- Auto
  - day mode 4-7
  - set relocation 4-9
- Auto Redial 4-6

**B**

- Background music 4-11

- Barge into busy line 6-5
- Barge-In for Direct Lines 4-6
- Battery backup 4-12
- Blind transfer
  - DSLTL 5-16
  - key telephone 4-25
  - SLT 6-14
- Busy override
  - attendant 3-4
  - DSLTL 5-6
  - SLT 6-5

**C**

- Call
  - coverage groups 4-8
  - duration display 4-9
  - forward ID code for voice mail 4-13
  - forwarding
    - attendant control 3-7
    - DSLTL 5-7
    - key telephone 4-11
    - SLT 6-6
  - hold
    - DSLTL 5-11
    - key telephone 4-17
    - SLT 6-10
  - park
    - attendant 3-5
    - DSLTL 5-12
    - key telephone 4-21
    - SLT 6-11
  - pickup
    - direct 4-22, 6-12
    - DSLTL 5-14
    - group 6-13
    - key telephone 4-22, 4-24
    - SLT 6-12
  - transfer
    - DSLTL 5-16
    - key telephone 4-25
    - SLT 6-14
  - waiting
    - DSLTL 5-19

- key telephone 4-29
- SLT 6-17
- Call waiting/OHVA text reply 4-32
- Callback request
  - DSLTL 5-29
  - key telephone 4-68
- Caller ID 4-14, 4-15
- Camp-on
  - DSLTL 5-21
  - key telephone 4-37
  - SLT 6-19
- Centrex/PBX compatibility 4-16
- Circular hunting 4-47
- Class of service, station 4-45
- CO line key trunk access 4-38
- Conference calls
  - DSLTL 5-22
  - key telephone 4-39
  - SLT 6-20
- Coverage groups 4-8
- D**
- Date, system 3-22
- Day mode, auto 4-7
- Delayed ringing
  - DID 4-18
  - key telephone 4-42
- Dial "0" for attendant
  - DSLTL 5-23
  - key telephone 4-42
  - SLT 6-21
- Dial tone disable 3-12, 4-44, 5-24, 6-22
- Dialing, onhook 5-32
- DID 4-16
  - delayed ringing 4-18
  - night ringing assignment 4-17
  - text name assignment 4-19
- Digital single line telephone
  - see "DSLTL features" 5-1
- Digital telephone features
  - see "Key telephone features" 4-1
- Direct call pickup
  - DSLTL 5-14
  - key telephone 4-22
  - SLT 6-12
- Direct inward dialing
  - see "DID" 4-16
- Direct inward system access
  - see "DISA" 4-20
- Direct line appearances 4-60, 4-62
- Direct Line Barge In 4-6
- Direct trunk access
  - DSLTL 5-24
  - key telephone 4-24
  - SLT 6-23
- DISA 4-20
- Distinctive ringing 4-24
- Distributed hunting 4-49
- DND
  - attendant control 3-7
  - DSLTL 5-25
  - key telephone 4-45
  - SLT 6-23
- DNIS text name assignment 4-19
- Do-not-disturb
  - see "DND" 5-25
- Door box 4-27
- DP to DTMF signal conversion 4-29
- DP/DTMF stations 4-29
- DSLTL features 5-1
  - absence message 5-4
  - blind transfer 5-16
  - busy override 5-6
  - call forwarding 5-7
  - call hold 5-11
  - call park 5-12
  - call pickup 5-14
  - call transfer 5-16
  - call waiting 5-19
  - camp-on 5-21
  - conference calls 5-22
  - dial "0" for attendant 5-23
  - direct call pickup 5-14
  - direct trunk access 5-24
  - DND 5-25
  - group call pickup 5-15
  - illustration 5-3
  - intercom calling 5-26
  - last number redial 5-27
  - meet-me answer 5-28
  - message waiting/callback request 5-29
  - OHVA 5-30

- onhook dialing 5-32
  - personal speed dialing 5-35
  - pooled trunk access 5-32
  - reminder call 5-33
  - saved number redial 5-34
  - screened transfer 5-17
  - speed dialing 5-35
  - system speed dial 5-37, 6-33
  - DSS/72 3-13
  - DSS/BLF line appearances 4-60, 4-61
  - DTMF to DP signal conversion 4-29
  - DTMF/DP stations 4-29
  - Duration display 4-9
- E**
- EM/24 console 4-47
  - Exclusive hold 4-17
  - Extension relocation 4-9
- F**
- FF key extender 4-47
  - FF keys
    - see "Key telephone features" 4-47
  - Flexible function keys
    - see "FF keys" 4-47
  - Forwarding
    - DSLTL 5-7
    - key telephone 4-11
    - SLT 6-6
- G**
- Group call pickup
    - DSLTL 5-15
    - key telephone 4-24
    - SLT 6-13
- H**
- Handsfree
    - answerback 4-54
    - operation 4-55
  - Headset operation
    - attendant 3-17
    - key telephone 4-55
  - Hold
    - DSLTL 5-11
    - exclusive 4-17
    - key telephone 4-17
    - SLT 6-10
    - system 4-18
  - Hunt groups
    - all versions 4-46
    - CPC-B 2.0 and higher 4-49
    - distributed 4-49
    - longest idle 4-49
    - terminal 4-47
    - terminal (CPC-B 2.0 and higher) 4-49
  - Hunting priority for VAUs 4-30
- I**
- Independent timers
    - call forwarding-no answer 4-32
    - CO delayed ring 4-32
    - extension delayed ring 4-32
    - hunt group-no answer 4-32
  - Intercom calling
    - DSLTL 5-26
    - key telephone 4-56
    - SLT 6-25
- K**
- Key telephone features 4-1
    - absence message 4-3
    - Auto Redial 4-6
    - blind transfer 4-25
    - call coverage groups 4-8
    - call duration display 4-9
    - call forwarding 4-11
    - call hold 4-17
    - call park 4-21
    - call pickup 4-22
    - call transfer 4-25
    - call waiting 4-29
    - call waiting/OHVA text reply 4-32
    - camp-on 4-37
    - CO line key trunk access 4-38
    - conference calls 4-39
    - delayed ringing 4-42
    - dial "0" for attendant 4-42
    - direct call pickup 4-22

direct line appearances 4-62  
 direct trunk access 4-24  
 DND 4-45  
 DSS/BLF appearances 4-61  
 EM/24 console 4-47  
 exclusive hold 4-17  
 FF keys 4-47  
 group call pickup 4-24  
 handsfree answerback 4-54  
 handsfree operation 4-55  
 headset operation 4-55  
 illustration 4-3  
 intercom calling 4-56  
 last number redial 4-59  
 line appearances 4-60  
 meet-me answer 4-67  
 message waiting/callback request 4-68  
 ML/MCO separation 4-66  
 multi-CO (MCO) appearances 4-63  
 multi-line (ML) appearances 4-65  
 non-appearing outside lines 4-70  
 offhook signaling 4-71  
 OHVA 4-72  
 one-touch keys 4-74  
 one-touch voice mail access 4-78  
 onhook dialing 4-81  
 personal speed dialing 4-88  
 pooled trunk access 4-81  
 prime line preference 4-83  
 private line 4-84  
 reminder call 4-85  
 ringing line preference 4-87  
 saved number redial 4-87  
 screened transfer 4-27  
 speed dial linking 4-94  
 speed dialing 4-88  
 station lockout 4-96  
 system hold 4-18  
 system speed dialing 4-92  
 trunk-to-trunk transfer 4-97

**L**

Last number redial  
   DSLTL 5-27  
   key telephone 4-59  
   SLT 6-26

LCR 4-33  
 Least cost routing  
   see "LCR" 4-33  
 Line appearances  
   direct 4-62  
   direct line 4-60  
   DSS/BLF 4-60  
   key telephone 4-60  
   multi-CO 4-60  
   multi-CO (MCO) 4-63  
   multi-line (ML) 4-60, 4-65  
   non-appearing outside line 4-70  
 List of features 1-1  
 Lockout for extension 4-96  
 Longest idle hunting 4-49

**M**

Maintenance  
   remote 4-42  
   remote programming mode 4-42  
   remote programming using PCAS 4-44  
 Meet-me answer  
   DSLTL 5-28  
   key telephone 4-67  
   SLT 6-27  
 Message waiting/callback request  
   DSLTL 5-29  
   key telephone 4-68  
   SLT 6-28  
 Messages  
   playing 4-66  
   recording 4-66  
   using two 4-66  
 ML/MCO separation 4-66  
 Multi-CO (MCO) appearances 4-60, 4-63  
 Multi-line (ML) appearances 4-60, 4-65  
 Music  
   background 4-11  
   on hold 4-34

**N**

Naming trunks 4-62  
 Night  
   mode 4-35  
   ringing assignment, DID 4-17

- service 4-35
- Non-appearing outside lines 4-70
- Non-verified account codes 4-3
- O**
- Offhook signaling 4-71
- Offhook voice announce
  - see "OHVA" 6-29
- Off-premises extension adaptor
  - see "OPX adaptor" 4-39
- OHVA
  - DSLTL 5-30
  - key telephone 4-72
  - SLT 6-29
- OHVA/call waiting text reply 4-32
- One-touch
  - keys 4-74
  - voice mail access 4-78
  - voice mail transfer 3-18
- Onhook dialing
  - DSLTL 5-32
  - key telephone 4-81
- OPX adaptor 4-39
- Override busy line 6-5
- P**
- Paging 4-39
  - meet-me answer 4-67, 5-28, 6-27
- Park
  - attendant 3-5
  - DSLTL 5-12
  - key telephone 4-21
  - SLT 6-11
- PBX/centrex compatibility 4-16
- Personal speed dialing
  - DSLTL 5-35
  - key telephone 4-88
  - SLT 6-31
- Pickup
  - direct 4-22, 6-12
  - DSLTL 5-14
  - group 6-13
  - key telephone 4-22, 4-24
  - SLT 6-12
- Playing messages 4-66
- Pooled trunk access
  - DSLTL 5-32
  - key telephone 4-81
  - SLT 6-30
- Port assignment, VAU 4-67
- Power failure
  - transfer 4-41
  - unit 4-41
- Prime line preference 4-83
- Private line 4-84
- R**
- Recording messages 4-66
- Redial
  - Auto 4-6
  - DSLTL 5-27
  - key telephone 4-59
  - saved number 4-87, 5-34
  - SLT 6-26
- Relocating extensions 4-9
- Reminder call
  - DSLTL 5-33
  - key telephone 4-85
- Remote
  - maintenance 4-42
  - programming mode 4-42
  - programming using PCAS 4-44
- Ringing
  - delayed 4-42
  - distinctive 4-24
  - line preference 4-87
- S**
- Saved number redial
  - DSLTL 5-34
  - key telephone 4-87
- Screened transfer
  - DSLTL 5-17
  - key telephone 4-27
  - SLT 6-15
- Sensor 4-28
- Signal conversion, DP to DTMF 4-29
- Single line telephone
  - see "SLT features" 6-1
- SLT features 6-1

- absence message 6-3
- blind transfer 6-14
- busy override 6-5
- call forwarding 6-6
- call hold 6-10
- call park 6-11
- call pickup 6-12
- call transfer 6-14
- call waiting 6-17
- camp-on 6-19
- conference calls 6-20
- dial "0" for attendant 6-21
- direct call pickup 6-12
- direct trunk access 6-23
- DND 6-23
- group call pickup 6-13
- intercom calling 6-25
- last number redial 6-26
- meet-me answer 6-27
- message waiting/callback request 6-28
- OHVA 6-29
- personal speed dialing 6-31
- pooled trunk access 6-30
- screened transfer 6-15
- speed dialing 6-31
- system speed dialing 6-32
- SMDR 4-51
- Speed dialing
  - attendant assignment of 3-3
  - DSLTL 5-35
  - key telephone 4-88
  - linking numbers 4-94
  - personal 4-88, 6-31
  - SLT 6-31
  - system 4-92, 6-32
- Station class of service 4-45
- Station hunting
  - all versions 4-46
  - circular 4-47
  - CPC-B 2.0 and higher 4-49
  - distributed 4-49
  - longest idle 4-49
  - terminal (CPC-A and CPC-B below 2.0) 4-47
  - terminal (CPC-B 2.0 and higher) 4-49
- Station lockout 4-96
- code assignment 3-21, 4-96
- Station Message Detail Recording A-32
- Station message detail recording
  - see "SMDR" 4-51
- System
  - hold 4-18
  - speed dialing
    - DSLTL 5-37, 6-33
    - key telephone 4-92
    - SLT 6-32
  - time and date control 3-22
- System features 4-1
  - account codes 4-3
  - answer supervision for voice mail 4-6
  - auto day mode 4-7
  - auto set relocation 4-9
  - background music 4-11
  - battery backup 4-12
  - call forward ID code for voice mail 4-13
  - Caller ID 4-14, 4-15
  - centrex/PBX compatibility 4-16
  - circular hunting 4-47
  - DID 4-16
  - DID delayed ringing 4-18
  - DID night ringing assignment 4-17
  - DID/DNIS text name assignment 4-19
  - DISA 4-20
  - distinctive ringing 4-24
  - distributed hunting 4-49
  - door box 4-27
  - DP to DTMF signal conversion 4-29
  - DP/DTMF stations 4-29
  - hunting priority for VAUs 4-30
  - independent timers 4-32
  - LCR 4-33
  - longest idle hunting 4-49
  - music-on-hold 4-34
  - night service 4-35
  - non-verified account codes 4-3
  - OPX adaptor 4-39
  - paging 4-39
  - power failure transfer 4-41
  - remote maintenance 4-42
  - remote programming mode 4-42
  - remote programming using PCAS 4-44
  - sensor 4-28



- SMDR 4-51
  - station class of service 4-45
  - station hunting (all versions) 4-46
  - station hunting (CPC-B 2.0 and higher) 4-49
  - T1 interface 4-54
  - terminal hunting (CPC-A and CPC-B below 2.0) 4-47
  - terminal hunting (CPC-B 2.0 and higher) 4-49
  - toll restriction 4-58
  - trunk groups 4-61
  - trunk name assignment 4-62
  - trunk queuing 4-63
  - universal night answer 4-64
  - VAU 4-66
  - VAU port assignment 4-67
  - verified account codes 4-4
  - voice mail ringing 4-65
  - walking TRS class of service 4-68
- T**
- T1 interface 4-54
  - Terminal hunting
    - (CPC-A and CPC-B below 2.0) 4-47
    - (CPC-B 2.0 and higher) 4-49
  - Text assignment, attendant control 3-8
  - Text name assignment
    - DID 4-19
    - DNIS 4-19
  - Time, system 3-22
  - Toll restriction 4-58
    - walking class of service 4-68
  - Traffic measurement 3-24
  - Transfer
    - blind 4-25, 5-16, 6-14
    - DSLTT 5-16
    - key telephone 4-25
    - screened 4-27, 5-17, 6-15
    - SLT 6-14
    - trunk-to-trunk 4-97
  - Transfer Key
    - Voice Mail 4-98
  - Trunk
    - access
      - CO line key 4-38
      - direct 4-24, 5-24, 6-23
      - pooled 4-81, 5-32, 6-30
    - groups 4-61
    - name assignment 4-62
    - queuing 4-63
  - Trunk-to-trunk transfer 4-97
- U**
- UNA 4-64
  - Universal night answer 4-64
  - Using
    - two messages 4-66
  - VAU
    - playing messages 4-66
    - recording messages 4-66
- V**
- VAU 4-66
    - hunting priority 4-30
    - port assignment 4-67
  - Verified account codes 4-4
  - Voice announce unit
    - see "VAU" 4-66
  - Voice mail
    - answer supervision 4-6
    - call forward ID 4-13
    - ringing 4-65
  - Voice Mail Transfer Key 4-98
- W**
- Walking
    - COS confirmation 3-25
    - TRS class of service 4-68

