

Panasonic

Digital Proprietary Telephones
for Digital Super Hybrid Systems

Operating Instructions

Model **KX-T7420**
KX-T7425
KX-T7431
KX-T7433
KX-T7436

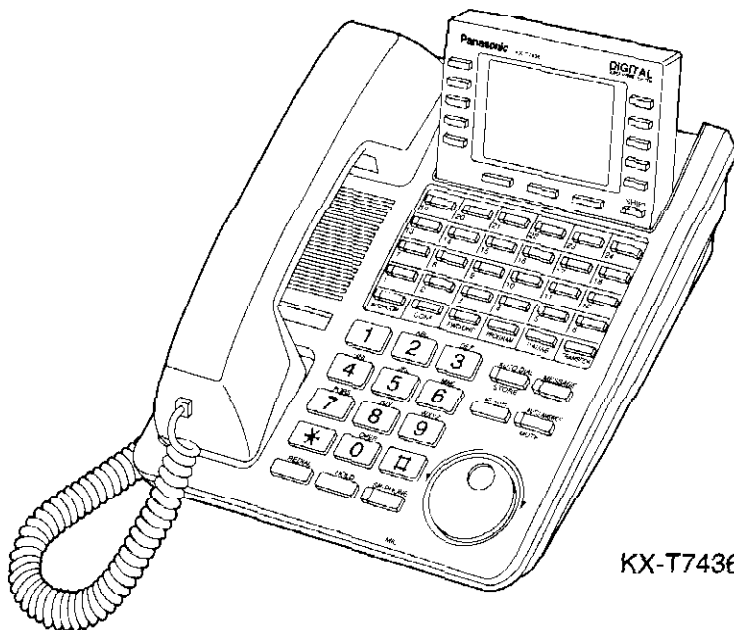

KX-T7436

**Please read this manual before using the
Digital Proprietary Telephone.**

Thank you for purchasing a Panasonic Telephone.

Accessories

When unpacking, check the following items.

- Handset one
- Telephone line cord one
- Handset cord one
- Overlay one (KX-T7431, KX-T7433 and
KX-T7436 only)
- Card holder with memory station card one (KX-T7420, KX-T7425 only)

When you ship the product

Carefully pack and send it prepaid, adequately insured and preferably in the original carton. Attach a postage-paid letter, detailing the symptom to the outside of the carton. *DO NOT send the product to the Executive or Regional Sales offices. They are NOT equipped to make repairs.*

Product service

Panasonic Servicenters for this product are listed in the servicenter directory. Consult your authorized Panasonic dealer for detailed instructions.

For your future reference

SERIAL NO. _____ DATE OF PURCHASE _____
(found on the bottom of the unit)

NAME OF DEALER _____

DEALER'S ADDRESS _____

Contents

Location of Controls	4
Getting Started	6
Connection	6
Controlling the volume/adjusting the display contrast	6
Description of the symbols	7
Making Calls	8
Calling	8
Speed dialing	8
One-touch dialing	8
Dialing the last number you dialed (Last Number Redial)	8
Receiving Calls	9
Receiving calls	9
Handsfree answerback	9
Picking up a call for someone else (Call Pickup)	9
When the Dialed Extension is Busy/No Answer	10
Reserving a busy line (Automatic Callback Busy)	10
Leaving a call notification (Message Waiting)	10
Calling Back	11
When you receive a notification (Message Waiting)	11
Calling using the call log (Incoming Call Log) (KX-T7433/KX-T7436 only)	11
During a Conversation	12
Placing a call on hold	12
Transferring a call	13
Paging	13
Paging a person and transferring a call	14
Answering an announced page	14
Answering a call waiting	14
Useful Features	15
Forwarding your calls (Call Forwarding)	15
Preventing others from disturbing you (Do Not Disturb [DND])	17
Three-party conversation (Conference)	17
Ringing tone selection for CO buttons	18
Storing numbers for One-touch dialing	18
How to Use the Display	19
Using the Jog Dial	19
KX-T7431	20
KX-T7433	21
KX-T7436	23
Storing in Speed Dialing	25
Storing names and numbers at your extension for personal use	25
Storing names and numbers in the system	27
Wall Mounting	28
Installing the Card Holder	29
Features List	30
Important Safety Instructions	32
FCC and Other Information	34

Location of Controls

■ KX-T7431

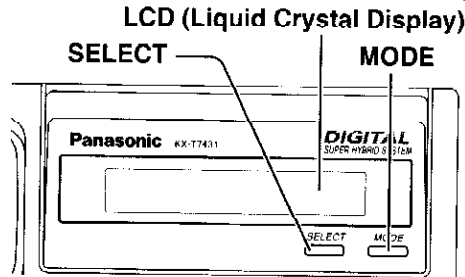



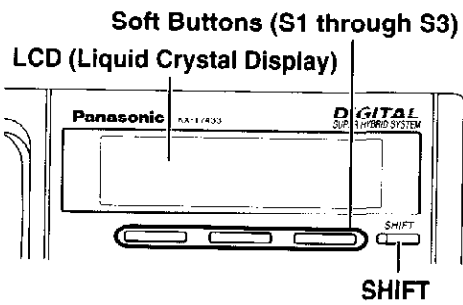



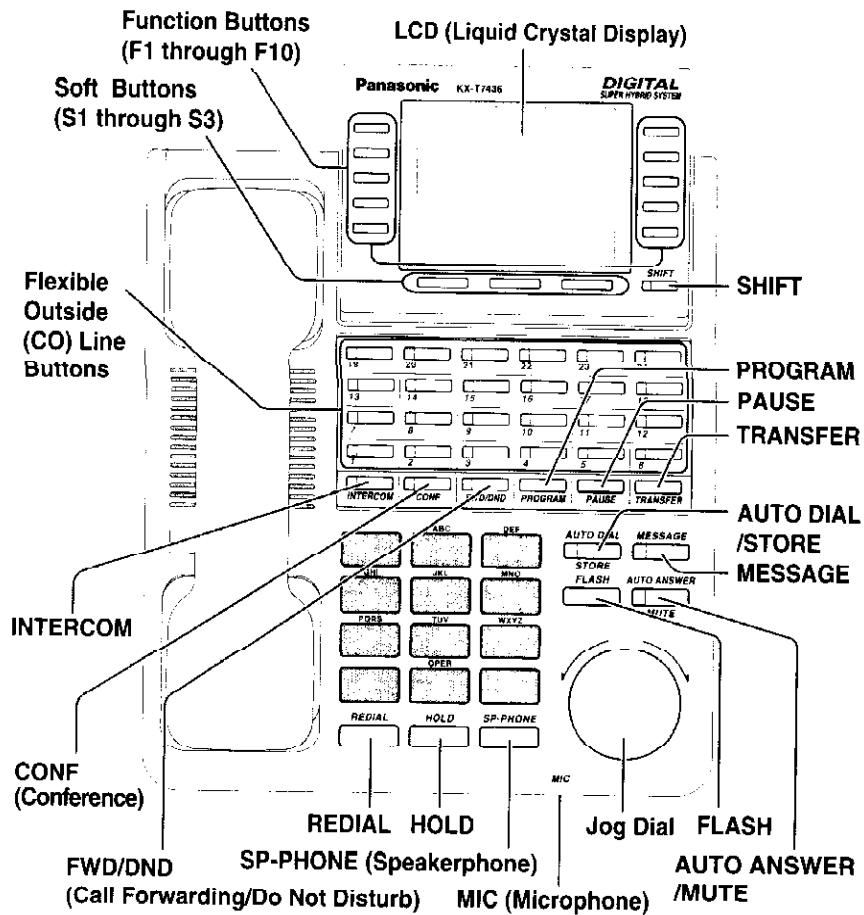



■ KX-T7433













■ KX-T7436



* The KX-T7420 and KX-T7425 are non-display models.

	<p>AUTO ANSWER/MUTE AUTO ANSWER is used to answer an intercom call. MUTE is used to listen to the other party without them hearing you.</p>
	<p>AUTO DIAL/STORE Used for speed dialing in the system or storing program changes.</p>
	<p>CONF Used to make a three-party conference.</p>
	<p>FLASH Used to disconnect the current call and make another call with holding the same outside line.</p>
	<p>Flexible Outside (CO) Line Button Used to make or receive an outside call, or access a feature if the button is assigned as a One-touch dialing button.</p>
	<p>Function Button Used to perform the displayed function or operation.</p>
	<p>FWD/DND Used to perform Call Forwarding or Do Not Disturb.</p>
	<p>HOLD Used to place a call on hold.</p>
	<p>INTERCOM Used to make or receive intercom calls.</p>
	<p>Jog Dial Used to adjust the volume and the display contrast or select desired items for each functions.</p>

	<p>MESSAGE Used to leave a notification or call back the party who left the notification.</p>
	<p>MODE Used to set the display to access a feature.</p>
	<p>PAUSE Used to insert a pause in speed dial numbers or in other numbers.</p>
	<p>PROGRAM Used to enter and exit the programming mode.</p>
	<p>REDIAL Used to redial.</p>
	<p>SELECT Used to select the displayed function or to call the displayed phone number.</p>
	<p>SHIFT Used to alternate the sub function on the display.</p>
	<p>Soft Button Used to perform the function or operation that appears on the bottom line of the display.</p>
	<p>SP-PHONE Used for the handsfree operation.</p>
	<p>TRANSFER Used to transfer a call to another party.</p>

For KX-T7433 and KX-T7436 Users

- The display can be adjusted.
- 1 Press the LCD ADJ button.
 - 2 Lift or put down the display.

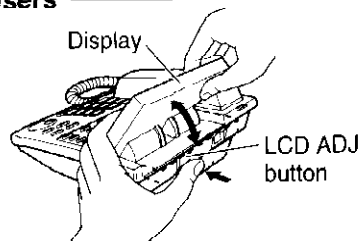

Getting Started

■ Connection

The telephone line cord (included)

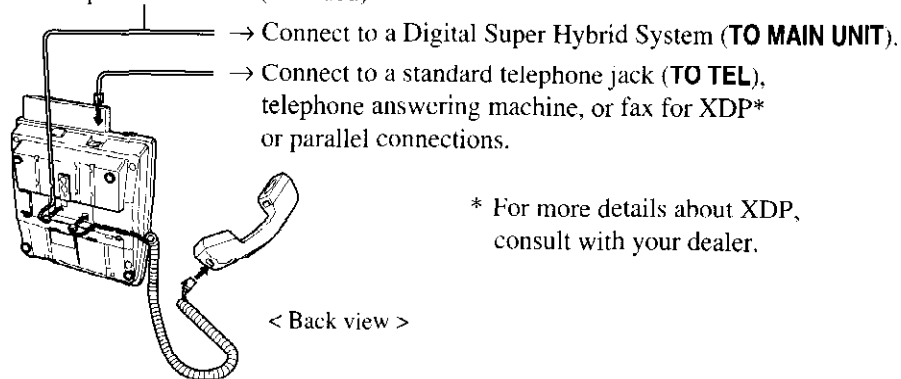

* For more details about XDP, consult with your dealer.

■ Controlling the volume/adjusting the display contrast

Speaker volume

- 1 Press the **SP-PHONE** button.
- 2 Rotate the **Jog Dial** in the desired direction.*

Handset/Headset volume

- 1 Lift the handset.
(Press the **SP-PHONE** button for headset volume.)
- 2 Rotate the **Jog Dial** in the desired direction.*

For KX-T7420 and KX-T7425 Users

Ringer volume

- 1 Adjust the **RINGER Volume selector** lever to the desired setting (OFF/LOW/HIGH).

RINGER Volume selector

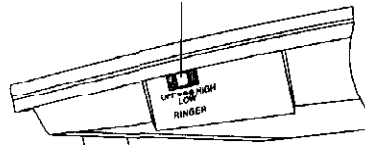

<Side view of the KX-T7420 and KX-T7425>

For KX-T7431 Users

Display contrast

While idle and on-hook

- 1 Press the **MODE** button six times.

Display: Contrast: * * *

- 2 Rotate the **Jog Dial** in the desired direction.*

Ringer volume

While idle and on-hook

- 1 Press the **MODE** button five times.

Display: Ringer: * * *

- 2 Rotate the **Jog Dial** in the desired direction.*

* While rotating the Jog Dial, the display shows the volume level.

For KX-T7433 and KX-T7436 Users

Display contrast

While on-hook or during a conversation

- 1 Press the **CONT (S1)** button.

Display: Contrast: ***

- 2 Rotate the **Jog Dial** in the desired direction.*

Ringer volume

While idle and on-hook

- 1 Press the **RING (S2)** button.

Display: Ringer: ***

- 2 Rotate the **Jog Dial** in the desired direction.*

* While rotating the Jog Dial, the display shows the volume level.

Description of the symbols

In this manual, many symbols are used. Some of the symbols are described below.



Off-hook

- Lift the handset.
- Press the SP-PHONE button.



Press the desired number keys on the telephone.



On-hook

- Replace the handset.
- Press the SP-PHONE button.



Various tones are heard depending on the operation.

Helpful hints for the handsfree operation

- **If the other party's voice is difficult to hear;**
Raise the sound level using the speaker volume control.
- **If the other party has difficulty hearing you;**
Lower the speaker volume.
- **Absorbing echoes;**
Use this unit in a room which has curtains and/or carpeting.
- **To avoid missing part of the conversation;**
If you and the other party speak at the same time, parts of your conversation will be lost. To avoid this, speak alternately.

Making Calls

■ Calling

To an extension

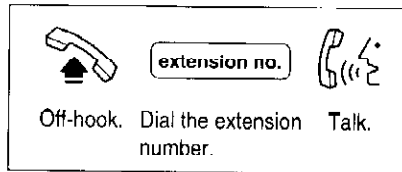

To an external party

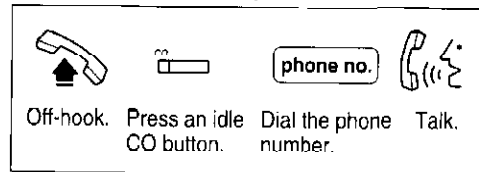

■ Speed dialing

Using a speed dial number stored in your telephone

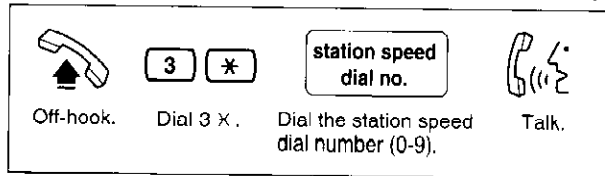

To store numbers, refer to page 25.

Using a speed dial number stored in the system

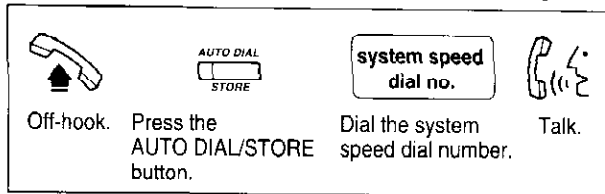

To store numbers, refer to page 27.

■ One-touch dialing

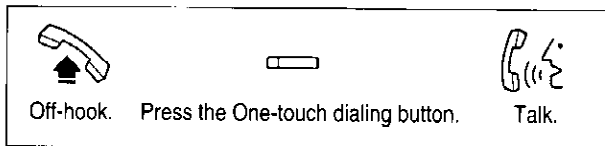

To store numbers, refer to page 18.

■ Dialing the last number you dialed (Last Number Redial)

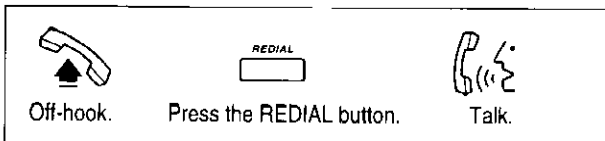

Receiving Calls

■ Receiving calls

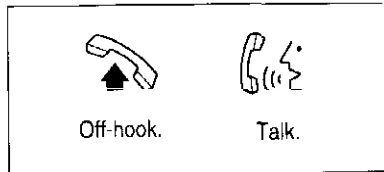

If your telephone rings,

- *Lift the handset or press the SP-PHONE button.*
(Default: The ringing line is selected.)
- *Press the rapid flashing green outside (CO) line button or rapid flashing INTERCOM button.*

■ Handsfree answerback

You can answer an intercom call without lifting the handset.
The AUTO ANSWER/MUTE button light shows the current status as follows.

- On:** Set
- Off:** Not set

To set / cancel

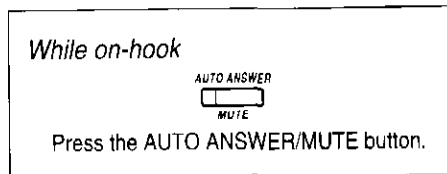

■ Picking up a call for someone else (Call Pickup)

You can answer an incoming call that is ringing at another extension from your telephone. A call within your extension group can be picked up.

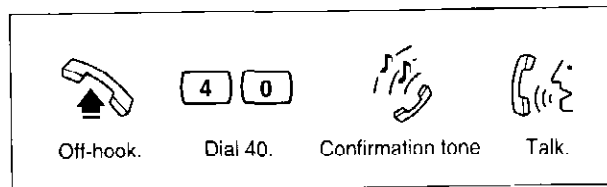



When the Dialed Extension is Busy/No Answer



■ Reserving a busy line (Automatic Callback Busy)

You can receive a notification when a busy extension becomes free.
To answer the notification, lift the handset or press the SP-PHONE button. The called extension starts ringing automatically.

To set

When hearing a busy tone

Dial 6 or press the C.BCK (S3) button.*¹   Confirmation tone On-hook.

To answer and call*²

If you hear call back ringing

 Off-hook

The extension is called automatically.

*¹ The C.BCK (S3) button is only available for KX-T7433 and KX T7436 users.

*² If you do not answer after four callback rings, this feature will be canceled.



■ Leaving a call notification (Message Waiting)

When the called extension is busy or does not answer, you can leave a notification to have the called extension call you back.







To leave a notification

When the called extension is busy or does not answer

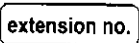

Press the MESSAGE button.   Confirmation tone On-hook.

To cancel a notification

 Off-hook.    Dial 700.  Dial the extension number.   Confirmation tone On-hook.

Calling Back

■ When you receive a notification (Message Waiting)

The MESSAGE button lights to let you know that a call has been received.

To check and select the party (display telephone only)

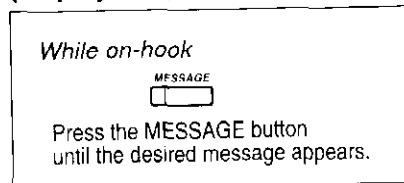

To call back

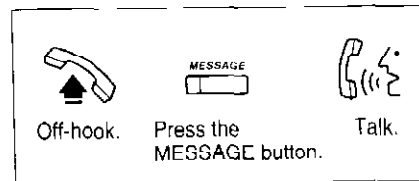

To clear all notifications

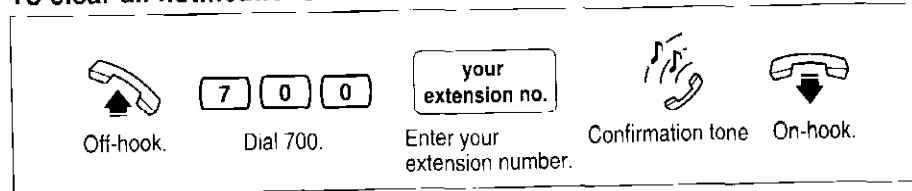

■ Calling using the call log (Incoming Call Log) (KX-T7433/KX-T7436 only)

If you do not answer a call, your telephone automatically records the incoming outside call information with the CLIP (Calling Line Identification Presentation) service*. You can also record the existing call during a conversation or call back the logged numbers. To confirm or call back using the call log, refer to pages 22 (for KX-T7433) and 24 (for KX-T7436).

* The CLIP service provides you with the caller's telephone number.
For more details, consult with your dealer.

To record the information of an existing call

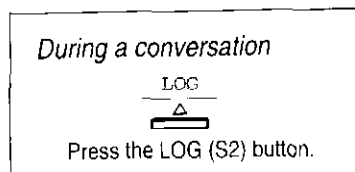

During a Conversation

■ Placing a call on hold

The corresponding outside (CO) line button or the INTERCOM button lights show the current status as follows.

Flashing green slowly: Your held call

Flashing red slowly: Another extension's held call

Holding

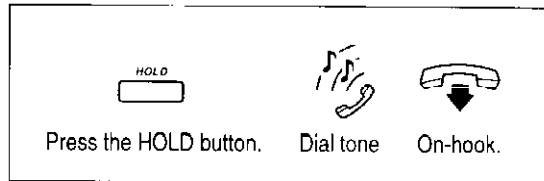

To retrieve a call at the holding extension*

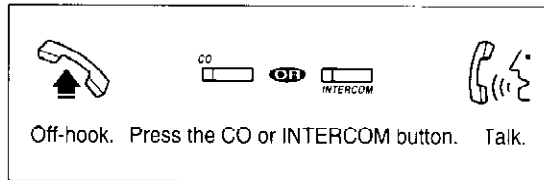

To retrieve an outside call from another extension*

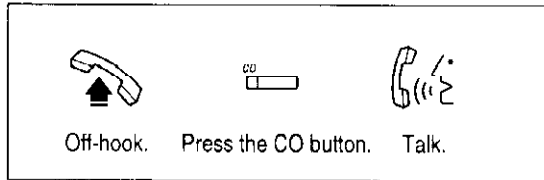

** If a call is not retrieved within a specified time, you will hear an alarm as a reminder.*



■ Transferring a call

Using the TRANSFER button

To an extension

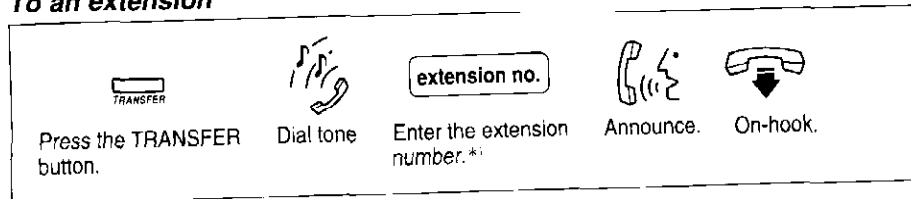

To an external party *2

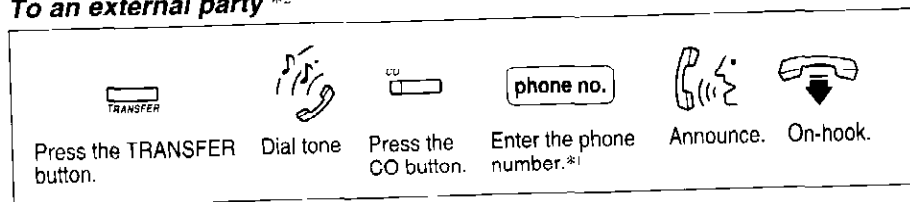

*1 To retrieve the held call, press the TRANSFER button, corresponding Outside (CO) line button, or the INTERCOM button.

*2 Transferring a call to an external party may be restricted by System Programming.

Through Paging

Refer to page 14, "Paging a person and transferring a call".

■ Paging

You can make a voice announcement to all people in the office through the telephone speaker and external speaker at the same time.

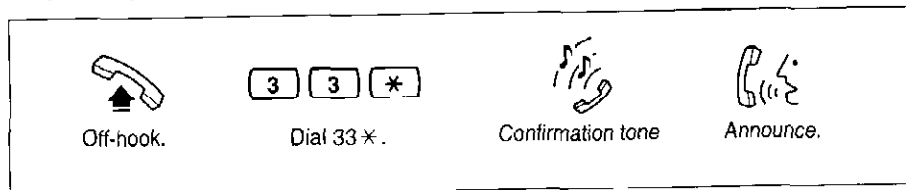

During a Conversation

■ Paging a person and transferring a call

During a conversation

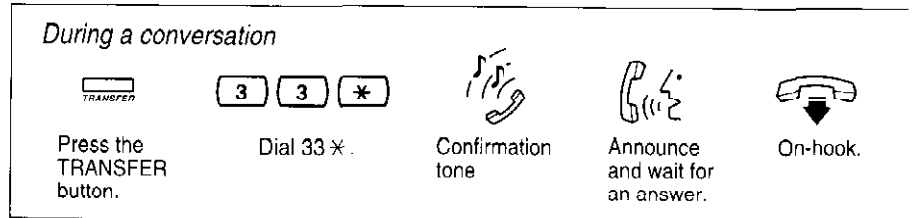

Press the TRANSFER button.

Dial 33 *.

Confirmation tone

Announce and wait for an answer.

On-hook.

■ Answering an announced page

Through a telephone speaker

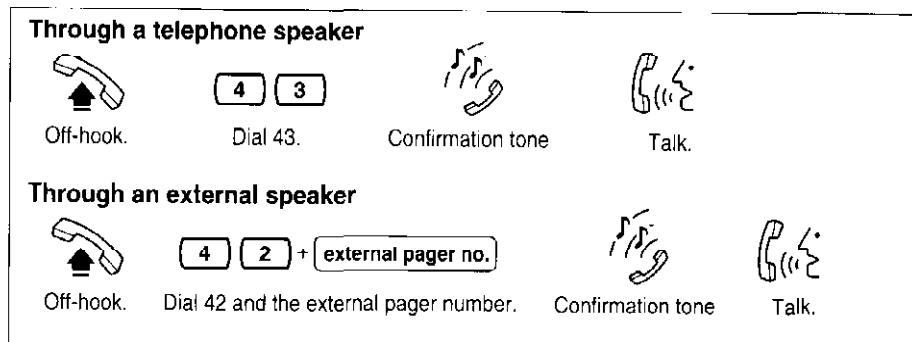

Off-hook.

Dial 43.

Confirmation tone

Talk.

Through an external speaker

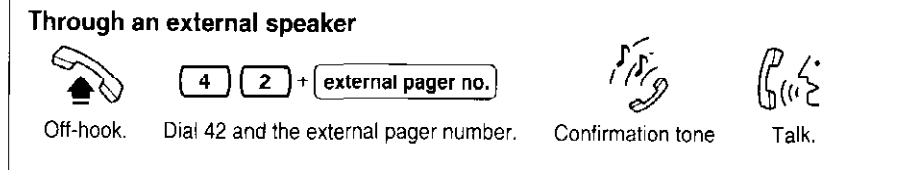

Off-hook.

Dial 42 and the external pager number.

Confirmation tone

Talk.

■ Answering a call waiting

During a conversation, a call waiting tone occurs when an outside call is received or another extension is letting you know that another call is waiting. (Default: Cancel)

To set / cancel

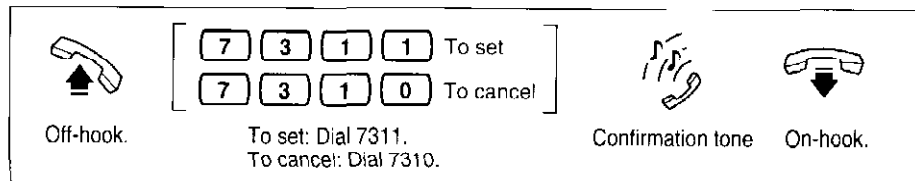

Off-hook.

To set: Dial 7311.
To cancel: Dial 7310.

Confirmation tone

On-hook.

To talk to the new party

While hearing a tone

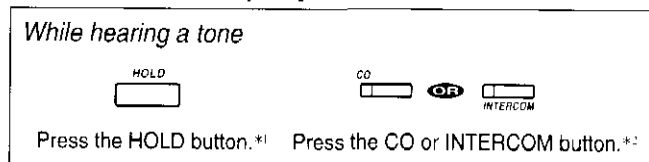

Press the HOLD button.*¹

Press the CO or INTERCOM button.*²

*¹ If you terminate the current call, disregard this step.

*² If both parties are extensions, disregard this step.

Useful Features

■ Forwarding your calls (Call Forwarding)

You can have your incoming calls forwarded to another extension or external party.

All calls

All calls are forwarded to another extension.

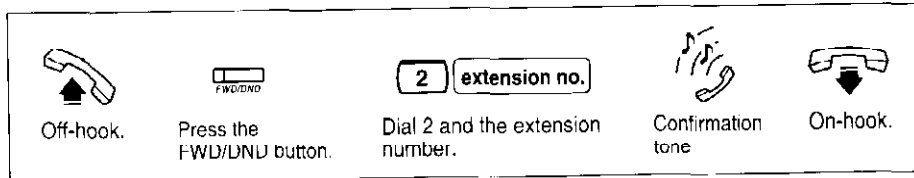

Busy

All calls are forwarded to another extension when your extension is busy.

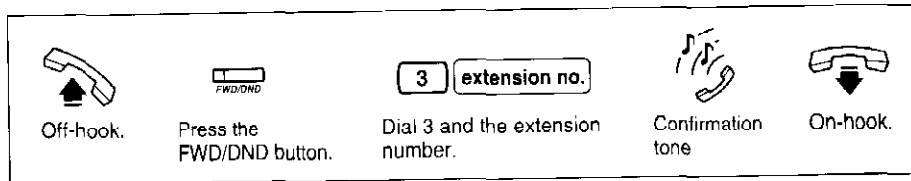

No answer

All calls are forwarded to another extension when you do not answer the call.

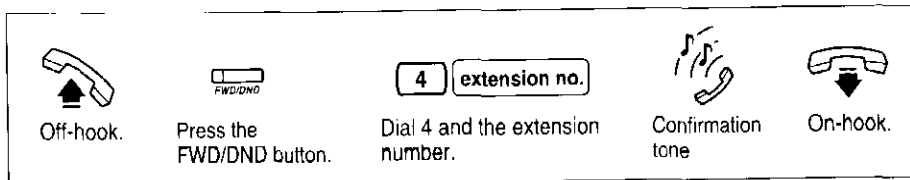

Busy/No answer (BSY N/A)



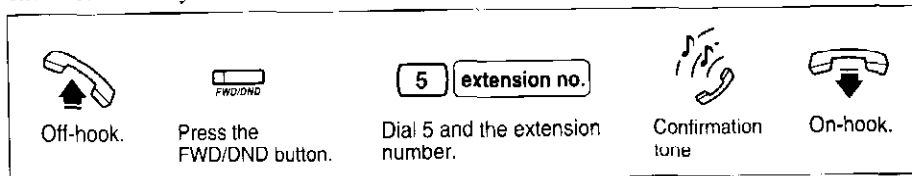





All calls are forwarded to another extension when you do not answer or when your extension is busy.



Useful Features

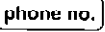



To outside (CO) line

All calls are forwarded to an external party. Some extensions may be restricted.



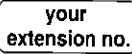

		   		
Off-hook.	Press the FWD/DND button.	Dial 69, the phone number and #.	Confirmation tone	On-hook.

Follow Me (From)







All calls are forwarded to another extension which you set to receive your calls.

		 		
Off-hook.	Press the FWD/DND button.	Dial 7 and your extension number.	Confirmation tone	On-hook.

Canceling (except Follow Me)

				
Off-hook.	Press the FWD/DND button.	Dial 0.	Confirmation tone	On-hook.

Canceling Follow Me

		 		
Off-hook.	Press the FWD/DND button.	Dial 8 and your extension number.	Confirmation tone	On-hook.



■ Preventing others from disturbing you (Do Not Disturb [DND])

During a meeting or when you are busy, you can refuse an incoming call.

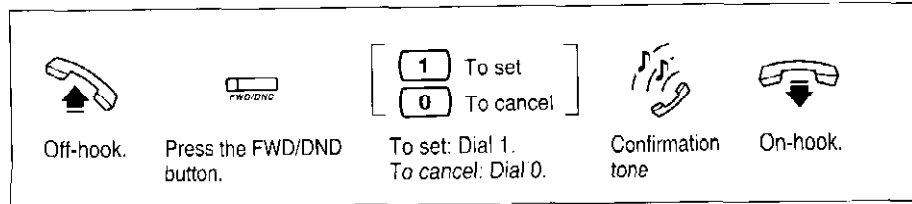

■ Three-party conversation (Conference)

You can add another party during a conversation.

Adding a third party during a conversation

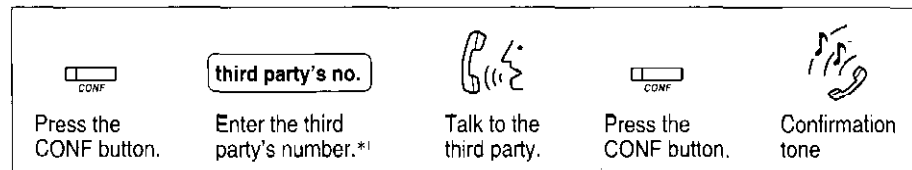

*1 To add an external party, press an outside (CO) line button and dial the phone number.

To talk to one party by terminating the other

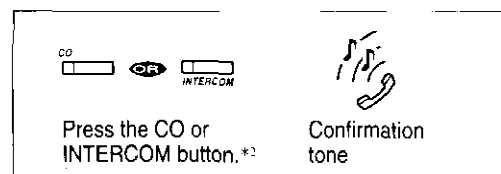

*2 This is only available for a combination of one extension and two outside (CO) lines or two extensions and one outside (CO) line.

*3 If the other parties are both outside lines, they will be disconnected.

Leaving a conference



Useful Features

■ Ringing tone selection for CO buttons

You can select the desired ringer frequency for each outside (CO) line button.

To program

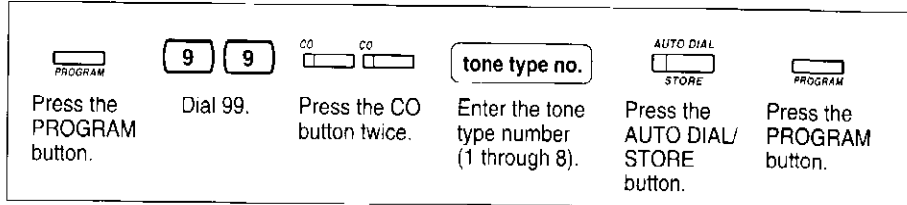

■ Storing numbers for One-touch dialing

The stored number is dialed automatically by pressing an outside (CO) line button which is assigned as a one-touch dialing button.

To program

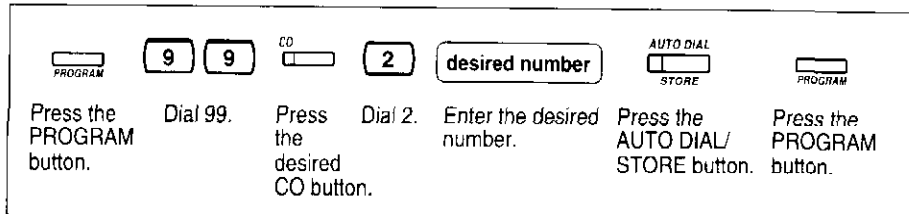

How to Use the Display

■ Using the Jog Dial

Using the display message and the Jog Dial, KX-T7431, KX-T7433 and KX-T7436 users can make a call or operate the features without programming the feature numbers. The displays used in this page are a KX T7431.

Extension Dialing <div style="border: 1px solid black; padding: 2px; width: fit-content; margin: 5px auto;">Extension</div>	You can make an intercom call using the directory.	Only items which have a name assigned are displayed in alphabetical order.
System Speed Dialing <div style="border: 1px solid black; padding: 2px; width: fit-content; margin: 5px auto;">System Speed</div>	You can make a call to a party stored in the system using the directory.	
Station Speed Dialing <div style="border: 1px solid black; padding: 2px; width: fit-content; margin: 5px auto;">Station Speed</div>	You can make a call to a party stored in your telephone using the directory.	Items which have a name assigned are displayed by priority in stored order. If a name is not assigned, the number is displayed.
System Feature Access <div style="border: 1px solid black; padding: 2px; width: fit-content; margin: 5px auto;">Feature Access</div>	You can access the features which are displayed in alphabetical order.*	

* For more details about the accessible features, refer to your Digital Super Hybrid system manual or consult with your dealer.

How to Use the Display

KX-T7431

Operating the feature

- 1 Press the **MODE** button repeatedly to set the display to the Jog Dial function (the second to fifth displays).

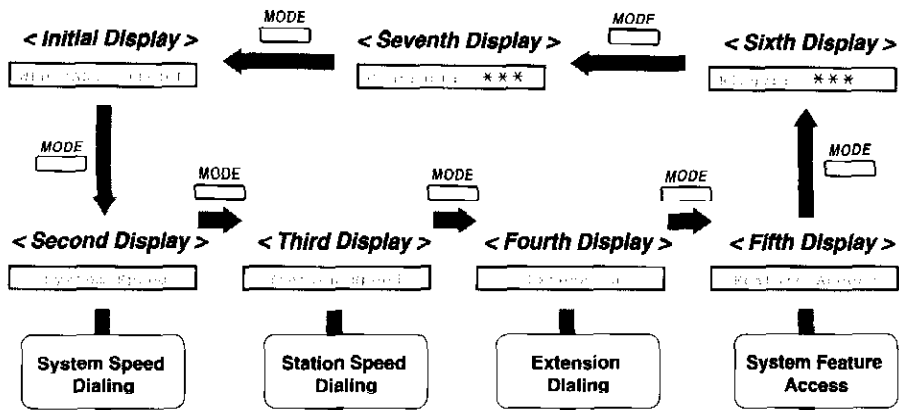

- 2 Rotate the **Jog Dial** until the desired item is at the arrow on the display.

- 3 Press the **SELECT** button.



If a parameter is required, the feature name and parameter will flash.

- 4 Enter a parameter, if required or follow the procedure for standard operation (for System Feature Access only).

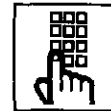



■ KX-T7433

Operating the feature

- 1 Press the **SHIFT** button repeatedly to set the display to the third display.

- 2 Select the desired feature.*
 - Press the **STA** (S1) button (for Station Speed Dialing).
 - Press the **EXT** (S2) button (for Extension Dialing).
 - Press the **FEAT** (S3) button (for System Feature Access).

- 3 Rotate the **Jog Dial** until the desired item is at the arrow on the display.

- 4 • Press the **CALL** (S3) button (for System Speed Dialing, Station Speed Dialing and Extension Dialing).
 - Press the **SEL** (S3) button (for System Feature Access).

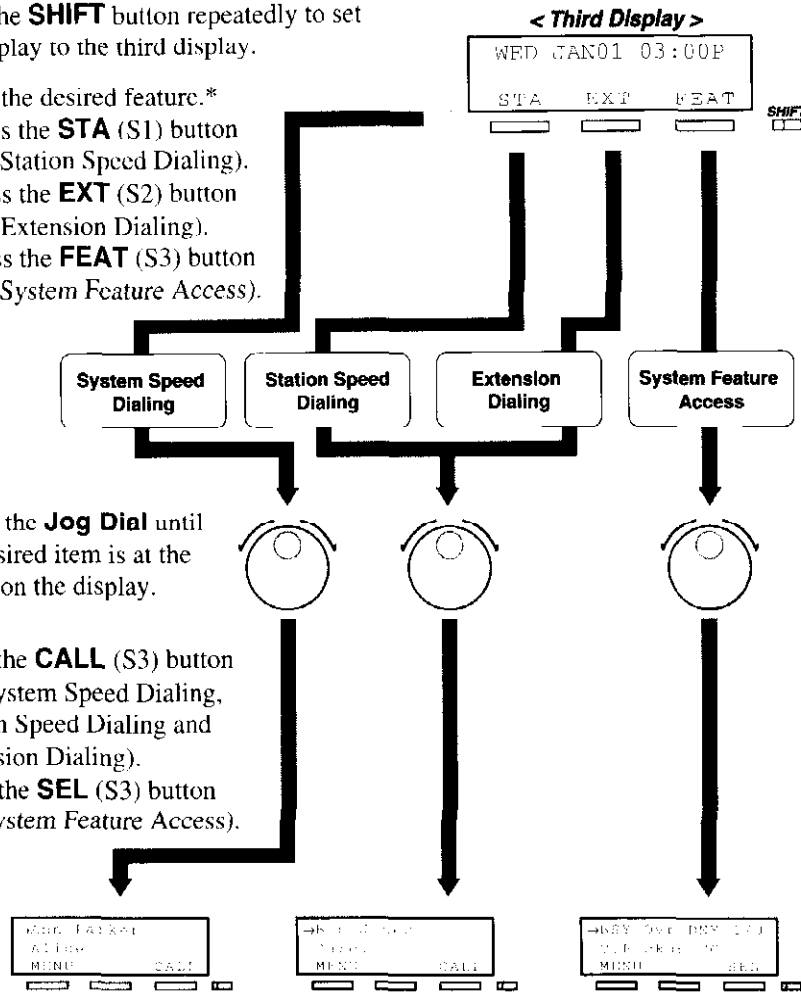

If a parameter is required, the feature name and parameter will flash.

- 5 Enter a parameter, if required or follow the procedure for standard operation (for System Feature Access only).

* Step 2 can be skipped for System Speed Dialing.

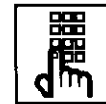

How to Use the Display

Confirming and calling back using the call log

Press the **SHIFT** button to set the display to the second display.

Select the desired call log.

- Press the **OLD** (S1) button to see the confirmed information.
- Press the **NEW** (S2) button to see the unconfirmed information.

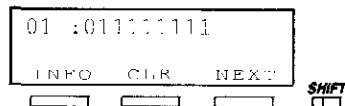
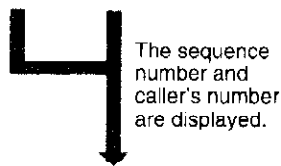
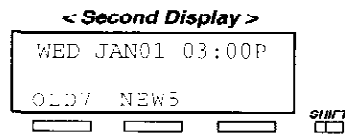

- Press the **INFO** (S1) button to see the information in detail.
- Press the **NEXT** (S3) button to see another caller's information.

Pressing the INFO button provides you with more information.

- Once: sequence number/caller's name
- Twice: date/time/number of times called (30 times max.)
- Three times: outside line number /outside line name

To see another caller's information

Off-hook.



Press the **CALL** (S1) button.

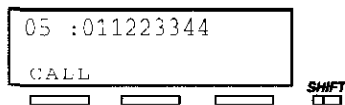



■ KX-T7436

Operating the feature

- 1 Press the **SHIFT** button repeatedly to set the display to the third display.
- 2 Select the desired feature.*
 - Press the **STA** (S1) button (for Station Speed Dialing).
 - Press the **EXT** (S2) button (for Extension Dialing).
 - Press the **FEAT** (S3) button (for System Feature Access).

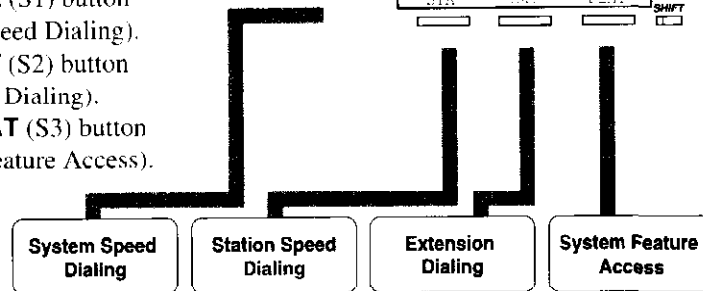
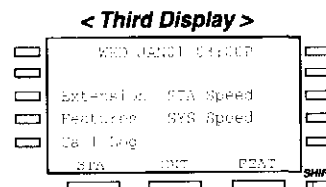

- 3 Rotate the **Jog Dial** until the desired item is at the arrow on the display.
- 4 • Press the **CALL** (S3) button (for System Speed Dialing, Station Speed Dialing and Extension Dialing).
- Press the **SEL** (S3) button (for System Feature Access).
Or press the corresponding buttons on the side of the display (Function button).

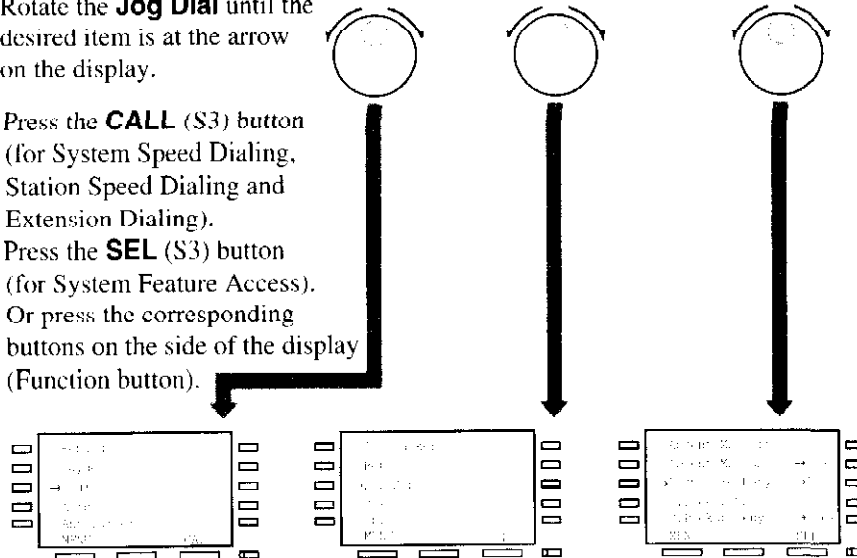

If a parameter is required, the parameter will flash.

- 5 Enter a parameter if required or follow the procedure for standard operation (for System Feature Access only).

* Step 2 can be skipped for System Speed Dialing.

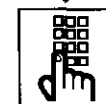

How to Use the Display

Confirming and calling back using the call log

1 Press the **SHIFT** button to set the display to the second display.

- 2 Select the desired call log.
- Press the Function button (call log) to call a number previously dialed (for the outgoing call log).
 - Press the **OLD** (S1) button to see the confirmed call information you received.
 - Press the **NEW** (S2) button to see the unconfirmed call information you received.

3 Press the **NEXT** (S3) button to see another caller's information.*

- 4 • Press the corresponding button on the side of the display (for the outgoing call log).
- Off-hook

5 Press the **CALL** (S1) button.*

* Step 3 and 5 can be skipped for the outgoing call log.

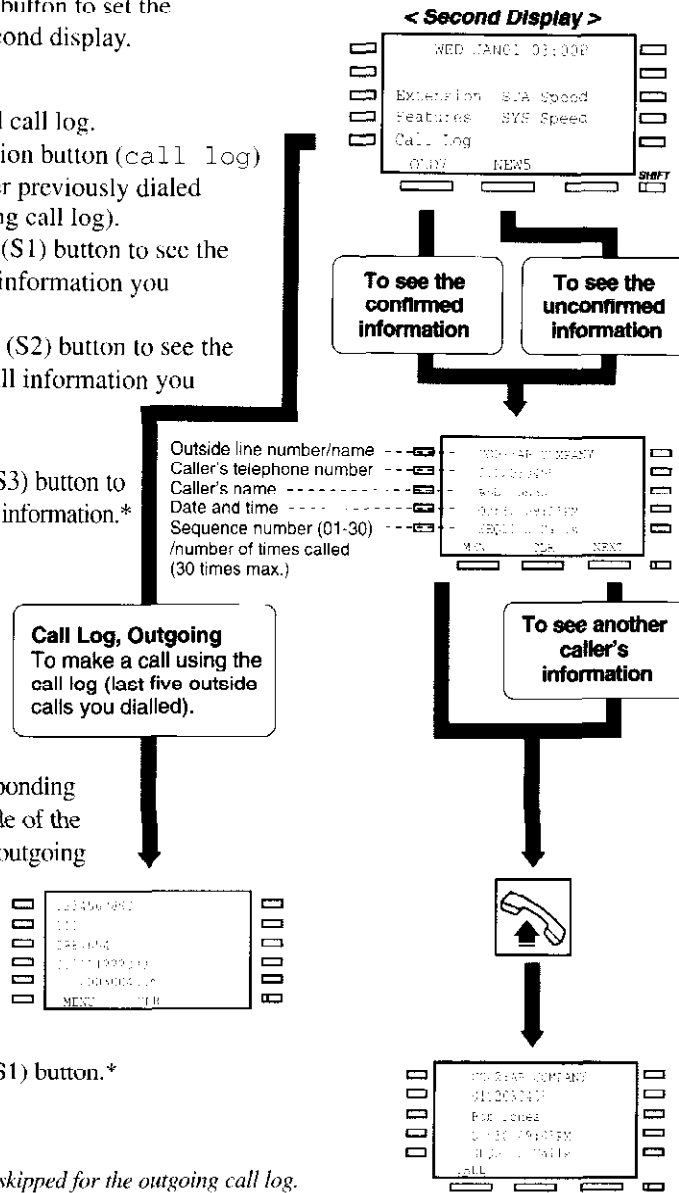

Storing in Speed Dialing

■ Storing names and numbers at your extension for personal use

To store a phone number

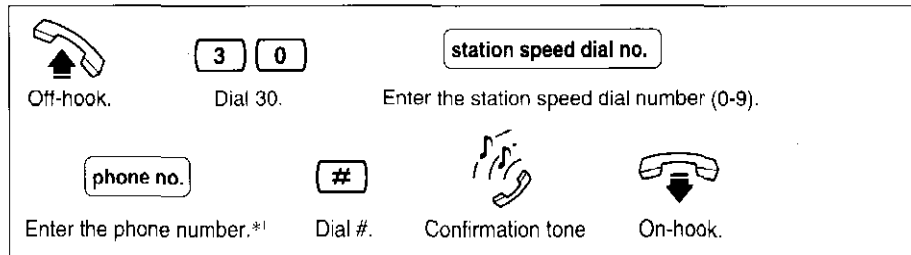

¹ "" and PAUSE can be also stored as digits.

To store a phone number

– For KX-T7431 and KX-T7433 users *²

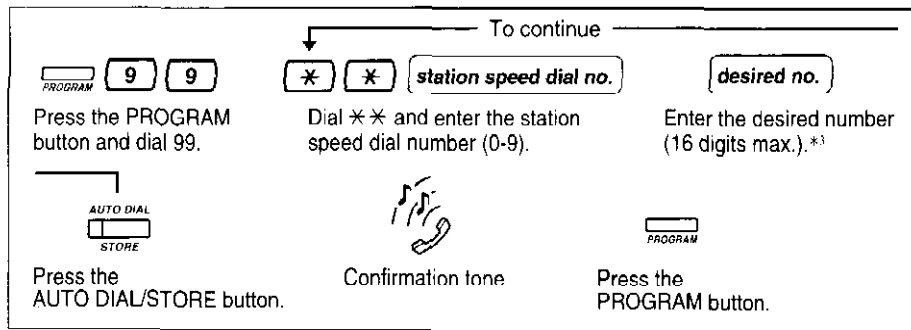

– For KX-T7436 users

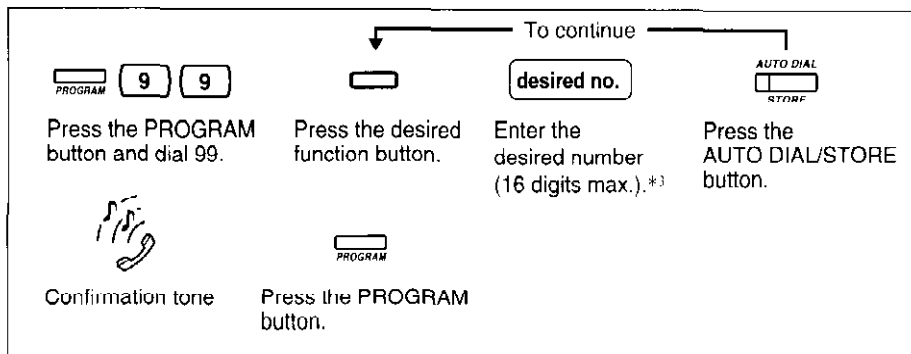

*² This is only available for KX-TD816/1232 users.

³ "", "#", FLASH, SECRET (INTERCOM), -(CONF) and PAUSE can be also stored.

Storing in Speed Dialing

To store a name

- For KX-T7431 and KX-T7433 users *¹

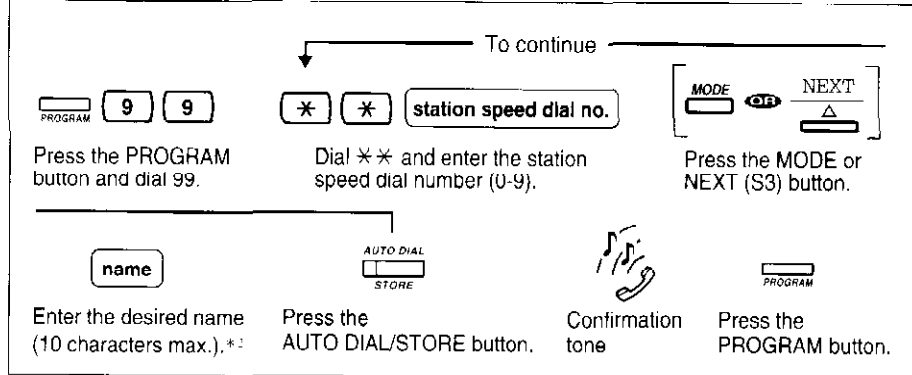

- For KX-T7436 users

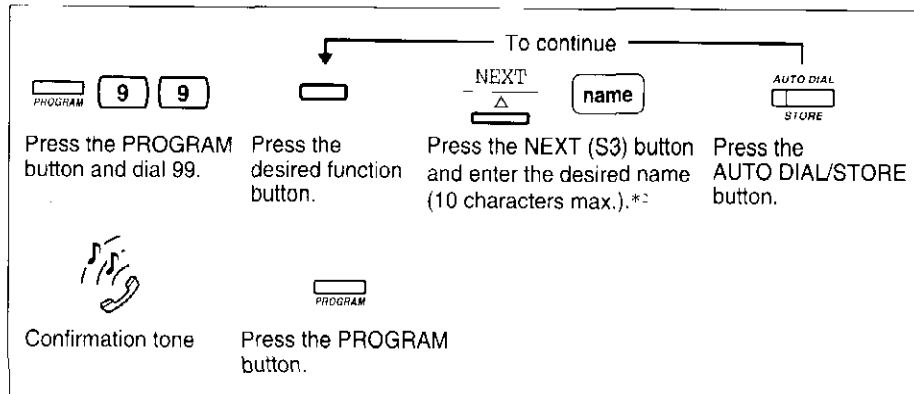

*¹ This is only available for KX-TD816/1232 users.

*² To enter characters, press 2 and rotate the Jog Dial to select the character. You can continue entering characters by pressing 2 and using the jog dial repeatedly. To correct a wrong entry, press the TRANSFER button and enter the new one.









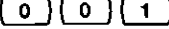

Example: To enter "Mike"

- 1 Press 2, rotate the Jog Dial to enter "M".
- 2 Press 2, rotate the Jog Dial to enter "i".
- 3 Press 2, rotate the Jog Dial to enter "k".
- 4 Press 2, rotate the Jog Dial to enter "e".

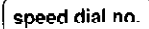







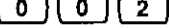

■ Storing names and numbers in the system

As the stored numbers can be used by all of the users in the system, confirm the stored entries with other users.

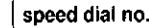
To store a phone number

				
Press the PROGRAM button.	Dial * * .	Enter the user password.	Dial 001.	Press the NEXT (S3) button.
				
Enter the speed dial number (000-499). ^{*1}	Enter the desired number.	Press the AUTO DIAL/STORE button.	Confirmation tone ^{*2}	
				
Press the HOLD button.	Press the PROGRAM button.			

To store a name

				
Press the PROGRAM button.	Dial * * .	Enter the user password.	Dial 002.	Press the NEXT (S3) button.
				
Enter the speed dial number (000-499). ^{*1}	Enter the desired name.	Press the AUTO DIAL/STORE button.	Confirmation tone ^{*2}	
				
Press the HOLD button.	Press the PROGRAM button.			

^{*1} 100 speed dial numbers (00-99) can be stored in the KX-TD308.

^{*2} You can continue entering the number/name by pressing the NEXT (S3) or SP-PHONE button after the confirmation tone.

Wall Mounting

- 1** Remove the handset hook by pulling it toward the top of the unit. Turn it around and re-insert it.

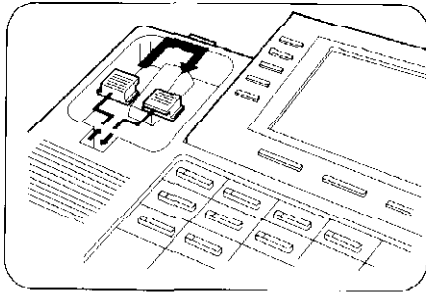

- 4** Insert the stand in the center slots.

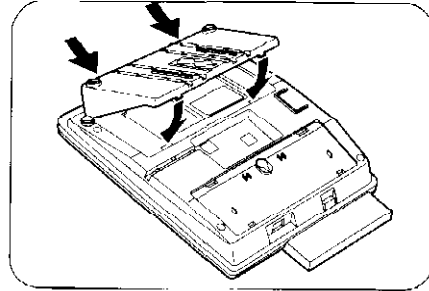

- 2** Remove the attached stand.

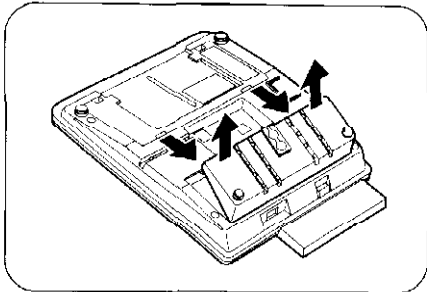

- 5** Mount the unit on the wall.

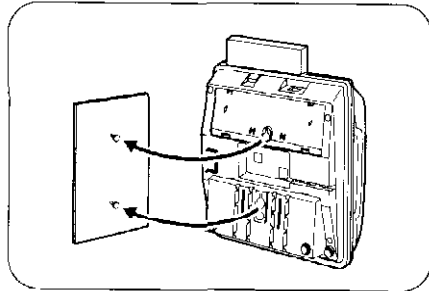

- 3** Turn it around 180 degrees.

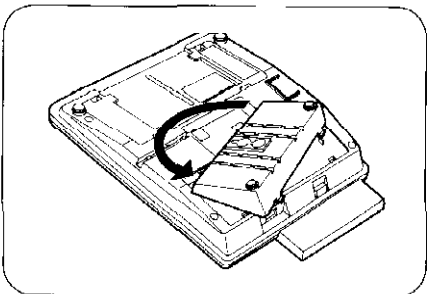

To temporary place the handset down during a conversation.
Hook it over the top edge of the phone as shown.

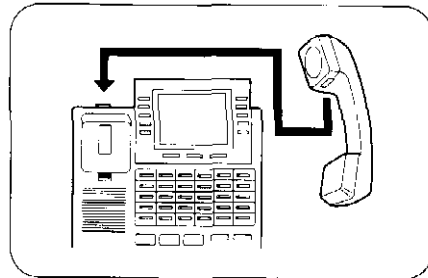

* The illustrations used in this page are a KX-T7436.

Installing the Card Holder

The KX-T7420 and KX-T7425 are equipped with a card holder with memory station card. Follow the instructions below to install the card holder to the unit.

- 1 Place the card holder edges so that they can be inserted under the slide rails on the unit.

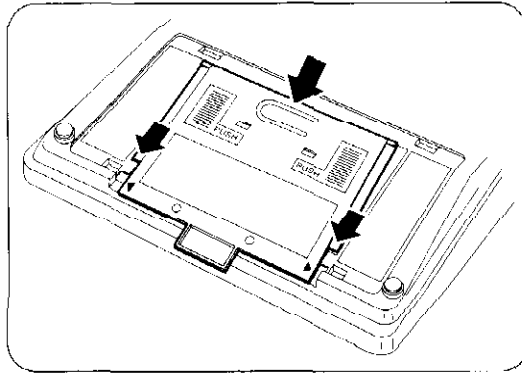

- 2 While pushing on the areas marked "PUSH", insert the edges of the holder under the slide rails and then slide in the direction of arrow (A).

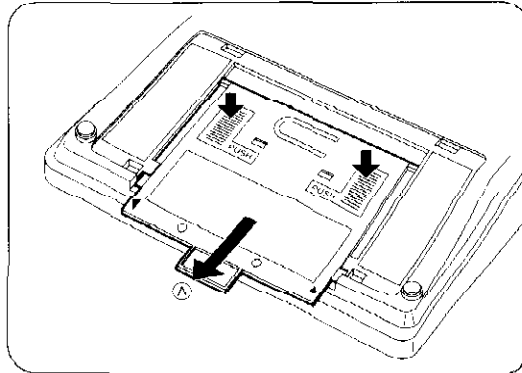





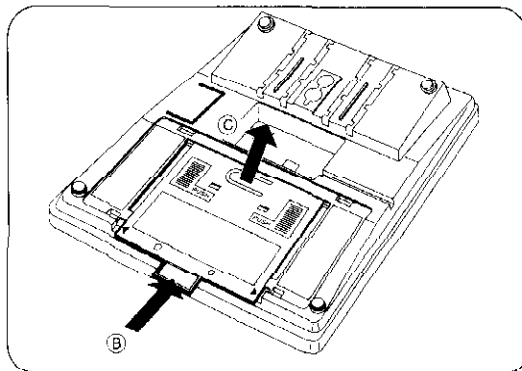







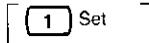
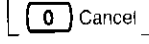

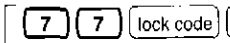

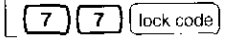







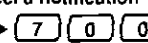
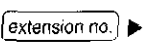





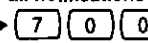
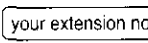





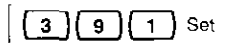
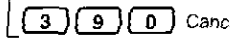

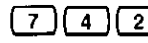
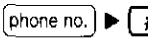



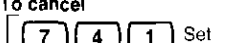
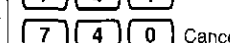

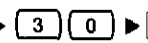
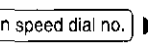
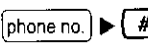

Remove the card holder:

Push the card holder in the direction of arrow (B). Then, while pressing on the tab, pull the top of the holder in the direction of arrow (C).

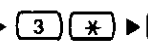
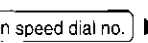

Features List

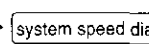
Desired Function	Operation
Setting Absent Message	► 7 5 0 ► message no. ►
Account Code Entry	► 4 9 ► account code + # ► 9 / ► phone no.
Sending a Call Waiting tone (BSS)	1 ►
Forwarding a call	► FWD/IND ► <div style="border: 1px dashed black; padding: 5px; display: inline-block;"> <p>All Calls 2 ► extension no. ► </p> <p>Busy 3 ► extension no. ► </p> <p>No Answer 4 ► extension no. ► </p> <p>Busy / No Answer 5 ► extension no. ► </p> <p>To Outside Line 6 9 ► phone no. ► # ► </p> <p>Follow Me 7 ► your extension no. ► </p> <p>Cancel 0</p> <p>Cancel Follow Me 8 ► your extension no. ► </p> </div>
Holding a call	Holding ► HOLD ►
	To retrieve a call at the holding extension ► CO INTERCOM ►
Holding a call exclusively	Holding ► HOLD ► HOLD ►
	To retrieve a call on exclusive hold ► CO INTERCOM ►
Parking a call in the system	► TRANSFER ► 5 2 ► parking zone no. ►
Picking up a call	► 4 0 ►
Transferring a call	► TRANSFER ► <div style="display: inline-block; border: 1px solid black; padding: 2px;"> extension no. to an extension CO phone no. to an external party </div> ► ► Announce. ►
Call Waiting	► <div style="display: inline-block; border: 1px solid black; padding: 2px;"> 7 3 1 1 Set 7 3 1 0 Cancel </div> ►
Three-party conference	► CONF ► third party's no. ► ► CONF
Paging	► 3 3 * All extensions & external speaker ► Announce.

Desired Function	Operation
Do Not Disturb (DND)	    
Locking your extension	     
Clearing the setting	  
Message Waiting	<p>To leave a notification</p>   <p>To cancel a notification</p>     <p>To call back</p>    <p>To clear all notifications</p>    
Calling an operator	  
Connecting an SLT in parallel	   
Calling a pre-programmed party (Pickup Dialing)	<p>To store</p>      <p>To set / To cancel</p>     <p>To dial</p> 
Speed dialing (Station)	<p>To set</p>       <p>To dial</p>    
Speed dialing (System)	   

Important Safety Instructions

When using your telephone equipment, basic safety precautions should always be followed to reduce the risk of fire, electric shock and injury to persons, including the following:

1. Read and understand all instructions.
2. Follow all warnings and instructions marked on the product.
3. Unplug this product from the wall outlet before cleaning. Do not use liquid cleaners or aerosol cleaners. Use a damp cloth for cleaning.
4. Do not use this product near water, for example, near a bath tub, wash bowl, kitchen sink, or laundry tub, in a wet basement, or near a swimming pool.
5. Do not place this product on an unstable cart, stand, or table. The product may fall, causing serious damage to the product.
6. Slots and openings in the cabinet and the back or bottom are provided for ventilation, to protect it from overheating, these openings must not be blocked or covered. The openings should never be blocked by placing the product on the bed, sofa, rug, or other similar surface. This product should never be placed near or over a radiator or heat register. This product should not be placed in a built-in installation unless proper ventilation is provided.
7. Do not allow anything to rest on the telephone cord. Do not locate this product where the cord will be abused by persons walking on it.
8. Do not overload wall outlets and extension cord as this can result in the risk of fire or electric shock.
9. Never push objects of any kind into this product through cabinet slots as they may touch dangerous voltage points or short out parts that could result in a risk of fire or electric shock. Never spill liquid of any kind on the product.
10. To reduce the risk of electric shock, do not disassemble this product, but take it to a qualified serviceman when some service or repair work is required. Opening or removing covers may expose you to dangerous voltages or other risks. Incorrect reassembly can cause electric shock when the appliance is subsequently used.
11. Unplug this product from the wall outlet and refer servicing to qualified service personnel under the following conditions:
 - A. When the power supply cord or plug is damaged or frayed.
 - B. If liquid has been spilled into the product.
 - C. If the product has been exposed to rain or water.

-
- D. If the product does not operate normally by following the operating instructions. Adjust **only** those controls, that are covered by the operating instructions because improper adjustment of other controls may result in damage and will often require extensive work by a qualified technician to restore the product to normal operation.
- E. If the product has been dropped or the cabinet has been damaged.
- F. If the product exhibits a distinct change in performance.
12. Avoid using a telephone (other than a cordless type) during an electrical storm. There may be a remote risk of electric shock from lightning.
13. Do not use the telephone to report a gas leak in the vicinity of the leak.

SAVE THESE
INSTRUCTIONS

FCC and Other Information

NOTE:

This equipment has been tested and found to comply with the limits for a Class B digital device, pursuant to Part 15 of the FCC Rules. These limits are designed to provide reasonable protection against harmful interference in a residential installation. This equipment generates, uses and can radiate radio frequency energy and, if not installed and used in accordance with the instructions, may cause harmful interference to radio communications. However, there is no guarantee that interference will not occur in a particular installation. If this equipment does cause harmful interference to radio or television reception, which can be determined by turning the equipment off and on, the user is encouraged to try to correct the interference by one or more of the following measures:

Reorient or relocate the receiving antenna.

- Increase the separation between the equipment and receiver.
- Connect the equipment into an outlet on a circuit different from that to which the receiver is connected.
- Consult the dealer or an experienced radio/TV technician for help.

WARNING:

TO PREVENT FIRE OR SHOCK HAZARD, DO NOT EXPOSE THIS PRODUCT TO RAIN OR ANY TYPE OF MOISTURE.

CAUTION:

To assure continued compliance with FCC rules, do not make any unauthorized modifications. When programming emergency numbers and/or making test calls to emergency numbers:

- 1) Remain on the line and briefly explain to the dispatcher the reason for the call before hanging up.
- 2) Perform such activities in the off-peak hours, such as early morning hours or late evenings.

If there is any trouble, disconnect the unit from the extension line and connect a known working phone. If the known working phone operates properly, have it repaired by one of the specified Panasonic Factory Service Centers. If the known working phone does not operate properly, check the Electronic Modular Switching System and the internal extension wiring.

- Keep the unit away from heating appliances and electrical noise generating devices such as fluorescent lamps and motors.
- The unit should be kept free of dust, moisture and vibration, and should not be exposed to direct sunlight.
- Do not use benzine, thinner, or the like, or any abrasive powder to clean the cabinet. Wipe it with a soft cloth.
- Do not use any handset other than Panasonic handset.

This telephone provides magnetic coupling for hearing aids.