

# Panasonic®

## Quick Guide

SIP Cordless Phone

Model No. **KX-TGP500** **B04**

Model No. **KX-TGP500** **T04**

DECT  
**6.0**

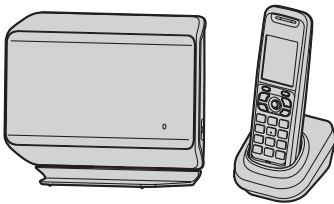

Model shown is KX-TGP500.

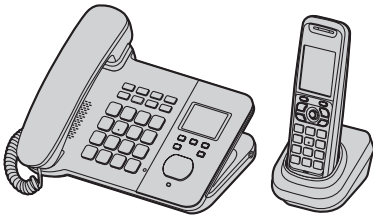

Model shown is KX-TGP550.

**Thank you for purchasing a Panasonic product.**

**Charge the batteries for about 6 hours before initial use.**

Please read this guide before using the unit and save it for future reference.

Panasonic Corporation of North America  
One Panasonic Way, Secaucus, New Jersey 07094

Printed in Malaysia



\*TGP500B04\*

**PNQX2111YA** CM0709SY2030

## **Table of Contents**

---

### **Introduction**

About this guide. . . . .	3
Accessory information. . . . .	3

### **Important Information**

For your safety . . . . .	4
Important safety instructions . . . . .	5
For best performance . . . . .	5
Security caution. . . . .	6
Other information. . . . .	6
Emergency calls . . . . .	7

### **Controls**

Handset. . . . .	8
Base unit . . . . .	9
STATUS indicator on the base unit . . . . .	11

### **Basic Operations**

Making calls using the handset. . . . .	13
Making calls using the base unit (KX-TGP550 only) . . . . .	13
Answering calls using the handset . . . . .	14
Answering calls using the base unit (KX-TGP550 only) . . . . .	15
Hold. . . . .	15
Transferring calls. . . . .	15

### **Setting Up**

Setting up the base unit. . . . .	17
Setting up the handset . . . . .	19
Note when setting up. . . . .	19
Setting network . . . . .	20

### **Open Source Software**

Open Source Software . . . . .	22
--------------------------------	----

### **FCC and Other Information**

FCC and other information . . . . .	30
-------------------------------------	----

## About this guide

This guide explains how to use the basic features of KX-TGP500/KX-TGP550. For further information on operations and customizing your phone, please read the User Guide on the Panasonic Web site at:

<http://panasonic.net/pcc/support/sipphone/>

Contact your administrator for further information.

## Accessory information

### Note:

- See page 17 for setting up the unit.

## Supplied accessories

No.	Accessory item/Order number	Quantity	
		KX-TGP500	KX-TGP550
①	AC adaptor/PQLV219Z or PQLV219 (03)Z	2	2
②	Ethernet cable/PNJA1019Z	1	1
③	Base unit stand <sup>*1</sup> /PNKL1003Z1	1	—
④	Corded handset/PNLXP1007Z	—	1
⑤	Corded handset cord/PQJA212V	—	1
⑥	Rechargeable batteries/HHR-4DPA (Part No. HHR-65AAAABU or N4DHYYY00002)	2	2
⑦	Handset cover <sup>*2</sup> /PNYNTGA641TR	1	1
⑧	Belt clip/PNKE1029Z1	1	1
⑨	Charger/PNWETGP500B	1	1
⑩	Index sticker <sup>*3</sup> /PNQT1735Z	—	1

\*1 The base unit stand comes attached to the base unit.

\*2 The handset cover comes attached to the handset.

\*3 Write down the names of 6 users and attach to the base unit (page 10).

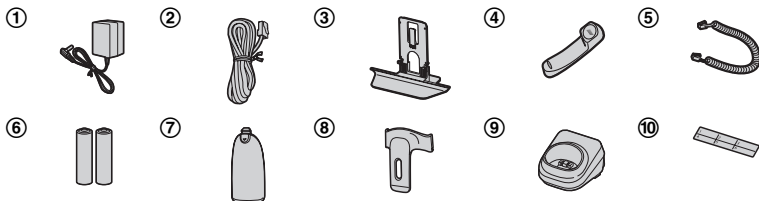

### For your safety

To prevent severe injury and loss of life/property, read this section carefully before using the product to ensure proper and safe operation of your product.

---

#### WARNING

---

##### Power connection

- Use only the power source marked on the product.
- Do not overload power outlets and extension cords. This can result in the risk of fire or electric shock.
- Completely insert the AC adaptor/power plug into the power outlet. Failure to do so may cause electric shock and/or excessive heat resulting in a fire.
- Regularly remove any dust, etc. from the AC adaptor/power plug by pulling it from the power outlet, then wiping with a dry cloth. Accumulated dust may cause an insulation defect from moisture, etc. resulting in a fire.
- Unplug the product from power outlets if it emits smoke, an abnormal smell, or makes an unusual noise. These conditions can cause fire or electric shock. Confirm that smoke has stopped emitting and contact your phone system dealer.
- Unplug from power outlets and never touch the inside of the product if its casing has been broken open.
- Never touch the plug with wet hands. Danger of electric shock exists.

---

##### Installation

- To prevent the risk of fire or electrical shock, do not expose the product to rain or any type of moisture.
- Do not place or use this product near automatically controlled devices such as automatic doors and fire alarms. Radio waves emitted from this product may cause such devices to malfunction resulting in an accident.
- Do not allow the AC adaptor or Ethernet cable to be excessively pulled, bent or placed under heavy objects.

---

##### Operating safeguards

- Unplug the product from power outlets before cleaning. Do not use liquid or aerosol cleaners.
- Do not disassemble the product.
- Do not spill liquids (detergents, cleansers, etc.) onto the Ethernet cable plug, or allow it to become wet at all. This may cause a fire. If the Ethernet cable plug becomes wet, immediately pull it from the LAN (Local Area Network) wall jack, and do not use.
- KX-TGP550 only: Do not excessively pull the corded handset cord from the base unit. This may cause the base unit to fall, resulting in injury.

---

##### Medical

- Consult the manufacturer of any personal medical devices, such as pacemakers or hearing aids, to determine if they are adequately shielded from external RF (radio frequency) energy. (The product operates in the frequency range of 1.92 GHz to 1.93 GHz, and the RF transmission power is 115 mW (max.).)
- Do not use the product in health care facilities if any regulations posted in the area instruct you not to do so. Hospitals or health care facilities may be using equipment that could be sensitive to external RF energy.

---

#### CAUTION

---

##### Installation and relocation

- Never install LAN (Local Area Network) during an electrical storm.
- Never install Ethernet cable jacks in wet locations unless the jack is specifically designed for wet locations.
- Never touch uninsulated LAN (Local Area Network) or terminals unless the LAN (Local Area Network) has been disconnected at the network interface.
- Use caution when installing or modifying LAN (Local Area Network).
- The AC adaptor is used as the main disconnect device. Ensure that the AC outlet is installed near the product and is easily accessible.
- This product is unable to make calls when there is a power failure.

**Battery**

- We recommend using the batteries noted on page 3. **USE ONLY rechargeable Ni-MH batteries AAA (R03) size.**
- Do not mix old and new batteries.
- Do not open or mutilate the batteries. Released electrolyte from the batteries is corrosive and may cause burns or injury to the eyes or skin. The electrolyte is toxic and may be harmful if swallowed.
- Exercise care when handling the batteries. Do not allow conductive materials such as rings, bracelets, or keys to touch the batteries, otherwise a short circuit may cause the batteries and/or the conductive material to overheat and cause burns.
- Charge the batteries provided with or identified for use with this product only, in accordance with the instructions and limitations specified in this manual.
- Only use a compatible charger to charge the batteries. Do not tamper with the charger. Failure to follow these instructions may cause the batteries to swell or explode.

**Attention:**



A nickel metal hydride battery that is recyclable powers the product you have purchased. Please call 1-800-8-BATTERY (1-800-822-8837) for information on how to recycle this battery.

**Important safety instructions**

When using your product, basic safety precautions should always be followed to reduce the risk of fire, electric shock, and injury to persons, including the following:

1. Do not use this product near water for example, near a bathtub, washbowl, kitchen sink, or laundry tub, in a wet basement or near a swimming pool.
2. Avoid using a telephone (other than a cordless type) during an electrical storm. There may be a remote risk of electric shock from lightning.
3. Do not use the telephone to report a gas leak in the vicinity of the leak.
4. Use only the power cord and batteries indicated in this manual. Do not dispose of batteries in a fire. They may explode. Check with local codes for possible special disposal instructions.

**SAVE THESE INSTRUCTIONS**

**For best performance**

**Base unit location/avoiding noise**

The base unit and other compatible Panasonic units use radio waves to communicate with each other.

- For maximum coverage and noise-free communications, place your base unit:
  - at a convenient, high, and central location with no obstructions between the cordless handset and base unit in an indoor environment.
  - away from electronic appliances such as TVs, radios, personal computers, wireless devices, or other phones.
  - facing away from radio frequency transmitters, such as external antennas of mobile phone cell stations. (Avoid putting the base unit on a bay window or near a window.)
- Coverage and voice quality depends on the local environmental conditions.
- If the reception for a base unit location is not satisfactory, move the base unit to another location for better reception.

## Important Information

---

### Environment

- Keep the product away from electrical noise generating devices, such as fluorescent lamps and motors.
- The product should be kept free from excessive smoke, dust, high temperature, and vibration.
- The product should not be exposed to direct sunlight.
- Do not place heavy objects on top of the product.
- When you leave the product unused for a long period of time, unplug the product from the power outlet.
- The product should be kept away from heat sources such as heaters, kitchen stoves, etc. It should not be placed in rooms where the temperature is less than 0 °C (32 °F) or greater than 40 °C (104 °F). Damp basements should also be avoided.
- The maximum calling distance may be shortened when the product is used in the following places: Near obstacles such as hills, tunnels, underground, near metal objects such as wire fences, etc.
- Operating the product near electrical appliances may cause interference. Move away from the electrical appliances.

### Routine care

- **Wipe the outer surface of the product with a soft moist cloth.**
- Do not use benzine, thinner, or any abrasive powder.

---

## Security caution

When using this product, take appropriate measures to avoid the following security breaches.

- Leaks of private information via this product
- Illegal use of this product by a third party
- Interference or suspension of the use of this product by a third party

Take the following measures to avoid security breaches:

- To prevent illegal access, keep the base unit software updated (if you do not have the latest version of software, this can lead to blocked access or information leaks).

Refer to the User Guide on the Panasonic Web site. See page 3 for Panasonic URL.

- You are responsible for the security settings, such as the password for the Web user interface, to access this product. This information should not be made available to any third parties outside the user group. To prevent unauthorized access to this product, we recommend that you regularly change the password.
- Place this product where it is unlikely to be stolen.
- During an internet call, outside interference may occur resulting in improper call transmission and/or unit function.

---

## Other information

**CAUTION:** Risk of explosion if battery is replaced by an incorrect type. Dispose of used batteries according to the instructions.

---

### Notice for product disposal, transfer, or return

- This product can store your private/confidential information. To protect your privacy/confidentiality, we recommend that you erase information such as phonebook or caller list entries, or the password for the Web user interface from the memory before you dispose of, transfer, or return the product. Contact your administrator about resetting the password for the Web user interface.

---

**Notice**

- This product is designed for use in the United States of America. Sale or use of this product in other countries may violate local laws.
- Cet appareil est conçu pour être utilisé aux États-Unis d'Amérique. La vente ou l'emploi de cet appareil dans certains autres pays peut constituer une infraction à la législation locale.
- Este producto está diseñado para usarse en los Estados Unidos de América. La venta o el empleo de este producto en ciertos países puede constituir violación de la legislación local.
- 本產品專為美國使用而設。若在其他國家銷售或使用，可能會違反當地法例。
- この製品は、日本国外での使用を目的として設計されており、日本国内での使用は法律違反となります。従って、当社では日本国内においては原則として修理などのサービスは致しかねます。

---

**Emergency calls**

All lines including unassigned lines are available for emergency calls if the phone numbers are configured in the Web user interface. Availability depends on your phone system. Contact your administrator for further information.

## Handset

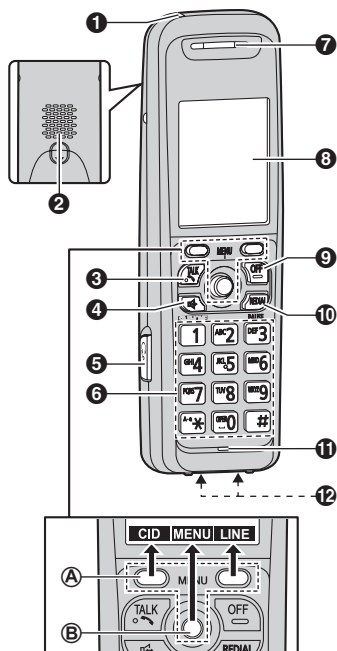

- 1** Charge indicator  
Ringer indicator  
Message indicator
- 2** Speaker
- 3** [TALK]
  - To make calls
- 4** [SP-PHONE: Speakerphone]
  - To talk hands-free
- 5** Headset jack
- 6** Dial keypad
- 7** Receiver
- 8** Display
- 9** [OFF]
  - To stop operation
- 10** [REDIAL] [PAUSE]
- 11** Microphone

## 12 Charge contacts

### ■ Control type

#### Ⓐ Soft keys

The handset features 2 soft keys and a joystick. By pressing a soft key, or by pressing the center of the joystick, you can select the feature shown directly above it on the display.

#### Ⓑ Joystick

By pushing the joystick ([▲], [▼], [◀], or [▶]) repeatedly, you can:

- scroll through (up, down, left, or right) various lists or items
- adjust the receiver or speaker volume (up or down) while talking

## Temporarily switching the handset display mode

You can select to display either a single item or multiple items on one screen at a time for the phonebook list, caller list, and redial list.

You can temporarily switch the handset display mode as follows by pressing the right soft key shown when viewing the lists with:

- **[MULTI]**: Multiple items are shown on one screen at a time.
- **[SINGLE]**: An item is shown on one screen at a time. You can confirm the detailed information.



---

## Base unit

---

### KX-TGP500

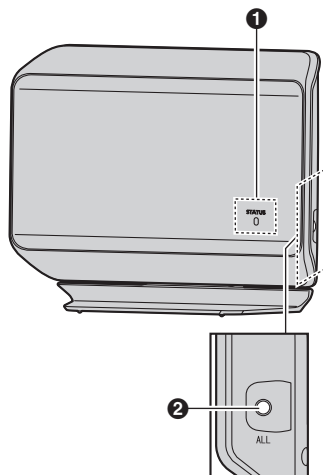

**1 STATUS indicator**

- Indicates the status of the unit and network.

**2 Handset locator button [ALL]**

- Allows you to page all handsets.

KX-TGP550

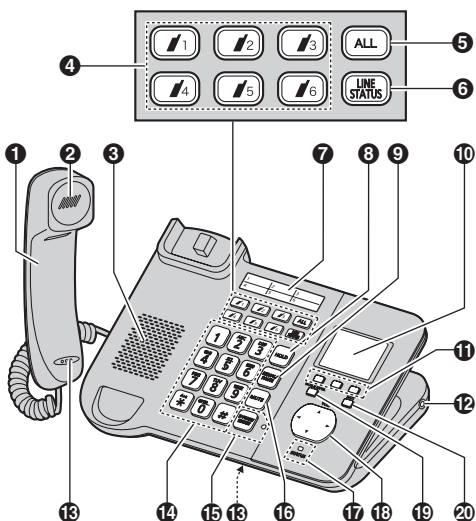

- |  |   |
|--|---|
| <p><b>1</b> Corded handset</p> <p><b>2</b> Receiver</p> <p><b>3</b> Speaker</p> <p><b>4</b> Handset paging buttons ([<b>1</b>] – [<b>6</b>])<br/>Handset status indicators</p> <ul style="list-style-type: none"> <li>Allow you to page each handset. Also they show the status of each handset.</li> </ul> <p><b>5</b> Handset paging button [<b>ALL</b>]</p> <ul style="list-style-type: none"> <li>Allows you to page all handsets.</li> </ul> <p><b>6</b> [<b>LINE STATUS</b>]</p> <ul style="list-style-type: none"> <li>Tells you the status of each line on the display.</li> </ul> <p><b>7</b> Index sticker</p> <ul style="list-style-type: none"> <li>You can write down the names of 6 users on the supplied index sticker and attach it to the base unit.</li> </ul> <p><b>8</b> [<b>HOLD</b>]</p> <p><b>9</b> [<b>REDIAL</b>] [<b>PAUSE</b>]</p> <p><b>10</b> Display</p> | <p><b>11</b> Soft keys</p> <p><b>12</b> Headset jack</p> <p><b>13</b> Microphone</p> <p><b>14</b> Dial keypad</p> <p><b>15</b> [<b>SP-PHONE</b>] [<b>HEADSET</b>]<br/>SP-PHONE indicator</p> <p><b>16</b> [<b>MUTE</b>]</p> <p><b>17</b> <b>STATUS</b> indicator</p> <ul style="list-style-type: none"> <li>Indicates the status of the unit and network.</li> </ul> <p><b>18</b> Navigator key ([<b>▲</b>]/[<b>▼</b>])/[<b>◀</b>]/[<b>▶</b>])<br/>VOL. (Volume: [<b>▲</b>]/[<b>▼</b>])</p> <p><b>19</b> [<b>VOICE MAIL</b>]<sup>*1</sup><br/>VOICE MAIL indicator</p> <p><b>20</b> [<b>EXIT</b>]</p> <ul style="list-style-type: none"> <li>To stop operation</li> </ul> |
|--|---|

\*1 Your phone system needs to support voice mail. Contact your administrator for further information.

## Navigator key/volume key

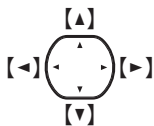

### ■ Scrolling through lists or items

By pressing this key ([▲], [▼], [◀], or [▶]) repeatedly, you can scroll through (up, down, left, or right) various lists or items.

### ■ Adjusting the volume

By pressing this key ([▲] or [▼]) repeatedly, you can adjust the receiver or speaker volume (up or down) while talking.

### ■ Moving the cursor

By pressing this key ([▲], [▼], [◀], or [▶]) repeatedly, you can move the cursor to edit a number or name.

## Soft keys

The base unit features 3 soft keys. By pressing a soft key, you can select the feature shown directly above it on the display.

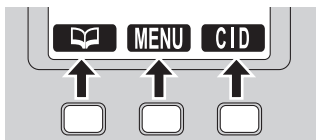

## STATUS indicator on the base unit

During the startup process you may notice that the STATUS indicator on the base unit is flashing. This indicates that the base unit is booting up with your phone system. You may find the following flash patterns helpful:

Status		Meaning
Color	Light pattern	
Green	On	<ul style="list-style-type: none"> <li>The base unit is connected to the Internet. The startup process is complete and you may now make and receive internet calls.</li> </ul>
	Flashing	<ul style="list-style-type: none"> <li>The base unit is downloading data. Do not disconnect the Ethernet cable or AC adaptor from the base unit until the STATUS indicator stops flashing and lights in steady green.</li> </ul>

## Controls

Status		Meaning
Color	Light pattern	
Red	On	<ul style="list-style-type: none"> <li>When the base unit is turned on, the STATUS indicator lights in red for about 10 seconds.</li> </ul>
	Flashing	<ul style="list-style-type: none"> <li>The base unit is registering a handset.</li> </ul>
	Flashing rapidly	<ul style="list-style-type: none"> <li>The base unit is paging handsets. (KX-TGP500 only)</li> </ul>
Amber	On	<ul style="list-style-type: none"> <li>The base unit's IP address may conflict with the IP addresses of other devices on your local network. Contact your administrator for further information.</li> </ul>
	Flashing	<ul style="list-style-type: none"> <li>The base unit is obtaining an IP address or is obtaining configurations. Please wait.</li> <li>The base unit is registering with your phone system. Please wait.</li> <li>If the STATUS indicator continues flashing, check the following:               <ul style="list-style-type: none"> <li>Network settings may not be correct. Contact your administrator.</li> <li>Many installation issues can be resolved by resetting all the equipment. First, shut down your modem, router, hub, base unit, and computer. Then turn the devices back on one at a time in this order: modem, router, hub, base unit, computer.</li> <li>If you cannot access Internet Web pages using your computer, check to see if your phone system is having connection issues in your area.</li> <li>For more troubleshooting help, contact your administrator.</li> </ul> </li> </ul>
	Flashing rapidly	<ul style="list-style-type: none"> <li>Unplug the base unit's AC adaptor to reset the unit, then reconnect the AC adaptor. If the STATUS indicator is still flashing rapidly, there may be a problem with the base unit hardware. Contact your phone system dealer.</li> </ul>
Off	—	<ul style="list-style-type: none"> <li>The base unit power is off.</li> <li>The Ethernet cable is not connected properly. Connect it.</li> <li>Your network devices (hub, router, etc.) are turned off. Check the LEDs for the link status of the devices.</li> <li>The base unit power is booting up.</li> </ul>

## Making calls using the handset

- 1 Lift the handset and dial the phone number.
  - To correct a digit, press **[CLEAR]**.
- 2 Press **[CALL]** or **[↶]**.
  - The unit selects the default line configured by your administrator.
  - You can also select the line manually as follows:  
**[LINE]** → **[▼]/[▲]**: Select the desired line. → **[CALL]**
- 3 When you finish talking, press **[OFF]** or place the handset on the charger.

### Note:

- For further details, please read the User Guide on the Panasonic Web site. See page 3 for Panasonic URL.

## Using the speakerphone

- 1 Dial the phone number and press **[☎]**.
  - The unit selects the default line configured by your administrator.
  - You can also select the line manually as follows:  
**[LINE]** → **[▼]/[▲]**: Select the desired line. → **[☎]**
  - Speak alternately with the other party.
- 2 When you finish talking, press **[OFF]**.

### Note:

- For best performance, use the speakerphone in a quiet environment.
- To switch back to the receiver, press **[↶]**.

## Adjusting the receiver or speaker volume

Push the joystick up or down repeatedly while talking.

## Making a call using the redial list

The last 10 phone numbers dialed are stored in the redial list (each 32 digits max.).

- 1 **[REDIAL]**
- 2 **[▼]/[▲]**: Select the desired phone number.
- 3 **[↶]/[☎]**
  - If **[☎]** is pressed and the other party's line is engaged, the unit automatically redials multiple times. While the handset is waiting to redial, the ringer indicator flashes. To cancel, press **[OFF]**.

## Making calls using the base unit (KX-TGP550 only)

- 1 Dial the phone number.
  - To correct a digit, press **[CLEAR]**.
- 2 Lift the corded handset.
  - The unit selects the default line configured by your administrator.
  - You can also select the line manually as follows:  
**[LINE]** → **[▼]/[▲]**: Select the desired line. → Lift the corded handset.
- 3 When you finish talking, place the corded handset on the cradle.

## Basic Operations

---

### Note:

- You can also dial the phone number after lifting the corded handset.
- For further details, please read the User Guide on the Panasonic Web site. See page 3 for Panasonic URL.

---

## Using the speakerphone

- 1 Dial the phone number and press **[SP-PHONE]**.
  - The unit selects the default line configured by your administrator.
  - You can also select the line manually as follows:  
**[LINE]** → **[▼]/[▲]**: Select the desired line. → Press **[CALL]** or **[SP-PHONE]**.
- 2 When the other party answers, speak into the base unit microphone.
  - Speak alternately with the other party.
- 3 When you finish talking, press **[SP-PHONE]**.

### Note:

- For best performance, use the speakerphone in a quiet environment.
- To switch to the receiver, lift the corded handset.

---

## Adjusting the receiver or speaker volume

Press **[▲]** or **[▼]** repeatedly while talking.

---

## Making a call using the redial list

The last 10 phone numbers dialed are stored in the redial list in each unit (each 32 digits max.).

- 1 **[REDIAL]**

- 2 **[▼]/[▲]**: Select the desired phone number.
- 3 Lift the corded handset or press **[SP-PHONE]**.
  - If **[SP-PHONE]** is pressed and the other party's line is engaged, the unit automatically redials multiple times. While the base unit is waiting to redial, the **SP-PHONE** indicator on the base unit flashes. To cancel, press **[EXIT]**.

---

## Answering calls using the handset

When a call is being received, the ringer indicator on the handset flashes rapidly.

- 1 Lift the handset and press **[CALL]**, **[↶]**, or **[↷]** when the unit rings.
  - You can also answer the call by pressing any dial key from **[0]** to **[9]**, **[\*]**, or **[#]**. (**Any key answer feature**)
- 2 When you finish talking, press **[OFF]** or place the handset on the charger.

---

## Adjusting the handset ringer volume

- **While the handset is ringing for an incoming call:**  
Push the joystick up or down repeatedly to select the desired volume.
- **Programming the volume beforehand:**
  - 1 **[MENU]** (center of joystick) → **[#][1][6][0]**
  - 2 **[▼]/[▲]**: Select the desired volume.
  - 3 **[SAVE]** → **[OFF]**

 Base unit

Available for: KX-TGP550

## Answering calls using the base unit (KX-TGP550 only)

- 1 Lift the corded handset or press **[CALL]** or **[SP-PHONE]** when the unit rings.
- 2 When you finish talking, place the corded handset on the cradle. When the speakerphone is used, press **[SP-PHONE]**.

## Adjusting the base unit ringer volume

### ■ While the base unit is ringing for an incoming call:

Press **[▲]** or **[▼]** repeatedly to select the desired volume.

### ■ Programming the volume beforehand:

- 1 **[MENU]** (middle soft key) → **[#][1][6][0]**
- 2 **[▼]/[▲]**: Select the desired volume.
- 3 **[SAVE]** → **[EXIT]**

## Hold

This feature allows you to put an outside call on hold.

 Handset

- 1 Press **[HOLD]** during an outside call.
- 2 To release hold, press **[HOLD]** or **[↶]**.

## Transferring calls

Outside calls can be transferred to:

- another unit
- an outside party

## Using the handset

### Transferring calls to another unit

- 1 During an outside call, press **[MENU]**.
- 2 **[▼]/[▲]**: “Intercom” → **[SELECT]**
- 3 **[▼]/[▲]**: Select the desired unit. → **[CALL]**
- 4 Wait for the paged party to answer.
  - If the paged party does not answer, press **[↶]** to return to the outside call.
- 5 **[OFF]**

### Transferring calls to an outside party

- 1 During an outside call, press **[MENU]**.
- 2 **[▼]/[▲]**: “Transfer” → **[SELECT]**
- 3 Dial the phone number.

## Basic Operations

---

- To correct the number, press **[CANCEL]** to clear the number and enter again.
- 4 Wait for the paged party to answer.
    - If the paged party does not answer, press **[CANCEL]** 2 times to return to the outside call.
  - 5 **[TRANS]**

---

### Using the base unit

Available for: KX-TGP550
--------------------------

---

#### Transferring calls to another unit

- 1 During an outside call, press **[#1]** – **[#6]** or **[ALL]**.
- 2 Wait for the paged party to answer.
  - If the paged party does not answer, press the same button as in step 1 to return to the outside call.
- 3 Place the corded handset on the cradle.

---

#### Transferring calls to an outside party

- 1 During an outside call, press **[MENU]**.
- 2 **[▼]/[▲]**: “Transfer” → **[SELECT]**
- 3 Dial the phone number.
  - To correct the number, press **[CANCEL]** to clear the number and enter again.
- 4 Wait for the paged party to answer.
  - If the paged party does not answer, press **[CANCEL]** 2 times to return to the outside call.
- 5 **[TRANS]**



## Setting up the base unit

### Connecting the base unit

#### Important:

- Use only the supplied Panasonic AC adaptor PQLV219 or PQLV219 (03).
- Do not connect the Ethernet cable connected to the PoE hub to the computer port of the unit. Doing so may cause severe damage to the unit.

#### KX-TGP500

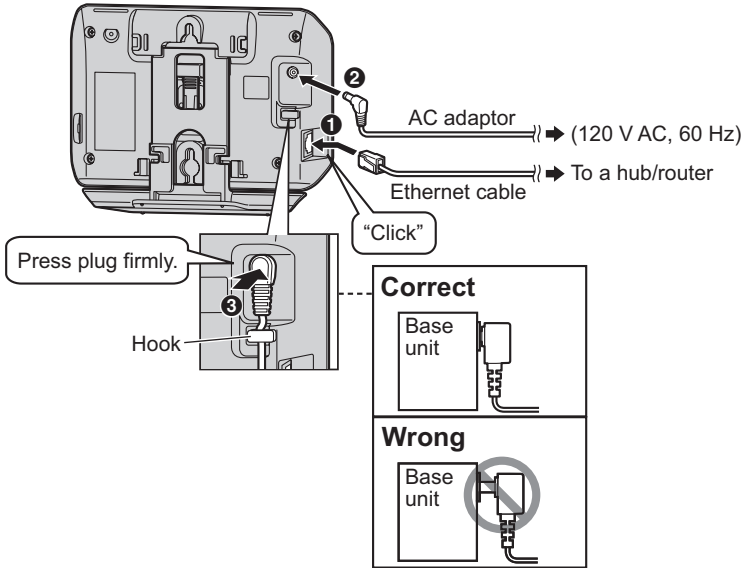

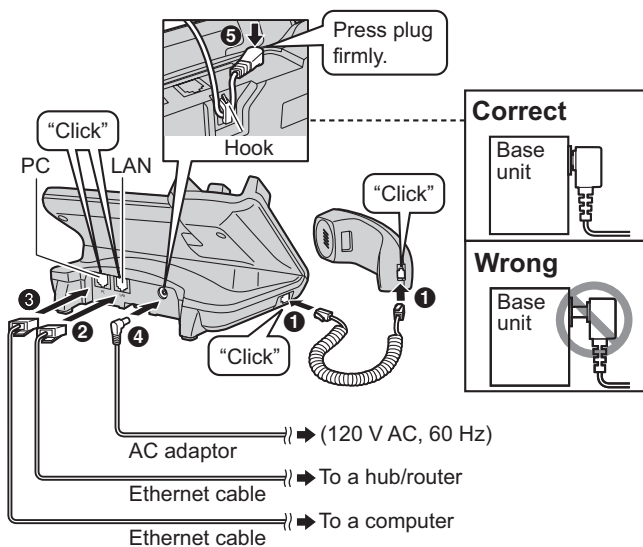

## Setting up the handset

### Connecting the charger

- Use only the supplied Panasonic AC adaptor PQLV219 or PQLV219 (03).

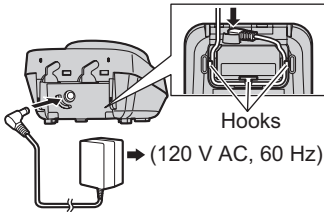

### Battery installation

- USE ONLY Ni-MH batteries AAA (R03) size.
- Do NOT use Alkaline/Manganese/Ni-Cd batteries.
- Confirm correct polarities ( $\oplus$ ,  $\ominus$ ).

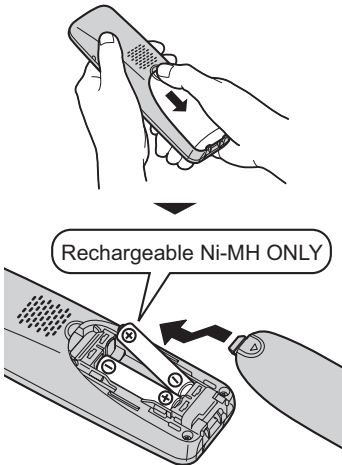

### Battery charge

Charge for about 6 hours.

- When the batteries are fully charged, the charge indicator goes off.

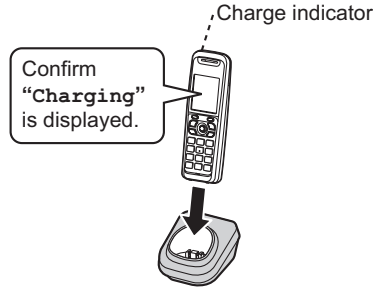

## Note when setting up

### Note for connections

- The AC adaptor must remain connected at all times. (It is normal for the adaptor to feel warm during use.)
- The AC adaptor should be connected to a vertically oriented or floor-mounted AC outlet. Do not connect the AC adaptor to a ceiling-mounted AC outlet, as the weight of the adaptor may cause it to become disconnected.
- The unit will not work during a power failure.

### Note for battery installation





- Use the supplied rechargeable batteries. For replacement, we recommend using the Panasonic rechargeable batteries noted on page 3.
- Wipe the battery ends ( $\oplus$ ,  $\ominus$ ) with a dry cloth.
- Avoid touching the battery ends ( $\oplus$ ,  $\ominus$ ) or the unit contacts.

## Setting Up

### Note for battery charge

- It is normal for the handset to feel warm during charging.
- Clean the charge contacts of the handset and charger with a soft and dry cloth once a month. Clean more often if the unit is exposed to grease, dust, or high humidity.

### Battery level

Icon	Battery level
	High
	Medium
	Low
	Needs charging.
	Empty

### Panasonic Ni-MH battery performance (supplied batteries)

Operation	Operating time
In continuous use	5 hours max.
Not in use (standby)	10 days max.

### Note:

- It is normal for batteries not to reach full capacity at the initial charge. Maximum battery performance is reached after a few complete cycles of charge/discharge (use).
- Actual battery performance depends on a combination of how often the handset is in use and how often it is not in use (standby).
- Even after the handset is fully charged, the handset can be left on the charger without any ill effect on the batteries.
- The battery level may not be displayed correctly after you replace

the batteries. In this case, place the handset on the charger and let it charge for at least 6 hours.

## Setting network

### Important:

- We recommend configuring these settings with your administrator. You can also configure the network settings through the Web user interface. Contact your administrator for further information.

### Automatic setup (default)

#### Turning the DHCP connection mode on

##### Handset

- 1 **[MENU]** (center of joystick) → **[#][5][0][0]**
- 2 **[▼]/[▲]**: “On” → **[SAVE]**
- 3 **[▼]/[▲]**: “Automatic” → **[SAVE]** → **[OFF]**

##### Base unit

#### Available for: KX-TGP550

- 1 **[MENU]** (middle soft key) → **[#][5][0][0]**
- 2 **[▼]/[▲]**: “On” → **[SAVE]**
- 3 **[▼]/[▲]**: “Automatic” → **[SAVE]** → **[EXIT]**

### Static setup

##### Handset

#### Turning the DHCP connection mode off

- 1 **[MENU]** (center of joystick) → **[#][5][0][0]**

- 2 **[▼]/[▲]: “Off” → [SAVE] → [OFF]**

#### Setting the static IP address and other settings

- 1 **[MENU]** (center of joystick) → **[⇦][5][0][1]**
- 2 Set the IP address, subnet mask, default gateway, DNS1, and DNS2.
- Push the joystick down **[▼]** or up **[▲]** to move between the items.
  - To move the cursor, push the joystick right **[▶]** or left **[◀]**.  
To correct digits, press **[CLEAR]**.

- 3 **[SAVE] → [OFF]**

#### Base unit

Available for: KX-TGP550

#### Turning the DHCP connection mode off

- 1 **[MENU]** (middle soft key) → **[⇦][5][0][0]**
- 2 **[▼]/[▲]: “Off” → [SAVE] → [EXIT]**

#### Setting the static IP address and other settings

- 1 **[MENU]** (middle soft key) → **[⇦][5][0][1]**
- 2 Set the IP address, subnet mask, default gateway, DNS1, and DNS2.
- Press **[▼]** or **[▲]** to move between the items.
  - To move the cursor, press **[▶]** or **[◀]**.  
To correct digits, press **[CLEAR]**.
- 3 **[SAVE] → [EXIT]**

# Open Source Software

Parts of this product use Open Source Software. Relevant conditions apply to this software. Panasonic cannot accept inquiries regarding the content of the following copyright and license information.

<<NetBSD kernel>>

This product uses a part of NetBSD kernel.

The use of a part of NetBSD kernel is based on the typical BSD style license below.

Copyright (c)

The Regents of the University of California. All rights reserved.

Redistribution and use in source and binary forms, with or without modification, are permitted provided that the following conditions are met:

1. Redistributions of source code must retain the above copyright notice, this list of conditions and the following disclaimer.
2. Redistributions in binary form must reproduce the above copyright notice, this list of conditions and the following disclaimer in the documentation and/or other materials provided with the distribution.
3. All advertising materials mentioning features or use of this software must display the following acknowledgement:  
This product includes software developed by the University of California, Berkeley and its contributors.
4. Neither the name of the University nor the names of its contributors may be used to endorse or promote products derived from this software without specific prior written permission.

THIS SOFTWARE IS PROVIDED BY THE REGENTS AND CONTRIBUTORS ``AS IS"  
AND  
ANY EXPRESS OR IMPLIED WARRANTIES, INCLUDING, BUT NOT LIMITED TO, THE  
IMPLIED WARRANTIES OF MERCHANTABILITY AND FITNESS FOR A PARTICULAR  
PURPOSE  
ARE DISCLAIMED. IN NO EVENT SHALL THE REGENTS OR CONTRIBUTORS BE  
LIABLE  
FOR ANY DIRECT, INDIRECT, INCIDENTAL, SPECIAL, EXEMPLARY, OR  
CONSEQUENTIAL  
DAMAGES (INCLUDING, BUT NOT LIMITED TO, PROCUREMENT OF SUBSTITUTE  
GOODS  
OR SERVICES; LOSS OF USE, DATA, OR PROFITS; OR BUSINESS INTERRUPTION)  
HOWEVER CAUSED AND ON ANY THEORY OF LIABILITY, WHETHER IN CONTRACT,  
STRICT  
LIABILITY, OR TORT (INCLUDING NEGLIGENCE OR OTHERWISE) ARISING IN ANY  
WAY  
OUT OF THE USE OF THIS SOFTWARE, EVEN IF ADVISED OF THE POSSIBILITY OF  
SUCH DAMAGE.

However, parts of the NetBSD Kernel are provided with the following copyright notices.

Copyright (c) 1980, 1983, 1988, 1993 The Regents of the University of California. All rights reserved.

Copyright (c) 1980, 1986, 1989, 1993 The Regents of the University of California. All rights reserved.



Copyright (c) 1987, 1993 The Regents of the University of California. All rights reserved.  
Copyright (c) 1988 Regents of the University of California. All rights reserved  
Copyright (c) 1988 Stephen Deering.  
Copyright (c) 1988 University of Utah.  
Copyright (c) 1988, 1989, 1993 The Regents of the University of California. All rights reserved.  
Copyright (c) 1988, 1991, 1993 The Regents of the University of California. All rights reserved.  
Copyright (c) 1988, 1992, 1993 The Regents of the University of California. All rights reserved.  
Copyright (c) 1988, 1993 The Regents of the University of California. All rights reserved.  
Copyright (c) 1989 The Regents of the University of California. All rights reserved.  
Copyright (c) 1989, 1991, 1993 The Regents of the University of California. All rights reserved.  
Copyright (c) 1989, 1993 The Regents of the University of California. All rights reserved.  
Copyright (c) 1989, 1993, 1994 The Regents of the University of California. All rights reserved.  
Copyright (c) 1990, 1991, 1993 The Regents of the University of California. All rights reserved.  
Copyright (c) 1990, 1993 The Regents of the University of California. All rights reserved.  
Copyright (c) 1991, 1993 The Regents of the University of California. All rights reserved.  
Copyright (c) 1991, 1993, 1994 The Regents of the University of California. All rights reserved.  
Copyright (c) 1992 Regents of the University of California. All rights reserved.  
Copyright (c) 1992, 1993 The Regents of the University of California. All rights reserved.  
Copyright (c) 1993 The Regents of the University of California. All rights reserved.  
Copyright (c) 1993 Adam Glass  
Copyright (C) 1993 by Sun Microsystems, Inc. All rights reserved.  
Copyright (c) 1994 Gordon W. Ross  
Copyright (c) 1994 Winning Strategies, Inc. All rights reserved.  
Copyright (c) 1995 The Regents of the University of California. All rights reserved.  
Copyright (C) 1995, 1996, 1997, and 1998 WIDE Project. All rights reserved.  
Copyright (c) 1996 The Regents of the University of California. All rights reserved.  
Copyright (c) 1996 John S. Dyson All rights reserved.  
Copyright (c) 1996 Matt Thomas. All rights reserved.  
Copyright (c) 1996 Matthew R. Green. All rights reserved.  
Copyright (c) 1996 Paul Kranenburg  
Copyright (c) 1996, 1997, 1999, 2001 The NetBSD Foundation, Inc. All rights reserved.  
Copyright (c) 1996, 2000 Christopher G. Demetriou. All rights reserved.  
Copyright (c) 1996,1999 by Internet Software Consortium.  
Copyright (c) 1996-1999 by Internet Software Consortium.  
Copyright (c) 1997 Jonathan Stone and Jason R. Thorpe. All rights reserved.  
Copyright (c) 1997 Christos Zoulas. All rights reserved.  
Copyright (c) 1997 Manuel Bouyer. All rights reserved.  
Copyright (c) 1997, 1998 The NetBSD Foundation, Inc. All rights reserved.  
Copyright (c) 1997, 1998, 1999, 2000 The NetBSD Foundation, Inc. All rights reserved.  
Copyright (c) 1997, 1998, 1999, 2001 The NetBSD Foundation, Inc. All rights reserved.  
Copyright (c) 1997, 1998, 1999, 2002 The NetBSD Foundation, Inc. All rights reserved.  
Copyright (c) 1997, 1998, 2000, 2001 The NetBSD Foundation, Inc. All rights reserved.  
Copyright (c) 1997, 1998, 2001 The NetBSD Foundation, Inc. All rights reserved.  
Copyright (c) 1997,98 The NetBSD Foundation, Inc. All rights reserved.  
Copyright (C) 1997-2000 Sony Computer Science Laboratories Inc. All rights reserved.  
Copyright (c) 1997-2002 The NetBSD Foundation, Inc. All rights reserved.  
Copyright (c) 1998 The NetBSD Foundation, Inc. All rights reserved.  
Copyright (c) 1998 Todd C. Miller <Todd.Miller@courtesan.com> All rights reserved.  
Copyright (c) 1998, 1999 The NetBSD Foundation, Inc. All rights reserved.  
Copyright (c) 1998, 1999, 2000 The NetBSD Foundation, Inc. All rights reserved.



Copyright (c) 1998, 1999, 2000, 2001 The NetBSD Foundation, Inc. All rights reserved.  
Copyright (c) 1998, 2000 The NetBSD Foundation, Inc. All rights reserved.  
Copyright (c) 1998, 2000, 2001 The NetBSD Foundation, Inc. All rights reserved.  
Copyright (c) 1999 The NetBSD Foundation, Inc. All rights reserved.  
Copyright (C) 1999 WIDE Project. All rights reserved.  
Copyright (c) 1999, 2000 Jason L. Wright (jason@thought.net) All rights reserved.  
Copyright (c) 1999, 2000 The NetBSD Foundation, Inc. All rights reserved.  
Copyright (c) 1999, 2000, 2001 The NetBSD Foundation, Inc. All rights reserved.  
Copyright (c) 1999, 2001 The NetBSD Foundation, Inc. All rights reserved.  
Copyright (c) 2000 The NetBSD Foundation, Inc. All rights reserved.  
Copyright (c) 2000, 2001 The NetBSD Foundation, Inc. All rights reserved.  
Copyright (c) 2000, 2001, 2002 The NetBSD Foundation, Inc. All rights reserved.  
Copyright (c) 2001 The NetBSD Foundation, Inc. All rights reserved.  
Copyright (c) 2002 The NetBSD Foundation, Inc. All rights reserved.  
Copyright 1998 Massachusetts Institute of Technology. All rights reserved.  
Copyright 2001 Wasabi Systems, Inc. All rights reserved.  
Portions Copyright (c) 1993 by Digital Equipment Corporation.  
Portions Copyright (c) 1995 by International Business Machines, Inc.  
Copyright (c) 1983, 1989 The Regents of the University of California. All rights reserved.  
Copyright (c) 1996 by Internet Software Consortium. All rights reserved.  
Copyright (c) 1980, 1986, 1989 Regents of the University of California. All rights reserved.  
Copyright (c) 1988 The Regents of the University of California. All rights reserved.  
Copyright (c) 1992, 1993 The Regents of the University of California. All rights reserved.  
Copyright (c) 1994 Christopher G. Demetriou. All rights reserved.  
Copyright (c) 1997 The NetBSD Foundation, Inc. All rights reserved.  
Copyright (c) 1999 The NetBSD Foundation, Inc. All rights reserved.  
Copyright (c) 2001 The NetBSD Foundation, Inc. All rights reserved.  
Copyright (c) 1996 Gardner Buchanan <gbuchanan@shl.com> All rights reserved.

Parts of the NetBSD Kernel are provided with the licenses that are slightly different from the above Berkeley-formed license. Please refer the source code of the NetBSD Kernel about the details.

The source code of the NetBSD Kernel is provided by the NetBSD CVS Repositories (<http://cvsweb.netbsd.org/bsdweb.cgi/>), and this product includes parts of the source code in the

following directories.

<http://cvsweb.netbsd.org/bsdweb.cgi/src/sys/kern/>

<http://cvsweb.netbsd.org/bsdweb.cgi/src/sys/net/>

<http://cvsweb.netbsd.org/bsdweb.cgi/src/sys/netinet/>

<<OpenSSL>>

The product includes software developed by the OpenSSL Project and it is used under the following license.

### LICENSE ISSUES

=====

The OpenSSL toolkit stays under a dual license, i.e. both the conditions of the OpenSSL License and the original SSLeay license apply to the toolkit. See below for the actual license texts. Actually both licenses are BSD-style Open Source licenses. In case of any license issues related to OpenSSL please contact [openssl-core@openssl.org](mailto:openssl-core@openssl.org).

OpenSSL License

-----

/\* =====

## Open Source Software

---

\* Copyright (c) 1998-2004 The OpenSSL Project. All rights reserved.

\*

\* Redistribution and use in source and binary forms, with or without  
\* modification, are permitted provided that the following conditions  
\* are met:

\*

\* 1. Redistributions of source code must retain the above copyright  
\* notice, this list of conditions and the following disclaimer.

\*

\* 2. Redistributions in binary form must reproduce the above copyright  
\* notice, this list of conditions and the following disclaimer in  
\* the documentation and/or other materials provided with the  
\* distribution.

\*

\* 3. All advertising materials mentioning features or use of this  
\* software must display the following acknowledgment:  
\* "This product includes software developed by the OpenSSL Project  
\* for use in the OpenSSL Toolkit. (<http://www.openssl.org/>)"

\*

\* 4. The names "OpenSSL Toolkit" and "OpenSSL Project" must not be used to  
\* endorse or promote products derived from this software without  
\* prior written permission. For written permission, please contact  
\* [openssl-core@openssl.org](mailto:openssl-core@openssl.org).

\*

\* 5. Products derived from this software may not be called "OpenSSL"  
\* nor may "OpenSSL" appear in their names without prior written  
\* permission of the OpenSSL Project.

\*

\* 6. Redistributions of any form whatsoever must retain the following  
\* acknowledgment:

\* "This product includes software developed by the OpenSSL Project  
\* for use in the OpenSSL Toolkit (<http://www.openssl.org/>)"

\*

\* THIS SOFTWARE IS PROVIDED BY THE OpenSSL PROJECT ``AS IS'' AND ANY  
\* EXPRESSED OR IMPLIED WARRANTIES, INCLUDING, BUT NOT LIMITED TO, THE  
\* IMPLIED WARRANTIES OF MERCHANTABILITY AND FITNESS FOR A PARTICULAR  
\* PURPOSE ARE DISCLAIMED. IN NO EVENT SHALL THE OpenSSL PROJECT OR  
\* ITS CONTRIBUTORS BE LIABLE FOR ANY DIRECT, INDIRECT, INCIDENTAL,  
\* SPECIAL, EXEMPLARY, OR CONSEQUENTIAL DAMAGES (INCLUDING, BUT  
\* NOT LIMITED TO, PROCUREMENT OF SUBSTITUTE GOODS OR SERVICES;  
\* LOSS OF USE, DATA, OR PROFITS; OR BUSINESS INTERRUPTION)  
\* HOWEVER CAUSED AND ON ANY THEORY OF LIABILITY, WHETHER IN CONTRACT,  
\* STRICT LIABILITY, OR TORT (INCLUDING NEGLIGENCE OR OTHERWISE)  
\* ARISING IN ANY WAY OUT OF THE USE OF THIS SOFTWARE, EVEN IF ADVISED  
\* OF THE POSSIBILITY OF SUCH DAMAGE.

=====

\*

\* This product includes cryptographic software written by Eric Young  
\* ([eyay@cryptsoft.com](mailto:eyay@cryptsoft.com)). This product includes software written by Tim  
\* Hudson ([tjh@cryptsoft.com](mailto:tjh@cryptsoft.com)).

\*

\*/

Original SSLeay License

-----

/\* Copyright (C) 1995-1998 Eric Young ([eyay@cryptsoft.com](mailto:eyay@cryptsoft.com))

\* All rights reserved.

- \*
- \* This package is an SSL implementation written
- \* by Eric Young (eay@cryptsoft.com).
- \* The implementation was written so as to conform with Netscapes SSL.
- \*
- \* This library is free for commercial and non-commercial use as long as
- \* the following conditions are aheared to. The following conditions
- \* apply to all code found in this distribution, be it the RC4, RSA,
- \* lhash, DES, etc., code; not just the SSL code. The SSL documentation
- \* included with this distribution is covered by the same copyright terms
- \* except that the holder is Tim Hudson (tjh@cryptsoft.com).
- \*
- \* Copyright remains Eric Young's, and as such any Copyright notices in
- \* the code are not to be removed.
- \* If this package is used in a product, Eric Young should be given attribution
- \* as the author of the parts of the library used.
- \* This can be in the form of a textual message at program startup or
- \* in documentation (online or textual) provided with the package.
- \*
- \* Redistribution and use in source and binary forms, with or without
- \* modification, are permitted provided that the following conditions
- \* are met:
- \* 1. Redistributions of source code must retain the copyright
- \* notice, this list of conditions and the following disclaimer.
- \* 2. Redistributions in binary form must reproduce the above copyright
- \* notice, this list of conditions and the following disclaimer in the
- \* documentation and/or other materials provided with the distribution.
- \* 3. All advertising materials mentioning features or use of this software
- \* must display the following acknowledgement:
- \* "This product includes cryptographic software written by
- \* Eric Young (eay@cryptsoft.com)"
- \* The word 'cryptographic' can be left out if the rouines from the library
- \* being used are not cryptographic related :-).
- \* 4. If you include any Windows specific code (or a derivative thereof) from
- \* the apps directory (application code) you must include an acknowledgement:
- \* "This product includes software written by Tim Hudson (tjh@cryptsoft.com)"
- \*
- \* THIS SOFTWARE IS PROVIDED BY ERIC YOUNG ``AS IS'' AND
- \* ANY EXPRESS OR IMPLIED WARRANTIES, INCLUDING, BUT NOT LIMITED TO, THE
- \* IMPLIED WARRANTIES OF MERCHANTABILITY AND FITNESS FOR A PARTICULAR
- PURPOSE
- \* ARE DISCLAIMED. IN NO EVENT SHALL THE AUTHOR OR CONTRIBUTORS BE
- LIABLE
- \* FOR ANY DIRECT, INDIRECT, INCIDENTAL, SPECIAL, EXEMPLARY, OR
- CONSEQUENTIAL
- \* DAMAGES (INCLUDING, BUT NOT LIMITED TO, PROCUREMENT OF SUBSTITUTE
- GOODS
- \* OR SERVICES; LOSS OF USE, DATA, OR PROFITS; OR BUSINESS INTERRUPTION)
- \* HOWEVER CAUSED AND ON ANY THEORY OF LIABILITY, WHETHER IN CONTRACT,
- STRICT
- \* LIABILITY, OR TORT (INCLUDING NEGLIGENCE OR OTHERWISE) ARISING IN ANY
- WAY
- \* OUT OF THE USE OF THIS SOFTWARE, EVEN IF ADVISED OF THE POSSIBILITY OF
- \* SUCH DAMAGE.
- \*
- \* The licence and distribution terms for any publically available version or

## Open Source Software

---

\* derivative of this code cannot be changed. i.e. this code cannot simply be  
\* copied and put under another distribution licence  
\* [including the GNU Public Licence.]  
\*/

<<MD5>>

This software uses the Source Code of RSA Data Security, Inc. described in the RFC1321 (MD5 Message-Digest Algorithm).

-----  
Copyright (C) 1991-2, RSA Data Security, Inc. Created 1991. All rights reserved.

License to copy and use this software is granted provided that it is identified as the "RSA Data Security, Inc. MD5 Message-Digest Algorithm" in all material mentioning or referencing this software or this function.

License is also granted to make and use derivative works provided that such works are identified as "derived from the RSA Data Security, Inc. MD5 Message-Digest Algorithm" in all material mentioning or referencing the derived work.

RSA Data Security, Inc. makes no representations concerning either the merchantability of this software or the suitability of this software for any particular purpose. It is provided "as is" without express or implied warranty of any kind.

These notices must be retained in any copies of any part of this documentation and/or software.

<<MT19937>>

The MT19937 software that Takuji Nishimura and Makoto Matsumoto developed is contained, and this product shall be used subject to the following license conditions.

Copyright (C) 1997 - 2002, Makoto Matsumoto and Takuji Nishimura, All rights reserved.

Redistribution and use in source and binary forms, with or without modification, are permitted provided that the following conditions are met:

1. Redistributions of source code must retain the above copyright notice, this list of conditions and the following disclaimer.
2. Redistributions in binary form must reproduce the above copyright notice, this list of conditions and the following disclaimer in the documentation and/or other materials provided with the distribution.
3. The names of its contributors may not be used to endorse or promote products derived from this software without specific prior written permission.

THIS SOFTWARE IS PROVIDED BY THE COPYRIGHT HOLDERS AND CONTRIBUTORS

"AS IS" AND ANY EXPRESS OR IMPLIED WARRANTIES, INCLUDING, BUT NOT

LIMITED TO, THE IMPLIED WARRANTIES OF MERCHANTABILITY AND FITNESS FOR A PARTICULAR PURPOSE ARE DISCLAIMED. IN NO EVENT SHALL THE COPYRIGHT OWNER OR CONTRIBUTORS BE LIABLE FOR ANY DIRECT, INDIRECT, INCIDENTAL, SPECIAL, EXEMPLARY, OR CONSEQUENTIAL DAMAGES (INCLUDING, BUT NOT LIMITED TO, PROCUREMENT OF SUBSTITUTE GOODS OR SERVICES; LOSS OF USE, DATA, OR PROFITS; OR BUSINESS INTERRUPTION) HOWEVER CAUSED AND ON ANY THEORY OF LIABILITY, WHETHER IN CONTRACT, STRICT LIABILITY, OR TORT (INCLUDING NEGLIGENCE OR OTHERWISE) ARISING IN ANY WAY OUT OF THE USE OF THIS SOFTWARE, EVEN IF ADVISED OF THE POSSIBILITY OF SUCH DAMAGE.

<<thttpd>>

The thttpd software that ACME Labs developed is contained, and this product shall be used subject to the following license conditions.

Copyright 1995,1998,1999,2000 by Jef Poskanzer <jef@acme.com>.  
All rights reserved.

Redistribution and use in source and binary forms, with or without modification, are permitted provided that the following conditions are met:

1. Redistributions of source code must retain the above copyright notice, this list of conditions and the following disclaimer.
2. Redistributions in binary form must reproduce the above copyright notice, this list of conditions and the following disclaimer in the documentation and/or other materials provided with the distribution.

THIS SOFTWARE IS PROVIDED BY THE AUTHOR AND CONTRIBUTORS ``AS IS" AND ANY EXPRESS OR IMPLIED WARRANTIES, INCLUDING, BUT NOT LIMITED TO, THE IMPLIED WARRANTIES OF MERCHANTABILITY AND FITNESS FOR A PARTICULAR PURPOSE ARE DISCLAIMED. IN NO EVENT SHALL THE AUTHOR OR CONTRIBUTORS BE LIABLE FOR ANY DIRECT, INDIRECT, INCIDENTAL, SPECIAL, EXEMPLARY, OR CONSEQUENTIAL DAMAGES (INCLUDING, BUT NOT LIMITED TO, PROCUREMENT OF SUBSTITUTE GOODS OR SERVICES; LOSS OF USE, DATA, OR PROFITS; OR BUSINESS INTERRUPTION) HOWEVER CAUSED AND ON ANY THEORY OF LIABILITY, WHETHER IN CONTRACT, STRICT LIABILITY, OR TORT (INCLUDING NEGLIGENCE OR OTHERWISE) ARISING IN ANY WAY OUT OF THE USE OF THIS SOFTWARE, EVEN IF ADVISED OF THE POSSIBILITY OF SUCH DAMAGE.

## **FCC and other information**

This equipment complies with Part 68 of the FCC rules and the requirements adopted by the ACTA. On the back/bottom of this equipment is a label that contains, among other information, a product identifier in the format US:ACJ-----.

If requested, this number must be provided to the telephone company.

If the equipment is causing harm to the telephone network, the telephone company may request that you disconnect the equipment until the problem is resolved.

### **WHEN PROGRAMMING EMERGENCY NUMBERS AND/OR MAKING TEST CALLS TO EMERGENCY NUMBERS:**

- 1) Remain on the line and briefly explain to the dispatcher the reason for the call.
- 2) Perform such activities in the off-peak hours, such as early morning or late evenings.

This device complies with Part 15 of the FCC Rules. Operation is subject to the following two conditions:

(1) This device may not cause harmful interference, and (2) this device must accept any interference received, including interference that may cause undesired operation.

Privacy of communications may not be ensured when using this phone.

### **CAUTION:**

Any changes or modifications not expressly approved by the party responsible for compliance could void the user's authority to operate this device.

### **NOTE:**

This equipment has been tested and found to comply with the limits for a Class B digital device, pursuant to Part 15 of the FCC Rules. These limits are designed to provide reasonable protection against harmful interference in a residential installation. This

equipment generates, uses, and can radiate radio frequency energy and, if not installed and used in accordance with the instructions, may cause harmful interference to radio communications. However, there is no guarantee that interference will not occur in a particular installation. If this equipment does cause harmful interference to radio or television reception, which can be determined by turning the equipment off and on, the user is encouraged to try to correct the interference by one or more of the following measures:

- Reorient or relocate the receiving antenna.
- Increase the separation between the equipment and receiver.
- Connect the equipment into an outlet on a circuit different from that to which the receiver is connected.
- Consult the dealer or an experienced radio/TV technician for help.

### **FCC RF Exposure Warning:**

- This product complies with FCC radiation exposure limits set forth for an uncontrolled environment.
- To comply with FCC RF exposure requirements, the base unit must be installed and operated 20 cm (8 inches) or more between the product and all person's body (excluding extremities of hands, wrist and feet).
- This product may not be collocated or operated in conjunction with any other antenna or transmitter.
- For body-worn operation, the handset must be used only with a non-metallic accessory. Use of other accessories may not ensure compliance with FCC RF exposure requirements.

### **Notice**

- FCC ID can be found inside the battery compartment or on the back/bottom of the units.

**FCC Declaration of Conformity**

Trade Name: Panasonic  
Model Number: KX-TGP500/KX-TGP550  
Responsible Party: Panasonic Corporation  
of North America  
One Panasonic Way  
Secaucus, NJ 07094  
U.S.A.

Telephone No.: 1-800-211-PANA (7262)

This telephone provides magnetic coupling for hearing aids.

**Compliance with TIA-1083 standard:**

Telephone handsets identified with this logo have reduced noise and interference when used with T-Coil equipped hearing aids and cochlear implants.



# IMPORTANT!

If your product is not working properly. . .

- ① **Reconnect AC adaptor to the base unit.**
- ② **Check if Ethernet cable is connected.**
- ③ **Use rechargeable Ni-MH batteries.**  
(Alkaline/Manganese/Ni-Cd batteries CANNOT be used.)
- ④ Read **troubleshooting** page in the **User Guide** on the **Panasonic Web site** at:  
**<http://panasonic.net/pcc/support/sipphone/>**
- ⑤ If you still have any problems, contact your phone system dealer.

## For your future reference

We recommend keeping a record of the following information to assist with any repair under warranty.

Serial No.

Date of purchase

---

(found on the back/bottom of the base unit)

Name and address of dealer

---

┌-----┐  
└-----┘  
**Attach your purchase receipt here.**

## Copyright:

This material is copyrighted by Panasonic System Networks Co., Ltd., and may be reproduced for internal use only. All other reproduction, in whole or in part, is prohibited without the written consent of Panasonic System Networks Co., Ltd.

© Panasonic System Networks Co., Ltd. 2009