

Treo™ 90 Handheld  
User Guide

Windows Edition



## Copyright

Copyright © 2002 Handspring, Inc. All Rights Reserved. Handspring, Treo, and the Treo logo are trademarks of Handspring, Inc. and may be registered in some jurisdictions. Blazer and the Handspring logo are trademarks of Handspring Inc., are registered trademarks in the U.S.A., and may be registered in other jurisdictions. Portions copyright © 1998-2002 Palm, Inc. or its subsidiaries. All rights reserved. Palm OS and HotSync are registered trademarks and Palm and the Palm Powered logo are trademarks of Palm, Inc. and are used by Handspring under license. The SD logo is a trademark. All other trademarks and trade names are the property of their respective owners.

## Disclaimer and limitation of liability

Handspring, Inc. and its suppliers assume no responsibility for: (i) any damage or loss resulting from the use of this handbook, (ii) any loss or claims by third parties that may arise through the use of this software, or (iii) any damage or loss caused by deletion of data as a result of malfunction, dead battery, or repairs. Be sure to make backup copies of all important data on other media to protect against data loss.

## Warranty and License Agreement

In order to obtain warranty service, you must immediately notify Handspring of any defect within the warranty period and provide dated proof of original purchase. For further information about the warranty service procedure, please visit our website at: <http://www.handspring.com>

A copy of the Warranty and End User License Agreement are included in this guide. You can also view a copy of the warranty on our website at <http://support.handspring.com/esupport/forms/hsFileList.jsp?Type=Warranties>.

The information included in this guide sets forth Handspring's sole and complete warranty and software licensing obligations with respect to your Handspring product. Use of the product indicates your acceptance of the terms of the warranty and the End User License Agreement.

## Software download available

Wireless setup and desktop synchronization software are supplied on the Handspring CD-ROM disc. If you do not have access to a CD-ROM drive for your computer, you can download this software from [www.handspring.com](http://www.handspring.com).

# Contents

<b>Introduction to Your Treo™ 90 Handheld</b> .....	<b>11</b>
Getting to know your handheld .....	11
What is a Treo handheld? .....	11
System requirements .....	12
Upgrade information .....	12
Treo components .....	14
Locking and unlocking the keyboard .....	16
Adjusting the display .....	16
Charging the battery .....	17
Using the protective cover .....	18
Using the stylus to get things done .....	19
Elements of the handheld interface .....	19
Moving around the screen .....	20
Displaying online tips .....	20
Customizing your handheld .....	21
Connecting the HotSync cable .....	23
Using desktop software .....	24
Using your handheld with Palm Desktop software .....	24
Using your handheld with Microsoft Outlook .....	25
Using your handheld with another PIM .....	25
<b>Entering Data in Your Handheld</b> .....	<b>27</b>
Using the handheld keyboard .....	27
Typing capital letters .....	27
Typing numbers and symbols .....	28
Navigation keystrokes .....	29
Using menus .....	29
Using text ShortCuts .....	30
Typing accented characters .....	31
Typing extended characters .....	31
Using the onscreen keyboard .....	33
Using your computer keyboard .....	33
Importing data .....	34

<b>Managing Your Applications</b> .....	<b>37</b>
Using the Applications Launcher .....	37
Opening applications .....	37
Switching between applications .....	38
Categorizing applications .....	38
Changing the Applications Launcher display .....	38
Choosing preferences .....	39
Installing and removing applications .....	40
Installing add-on applications .....	40
Removing applications .....	42
Removing Palm Desktop software .....	43
Working with expansion cards .....	44
Opening applications on an expansion card .....	45
Copying applications to an expansion card .....	45
Using the Card Info application .....	46
Security .....	47
Assigning a password .....	48
Changing or deleting a password .....	48
Locking your handheld .....	49
Recovering from a forgotten password .....	50
 <b>Applications Overview</b> .....	 <b>53</b>
Date Book Plus .....	54
Contacts .....	55
To Do List .....	56
Memo Pad .....	57
CityTime .....	58
Calculator .....	59
Expense .....	60
 <b>Common Tasks</b> .....	 <b>61</b>
Creating records .....	61
Editing records .....	62
Entering text .....	62
Edit menu .....	62
Deleting records .....	63
Other ways to delete records .....	64
Purging records .....	64
Categorizing records .....	65
System-defined and user-defined categories .....	65

Finding records .....	67
Looking up Contacts records .....	68
Using Find .....	69
Using Phone Number Lookup .....	69
Sorting lists of records .....	72
Making records private .....	73
Hiding and masking private records .....	73
Attaching notes .....	75
Choosing fonts .....	76
Exchanging and updating data: HotSync operations .....	76
Performing a HotSync operation for the first time .....	77
Beaming information .....	78
<b>Application-Specific Tasks .....</b>	<b>81</b>
Date Book Plus .....	82
Working in Day View .....	82
Scheduling an event .....	82
Rescheduling an event .....	84
Setting an alarm for an event .....	85
Scheduling repeating or continuous events .....	86
Changing the Date Book Plus view .....	88
Working in Week View .....	89
Working in Week View with Text .....	90
Working in Month View .....	91
Working in Year View .....	91
Working in List View .....	92
Spotting event conflicts .....	93
Working with floating events .....	93
Working with To Do items .....	94
Using the Daily Journal .....	94
Using templates .....	95
Date Book Plus menus .....	96
Contacts .....	103
Creating a Contacts entry .....	103
Duplicating a Contacts entry .....	104
Selecting types of phone numbers .....	104
Changing Contact entry details .....	105
Dialing a number in your Contacts list .....	105
Contacts menus .....	106
To Do List .....	109
Setting priority .....	109
Setting a due date .....	109
Assigning a category .....	110

Checking off a To Do item .....	111
To Do Show Options .....	111
To Do List menus .....	112
Memo Pad .....	114
Reviewing memos .....	114
Memo Pad menus .....	115
CityTime .....	116
Setting your home city .....	116
Selecting remote cities .....	116
Adding cities .....	117
CityTime menus .....	117
Calculator .....	118
Selecting the Calculator mode .....	118
Using the Basic Calculator buttons .....	118
Displaying Recent Calculations .....	119
Using the Advanced Calculator mode .....	119
Using the Advanced Calculator buttons .....	119
Creating a custom view .....	126
Calculator menus .....	127
Expense .....	128
Changing the date of an Expense item .....	128
Entering receipt details .....	129
Customizing the Currency pick list .....	130
Show Options .....	131
Transferring your data to Microsoft Excel .....	132
Expense menus .....	134
<b>Setting Preferences for Your Handheld .....</b>	<b>137</b>
Viewing Preferences .....	137
Buttons Preferences .....	138
HotSync Buttons Preferences .....	138
Connection Preferences .....	139
Connection Types .....	139
Date & Time Preferences .....	140
Digitizer Preferences .....	140
Formats Preferences .....	140
Country default .....	140
Time, date, week start, and numbers formats .....	141
General Preferences .....	141
Auto-off delay .....	141
System, alarm, and game sounds .....	142

Network Preferences and TCP/IP software .....	142
Selecting a service .....	142
Entering a user name .....	143
Entering a password .....	144
Selecting a connection .....	144
Adding telephone settings .....	145
Connecting to your service .....	147
Creating additional service templates .....	147
Adding detailed information to a service template .....	148
Creating a login script .....	150
Deleting a service template .....	152
Network Preferences menu commands .....	152
TCP/IP troubleshooting .....	152
Owner Preferences .....	153
Phone Preferences .....	154
ShortCuts Preferences .....	154
Creating a ShortCut .....	154
Editing a ShortCut .....	155
Deleting a ShortCut .....	155
<b>Advanced HotSync® Operations .....</b>	<b>157</b>
Selecting HotSync setup options .....	157
Customizing HotSync application settings .....	159
IR HotSync operations .....	160
Preparing your computer for infrared communication .....	160
Configuring HotSync Manager for infrared communication .....	162
Performing an IR HotSync operation .....	163
Returning to serial cable HotSync operations .....	164
Conducting a modem HotSync operation .....	164
Preparing your computer .....	165
Preparing your handheld .....	166
Selecting the conduits for a modem HotSync operation .....	167
Performing a modem HotSync operation .....	167
Conducting a HotSync operation via a network .....	168
Connecting to your company's dial-in server .....	168
Performing a dial-in network HotSync operation .....	169
Performing a network HotSync operation via a LAN .....	170
Using File Link .....	170
Creating a user profile .....	171
Synchronizing with your desktop e-mail application .....	172
Preparing your computer to synchronize desktop e-mail .....	173
Using Palm Mail on your handheld .....	174

Viewing e-mail items .....	175
Creating e-mail items .....	176
Looking up an address .....	177
Adding details to e-mail items .....	178
Storing e-mail to be sent later .....	181
Filing e-mail .....	183
Deleting e-mail .....	184
Message list options .....	185
Sorting the Message list .....	186
Palm Mail HotSync options .....	186
Palm Mail menus .....	191
<b>Using the Wireless Application Suite .....</b>	<b>193</b>
Preparing for mobile communications .....	194
Blazer Web Browser .....	195
Viewing web pages .....	195
Working with bookmarks .....	196
Blazer menus .....	200
Palm™ SMS .....	204
Receiving SMS messages .....	205
Creating text messages .....	206
Creating a message signature .....	207
Sending data via SMS .....	208
Modifying messages .....	208
SMS Messaging menus .....	209
One-Touch Mail .....	211
<b>Maintaining Your Handheld .....</b>	<b>213</b>
Caring for your handheld .....	213
Battery considerations .....	213
Resetting your handheld .....	214
Performing a soft reset .....	214
Performing a warm (or safe) reset .....	215
Performing a hard reset .....	215
<b>Troubleshooting Tips .....</b>	<b>217</b>
Software installation problems .....	217
Operating problems .....	218
Tapping and keyboard problems .....	218
Wireless communication problems .....	219
Application problems .....	221
HotSync problems .....	222
Beaming problems .....	223



Password problems .....	224
Technical support .....	224
<b>Creating a Custom Expense Report .....</b>	<b>225</b>
About mapping tables .....	225
Customizing existing sample templates .....	225
Determining the layout of the Expense Report .....	227
Labels .....	227
Sections .....	227
Analyzing your custom Expense Report .....	228
Programming the mapping table .....	228
Using applications other than Microsoft Excel .....	232
Expense file details .....	232
<b>Non-ASCII Characters for Login Scripts .....</b>	<b>233</b>
Use of ^char .....	233
Carriage return and line feed .....	233
Literal characters .....	233
<b>Warranty and Other Product Information .....</b>	<b>235</b>
Product Warranty .....	235
Handspring, Inc. End User Software License Agreement .....	236
GNU Library General Public License .....	237
FCC Statement .....	243
Canadian RFI Statement .....	243
Acknowledgments .....	244
<b>Index .....</b>	<b>245</b>



## Chapter 1

# Introduction to Your Treo™ 90 Handheld

This chapter explains the physical buttons and controls on your Treo™ 90 handheld, how to use your handheld for the first time, and how to install Palm™ Desktop software and the HotSync® Manager synchronization software so you can synchronize your handheld and your computer.

## Getting to know your handheld

### What is a Treo handheld?

Your Treo handheld is one of the smallest, lightest, color Palm OS® handhelds available today. With your new handheld, you will no longer have trouble getting to meetings and appointments on time, remembering people's names and personal details, or keeping track of all the items on your to do list. Your handheld can help you improve your track record in all these areas, both at work and at home.

You can enter all your schedule details in Date Book Plus so you can view them by the day, week, month, year, or in list format; you can even set an alarm to remind you of important meetings. Keep all your contact names, addresses, phone numbers, and other details in Contacts, so you can find them as soon as you need them. Add your tasks to To Do list, prioritize them so you don't overlook them, and assign them a due date.

To make sure you don't lose any of this important information, you can synchronize your data with Palm Desktop software on your computer so you always have a backup copy. You can set different levels of security for your handheld so unauthorized eyes cannot view your data.

When you are out of the office, track your expenses for your expense reports; then transfer the data to your computer to print it out. Using the IR port or a cable to connect to your data-enabled mobile phone, you can dial your ISP and use the included Wireless Application Suite to send and receive e-mail, exchange SMS text messages, and to browse the Internet. Alternatively you can write, edit, and view your e-mail, and then use Palm Mail to synchronize your e-mail with your desktop e-mail application when you return to your office.

Using your handheld doesn't always have to be serious either. With the bright color screen and expansion capabilities, you can enjoy viewing photos and playing games without worrying about running out of storage space.

# System requirements

To install and operate Palm Desktop software and the HotSync Manager synchronization software, your computer system must meet the following requirements:

## Minimum requirements

- Windows 98, Windows Me, Windows 2000, or Windows XP with USB port, (for USB HotSync® cable)  
--or--  
Windows 95, Windows 98, Windows Me, Windows 2000, Windows XP, or Windows NT 4.0 with serial port (for serial HotSync cable)
- 32 MB RAM (memory)
- 25 MB available hard disk space
- VGA monitor or better
- CD-ROM drive (you can also download Palm Desktop software from [www.handspring.com](http://www.handspring.com))
- Internet Explorer 5.01 or higher (recommended)

## Upgrade information

If you already own a Palm OS handheld, Handspring recommends that you install the version of Palm Desktop software that comes with your Treo handheld into the same folder as your current Palm Desktop software. When you install the new version in the same folder as the previous version, all your data is preserved. If you use another personal information manager (PIM), you still need to install Palm Desktop software in order to update the HotSync Manager on your computer.

You perform HotSync operations in exactly the same way, so you can quickly synchronize your old data with your new handheld.

**Note:** If you used password protection on your old handheld, you must upgrade to the most current desktop. The method of storing passwords has changed with the latest release of the desktop. Therefore, your password-protected information will not be synchronized if you don't upgrade.

### To upgrade:

1. Synchronize your old handheld with your old Palm Desktop software. This ensures that the latest information from your handheld is on your desktop computer.
2. (Optional) To ensure against any data loss, go to the folder that stores Palm Desktop software (this is usually the Handspring or Palm folder), copy (*do not move*) your user name folder, and store the copy outside the Palm Desktop software folder.
3. Follow the installation instructions that begin on page 24. Be sure to install the new software in the same folder as the old software.
4. Connect your new handheld to the HotSync cable and press the HotSync button on the cable. If the Select User dialog box appears, select your user name.

5. If you had important settings on your old handheld, such as Network Preferences or Connection Preferences, manually copy them from your old handheld to your new handheld.
6. Compare the applications on your old handheld and your new handheld.
7. Beam any third party applications that did not transfer from your old handheld to your new handheld, or install them from the original files.
8. If any data for your third party applications did not transfer, beam it from your old handheld to your new handheld.
9. If you created a password on your old handheld, enter it on your new handheld.

Note: Records you previously marked Private remain marked Private, but you need to reenter a password on your new handheld.

### **Each device must have a unique name**

After you complete the upgrade process described above, you have two devices with the same name. This is an undesirable situation. Each device must have a unique name in order to prevent unexpected results during HotSync operations and other complications.

We strongly recommend that you perform a hard reset on your old handheld. See page 215 for details.

A hard reset not only erases all data from the old handheld; it also erases the name and makes that handheld a clean slate, ready to receive a new name. The next time you perform a HotSync operation with this old handheld, you are asked to give it a name. Be sure to give it a unique name.

# Treo components

## Locating front panel controls

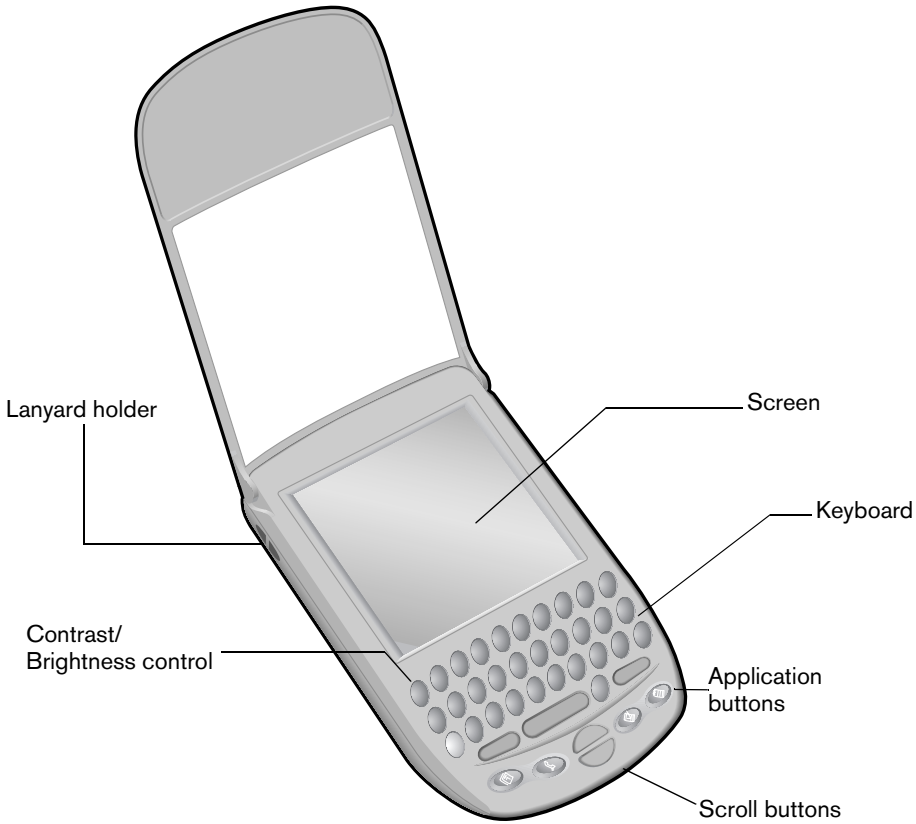

**Lanyard holder** Enables you to attach a lanyard to your handheld so that it's easy to carry.

**Contrast/Brightness Control** Opens the Adjust Display dialog box where you can adjust the appearance of your handheld screen for the clearest screen display. See page 16 for instructions.

**Scroll buttons** Displays text and other information that extends beyond the area of the handheld screen. Pressing the bottom scroll button scrolls down to view information below the viewing area, and pressing the top scroll button scrolls up to view the information above the viewing area.

**Application buttons**

Activates the applications that correspond to the icons on the buttons: Date Book Plus, Contacts, To Do List, and Memo Pad. See page 138 for details on reassigning these buttons to activate any application on your handheld.

You can also use these buttons in combination with Option  to activate other applications. See Chapter 4 in this guide for details.

Tip: If your handheld is turned off, pressing any application button turns on your handheld and opens the corresponding application.

**Keyboard**

Enables you to type letters, numbers and symbols on your handheld. See Chapter 2 to learn how to enter information.

**Handheld screen**

Displays the applications and information stored in your handheld. It is touch-sensitive and responds to the stylus.

## Locating back panel controls

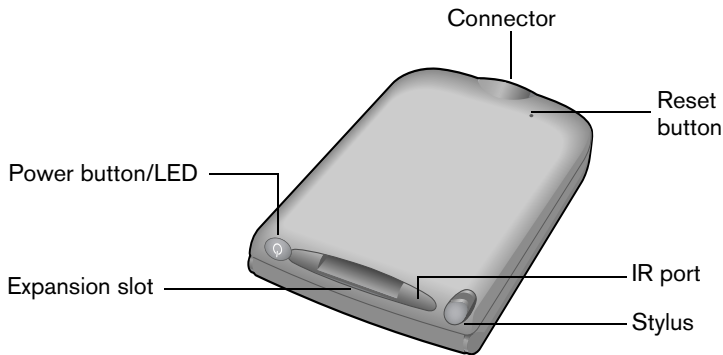

**Power button/LED**



Turns your handheld on and off, locks and unlocks the keyboard, and indicates the status of the battery as it charges.

When your handheld is connected to the travel charger or HotSync cable, the LED blinks while the battery charges and stays on after the battery is charged. When the LED alarm setting is active, the LED blinks as an alarm notification. See page 142 for details.

**Expansion slot**

Insert optional Secure Digital (SD) cards or MultiMedia Cards (MMC) to add features to your handheld. See the section that begins on page 44 for information about how to use expansion cards.

**Stylus**

Serves as the instrument used to tap options on your handheld screen. To use the stylus, slide the stylus out of the slot, and hold it as you would a pen or pencil.

**IR port**

Uses infrared technology to transmit data to and receive data from other Palm OS devices. See the section that begins on page 78 for details. You can also use the IR port to update the information between your handheld and computer using HotSync technology. See the section that begins on page 160 for details.

- Reset button** Under normal use, you should not have to use the reset button. See Appendix A for information about when and how to use the reset button.
- Connector** Enables you to connect your handheld to the travel charger, HotSync cable, and other devices such as a mobile phone. The HotSync cable connects to a USB port or serial port on your computer and enables you to synchronize the information between your handheld and computer using HotSync technology.

## Locking and unlocking the keyboard

To avoid accidentally pressing keys while your handheld is in your pocket, purse, etc., you can lock the keyboard. Locking the keyboard helps conserve battery power, and prevents unintentional creation and deletion of records. When the keyboard is locked, you cannot enter data or view information on your handheld until you unlock the keyboard.

### To lock the keyboard:

- Press and hold the power button for two seconds.

### To unlock the keyboard:



1. Press and hold the power button for two seconds.
2. In the KeyLock Off dialog box, tap OK to unlock the keyboard.

## Adjusting the display



Depending on the lighting conditions or temperature of the environment where you use your handheld, you may need to adjust the brightness and color saturation of the display.

The Adjust Display dialog box contains two sliders. The upper slider adjusts color saturation and the lower slider adjusts brightness. The display usually looks best at maximum brightness but you may want to decrease the brightness to conserve battery power.

### To adjust the display:

1. Press Option .
2. Type the letter Q.
3. Press the scroll buttons, or drag the top slider, to adjust the color saturation until you can see the three shapes as distinctly as possible.
4. Hold Option  and press the scroll buttons, or drag the bottom slider, to adjust the screen brightness

Tip: You can also tap to the left or right of the sliders to fine tune the display settings.

5. Hold Option  and press Return  to finish.



# Charging the battery

To use your handheld, you must connect the travel charger or the HotSync cable and charge the battery. When you're near your computer, connect your handheld to the HotSync cable with the travel charger connected to a wall outlet as shown in the section that begins on page 23. When travelling, connect the travel charger cable directly to your handheld as shown in this section.

It takes about 90 minutes to charge the battery. A fully charged battery provides approximately 10 days of use. If the battery drains to the point where your handheld does not turn on, it stores your data safely for about three days.

**Note:** Recharge the battery after the first low battery warning. This prevents data loss that can occur if your handheld sits idle for more than five days after the first battery warning. See Appendix A for tips on extending the life of the battery.

**To charge the battery with the travel charger:**

1. Plug the travel charger into a wall outlet.
2. With the word "UP" facing up (as shown), connect the travel charger cable to the charger connector on the bottom of your handheld.

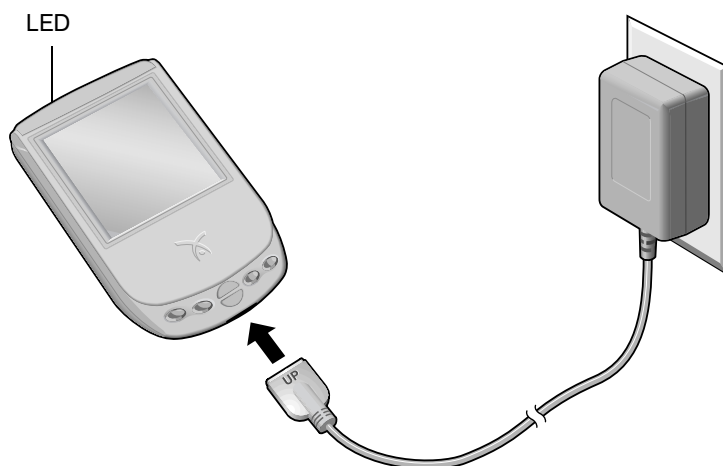

**Tip:** The LED blinks green while your handheld charges. When the LED turns solid green, your handheld is charged. It takes approximately 90 minutes to charge a fully drained battery.

## Using the protective cover

The cover protects the handheld screen when it is not in use.

### To remove the cover:

1. Unclip the top of the cover from your handheld.
2. Lift the cover off your handheld.

### To reattach the cover:

1. Insert the pegs on the cover into the holes on the top of the sides of your handheld.
2. Gently press the top of the cover onto your handheld until it clicks into place.

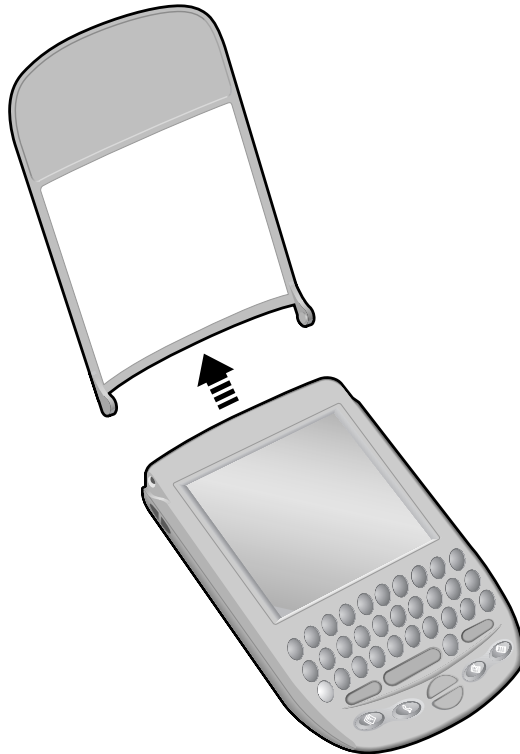

# Using the stylus to get things done

Like using a mouse to click elements on a computer screen, using the stylus to tap elements on your handheld screen is a way to get things done on your handheld.

The first time you start your handheld, setup instructions appear on the screen. These instructions include a calibration screen, or digitizer. Calibration aligns the internal circuitry of your handheld with its touch-sensitive screen so that when you tap an element on the screen, the handheld can detect exactly which task you want to perform.

**Important:** Always use the point of the stylus for tapping the handheld screen. Never use an actual pen, pencil, or other sharp object to tap the handheld screen.

With your handheld turned on, you can tap the handheld screen to perform many operations, such as the following:

- Open applications
- Choose menu commands
- Select options in dialog boxes

Just as you can drag the mouse to select text or move objects on your computer, you can also drag the stylus to select text. You can also use the stylus to drag the slider of any scroll bar.

## Elements of the handheld interface

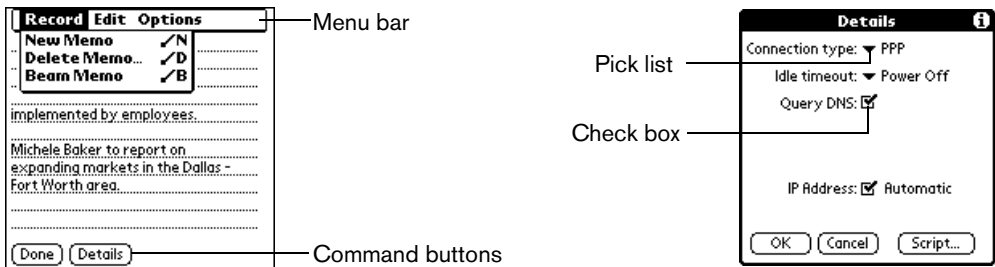

**Menu bar** A set of commands that are specific to the application. Not all applications have a menu bar.

**Command buttons** Tap a button to perform a command. Command buttons appear in dialog boxes and at the bottom of application screens.

**Check box** When a check mark appears in a check box, the corresponding option is active. If a check box is empty, tapping it inserts a check mark. If a check box is checked, tapping it removes the check mark.

**Pick list** Tap the arrow to display a list of choices, and then tap an item in the list to select it.

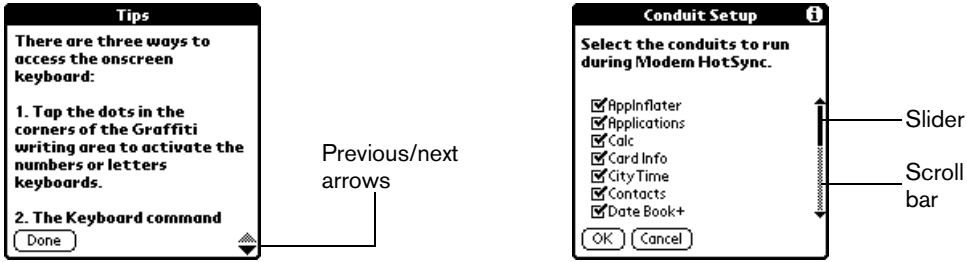

**Previous/next arrows** Tap the up and down arrows to display the previous and next page of information; tap the left and right arrows to display the previous and next record.

**Scroll bar** Press the scroll buttons on the front panel of your handheld to scroll to the previous and next pages. To scroll the display one line at a time, tap the top or bottom arrow.

You can also scroll by dragging the slider or by tapping the scroll bar just above or below the slider to scroll to the previous or next page.

## Moving around the screen

You can move between entry fields, pick lists, check boxes, and other options by using the stylus, or the scroll buttons.

To move around the screen do one of the following:

- Tap an item with the stylus.
- Press the scroll buttons to scroll through the items on the screen.

Tip: To learn how to move around the screen using the Treo keyboard, see page 33.

## Displaying online tips

Many of the dialog boxes that appear on your handheld contain an online Tips icon in the upper-right corner. Online tips anticipate questions you have in a dialog box, provide shortcuts for using the dialog box, or give you other useful information.

To display an online tip:

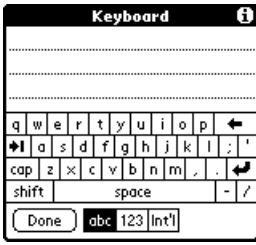

1. Tap the Tips icon (i).
2. After you review the tip, hold Option (⌘) and press Return (↵) to finish.



## Customizing your handheld

You can customize your handheld by using the Preferences application. You can enter personal information such as your name and address; change the time and date; view different date and time formats when you travel; turn off sounds, and configure your handheld to work with a modem or network. See Chapter 7 for more information on customizing your handheld.

To open the Preferences screens:

1. Press Option  and then press Menu  to access the Applications Launcher.
2. Tap the Preferences icon .
3. Tap the category pick list in the upper-right corner of the screen.
4. Tap the Preferences category you want to view.

The following procedures for setting the time and date give you an example of how to customize your handheld using the Date & Time Preferences.

To set the current time:

1. Tap the Set Time box.

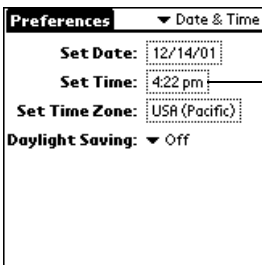



Tap here



2. Tap the up or down arrows to change the hour.
3. Tap each minute number, and then tap the arrows to change them.
4. Tap AM or PM.



Note: Your handheld can also display time based on a 24-hour clock. See page 140 for details.

5. Hold Option  and press Return  to finish.

To set the current date:

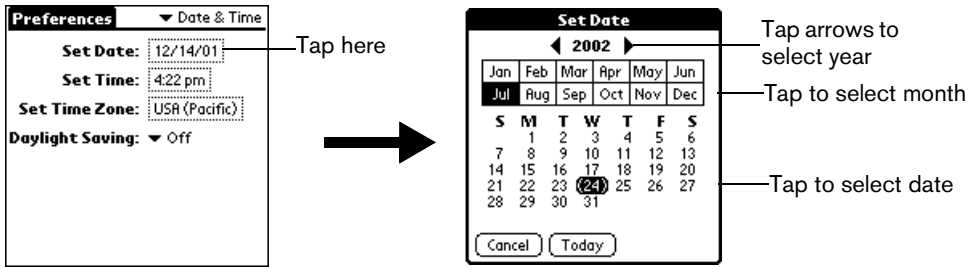
1. Tap the Set Date box.



2. Hold Option  and press a scroll button to scroll to the current year.
3. Hold Shift  and press a scroll button to scroll to the current month.
4. Type the number for the current date.
5. Press Space  to select the date.

Tip: You can also select the date by tapping the screen as shown above.

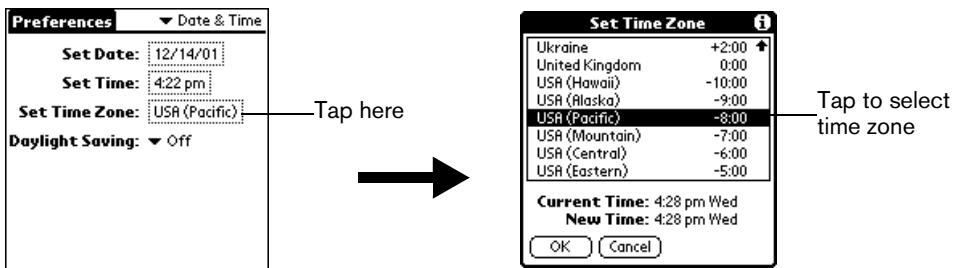

To set the time zone:

1. Tap the Set Time Zone box.



2. Press the scroll buttons or tap the arrows to scroll to your country and time zone.

Tip: Choose the time zone that corresponds to where you are. When you travel, use this dialog box to change time zones. If you're not sure what time zone you are in, find out what time it is, and select the time zone which shows the correct New Time. Do not use the time zone dialog to switch between daylight savings time and standard time. Use the Daylight Savings pick list.

3. Hold Option  and press Return  to finish.

To set the daylight savings time:

- Tap the Daylight Savings pick list to toggle this feature on and off.

# Connecting the HotSync cable

The HotSync cable that comes with your Treo enables you to charge your handheld battery and to synchronize the information on your handheld using HotSync technology.

Note: If your computer does not have a USB port, or it uses Windows 95 or Windows NT, you need a serial HotSync cable to connect to your computer. You can purchase a serial HotSync cable from [www.handspring.com](http://www.handspring.com).

## To connect the HotSync cable:

1. Connect the travel charger cable to the short end of the Hotsync cable. Be sure to match the sides of the connectors labeled "UP."
2. Connect the USB HotSync cable to a USB port on your computer, or connect the Serial HotSync cable to a Serial port on your computer.
3. Connect the long end of the HotSync cable to your handheld with the button facing up.

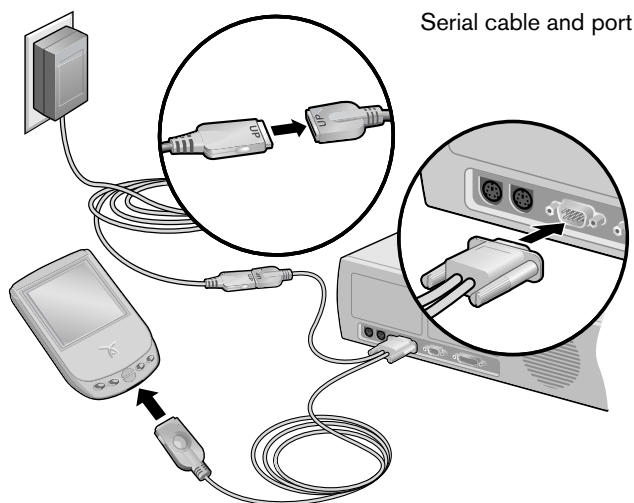
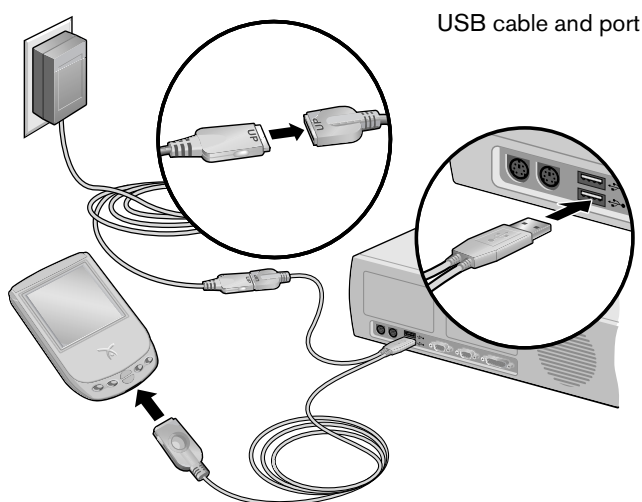

Note: If you are unsure about the exact location of the USB port or serial port on your computer, refer to the manual supplied with the computer.

4. Plug the travel charger into a wall outlet.

Tip: The travel charger does not need to be plugged into a wall outlet to perform a HotSync operation. However, if you want to use the HotSync cable to charge your Treo handheld, you must plug the travel charger into a wall outlet.

## Using desktop software

When you use desktop software with HotSync technology, you can do any of the following:

- Work with your handheld applications on your computer. Most desktop software applications duplicate many of the applications on your handheld, so you can view, enter, and modify most of the data stored on your handheld.
- Back up and synchronize data between your handheld and your computer. Synchronization is a one-step procedure that ensures that changes you make on your handheld or desktop software appear in both places. See the section that begins on page 76 for details.
- Import and export data, so you can easily transfer data from other desktop applications into many of your applications. See the section that begins on page 34 for details.
- Print data from your desktop software on any printer.

## Using your handheld with Palm Desktop software

Your handheld comes with Palm Desktop software. Palm Desktop software includes many of the same applications as your handheld: Date Book, Address (Contacts), To Do List, Memo Pad, Expense, and desktop e-mail connectivity.

The following instructions guide you through installing Palm Desktop software. After installation, refer to the online Help in Palm Desktop software for information about how to use the software.

Note: You must install the software that comes with your Treo handheld even if you already installed Palm Desktop software for a previous Palm OS handheld.

To ensure a safe and uninterrupted installation of Palm Desktop software, please do *not* simply copy the Palm Desktop software files to your computer's hard disk. You must use the installer to place the files in their proper locations and to decompress the files.

### To install Palm Desktop software:

1. Connect the HotSync cable. See page 23 for instructions.
2. Exit any open programs, including those that run at startup such as Microsoft Office, and disable any virus-scanning software.
3. Insert the Handspring CD-ROM into the computer's CD-ROM drive.
4. If the language selection screen appears, click the same language you selected on your handheld. *Choosing a different language may result in loss of data.*



5. Follow the onscreen instructions to complete the installation.
6. If you have a data-enabled mobile phone with an IR port, or a special cable that connects to your handheld, complete the next part of the installation to install the Wireless Application Suite and configure your Treo for wireless data communication, otherwise skip this step.

When the set up process is done, the installation screen closes automatically.

## Using your handheld with Microsoft Outlook

The software that comes with your Treo handheld includes everything you need to synchronize your handheld with Microsoft Outlook. If you already have Microsoft Outlook installed on your computer, the installation program prompts you to choose the Microsoft Outlook synchronization option.

## Using your handheld with another PIM

If you prefer to use another personal information manager (PIM), such as Lotus Notes, you can use it if third-party connection software, called a conduit, is available for your PIM. You must install the software that came with your Treo handheld along with the conduit for your PIM to synchronize the data between your handheld and your PIM. For information on conduit software, go to this web site: [www.handspring.com](http://www.handspring.com).



## Chapter 2

# Entering Data in Your Handheld

This chapter explains how to enter data into your Treo™ 90 handheld using each of the following methods:

- Using the handheld keyboard
- Using the onscreen keyboard
- Using your computer keyboard
- Importing data

## Using the handheld keyboard

The handheld keyboard is the primary method you'll use to enter data into your handheld. Each letter key on the keyboard has three functions:

Normal: Types a lowercase letter.

Shift: Types an uppercase letter.

Option: Types the number/symbol, or activates the function, that appears in blue on the key.



## Typing capital letters

To type capital letters, you must first "shift" to caps and then type the character.

Note: Your handheld includes a feature that automatically capitalizes the first letter when you create a new sentence or a new record (by tapping New or a blank line).

## To type a single capital letter (Caps Shift):

1. Press Shift .

When Caps Shift is active, an “up arrow” symbol appears in the lower-right corner of the Treo screen. If you accidentally activate Caps Shift, press Shift  twice to cancel it, or if you do nothing for five seconds, it reverts to lowercase.

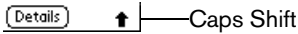

2. Type the letter you want to capitalize.

## To enter only capital letters (Caps Lock):

1. Press Shift  twice.

When Caps Lock is active, an underlined “up arrow” symbol appears in the lower-right corner of the handheld screen.





2. Type the text you want to capitalize.
3. Press Shift  to turn off Caps Lock.

## Typing numbers and symbols

Typing numbers and symbols with your handheld is similar to typing symbols on a computer keyboard. You must first “shift” to option mode and then type the number or symbol strokes.

### To enter a single number or symbol (Option Shift):

1. Press Option .

When Option Shift is active, a dot appears in the lower-right corner of the Treo screen. If you accidentally activate Option Shift, press Backspace  to cancel it.

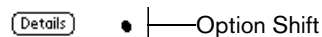



2. Press the key where the number or symbol appears in blue.

### To enter only numbers or symbols (Option Lock):

1. Press Option  twice.
2. Press the keys where the numbers or symbols appear in blue.

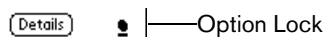
When Option Lock is active, an underlined dot appears in the lower-right corner of the Treo screen.











3. Press Option  to turn off Option Lock.

## Navigation keystrokes

In addition to character symbols, your handheld includes special keystrokes that you can use to navigate within text or fields in your applications.

Note: Some applications may not support these navigation keystrokes.

Command	Keystrokes
Move cursor right	Hold Option  while pressing the bottom scroll button.
Move cursor left	Hold Option  while pressing the top scroll button.
Previous field	Press the top scroll button.
Next field	Press the bottom scroll button.
Affirm an action	Hold Option  and press Return  . Use these keys instead of tapping the following onscreen buttons: OK, Done, Yes, Next, Accept, Send, and Dial.
Annul an action	Hold Option  and press Backspace  . Use these keys instead of tapping the following onscreen buttons: Cancel, No, Previous, and Reject.
Open or dial the selected item	Press Space  or press Return  .

## Using menus

Menus on your handheld are easy to use. Once you have mastered them in one application, you can use them the same way in all other applications.

The menus and menu commands that are available depend on the application. Also, the menus and menu commands vary depending on *which part* of the application you're using. For example, in Memo Pad, the menus are different for the Memo list screen and the Memo edit screen.

The menus of each application are illustrated in the section on that application in Chapter 6. The Edit menu is described in the section that begins on page 62.

### To use the menu bar:

1. Open an application (such as Memo Pad).
2. Press Menu  to open the menu bar.

Tip: You can also open the menu bar by tapping the inverted tab at the top of any application's screen (except Calculator).

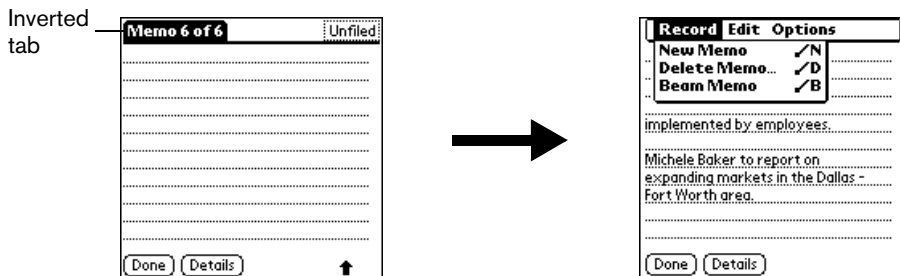

In this example, three menus are available: Record, Edit, and Options. The Record menu is selected and contains the commands New Memo, Delete Memo, and Beam Memo.

3. Press the top scroll button to switch between menus.
4. Press the bottom scroll button to select a command within a menu.
5. Press Space  to run the selected command.

Tip: To close the menus without running a command, press Menu  again.

## Keyboard shortcut menu commands

Most menu commands have an equivalent keyboard shortcut. The shortcut letters appear to the right of the menu command names. Throughout this guide, the shortcut letters appear in parentheses (/C) next to menu selection instructions.

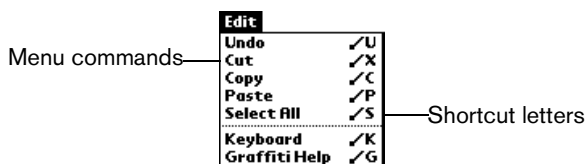

To use keyboard shortcuts for menu commands:

1. Press Menu  to open the menu bar.
2. Type the menu command shortcut letter.

For example, to choose Copy in the Edit menu, press Menu  followed by the letter “c.”

Tip: When the menu bar is open, you can enter a shortcut letter for any menu item in the current application view, not just the ones that appear on the current menu.

## Using text ShortCuts



ShortCuts make entering commonly used words or phrases quick and easy. ShortCuts are similar to the Glossary or Autotext features of some word processors.

Your handheld comes with several predefined ShortCuts, and you can also create your own. Each ShortCut can represent up to 45 characters. For example, you might create a ShortCut for your name, or for the header of a memo. See the section that begins on page 154 to learn about creating your own ShortCuts.

Your handheld includes the following predefined ShortCuts:

Entry	ShortCut
Date stamp	ds
Time stamp	ts
Date / time stamp	dts
Meeting	me
Breakfast	br
Lunch	lu
Dinner	di

### To use a ShortCut:

1. Type the letter s.
2. Press ListType .
3. Use the scroll buttons to select the ShortCut symbol .

Note: The ShortCut symbol appears by the cursor to show that you are in ShortCut mode.



4. Type the ShortCut characters.

## Typing accented characters

The ListType feature enables you to enter accented characters. You can enter the following accented letters:

à á â ã ä å ç è é ê ë ì í î ï ñ ò ó ô õ ö ù ú ü ý ÿ

### To enter accented characters:

1. Type the letter (uppercase or lowercase) to which you want to add an accent.
2. Press ListType .
3. Use the scroll buttons to select the accent you want to apply.
4. Press Space  to insert the accented character.

Tip: You can also select the accented character you want to insert by repeatedly pressing ListType .

## Typing extended characters



The ListType feature also enables you to enter many extended characters that are not on the keyboard, such as currency symbols and emoticons. Extended characters are often found under related characters. For example, the £ symbol is located under \$.

To enter extended characters:

1. Position the cursor where you want to insert the extended character.
2. Type the base character associated with the extended character you want to insert:

Tip: To view a list of available accented and symbol characters, press Menu  and under Edit select Keyboard Help (/G).

Base character	Symbols	Base character	Symbols	Base character	Symbols
a	æ	O	∅	.	? ! ...
A	Æ	p	¶	,	”
b	β	P	¶	!	i
B	β	r	®	?	¿
c	ç © ^ ^	R	®	:	;-) :-(-;-) :-D
C	ç © ^ ^	s	ß š Š	'	‘ ’ < > ~ `
d	† ‡	S	ß Š Š	"	“ ” « »
D	† ‡ Đ	t	~ ™ † ‡	\$	€ £ ¥
e	€	T	~ ™ † ‡	+	&
E	€	x	×	-	_ ~ • - -
f	f	X	×	/	\ ÷
F	f	y	¥	%	%00
l	£	Y	¥	#	=
L	£	0	%00 °	(	<{ {<
m	μ	1	1 1/4 1/2	)	>}] }>
M	μ	2	2		
o	∅	3	3		

3. Press ListType .
4. Use the scroll buttons to select the extended symbol you want to insert.
5. Press Space  to insert the extended character.

Tip: To enter a tab, press Shift  and then press Space .



# Using the onscreen keyboard

You can open the onscreen keyboard anytime you need to enter text or numbers on your handheld. When used in conjunction with the backlight, the onscreen keyboard is especially useful for typing in the dark.

To use the onscreen keyboard:

1. Open a record in an application that requires you to enter data (such as Memo Pad).
2. Press Menu .
3. Under Edit, select Keyboard (/K).
4. Tap the characters to enter text, numbers, and international characters.

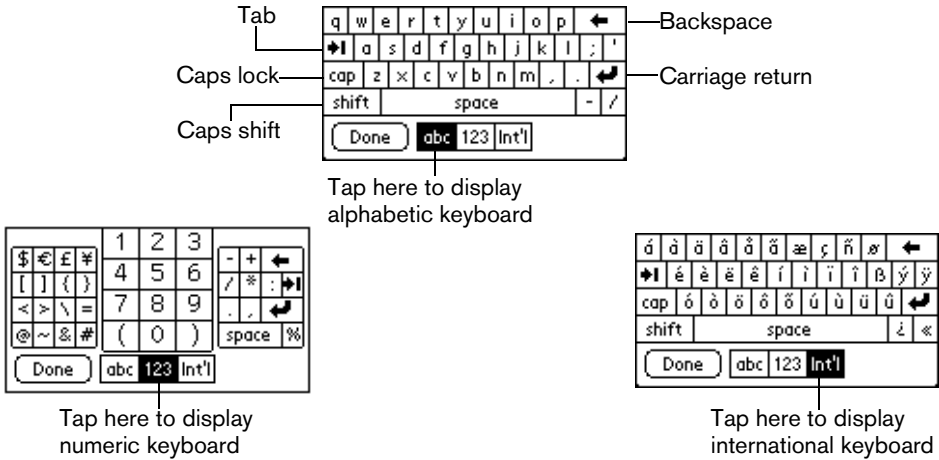

Note: The onscreen keyboard also includes a dialog box for international characters. You can switch among the three dialogs at any time to enter the exact text you need.

5. After you finish, tap Done to close the onscreen keyboard and place the text in the record.

# Using your computer keyboard

Many of the applications on your handheld are available in Palm Desktop software and in most Personal Information Manager (PIM) applications. If you have a lot of data to enter, or prefer to use the computer keyboard, you can use Palm™ Desktop software, or any supported PIM such as Microsoft Outlook, to enter information. You can then perform a HotSync® operation to synchronize the information on your computer with the information on your handheld. See the section that begins on page 76 for details on HotSync operations.

Refer to Palm Desktop online Help or the documentation that came with your PIM software for more information on entering data on your computer.

# Importing data

If you have data stored in computer applications such as spreadsheets and databases, or if you want to import data from another Palm OS® handheld, you can transfer the data to your handheld without having to key it in manually. Save the data in one of the file formats listed below, import it into Palm Desktop software, and then perform a HotSync operation to transfer the data to your handheld.

Palm Desktop software can import data in the following file formats:

- Comma delimited (.csv, .txt): Address and Memo Pad only
- Tab delimited (.tab, .tsv, .txt): Address and Memo Pad only
- CSV (Lotus Organizer 2.x/97 Mapping): Address only
- vCal (.vcs) Date Book only
- vCard (.vcf) Address only
- Date Book archive (.dba)
- Address archive (.aba)
- To Do List archive (.tda)
- Memo Pad archive (.mpa)

Archive formats can only be used with Palm Desktop software. Use the archive file formats to share information with other people who use Palm OS handhelds or to create a copy of your important Palm Desktop information.

## To import data:

1. Open Palm Desktop software.
2. Click the application into which you want to import data.
3. If you are importing records containing a field with category names, select All in the Category box.

Be sure that the same categories that appear in the imported file also exist in the application. If the categories do not exist, create them now; otherwise, the records are imported into the Unfiled category.

4. From the File menu, select Import.
5. Select the file you want to import.
6. Click Open.
7. To import data into the correct Palm Desktop fields, drag fields in the left-hand column so that they are opposite the corresponding imported field on the right.
8. If you do not want to import a field, deselect the check box for that field.

9. Click OK.

The imported data is highlighted in the application.

10. To add the imported data to your handheld, perform a HotSync operation.

See Palm Desktop online Help for more information on importing and exporting data.



## Chapter 3

# Managing Your Applications

This chapter explains how to switch between applications on your Treo™ 90 handheld, how to change application settings so they are personalized to your work methods, and how to categorize applications so you view them in related groups.

## Using the Applications Launcher

Your handheld is equipped with a variety of applications. All the applications installed on your handheld appear in the Applications Launcher.

### Opening applications

You can use the Applications Launcher to open any application installed on your handheld. You can also open the four main applications – Date Book Plus, Contacts, To Do List, and Memo Pad – with the application buttons on the front panel of your handheld.



**Tip:** When you press an application button on the front panel of your handheld, you have instant access to the selected application. You don't even need to turn on your handheld first.

In addition to providing a way for you to open applications, the Applications Launcher displays the current time, battery level, and application category.

To open an application:



1. Press Option  and then press Menu  to access the Applications Launcher.



2. Press the scroll buttons to select the application you want to open.
3. Press Space  or press Return  to launch the application.

**Tip:** You can also tap the icon of the application that you want to open. To find an application quickly, you can type the first few letters of its name. The Applications Launcher scrolls to the first application with a name that begins with those letters. You can also create categories and organize your applications by category. See page 38 for details.



# Switching between applications

When working in any application, press Option  and then press Menu , or press an application button on the front panel of your handheld to switch to another application. Your handheld automatically saves your work in the current application and displays it when you return to that application.





# Categorizing applications

The category feature enables you to manage the number of application icons that appear onscreen in the Applications Launcher. You can assign an application to a category and then display a single category or all your applications.

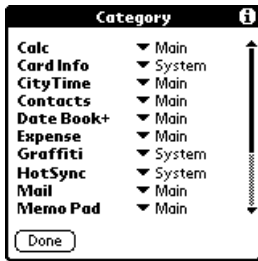



## To categorize an application:

1. Press Option  and then press Menu  to access the Applications Launcher.
2. Press Menu  again to open the menus.
3. Under App, select Category (/Y).



4. Tap the pick list next to each application to select a category.  
Tip: To create a new category, tap Edit Categories from the pick list. Tap New, enter the category name. Hold Option  and press Return  twice to add the category.
5. Hold Option  and press Return  to finish.





## To display applications by category:

1. Press Option  and then press Menu  to access the Applications Launcher.
2. Do one of the following:
  - Hold Option  and press Menu  repeatedly to cycle through all your categories.
  - Tap the pick list in the upper-right corner of the screen and select the category you want to display.

# Changing the Applications Launcher display





By default, the Applications Launcher displays each application as an icon. As an alternative, you can choose to show a list of applications. You can also choose to view the same category of applications each time you open the Applications Launcher.

To change the Applications Launcher display:

1. Press Option  and then press Menu  to access the Applications Launcher.
2. Press Menu  again to open the menus.
3. Under Options, select Preferences(/R).
4. Tap the View By pick list and select List.
5. Hold Option  and press Return  to finish.



To open the Applications Launcher to the last opened category:

1. Press Option  and then press Menu  to access the Applications Launcher.
2. Press Menu  again to open the menus.
3. Under Options, select Preferences (/R).
4. Tap the Remember Last Category check box to select it.
5. Hold Option  and press Return  to finish.



## Choosing preferences

You can set options that affect an entire application in the application's Preferences dialog box.

To change preferences for an application:

1. Open an application.
2. Press Menu .
3. Under Options, select Preferences (/R).

Note: Not all applications have a Preferences command.

4. Make changes to the settings.
5. Hold Option  and press Return  to finish.

# Installing and removing applications

This section explains how to install and remove applications on your handheld and how to remove Palm™ Desktop software from your computer.

## Installing add-on applications

Your handheld comes with the Contacts, Date Book Plus, To Do List, Memo Pad, Expense, Calculator, CityTime, and Palm Mail applications installed and ready to use. The Handspring CD-ROM also includes a wireless application suite which you can install from the CD-ROM if you want to configure your handheld for wireless communication.

You can also install additional applications on your handheld, such as business applications, games, and other software. The Install Tool makes it easy to install software on your handheld during a HotSync® operation. There are a variety of third-party applications available for devices that use Palm OS software. To learn more about these applications, go to the web site: [www.handspring.com](http://www.handspring.com).

When you download an add-on application from the Internet, it is probably in a compressed format such as a .zip or .sit file. If the file is compressed, you need to use a decompression utility on your computer, to decompress the .prc and .pdb files inside the compressed file. A trial version of the PKZIP decompression utility is located on your computer in the Programs\Handspring\Utility folder. If you need a different decompression utility, search the Internet using phrases like 'zip decompression' or 'how to unzip'. This will lead you to various third-party utilities that you can use to decompress any kind of compressed or downloaded file--not just add-ons for your handheld. After you install the utility, you are ready to decompress the add-on application files that you downloaded.

**Note:** Any applications that you install on your handheld resides in RAM memory; you can delete them at any time.

### To install add-on software on your handheld:

1. Copy or download the application you want to install into the add-on folder in your Handspring (or Palm) directory on your computer.

**Note:** If the software you download is compressed, you need to decompress it into this folder. If you prefer to place the application into another folder, you need to navigate to that folder before you complete step 5.

2. Double-click the Palm Desktop icon on your desktop.



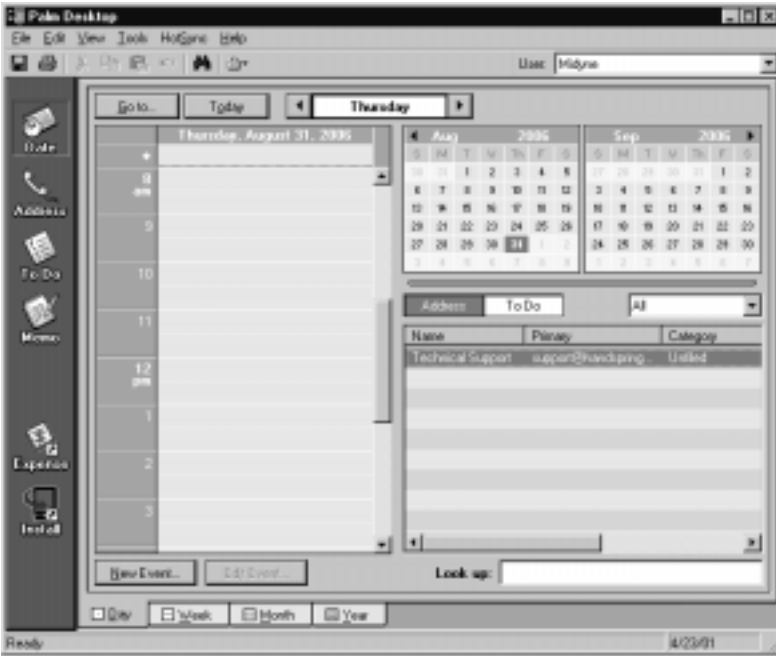

3. Click Install.

Tip: You can also access the Install Tool dialog box by selecting Install Tool under Handspring on the Start menu, or by double-clicking any file with a PRC file extension.

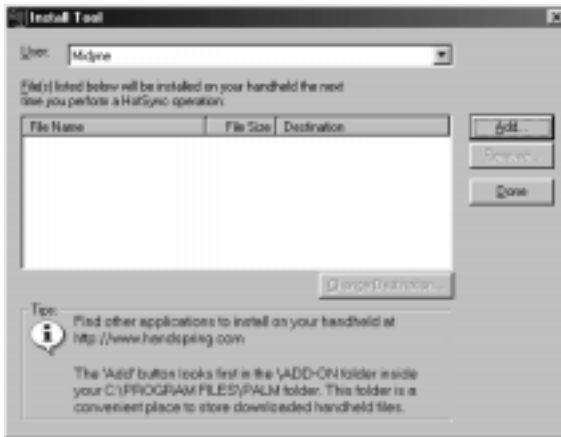

4. In the User drop-down list, select the name that corresponds to your handheld.

5. Click Add.



6. Select the application(s) that you want to install on your handheld.
7. Click Open.

**Note:** Review the list of applications you selected in the Install Tool dialog box. If you do not want to install an application, select it, and then click Remove. (This does not remove the application from your computer; it simply removes it from the list of applications to install.)

8. If you want to install the application(s) on an expansion card, click Change Destination, click the arrows to move the application(s) to the expansion card pane, and then click OK.

**Note:** Before you install an application on an expansion card, make sure that it is compatible with Palm OS version 4.0. Older applications may not work properly when installed on an expansion card.



9. Click Done.
10. Perform a HotSync operation to install the application(s) you selected in step 6. See the section that begins on page 76 for details.

**Tip:** You can also install an application by simply double-clicking the application's icon.

## Removing applications



In the event that you run out of memory or decide that you no longer need an application you installed, you can remove applications from your handheld. You can remove only add-on applications, patches, and extensions that you install; you cannot remove the applications that reside in the ROM portion of your handheld.

**To remove an add-on application:**

1. Press Option  and then press Menu  to access the Applications Launcher.
2. Press Menu  again to open the menus.
3. Under App, select Delete (/D).
4. If you want to remove an application from an expansion card, tap the Delete From pick list and select the card name.

Note: To delete an application from an expansion card, you must first insert the card into your handheld. See page 44 for details.



5. Tap the application that you want to remove.
6. Tap Delete.
7. Hold Option  and press Return  twice to finish.
8. Check the Backup folder in the Palm Desktop folder on your computer. If you find a PRC file for the application you just removed, delete the PRC file from the Backup folder.

Tip: If you installed Palm Desktop software for the first time when you purchased your Treo handheld, the Palm Desktop software is located in the Handspring folder. If you upgraded from a previous version of Palm Desktop software, these files are most likely located in the Palm folder.

## Removing Palm Desktop software

Removing Palm Desktop software also removes HotSync Manager. If you remove this software from your computer, you cannot synchronize your data. So, we highly recommend leaving Palm Desktop software on your computer.

To remove Palm Desktop software:

1. From the Windows Start menu, choose Programs, Handspring (or Palm) and then Uninstall.
2. Click Yes to uninstall the software.

# Working with expansion cards

The expansion slot on your handheld enables you to add Secure Digital (SD) cards and MultiMedia Cards (MMC) that extend the functionality and storage capacity of your handheld. Your Treo comes with a mock, non-functional card inside the expansion slot. When you do not have a functioning card inside the expansion slot, reinsert the mock card to protect the slot opening.

## To insert and remove an expansion card:

1. Press down and release the mock card.
2. After you feel the expansion slot eject the mock card, remove the card from the expansion slot.

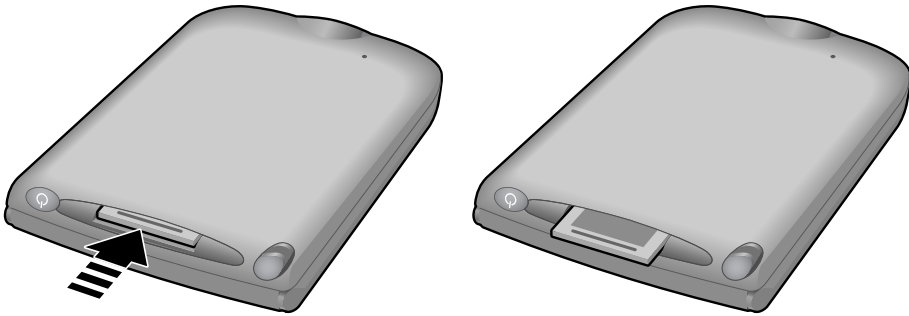

3. Hold the card so it is facing in the same direction as the card icon on the back of your handheld.
4. Insert the card into the expansion slot until you feel the card lock into place and hear the confirmation tone.

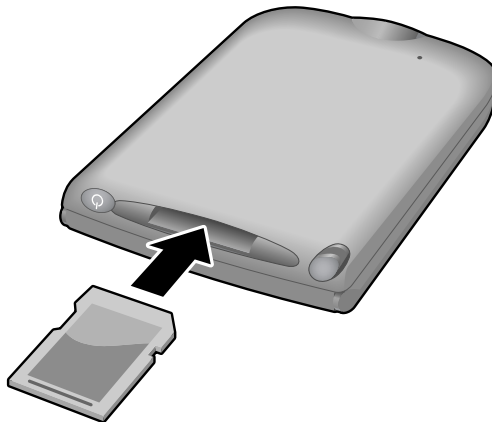

5. When you're done using the expansion card, repeat steps 1 and 2 to remove the expansion card.
6. Reinsert the mock card to keep the expansion slot clean.

## Opening applications on an expansion card

After you insert an expansion card in the expansion slot, you can open any of the applications stored on the expansion card.

To open an application on an expansion card:

1. Insert the expansion card into the expansion slot as described in the previous section.

The Applications Launcher automatically displays its contents.

2. Press the scroll buttons to select the icon associated with the application you want to open.



**Tip:** To switch between the applications on the expansion card and your handheld, tap the category pick list in the upper-right corner and select another category. When you insert an expansion card, the card name appears as a new category with a card icon next to the name. This enables you to easily switch between applications on your handheld and the expansion card.



3. Press Space  or press Return  to launch the application.

## Copying applications to an expansion card

You can copy applications between your handheld and your expansion card.

**Note:** Before you copy an application to an expansion card, make sure that it is compatible with Palm OS version 4.0. Older applications may not work properly when used on an expansion card.

To copy an application to an expansion card:

1. Press Option  and then press Menu  to access the Applications Launcher.
2. Press Menu  again to open the menus.
3. Under App, select Copy (/C).







4. Tap the Copy To pick list and select the destination: card name, or Handheld.
5. Tap the From pick list and select the location of the application you want to copy: card name, or Handheld.
6. Tap the application you want to copy.
7. Tap Copy.

## Using the Card Info application

The Card Info application displays general information about the expansion card that is currently in the expansion slot and it enables you to rename and format a card.

To view expansion card information:

1. Press Option  and then press Menu  to access the Applications Launcher.
2. Press the scroll buttons to select the Card Info icon .
3. Press Space  or press Return  to launch the application.

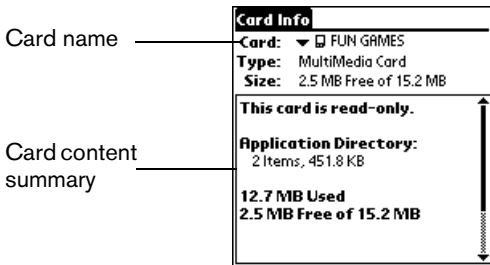



## Renaming an expansion card

If you change the contents of an expansion card, you may at some point want to rename the card to better match its contents.

To rename an expansion card:

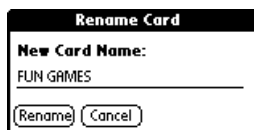
1. Press Menu .
2. Under Card, select Rename Card (/R).
3. Enter the new name for the card.





4. Hold Option  and press Return  to finish.

## Formatting an expansion card

When you format an expansion card, you erase all the data stored on the card and prepare it to a blank state. Formatting an expansion card is similar to formatting a diskette on a computer.

To format an expansion card:

1. Press Menu .
2. Under Card, select Format Card (/F).
3. Hold Option  and press Return  to finish.

## Security

Your handheld comes with a Security application so that unauthorized users cannot view the entries you wish to protect.





In Security, you can do the following:

- Mask or hide entries you define as private. The Mask option displays a gray bar over private records, and the Hide option completely removes (hides) private records. See the section that begins on page 73 for more information.
- Assign a password to the Security viewing options. Assigning a password requires you to enter a password to view masked or hidden private entries; not assigning a password enables you (or anyone else) to view individual masked private entries by tapping them, and to view all hidden or masked private entries by selecting Show Records in the Security dialog box.
- Lock and turn off your handheld so that it does not operate until you enter the correct password.



# Assigning a password

You can assign a password to protect your private records and to lock your handheld.

To assign a password:

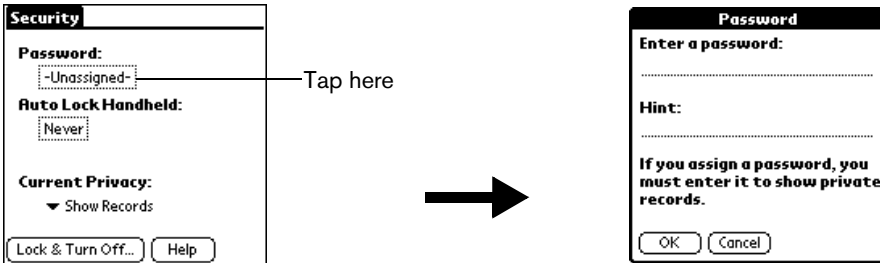
1. Press Option  and then press Menu  to access the Applications Launcher.
2. Tap the Security icon .
3. Tap the Password box.
4. Enter a password.
5. Hold Option  and press Return .



6. Enter the *same* password a second time.
7. Hold Option  and press Return  to finish.

# Changing or deleting a password

Once you define a password for your handheld, you can change or delete it at any time. You must enter the current password before you can change or delete it.

To change or delete your password:

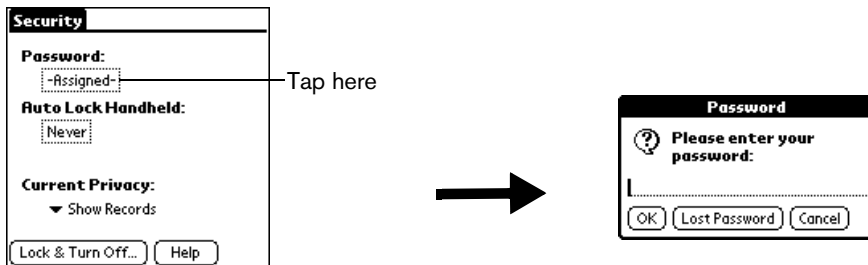

1. Tap the Password box.
2. Enter the current password.



3. Hold Option  and press Return .



4. Do one of the following:

- To change the password, enter the new password, and hold Option  and press Return .
- To delete the password, tap Unassign.

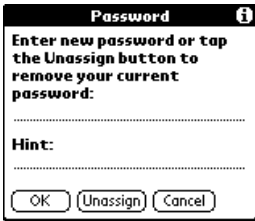

## Locking your handheld

You can also lock your handheld so that you need to enter your password to operate it. There are two ways to lock your handheld: manually and automatically.

**Important:** If you lock your handheld, you must enter the exact password to re-activate your handheld. If you forget the password, you need to perform a hard reset to resume using your handheld. Performing a hard reset deletes all the records in your handheld; however, you can restore all previously synchronized data at the next HotSync operation. See page 215 for details.

To lock your handheld manually:

1. Assign a password.
2. Tap Lock & Turn Off.

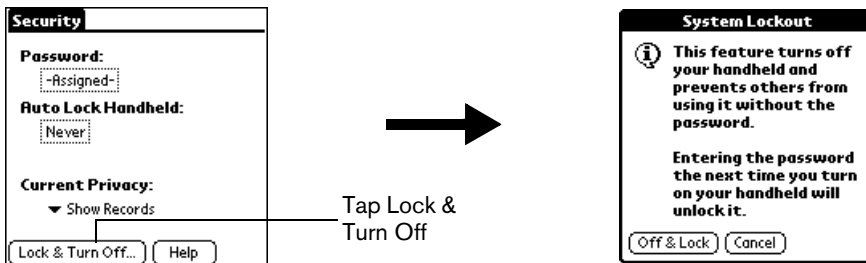

3. Tap Off & Lock.
4. To start your handheld, turn it on, and then enter the password.

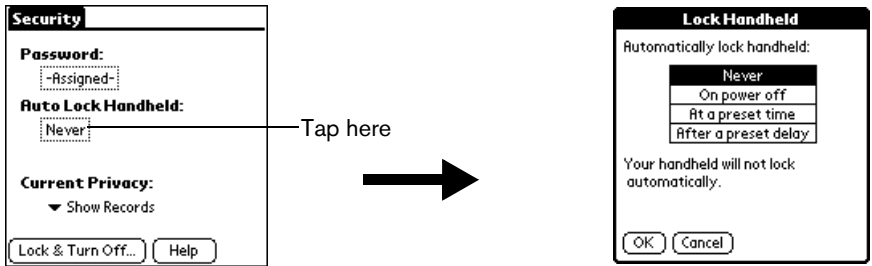

To lock your handheld automatically:

1. Assign a password.
2. Tap the Auto Lock Handheld box.
3. When prompted, enter your password.



4. Tap one of the following options:

- Never** Prevents your handheld from locking automatically.
- On power off** Locks your handheld when you turn it off, or when it shuts off with the auto-off feature.
- At a preset time** Locks your handheld at a specific time of day. If you choose this option, the Set Time dialog box appears for you to specify when you want your handheld to lock.
- After a preset delay** Locks your handheld after a period of inactivity. If you choose this option, the minutes field appears for you to specify the number of minutes after which you want your handheld to lock.

5. Hold Option  and press Return  to finish.
6. To start your handheld, turn it on, and then enter the password.

## Recovering from a forgotten password



If you lock your handheld and you forget your password, you can delete the password from your handheld. Deleting a forgotten password also deletes all entries and files marked as Private.

**Important:** If you synchronize with your computer before deleting a forgotten password, your handheld restores your private entries the next time you perform a HotSync operation, but it does not restore the password.

To delete a forgotten password:

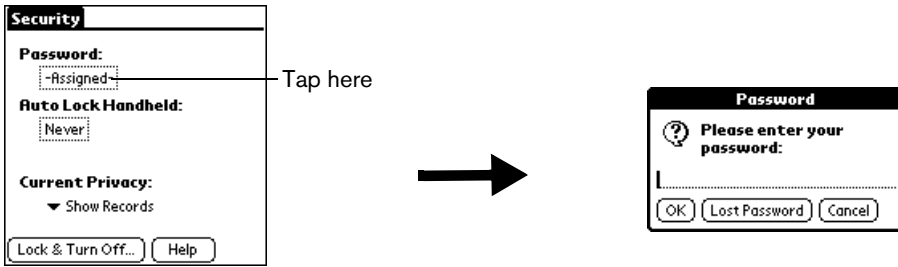
1. Tap the Password box.



2. Tap Lost Password.
3. Hold Option  and press Return  for Yes.



## Chapter 4

# Applications Overview

This chapter briefly describes each application and how to open it. Your Treo™ 90 handheld comes with these applications already installed:

- Date Book Plus
- Contacts
- To Do List
- Memo Pad
- CityTime
- Calculator
- Expense

# Date Book Plus



Date Book Plus lets you quickly and easily schedule appointments or any kind of activity associated with a date and/or a time.

## In Date Book Plus, you can do the following:

- Enter a description of your appointment and assign it to a specific time and date.
- Display a chart of your appointments for an entire week to easily spot available times and any potential scheduling overlaps or conflicts, or display descriptions of your appointments for one or two weeks.
- Display a monthly calendar to quickly spot days where you have morning, lunch, or afternoon appointments, or display a calendar for an entire year.
- Display a list of both your appointments and your To Do items.
- Create unscheduled events or To Do items that float from one day to the next until you complete them.
- Create a Daily Journal to track events with automatic time stamps.
- Set an alarm to sound prior to the scheduled activity, and create reminders for events that are based on a particular date, rather than time of day, such as birthdays and anniversaries.
- Attach notes to individual events for a description or clarification of the entry in your Date Book.

## To open Date Book Plus:

- Press Date Book Plus . Date Book Plus opens to today's schedule.



Date Book Plus button

Tip: Press Date Book Plus  repeatedly to cycle through the Day, Week, Week with Text, Month, Year, and List views.

# Contacts



Contacts enables you to keep names, addresses, phone numbers, and other information about your personal or business contacts.

## In Contacts, you can do the following:

- Store thousands of names, addresses, phone numbers, e-mail addresses, and more.
- Quickly look up, enter, or duplicate names, addresses, phone numbers, and other information.
- Enter up to five phone numbers (home, work, fax, mobile, etc.) or e-mail addresses for each name.
- Attach a note to each Contacts entry, in which you can enter additional information about the entry.
- Assign Contacts entries to categories so that you can organize and view them in logical groups.
- Dial numbers using infrared communication and a data-enabled mobile phone.

## To open Contacts:

- Press Contacts . Contacts opens to display the Contacts list.



Contacts button

Tip: Press Contacts repeatedly to cycle through the categories in which you have entries.

# To Do List



To Do List is a convenient place to create reminders and prioritize the things that you have to do.

## In To Do List, you can do the following:

- Make a quick and convenient list of things to do.
- Assign a priority level to each task.
- Assign a due date for any or all of your To Do items.
- Assign To Do items to categories so that you can organize and view them in logical groups.
- Sort your To Do items either by due date, priority level, or category.
- Attach notes to individual To Do items for a description or clarification of the task.

## To open To Do List:

- Press To Do List . To Do List displays the category of items you last viewed.



To Do List button

**Tip:** Press the To Do List  repeatedly to cycle through the categories in which you have To Do items.



# Memo Pad



Memo Pad provides a place to take notes that are not associated with records in other applications such as Date Book Plus, Contacts, or To Do List.

## In Memo Pad, you can do the following:

- Take notes or any kind of message on your handheld.
- Drag and drop memos into popular computer applications like Microsoft Word when you synchronize using Palm™ Desktop software and HotSync® technology.
- Assign memos to categories so that you can organize and view them in logical groups.
- Take down phone numbers and other types of information. Later, you can copy and paste this information to other applications.

## To open Memo Pad:

- Press Memo Pad . Memo Pad displays the category of memos you last viewed.



Memo Pad button

Tip: Press Memo Pad  repeatedly to cycle through the categories in which you have memos.

# CityTime





CityTime helps you keep track of the time anywhere around the globe.

## In CityTime, you can do the following:

- Select a home city as a point of reference.
- Display the day and time in four other cities simultaneously.
- Add a definition for any city that isn't in the default list.
- Display sunrise and sunset information for your home city.

## To open CityTime:

1. Press Option .
2. Press To Do List .

Tip: You can also open CityTime by tapping the CityTime icon  in the Applications Launcher.



# Calculator





Calculator enables you to perform addition, subtraction, multiplication, division and a variety of advanced math and scientific calculations.

## In Calculator, you can do the following:

- Select a view to perform specific types of calculations including: math, trigonometry, finance, logic, statistics, weight/temp, length, area, and volume.
- Store and retrieve values.
- Display the last series of calculations, which is useful for confirming a series of “chain” calculations.
- Create a custom view with the buttons you use most often.
- Switch to basic mode to perform simple calculations.

## To open Calculator:

1. Press Option .
2. Press Memo Pad .

Tip: You can also open Calculator by tapping the Calculator icon  in the Applications Launcher.

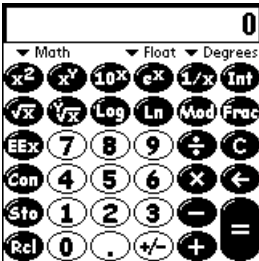

Tip: Hold Option  and press Memo Pad  repeatedly to toggle between Basic and Advanced mode.

# Expense





Expense lets you keep track of your expenses and then transfer the information to a spreadsheet on your computer.

## In Expense, you can do the following:

- Record dates, types of expenses, amount spent, payment method, and other details associated with any money that you spend.
- Assign expense items to categories so that you can organize and view them in logical groups.
- Keep track of vendors (companies) and people involved with each particular expense.
- Log miles traveled for a particular date or expense category.
- Sort your expenses by date or expense type.
- Transfer your expense information to a Microsoft Excel spreadsheet (version 5.0 or later) on your computer. (Microsoft Excel is *not* included in the Treo handheld package.)

## To open Expense:

1. Press Option .
2. Press Menu .
3. Tap the Expense icon .



Expense		▼ All
4/14 Taxi	\$	20.00
4/14 Lunch	\$	42.75
4/14 Hotel	\$	98.25
4/14 Car Rental	\$	127.38

Buttons: New, Details..., Show...

## Chapter 5

# Common Tasks



Your Treo™ 90 handheld includes a full suite of personal information manager (PIM) applications: Date Book Plus, Contacts, To Do List, Memo Pad, and Expense. This chapter provides instructions on how to do tasks that are common to these applications. It's easy to transfer what you learn in one application to the other applications because the structure and behavior of these applications are quite similar.

Throughout this chapter, the term "record" is used to refer to an individual item in any of the PIM applications: a single Date Book Plus event, Contacts entry, To Do List item, Memo Pad memo, or Expense item.



## Creating records

You can use the following procedure to create a new record in Date Book Plus, Contacts, To Do List, Memo Pad, and Expense.

**To create a record:**

1. Open the application in which you want to create a record.
2. Press Menu .
3. Under Record, select New... (/N).
4. In Date Book Plus only: Select start and end times for your event, and then hold Option  and press Return .
5. Enter text for the record.

**Note:** You do not have to press Shift  to capitalize the first letter of the name. Your handheld automatically capitalizes the first letter of each field (except numeric and e-mail fields).

6. Use the scroll buttons or tap a field directly to move between fields.
7. (Optional) Tap Details to select attributes for the record.
8. In Contacts only: Hold Option  and press Return  to finish.

There's no need to save the record because your handheld saves it automatically.

# Editing records

After you create a record, you can change, delete, or enter new text at any time. Two screen features tell you when your handheld is in editing mode:

- A blinking cursor
- One or more edit lines

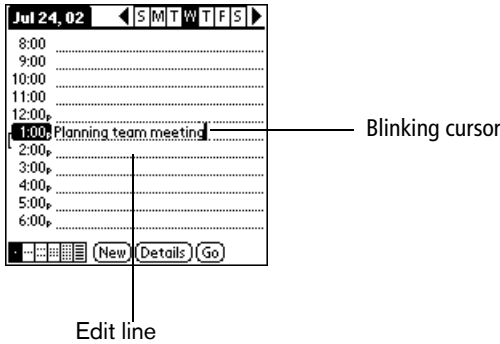

## Entering text

For information on how to enter text using the keyboard on your handheld, the onscreen keyboard, or the keyboard attached to your computer, see Chapter 2.

## Edit menu

The Edit menu is available with any screen where you enter or edit text. In general, commands available in the Edit menu apply to text that you *select* (or highlight) in an application.



To select text in an application:

1. Tap the beginning of the text that you want to select.
2. Drag the stylus over the text to highlight it. You can drag *across* the text to select additional words, or drag *down* to select a group of lines.

Tip: To select a word, double-tap the word. To select a whole line, triple-tap the line.

The following commands may appear in an Edit menu:

- Undo** Reverses the action of the *last edit* command. For example, if you used Cut to remove text, Undo restores the text you removed. Undo also reverses deletions done by using backspace.
- Cut** Removes the selected text and stores it temporarily in the memory of your handheld. You can paste the text you cut into another area of the current application or into a different application.

<b>Copy</b>	Copies the selected text and stores it temporarily in the memory of your handheld. You can paste the text that you copy into another area of the current application or into a different application.
<b>Paste</b>	Inserts the text that you cut or copied at the selected point in a record. The text you paste replaces any selected text. If you did not previously cut or copy text, Paste does nothing.
<b>Select All</b>	Selects all of the text in the current record or screen. This enables you to cut or copy all of the text and paste it elsewhere.
<b>Keyboard</b>	Opens the onscreen keyboard. When you finish with the onscreen keyboard, hold Option  and press Return  to finish.
<b>Keyboard Help</b>	Opens screens that show many keyboard shortcuts and the base characters associated with symbols and other extended characters. Use this command anytime you need forget how to do something with the keyboard.

## Deleting records

To delete a record in any of the PIM applications:

1. Select the record you want to delete.
2. Press Menu .
3. Under Record, select the Delete command:

Date Book Plus: Delete Event



Contacts: Delete Contact

To Do List: Delete Item

Memo Pad: Delete Memo

Expense: Delete Item



A confirmation dialog box appears. If you want to save a copy of the deleted item to an archive file in Palm Desktop software, be sure that the check box is checked. If you don't want to save a copy, tap the check box to remove the check.

4. Hold Option  and press Return  to finish.

If you choose to save a copy of the selected item, your handheld transfers it to the archive file on your desktop the next time you perform a HotSync operation.

## Other ways to delete records

You can also delete records in the following ways:

- In the Details dialog box of the application, tap Delete, and then hold Option  and press Return  to finish.
- Delete the text of the record.

Note: In Date Book Plus, if you delete the text of a repeating event, you delete all instances of that event.

## Purging records

Over time, as you use Date Book Plus, To Do List, and Expense, you'll accumulate records in these applications that have outlived their usefulness. For example, events that occurred months ago remain in the Date Book Plus, and To Do items that you marked as completed remain in the list, as do Expense items.

All these outdated records take up memory on your handheld, so it's a good idea to remove them by using Purge. If you think Date Book Plus or To Do List records might prove useful later, you can purge them from your handheld and save them in an archive file.

Purging is not available in Contacts or Memo Pad, so delete outdated records from these applications individually.



### To purge records:

1. Open the application.
2. Press Menu .
3. Under Record, select Purge (/E).

A confirmation dialog box appears.

Date Book Plus: Tap the pick list and select how old a record must be to be purged. Purge deletes repeating events if the last of the series ends before the date that you purge records.

Date Book Plus, To Do List: If you want to save a copy of the purged records to an archive file on your desktop, be sure that the check box is checked. If you don't want to save a copy, tap the check box to remove the check box.

4. Hold Option  and press Return  to finish.

If you chose to save a copy of the purged records, your handheld transfers them to an archive file on your desktop the next time you perform a HotSync operation.

Note: Purging does not happen automatically. You must use the Purge command to make it happen.



# Categorizing records

Categorize records in Contacts, To Do List, Memo Pad, and Expense applications so that they are grouped logically and are easy to review. (You can also categorize applications. See page 37 for details.)

When you create a record, your handheld automatically places it in the category that is currently displayed. If the category is All, your handheld assigns it to the Unfiled category. You can leave an entry as Unfiled or assign it to a category at any time.

## System-defined and user-defined categories

By default, your handheld includes system-defined categories, such as All and Unfiled, and user-defined categories, such as Business and Personal.

You cannot modify the system-defined categories, but you can rename and delete the user-defined categories. In addition, you can create your own user-defined categories. You can have a maximum of 15 user-defined categories in each application.

Contacts contains the QuickList user-defined category, in which you can store the names, addresses, and phone numbers you might need in emergencies (doctor, fire department, lawyer, etc.).

Expense contains two user-defined categories, New York and Paris, to show how you might sort your expenses for different business trips.



Note: The illustrations in this section come from Memo Pad, but you can use these procedures in all the applications in which categories are available. Categories are not available in Date Book Plus.

### To move a record into a category:

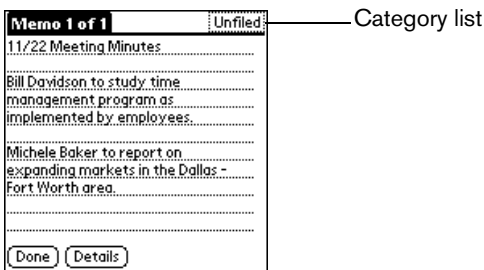
1. Open the record you want to categorize.
2. In Contacts: Press Menu , and under Record, select Edit Contact (/E).
3. In the record view, tap the Category list to display the list of available categories.



4. Select the category for the record.

Tip: You can also assign a record to a category by tapping the Details button, selecting a category from the Category pick list in the Details dialog box, and then holding Option  and pressing Return  to finish.

To display a category of records:

1. Tap the category pick list in the upper-right corner of the list screen.

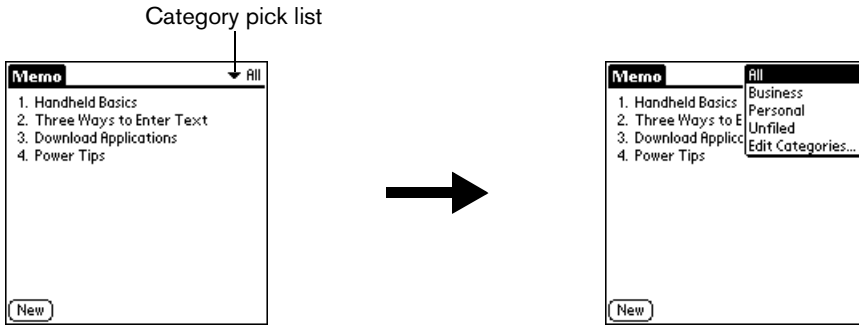

2. Select the category you want to view.

The list screen now displays only the records assigned to that category.

To define a new category:

1. Tap the category pick list in the upper-right corner of the screen.

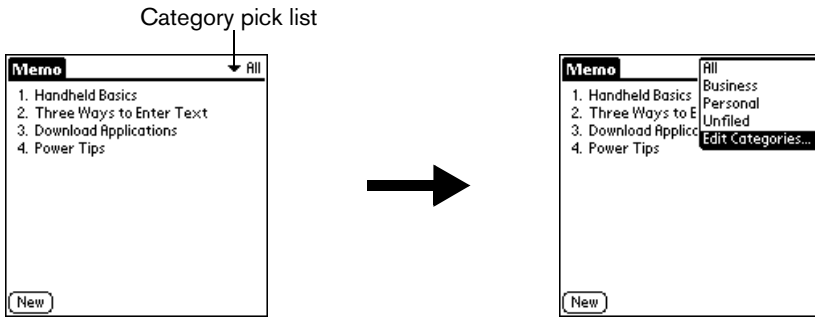



2. Tap Edit Categories.
3. Tap New.



4. Enter the name of the new category.



5. Hold Option  and press Return  twice to finish.

You can assign any of your records to the new category.

To rename a category:

1. Tap the category pick list in the upper-right corner of the screen.
2. Tap Edit Categories.
3. Select the category that you want to rename, and then tap Rename.



4. Enter the new name for the category.



5. Hold Option  and press Return  twice to finish.

**Tip:** You can group the records in two or more categories into one category by giving the categories the same name. For example, if you change the name of the Personal category to Business, all records formerly in the Personal category appear in the Business category.

## Finding records

Your handheld offers several ways to find information quickly:

- All applications: The Find utility locates any text that you specify, always starting with the current application.
- Date Book Plus, To Do List, Memo Pad: The Phone Number Lookup feature displays the Contacts list and shows names and phone numbers for entries that have phone numbers. You can add the information that appears in this list to a record.

- **Contacts:** The Instant Lookup feature lets you scroll immediately to a Contacts entry by entering the first few letters of a first or last name, or the first name initial and the first few letters of a last name.
- **Expense:** The Lookup feature displays the Contacts entries that have data in the Company field. You can add these names to a list of attendees associated with an Expense record.

## Looking up Contacts records

When working with Contacts, the buttons on your handheld make it easy to navigate among your Contacts entries.

- In the Contacts list screen, the scroll buttons move the highlight. Holding Shift  and using the scroll buttons moves up or down an entire screen of records. If you press and hold a scroll button, you accelerate the scrolling.
- In the Contact View screen, the scroll buttons move to the previous or next Contacts record.

You can also use the Instant Lookup feature, to quickly scroll to any of your Contacts entries.

### To use Instant Lookup to find a Contacts record:

1. From the Contact list, tap the Look Up line.
2. Enter one of the following for the name you want to find:
  - First name initial and last name.
  - First name
  - Last name

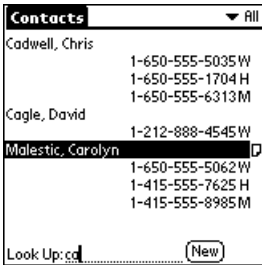



For example, entering an "ca" displays "Chris Cadwell," "David Cagle," and "Carolyn Malestic" as shown above. Entering "cma" finds only "Carolyn Malestic."

3. Use the scroll buttons to select the contact name.
4. Press Return  to view the contents of the record.

## Using Find

You can use Find to locate any text that you specify, in any application.

To use Find:

1. Press Option  and then press Shift  to open the Find dialog box.

Tip: If you select text in an application before you opening the Find dialog box, the selected text automatically appears in the Find dialog box.

2. Enter the text that you want to find.

Find is *not* case-sensitive. For example, searching for the name “davidson” also finds “Davidson.”

Find locates any word that begin with the text you enter. For example, searching for “plan” finds “planet,” but not “airplane.”

3. Hold Option  and press Return  to start the search.

Find searches for the text in all records and all notes.

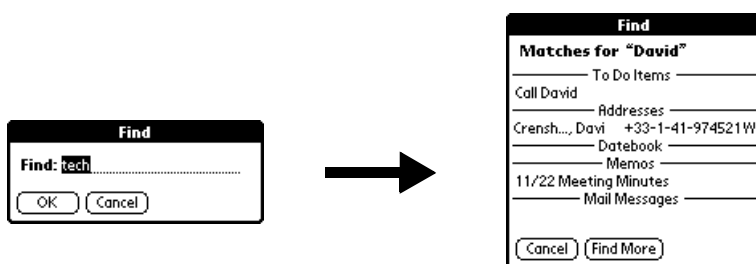

As your handheld searches for the text, you can tap Stop at any time. You may want to do this if the entry you want appears before your handheld finishes the search. To continue the search after you tap Stop, tap Find More.

4. Tap the text that you want to review.

## Using Phone Number Lookup

Phone Number Lookup displays the information you entered in Contacts, and it lets you add this information to a record.

To use Phone Number Lookup:

1. Display the record in which you want to insert a phone number. The record can be in Date Book Plus, To Do List, or Memo Pad.
2. Press Menu .
3. Under Options, select Phone Lookup (/L).
4. If your Contacts entries are sorted by last name, begin to spell the last name. If your Contacts are sorted by first name, begin to spell the first name.

Note: The first initial and last name search in the Contacts Instant Lookup feature is not available in the Phone Number Lookup feature.

Phone Number Lookup displays records that begin with the letters you enter based on the sort method in your Contacts application. For example, if your Contacts are sorted by last name and you enter "su," the list displays "John Sung" and "Mario Suarez." If your Contacts are sorted by first name, and you enter "su," the list displays "Susan Smith" and "Suki Sakimoto."

5. Continue to spell the name you're looking for, or when you see the name, scroll to it.



6. Press Space  or Return .

The name you selected, along with the other information associated with it, is pasted into the record you selected in step 1.

## Phone Number Lookup tips

You can also enter the keyboard shortcut (/L) to activate the Phone Number Lookup feature in the following circumstances:

- While entering text: For example, if your Contacts entries are sorted by last name and you want to insert the full name and phone number for someone with the last name "Williams," enter "Wi" and then the Phone Number Lookup keyboard shortcut (/L). Assuming you have only one Contacts record with a last name that begins with "Wi," your handheld inserts the full name "Fred Williams" (and its associated information). If you have more than one name that begins with "Wi," the Phone Number Lookup screen appears and highlights the first record that begins with "Wi."
- For selected text: Drag to highlight the text, and then enter the Phone Number Lookup keyboard shortcut (/L). Your handheld replaces the selected text and adds the name and its associated information.

## Looking up names to add to expense records

In Expense, Lookup displays the names of Contacts entries that have data in the Company field. You can add these names to a list of attendees associated with an Expense record.

To add names to an Expense record:

1. Open the Expense record to which you want to add names.
2. Tap Details.

**Receipt Details**  
Category: ▼ Unfiled  
Type: ▼ Lunch  
Payment: ▼ Unfiled  
Currency: ▼ \$  
Vendor: .....  
City: .....  
Attendees: Who...  
OK Cancel Delete Note ↑



3. Tap Who.

**Receipt Details**  
Category: ▼ Unfiled  
Type: ▼ Lunch  
Payment: ▼ MasterCard  
Currency: ▼ \$  
Vendor: Rosie's Cafe  
City: San Francisco  
Attendees: Who... Tap here  
OK Cancel Delete Note ↑



**Attendees**  
.....  
.....  
.....  
.....  
.....  
.....  
.....  
.....  
.....  
.....  
Done Lookup A A ↑

4. Tap Lookup.

The Attendees Lookup screen displays all the names of Contacts entries that have data in the Company field.

5. Use the scroll buttons to select the name you want to add.
6. Press Space  or Return .

The name appears in the Attendees screen.



7. Repeat steps 4 through 6 to add more names.
8. Hold Option  and press Return  twice to finish.

# Sorting lists of records

You can sort lists of records in various ways, depending on the application. Sorting is available in applications that have list screens: Contacts, To Do List, Memo Pad, and Expense.

Note: You can also assign records to categories. See page 65 for details.

To sort records in To Do List and Expense:

1. Open the application to display the list screen.
2. Tap Show.
3. Tap the Sort by pick list and select an option.
4. Hold Option  and press Return  to finish.

To sort records in Contacts and Memo Pad:

1. Open the application to display the list screen.
2. Press Menu .
3. Under Options, select Preferences (/R).



Contacts

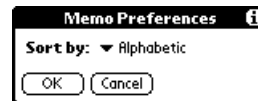



Memo Pad

4. Do one of the following:

Contacts: Tap the setting you want.

Memo Pad: Tap the Sort by pick list and select Alphabetic or Manual.

5. Hold Option  and press Return  to finish.

To sort the Memo list manually, tap and drag a memo to a new location in the list.

Note: To make the list of your memos appear in Palm Desktop software as you manually sorted it on your handheld, open Memo in Palm Desktop software, click Sort by, and then select Order on Handheld.



# Making records private



In all PIM applications, except Expense, you can make individual records private. Private records remain visible and accessible until you select the Security setting to hide or mask all private records. See the section that begins on page 47 for details.

## Hiding and masking private records



You can hide records that you mark as private. When you hide records, they do not appear anywhere in the application. When you mask records, a visual placeholder appears where the record would normally appear. If you define a password, you must enter it to display private records.

**Note:** As a security measure, masked Contacts records are temporarily hidden when you search for records. So you will not see a placeholder for these records when viewing the results of a Lookup or Find request.



### To make a record private:

1. Display the entry that you want to make private.
2. Tap Details.
3. Tap the Private check box to select it.
4. Hold Option  and press Return  to finish.

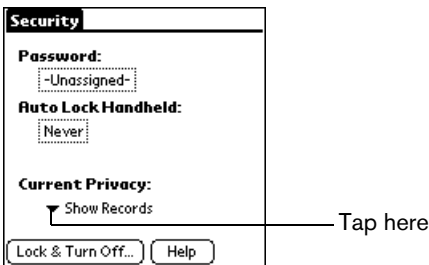

### To hide or mask all private records:

1. Make sure the records you want to mask are marked private.
2. Press Option  and then press Menu  to access the Applications Launcher.
3. Tap the Security icon .
4. Tap the Current Privacy pick list.



5. Tap either Hide Records or Mask Records.
6. Hold Option  and press Return  to confirm that you want to change the security setting.

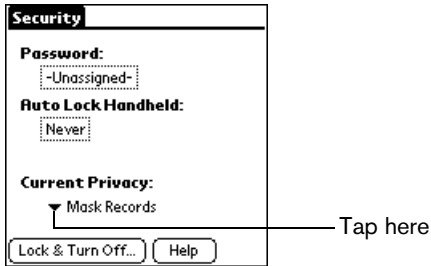

### To display all private records:

1. Press Option  and then press Menu  to access the Applications Launcher.
2. Tap the Security icon .
3. Tap the Current Privacy pick list.



4. Tap Show Records.



If you do not have a password, private records become visible.

If you have a password, the Show Private Records dialog box appears. Enter your password in this dialog box, and then hold Option  and press Return  to finish.

### To display a specific masked record:

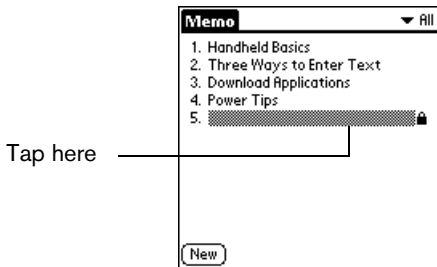
1. Open the application that contains the record you want to view.
2. Tap the shaded bar that masks the record.





Note: If you have a password, you must enter your password and then hold Option  and press Return  to view the record. The record becomes masked again when you move to another record.

### To display all private records in a specific application:

1. Open the application in which you want to display the records.
2. Press Menu .
3. Under Options, select Security (/H).
4. Tap the Current Privacy pick list.





5. Tap Show Records.
6. Hold Option  and press Return  to finish.

## Attaching notes

In all PIM applications except Memo Pad, you can attach a note to a record. A note can be up to several thousand characters long. For example, for an appointment in Date Book Plus, you can attach a note with directions to the location.

### To attach a note to a record:

1. Display the entry to which you want to add a note.
2. In Contacts only: Press Menu , and under Record, select Edit Contact (/E).
3. Tap Details.
4. Tap Note.
5. Enter your note.
6. Hold Option  and press Return  to finish.

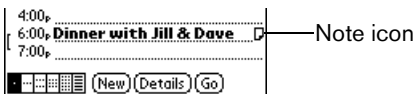

A small note icon appears at the right side of any item that has a note.



### To review or edit a note:

1. Tap the Note icon .

### To delete a note:

1. Tap the Note icon .
2. Tap Delete.
3. Hold Option  and press Return  for Yes.

# Choosing fonts

In all PIM applications except Expense, you can change the font style to make text easier to read. You can choose a different font style for each application.

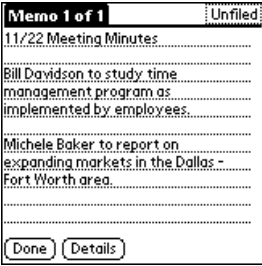

Small font



Bold font





Large font

To change the font style:

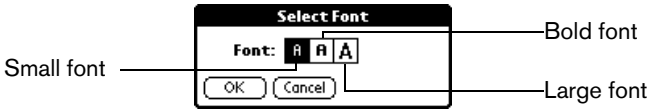
1. Open an application.
2. Press Menu .
3. Under Options, select Font (/F).
4. Use the scroll buttons to select the font style you want to use.



5. Hold Option  and press Return  to finish.

# Exchanging and updating data: HotSync operations

The HotSync process automatically synchronizes – that is, exchanges and updates – data between your handheld and desktop software. Changes you make on your handheld or desktop software appear in both places after a HotSync operation. HotSync technology synchronizes only the needed portions of files, thus reducing synchronization time. You can synchronize your data directly by connecting your handheld to your computer with the HotSync cable or by beaming the data from the IR port on your handheld to the IR port on your computer, or indirectly with a modem or network. See Chapter 8 for information about performing HotSync operations via the IR port, a modem, or a network.

## Performing a HotSync operation for the first time

The first time you synchronize your data, you need to enter user information on both the handheld and Palm Desktop software. After you enter this information and synchronize, the HotSync Manager recognizes your handheld and doesn't ask for this information again.

If you are a System Administrator preparing several handhelds for a group of users, you may want to create a user profile. See the section that begins on page 171 before performing the following steps.

**Important:** You must use the HotSync cable for your *first* HotSync operation.

The following steps assume that you have already installed the Palm Desktop software. If you have not installed this software, see page 24 for instructions.

### To perform a local HotSync operation:

1. Connect your handheld to the HotSync cable. See the section that begins on page 23 for details.
2. If the HotSync Manager is not running, start it: On the Windows desktop, click Start, and then choose Programs. Navigate to the Handspring (or Palm) program group and choose HotSync Manager. Alternatively, you can start the Palm Desktop software which automatically opens the HotSync Manager.
3. Press the HotSync button on the cable.

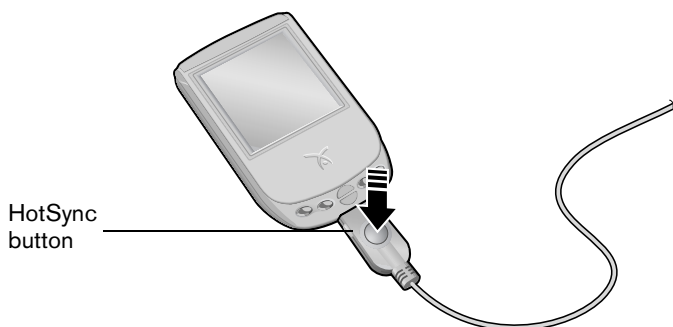

**Important:** The first time you perform a HotSync operation, you must enter a user name in the New User dialog box and click OK. Every handheld should have a unique name. To prevent loss of a user's records, never try to synchronize more than one handheld to the same user name.

4. From the Select User dialog box, choose the user name you assigned to your handheld.

The HotSync Progress dialog box appears and synchronization begins.



5. Wait for a message on your handheld indicating that the process is complete.

After the HotSync process is complete, you can remove the cable from your handheld.

## Beaming information



Your handheld is equipped with an IR (infrared) port that you can use to beam information to another Palm OS® device that's close by and also has an IR port. The IR port is located on the top of your handheld, between the expansion slot and the stylus, behind the small dark shield.

You can beam the following information between Palm OS devices:

- The record currently displayed in Date Book Plus, Contacts, To Do List, or Memo Pad
- All records of the category currently displayed in Contacts, To Do List, or Memo Pad
- A special record in Contacts that you designate as your personal business card, containing information you want to exchange with business contacts
- An application installed in RAM memory

You can also use the infrared port to perform HotSync operations. See the section that begins on page 160 for details.

### To select a business card:

1. In Contacts, create an entry that contains the information you want on your personal business card.
2. Press Menu .
3. Under Record, select Select Business Card.
4. Hold Option  and press Return  for Yes.

### To beam a record, business card, or category of records:

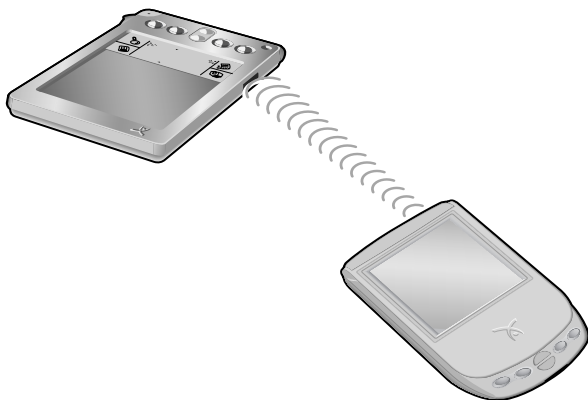

1. Locate the record, business card, or category you want to beam.
2. Press Menu .
3. Under Record, select one of the following:
  - The Beam command for an individual record (/B)
  - In Contacts only: Beam Business Card (/M)
  - Beam Category (/Y)
4. When the Beam Status dialog box appears, point the IR port directly at the IR port of the receiving handheld.

**Tip:** For best results, the path between the two handhelds must be clear of obstacles. If you have difficulty beaming information, see the troubleshooting tips that begin on page 223.



5. Wait for the Beam Status dialog box to indicate that the transfer is complete before you continue working on your handheld.

### To beam an application:

1. Press Option  and then press Menu  to access the Applications Launcher.
2. Press Menu .
3. Under App, select Beam (/B).
4. Tap the Beam From pick list and indicate whether the application you want to beam is located on your handheld or an expansion card.
5. Tap the application you want to transfer.

**Note:** Some applications are copy-protected and cannot be beamed. These are listed with a lock icon next to them.



6. Tap Beam.

7. When the Beam Status dialog box appears, point the IR port directly at the IR port of the receiving handheld.
8. Wait for the Beam Status dialog box to indicate that the transfer is complete before you continue working on your handheld.

**To receive beamed information:**

1. Turn on your handheld.
2. Point the IR port directly at the IR port of the transmitting handheld to open the Beam Status dialog box.
3. When the Beam dialog box appears, select a category for the entry.

Tip: If you do not select a category the entry is placed in the Unfiled category.

4. Hold Option  and press Return  for Yes.



## Chapter 6

# Application-Specific Tasks

This chapter is organized by application and gives instructions on how to do tasks that are specific to each of the following applications:

- Date Book Plus
- Contacts
- To Do List
- Memo Pad
- CityTime
- Calculator
- Expense

# Date Book Plus

When you open Date Book Plus, the screen shows the current date and a list of times for a normal business day.

## Working in Day View

Day View shows an hourly calendar for a particular date. If there are events scheduled on that date, they appear in the appropriate time slot.





To view or select a date, do one of the following:

- Press the scroll buttons to move forward or backward one day at a time.

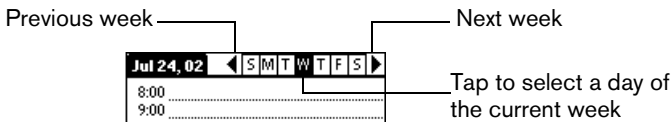
Note: If you plan to do a lot of scrolling in Date Book Plus while the lid is closed, consider enabling the Scroll before day move option in the Day Options dialog box. See page 98 for details.

- Press Shift  and then a scroll button to scroll by weeks.
- Tap the day of the week that you want in the date bar at the top of the screen. If necessary, tap the Previous week or Next week scroll arrows to move to another week.



- Press Menu  and under Options select Go to Day (/O). To scroll by days, press a scroll button. To scroll by months, hold Shift  and press a scroll button. To scroll by years hold Option  and press a scroll button. After you scroll to the date, press Space  to select it. You can also type the number of the day or tap the screen to select a date from the calendar.

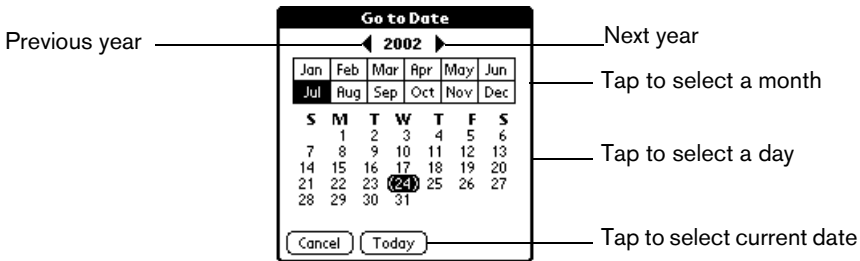

## Scheduling an event

A record in Date Book Plus is called an "event." An event can be any kind of activity that you associate with a day. You can enter a new event on any of the available time lines. When you schedule an event, its description appears on the time line, and its duration is automatically set to one hour. You can easily change the start time and duration for any event.

Note: It's possible to schedule events that overlap, but Date Book Plus makes it easy to find such conflicts. See page 93 for details.

You can also schedule events that occur on a particular date but have no specific start or end times, such as birthdays, holidays, and anniversaries. These are referred to as “untimed events.” Untimed events appear at the top of the list of times, marked with a diamond. You can have more than one untimed event on a particular date.

You can also schedule a repeating event, such as a weekly meeting, and continuous events, such as a three-day conference or a vacation.

**To schedule an event:**

1. Select the date on which you want to schedule the event as described in the previous section.
2. Type the time the event begins to open the Set Time dialog box. For example, type 4 for 4:00.

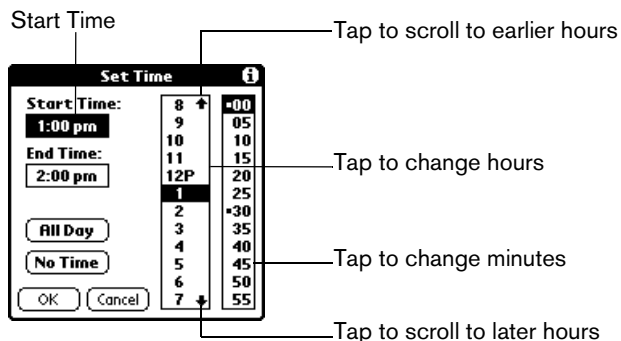

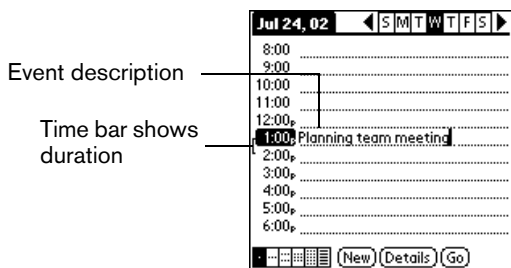

3. If the event is longer than an hour, press the bottom scroll button and type the end time.
4. Hold Option and press Return to finish.
5. Enter a description of the event. You can enter up to 255 characters.



6. Tap a blank area of the screen to deselect the event. A vertical line appears next to the time, indicating the duration of the event.

**To schedule an untimed event:**

1. Select the date on which you want to schedule the event. See page 82 for details.
2. Press Menu .
3. Under Record, select New Appointment (/N).

4. Hold Option  and press Return  so that no start or end times are defined for the new event.

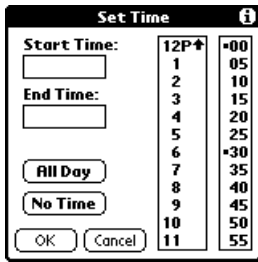

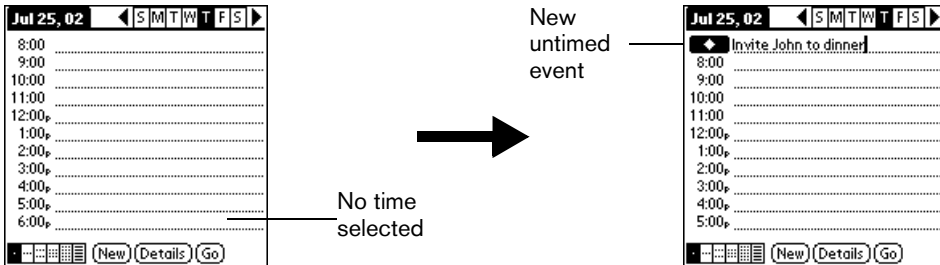

Tip: You can also create a new untimed event by making sure no event is selected and then entering a description.

5. Enter a description of the event.





6. Tap a blank area on the screen to deselect the untimed event.

Note: If you create an event and decide later that there is no particular start or end time, you can easily change it to an untimed event. Tap the time of the event in the Date Book Plus screen, tap No Time, and then hold Option  and press Return  to finish.

## Rescheduling an event

You can easily make changes to your schedule with your handheld.

To reschedule an event:

1. Tap the event you want to reschedule.
2. Tap Details.
3. To change the time, tap the Time box and select a new time.
4. To change the date, tap the Date box and select a new date.
5. Hold Option  and press Return  to finish.

## Setting an alarm for an event

The Alarm setting enables you to set an audible alarm for events in Date Book Plus. You can set an alarm to sound minutes, hours, or days before an event. The default Alarm setting is 5 minutes before the time of the event, but you can change this to any number of minutes, hours, or days.

When you set an alarm, this icon  appears to the far right of the event with the alarm. When the alarm tone sounds, a reminder message also appears onscreen.

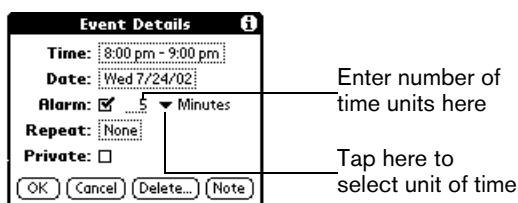

To set an alarm for an event:

1. Tap the event to which you want to assign an alarm.
2. Tap Details.
3. Tap the Alarm check box to select it.
4. Tap the pick list to select Minutes, Hours, or Days.
5. Select the 5 and enter any number from 0 to 99 (inclusive) as the number of time units.



6. Hold Option  and press Return  to finish.

Alarm for untimed events: You can set a silent alarm for an untimed event. In this case, the alarm triggers at the specified period of minutes, hours, or days before midnight (beginning) of the day of the untimed event. No audible alarm sounds for an untimed event; instead, the reminder message appears onscreen.

For example, you set an alarm for an untimed event that occurs on February 4th. If the alarm is set for 5 minutes, the reminder message appears at 11:55 PM on the night of February 3rd. The reminder remains onscreen until you turn on your handheld and hold Option  and press Return  to dismiss it.

To dismiss the alarm reminder, do one of the following:

- Tap OK to dismiss the alarm.
- Tap Snooze to be reminded again in 5 minutes.
- Tap Go To to clear the item from the reminder list and jump to that item.

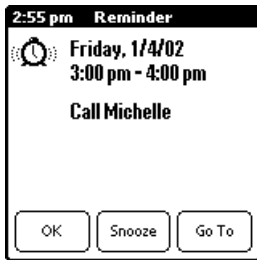

To dismiss a reminder for multiple alarms, do one of the following:

- Tap the check box next to an item to clear that item from the reminder list.
- Tap the item text or icon clear the item from the reminder list and jump to that item.
- Tap Done to close the reminder list without clearing the items. An indicator blinks in the upper-left corner of the screen. To return to the reminder list, tap the blinking indicator.
- Tap Snooze to be reminded again in 5 minutes. An indicator blinks in the upper-left corner of the screen. To return to the reminder list, tap the blinking indicator.
- Tap Clear All to dismiss all the alarms.

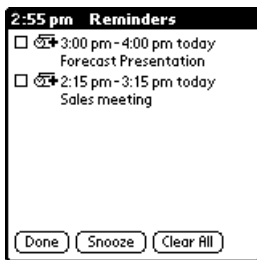

## Scheduling repeating or continuous events



The Repeat function lets you schedule events that recur at regular intervals or extend over a period of consecutive days. A birthday is a good example of an event that repeats annually. Another example is a weekly guitar lesson that falls on the same day of the week and the same time of day.

Typically, a continuous event is an untimed event such as a business trip or a vacation that continues for several days but doesn't occur at a particular time of day.

To schedule a repeating or continuous event:

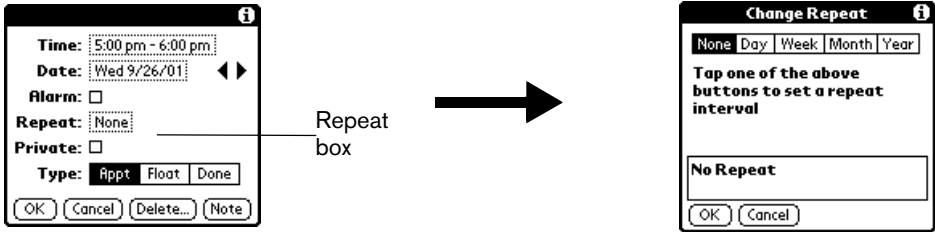
1. Tap the event.
2. Tap Details.
3. Tap the Repeat box to open the Change Repeat dialog box.





4. Tap Day, Week, Month, or Year to set how often the event repeats.  
 Tip: For a continuous event, tap Day.
5. Enter a number that corresponds to how often you want the event to repeat on the Every line.  
 For example, if you select Month and enter the number 2, the event repeats every other month.
6. To specify an end date for the repeating or continuous event, tap the End on pick list and tap Choose Date. Use the date picker to select an end date.
7. Hold Option  and press Return  to finish.

After you schedule a repeating or continuous event, this icon  appears to the far right of the event.

## Changing and deleting repeating or continuous events

If you change or delete a repeating or continuous event you can apply the action to only the current event, to all instances of the event, or to the current event and instances that follow.

To change or delete repeating events:

1. Select the record you want to change or delete.
2. Tap Details.
3. Enter the change.
4. Hold Option  and press Return  to accept the change, or tap Delete.
5. Tap one of the following:



Current. Changes or deletes only the current instance of the repeating event.

All. Changes or deletes all past, current, and future occurrences of this event.

Following. Changes or deletes the current event and all future occurrences of this event.

## Considerations for repeating or continuous events

Keep the following points in mind:

- If you change the start date of a repeating event, your handheld calculates the number of days you moved the event. Your handheld then automatically changes the end date to maintain the duration of the repeating event.
- If you change the repeat interval (e.g., daily to weekly) of a repeating event, past occurrences (prior to the day on which you change the setting) are not changed, and your handheld creates a new repeating event.
- If you change the date of an occurrence of a repeating event (e.g., from January 14th to January 15th) and apply the change to All occurrences, the new date becomes the start date of the repeating event. Your handheld adjusts the end date to maintain the duration of the event. If you apply the change to Current or Future occurrences, past occurrences (prior to the day on which you change the setting) are not changed.
- If you change other repeat settings (e.g., time, alarm, private) of a repeating event and apply the change to Future occurrences, your handheld creates a new event. The start date of this new event is the day on which the setting is changed. Past occurrences (prior to the day of the change) are not changed.
- If you apply a change to a single occurrence of a repeating event (e.g., time), that occurrence no longer shows the Repeat icon .

## Changing the Date Book Plus view

In addition to displaying the calendar for a specific day, you can also display a whole week in graph or text format, a month, a year, or a list of your appointments, as well as the current time.

To cycle through Day, Week, Week with Text, Month, Year, and List views:

- Repeatedly press Date Book Plus  to display the next view.

To display the current time:

1. Tap and hold the stylus on the date in the date bar to display the current time.



2. Drag the stylus below the date bar and then lift it.

Note: If you lift the stylus while it is still on the date bar, the menu bar appears.



## Working in Week View

Week View shows the calendar of your events for an entire week. This view lets you quickly review your appointments and available time slots. In addition, the graphical display helps you spot overlaps and conflicts in your schedule.

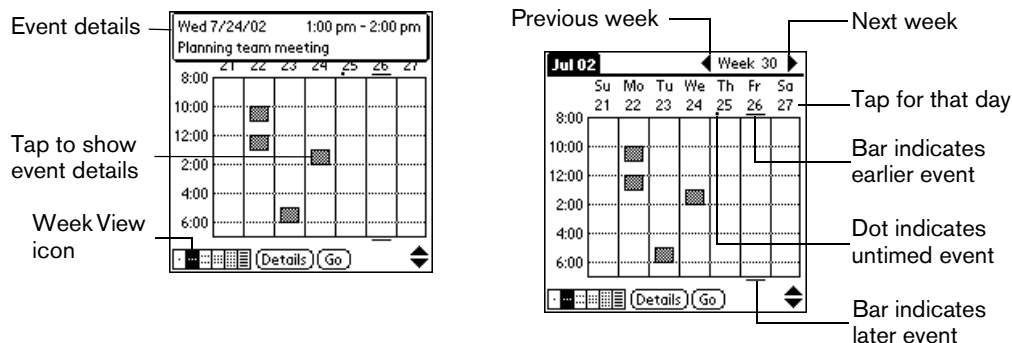

## Tips for using Week View

Keep the following points in mind:

- Tap an event to show details for the event.
- Press the scroll buttons to move forward or backward a week at a time.
- To reschedule an event, tap and drag the event to a different time or day.
- Tap a blank time on any day to move to that day and have the time selected for a new event.
- Tap any day or date that appears at the top of the Week View to move directly to that day without selecting an event.
- The Week View shows the time span defined by the Start Time and End Time in the Date Book Plus Preferences settings. If you have an event before or after this time span, a bar appears at the top or bottom of that day's column. Use the onscreen scroll arrows to scroll to the event.

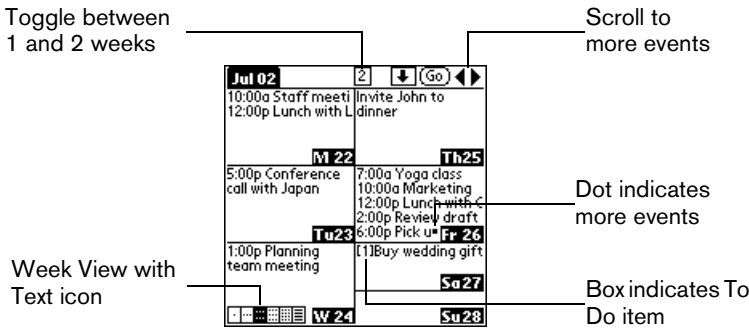

# Working in Week View with Text

The Week View with Text shows an entire week with a description of each scheduled event. This view can display one or two weeks at a time and can include To Do items that are due on the dates shown.



## Tips for using Week View with Text

Keep the following points in mind:

- Tap a day to display that day in the Day View.
- Press the scroll buttons to move between weeks. You can also tap the scroll arrows in the upper-right corner to move forward or backward a week.
- Press Menu , and under Options, select Go to Week (/O). Tap a number to select a different week.
- Tap Go to open the date selector use the scroll buttons to select a week and then hold Option  and press Return  to finish.
- Tap the number of weeks to toggle between a one week view and a two week view.

## Working in Month View

The Month View screen shows which days have events scheduled. Dots and lines in the Month View indicate events, repeating events, and untimed events.

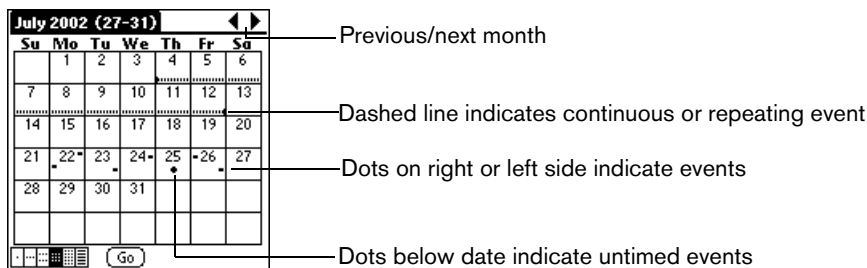

Month View icon

You can control the dots and lines that appear in the Month View. See page 96 for details.

## Tips for using Month View

Keep the following points in mind:

- Tap a day in the Month View to display that day in the Day View.
- Press the scroll buttons to move between months. You can also tap the scroll arrows in the upper-right corner to move forward or backward a month.
- Press Menu , and under Options, select Go to Month (/O) to open the date selector and select a different month.

## Working in Year View

The Year View shows an overview of your calendar for an entire year.

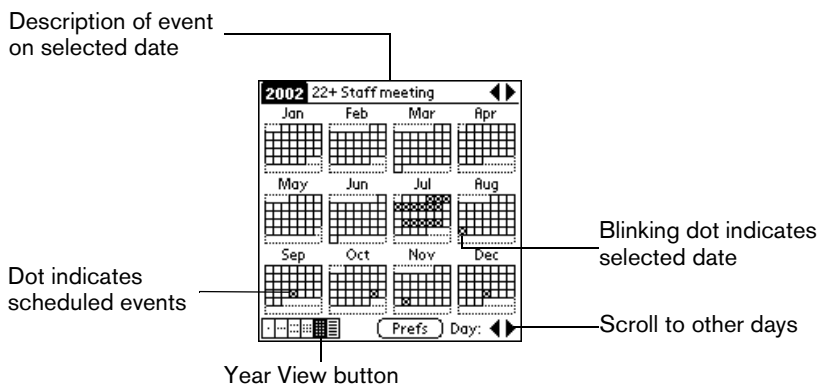

## Tips for using Year View

Keep the following points in mind:

- Tap a day to display the date and events for that day in the title bar. A minus sign indicates only one event is scheduled on that day. A plus sign indicates multiple events are scheduled on that day.
- Press the scroll buttons to move between days. You can also tap the scroll arrows in the lower-right corner to move forward or backward a day.
- Tap the scroll arrows in the upper-right corner to move forward or backward a year.
- Press Menu , and under Options select Year Preferences (/Y) to set display options.

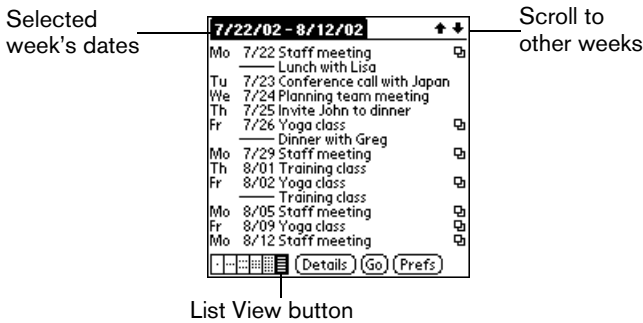

## Working in List View

The List View is a text oriented view that is integrated with To Do List. It displays a list of events and To Do items for the selected week(s).



## Tips for using List View

Keep the following points in mind:

- Tap a line to select it. The start and end time display briefly in the title bar. To redisplay the event details, tap to the left of the description.
- Tap the description of the selected line to display the event in Day View.
- Press the scroll buttons to select specific items on the screen. You can also tap the up scroll arrow in the upper-right corner to jump forward by one of the following: 1 Day, 1 Week, 1 Month, or Pick (a specific date). Then tap the scroll arrows to move forward or backward a week.
- Press Menu , and under Options, select Go to Date (/O) to open the date selector and select a different date.
- Press Menu , and under Options, select List View Preferences (/L) to set display options.

## Spotting event conflicts

With the ability to define specific start and end times for any event, it's possible to schedule events that overlap (an event that starts before a previous event finishes).

An event conflict (time overlap) appears in the Week View as overlapping bars. The Day View displays overlapping brackets to the left of the conflicting times.

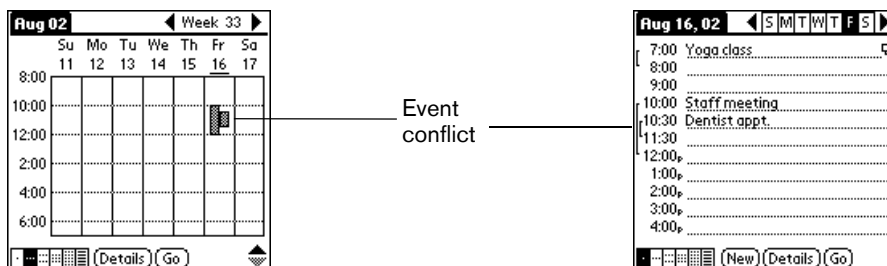

## Working with floating events

Date Book Plus can include events that are a combination of a To Do item and a Date Book event. These events are called “floating events.” Floating events are not assigned to a specific date, but can still be timed or untimed, can have alarms, and can repeat. If a floating event is not completed by midnight, it automatically advances to the next day until you mark it complete.

You can distinguish a floating event from an integrated To Do item by the circle that appears next to the floating event (in place of the To Do item priority number and check box). Floating events appear in alphabetical order at the top of the Day View screen between any integrated To Do items and untimed events.



### To create a floating event:

1. From the Day View, press Menu .
2. Under Record, select New Floating Event (/).
3. Enter a description of the event.
4. Tap a blank area on the screen to deselect the floating event.

### To mark a floating event complete:

- Tap the circle to the right or left of the event.

### Tips for using floating events:

- To prioritize floating events, enter a number followed by a space or dash as the first few characters of the description.
- To convert an existing event to a floating event, select the event, tap Details, tap Float as the Type, and then hold Option  and press Return  to finish.
- When you complete a repeating floating event, it marks only the current occurrence of the event as complete.

- Avoid scheduling a floating event that repeats daily. These events can accumulate quickly unless you complete them each day.
- When viewing a floating event in a desktop application, the Note field will contain a series of characters: ##f@@@@@ for an incomplete event and ##c@@@@@ for a complete event. Do not remove or edit these characters.

## Working with To Do items

Date Book Plus can create and display To Do items. To Do items appear in priority order at the top of the Day View screen.

### To create To Do items in Date Book Plus:

1. From the Day View, press Menu .
2. Under Record, select New To Do (/T).
3. Enter a description of the To Do item.
4. Tap a blank area on the screen to deselect the item.

### To mark a To Do item complete:

- Tap the check box next to the item.

### Tips for using To Do items:

- When you create a To Do item in Date Book Plus, the priority and category are based on the settings in the Create Options dialog box. See the section that begins on page 100 for details.
- If a To Do item does not appear in Date Book Plus, confirm that the category assigned to the item is selected. See the section that begins on page 100 for details.
- If you do not complete a To Do item on or before the due date, then an ! (exclamation mark) appears next to the item as a reminder that it is overdue.



## Using the Daily Journal

You can use the Daily Journal feature to record events as they occur. Events are recorded with automatic time-stamping as Date Book Plus Notes so they do not clutter your schedule. The Daily Journal is especially useful for tracking activities such as sales calls, start and end times for consulting or other work, or keeping a record of how you spend your time at the office.

### To create a Daily Journal entry:

1. From the Day View, press Menu .
2. Under Record, select New Journal Entry (/J).



Date Book Plus creates an untimed event, opens a Note for this event, and inserts the current time. If you've already started a journal for the current day, Date Book Plus opens the existing journal and inserts a new entry.

3. Enter a description for the journal entry.
4. Hold Option  and press Return  to finish.

## Using templates

You can use templates to create a list of standard events. You can then select an event from this list and add it to your calendar. Since Date Book Plus saves all the event attributes, including alarms and notes, templates can really save you time when entering reminder notices or events that recur on different days and times.

### To create a template:



1. Select the event you want to save as a template.
2. Press Menu .
3. Under Record, select tap Create Template (✓).
4. Hold Option  and press Return  to finish.

### To schedule a template event:

1. Select the date on which you want to schedule the event.
2. From the Day View, tap the time line that corresponds to the beginning of the event.
3. Tap New and select Template from the list.



Tap to create an event from a template

4. Select the event from the Appointment Templates list.
5. Hold Option  and press Return  to finish.

# Date Book Plus menus

Date Book Plus menus are shown here for your reference, and Date Book Plus features that are not explained elsewhere in this guide are described here.

See page 33 for information about choosing menu commands.

## Record menu

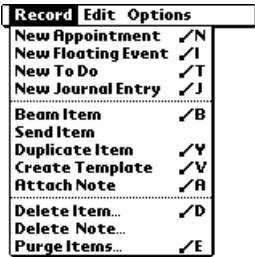

Day View



List View

### New To Do

Creates a new To Do item and adds it to your Date Book Plus and To Do List database.

### Send Item

Enables you to send the selected event to someone else via an SMS message. When you select this command, the Send dialog box opens where you can select or enter the recipient's mobile phone number. See page 208 for more information.

Note: This command appears only if you installed the Palm SMS application while configuring the Wireless Suite.

### Duplicate Item

Creates a copy of the selected event and opens the Details dialog box for the new event.

## Options menu

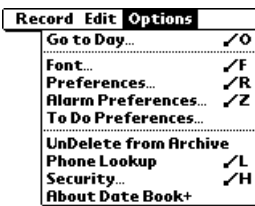

Day View

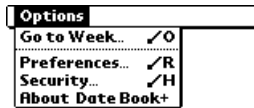

Week View

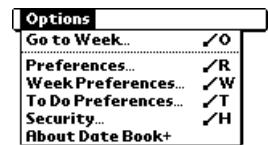

Week View with Text

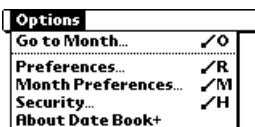

Month View

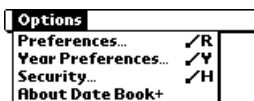

Year View

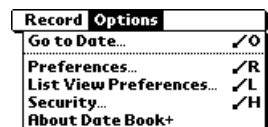

List View



## Preferences (Day View)

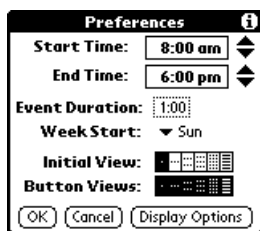

- Start/End Time. Defines the start and end times for Date Book Plus screens. If the time slots you select do not fit on one screen, you can tap the scroll arrows  to scroll up and down.
- Event Duration. Defines the default duration for new events.
- Week Start. Defines the first day of the week. This setting overrides the System Preferences setting for all Date Book Plus views.
- Initial View. Defines the view that appears when you start Date Book Plus.
- Button Views. Defines which views display when you repeatedly press the Date Book Plus button. By default, all views appear.
- Display Options. Opens the Display Options dialog box where you can define the following options:

## Display Options



- Show Time Bars. Activates the time bars that appear in the Day View. The time bars show the duration of an event and illustrate event conflicts
- Compress Day View. Controls how times appear in the Day View. When Compress Day View is off, all time slots display. When it is on, start and end times display for each event, but blank time slots toward the bottom of the screen disappear to minimize scrolling.
- Show PM Label. Displays a "p" after PM times.
- Show End Times. Displays all time bars and time slots for end times of an event.
- Scroll Before Day Move. Determines whether the front panel scroll buttons will scroll up and down within the current day before scrolling to the previous or next day.
- Auto-scroll Time. Displays events based on the time of day when the Day View contains more than one screen of information.
- Float Advance at Midnight. Advances floating events to the next day at midnight of the current day.
- Show Completed Floating Events. Displays completed floating events.

## Alarm Preferences

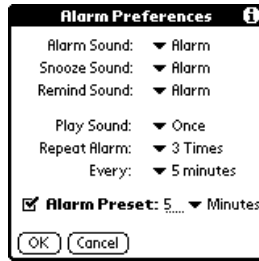

- Alarm Sound. Sets the tone of the alarm.
- Snooze Sound. Sets the tone of the snooze alarm.
- Remind Sound. Sets the tone of the reminder alarm. The reminder alarm sounds when the snooze alarm is not acknowledged.
- Play Sound. Defines how many tones the alarm emits before it stops. The choices are Once, Twice, 3 Times, 5 Times, and 10 Times.
- Repeat Alarm. Defines how many times the alarm repeats when it is not acknowledged. The choices are Once, Twice, 3 Times, 5 Times, 10 Times, and 100 Times.
- Every. Defines how often the alarm sound repeats. The choices are Minute, 5 minutes, 10 minutes, and 30 minutes.
- Alarm Preset. Automatically sets an alarm for each new event. The silent alarm for untimed events is defined by minutes, days, or hours before midnight of the date of the event.

## To Do Preferences

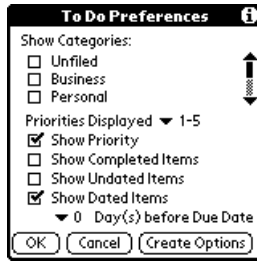

- Show Categories. Displays the To Do items in the categories you select.
- Priorities Displayed. Displays To Do items with the selected priority level. The choices are 1 only, 1-2, 1-3, 1-4, and 1-5.
- Show Priority. Displays the priority level for To Do items.
- Show Completed Items. Displays completed To Do items.
- Show Undated Items. Shows all To Do items that have not been assigned a due date.
- Show Dated Items. Shows all To Do items that have been assigned a due date.
- Days before Due Date. Defines the number of days before the due date that an item will appear in Day View as a To Do item.
- Create Options. Opens the Create Options dialog box where you can select the default priority and category for To Do Items you create in Date Book Plus.

## UnDelete from Archive

Restores the last event you deleted from Date Book Plus (provided it was stored in the Archive file). You can select this command repeatedly to restore additional events.

## Go to Week

Enables you to jump to a specific week by tapping the week number in the current year.

## Week Preferences

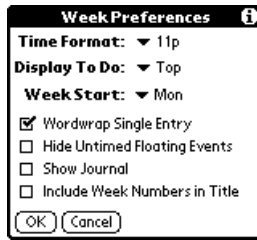

- Time Format. Defines the format of the time display. The choices are No Time, 11p, 11:30p, 23, 23:30.
- Display To Do. Defines where To Do items will appear on the Date Book Plus screen. The choices are Top, Bottom, and Hide.
- Week Start. Defines the first day of the week for Week View with Text.
- Wordwrap Single Entry. Wraps text in cells that contain a single event to display as much text as will fit in the cell.
- Hide Untimed Floating Events. Removes untimed floating events from the Week View with Text display.
- Show Journal. Displays a Daily Journal entry.
- Include Week Numbers in Title. Displays the selected week number in the title bar.

## Month Preferences



- Show Timed Events. Displays events that you assigned to a specific time.
- Show Untimed Events. Displays events that you assigned to a date, but did not assign to a specific time.
- Show Daily Repeating Events. Displays events that repeat each day.
- Include Week Numbers in Title. Displays week numbers in the title bar for the first and last weeks in the month.
- Show Zero Duration Events. Displays events that have no duration in the Month View display.

## Year Preferences



- Hide Floating and Done Items. Removes floating events and completed To Do items from the Year View display.
- Hide Untimed Events. Removes untimed events from the Year View display.
- Hide Zero Duration Events. Removes events without a duration from the Year View display.
- Hide Events <. Removes events that are shorter than the time you specify from the Year View display. The choices are 0.5, 1, 2, 4, 8, and 12.
- Hide Daily Repeating Events. Removes events that repeat daily from the Year View display.

## List View Preferences

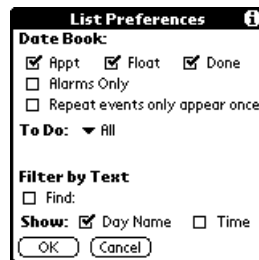

- Date Book. Determines which type of events appear in the List View display. The choices are: Appt, Float, Done, Alarms Only, and Repeat events only appear once.
- To Do. Determines which type of To Do items appear in the List View display. The choices are All, Not Complete, Complete, and None. If you choose either Not Complete or Complete, you also have the following choices: Dated & Undated, Dated only, and Undated only.
- Filter by Text. Displays events that contain the text you enter in this field and hides events that do not contain this text.
- Show. Determines the type of information that will appear for each event. The choices are Day Name and Time.

## About Date Book+

Shows version information for Date Book Plus.

# Contacts



Contacts is the application where you store name and address information about people or businesses and more.

## Creating a Contacts entry

You can create Contacts entries on your handheld, or you can use your desktop software to create entries on your computer and then download the entries to your handheld with your next HotSync operation.

Many desktop software applications also have data import capabilities that enable you to load database files into your Contacts list on your handheld. See the section that begins on page 34 and the online Help for your desktop software for more information.

To create a new Contacts entry:

1. Press Contacts .
2. Press Menu .
3. Under Record, select New Contact (N).

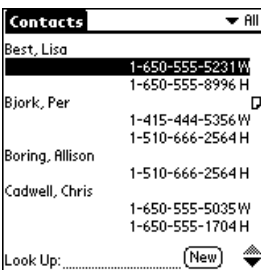

Cursor at  
Last name

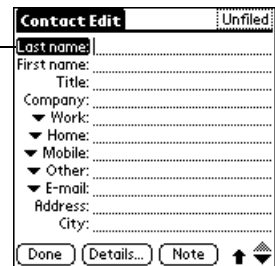

4. Enter the last name of the person you want to add to your Contacts list.
5. Press the bottom scroll button to move to the First Name field and then enter the person's first name.
6. Press the bottom scroll button to move to other fields and then enter the other information that you want to include in this entry.

Tip: Hold Shift  and use the scroll buttons to move between pages in this entry.

7. After you finish entering information, hold Option  and press Return  to finish.





**Tip:** To create an entry that always appears at the top of the Contacts list, begin the Last name or Company field with a symbol, as in \*If Found Call\*. This entry can contain contact information in case you lose your handheld.

## Duplicating a Contacts entry

You can duplicate existing entries, which can be helpful when you want to enter multiple people from a single organization. When you duplicate an entry, the word *Copy* appears next to the name in the First Name field.



To duplicate an entry:

1. From the Contacts list, select the name you want to duplicate.
2. Press Menu .
3. Under Record, select Duplicate Contact (/T).
4. Edit the entry as necessary.
5. Hold Option  and press Return  to finish.



## Selecting types of phone numbers

You can select the types of phone numbers or e-mail addresses that you associate with a Contacts entry. Any changes you make apply only to the current entry.

To select other types of phone numbers in an entry:

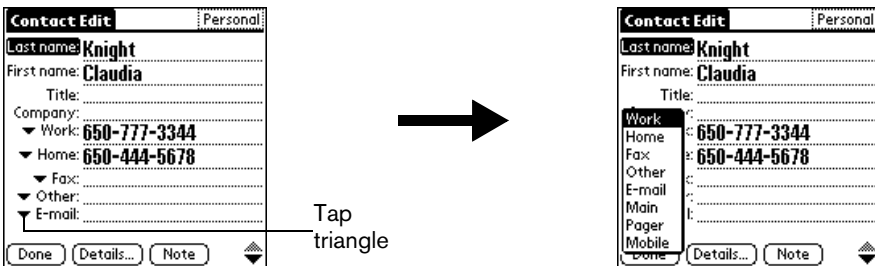
1. Select the contact name for the entry that you want to change.
2. Press Space  to open the entry.
3. Press Menu .
4. Under Record, select Edit Contact (/E).
5. Tap the pick list next to the label you want to change.





6. Select a new label.
7. Hold Option  and press Return  to finish.



## Changing Contact entry details

The Contact Entry Details dialog box provides a variety of options that you can associate with an entry.

To open the Contact Entry Details dialog box:

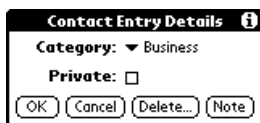

1. Select the name for the entry whose details you want to change.
2. Press Space  to open the entry.
3. Press Menu .
4. Under Record, select Edit Contact (/E).
5. Press Menu .
6. Under Record, select Details (/E).



7. Select any of the following settings:

**Category** Assign the entry to a category.

**Private** Hide this entry when Security is turned on.

8. Hold Option  and press Return  to finish.

## Dialing a number in your Contacts list

You can dial any number that you've entered in your Contacts list.

Note: To use the Dial command you must first install the Palm SMS application and the appropriate phone driver from the Handspring CD-ROM.

To dial a number in your Contacts list:

1. From the Contacts list, use the Instant Lookup feature to select the number you want to call. See the section that begins on page 68 for details.
2. Press Menu .
3. Under Record, select Dial.

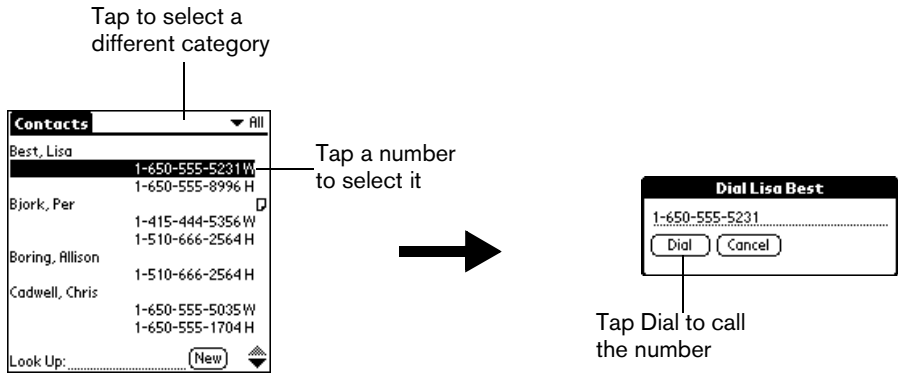

4. Prepare your handheld and mobile phone for data communications. See page 194 for details.
5. Tap Dial.

Tip: If you select the Enable Tap-Dialing check box in the Contacts Preference dialog box, you can simply tap the number you want to dial without using the Dial menu command.

## Contacts menus

Contacts menus are shown here for your reference, and Contacts features that are not explained elsewhere in this guide are described here.

See page 29 for information about choosing menu commands.

The Record and Options menu differ depending on which screen is displayed.

## Record menus

Record	Edit	Options
Open Contact	✓/O	
New Contact	✓/N	
Duplicate Contact	✓/T	
Dial...		
Beam Contact	✓/B	
Beam Category	✓/Y	
Beam Business Card	✓/M	

Contacts list view

Record	Options
Edit Contact...	✓/E
New Contact...	✓/N
Delete Contact...	✓/D
Duplicate Contact	✓/T
Beam Contact	✓/B
Send Contact	
Dial...	
Attach Note	✓/A
Delete Note...	✓/O
Select Business Card...	
Beam Business Card	✓/M

Contacts record view

Record	Edit	Options
Details...		✓/E
Delete Contact...	✓/D	
Duplicate Contact	✓/T	
Beam Contact	✓/B	
Attach Note	✓/A	
Delete Note...	✓/O	
Select Business Card...		
Beam Business Card	✓/M	

Contacts edit view

## Send Contact

Enables you to send the selected record to someone else via an SMS message. When you select this command, the Send dialog box opens where you can select or enter the recipient's mobile phone number. See page 208 for more information.

Note: This command appears only if you installed the Palm SMS application and a phone driver from the Handspring CD-ROM.

## Options menus



Contacts list view



Contacts record & edit views

## Preferences



- Remember last category. Determines how the Contacts list appears when you return to it from another application. If you select this check box, the Contacts list shows the last category you selected. If you clear it, the Contacts list displays the All category.
- List By. Determines how the Contact entries are sorted and also controls the Instant Lookup feature and SMS address lookup options.
- Enable Tap-Dialing. Toggles the tap-dialing feature on and off. When enabled, you can dial a phone number from the Contacts list simply by tapping it. You do not need to select the Dial command from the menu.

## Dial Preferences

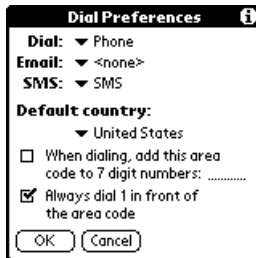

- Dial, Email, SMS. Provides third-party applications access to the Contacts application's dialing functions. In most cases you do not need to change these settings.

- Default country. Determines if North American hyphenation conventions are automatically applied to phone numbers, and whether the following two options are available:
  - When dialing, add this area code to 7 digit numbers. Inserts the area code you specify in front of 7-digit numbers before dialing.
  - Always dial 1 in front of the area code. Inserts a 1 in front of 10-digit numbers before dialing.

If you select a country other than United States or Canada, numbers are formatted exactly as they appear in the Contact record.

## Rename Custom Fields



These custom fields appear at the end of the Contact Edit screen. Rename them to identify the kind of information you enter in them. The names you give the custom fields appear in all Contacts records.

## About Contacts

Shows version information for Contacts.

# To Do List

To Do reminds you of tasks you have to complete. A record in To Do List is called an “item.”

To create a To Do item:

1. Press To Do List .
2. Enter the text of the To Do item. The text can be longer than one line.

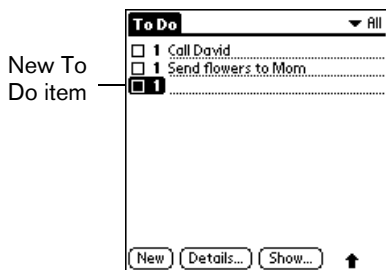

3. Press a scroll button to deselect the To Do item.

## Setting priority

The priority setting for items lets you arrange your To Do items according to their importance or urgency. The default setting is to arrange To Do items by priority and due date, with priority 1 items at the top. If you have a number of items in your list, changing an item's priority setting may move its position in the list.

Note: When you create a new To Do item, its priority is automatically set to level 1, the highest (most important) level. If you select another item first, however, the item you create appears beneath the selected item and is given the same priority as the selected item.

To set the priority of a To Do item:

1. Tap the Priority number on the left side of the To Do item.

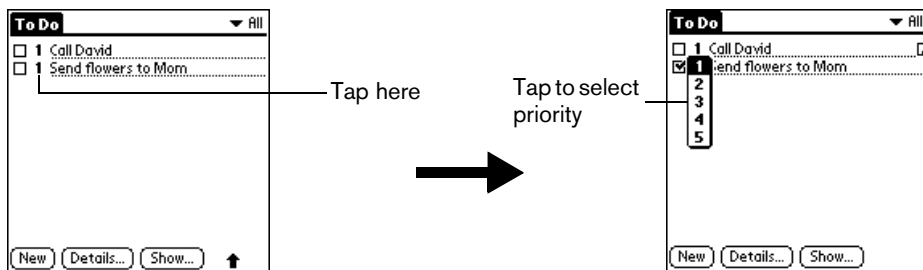

2. Tap the Priority number that you want to set (1 is most important).

## Setting a due date

You can associate a due date with any To Do item. You can also sort the items that appear in the list based on their due date.

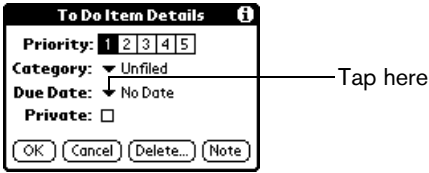

To set a due date for a To Do item:

1. Tap the text of the item whose details you want to change.
2. Tap Details.
3. Tap the Due Date pick list.



4. Tap the date that you want to assign the item:

<b>Today</b>	Assigns the current date.
<b>Tomorrow</b>	Assigns tomorrow's date.
<b>One week later</b>	Assigns the date exactly one week from the current date.
<b>No Date</b>	Removes the due date from the item.
<b>Choose date</b>	Opens the date selector, where you can choose any date that you want for the item.

5. Hold Option  and press Return  to finish.

Tip: If you turn on the Show Due Dates option in the To Do Show options dialog, you can tap directly on the due date in the To Do list to open the pick list shown in step 4.

## Assigning a category



You can associate any To Do item with a category. You can also sort the items that appear in the list based on their category.

To assign a category for a To Do item:

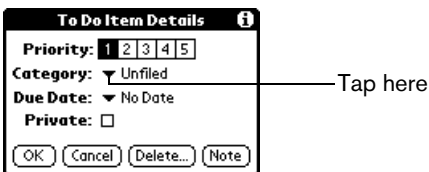
1. Tap the text of the item whose details you want to change.
2. Tap Details.
3. Tap the category pick list.



4. Tap the category that you want to assign the item.

5. Hold Option  and press Return  to finish.

Tip: If you turn on the Show Categories option in the To Do Show options dialog, you can tap directly on the category in the To Do list to assign categories.



## Checking off a To Do item

You can check off a To Do item to indicate that you've completed it. You can set To Do List to record the date that you completed the To Do item, and you can choose to show or hide completed items as described on page 111.

To check off a To Do item do one of the following:

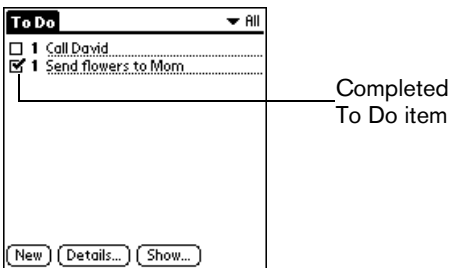
- Select the item and press Space  to mark it complete.
- Tap the check box on the left side of the item.



Tip: To uncheck the selected item, hold Option  and press Space .

## To Do Show Options

The Show Options dialog box enables you to control the appearance of the To Do list screen.



To change the Show Options settings:

1. In To Do list screen, tap Show.



2. Select any of the following settings:

- Show Completed Items** Displays your completed items in the To Do list screen. If you turn off this setting, your To Do items disappear from the list when you complete (check) them.  
  
Items that no longer appear on the list because you turn off this setting have not been deleted. They are still in the memory of your handheld. Purge completed items to remove them from memory.
- Show Only Due Items** Shows only the items that are currently due, past due, or have no due date specified. When this setting is active, items that are not yet due do not appear in the list until their due date.
- Record Completion Date** Replaces the due date with the actual date when you complete (check) the item. If you do not assign a due date to an item, the completion date still records when you complete the item.
- Show Due Dates** Displays the due dates associated with To Do items and displays an exclamation mark next to items that remain incomplete after the due date passes.
- Show Priorities** Shows the priority setting for each item.
- Show Categories** Shows the category for each item.

3. Hold Option  and press Return  to finish.

## To Do List menus

To Do List menus are shown here for your reference, and To Do List features that are not explained elsewhere in this guide are described here. See page 33 for information about choosing menu commands.

### Record menu

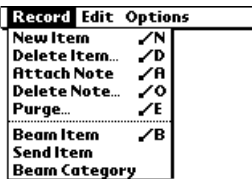

**Send Item** Enables you to send the selected To Do item to someone else via an SMS message. When you select this command, the Send dialog box opens where you can select or enter the recipient's mobile phone number. See page 208 for more information.

Note: This command appears only if you installed the Palm SMS application and a phone driver from the Handspring CD-ROM.



## Options menu





**About To Do List** Shows version information for To Do List.

# Memo Pad



A memo can contain up to 4,000 characters. The number of memos you can store is dependent only on the memory available on your handheld. A record in Memo Pad is called a "memo."

To create a new memo:

1. Press Memo Pad .
2. Enter the text you want to appear in the memo. Press Return  to move down to new lines in the memo.

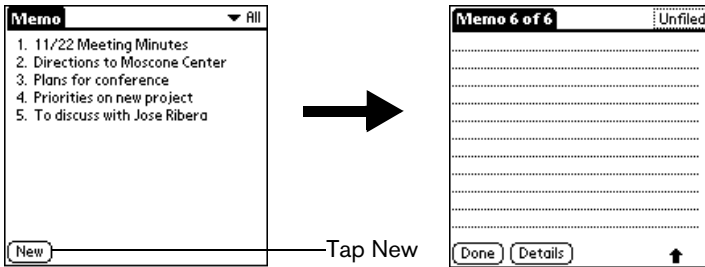
Tip: The first letter of your memo is automatically capitalized.



3. Hold Option  and press Return  to finish.

## Reviewing memos



The first line of a memo appears in the Memo list. This makes it easy to locate and review your memos.

To review a memo:

1. In the Memo list, press the scroll buttons to select the memo you want to view.
2. Press Space  to open the selected memo.

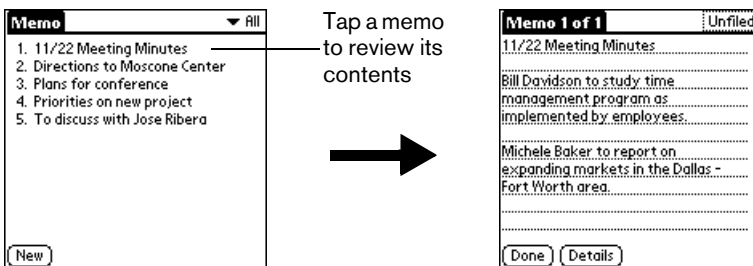
Tip: You can also tap the text of the memo you want to view in the Memo list.



3. Review or edit the text in the memo.
4. Hold Option  and press Return  to finish.

## Memo Pad menus

Memo Pad menus are shown here for your reference, and Memo Pad features that are not explained elsewhere in this guide are described here. See page 33 for information about choosing menu commands.

The Record and Options menus differ depending on whether you're displaying the Memo list or an individual memo.

### Record menus

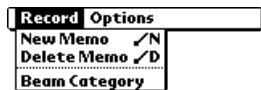

Memo list

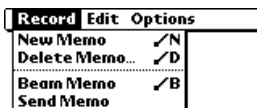

Memo screen

#### Send Memo

Enables you to send the selected record to someone else via an SMS message. When you select this command, the Send dialog box opens where you can select or enter the recipient's mobile phone number. See page 208 for more information.

Note: This command appears only if you installed the Palm SMS application and a phone driver from the Handspring CD-ROM.

### Options menus



Memo list



Memo screen

#### Preferences

Displays the Memo Preferences dialog box, where you define the sort order for memos.

#### About Memo Pad

Shows version information for Memo Pad.

# CityTime



CityTime enables you to display the day and time in your home city and in four other cities around the globe. Whether you're travelling or at home, now it's easy to keep track of the best time to reach your business associates, friends, and family in far away places.

Note: CityTime does not automatically update the current time for Daylight Savings Time.

## Setting your home city

The home city serves as a point of reference for your other city selections. The information displayed for all the other cities is based on the day and time in your home city. When you use CityTime for the first time (or when you travel or move to another city), make sure you set your home city location. Setting your home city location ensures that CityTime displays accurate information for the other cities you select.

To set your home city:

1. Press Option  and then press To Do List .



Tip: You can also access CityTime by tapping the CityTime icon  in the Applications Launcher.

2. Press Menu .

3. Under Options, select Select Home City (/H).

4. Tap the Home City pick list and select the city closest to where you are located.

Tip: If a nearby city isn't in the list, you can use the Edit Cities command to add a new city to the list. See page 117 for details.

5. Hold Option  and press Return  to finish.

## Selecting remote cities

In addition to your home city, you can display the day and time for four other cities anywhere around the globe. These other cities are called remote cities.

To set your remote cities:

1. Tap a pick list in the lower part of the CityTime screen and select the city closest to the city you want to display.

Tap to select  
a remote city



Tip: If a nearby city isn't in the list, you can use the Edit Cities command to add a new city to the list. See the next section for details.



2. Tap the remaining pick lists and select the other three cities you want to display.

Tip: You can temporarily display the day and time for any other city by tapping the city's location on the map display.

## Adding cities

If the city you want to display is not in the predefined list, you can use the Edit Cities command to add it.

To add a city to the list:

1. Press Menu .
2. Under Options, select Edit Cities (/E).
3. Tap New.
4. Enter the city name and other information.
5. Hold Option  and press Return  to finish.

## CityTime menus

CityTime menus are shown here for your reference, and CityTime features that are not explained elsewhere in this guide are described here. See page 33 for information about choosing menu commands.

### Options menu

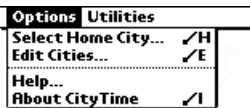

**About CityTime** Shows version information for CityTime.

**Help** Displays online help for the CityTime screens.

### Utilities menu



**Change Location** Opens the Change Location dialog box where you can select the city to which you are moving or travelling. Changing the location updates the system time, date, and daylight savings settings.

**Sun Rise/Set** Opens the Sun Rise/Set dialog box where you can view sunrise and sunset information for your home city. To view this information for another city, tap the City pick list and select the city from the list. To view this information for another date, tap the scroll arrows next to the date box.



# Calculator

Calculator includes two operating modes: Basic and Advanced. In Basic mode you can perform simple mathematical calculations. Basic mode uses input precedence, like most 4-function calculators, and the order of the numbers entered results in an answer regardless of operation. In Advanced mode you can access scientific functions and perform sophisticated math calculations. The Advanced mode uses algebraic precedence, like most scientific calculators, and the results differ depending on the rules associated with the algebraic equation. This section explains how to select the operating mode and use the buttons and menu options available in each mode.

## Selecting the Calculator mode

The Toggle Mode command enables you to choose whether you want to work in Basic Calculator mode or Advanced Calculator mode. You can change modes at any time.



To select the Calculator mode:

1. Press Option  and then press Memo Pad .

Tip: You can also access Calculator by tapping the Calculator icon  in the Applications Launcher.

2. Press Menu .

3. Under Options, select Toggle Mode (/M).

Tip: You can also toggle between Basic and Advanced mode by holding Option  and repeatedly press Memo Pad .

## Using the Basic Calculator buttons

The Basic Calculator includes the following buttons.



Clears the last number you entered. Use this button if you make a mistake while entering a number in the middle of a calculation. This button enables you to re-enter the number without starting the calculation over.



Clears the entire calculation and enables you to begin a fresh calculation.



Toggles the current number between a negative and positive value. If you want to enter a negative number, enter the number first *and then press* the +/- button.



Places the current number in memory. Each new number you enter with the M+ button is *added to the total* already stored in memory. You can add either a calculated value or a number you enter by pressing the number buttons. Pressing this button has no effect on the current calculation (or series of calculations); it merely places the value into memory until it is recalled.



Recalls the stored value from memory and inserts it in the current calculation.



Clears any value that is stored in the Calculator memory.



# Displaying Recent Calculations

The Basic Calculator's Recent Calculations command enables you to review the last series of calculations and is particularly useful for confirming a series of "chain" calculations.

To display recent calculations:

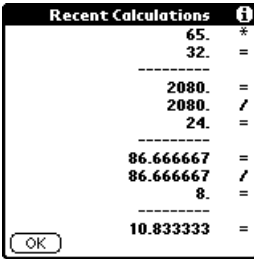
1. Press Menu .
2. Under Options, select Recent Calculations (/I).



3. After you finish reviewing the calculations, hold Option  and press Return  to finish.

# Using the Advanced Calculator mode



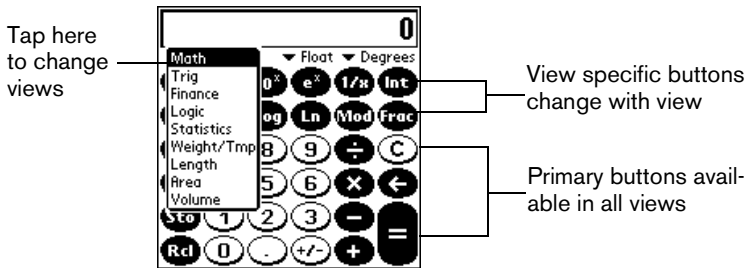



The Advanced Calculator screen consists of three regions. Each region performs a different function to help you perform a variety of calculations.















# Using the Advanced Calculator buttons

In addition to most of the Basic Calculator buttons, the Primary buttons are available in all the Advanced Calculator views. The remaining buttons are available only in specific views. The information that follows provides an overview of the Advanced Calculator functions. For more detailed information and instructions, visit the website: [www.radiks.net/~rhuebner/parendoc.html](http://www.radiks.net/~rhuebner/parendoc.html)

## Primary buttons













-  Clears the entire calculation and enables you to begin a fresh calculation.
-  Clears the last digit you entered. Use this button if you make a mistake while entering a number in the middle of a calculation. This button enables you to re-enter the number without starting the calculation over.
-  Enters an exponent symbol in the calculation.
-  Opens the Constants dialog box where you can select a constant to include in the calculation.
-  Opens the Store in which memory dialog box where you can select the memory bank in which you want to store the current value. Advanced Calculator has ten memory banks.
-  Opens the Recall which memory dialog box where you can select the memory bank from which you want to recall a value.

## Math buttons

-  Squares the current value.
-  Calculates the value of  $x$  raised to the  $y$  power.
-  Calculates the value of a common (base 10) antilogarithm.
-  Calculates the value of a natural (base e) antilogarithm.
-  Calculates the reciprocal of the current number.
-  Displays the integer portion of a decimal value.
-  Calculates the square root of the current number.
-  Calculates the inverse of  $x$  to the  $y$  power.
-  Calculates the common (base 10) logarithm.
-  Calculates the natural (base e) logarithm.
-  Displays the remainder of  $x/y$ .
-  Displays the decimal portion of a decimal value.



## Trigonometry buttons

-  Calculates the sine of the current number.
-  Calculates the cosine of the current number.
-  Calculates the tangent of the current number.
-  Calculates the hyperbolic sine of the current number.
-  Calculates the hyperbolic cosine of the current number.
-  Calculates the hyperbolic tangent of the current number.
-  Calculates the arc (inverse) sine of the current number.
-  Calculates the arc (inverse) cosine of the current number.
-  Calculates the arc (inverse) tangent of the current number.
-  Calculates the arc (inverse) hyperbolic sine of the current number.
-  Calculates the arc (inverse) hyperbolic cosine of the current number.
-  Calculates the arc (inverse) hyperbolic tangent of the current number.

## Finance buttons

Finance buttons enable you to find an unknown variable value based on a group of known variable values. For example, to calculate the monthly payment for a 30-year home loan of \$100,000 with an annual interest rate of 8%, you would enter the following variables:

- Payments/year = 12
- $N = 360$  (30 years x 12 months)
- APR = 8
- PV = 100,000
- FV = 0



Using these variables, the answer would be -733.76 per month.

To solve this example:

1. Enter a value and then tap the corresponding variable button. Repeat this process until you've entered the following four variables:
  - $N = 360$  (30 years x 12 months)
  - APR = 8

■  $PV = 100,000$

■  $FV = 0$

2. Enter 12 and tap the P/Yr button to enter the number of payments per year.
3. Tap Edit.
4. Tap the Pmt line and erase all values on the line including zero.
5. Tap Solve.
6. Hold Option  and press Return  to finish.

You can use a similar process to solve other financial equations by entering four of the variables to find the value of the fifth variable.



Stores the current number as the total number of payments over the life of the loan.



Stores the current number as the annual percentage rate of interest.



Stores the current number as the number of payments per year.



Stores the current number as the initial loan amount.



Stores the current number as the payment amount.



Stores the current number as the compounded loan amount including interest.



Opens the Time Value of Money dialog box where you can modify values and solve the equation.



Stores the remaining balance, interest, and principal (amortization) based on the supplied values.



Calculates a given percentage of a value. To use this button, enter a value, tap this button, enter the percent, and then tap the equal sign button.



Calculates the change in a value by a given percentage. To use this button, enter a value, tap this button, enter the percent, and then tap the equal sign button.















Calculates the percentage of one number relative to another number. To use this button, enter the first number, tap this button, enter the second number, and then tap the equal sign button.















Calculates the percentage required to get to one value from another value. To use this button, enter the result number, tap this button, enter the starting number, and then tap the equal sign button.

## Logic buttons











-  Shifts the value to the left and fills the new places with zeros.
-  Enters D in a hexadecimal calculation.
-  Enters E in a hexadecimal calculation.
-  Enters F in a hexadecimal calculation.
-  Calculates bit-by-bit commonalities between two arguments.
-  Calculates bit-by-bit unique occurrences in two arguments.
-  Shifts the sign bit to the right in signed mode.
-  Enters A in a hexadecimal calculation.
-  Enters B in a hexadecimal calculation.
-  Enters C in a hexadecimal calculation.
-  Calculates the inverse of each bit of the argument.
-  Calculates the exclusive OR between two arguments.

## Statistics buttons





-  Adds the current value to the end of the statistics memory list. You can store up to 200 values.
-  Calculates the mean of the values in the statistics memory list.
-  Calculates the standard deviation based on a population of  $n$ .
-  Calculates the standard deviation based on a population of  $n-1$ .
-  Calculates the sum of the values in the statistics memory list.
-  Calculates the square of the sum of the values in the statistics memory list.
-  Opens the Statistical Data dialog box where you can view, edit, delete, and clear values in the statistics memory list.
-  Displays the number of values in the statistics memory list.
-  Calculates the factorial of any integral from 0 to 170.

-  Generates a random number between 0 and 32767 and then divides this number by 32768 to generate a random fraction between 0 and .99997.
-  Returns the number of combinations of  $n$  items taken  $m$  at a time.
-  Returns the number of permutations of  $n$  items taken  $m$  at a time.

## Weight/Temp buttons

-  Indicates the current value is entered in ounces. When you tap this button after tapping another unit of measure, it converts the value to ounces.
-  Indicates the current value is entered in pounds. When you tap this button after tapping another unit of measure, it converts the value to pounds.
-  Indicates the current value is entered in US tons. When you tap this button after tapping another unit of measure, it converts the value to US tons.
-  Indicates the current value is entered in UK tons. When you tap this button after tapping another unit of measure, it converts the value to UK tons.
-  Indicates the current value is entered in milligrams. When you tap this button after tapping another unit of measure, it converts the value to milligrams.
-  Indicates the current value is entered in grams. When you tap this button after tapping another unit of measure, it converts the value to grams.
-  Indicates the current value is entered in kilograms. When you tap this button after tapping another unit of measure, it converts the value to kilograms.
-  Indicates the current value is entered in metric tons. When you tap this button after tapping another unit of measure, it converts the value to metric tons.
-  Indicates the current value is entered in degrees Fahrenheit. When you tap this button after tapping another unit of measure, it converts the value to degrees Fahrenheit.
-  Indicates the current value is entered in degrees Kelvin. When you tap this button after tapping another unit of measure, it converts the value to degrees Kelvin.
-  Indicates the current value is entered in degrees Celsius. When you tap this button after tapping another unit of measure, it converts the value to degrees Celsius.

## Length buttons

-  Indicates the current value is entered in inches. When you tap this button after tapping another unit of measure, it converts the value to inches.
-  Indicates the current value is entered in feet. When you tap this button after tapping another unit of measure, it converts the value to feet.
-  Indicates the current value is entered in yards. When you tap this button after tapping another unit of measure, it converts the value to yards.
-  Indicates the current value is entered in miles. When you tap this button after tapping another unit of measure, it converts the value to miles.



Indicates the current value is entered in nautical miles. When you tap this button after tapping another unit of measure, it converts the value to nautical miles.



Indicates the current value is entered in millimeters. When you tap this button after tapping another unit of measure, it converts the value to millimeters.



Indicates the current value is entered in centimeters. When you tap this button after tapping another unit of measure, it converts the value to centimeters.



Indicates the current value is entered in meters. When you tap this button after tapping another unit of measure, it converts the value to meters.



Indicates the current value is entered in kilometers. When you tap this button after tapping another unit of measure, it converts the value to kilometers.

## Area buttons



Indicates the current value is entered in square inches. When you tap this button after tapping another unit of measure, it converts the value to square inches.



Indicates the current value is entered in square feet. When you tap this button after tapping another unit of measure, it converts the value to square feet.



Indicates the current value is entered in square yards. When you tap this button after tapping another unit of measure, it converts the value to square yards.



Indicates the current value is entered in acres. When you tap this button after tapping another unit of measure, it converts the value to acres.



Indicates the current value is entered in square miles. When you tap this button after tapping another unit of measure, it converts the value to square miles.



Indicates the current value is entered in square millimeters. When you tap this button after tapping another unit of measure, it converts the value to square millimeters.



Indicates the current value is entered in square centimeters. When you tap this button after tapping another unit of measure, it converts the value to square centimeters.



Indicates the current value is entered in square meters. When you tap this button after tapping another unit of measure, it converts the value to square meters.



Indicates the current value is entered in hectares. When you tap this button after tapping another unit of measure, it converts the value to hectares.



Indicates the current value is entered in square kilometers. When you tap this button after tapping another unit of measure, it converts the value to square kilometers.

## Volume buttons



Indicates the current value is entered in teaspoons. When you tap this button after tapping another unit of measure, it converts the value to teaspoons.



Indicates the current value is entered in fluid ounces. When you tap this button after tapping another unit of measure, it converts the value to fluid ounces.



Indicates the current value is entered in cups. When you tap this button after tapping another unit of measure, it converts the value to cups.



Indicates the current value is entered in pints. When you tap this button after tapping another unit of measure, it converts the value to pints.



Indicates the current value is entered in quarts. When you tap this button after tapping another unit of measure, it converts the value to quarts.



Indicates the current value is entered in gallons. When you tap this button after tapping another unit of measure, it converts the value to gallons.



Indicates the current value is entered in tablespoons. When you tap this button after tapping another unit of measure, it converts the value to tablespoons.



Indicates the current value is entered in milliliters. When you tap this button after tapping another unit of measure, it converts the value to milliliters.



Indicates the current value is entered in liters. When you tap this button after tapping another unit of measure, it converts the value to liters.



Indicates the current value is entered in cubic inches. When you tap this button after tapping another unit of measure, it converts the value to cubic inches.



Indicates the current value is entered in cubic feet. When you tap this button after tapping another unit of measure, it converts the value to cubic feet.











Indicates the current value is entered in cubic meters. When you tap this button after tapping another unit of measure, it converts the value to cubic meters.

## Creating a custom view

You can modify any existing Advanced Calculator view to create your own view. While customizing a view, you can change the button names as well as the button definitions.

To create a custom view:

1. From the Advanced Calculator screen, press Menu .
2. Under Program, select Export (/E).
3. Tap the pick list and select the view you want to modify.
4. Tap Export.
5. Hold Option  and press Return  twice.
6. In Memo Pad, open the memo containing the definition you selected in step 3.
7. Modify the definition, and then hold Option  and press Return .

8. From the Advanced Calculator screen, press Menu .
9. Under Program, select Import (/I).
10. Tap the pick list and select the view you modified.
11. Tap Import.
12. Tap Replace to change an existing definition, or tap Add to create an additional definition.
13. Hold Option  and press Return  twice to finish.

## Calculator menus

Calculator menus are shown here for your reference, and Calculator features that are not explained elsewhere in this guide are described here. See page 33 for information about choosing menu commands.

### Options menus

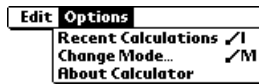

Basic Calculator



Advanced Calculator

**About Calculator** Shows version information for Calculator.

### Program menu



Advanced Calculator

**Export** Opens the Export dialog box where you can select a view definition to export to Memo Pad.

**Import** Opens the Import dialog box where you can select a view definition to import to Memo Pad.



**Delete View** Opens the Delete View dialog box where you can delete a user-defined view.

**Restore Defaults** Returns all the view definitions to the preset default values.

# Expense

Expense enables you to record the date, expense type, and the amount that you spent. A record in Expense is called an "item." You can sort your Expense items into categories or add other information that you want to associate with the item.

To create an Expense item:

1. Press Option  and then press Menu  to access the Applications Launcher.
2. Tap the Expense icon .
3. Enter the amount of the expense.

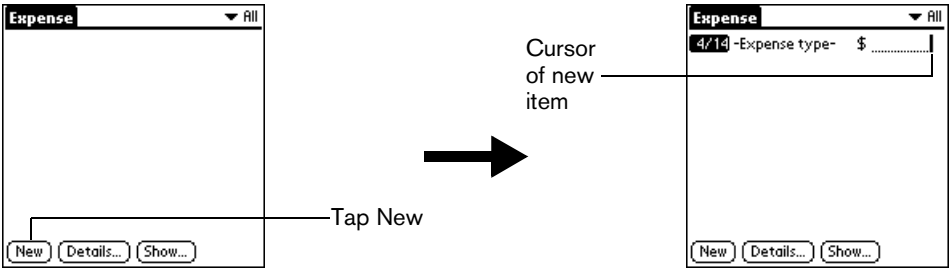

4. Tap the Expense type pick list and select a type from the list.

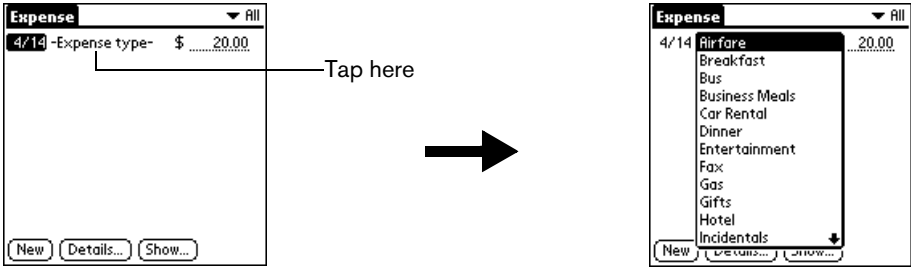

Note: As soon as you select an expense type, your handheld saves the entry. If you don't select an expense type, it doesn't save the entry.

Tip: A quick way to create a new Expense item is to make sure that no Expense item is selected in the Expense list, enter the first letter(s) of the expense type, and then enter the numerical amount. This technique takes advantage of the automatic fill feature. See the section that begins on page 134 for details.

## Changing the date of an Expense item



Initially, Expense items appear with the date you enter them. You can use Expense to change the date associated with any Expense item.

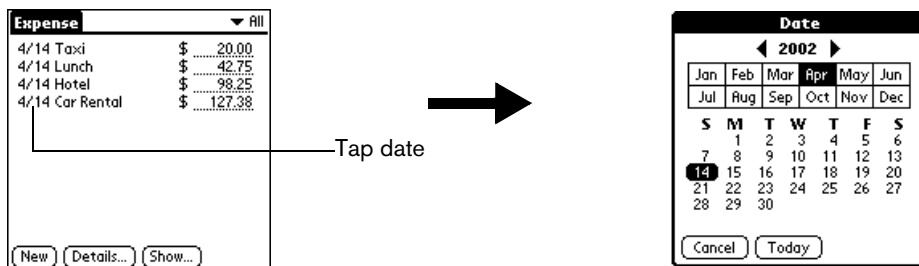

To change the date of an Expense item:

1. Tap the Expense item you want to change.
2. Tap the date of the selected item.



3. Select the new date.
4. Hold Option  and press Return  to finish.

## Entering receipt details

Expense provides a variety of options that you can associate with an item. These options appear in the Receipt Details dialog box.

To open the Receipt Details dialog box:

1. Tap the Expense item to which you want to assign details.
2. Tap Details.





3. Select any of the following options:

- |                 |   |
|-----------------|---|
| <b>Category</b> | See the section that begins on page 65 for details.   |
| <b>Type</b>     | Opens a pick list of expense types.   |
| <b>Payment</b>  | Lets you choose the payment method used to pay the Expense item. If the item is prepaid (such as airline tickets supplied by your company), you can choose Prepaid to place your expense in the appropriate company-paid cell of your printed expense report spreadsheet. See the section that begins on page 132 for more information. |

**Currency** Enables you to choose the type of currency used to pay the Expense item. The default currency unit is defined in the Preferences dialog (see page 134). You can also display up to four other common types of currency. see the next section in this chapter for more information.

**Vendor and City** Lets you record the name of the vendor (usually a company) associated with the expense and the city where the expense was incurred. For example, a business lunch might be at Rosie's Cafe (Vendor) in San Francisco (City).

**Attendees** See the section that begins on page 71 for details.

4. Hold Option  and press Return  to finish.



## Customizing the Currency pick list

You can select the currencies and symbols that appear in the Currency pick list.

To customize the Currency pick list:

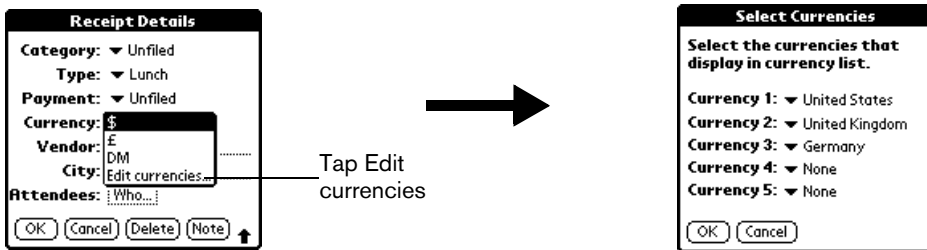
1. In the Receipt Details dialog box, tap the Currency pick list and select Edit currencies.



2. Tap each Currency pick list and select the country whose currency you want to display on that line.
3. Hold Option  and press Return  twice to finish.

## Defining a custom currency symbol

If the currency you want to use is not in the list of countries, you can create your own custom country and currency symbol.

To define a custom currency symbol:

1. Press Menu .
2. Under Options, select Custom Currencies. (/Y)
3. Tap one of the four Country boxes.

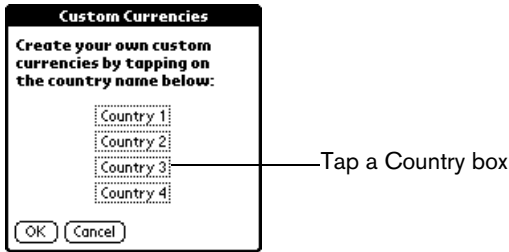

4. Enter the name of the country and the symbol that you want to appear in Expense.



5. Hold Option  and press Return  twice to finish.

Note: If you want to use your custom currency symbol as the default for all Expense items, select the symbol in the Preferences dialog box. If you want to use your custom currency symbol only for a particular Expense item, select the symbol in the Receipt Details dialog box associated with that item.

## Show Options



Show Options define the sort order and other settings that relate to your Expense items.

To open the Show Options dialog box:

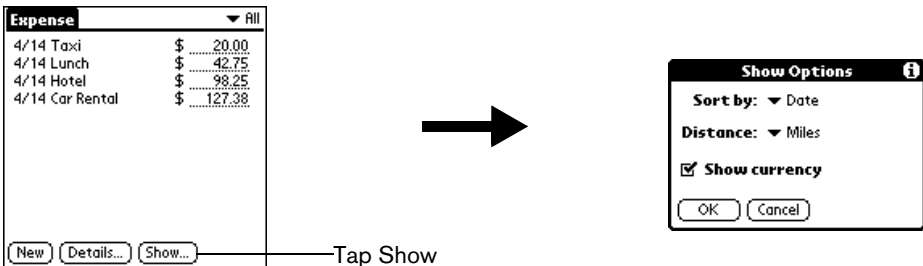
1. In the Expense list, tap Show.
2. Select any of the options.



- Sort by** Enables you to sort expense items by date or type.
- Distance** Enables you to display Mileage entries in miles or kilometers.
- Show currency** Shows or hides the currency symbol in the Expense list.

3. Hold Option  and press Return  to finish.

# Transferring your data to Microsoft Excel

After you enter your expenses into the Expense application on your handheld, you can view and print the data with your computer.

**Note:** You need Microsoft Excel version 5.0 (or later) to view and print your Expense data using one of the provided templates. Microsoft Excel is *not* included with the Treo handheld package. The procedures in this section also assume that you have installed Palm Desktop software as described on page 24.

## Creating or printing an expense report

It is easy to view and print your Expense data in a Microsoft Excel spreadsheet.

To create or print an expense report:

1. Perform a HotSync operation to transfer your latest Expense data to your computer.
2. Do one of the following:
  - Click Expense in Palm Desktop software to open Microsoft Excel and the Expense Report configuration dialog box.
  - From the Windows Start menu, click Programs, Palm Desktop, Expense Reports, and then choose your user name.
3. Click the expense category that you want.

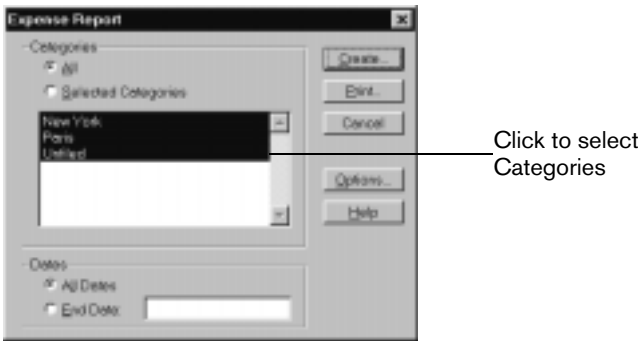

**Tip:** You can press Ctrl+click to select multiple categories. To print the expenses associated with all of your Expense categories, select All in the Categories group.

4. If you want to define an end date for the expense report, enter the date in the End Date box.

**Note:** If you do not specify an end date, all expense entries for the selected categories appear – up to the date of the last HotSync operation.

5. Do one of the following:
  - Click Print to display the expense report in the Print Preview window, and then click Print in the Microsoft Excel window to print your expense report.
  - Click Create to display a Microsoft Excel spreadsheet containing your expense data. Your data appears in Microsoft Excel spreadsheet form. You can enter information, make formatting changes, and save and print the file in the normal manner.

## Using expense report templates

Palm Desktop software includes several expense report templates. When you use one of these templates, you can edit your expense data in Microsoft Excel.

The templates have the extension .xlt and are stored in the template folder in the Palm Desktop software directory on your computer. To see what a template looks like before you use it, open the template in Microsoft Excel. For example, the template Sample2.xlt looks like this:

The screenshot shows a Microsoft Excel spreadsheet titled "Sample2.xlt". The spreadsheet is a form for a "Travel Expense Report". It has a grid layout with columns for recording expenses. The form is organized into sections:

- LODGING**: Includes categories like Lodging & Hotel, Laundry, and Taxi. A "Lodging total" row is at the bottom of this section.
- MEALS**: Includes categories like Breakfast, Lunch & Dinner, and Dinner. A "Meals total" row is at the bottom of this section.
- BUSINESS**: Includes categories like Business meals, Conferences, and Entertainment. A "Business total" row is at the bottom of this section.
- TRANSPORTATION**: Includes categories like Airfare, Auto Rental, Auto Miles/Gas, Local Transportation, Tolls/Parking, Mileage, and Travel. A "Travel total" row is at the bottom of this section.
- MISCELLANEOUS**: Includes categories like Gifts, Telephone & Fax, Supplies, Postage, Other, and Misc. total.

At the bottom of the form, there are fields for "Less cash advance", "Due employee", and "Due company". Below these are several rows for "Receipt number" with columns for "Exp", "Date", and "Amount".

If you want to streamline or customize your expense reports, you can change these templates. For example, you can add your company name to a template. See Appendix C for information on changing templates.

To view your expense data using a Microsoft Excel template:

1. Display your expense data in a Microsoft Excel spreadsheet as described in the previous procedure.
2. Click Options.

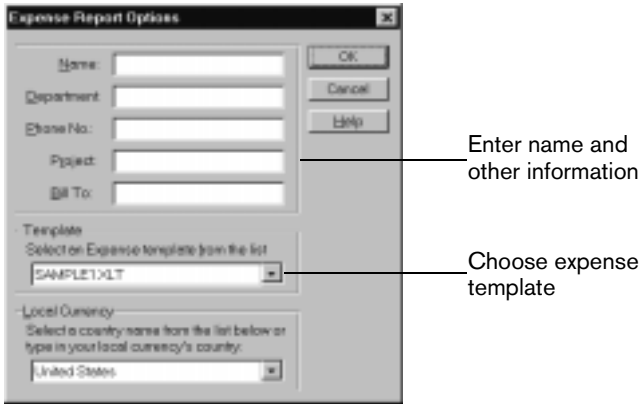

3. Enter name, department, and other information as necessary for your expense report.
4. Click the Templates menu; then select an expense template.

Note: If you want to create your own custom expense template and have it appear in the Templates menu, see Appendix C for more information.

5. Click OK.

## Expense menus

Expense menus are shown here for your reference, and Expense features that are not explained elsewhere in this guide are described here.

See page 33 for information about choosing menu commands.

### Record menu

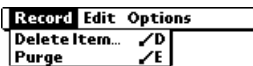

### Options menu

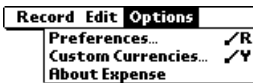

## Preferences

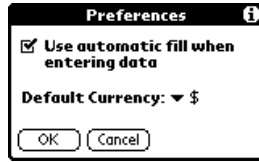

- Use automatic fill. Lets you select an expense type by entering the first letter of an expense type. For example, if you enter the letter "T," it enters the "Taxi" expense type. Entering "T" and then "E" enters "Telephone" which is the first expense type beginning with the letters "TE."
- Default currency. Sets the default currency symbol for Expense.

**About Expense** Shows version information for Expense.





## Chapter 7

# Setting Preferences for Your Handheld



The Preferences screens enable you to customize the configuration options on your Treo™ 90 handheld.

In the Preferences screens, you can do the following:

<b>Buttons</b>	Assign different applications to many of the buttons and icons on your handheld and the HotSync® cable.
<b>Connection</b>	Configure your handheld to communicate with other devices.
<b>Date &amp; Time</b>	Set the current date and time, the time zone, and daylight savings setting.
<b>Digitizer</b>	Calibrate the screen on your handheld.
<b>Formats</b>	Set the country default and the formats for dates, times, calendar, and numbers.
<b>General</b>	Set the current date and time, the auto shut-off interval, the Beam Receive feature, and the system, alarm, and game sounds.
<b>Network</b>	Configure your handheld for use with a wireless data network.
<b>Owner</b>	Assign your name, phone number, and other owner information to your handheld.
<b>Phone</b>	Assign a Connection profile and phone driver to use when communicating with a cell phone via IR or a special cable. These settings are used by the Palm SMS application and the dialing feature in the Contacts application.
<b>ShortCuts</b>	Define a list of abbreviations.

## Viewing Preferences

To open the Preferences screens:

1. Press Option  and then press Menu  to access the Applications Launcher.
2. Tap the Preferences icon .
3. Tap the pick list in the upper-right corner of the screen.
4. Select the Preferences screen you want to view.

# Buttons Preferences

The Buttons Preferences screen enables you to associate different applications with the application buttons on the front of your handheld and the HotSync button on the cable. For example, if you find that you seldom use To Do List and often use CityTime, you can assign the To Do List button to start CityTime, or any other application on your handheld. Any changes you make in the Buttons Preferences screen become effective immediately; you do not have to change to a different screen or application. If you assign a different application to a button, you can still access the original application using the Applications Launcher.

To change the Buttons Preferences:

1. Tap the pick list next to the button or icon you want to re-assign.

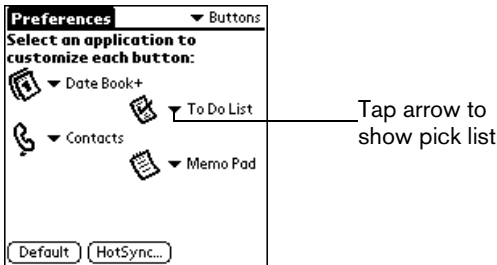

2. Tap the application that you want to assign to the button.

Tip: To restore all of the buttons to their factory settings, tap Default.

## HotSync Buttons Preferences

The HotSync Buttons Preferences screen also enables you to associate a different application with the button on the HotSync cable. Any changes that you make in the HotSync Buttons dialog box become effective immediately; you do not have to change to a different screen or application.

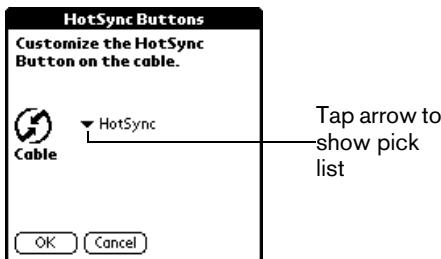

To change the HotSync Buttons Preferences:

1. From the Buttons Preferences screen, tap HotSync.
2. Tap the pick list.



3. Tap the application that you want to assign to the button.

The default setting for the button is the HotSync setting, which means the cable performs its normal HotSync functions.

4. Hold Option  and press Return  to finish.

# Connection Preferences

The Connection Preferences screen lets you create configurations for communicating with other hardware devices: PC, Modem, Phone, or Local Network, and the method used to connect to the device: Cradle/Cable, Infrared, Serial, or USB. Configurations, or profiles, once activated are available to applications on your handheld.

## Connection Types

The Connection Preferences screen displays a list of available configurations that you can modify as needed. This list varies depending on the software you have added to your handheld.

<b>Standard Modem</b>	Defines a connection between a modem attached to your handheld and a modem that is part of your computer or laptop.
<b>Cradle/Cable</b>	Defines the direct serial or USB connection between your handheld and your desktop computer. It is used to perform a local HotSync operation when your handheld is connected by a cradle or cable.
<b>IR to PC/Handheld</b>	Defines a connection between the IR port of your handheld and the infrared device of your computer or laptop.
<b>IR to Mobile Phone</b>	Defines a connection between the IR port of your handheld and a mobile phone with an IR port.
<b>Cable to Mobile Phone</b>	Defines a connection between your handheld and a mobile phone, using a special cable designed to match your phone.
<b>Serial to Modem</b>	Defines a connection between a modem attached to the serial connector of your handheld and a modem that is part of your computer or laptop.
<b>Verizon QNC</b>	Defines a connection between your handheld and mobile phone that connects to the Internet using the Verizon Quick Connect feature.

The following steps provide an example of how to define the Connection Preferences settings. In this example we illustrate how to create a connection that would enable you to use infrared communication between your handheld and your computer.

To create an IR to PC/Handheld connection:

1. In the Connection Preferences screen, tap New.
2. Enter a name for this configuration.
3. Tap the Connect to pick list and select PC.



4. Tap the Via pick list and select Infrared.
5. Hold Option and press Return to finish.

# Date & Time Preferences

The Date & Time Preferences screen enables you to set the time, date, time zone, and daylight savings setting for your handheld. See the section that begins on page 21 for information on changing these settings.

# Digitizer Preferences

The Digitizer Preferences screen opens the digitizer calibration screen. This is the same screen that appears when you start your handheld for the first time. You can recalibrate your screen after a hard reset, or if your digitizer accuracy changes over time.

# Formats Preferences

Use the Formats Preferences screen to set the country default and the display format of the dates, times, and numbers on your handheld.

## Country default

The country default sets date, time, week start day, and number conventions based on geographic regions where you might use your handheld. For example, in the United Kingdom, time often is expressed using a 24-hour clock. In the United States, time is expressed using a 12-hour clock with an AM or PM suffix.

All your handheld applications use the Country default settings. See the next section in this chapter for information on customizing these settings.

### To set the country default:

1. Tap the country name pick list.

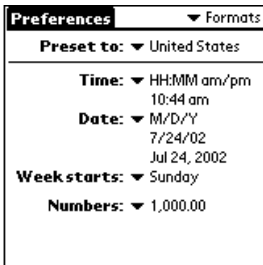

2. Tap the setting you want to use.

## Time, date, week start, and numbers formats

The Time setting defines the format for the time of day. The time format that you select appears in all applications on your handheld.

To select the time, date, week start, and numbers format:

1. Tap the Time pick list and select a format.
2. Tap the Date pick list and select a format.
3. Tap the Week starts pick list, and select whether you want the first day of the week to be Sunday or Monday.

Note: This setting controls the Day, Week, Month, Year, and List views in Date Book Plus and all other aspects of your handheld that display a calendar.

4. Tap the Numbers pick list, and select formats for the decimal point and thousands separator.

## General Preferences

The General Preferences screen enables you to set the auto shutoff interval, sounds for your handheld, the alarm LED, and the beam receive feature.

### Auto-off delay

Your handheld has an automatic shutoff feature that turns off the power after a period of inactivity. This feature conserves battery power if you forget to turn off your handheld. If you find that your handheld shuts itself off before you finish viewing information on the screen, increase the auto-off setting.

To set the Auto-off delay:

1. Tap the Auto-off After pick list.
2. Tap the setting you want to use for the automatic shutoff feature: 30 seconds, 1 minute, 2 minutes, or 3 minutes.

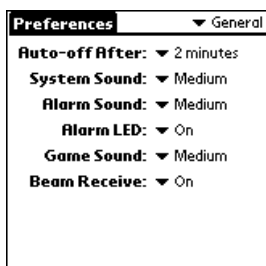

## System, alarm, and game sounds

Your handheld uses a variety of sounds. The System, Alarm, and Game Sound settings enable you to turn the sounds on or off, to adjust the volume level, and to turn the Alarm LED option on and off.

### To set the system, alarm, and game sounds:

1. Tap the System Sound pick list and select the sound level.

Note: When you turn off the System Sounds, you also turn off the “chime” tones associated with the HotSync operation.

2. Tap the Alarm Sound pick list and select the sound level.
3. Tap the Alarm LED pick list and select On if you want the LED to blink for two minutes when an alarm goes off, or select Off if you don't want the LED to blink.
4. Tap the Game Sound pick list and select the sound level.

Note: The Game Sound setting works only with games that are programmed to respond to this setting. Older games typically do not respond to this setting.

## Network Preferences and TCP/IP software

Network Preferences let you set a password, telephone number, DNS number, IP address, as well as create a login script for remote connections. For example, if you have a data-enabled mobile phone and want to use the modem inside the phone to connect to the Internet. TCP/IP provides the ability to connect to your ISP or dial-in server with applications that allow you to view the transmitted data.

To use TCP/IP software, you must first configure the Connection Preferences and then the Network Preferences settings. After you configure both of these Preferences, you can establish a PPP (Point-to-Point Protocol), SLIP (Serial Line Internet Protocol), or CSLIP (Compressed Serial Line Internet Protocol) connection with your ISP or dial-in server. You can do this either by using menu commands from the Network Preferences screen or by using a third-party application.

### Selecting a service

Use the Service setting to select the service template for your ISP or a dial-in server. Service templates are a set of ISP and dial-in server configuration settings that you can create, save, and reuse.

To select a service:

1. Tap the Service pick list.

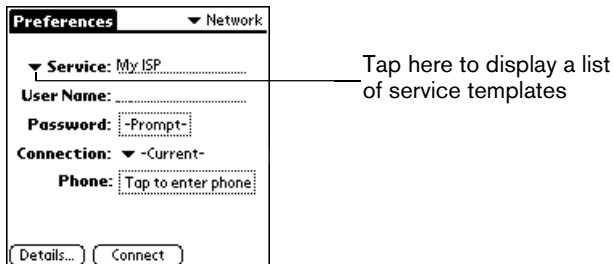

2. Tap the predefined service template.

Note: If you want to enter a name for a new service template, see page 147 for details.

## Entering a user name

The User Name setting identifies the name you use when you log into your Internet Service Provider or your dial-in server. Although this field can contain multiple lines of text, only two lines appear onscreen.

To enter a user name:

1. Tap the User Name field.
2. Enter your user name.

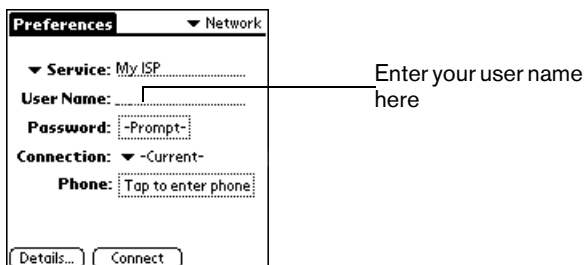

Note: Most dial-in servers do not accept spaces in the user name.

## Entering a password

The Password box identifies the password you use to log into your server or ISP. Your entry in this field determines whether your handheld prompts you to enter a password each time you log into your network:



- If you do not enter a password, your handheld displays the word "Prompt" in this field and asks you to enter a password during the login procedure.
- If you enter a password, your handheld displays the word "Assigned" in this field and does not prompt you to enter a password during the login procedure.

Note: If you are concerned about security, select the Prompt option and do not enter a password.

To enter a password:

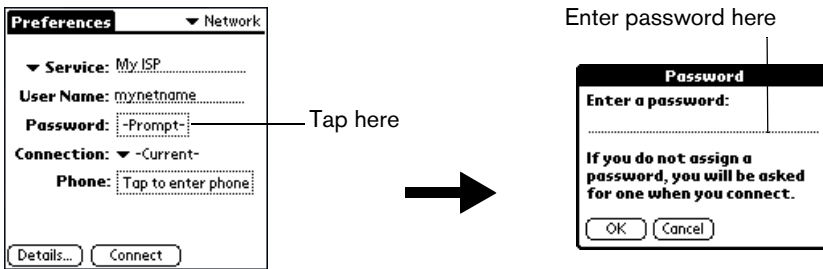
1. Tap the Password field.
2. Enter the password you use to log into your server.



3. Hold Option  and press Return  to finish.

Note: The Password field updates to display the word "Assigned."

## Selecting a connection

The Connection Preferences settings tell your handheld about the hardware you are using for remote data connections. For example, you can use a data-enabled mobile phone with an IR port or a special cable to connect the phone to your handheld. See the section that begins on page 139 for details on how to configure Connection Preferences.

To select a connection:

1. Tap the Connection pick list.

The list displays the configurations in your Connection Preferences panel.



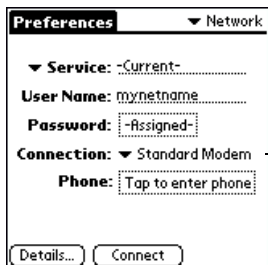

Tap to display a list of connection configurations

2. Select the appropriate Connection.

## Adding telephone settings

When you select the Phone field, your handheld opens a dialog box in which you define the telephone number you use to connect with your ISP or dial-in server. In addition, you can also define a prefix, disable Call Waiting, and give special instructions for using a calling card.



Note: The Phone Setup dialog box works correctly for AT&T and Sprint long-distance services. However, because MCI works differently, MCI customers need to put the calling card number in the Phone # field and the phone number in the Use calling card field.

To enter your server phone number:

1. Tap the Phone field.
2. Enter the phone number you use to reach your ISP or dial-in server.



Enter your ISP phone number here

3. If you need to enter a prefix or disable Call Waiting, skip to those procedures. Otherwise, hold Option  and press Return  to finish.

## Entering a prefix

A prefix is a number that you dial before the telephone number to access an outside line. For example, many offices require that you dial “9” to dial a number outside the building.

To enter a prefix:

1. Tap the Dial Prefix check box to select it.

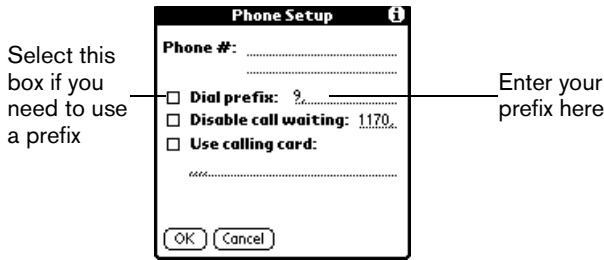

2. Enter the prefix.
3. Hold Option  and press Return  to finish.

## Disabling Call Waiting

Call Waiting can cause your session to terminate if you receive a call while you are connected. If your telephone has Call Waiting, you need to disable this feature before logging into your ISP or dial-in server.

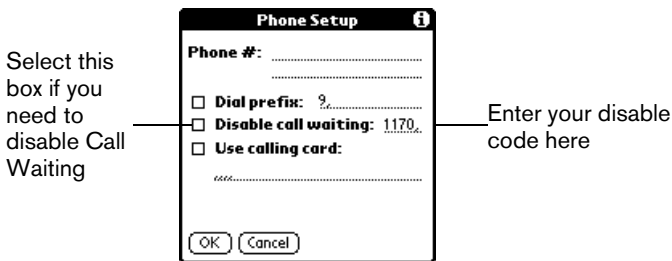

To disable Call Waiting:

1. Tap the Disable call waiting check box to select it.



2. Enter the code to disable Call Waiting on the Disable call waiting line.

Note: Each telephone company assigns a code to disable Call Waiting. Contact your local telephone company for the code that is appropriate for you.

3. Hold Option  and press Return  to finish.

## Using a calling card

The Use calling card field enables you to use your calling card when dialing your ISP or Intranet server. Keep in mind that there is usually a delay before you enter your calling card number. When you define your calling card number, you need to add commas at the beginning to compensate for this delay. Each comma delays transmission of your calling card number for two seconds.

To use a calling card:

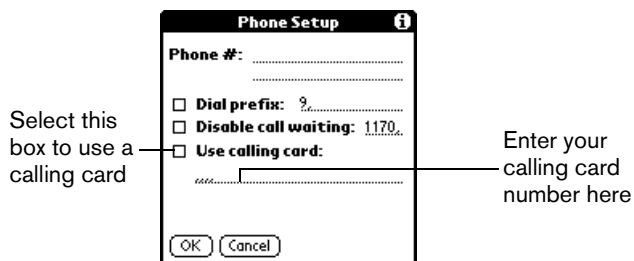

1. Tap the Use calling card check box to select it.



2. Enter your calling card number on the Use calling card line.

Note: It's a good idea to add at least three commas at the beginning of your calling card number to compensate for the cue delay.

Tip: MCI customers must enter the calling card number in the Phone # field, and the phone number in the Use Calling Card field.

3. Hold Option  and press Return  to finish.

## Connecting to your service

After you set your Connection and Network Preferences, establishing a connection to your Internet Service Provider (ISP) or your company's network (dial-in server) is easy.

To establish a connection:

- Tap Connect to dial the current service and display the Service Connection Progress messages.

Tip: To see expanded Service Connection Progress messages, press the bottom scroll button.

To close a connection:

- Tap Disconnect to terminate the connection between your handheld and your service.

## Creating additional service templates

You can create additional service templates from scratch or by duplicating existing templates and editing information. After you create a new or duplicate template, you can add and edit settings.

To add a new service template:

1. Press Menu .
2. Under Service, select New (/N).

A new service template (called Untitled) is added to the Service pick list.

To duplicate an existing service template:

1. Tap the Service pick list.
2. Tap the predefined service template you want to duplicate.
3. Press Menu .
4. Under Service, select Duplicate (/L).

A copy of the service template is added to the Service pick list.

## Adding detailed information to a service template

If you are using one of the predefined service templates, you probably only need to enter your user name and telephone number. If you are creating a new service template, you may need to provide additional information to your ISP or dial-in server. You use the Details dialog box to add additional information to a selected service template.

To select a connection type:

1. Tap the service field.
2. Tap Details.

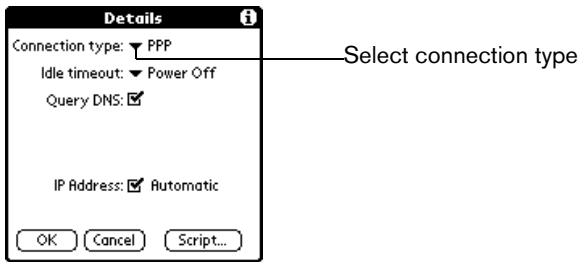

3. Tap the Connection type pick list and select one of the following connection types:

- |              |  |
|--------------|--|
| <b>PPP</b>   | Point-to-Point protocol                  |
| <b>SLIP</b>  | Serial Line Internet Protocol            |
| <b>CSLIP</b> | Compressed Serial Line Internet Protocol |

Note: If you are not sure, try PPP; if that doesn't work, ask your Internet Service Provider or your System Administrator for the correct connection type.

## Idle timeout

The Idle timeout setting defines how long your handheld waits before dropping the connection with your ISP or dial-in server when you switch out of a TCP/IP application.

### To set the Idle timeout:

1. Tap the Idle timeout pick list and select one of the following options:

- 1 minute**      Waits one minute for you to open another application before it drops the connection.
- 2 minutes**     Waits two minutes.
- 3 minutes**     Waits three minutes.
- Never**          Keeps your PPP or SLIP connection until you turn off your handheld (or until it times out). See page 141 for information on the Auto-off delay setting.

2. Hold Option  and press Return  to finish.

## Defining primary and secondary DNS

The Domain Naming System (DNS) is a mechanism in the Internet for translating the names of host computers into IP addresses. When you enter a DNS number (or IP address), you are identifying a specific server that handles the translation services.

Each IP address has four sections, separated by periods. In the Details dialog box, you enter each section separately. Each section of an IP address is made up of a number from 0 to 255; numbers are the only allowable characters in this field.



Ask your Internet Service Provider or System Administrator for the correct Primary or Secondary DNS IP numbers.

Note: Most Internet Service Providers automatically provide DNS information. Leave the Query DNS option checked unless you are certain you need to manually enter DNS information.

### To enter a primary and secondary DNS:

1. Tap the Query DNS check box to deselect it.
2. Tap the space to the left of the first period in the Primary DNS field, and then enter the first section of the IP address.

Note: Each section must be a number from 0 to 255.

3. Repeat step 2 for the second, third, and last sections of the Primary DNS field.
4. Repeat steps 2 and 3 for the Secondary DNS number.
5. Hold Option  and press Return  to finish.

## IP address

Everyone who logs on to the Internet needs to have a unique identifier (an IP address), whether permanent or temporary. Some networks dynamically assign a temporary IP address when clients log in. The IP Address field lets you identify whether your network provides automatic (dynamic) temporary IP addressing.

Note: Most Internet Service Providers automatically assign IP addresses. Leave the Automatic IP Address option checked unless you are certain you need to manually enter IP address information.

### To identify dynamic IP addressing:

- Tap the IP Address check box to select it.

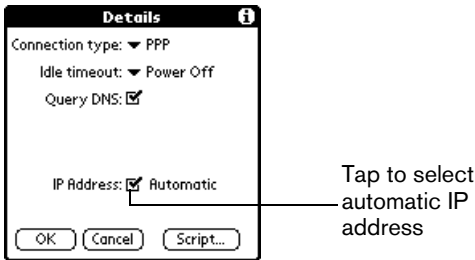

### To enter a permanent IP address:

1. Tap the IP Address check box to deselect it and display a permanent IP address field below the check box.
2. Tap the space to the left of the first period then enter the first section of the IP address.  
Note: Each section must be a number from 0 to 255.
3. Tap and enter the remaining sections of the IP address.
4. Hold Option and press Return to finish.

## Creating a login script

A login script is a series of commands, similar to an autoexec.bat file, that automates logging into your ISP. You can create login script files by selecting commands from the Command pick list in the Login Script dialog. Some commands from the Command pick list, such as Send, require you to supply additional information. Those commands have a parameter field so that you can add the necessary data.

Note: You can also use non-ASCII and literal characters in your login script. See Appendix D for more information.

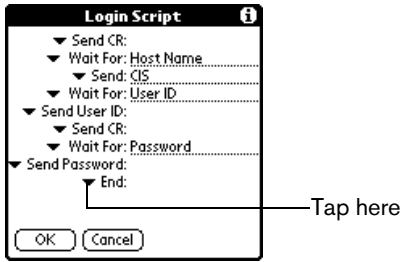

### To create a login script:

1. Tap Script.
2. Tap the End pick list.



3. Tap the command you want from the Command list. If the command requires additional information, a field appears to the right of it for you to enter the information. The following commands are available:



- |                        |  |
|------------------------|--|
| <b>Wait For</b>        | Tells your handheld to wait for specific characters from the TCP/IP server before executing the next command.  |
| <b>Wait For Prompt</b> | Detects a challenge-response prompt from the server and displays a dynamically generated challenge value. When you enter the challenge value into your token card, this generates a response value for you to enter on your handheld. This command takes two arguments, separated by a vertical bar ( ) on the input line. |
| <b>Send</b>            | Transmits specific characters to the TCP/IP server to which you are connecting.  |
| <b>Send CR</b>         | Transmits a carriage return or LF character to the TCP/IP server to which you are connecting.  |
| <b>Send User ID</b>    | Transmits the User ID information entered in the User ID field of the Network Preferences screen.  |
| <b>Send Password</b>   | Transmits the password entered in the Password field of the Network Preferences screen. If you did not enter a password, this command prompts you to enter one. The Password command is usually followed by a Send CR command.   |
| <b>Delay</b>           | Tells your handheld to wait a specific number of seconds before executing the next command in the login script.  |
| <b>Get IP</b>          | Reads an IP address and uses it as the IP address for your handheld. This command is used with SLIP connections.   |
| <b>Prompt</b>          | Opens a dialog box and prompts you to enter text of some kind (for example, a password or a security code).  |
| <b>End</b>             | Identifies the last line in the login script.  |

4. Repeat steps 2 and 3 until the login script is complete.
5. Hold Option  and press Return  to finish.

# Deleting a service template

There is only one way to delete a service template: use the Delete command from the Service menu.

## To delete a service template:

1. Tap the Service pick list.
2. Tap the service template you want to delete.
3. Press Menu .
4. Under Service, select Delete (/D).
5. Hold Option  and press Return  to finish.

# Network Preferences menu commands

The Network Preferences screen includes menu commands to make it fast and easy to create and edit service templates. TCP/IP application menus are show here for your reference.

See page 33 for more information about choosing menu commands.

## Service menu

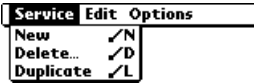

## Options menu

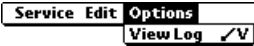

# TCP/IP troubleshooting

If you are having a problem establishing a network connection using TCP/IP, check this section and try the suggestions listed.

## Displaying expanded Service Connection Progress messages



It's helpful to identify at what point in the login procedure the connection fails. An easy way to do this is to display the expanded Service Connection Progress messages. Expanded Service Connection Progress messages describe the current stage of the login procedure. Press the bottom scroll button at any point during login to display these messages.

## Viewing the Network Log

If viewing the expanded Service Connection Progress messages does not give you enough information to find out why you cannot connect to your ISP or dial-in server, take a look at the Network Log. The Network Log lists all of the communication that occurs between your handheld and your dial-in server during the login procedure. The information in the Network Log can help your ISP or your System Administrator pinpoint where the login procedure communication fails and why.



### To view the Network Log:

1. Press Menu .
2. Under Options, select View Log (V).
3. Use the scroll buttons to see the entire Network Log.
4. Hold Option  and press Return  to finish.

## Adding a DNS number

If your ISP or dial-in server requires a DNS number and you did not enter that information in the Network Preferences screen, it will appear that you successfully logged into your network. When you try to use an application or look up information, however, the connection fails. If this occurs, try adding a DNS number. Ask your ISP or your System Administrator for the correct Primary and Secondary DNS IP numbers.

## Owner Preferences

The Owner Preferences screen enables you to record a name, company name, phone number, or any other information that you want to associate with your handheld.

If you use the Security application to turn off and lock your handheld with a password, information that you put in the Owner Preferences displays the next time you turn on your handheld.

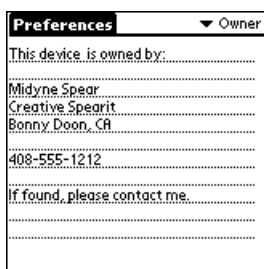

### To enter the Owner Preferences:

- Enter the text that you want to associate with your handheld in the Owner Preferences screen. If you enter more text than can fit on one screen, a scroll bar automatically appears on the right side of the screen.



If you assign a password with the Security application, the information in the Owner Preferences screen cannot be changed. In this case, an Unlock button appears at the bottom of the screen.

### To unlock the Owner Preferences screen:

1. Tap Unlock.
2. Enter the password that you defined in the Security application.
3. Hold Option  and press Return  to finish.

# Phone Preferences

The Phone Preferences screen enables you to assign a Connection profile to applications, such as Palm SMS, that must be used in conjunction with your mobile phone.

## To set Phone Preferences:

1. From the Connection pick list, select the configuration for you mobile phone.  
**Note:** If you do not see a Connection that is specific to your phone, select Infrared to GSM Phone if you connect to your phone via the IR port, or select Serial to GSM Phone if you connect to your phone with a cable.
2. Align your handheld's IR port with the IR port on your mobile phone, or connect your handheld to your phone via a special cable (sold separately).
3. Tap Test to confirm that the configuration works properly.

# ShortCuts Preferences

The ShortCuts Preferences screen enables you to define abbreviations for entering text. This section describes how to create, edit, and delete a ShortCut. See page 33 for information on the use of ShortCuts.



## Creating a ShortCut

You can create a ShortCut for any words, letters, or numbers. All ShortCuts you create appear on the list in the ShortCut Preferences screen. All the ShortCuts are available in any of your handheld applications and are backed up on your computer when you perform a HotSync operation.

## To create a ShortCut:

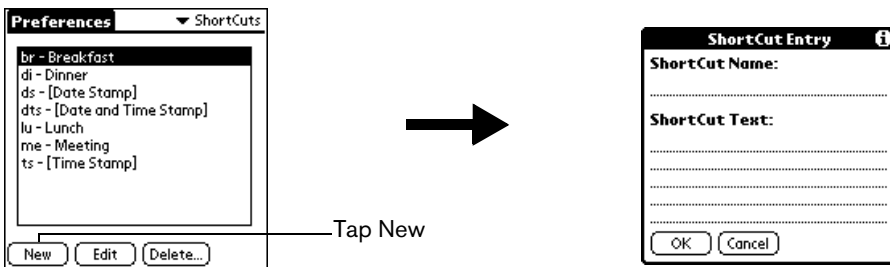
1. Tap New.
2. On the ShortCut name line, enter the letters you want to use to activate the ShortCut.





3. Tap the ShortCut Text area and enter the text that you want to appear when you type the ShortCut characters.  
**Tip:** You may want to add a space (space character) after the last word in your ShortCut text. This way, a space automatically follows the ShortCut text.
4. Hold Option  and press Return  to finish.  
**Tip:** To use a ShortCut, enter the ShortCut symbol followed by the ShortCut characters. See page 33 for details.

## Editing a ShortCut

After you create a ShortCut, you can modify it at any time.



To edit a ShortCut:

1. Tap the ShortCut you want to edit.
2. Tap Edit.
3. Make the changes you want.
4. Hold Option  and press Return  to finish.

## Deleting a ShortCut

If you no longer need a ShortCut, you can delete it from the list of ShortCuts.

To delete a ShortCut:

1. Tap the ShortCut you want to delete.
2. Tap Delete.
3. Hold Option  and press Return  for Yes.



## Chapter 8

# Advanced HotSync® Operations

HotSync® Manager enables you to synchronize data between one or more Palm OS® devices and Palm™ Desktop software or another PIM such as Microsoft Outlook. To synchronize data, you must connect your Treo™ 90 handheld and your desktop software either directly, by connecting your handheld to the HotSync cable attached to your computer or using infrared communication, or indirectly, with using an optional modem, or a network.

This chapter describes how to select HotSync options and perform a HotSync operation via the infrared port, an optional modem, or a network. See page 76 for information about performing your first and subsequent local HotSync operations.

## Selecting HotSync setup options

You can choose when you want HotSync Manager to run. If necessary, you can adjust the local and modem HotSync settings as well.

To set the HotSync options:

1. Click the HotSync Manager icon  in the Windows system tray.
2. Choose Setup.

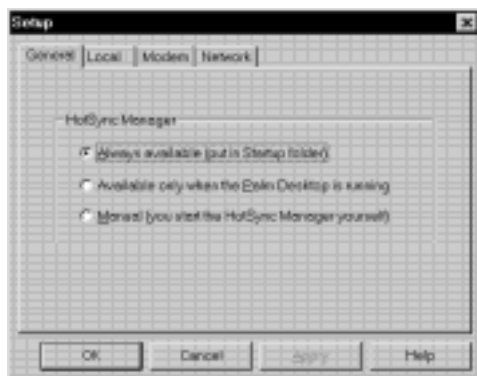

3. Click the General tab and select one of the following options:

**Always available** Adds HotSync Manager to the Startup folder and constantly monitors the communication port for synchronization requests from your handheld. With this option, the HotSync Manager synchronizes data even when Palm Desktop software is not running.

**Available only when Palm Desktop software is running**

Starts HotSync Manager and monitors requests automatically when you open Palm Desktop software.

**Manual**

Monitors requests only when you select HotSync Manager from the Start menu.

Tip: If you're not sure which option to use, keep the default setting: Always available.

4. Click the Local tab to display the settings for the connection between your computer and the HotSync cable, and adjust the following options as needed.

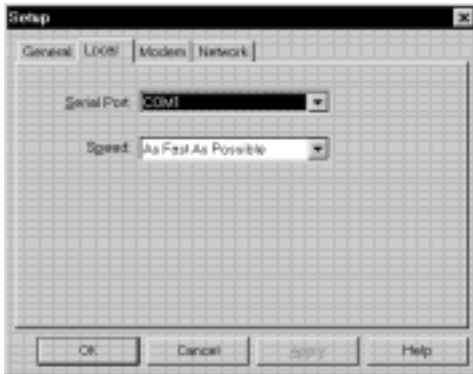

**Serial Port**

Identifies the port that your desktop software uses to communicate with the optional serial HotSync cable. This selection should match the number of the port to which you connected the optional cable.

Note: Your handheld cannot share this port with an internal modem or other device.

**Speed**

Determines the speed at which data is transferred between your handheld and your desktop software. Try the As Fast As Possible rate first, and adjust downward if you experience problems. This setting allows your desktop software and your handheld to find and use the fastest speed.

5. Click the Modem tab to display the modem settings and adjust the options as needed. See page 164 for more information.
6. If you are attached to a network, click the Network tab to display the network settings and adjust the options as needed. See page 168 for more information.
7. Click OK.

# Customizing HotSync application settings

For each application, you can define a set of options that determines how records are handled during synchronization. These options are called a “conduit.” By default, a HotSync operation synchronizes all files between the handheld and your desktop software.

In general, you should leave the settings to synchronize all files. The only reason you might want to change these settings is to overwrite data on either your handheld or your desktop software, or to avoid synchronizing a particular type of file because you don't use it.

In addition to the conduits for the applications on your handheld, HotSync Manager includes System and Install conduits. The System conduit backs up the system information stored on your handheld, including keyboard ShortCuts. The Install conduit installs applications on your handheld.

## To customize HotSync application settings:

1. Click the HotSync Manager icon  in the Windows system tray (bottom-right corner of the taskbar).

Tip: You can also click the HotSync command on the Palm Desktop software menu bar.

2. From the HotSync Manager menu, choose Custom.

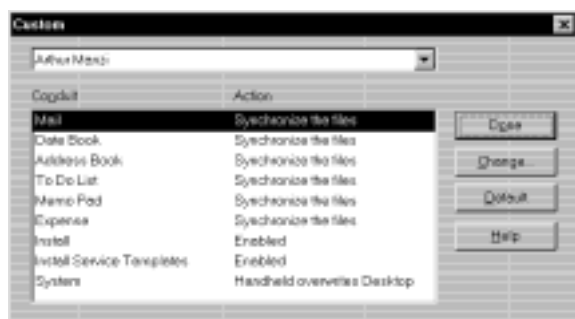

3. Select the appropriate user name from the list.
4. Select an application in the Conduit list.
5. Click Change.



6. Click the direction in which you want to write data, or click Do Nothing to skip data transfer for an application.

**Note:** Changing the HotSync setting from the default affects only the *next* HotSync operation. Thereafter, the HotSync Actions revert to their default settings. To use a new setting on an ongoing basis, select the Set As Default box. Thereafter, whatever you selected as the default setting is used when you click the Default button in the Custom dialog.

7. Click OK.
8. Repeat steps 4 through 7 to change conduit settings for other applications.
9. Click Done to activate your settings.

## IR HotSync operations

Your handheld is equipped with an infrared (IR) port that supports the IrCOMM implementation of the standards for infrared communication established by the Infrared Data Association (IrDA). This means that you can beam data to any other device that supports the IrCOMM implementation of the IrDA standards. Most importantly, you can use the IR port to perform HotSync operations. When you use the IR port on your handheld to perform HotSync operations, you don't need your HotSync cable. You simply enable infrared communication on your computer and your handheld and then perform an IR HotSync operation. So there's no need to carry your cable when you're on the road with an infrared-enabled laptop.

## Preparing your computer for infrared communication

To perform an IR HotSync operation, the computer you want to synchronize with must have an enabled infrared port or be connected to an infrared device that supports the IrCOMM implementation of the IrDA standards.

Desktop computers are likely to require an infrared device attached to a physical COM port. Laptops are likely to have a built-in IR port. Your computer must also have an installed infrared driver.

### Does your computer support infrared communication?

If your computer uses Microsoft Windows 98, Windows Me, Windows 2000, or Windows XP, infrared communication is built into the operating system. Some versions of Windows 95 also have built-in infrared communication. If you are using another type of computer, check the documentation that came with your computer to see if it supports infrared communication.

#### To check the ports used for infrared communication with Windows 98 and Me:

1. In the Windows taskbar click Start, choose Settings, and then choose Control Panel.
2. Double-click the Infrared icon.

**Note:** If you do not see the Infrared icon, you need to install an infrared driver.

3. Click the Options tab.



4. Select Enable infrared communication.

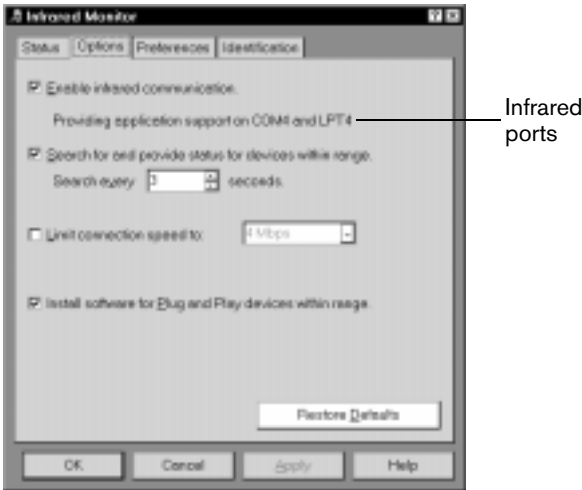

The COM port displayed on this screen is the port associated with your infrared device. It should be different from the port currently defined for cable synchronization.

5. Write down the port listed as “Providing application support” so you can configure HotSync Manager for infrared communication.

This port is the simulated port. It is the channel through which the actual infrared communication takes place between your computer and your handheld.

6. Deselect all other check boxes in the Options tab.
7. Click Apply and then click OK.

#### To enable infrared communication with Windows 2000 and Windows XP:

1. Click the HotSync Manager icon  in the Windows system tray (bottom-right corner of the taskbar).
2. Choose Exit to close HotSync Manager.
3. In the Windows taskbar click Start, choose Settings, and then choose Control Panel.
4. Double-click the Wireless Link icon.
5. Click the Image Transfer tab and deselect the Use Wireless Link to transfer images from a digital camera to your computer check box.

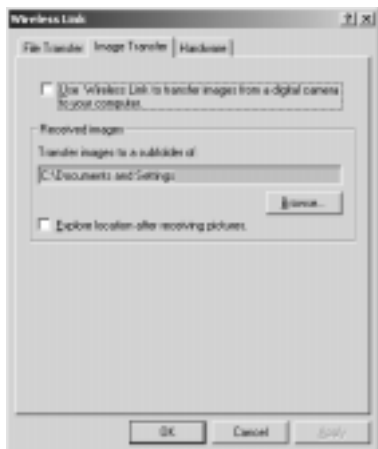

6. Click OK.
7. Disable any other application that opens the IR port.

## Configuring HotSync Manager for infrared communication

Next you need to go to the HotSync Manager and configure it for infrared communication. In Windows 98 and Me, you need to specify the simulated port used for infrared communication. In Windows 2000 and Windows XP, you simply need to activate the infrared menu item.

To configure HotSync Manager for infrared communication with Windows 98 and Me:

1. Click the HotSync Manager icon  in the Windows system tray.
2. Make sure Local Serial is checked on the menu.
3. Choose Setup.
4. Click the Local tab.
5. In the Serial Port list, select the simulated port used for infrared communication. See the previous section for instructions on identifying the simulated port.

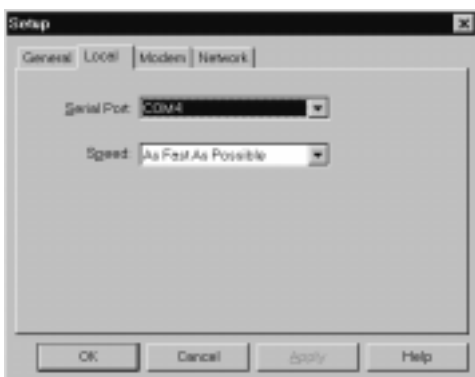

6. Click OK.

The HotSync Manager is now communicating with the simulated port defined for infrared communication.

Note: You cannot use your cable again until you reconfigure the HotSync Manager to communicate with the port defined for cable synchronization.

To configure HotSync Manager for infrared communication with Windows 2000 and Windows XP:

1. If necessary, start HotSync Manager.
2. Click the HotSync Manager icon  in the Windows system tray.







3. Choose InfraRed from the HotSync Manager menu.

## Performing an IR HotSync operation

After you complete the steps to prepare for an IR HotSync operation it is easy to perform the actual operation.

To perform an IR HotSync operation:

1. Press Option  and then press Menu  to access the Applications Launcher.
2. Use the scroll buttons to select the HotSync icon .
3. Press Return  to launch the application.
4. Tap Local.
5. Tap the pick list below the HotSync icon and select IR to a PC/Handheld.

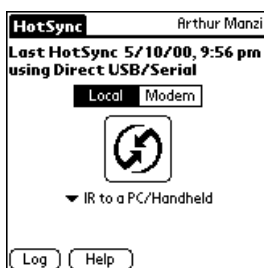

6. Position your handheld's IR port within a couple of inches of your computer's infrared port.
7. Tap the HotSync icon to start the IR HotSync operation.

## Returning to serial cable HotSync operations

It's easy to return to using the cable for HotSync operations.

**Note:** If you're using a USB cable and the Local USB option is already selected on the HotSync Manager menu, you don't need to do anything to return to cable operations.

### To return to serial cable HotSync operations with Windows 98 and Me:

1. If needed, connect the cable to your computer.
2. Click the HotSync Manager icon  in the Windows system tray.
3. Choose Setup, and then click Local.
4. In the Serial Port list, select the COM port where your cable is connected.
5. Click OK.

### To disable infrared communication with Windows 2000 and Windows XP:

1. Click the HotSync Manager icon  in the Windows system tray.
2. Uncheck InfraRed on the menu.
3. In the Windows taskbar click Start, choose Settings, and then choose Control Panel.
4. Double-click the Wireless Link icon.
5. Click the Image transfer tab, and select the Use Wireless Link to transfer images from a digital camera to your computer check box.

The next time you want to perform a HotSync operation just press the HotSync button on the cable. You can leave the HotSync application on your handheld set to perform IR HotSync operations and still use the cable. This is useful if you perform HotSync operations with both your desktop computer and a laptop. When you are in the office just connect your handheld to the cable and press the HotSync button. When you travel, you don't have to carry a cable.

## Conducting a modem HotSync operation

You can use a modem to synchronize your handheld when you are away from your computer. The modem can be located on an expansion card, or inside a mobile phone that you connect to your handheld.

**Note:** The first HotSync operation must be local, using the cable. After that, you can perform a modem HotSync operation.

To perform a modem HotSync operation you must complete the following steps:

- Connect a modem to your computer
- Configure HotSync Manager for use with your modem
- Connect a modem to your handheld
- Configure the Modem Preferences on your handheld for use with your modem

## Preparing your computer

There are a few steps you must perform to prepare your computer for a modem HotSync operation. Be sure to perform these steps before you leave your office so that your computer is ready to receive a call from your handheld.

### To prepare your computer for a modem HotSync operation:

1. Confirm that the computer modem is connected and turned on, and that no communications applications, such as fax or telephony software, are running on a COM port.

Note: Make sure the computer is disconnected from all online services, such as America Online (AOL) and CompuServe. This helps to avoid conflicts with the COM port.

2. Start HotSync Manager if it is not already running, and from the HotSync Manager menu, choose Modem.
3. Adjust the following options as needed.

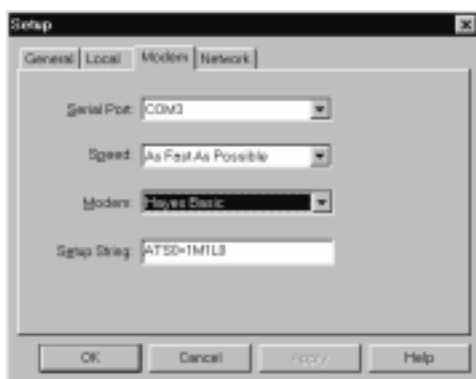

**Serial Port** Identifies the port for the modem. If you are unsure of the port assignment, look at the Modem Properties in the Windows Control Panel.

**Speed** Determines the speed at which data is transferred. Try the As Fast As Possible rate first, and adjust downward if you experience problems. This setting allows your desktop software and your handheld to find and use the fastest speed.

**Modem** Identifies the modem type or manufacturer. Refer to your modem manual or face plate for its type or settings. If you're not sure of your modem type or your modem doesn't match any that appear in the list, select Hayes Basic.





**Setup String** Identifies the setup string for your particular modem. Not all modems require a setup string. Refer to your modem manual and enter the setup string if recommended by the manufacturer.

4. Click OK.

# Preparing your handheld

There are a few steps you must perform to prepare your handheld for a modem HotSync operation.

To prepare your handheld for a modem HotSync operation:

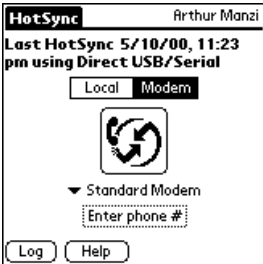

1. Press Option  and then press Menu  to access the Applications Launcher.
2. Use the scroll buttons to select the HotSync icon .
3. Press Return  to launch the application.
4. Tap Modem.



5. Tap the pick list below the HotSync icon and select Standard Modem.
6. Tap the Enter Phone # field.

Note: If you plan to connect to your company's dial-in server (network modem) instead of connecting to a computer modem, see page 168.







7. Enter the telephone number to access the modem connected to your computer.
8. If needed, enter a dial prefix (such as "9") to access an outside line, and then tap the Dial Prefix check box.  
  
Tip: You can enter a comma in the field to introduce a "pause" in the dialing sequence. Each comma equals a two second pause.
9. Select the Disable call waiting check box to avoid an interruption during the modem HotSync operation.
10. If you want to use a calling card to place the call, select the check box and enter the calling card number.
11. Hold Option  and press Return  to finish.

## Selecting the conduits for a modem HotSync operation

The Conduit Setup dialog box on your handheld enables you to define which files and/or applications synchronize during a modem HotSync operation. You can use these settings to minimize the time required for modem synchronization.

To change the Conduit Setup for a modem HotSync operation:

1. Press Option  and then press Menu  to access the Applications Launcher.
2. Use the scroll buttons to select the HotSync icon .
3. Press Return  to launch the application.
4. Press Menu .
5. Under Options, select Conduit Setup (✓/D).
6. Tap the check boxes to deselect the files and applications that you do *not* want to synchronize during a modem HotSync operation. The default setting is to synchronize all files.

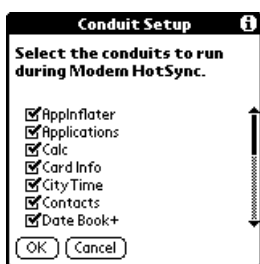





Note: Applications that do not have a database (such as games) do not synchronize – even if you select the item in the Conduit Setup dialog box.

7. Hold Option  and press Return  to finish.

## Performing a modem HotSync operation

After you prepare your computer and your handheld, and select your Conduit Setup options, you are ready to perform a modem HotSync operation.

To perform a modem HotSync operation:

1. Press Option  and then press Menu  to access the Applications Launcher.
2. Use the scroll buttons to select the HotSync icon .
3. Press Return  to launch the application.
4. Tap the Modem icon  to dial the desktop modem and synchronize the applications.
5. Wait for the HotSync operation to finish. If you have any problems conducting a successful HotSync operation, see Appendix B.

# Conducting a HotSync operation via a network

When you use the Network HotSync software, you can take advantage of the Local Area Network (LAN) and Wide Area Network (WAN) connectivity available in many office environments. The Network HotSync software enables you to perform a HotSync operation by using the WAN to dial-in to a network or by using a cable that is connected to any computer on your LAN (provided that the computer connected to the cable also has the Network HotSync software installed, your computer is on, and the HotSync Manager is running).

## Connecting to your company's dial-in server

The Network HotSync software requires the following:

- Your computer has TCP/IP support installed.
- Both your company's network system and its remote access server support TCP/IP. (Your System Administrator has this information.)
- You have a remote access account. (If you don't have an account, consult your System Administrator.)

Everything you need to connect to your company's dial-in server (network modem) is included with HotSync Manager and the software on your handheld. You need to activate the feature, however, in HotSync Manager and on your handheld.

To prepare your computer for a network HotSync operation:

1. Click the HotSync Manager icon  in the Windows system tray (bottom-right corner of the taskbar).
2. From the HotSync Manager menu, choose Network.

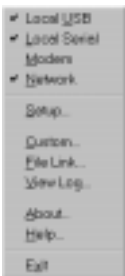

Note: To perform a Network HotSync from another computer on your network, you must select Network from the HotSync Manager menu on both your primary computer and the computer you want to use.

3. From the HotSync Manager menu, choose Setup.
4. Click the Network tab and make sure your user name has a check mark next to it. If the check mark is not there, click the check box next to your user name.











5. Click OK.
6. Connect your handheld to the cable and press the HotSync button.

The HotSync operation records network information about your computer on your handheld. With this information, your handheld can locate your computer when you perform a HotSync operation over the network.

#### To prepare your handheld for a dial-in network HotSync operation:

Note: If you are performing a network HotSync operation via a LAN, you do not need to prepare your handheld and can skip to page 170.



1. Press Option  and then press Menu  to access the Applications Launcher.
2. Use the scroll buttons to select the HotSync icon .
3. Press Return  to launch the application.
4. Press Menu .
5. Under Options, select Modem Sync Prefs (✓/O).
6. Tap Network.
7. Hold Option  and press Return  to finish.

Note: See the section that begins on page 142 for information on configuring Network HotSync preferences.

## Performing a dial-in network HotSync operation

You are ready to perform a dial-in network HotSync operation after you prepare your computer and handheld, and select your Conduit Setup options.

#### To perform a dial-in network HotSync operation:

1. Press Option  and then press Menu  to access the Applications Launcher.
2. Use the scroll buttons to select the HotSync icon .

3. Press Return  to launch the application.
4. Tap the modem HotSync icon to begin the operation.

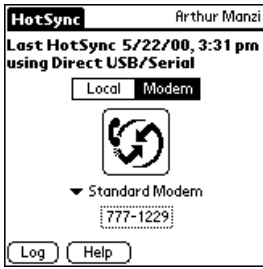

## Performing a network HotSync operation via a LAN

You are ready to perform a network HotSync from another computer on your network after you select Network from the HotSync Manager menu on both your primary computer and the computer you want to use for the network HotSync operation.

To perform a network HotSync operation via a LAN:

1. Connect your handheld to a HotSync cable that is connected to a computer on the LAN.
2. Press the HotSync button on the cable.

HotSync Manager finds your primary computer on the LAN and synchronizes with the data on your primary computer.

## Using File Link

The File Link feature enables you to import PhoneBook and Memo Pad information onto your handheld from a separate external file such as a company phone list. HotSync Manager stores the data in a separate category on your Palm Desktop software and your handheld. You can configure the File Link feature to check for changes to the external file when you perform a HotSync operation.

With File Link, you can import data stored in any of the following formats:

- Comma delimited (.csv)
- Tab delimited (.tsv)
- Memo Pad archive (.mpa)
- Address archive (.aba)
- Text (.txt)

For information on how to set up a file link, see the Palm Desktop online Help.

Note: To use this feature, you must use Palm Desktop software as your PIM software.

# Creating a user profile

If you need to configure several Palm OS® handhelds with specific information (such as a company phone list) before distributing them to their actual users, you can create a user profile to load the data into a handheld without associating that data with a user name. The User Profile feature is designed only for the first-time HotSync operation, before you assign a User ID to a particular handheld.

To create a user profile:

1. Open Palm Desktop software.
2. From the Tools menu, choose Users.
3. Click Profiles.
4. Click New.



5. Enter a unique name for the profile, and click OK.



6. Repeat steps 3 and 4 for each profile that you want to create, and then click OK to return to Palm Desktop software.
7. Select the profile from the User list and create the data for the profile (e.g., company phone list, etc.).



To use a profile for the first-time HotSync operation:

1. Connect the new handheld to the HotSync cable.
2. Press the HotSync button on the cable.
3. Click Profiles.
4. Select the profile that you want to load on the handheld, and click OK.

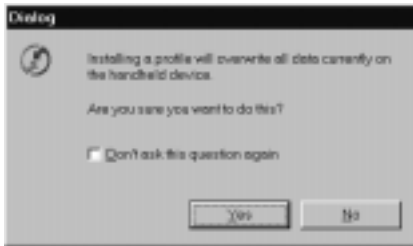

5. Click Yes to transfer all the profile data to the handheld.

The next time you perform a HotSync operation, Palm Desktop software prompts you to assign a user name to the handheld.

## Synchronizing with your desktop e-mail application

Palm™ Mail is an application that lets you synchronize with the e-mail application on your desktop computer. You can read, reply to, compose, and delete e-mail on your handheld. To send or receive e-mail, you simply perform a HotSync operation either locally, using the HotSync cable or the infrared port on your handheld, or remotely, using an optional modem or a network as described earlier in this chapter.

The key to Palm Mail is that it truly synchronizes the mail in the Inbox of your desktop e-mail application with the mail on your handheld. For example, if you delete e-mail items from Palm Mail, your next HotSync operation also deletes the e-mail items from your desktop e-mail application, so you never have to delete e-mail items twice. Similarly, if you read an e-mail item on your handheld and leave it in your Inbox, your next HotSync operation marks it as read in your desktop e-mail application.

**In Palm Mail, you can do the following:**

- View, delete, file, and reply to incoming mail.
- Create outgoing e-mail items and drafts of e-mail items.
- Create simple or complex filters, which allow you to decide the type of e-mail that your handheld retrieves from your desktop E-mail application.
- Use your handheld and its HotSync cable or with infrared communication to send and retrieve e-mail items from your desktop e-mail application.

## Preparing your computer to synchronize desktop e-mail

Before you use Palm Mail for the first time, make sure your desktop e-mail application is up and running. You must also set up Palm Desktop software for use with your desktop e-mail application.

Palm Mail supports a number of Windows desktop e-mail applications, such as Microsoft Outlook (version 4.0 or higher), QUALCOMM Eudora (version 3.0.3 or higher), and Lotus cc:Mail (versions 2.5, 6.0, and 7.0). You can see the full list of the supported applications when you set up Palm Mail.

If your desktop e-mail application does not appear on the list, you may still be able to manage your desktop e-mail application from your handheld by means of special connection software, called a conduit, that lets you synchronize your desktop e-mail application and your handheld. Contact the vendor of your e-mail application or visit the web site [www.handspring.com](http://www.handspring.com) for more information.

**Note:** The following instructions assume that you have already installed Palm Desktop software on your computer and that you did not set up Palm Mail during the installation. If you have not yet installed Palm Desktop software, install it now.

### To set up Palm Mail:

1. Click Start in the Windows taskbar.
2. Highlight Programs, highlight Handspring (or Palm), and then click Mail Setup to begin setup.
3. Follow the instructions onscreen to set up your handheld for use with your desktop e-mail application.

### To select HotSync options:

1. Click the HotSync icon  in the Windows system tray (bottom-right corner of the taskbar).
2. Choose Custom.

**Tip:** You can also choose Custom from the HotSync menu in Palm Desktop software.

3. Select Mail in the list box.
4. Click Change.



5. Click one of the following settings:

- |                                    |  |
|------------------------------------|--|
| <b>Synchronize the files</b>       | Synchronizes the mail on your handheld and your desktop e-mail application.  |
| <b>Desktop overwrites handheld</b> | Replaces the mail on your handheld with the mail in your desktop e-mail application. You should use this option only if, for some reason, the two inboxes get out of sync. This setting applies for only one HotSync operation and then reverts back to the default setting. |
| <b>Do Nothing</b>                  | Turns off communication between your handheld and desktop e-mail application. This setting applies for only one HotSync operation and then reverts back to the default setting.  |
| <b>Set As Default</b>              | Changes the default setting on an ongoing basis. (When you first set up Palm Mail, Synchronize the files is the default setting.)  |

Tip: To turn off Palm Mail, select Do Nothing and then select the Set As Default check box.

### To change your Palm Mail setup options:

1. Click the HotSync icon  in the Windows system tray.
2. Choose Custom.





Tip: You can also choose Custom from the HotSync menu in Palm Desktop software.

3. Select Mail in the list box.
4. Click Change.
5. Modify your settings as needed.
6. Click OK.

## Using Palm Mail on your handheld

After you enable and configure Palm Mail, perform a HotSync operation to synchronize Palm Mail with your desktop e-mail application. The following section explains how to use Palm Mail on your handheld.

### To open Palm Mail:

1. Press Option  and then press Menu  to access the Applications Launcher.
2. Use the scroll buttons to select the Mail icon .
3. Press Return  to launch the application.

## Viewing e-mail items

The Message list displays a list of your incoming e-mail items, who sent them, and the date they were received. E-mail items you've read have a check next to them. High-priority e-mail items appear in bold.

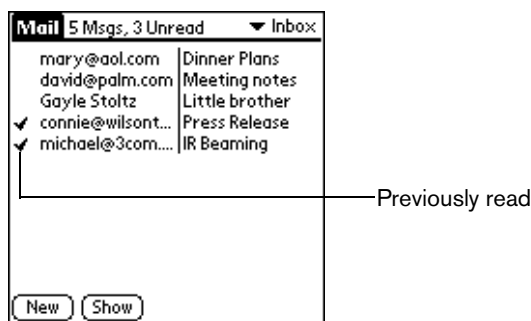

To open an e-mail item:

1. Use the scroll buttons to select the message you want to open.
2. Press Space  to open it.

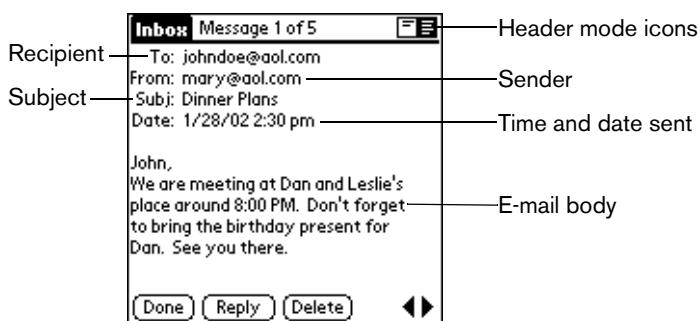

To close an e-mail item:

- Hold Option  and press Return  to close the e-mail item.

## Displaying full header information

By default, Palm Mail displays abbreviated header information, which comprises only the From: and Subj: fields. The full header provides complete information about the sender, receiver, and copied recipients, in addition to the subject and date the e-mail item was created. Palm Mail uses the header type you select for all your e-mail items.

To display full header information:

1. Open an e-mail item.
2. Tap the Complete Header icon.

Tip: To redisplay the abbreviated header, tap the Abbreviated Header icon.

# Creating e-mail items

You create e-mail items with your handheld the same way you create e-mail with your desktop E-mail application: you identify the recipient(s) of the e-mail item, define a subject, and create the body of the e-mail item.

You create original e-mail items and replies in the New Message screen. All e-mail items must, at the very least, contain information in the To: and Subj: fields.

To create an e-mail item:

1. Press Menu .
2. Under Message, select New (/N).

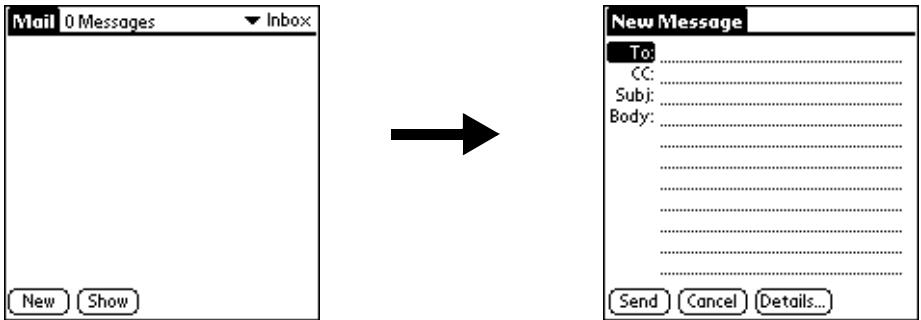

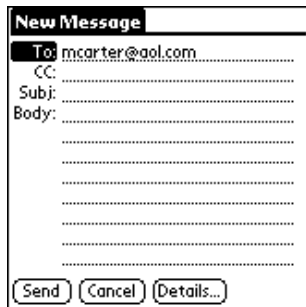

3. Enter the e-mail address of the recipient.



Note: Enter the address as if you were entering it from your desktop e-mail application. For example, network users sending an e-mail item to a user on the same network do not need to add Internet information, such as @mycorp.com.

4. To send a copy of this e-mail item to additional recipients, tap the CC: field, and then enter the e-mail addresses of the additional recipients, separating the addresses with a comma followed by a space.
5. In the Subj: field, enter a subject for your e-mail item.
6. In the Body: field, enter the text of your e-mail item.

Tip: If the address, CC, subject, or body exceeds the capacity of the screen display, tap the name of the field (for example, tap "To:") to expand that field. Hold Option  and press Return  to return to the New Message screen.



Tap the name of the field to open

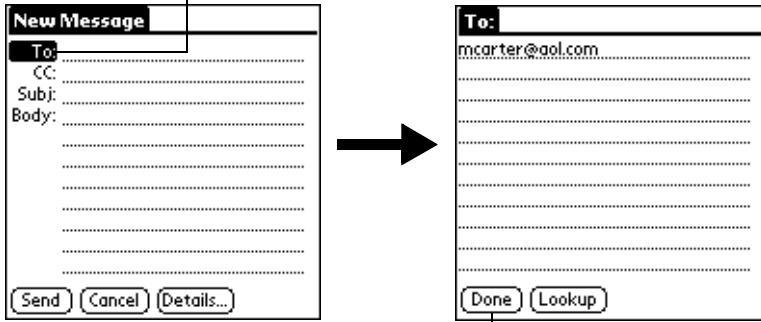



Tap to return to New Message screen

To reply to an e-mail item:

1. Open an e-mail item in the Message list to display it onscreen.
2. Tap Reply.
3. Select whom you want to receive the reply: Sender only, All recipients, or someone who didn't see the original e-mail item (Forward).



4. Select whether you want to include original text or comment original text.
5. Hold Option  and press Return  to finish.
6. Enter the text of your reply.

Tip: You have several options including setting the priority. See page 178 for details.

7. Tap Send to place your reply in the Outbox.

## Looking up an address

To identify the recipient of an e-mail item, you need to enter that person's e-mail address. You can do this either by entering the data directly into the field or by using the Look Up command to access the information in your Contacts list.

To look up an e-mail address:

1. Tap either the To: or CC: field name to expand it.
2. Enter the first few letters of the last name of the person whose address you want to find.
3. Press Menu .
4. Under Options, select Lookup (/L).
5. If the letters you enter identify a unique listing from your Contacts list, your handheld completes the address for you. If not, the Lookup dialog box appears and lists all records that contain information in an E-mail field.

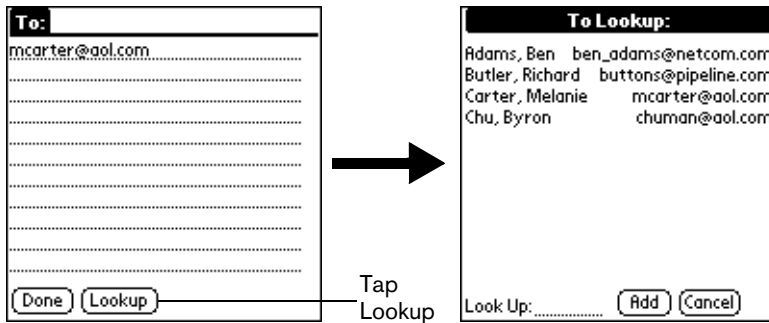

6. Enter the first letter of the entry you want to find to scroll to the first entry that begins with that letter. If you write an additional letter, the list scrolls to the first entry that starts with those two letters. For example, writing an "s" scrolls to "Sanders," and writing "sm" scrolls to "Smith."
7. Tap an address to select it.
8. Tap Add.

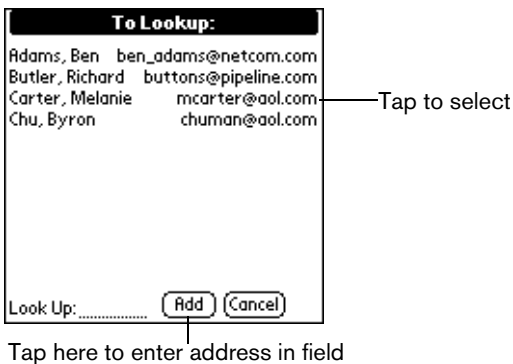

## Adding details to e-mail items

Before you send your e-mail item, you can attach additional attributes to it, such as a signature or a priority level. These features are dependent on the desktop E-mail application you use. If your application does not support the attribute you select, your handheld cannot attach that attribute to the e-mail item.

The following details are available:

- Priority** Flags an e-mail item as High, Normal, or Low priority.
- BCC** Creates a blind carbon copy field in the New Message screen.
- Signature** Attaches previously defined text as the closing of an e-mail item. See page 180 for details.
- Confirm Read** Requests a confirmation telling you when the e-mail item was read.
- Confirm Delivery** Requests a confirmation telling you when the e-mail item was delivered.

Note: The Priority and BCC settings are valid only for the current e-mail item and must be set for each item you create.

## Setting a priority

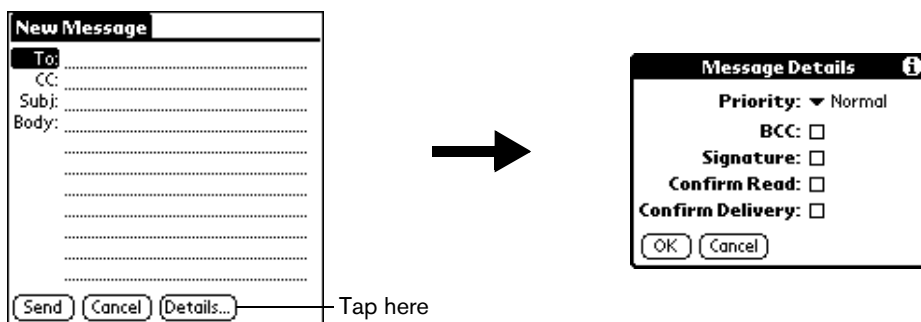

To set a priority for your e-mail item:

1. In the New Message screen, tap Details.

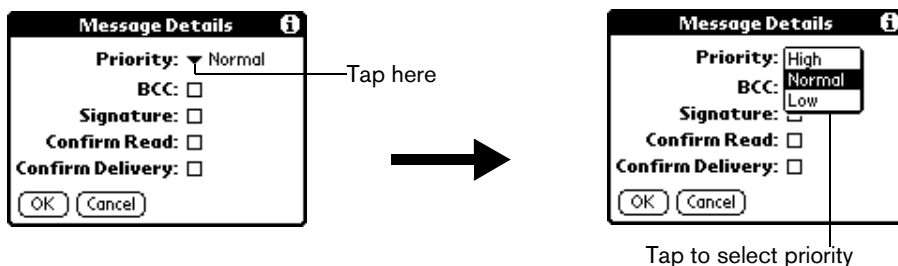

2. Tap the Priority pick list and select the priority you want.





3. Hold Option  and press Return  to finish.

Tip: Your handheld can flag e-mail items with a specific priority only if your desktop e-mail application supports this feature.

## Sending a blind carbon copy

To add a BCC field to your e-mail item:

1. In the New Message screen, tap Details.
2. Tap the BCC check box to select it.
3. Hold Option  and press Return  to finish.

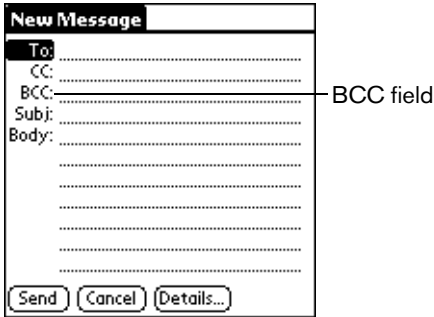

4. Tap the BCC: field and enter an address.

## Adding a signature to your e-mail item



A signature consists of information about yourself that is appended to your e-mail item as its closing. For example, a signature can contain your name, address, phone and fax numbers, and any other text you want to include. By defining such information as a signature, you save yourself the trouble of having to enter it every time you create an e-mail item.

Adding a signature to your message is a two-part process. First, you create your signature. Then you select the Signature option.

To create a signature:

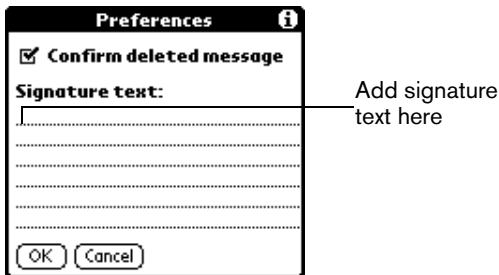
1. Press Menu .
2. Under Options, select Preferences (/R).
3. Tap the Signature text field and enter the text of your signature.



4. Hold Option  and press Return  to finish.

### To add a signature to your e-mail item:

1. In the New Message screen, tap Details.
2. Tap the Signature check box to select it and add your signature to the e-mail item.



Note: The check box stays selected, so all subsequent e-mail items you create will also contain your signature until you deselect the Signature option.

3. Hold Option  and press Return  to finish.



Note: The signature does not display in your e-mail item; only your recipient sees the signature.

## Requesting confirmations

### To receive a confirmation when your e-mail item is read:

1. In the New Message screen, tap Details.
2. Tap the Confirm Read check box to select it.
3. Hold Option  and press Return  to finish.

### To receive a confirmation when your e-mail item is delivered:

1. In the New Message screen, tap Details.
2. Select the Confirm Delivery check box to select it.
3. Hold Option  and press Return  to finish.

## Storing e-mail to be sent later

When you send e-mail from your handheld, it actually stores the e-mail in the Outbox folder until the next time you synchronize your handheld with your computer. During synchronization, all e-mail stored in the Outbox folder is transferred to the Outbox folder in your desktop e-mail application. E-mail created on your handheld is sent out the next time you send mail from your desktop e-mail application.

### To send e-mail:

- After you create an e-mail item, tap Send.

## Editing unsent e-mail

You can make changes to an e-mail that has not yet been sent, as long as you have not yet performed a HotSync operation. When you edit an e-mail item, your handheld removes the item from the Outbox folder and takes you back to the New Message screen, where you can edit the item and resend it, save it as a draft, or delete it.

To retrieve an e-mail item:

1. In the Message list, tap Outbox from the pick list in the upper-right corner.

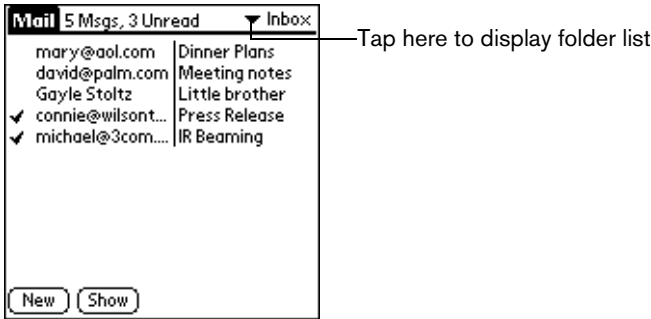

2. Use the scroll buttons to select the e-mail item you want to retrieve.

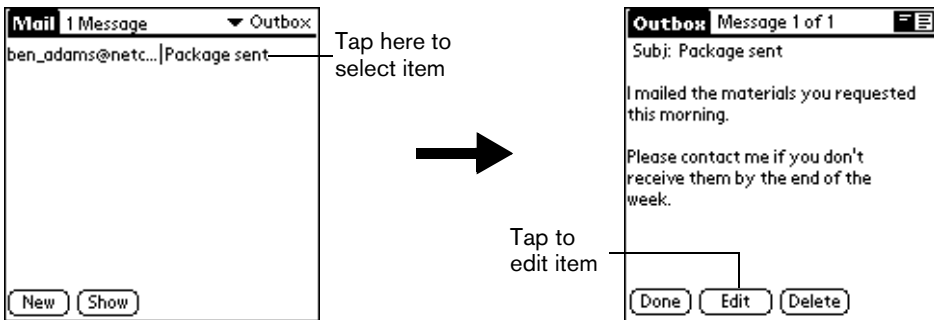

3. Tap Edit.

## Draft e-mail

Sometimes you may not want to send an e-mail item immediately; for example, you may want to add additional information before sending it. Your handheld stores such e-mail items in the Draft folder until you are ready to edit them again.

Note: When you're creating or editing an e-mail item, you can also save the item as a draft by canceling it. When you cancel an item, your handheld opens a dialog asking if you want to save the e-mail item. If you tap Yes, your handheld saves the item in the Draft folder.

To save an e-mail item as a draft:

1. Create an e-mail item.
2. Press Menu .
3. Under Message, select Save Draft (/W).

To edit an e-mail item saved as a draft:

1. In the Message list, tap Draft from the pick list in the upper-right corner.
2. Use the scroll buttons to select the draft you want to display.

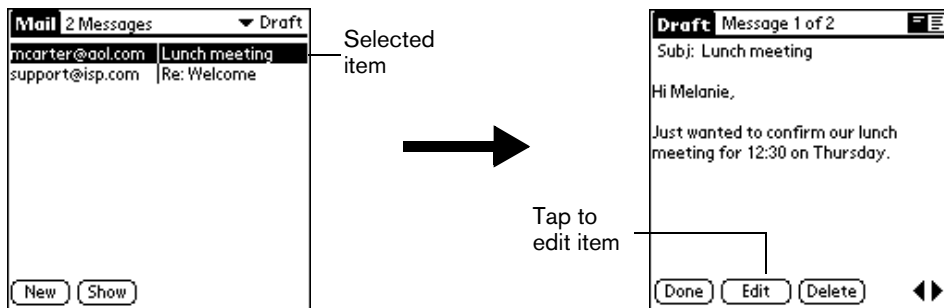

3. Tap Edit.
4. Enter your changes; then either save the e-mail item again as a draft, or tap Send to move the item to your Outbox folder.

## Filing e-mail

Your handheld can store e-mail you receive or create in the Filed folder. The contents of this folder do not automatically synchronize with your desktop e-mail application during a HotSync operation. Your handheld, however, stores a backup copy of the Filed folder on your computer hard disk.

To file e-mail:

1. Open an e-mail item.
2. Press Menu .
3. Under Message, select File (/I).
4. Tap No to save the e-mail item and move it to the Filed folder, or tap Yes to file the item and keep a copy in the Inbox.

To remove e-mail from the Filed folder:

1. In the Message list, tap Filed from the pick list in the upper-right corner.
2. Tap the e-mail item you want to restore.
3. Tap Edit to display and modify the item.

Tip: After you display and modify the e-mail item, you can send it, save it as a draft, or return it to the Filed folder.

## Deleting e-mail

Your handheld stores deleted e-mail in the Deleted folder until you perform the next HotSync operation. If you delete an e-mail item from the handheld, it is also deleted from your desktop e-mail application when you perform the next HotSync operation.

### To delete e-mail:

1. Open the e-mail item you want to delete.
2. Tap Delete.
3. If you selected the Preferences option to confirm deletion, tap Yes.

## Removing e-mail from the Deleted folder

You can reverse the deletion of an e-mail item (by removing it from the Deleted folder) as long as you have not performed a HotSync operation or purged the contents of the Deleted folder.

### To remove an e-mail item you received from the Deleted folder:

1. In the Message list, tap Deleted from the pick list in the upper-right corner.
2. Tap the e-mail item you want to restore.
3. Tap Undelete to move the selected item to the Inbox and mark it as read.

### To remove an e-mail item you created from the Deleted folder:

1. In the Message list, tap Deleted from the pick list in the upper-right corner.
2. Tap the e-mail item you want to restore.
3. Tap Edit to display and modify the item.

Note: After you display and modify the e-mail item, you can send it or save it as a draft.

## Purging deleted e-mail

Because your handheld stores deleted e-mail in the Deleted folder until you perform a HotSync operation, deleted e-mail can monopolize storage space. To avoid or correct this problem, purge the contents of your Deleted folder. E-mail that you purge is still deleted from your desktop e-mail application when you perform the next HotSync operation.

### To purge the contents of the Deleted folder:

1. Press Menu .
2. Under Message, select Purge Deleted (/E).
3. Tap Yes.

Note: You cannot restore e-mail items after you purge them.



# Message list options

Message list options enable you to manage the way the Message list displays information.

## Folders

Your handheld provides folders for categorizing your mail. The Message list displays the e-mail items in the folder you select.

To select a folder:

1. Tap the pick list in the upper-right corner to open the list of folders:

- Inbox** Contains the e-mail from your desktop e-mail application Inbox, minus any that you have excluded using filtering options. See page 187 for details.
- Outbox** Contains the e-mail you created and sent on the handheld since the last HotSync operation.
- Deleted** Contains the e-mail you deleted since the last HotSync operation.
- Filed** Contains the e-mail you want to store on the handheld.
- Draft** Contains the e-mail you created using the handheld but are not yet ready to send.

2. Select the folder you want to display in the Message list screen.



## Date column

The Date column is optional in the Message list. By default, the Date column is hidden to increase the available screen space.

To show the Date column:

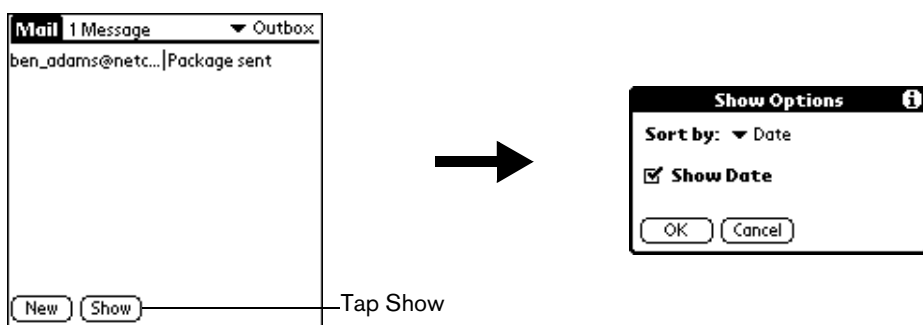
1. In the Message list, tap Show.



2. Tap the Show Date check box to select it.
3. Hold Option  and press Return  to finish.

# Sorting the Message list



You can sort e-mail items by the date sent, by sender, or by subject.

Note: High-priority e-mail items always appear first, no matter how you sort the list.

## To sort the Message list:

1. In the Message list, tap Show.
2. Tap the Sort by pick list and select one of the following options:

- Date** Sorts e-mail by date and displays the most recent e-mail item at the top of the screen.
- Sender** Sorts e-mail by the sender's user name and displays items in ascending alphabetical order, based on the first word of the From: field.
- Subject** Sorts e-mail by the subject and displays items in ascending alphabetical order, based on the first word of the Subj: field.

3. Hold Option  and press Return  to finish.

# Palm Mail HotSync options

Palm Mail's HotSync options enable you to manage your e-mail more effectively by selecting which e-mail items download when you synchronize your computer and your handheld. You can define different settings for local and remote synchronization. For example, you may want to download all of your e-mail during local synchronization and only urgent e-mail during remote synchronization. Once defined, your handheld determines if synchronization is occurring locally or remotely and uses the appropriate settings for the HotSync operation.

Note: The default setting is All. So, if your e-mail Inbox has lots of messages, synchronization could be time consuming.

## To open the HotSync Options dialog box:

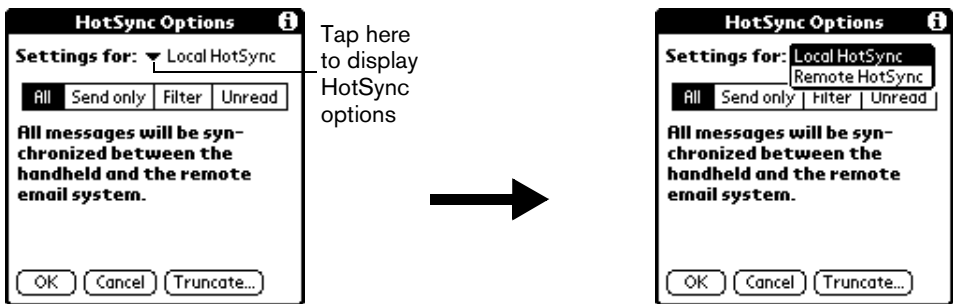

1. Press Menu .
2. Under Options, select HotSync Options (/H).
3. Tap the Settings for pick list and select Local HotSync or Remote HotSync.



4. Tap the filtering option you want to apply:

- All** During synchronization, all e-mail items in your desktop e-mail Inbox synchronize with your handheld, and all e-mail items in your handheld Outbox are sent to your desktop E-Mail application.
- Send Only** During synchronization, only the e-mail items in your handheld Outbox are sent to your desktop e-mail application; from there, they are sent to their destinations.
- Filter** During synchronization, all e-mail items in your handheld Outbox are sent to your desktop E-Mail application, and items in your desktop E-Mail Inbox that meet specific criteria download to your handheld. When you select the Filter setting, the HotSync Options dialog box opens and displays additional filter settings. See page 187 for details.
- Unread** During synchronization, only unread e-mail items download to your handheld from your desktop e-mail Inbox, and all items in your handheld Outbox are sent to your desktop e-mail application.

Note: The All setting does not mean that all information included in each e-mail item downloads to your handheld. Truncation settings (explained in a following section) for long e-mail items still apply. Also, Palm Mail never downloads any attachments to your handheld. The e-mail item and any text information appear, but the attachment is left in your desktop e-mail application.

5. If you selected All, Send only, or Unread, Hold Option  and press Return  to finish. If you selected Filter, continue to the next section.

## Creating special filters

You can create special filters to control the type of e-mail items that download to your handheld during synchronization. Special filters work on the premise of ignoring or retrieving items that contain specific information in their header fields.

To create a special filter, you must decide whether you want to ignore or retrieve certain e-mail items. Then, based on that decision, you must tell your handheld what it needs to look for in the To:, From:, and Subj: fields to single out those e-mail items.

To access the special filter settings:

- Tap the Filter box in the HotSync Options dialog box.

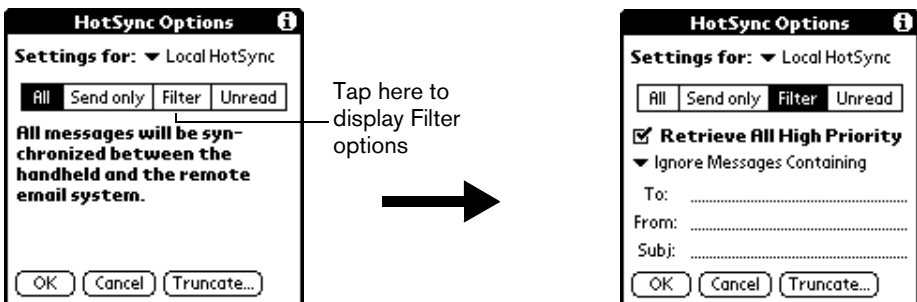

## Ignoring or receiving e-mail

The first step in establishing a special filter is to determine whether you want to ignore or retrieve e-mail that matches the information you specify.

To define whether to ignore or receive e-mail:

- Tap the pick list in the center of the HotSync Options dialog box and select one of the following settings:

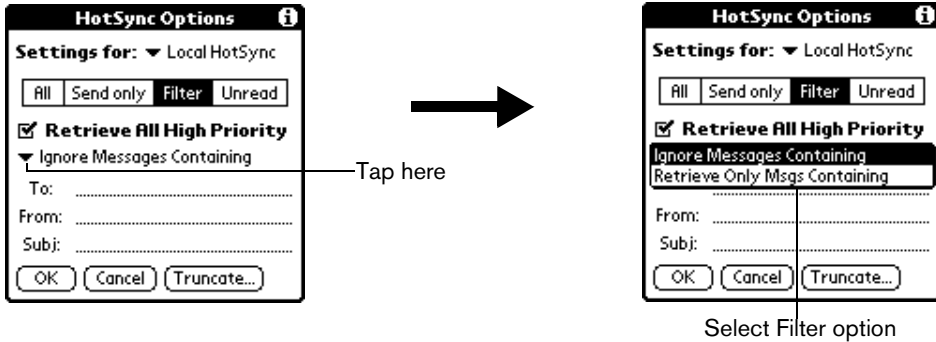

### Ignore Messages Containing

Tells your handheld to *exclude* the e-mail items that meet the criteria you define and download *all other e-mail items* during synchronization. In general, this filter downloads more e-mail during synchronization because it blocks only one defined subset of e-mail.

### Retrieve Only Msgs Containing

Tells your handheld to *include* only the e-mail items that meet the criteria you define and to ignore all other e-mail items during synchronization. This filter has the potential to block more e-mail during synchronization because it downloads only one subset of e-mail.

## Defining filter strings

E-mail items are filtered based on the information contained in their To:, From:, and Subj: fields. The information that defines what your handheld is looking for is called a *filter string*. You create a filter string by listing the words you want your handheld to find and separating them with either a comma or a space. Each word in the filter string is joined by an implicit OR, so you do not need to enter logical connectors like AND or OR.

To create a more complex filter, you can define filter strings for the To:, From:, and Subj: fields simultaneously. Your handheld joins the filter strings for these fields using an implicit AND; once again, you do not need to add the logical connector. Your handheld does that for you.

For example, suppose you want to receive only e-mail items from John Smith (jsmith@aol.com) or Jack Jones (jjones@aol.com) concerning the Apollo Project. You would create the following filter strings:

**In the To: field:** jsmith@aol.com, jjones@aol.com

**In the Subj: field:** Apollo Project

Your handheld interprets this as, "Accept e-mail items about the Apollo Project from John Smith or Jack Jones. Do not accept e-mail items from other people. Do not accept e-mail items from John or Jack about any other subject."

When you define a string, note that your handheld searches for any instance of that *sequence* of characters. For example, if you create a filter that retrieves only e-mail items containing the string "info," your handheld considers "info," "rainforest" and "kinfolk" appropriate matches.

To define a filter string:

1. Tap a header field in the HotSync Options dialog box.

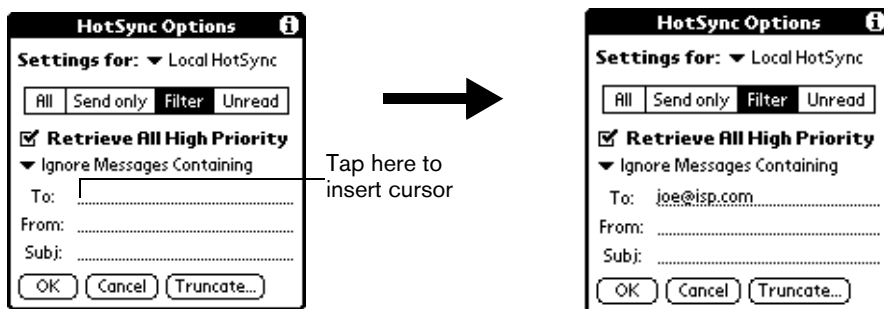

2. Enter your filter string, using commas or spaces to separate the words. Do not add connectors, such as AND or OR, between words in a string.
3. If your string exceeds the length of the field, tap the name of the field to display the Notes screen for that header field. For more information about header field Notes screens, see page 176 for details.

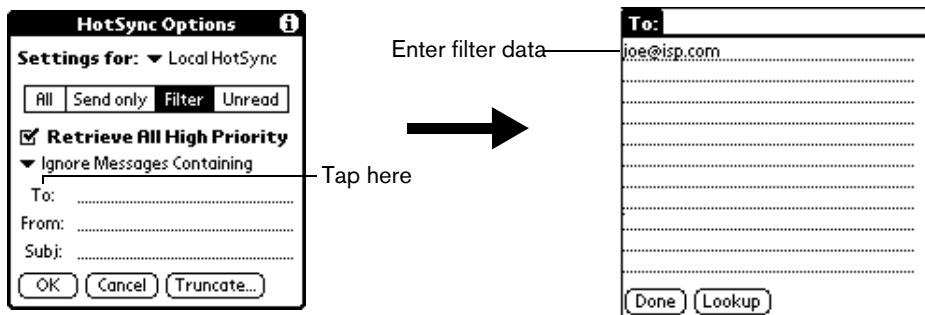

4. Hold Option  and press Return  twice to finish.

## High-priority e-mail

The Retrieve All High Priority setting lets you retrieve e-mail items marked high-priority, even if those items would have been blocked by a defined filter.

To retrieve high-priority e-mail items:

1. Tap the Filter box in the HotSync Options dialog box.
2. Tap the Retrieve All High Priority check box to select it.

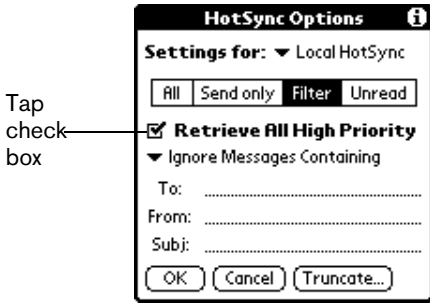

3. Hold Option and press Return to finish.

Note: This setting is applicable only if your e-mail application has the capacity to flag high-priority e-mail items.

## Truncating e-mail items

The Truncate feature lets you set a point at which long e-mail items truncate when downloading to your handheld. By default, this Truncate value is 4,000 characters. By truncating long messages, you reduce the time it takes to synchronize your desktop e-mail and Palm Mail, as well as the amount of storage space e-mail uses on your handheld.

Note: Truncation is separate and independent from filtering.

To truncate e-mail items:

1. Tap Truncate in the HotSync Options dialog box.

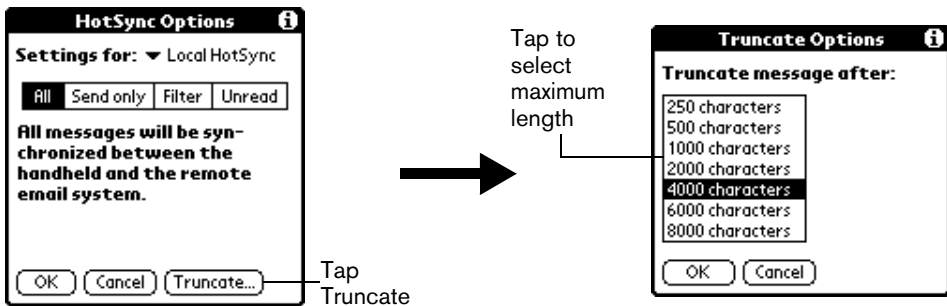

2. Tap to select the truncation setting you want.

Tip: If you select the maximum setting, messages can be 8,000 characters; longer messages are truncated. If you select a lower value, you'll have more room for e-mail items.

3. Hold Option and press Return to finish.

# Palm Mail menus

Palm Mail menus are shown here for your reference, and Palm Mail features that are not explained elsewhere in this guide are described here.

See page 29 for information about choosing menu commands.

## Message menus

The Message menu varies depending on whether you are viewing an e-mail item, creating an e-mail item, or viewing the Message list.

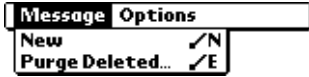

Message list



New Message

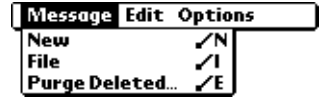

View Message

## Options menu

The Options menu varies depending on whether you are creating or editing an e-mail item.



Message list



New Message

### About Mail

Shows version information for Palm Mail.





## Chapter 9

# Using the Wireless Application Suite

This chapter provides information on how to use the applications and features that are specific to wireless data communication. The Wireless Application Suite includes the Blazer web browser, Palm SMS text messaging, and One-Touch Mail™ by JP Mobile e-mail application.

To use the Wireless Application Suite, you must have the following:

- A data-enabled mobile phone that is equipped with an IR port or a special cable that enables you to connect your mobile phone to your handheld.
- A wireless service provider that supports data services and it must be part of your service package (some wireless service providers may require you to sign up for data services separately).
- An account established with an ISP (Internet Service Provider). Many wireless service providers also provide ISP services. If ISP information is available from your wireless service provider when you configure your wireless communication settings with the Handspring CD-ROM, the installation program sets up your handheld for use with that provider.

### To install the Wireless Application Suite:

1. Insert the Handspring CD into the CD-ROM drive on your computer.
2. Complete step 1 of the installation process to install the synchronization software.
3. Proceed to step 2 of the installation process to install the Wireless Application Suite.
4. Follow the onscreen instructions to install the components you want to use.

# Preparing for mobile communications

After you install the Wireless Applications Suite software, you're ready to connect your handheld to your mobile phone and use it for mobile communication. You can connect your handheld and your mobile phone using infrared communication, or using a special cable.

**To connect your handheld to your mobile phone with infrared communication:**

1. Make sure infrared communication is enabled on your mobile phone.
2. Align the IR port on your handheld with the IR port on your mobile phone.

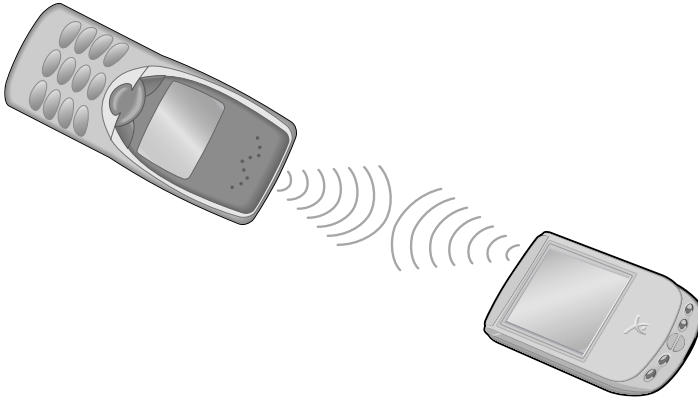

**To connect your handheld to your mobile phone with a special cable:**

1. Connect one end of the cable to your mobile phone.
2. Connect the other end of the cable to the connector on the bottom of your handheld.

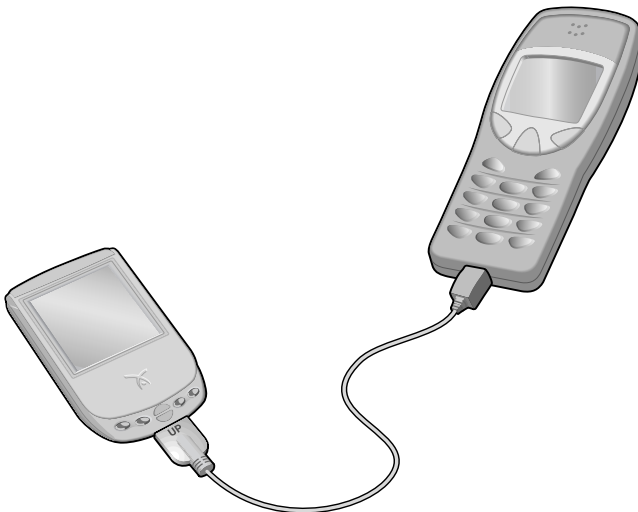

# Blazer Web Browser

If you can't hold the world in the palm of your hand, at least you can hold the World Wide Web when you use Blazer to browse the Internet on your handheld's screen.

In Blazer, you can do the following:

- Access the World Wide Web and display Internet content.
- Create up to 100 bookmarks for quick and convenient access to your favorite web sites.
- Navigate between web pages with familiar toolbar icons.





To use Blazer, you must subscribe to data services from your wireless service provider, and you must have an account established with an ISP (Internet Service Provider). Many wireless service providers also provide ISP services. If ISP information is available from your wireless service provider when you configure your wireless communication settings with the Handspring CD-ROM, the installation program will set up Blazer for use with that provider.

Note: If you already installed the desktop software from the Handspring CD-ROM but didn't configure the wireless communication settings, select Configure Wireless Suite under Handspring (or Palm) on the Windows Start menu, and follow the instructions on the screen.

## Viewing web pages

You can view web pages whenever you connect to your mobile phone via the IR port or a special cable. If you are outside a coverage area, you can view web pages that are stored temporarily on your handheld in an area called the "cache." However, if a page stored in the cache has an expiration date and it is past that date, you need to establish an Internet connection to view that page.

To view a web page:



1. Prepare your handheld and mobile phone for data communications. See page 194 for details.
2. Press Option  and then press Menu  to access the Applications Launcher.
3. Use the scroll buttons to select the Blazer icon .
4. Press Return  to launch the application.
5. Press Menu .
6. Under Go, select Go to Web Page (/G).



Tip: You can also tap the Folder icon  to open the Go to Web Page dialog box.



Folder icon



7. Enter the URL you want to view.
8. Hold Option  and press Return  to finish.
9. Tap Yes to connect now.

While a page is loading, a Progress icon  appears in the lower right corner of the screen. You can tap links to other pages as soon as they appear. You don't need to wait until a page fully loads. To stop loading a page, tap the Stop icon  in the lower left corner of the screen.



Tap to go to home page

10. To scroll through a page, do any of the following:
  - Press the scroll buttons on the front panel of your handheld.
  - Tap the onscreen arrows or scroll bar (if one appears).

**Tip:** To view a list of web sites that are optimized for your handheld, go to the home page, and then tap Directory of Mobile Sites.

## Working with bookmarks

The Bookmark view makes it easy for you to get to web sites you visit often.

### Viewing bookmarked pages

Your handheld may come with a few bookmarks already in place. You can jump directly to any of the predefined bookmarks, or to any pages for which you've created a bookmark.

To view a bookmark:

1. Prepare your handheld and mobile phone for data communications. See page 194 for details.
2. From the Page view, tap the Bookmark view icon .
3. Tap the bookmark you want to view.

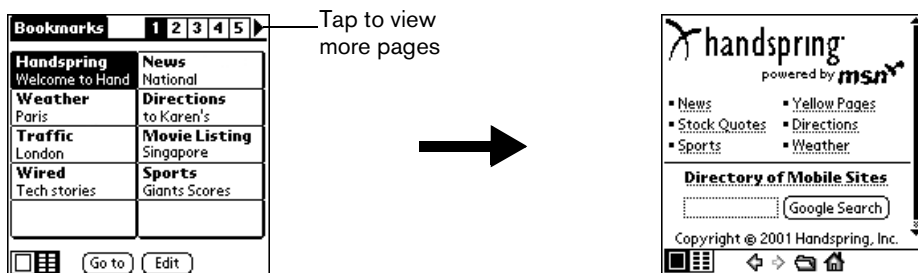

Tip: You can also press the scroll buttons to scroll to other pages.

## Adding bookmarks

You can store up to 100 bookmarks and group them in categories by placing similar links on the same bookmark page. See page 199 for information on creating page categories.

To bookmark the current page:

1. From the Page view, go to the page you want to bookmark.
2. Press Menu .
3. Under Page, select Add Bookmark (/A).

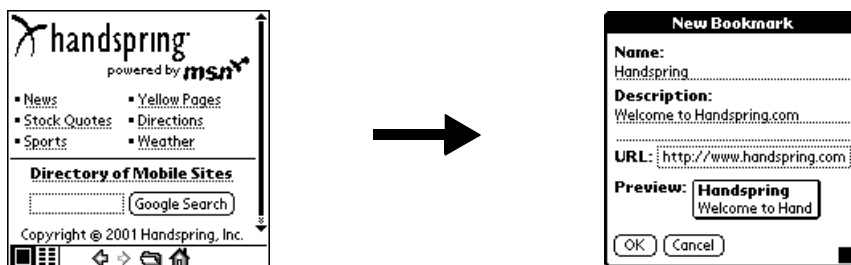

4. Hold Option  and press Return  to finish.

Tip: You can also add a bookmark by tapping an empty bookmark slot in the Bookmark view and entering a Name, Description, and URL for the page you want to bookmark.



**To define a bookmark:**

1. From the Bookmark view, press Menu .
2. Under Bookmark, select Add Bookmark (/A).

Tip: You can also open the New Bookmark dialog box by tapping an empty bookmark slot.

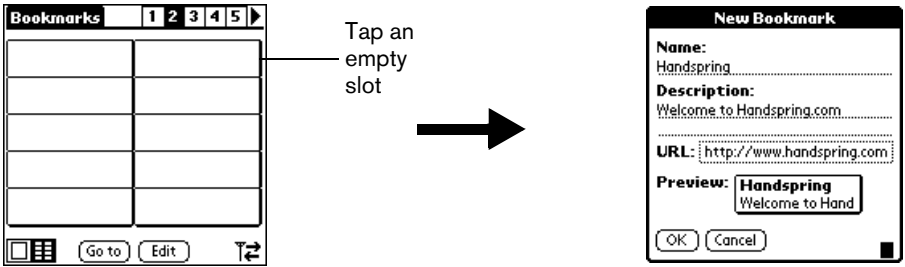
3. Enter a Name, Description, and URL for the page you want to bookmark.



4. Hold Option  and press Return  to finish.

**Editing bookmarks**

You can change the title, description, or URL associated with any of your bookmarks.

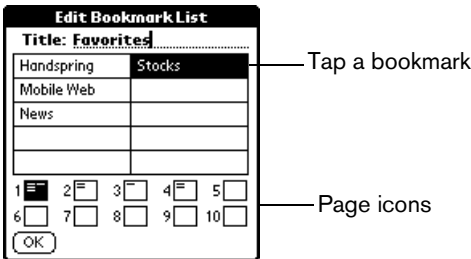

**To edit a bookmark:**

1. From the Bookmark view, press Menu .
2. Under Bookmark, select Edit Bookmark (/E).



3. Tap the page icons to navigate to the page containing the bookmark you want to change.



Tip: You can enter or change the Title for any bookmark page. Use the page Title to create bookmark categories. For example, if you want to create a page with links to various investments, you might name the page Assets.

4. Tap the bookmark you want to change.
5. Enter the changes.
6. Hold Option  and press Return  to finish.

## Deleting bookmarks

If your bookmark list becomes full, or you no longer need an entry, you can delete it.



### To delete a bookmark:

1. From the Bookmark view, press Menu .
2. Under Bookmark, select Edit Bookmark (/E).
3. Tap the entry you want to delete.
4. In the Edit Bookmark dialog, tap Delete.
5. Hold Option  and press Return  twice to confirm deletion.

## Arranging your bookmarks

As your bookmark list grows, you may want to rearrange the entries or move entire pages. You can assign a title to each bookmark page and arrange the entries by category. For example, if you want to create a page with links to various sports scores, you might name the page Scores.

### To assign page category titles:

1. From the Bookmark view, press Menu .
2. Under Bookmark, select Edit Bookmark (/E).
3. Tap the page icon to which you want to assign a title.
4. Enter the title.
5. Hold Option  and press Return  to finish.



### To rearrange bookmark entries:

1. From the Bookmark view, press Menu .
2. Under Bookmark, select Edit Bookmark (/E).
3. Drag the entries to the slot where you want them to appear.



Drag an entry to another slot or page

Tip: If the new slot is full, the other entries move down one slot as the rows fill from top to bottom. If you drag an entry to a page icon, the entry moves to the first available slot on that page.



4. Hold Option  and press Return  to finish.

To rearrange bookmark pages:

1. From the Bookmark view, press Menu .
2. Under Bookmark, select Edit Bookmark (/E).
3. Drag the page to the slot where you want it to appear.

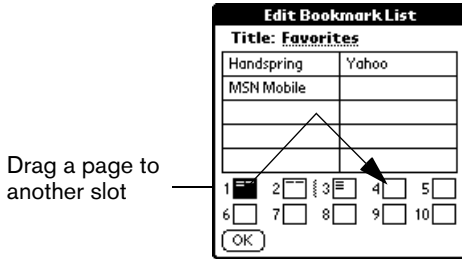
A grey line appears next to the page when it is in drag mode. When dropping a page on the top row, the grey line appears to the left of the slot where the page will appear. When dropping a page on the bottom row, the grey line appears to the right of the slot where the page will appear.



4. Hold Option  and press Return  to finish.

## Blazer menus

Blazer menus are shown here for your reference, and Blazer features that are not explained elsewhere in this guide are described here.

See page 33 for information about choosing menu commands.

The Go and Options menus differ depending on whether you're displaying the Page view or the Bookmark view.

### Page menu

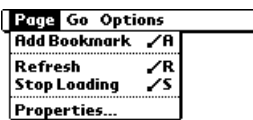

Page view

**Refresh** Enables you to update the current web page with the most up-to-date information.

**Stop loading** Cancels the process of loading a page.



**Properties** Displays the Page Properties dialog box where you can view the Page Name, URL, Size (Bytes) and whether the page was loaded from the cache.



## Bookmarks menu

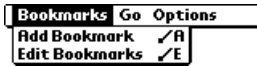

Bookmark view

## Go menus

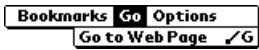

Bookmark view



Page view

## Options menu

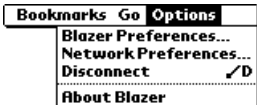

Bookmark view

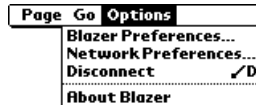

Page view

## Preferences

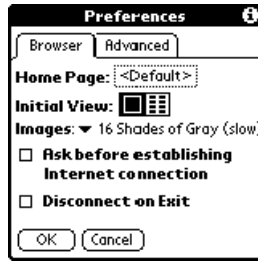

### Browser tab:

- Home page. Displays the URL of the current home page selection. Tap this option to open the Set Home Page dialog box and select a different home page. To restore the factory default Home Page setting, tap Restore in the Set Home Page dialog box.

Note: Some service providers may not support the default Home Page setting.

- Initial view. Determines whether the Page view or Bookmark view appears when you start the Blazer application. The default option is Page view.
- Images. Determines how many shades of gray are used to display graphic images. You can also choose to not display images at all. The options are: No Images (fastest), Black & White (faster), 4 Shades of Gray (fast), and 16 shades of Gray (slow). The default setting is 16 shades of Gray (slow).
- Ask before establishing Internet connection. Displays a confirmation dialog each time you begin an Internet session. The default setting for this option is on.
- Disconnect On Exit. Determines whether the Internet connection automatically closes when you exit the Blazer application. Leaving this option off enables you to switch to another application and then return to Blazer while you are still connected to the Internet. The default setting for this option is off.

## Preferences (continued)



### Advanced tab:

- **Cache Size (K).** Displays the amount of memory that Blazer reserves to store recently viewed pages. The amount of free memory available on your handheld appears below this option.
- **Clear.** Erases all the pages stored in the cache. You cannot cancel or undo this action.
- **Accept Cookies.** Enables the receipt of Internet cookies. The default setting for this option is on.
- **Clear Cookies.** Erases all the cookies stored on your handheld. You cannot cancel or undo this action.
- **Set Proxy.** Opens the Set Proxy dialog box where you can enter advanced HTTP proxy server settings. If your ISP or network requires you to go through a proxy server when you connect to the Internet, use this dialog box to enter the proxy server settings. Contact your ISP or system administrator for details.

**Disconnect** Terminates your connection to the Internet.

**About Blazer** Displays version information for Blazer.

# Palm™ SMS





Palm™ SMS provides a way for you to use your Treo and a GSM mobile phone to exchange short text messages with other people who also use GSM mobile phones and subscribe to an SMS service. These text messages, also called SMS (Short Message Service) messages, are similar to e-mail messages that you send and receive from your computer, but are limited to 160 characters in length. In addition to sending text, you can use Palm SMS to send and receive records from your handheld applications as an SMS message. Sending a record is similar to sending attachments with an e-mail message, but in the case of SMS, the data becomes the message, it isn't something extra you send with a text message.

In Palm SMS, you can do the following:

- Send and receive short text messages.
- Read incoming messages directly from the Inbox.
- Review messages you sent in the Sent folder.
- Send data from other applications including Contacts, Date Book Plus, Memo Pad, and To Do List

Note: The person receiving your SMS message must also have a GSM mobile phone and a wireless service provider that supports text messages. Some wireless service providers may use a different name for their text messaging service. Contact your GSM wireless service provider to see if their service is compatible with SMS.

To open Palm SMS:

1. Press Option  and then press Menu  to access the Applications Launcher.
2. Use the scroll buttons to select the Palm SMS icon .
3. Press Return  to launch the application.

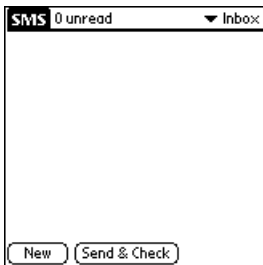

The SMS screen opens where you can access any of the following categories:

- Inbox** Stores incoming messages that you downloaded from your phone.
- Outbox** Stores messages waiting to be sent.
- Trash** Stores message which you've deleted. Deleted messages can be restored to their original category until you empty the trash.
- Archive** Stores messages you've read and want to keep.

**Draft** Stores messages you've created but are not ready to send. You can read or edit draft messages before sending them.

## Receiving SMS messages

When you receive SMS messages, they appear in the Inbox category. The icons to the right and left of the description indicate the item status and whether the message contains a data record.

Note: You can receive SMS messages even if you don't subscribe to your wireless service provider's SMS service.

To receive and view text messages:

1. Connect your handheld to your GSM mobile phone. See page 194 for details.
2. From any SMS list view, press Menu .
3. Under Message, select Check (/H).

Tip: You can also check for incoming messages and send any messages in your outbox simultaneously by tapping Send & Check.

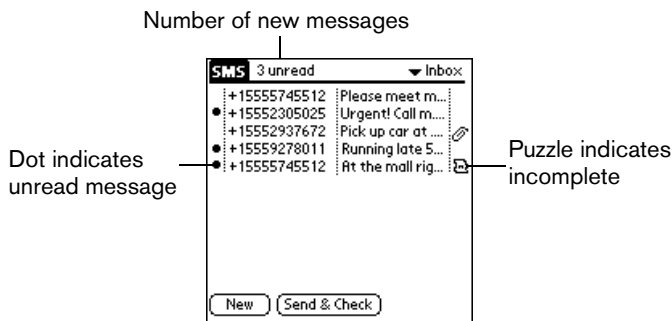

4. Use the scroll buttons to select the message you want to view.
5. Press Space  to open the message.
6. Tap one of the following buttons:

- Done** Saves the message in the Inbox category and marks the message as read.
- Reply** Opens the new message dialog box, and addresses the message to the person who sent you the message.
- Delete** Moves the current message to the Trash category.

### To receive and view data messages:

1. Connect your handheld to your GSM mobile phone. See page 194 for details.
2. From any SMS list view, press Menu .
3. Under Message, select Check (/H).

Tip: You can also check for incoming messages and send any messages in your outbox simultaneously by tapping Send & Check.

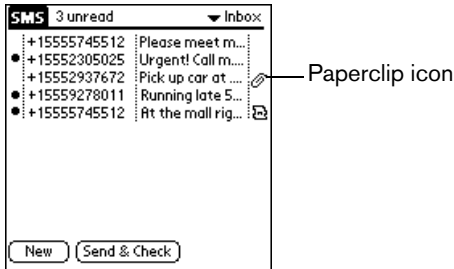

4. Use the scroll buttons to select a message that has a paperclip icon in the right column.
5. Press Space  to open the message.
6. In the Transfer dialog box, tap Yes to insert the record in the corresponding application, or tap No to view the record as text.

Note: When you view a data record as text, some characters may appear differently than in their native application.

## Creating text messages

Palm SMS enables you to create short text messages and send them to a GSM mobile phone number. If a message exceeds 160 characters, Palm SMS automatically divides the text into multiple messages when it sends the message. As you create a message, the status bar at the top of the screen indicates how many characters are in the current message.

### To create an SMS text message:

1. From any SMS list view, tap New.
2. Tap To.
3. Use the scroll buttons to select a name with a mobile phone number from your Contacts list, or enter a mobile phone number.

Note: Contact entries with mobile phone numbers appear with an (M) next to them in the Contacts list. Contact entries without a mobile phone number do not appear in the Lookup dialog box.

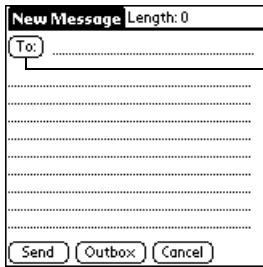

Tap To

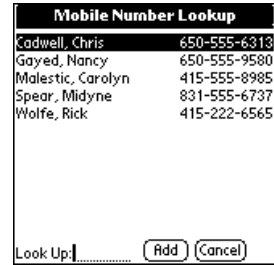

4. Enter the message text.
5. Connect your handheld to your GSM mobile phone. See page 194 for details.
6. Tap one of the following buttons

**Send** Sends the current message. If an error occurs, a message dialog box asks you if you want to save this message to the Outbox. To use this command, you must first connect your handheld to your GSM mobile phone. See page 194 for details.

**Outbox** Puts the current message into the Outbox so that you can send it later by using the Send menu command, or the Send & Check button. A dialog box informs you about this operation, and you can choose to not display the alert again.

**Cancel** Asks if you want to put the message into the Draft folder so you can view or edit it before sending it. Tap Yes to store the message in the Draft folder, tap No to delete the message.

When a message transmits successfully, a check appears next to it in the Outbox folder.

## Creating a message signature



You can create a signature of up to 80 characters. Then, when you create a message, you can insert your signature at the end of your messages.

To create a message signature:

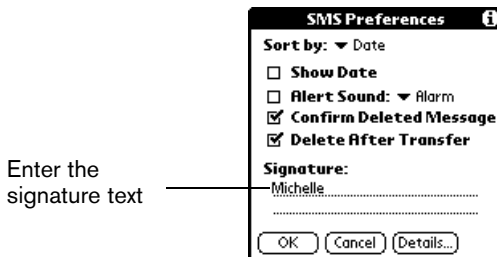
1. From any SMS list view, press Menu .
2. Under Options, select Preferences (/R).



Enter the signature text

3. Enter the signature text.
4. Hold Option  and press Return  to finish.

#### To add your signature to a message:

1. Create or open the message to which you want to add the signature.
2. Press Menu .
3. Under Options, select Add Signature (/Z).

## Sending data via SMS

You can also use Palm SMS to send and receive records from your handheld applications as an SMS message. Sending a record is similar to sending attachments with an e-mail message, but in the case of SMS, the data becomes the message, it isn't something extra you send with a text message.

If the recipient is using a Palm OS handheld, the recipient can insert the information directly in the native application, otherwise the information appears as text.

#### To send data via an SMS message:

1. Open the record you want to send.
2. Press Menu .
3. Under Record, select Send (/S).
4. Tap Lookup to select a name from your Contacts list  
Tip: You can also enter a mobile phone number, or tap To to select a recently used name.
5. Connect your handheld to your GSM mobile phone. See page 194 for details.
6. Tap Send.

## Modifying messages

You can modify any messages in the Draft category.

#### To store a message in the Draft category:

1. Create the message.
2. Do one of the following:
  - Press Menu , and under Message, select Draft (/D).
  - Tap Cancel, and then tap Yes.



To modify Draft messages:

1. In the Draft category, open the message you want to change.
2. Tap Edit.
3. Edit the message.
4. Tap one of the following buttons:

- Send** Sends the message. If an error occurs, a message dialog box asks you if you want to save this message to the Outbox. To use this command, you must first connect your handheld to your GSM mobile phone. See page 194 for details.
- Outbox** Puts the current message into the Outbox so that you can send it later.
- Cancel** Asks if you want to put the message into the Draft folder. Tap Yes to return the message to the Draft folder, tap No to delete the message.

## SMS Messaging menus

SMS Messaging menus are shown here for your reference, and SMS Messaging features that are not explained elsewhere in this guide are described here.

See page 33 for information about choosing menu commands.

### Message menus

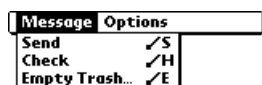

List view

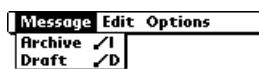

Message view

**Archive** Places the selected message in the Archive category.

**Send** Sends all message in the Outbox category.

**Empty Trash** Delete all message in the Trash category. This permanently removes the messages from your handheld.

### Options menus

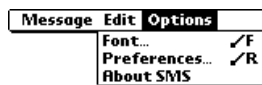

List views

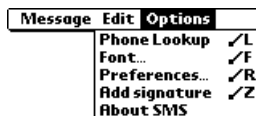

Message views

**Phone Lookup** Opens the Phone Lookup dialog box where you can select the recipient's mobile phone number.

## Preferences

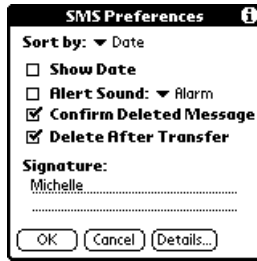

Sort by. Enables you to sort messages by Date, Type, Sender, or Content

Show Date. Toggles the display of the date on and off.

Alert Sound. Activates an alarm ring when you receive a new SMS message. Select the sound you want to play from the pick list.

Confirm Deleted Message. Displays a confirmation dialog box each time you delete a message.

Delete After Transfer. Deletes SMS messages with attachments after transferring the data to the corresponding application.

Signature. Enables you to define a signature that you can add to the end of a message while creating or editing it.

Details. Opens the Details dialog box where you can select the following options:



- Leave Messages on Phone. Enables you to choose if messages are automatically deleted from your phone after transferring them to your handheld. Clear this check box to keep messages on your phone after you transfer them to your handheld.
- Return Receipt. Enables you to choose whether to receive a notice confirming receipt of a message.
- Warn Over. Activates a warning when a multi-part message exceeds more than the selected number of parts.
- Expires. Enables you to indicate how long unsent messages remain in your Outbox.
- Message Center. Enables you to enter the number for your wireless service provider's SMS message center, or to read the number directly from the phone.

## About SMS

Shows version information for Palm SMS.

# One-Touch Mail

One-Touch Mail is a wireless e-mail application that enables you to access your ISP (POP3 account) e-mail directly from your handheld by using your data-enabled mobile phone to access the Internet. You may also be able to use One-Touch Mail to access your corporate e-mail; contact your System Administrator for assistance.

To install One-Touch Mail, do one of the following:

- Select the One-Touch Mail option when you configure the wireless communication features using the Handspring CD-ROM.
- If you already installed the desktop software from the Handspring CD-ROM but didn't install this application, select Configure Wireless Suite under Programs/Handspring (or Palm) on the Windows Start menu, and then select One Touch Mail when prompted to select an application to install.

For instructions on how to use One-Touch Mail, refer to the One-Touch Mail .PDF file located inside the Handspring\Wireless Suite\One-Touch Mail folder on your computer.



## Appendix A

# Maintaining Your Handheld

This chapter provides information on the following:

- Proper care of your Treo™ 90 handheld
- Maximizing battery life
- Resetting your handheld

## Caring for your handheld

Your handheld is designed to be rugged and reliable and to provide years of trouble-free service. Please observe the following general tips when using your handheld:

- Take care not to scratch the screen of your handheld. Keep the screen clean. When working with your handheld, use the supplied stylus or plastic-tipped pens intended for use with a touch-sensitive screen. Never use an actual pen or pencil or other sharp object on the surface of the handheld screen.
- Your handheld is not waterproof and should not be exposed to rain or moisture. Under extreme conditions, water may enter the circuitry through the front panel buttons. In general, treat your handheld as you would a pocket calculator or other small electronic instrument.
- The touch-sensitive screen of your handheld contains a glass element. Take care not to drop your handheld or subject it to any strong impact. Do not carry your handheld in your back pocket: if you sit on it, the glass may break.
- Protect your handheld from temperature extremes. Do not leave your handheld on the dashboard of a car on a hot day, and keep it away from heaters and other heat sources.
- Do not store or use your handheld in any location that is extremely dusty, damp, or wet.
- Use a soft, damp cloth to clean your handheld. If the surface of the handheld screen becomes soiled, clean it with a soft cloth moistened with a diluted window-cleaning solution.

## Battery considerations

Please note the following considerations when using the rechargeable battery in your handheld:

- Your handheld battery provides approximately 10 days of use between charges.
- You can conserve battery life by reducing the brightness of the backlight feature and by choosing a lower Auto-off setting which automatically turns the handheld off after a period of inactivity. See page 141 and page 16 for more information.
- If the battery becomes low in the course of normal use, an alert appears on the handheld screen describing the low battery condition. If this alert appears, connect your handheld to the HotSync cable or travel charger to charge the battery.

- If the battery drains to the point where your handheld does not turn on, it stores your data safely for about three days. In this case, there is enough residual energy in the battery to store the data, but not enough to turn on your handheld. If your handheld does not turn on when you press the power button, you should charge the battery immediately.
- If you leave a drained battery in your handheld for an extended period of time, you can lose all of the stored data. If this happens, charge the battery and then perform a HotSync operation to restore the data from your computer.

## Resetting your handheld

Under normal circumstances, you will not have to use the reset button. On rare occasions, however, your handheld may no longer respond to buttons or the screen. In this case, you need to perform a reset to get your handheld running again.

### Performing a soft reset

A soft reset tells your handheld to stop what it's doing and start over again. All records and entries stored in your handheld are retained with a soft reset. After a soft reset, the Palm Powered™ screen appears, followed by the Date & Time Preferences screen.

To perform a soft reset:

1. Unscrew the tip of the stylus to access the reset tool.

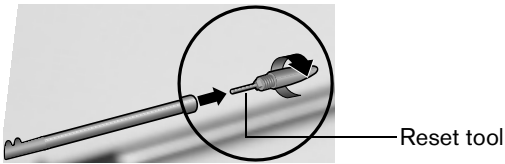

2. Use the reset tool to gently press the reset button inside the hole on the back panel of your handheld.

Tip: You can also use the tip of an unfolded paper clip (or similar object *without* a sharp tip).

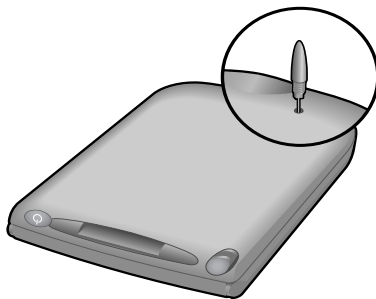

## Performing a warm (or safe) reset

A warm (or safe) reset bypasses system extensions on your handheld, such as HackMaster hacks or system patches. Performing a warm reset enables you to uninstall a third-party application that may be causing a problem.

### To perform a warm (or safe) reset:

1. Press and hold the top scroll button on the front panel of your handheld.
2. While holding down the top scroll button, use the reset tool (or similar object *without* a sharp tip) to gently press the reset button.
3. When the system screen appears, release the top scroll button.

## Performing a hard reset

*With a hard reset, all records and entries stored in your handheld are erased. Never perform a hard reset unless a soft or warm reset does not solve your problem.*

Note: You can restore any data previously synchronized with your computer during the next HotSync operation.

### To perform a hard reset:

1. Press and hold the power button on the top of the handheld.
2. While holding down the power button, use the reset tool (or similar object *without* a sharp tip) to gently press and release the reset button.
3. When the system screen appears, release the power button.
4. When a message appears on the handheld screen warning that you are about to erase all the data stored on your handheld, do one of the following:
  - Press the top scroll button on the front panel of your handheld to complete the hard reset and display the Digitizer screen.
  - Press any other button to perform a soft reset.

Note: With a hard reset, the current date and time are retained. Formats Preferences and other settings are restored to their factory default settings.

5. If the language selection screen appears, select the same language you selected for your desktop software. *Choosing a different language may result in loss of data.*

## To restore your data after a hard reset:

1. Click the HotSync Manager icon ™ in the Windows system tray (bottom-right corner of the taskbar).

Tip: You can also click the HotSync command on the Palm Desktop software menu bar.

2. From the HotSync Manager menu, choose Custom.

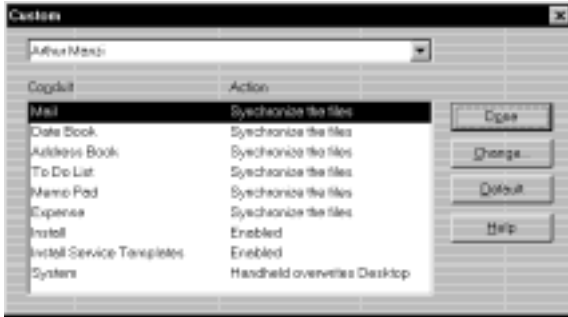

3. Select the appropriate user name from the list.
4. Select an application in the Conduit list.
5. Click Change.



6. Select Desktop overwrites handheld.

Note: Changing the HotSync setting from the default affects only the *next* HotSync operation. Thereafter, the HotSync Actions revert to their default settings.

7. Click OK.
8. Repeat steps 4 through 7 to change conduit settings for other applications.
9. Click Done to activate your settings.
10. Perform a HotSync operation.



## Appendix B

# Troubleshooting Tips

If you encounter a problem with your Treo™ 90 handheld:

- Review this section to see if your problem is listed
- Check our web site at [www.handspring.com](http://www.handspring.com) for the latest technical support information

Note: Thousands of add-on applications have been written for Palm OS® devices. Unfortunately, we are not able to support such a large number of non-Handspring software applications. *If you are having a problem with a non-Handspring application, please contact the developer or publisher of that software.*

## Software installation problems

### Problem

Palm™ Desktop software will not install successfully.

### Solution

Disable any anti-virus software, close any open applications or utilities, and then perform the installation again.

If you are installing on a computer at your workplace, make sure your System Administrator grants you the rights to install software.

If you are still having problems installing the Handspring software, try these steps:

1. Download the latest version of the software from the Customer Support or Product Support section of [www.handspring.com](http://www.handspring.com).
2. Restart your computer in "safe mode." In most versions of Windows you can do this by pressing F8 on the keyboard as the computer boots.
3. Install the file you downloaded in step 1. If the installation finishes, restart your computer in the normal operating mode and start using Palm Desktop software.

# Operating problems

## Problem

My handheld won't turn on.

## Solution

Try each of these in turn:

- Adjust the contrast settings.
- Make sure the battery is fully charged.
- Perform a soft reset. See page 214 for details.
- If your handheld still does not operate, try a hard reset. See page 215 for details.

My handheld keeps turning itself off.

Your handheld is designed to turn itself off after a period of inactivity. This period can be set at one, two, or three minutes. Check the Auto-off setting. See page 141 for details.

My handheld has frozen.

This is most commonly attributed to conflicts with non-Handspring software. Try each of these in turn:

- Perform a soft reset. See page 214 for details.
- Delete any application you recently installed. See page 42 for details.
- Perform a warm reset. See page 215 for details.
- Perform a hard reset. See page 215 for details.
- Adjust the contrast settings.
- Charge the battery.
- Perform a soft reset.

I don't see anything on my handheld's screen.

# Tapping and keyboard problems

## Problem

When I tap the buttons or screen icons, it activates the wrong feature.

## Solution

Calibrate the screen. See page 140 for details.

When I press Menu , nothing happens.





Not all applications or screens have menus. Try changing to a different application.

# Wireless communication problems

## Problem





The Blazer® application won't connect to the Internet

## Solution

- Confirm that your wireless service plan includes data services and not just voice minutes.
- If you're using an infrared connection, make sure the infrared port on your mobile phone is enabled. If you're using a cable connection, make sure the cable is securely attached to your mobile phone.
- Check with your Internet Service Provider to confirm that your Network Preferences settings are properly configured.
  1. Press Option  and then press Menu  to access the Applications Launcher.
  2. Use the scroll buttons to select the Preferences icon .
  3. Press Return  to launch the application.
  4. Select Network from the pick list in the upper-right corner.
  5. Check your Username, Password, and the phone number. The phone number should be the number you use to dial-in to your ISP.
  6. Tap Connect. If the Connect button changes to a Disconnect button after the connection dialogs finish, your Network Preferences settings are working. If the Connect button does not change, tap Details and enter DNS and IP address information for your Internet Service Provider.

Important: AOL users must download AOL for Palm from [www.aol.com/anywhere/pda/palm/palmaol](http://www.aol.com/anywhere/pda/palm/palmaol) to retrieve e-mail. AOL does not support web browsing with Blazer.

The Palm SMS application doesn't work

- Make sure you have a GSM mobile phone.
- Make sure you installed the proper Palm OS phone driver:
  1. Press Option  and then press Menu  to access the Applications Launcher.
  2. Use the scroll buttons to select the Preferences icon .
  3. Press Return  to launch the application.
  4. Select Phone from the pick list in the upper-right corner.
  5. Confirm that the model listed under Connection matches your GSM phone and the connection method you plan to use (infrared or cable).
  6. Tap Test.

Some phone numbers don't appear in the SMS Lookup

Make sure the number you want is identified as a mobile number in your Contacts list. Only mobile phone numbers appear when you use the SMS Lookup feature.

I can't send SMS messages

- Check the SMS Preferences dialog under Options in the SMS application and confirm that the SMS Message Center number on this screen is correct.
- Check with your wireless service provider to confirm that your wireless service plan includes SMS.

Note: Receiving SMS messages does not indicate that you have a subscription to your wireless service provider's SMS service. You must subscribe to this service to send or reply to messages.
- Verify that you are in a GSM coverage area.
- Make sure the destination number is correct. Some wireless service providers require 11-digit phone numbers for SMS messages.

# Application problems

## Problem

I tapped the Today button, but it does not show the correct date.

I know I entered some records, but they do not appear in the application.

I am having problems listing memos the way I want to see them.

I created an event in Date Book Plus, but it doesn't appear in the Week View.

## Solution

Your handheld is not set to the current date. Make sure the Set Date box in the Date & Time Preferences screen displays the current date. See page 22 and page 141 for details.

- Check the Categories pick list (upper-right corner of the screen). Choose All to display all of the records for the application.
  - Check Security and make sure that the Private Records setting is set to Show private records.
  - In To Do List, tap Show and check whether Show Only Due Items is selected.
  - If you cannot manually arrange the order of the memos in the list screen, check the Memo Preferences setting. Make sure that Sort by is set to Manual.
  - If you choose to view your memos alphabetically on Palm Desktop software and then perform a HotSync<sup>®</sup> operation, the memos on your handheld still appear in the order defined in the Memo Preferences setting. In other words, the sort settings that you use with Palm Desktop software *are not* transferred to your handheld.
- In the Week View, you cannot select overlapping events that have the same start time. If you have two or more events with the same start time, choose the Day View for the particular day to see the overlapping events.

# HotSync problems

## Problem

Why can't I synchronize my handheld with my computer?

## Solution

Try each of these in turn. After each step, try to synchronize to see if the problem persists:

- Make sure you installed the software that came with your handheld. You must install this software even if you upgraded from another Palm OS handheld.
- Make sure you selected your user name in Palm Desktop software before beginning the HotSync operation.
- Perform a soft reset. See page 214 for details.
- Make sure the HotSync Manager icon ™ appears in the Windows system tray in the lower-right corner of the screen. If it does not appear, open the Start menu, select Programs, Handspring, and then HotSync Manager.
- Click the HotSync Manager icon and make sure that the Local USB option has a check next to it. If you are using an optional serial cable, make sure that the Local Serial has a check next to it, then select Setup and confirm that the COM port setting matches the port where you attached the serial cable.
- Make sure the cable is connected securely to your computer and your handheld.
- Make sure you are using the correct type of cable. If your computer does not have a USB port, or is running Windows 95 or Windows NT 4.0, you must use a serial cable.
- If you're using a USB cable, navigate to the Handspring program group and select the Handspring USB utility.
- If you are using a USB cable, disconnect any other USB devices you are using. If you're connecting your cable to a USB hub, disconnect it and connect your cable directly to your computer.
- If you are using a serial cable, try a lower baud rate setting on the Local tab in the Setup dialog box.
- Restart your computer.
- If you installed a conduit from a non-Handspring software developer, contact the developer for support.

I did a HotSync operation, but one of my applications did not synchronize.

Click the HotSync Manager and choose Custom. Make sure that the conduit appears on the list and that it is set to Synchronize the files. See page 159 for details.

I cannot launch the HotSync Manager.

- Make sure you are not running another program, such as America Online, CompuServe, or WinFax, that uses the port you selected in the Setup dialog box.
- Reinstall the Palm Desktop software.

I am using Outlook as my PIM, but I cannot do a HotSync operation.

- Click the HotSync Manager and choose Custom. Make sure that the following Outlook conduits are installed and that the Action is set to "Synchronize the files" for each conduit: Outlook Contacts, Outlook Calendar, Outlook Tasks, and Outlook Notes.
- Reinstall the Palm Desktop software and make sure you select the option to synchronize with MS Outlook.

## Beaming problems

### Problem

I cannot beam data to another IR-equipped Palm OS device.

When someone beams data to my handheld, I get a message telling me it is out of memory.

### Solution

- Confirm that your handheld and the other device is clear of obstacles.
- Check the General Preferences screen and make sure the Beam Receive setting is on.
- Move your handheld closer to the receiving device.
- Move your handheld farther away from the receiving device.
- Angle the sides of the two devices towards each other.
- Perform a soft reset. See page 214 for details.
- Your handheld requires at least twice the amount of memory available as the data you are receiving. For example, if you are receiving a 30K application, you must have at least 60K free.
- Perform a soft reset. See page 214 for details.

# Password problems

## Problem

I forgot the password, and my handheld is not locked.

## Solution

You can use Security to delete the password. If you do this, your handheld deletes all entries marked as private. You can, however, perform a HotSync operation *before* you delete the password: the HotSync process backs up all entries, whether or not they are marked private. In this case, the following procedure restores your private entries and lets you access them:

1. Use the Palm Desktop software and the cable to synchronize your data.
2. Tap Forgotten Password in Security to remove the password and delete all private records.
3. Perform a HotSync operation to synchronize your data and restore the private records by transferring them from your computer to your handheld.

I forgot the password and my handheld is locked.

If you assign a password and lock your handheld, you must perform a hard reset to continue using your handheld. See page 215 for details.

## Technical support

If you cannot solve your problem after reviewing the sources listed at the beginning of this appendix, check our web site [www.handspring.com](http://www.handspring.com) for the latest technical support information.

Before requesting support, please experiment a bit to reproduce and isolate the problem. When you do contact support, please be ready to provide the following information:

- The name and version of the operating system you are using
- The actual error message or state you are experiencing
- The steps you take to reproduce the problem



## Appendix C

# Creating a Custom Expense Report

This section explains how to modify existing Expense application templates and how to create your own custom expense report templates for use with the Expense application.

**Note:** This section assumes that you are familiar with Microsoft Excel or a similar spreadsheet application. If you are not familiar with Microsoft Excel, consult your company's Information Services department or another experienced user.

## About mapping tables

Before creating or modifying an Expense template, it's important to understand the function of the Palm™ Desktop software Expense application. In simple terms, the Expense application moves Expense data from your handheld into a Microsoft Excel spreadsheet.

Each Expense item stored in your handheld represents a group of related data. You can link the following data to an expense item:

- Category
- Date
- Expense Type
- Amount
- Payment Method
- Payment Currency
- Vendor
- City
- Attendees
- Note

When you perform a HotSync® operation between your handheld and Palm Desktop software on your computer, the Expense data is stored on your computer (in a file named Expense.txt). When you open the Expense application in Palm Desktop software, an Excel macro starts, and populates an expense template with your data based on the rules specified in a spreadsheet file named Matable.xls.

The Matable.xls file is an editable spreadsheet that functions as a "mapping table." The function of the mapping table is to guide the Excel macro in extracting the Expense data. The mapping table tells the Excel macro how large the spreadsheet is and provides the data-cell layout of the Excel template used for the Expense Report.

## Customizing existing sample templates

Four sample Expense Report templates come with Palm Desktop software. These templates are stored in the Template folder (which is in the same folder as the Palm Desktop software application).

If the layout of one (or more) of these templates is appropriate for your reporting needs, you can easily customize the templates with your company name and other information.

## To customize a sample Expense Report template:

1. Make a backup copy of the contents of the Template folder.



2. Double-click the name of the sample template you want to modify to open it in Microsoft Excel.
3. Make any changes that you want to the names (or other information) in the sample template.

**Important:** *Do not* insert rows or columns in the sample template. Doing so changes the way your Expense data maps to the template and causes errors. If you want to move the cells to a different location or add or delete rows or columns, you have to make changes to the Mappable.xls file.

**Note:** You can insert your own company logo without changing the Mappable.xls file. If you change the file name, however, you need to make a corresponding change in the Mappable.xls file.

You can also rename cells without changing the Mappable.xls file, provided that the expense type corresponds to your handheld data. For example, you can change "Snack" to "Munchies," and then all items entered on your handheld as "Snack" map to the cell(s) labeled "Munchies."

4. From the File menu, choose Save As.
5. Click the Save as type drop-down list and choose Template (\*.xlt).
6. Navigate to the Template folder (in the Palm Desktop software directory).

**Note:** If you *do not* need to change the Mappable.xls file, save the template file with its *original file name* (e.g., Sample2.xlt).

If you *do* need to change the Mappable.xls file, give your modified template a unique name. Be sure to use the .xlt file suffix, which defines the file as a Microsoft Excel template.

7. Click Save to save your modified template and make it available for future use.

**Note:** If you need to modify the Mappable.xls file, you must do this before you can use the modified template with your Expense data. To modify the Mappable.xls file for your new template, see page 228 for details. *Read all of the sections of this appendix before making changes to the Mappable.xls file.*

# Determining the layout of the Expense Report

This section describes the layout considerations for the Expense Report and explains the terms used for creating the report.

## Labels

There are two kinds of labels that you need to define for your report: day/date and expense type. Each kind of label can be either Fixed or Variable. A Fixed label means that the label *always* appears as a header at the beginning of a row or column. If a label is not Fixed, it is variable.

For example, a list table of expenses could have variable labels in the rows for day/date, and variable labels in the columns for expense type. In this case, neither day/date or expense type information would be “fixed” (as a header). Instead, the date and expense type information would be filled into the cells of the spreadsheet as appropriate.

Examples of both Fixed and Variable labels appear in the sample expense templates.

## Sections

A Section is an area of the report that has common formatting. It is common for an Expense report to have more than one Section. For example, the following sample Expense Report named Sample3.xlt contains several Sections.

The screenshot shows an Excel spreadsheet with the following structure:

- Row 1: Menu bar (File, Edit, View, Insert, Format, Tools, Data, Window, Help)
- Row 2: Column headers (1-10)
- Row 3: Expense Report header with fields for Employee, Date, Dept., and Period.
- Row 4: Section header "Expense Report"
- Row 5: "DATE" header
- Row 6: "ITINERARY" header with "CITY" sub-headers
- Row 7: "CITY" header
- Row 8: Section 1 (not prepaid) - includes rows 9-18 with expense types like Breakfast, Lunch & Snack, Dinner, Business meals & entertainment, Conference.
- Row 19: Section 2 (prepaid) - includes rows 20-26 with expense types like Postage, Parking & Tolls, Gifts, Tips, Suppl, Incidentals, Other.
- Row 27: Section 3 header "BUSINESS MEALS AND ENTERTAINMENT EXPENDITURES"
- Row 28: Section 3 sub-headers (Date, Expense Type, Amount, Vendor, Car)
- Row 29: Section 3 data headers
- Row 30: Section 3 data rows

Callouts point to:

- Section 1 (not prepaid) - points to rows 9-18
- Section 2 (prepaid) - points to rows 20-26
- Section 3 - points to rows 27-30

Because your Expense data maps to row and column areas of your final report, different Sections require different definitions for the data mapping. To create additional Sections with different mapping, you create corresponding additional lines to the mapping table file named Maptable.xls. This procedure is explained later in this appendix.

If a section contains cells for prepaid (company paid) expenses, you need to create an additional line in the mapping table for “prepaid.” This will count as an additional section in the mapping table. The only data that differs in the prepaid section (from the non-prepaid section) is the row/column numbers for the expense type.

# Analyzing your custom Expense Report

If you already have a custom Excel expense report, you can use it with a modified mapping table. However, before you can create a Mappable.xls file that corresponds to your custom Expense Report, you must first analyze the characteristics of your report.

**Perform the following before you begin a custom mapping table:**

- Print a copy of your custom expense report. Activate the Row and Column Headings option in the Sheet settings of the Page Setup command. This enables you to quickly determine the size of the Section(s), as well as the numbers for the start rows and columns.
- On the printed copy, identify the data Sections. A Section is an area of data with common row and column formatting. A yellow highlighter marking pen can make it easy to see the Sections as you work with programming the mapping table. Your custom Expense Report can contain any number of Sections, and the same data can be repeated in any Section.
- On the printed copy, identify the type of Labels that apply to each Section. Each Section can have only one kind of Fixed or Variable Label for rows. Likewise, each Section can have only one kind of Fixed or Variable Label for columns.
- Place a copy of your custom Expense Report in the Template folder (in the Palm Desktop software directory). Change the file name so it has the file extension .xlt (which defines it as a Microsoft Excel template). Make a note of the exact file name so it can be defined in the mapping table file.

## Programming the mapping table

Once you have analyzed the components of your custom Expense Report, you can program the mapping table to fill the report with data from the handheld.

**To program a new custom mapping table:**

1. Open a copy of the Mappable.xls file in Microsoft Excel.

**Note:** This file is located in the same folder as the Palm Desktop software application. *Make a backup copy of this file before you make your modifications.*

2. Mapping a new template. Scroll to where you find the name of the original template that you chose for your modifications. The name of the template will appear in column B of the Mappable.xls file, next to the cell highlighted in green that reads "Template Name:". If you did not modify an existing template, move to any table in the Mappable.xls file.
3. Select all the rows associated with the template name. To select the rows, click and drag on the row numbers (left side), so they appear highlighted.

	1	2	3	4	5
5	Template Name:	SAMPLE1.XLT			
6		ROW			
7		Fixed Label		Variable Label by	
8		Day/Date	Expense Type	Day/Date	Expense Type
9	Section1			X	
10					
11					
12					
13	Template Name:	SAMPLE2.XLT			
14		ROW			
15		Fixed Label		Variable Label by	
16		Day/Date	Expense Type	Day/Date	Expense Type
17	Main		X		
18	Business&Entertainment			X	
19					
20					
21					
22	Template Name:	SAMPLE3.XLT			
23		ROW			
24		Fixed Label		Variable Label by	
25		Day/Date	Expense Type	Day/Date	Expense Type
26	Main (PREPAID)		X		
27	Main		X		

All rows related to template are selected

- From the Edit menu, choose Copy.
- Scroll down to a blank area of the Maptable.xls file (below the rows used for Sample4.xlt), and click on a row number to select a blank row.
- From the Edit menu, choose Paste. A copy of the rows you selected in step 3 is pasted into the Maptable.xls file.
- Name the table. In the cell immediately to the right of the cell entitled Template Name, enter the *exact* file name of your custom Expense Report template.
- Define the number of Sections. Each row in a table defines how your handheld data will be placed in a Section of your custom Expense Report. Note that the prepaid portion of a section has its own row and counts as a separate section for map table purposes, *even though it is not a separate section in your template*.

22	Template Name:	SAMPLE3.XLT			
23		ROW			
24		Fixed Label		Variable Label by	
25		Day/Date	Expense Type	Day/Date	Expense Type
26	Main (PREPAID)		X		
27	Main		X		
28	Business Meals & Entertainment				
29	Mileage Log				

Table with four sections

You may add or delete rows as necessary so that the total number of rows corresponds to the number of Sections in your custom Expense Report. To clear all of the existing settings in a row, click to select the row and press Ctrl+Delete. Name each row to correspond to a Section of your custom Expense Report.

- Determine the Label settings. The orientation of the data fields (Row, Column) appears in the yellow section of the table.

SAMPLE LIST							
ROW				COLUMN			
Fixed Label		Variable Label by		Fixed Label		Variable Label by	
Day/Date	Expense Type	Day/Date	Expense Type	Day/Date	Expense Type	Day/Date	Expense Type
		X					X

Determine whether the Rows will contain expense or date information, and place an "x" in the appropriate cell. When you do this, you also define whether the label is Fixed or Variable. You can place only one "x" in the Row section (columns 2–5).

Determine whether the Columns will contain expense or date information, and place an "x" in the appropriate cell. When you do this, you also define whether the label is Fixed or Variable. You can place only one "x" in the Column section (columns 6–9).

- Define the dimensions of the Section. The dimensions of the Section appear in the green columns (10–13).

# of Rows	# of Columns	Start Row	Start Column
36		12	1

**# of Rows** Represents the total number of rows in the Section, excluding any header or total rows. In other words, this includes only the number of rows in the Section where your handheld data will be placed.

**# of Columns** Represents the total number of columns in the Section, excluding any header or total columns. In other words, this includes only the number of columns in the Section where your handheld data will be placed.

**Start Row** Is the number of the first row of the Section that will be filled with your handheld data.

**Start Column** Is the number of the first column of the Section that will be filled with your handheld data.

- Define the Dates and Intervals. The dates and intervals between dates appears in the light blue columns (14–17).

Date	Intervals Between		
Date	Dates	Start day	Day
1	0		

In the Date cell, enter the row or column number where all the date information will be placed.

In the Dates cell, enter the number of blank columns (or rows) separating the date fields. If there are no blank columns (or rows) between date entries, leave this number set to zero.

In the Start Day cell, enter the day of the week that starts the expense reporting period. Enter a three-character abbreviation for the day (e.g., Sun, Mon, Tue).

In the Day cell, enter the row or column number where all the day information will be placed. If the dates are in a row or in a column, enter the row or column number.

- Define whether the Section is in list format. This setting appears in the light purple columns (18–19).

<b>Listing Format</b>	<b>Expense Type</b>
YES	8

If the Section will present the data in a list format, enter the word "yes". Otherwise, enter the word "no". The following diagram shows data presented in a list format:

6	Date	Category	Type	Amount	Country	Payment Type
7						
8						
9						
10						
11						

Only if your section is in list format: In the Expense Type cell, enter the number of the row or column where the expense description will be placed. Expense amounts can be entered in several different columns or rows if required by your template. *Expense type labels* must all appear in the same column.

- Enter the row or column numbers for the expense types that appear in the Section. These settings appear in the aqua columns (20–48).

Expense Types					
Before	Breakfast	Bus	Business Meals	Car Rental	Dinner
4	4	4	4	4	4

For these settings, simply enter the row or column number for the expense types that you want to appear in the Section. Note that the same row or column number can be used more than once. An example of this would be meals that encompass breakfast, lunch, dinner, and snacks. In the previous example, all expense items would be populated into row/column 4 of the custom Expense Report.

- Complete the table. All of the remaining columns (49–57) in the table are used to define the column or row number that corresponds to the description.
- Mark a Section for prepaid expenses (yellow column). If a row in the map table is for prepaid (company paid) expenses, type a "yes" in the cell on that Section's row. Type "no" in all the cells of this column that do not pertain to prepaid expenses.

NO
PrePaid
NO
YES
NO

- Repeat steps 9 through 15 for each Section you defined for your custom Expense Report.
- Map Expense Report Options dialog (magenta section). The Expense Report Options dialog has five fields where you can fill in data for the header on your expense report. Use this section to specify the row and column on your template where this information is mapped.

Employee Name		Department	
Header 1/Row	Header 1/Col	Header 2/Row	Header 2/Col
2	5	2	3

Because header data is not related to any particular Section, you have to fill in only one row. If the item does not appear on your template, leave these cells blank.

# Using applications other than Microsoft Excel

You can use applications other than Microsoft Excel (such as Lotus 1-2-3 or Quattro Pro) to open and manipulate the Expense data on your computer. The data file is named "Expense.txt," and is stored in the Expense folder, within the folder containing the handheld user data.

Expense data in the Expense.txt file is in tab-delimited format.

## Expense file details

The Expense.txt file contains four groups of data. It will be easier to see these four distinct groups of data if you open the file with a spreadsheet application.

<b>Trips</b>	Shows the number of Expense application categories, and lists each one followed by an "end" statement.
<b>Currency</b>	Shows how many currencies were used for the Expense data, and lists the countries that correspond to that currency.
<b>Trip</b>	Shows the number of expenses by category, and lists the expenses for each category.
<b>Expenses</b>	Shows the total number of expenses, and lists them chronologically.



## Appendix D

# Non-ASCII Characters for Login Scripts

The following information enables you to create custom login scripts that require non-ASCII characters. It is provided for advanced users who understand the use and requirements of such characters in a custom login script.

## Use of ^char

You may use the caret ( ^ ) to transmit ASCII command characters. If you send ^*char*, and the ASCII value of *char* is between @ and \_, then the character is automatically translated to a single-byte value between 0 and 31.

For example, ^M is converted to a carriage return. If char is a value between a and z, then the character sequence is translated to a single-byte value between 1 and 26. If char is any other value, then the character sequence is not subject to any special processing.

For example, the string "Joe^M" transmits Joe, followed by a carriage return.

## Carriage return and line feed

You may include carriage return and line feed commands as part of the login script, when entered in the following format:

<cr> Sends or receives a carriage return

<lf> Sends or receives a line feed

For example, the string "waitfor Joe<cr><lf>" waits to receive Joe followed by a carriage return and line feed from the remote computer before executing the next command in the script.

## Literal characters

The backslash ( \ ) character defines that the *next character* is transmitted as a literal character, and is not subject to any special processing ordinarily associated with that character.

### Examples:

\^ Includes a caret as part of the string

\< Includes a < as part of the string

\\ Includes a backslash as part of the string



# Warranty and Other Product Information

## Product Warranty

**WARRANTY.** Handspring warrants to you that at the date of purchase, the product is free of defects in workmanship and materials, and the software included in the product will perform in substantial compliance to its program specifications.

**EXCLUSIONS FROM WARRANTY.** This warranty does not cover physical damage to the surface of the product, including, without limitation, breakage, cracks, dents, scratches or adhesive marks on the LCD touchscreen or outside casing of the product caused by you or a third party. In addition, this warranty shall not apply (i) if the casing for the product is opened by someone other than an authorized Handspring representative; (ii) if the defect or malfunction is caused by your or a third party's misuse, accident, modification of the product's components, or operation of the product in an unsuitable environment or in a manner for which it is not intended; (iii) if Handspring's testing and examination discloses that the alleged defect or malfunction in the product does not exist, (iv) if the defect or malfunction results from the use of the product in conjunction with accessories, other products, or ancillary or peripheral equipment and Handspring determines that there is no fault with the product itself; or (v) if the defect or malfunction is due to any communication service you may subscribe to or use with the product. Handspring shall not be responsible for software, firmware, information, or memory data contained in, stored on, or integrated with any products returned to Handspring for repair, whether under warranty or not. Handspring makes no warranty or representation that its software products will meet your requirements or will work in combination with any hardware or applications software products provided by third parties, that the operation of the software products will be uninterrupted or error free, or that all defects in the software products will be corrected.

**REMEDIES.** Handspring shall, at its discretion, either replace the product with a comparable product, repair the product, or refund the purchase price paid for the product. Replacement products may be new or reconditioned.

**WARRANTY PERIOD.** The warranty period is one (1) year from your date of purchase. Handspring warrants any replaced or repaired product for a period of ninety (90) days from the date of shipment back to you, or through the end of the original warranty period, whichever is longer.

**OBTAINING WARRANTY SERVICE.** In order to obtain warranty service, you must receive warranty service authorization by contacting Handspring within the warranty period and provide dated proof of original purchase. For further information about the warranty service procedure, please visit our website at <http://www.handspring.com>.

**WARRANTY EXCLUSIVE.** This warranty is exclusive and Handspring will not assume and hereby expressly disclaims any further warranties, including, but not limited to, any warranty of merchantability, fitness for a particular purpose and non-infringement.

**LIMITATION OF LIABILITY.** To the full extent allowed by law, Handspring's liability is limited to repair or replacement of the product, or refund of the purchase price paid. Handspring shall not be liable for any incidental, consequential, indirect, special or punitive damages of any kind, or for loss of revenue or profits, loss of business, loss of information or data, or other financial loss arising out of or in connection with the sale, installation, maintenance, use, performance, failure, or interruption of this product.

**GOVERNING LAW.** This warranty will be governed by the laws of California, and excluding the United Nations Convention on Contracts for the International Sale of Goods. The courts of California shall have exclusive personal jurisdiction in case of any disputes arising out of or in connection with this warranty.

# Handspring, Inc.

## End User Software License Agreement

THIS PRODUCT CONTAINS SOFTWARE, THE USE OF WHICH IS LICENSED BY HANDSPRING, INC. AND ITS SUPPLIERS (COLLECTIVELY, "HANDSPRING"), TO ITS CUSTOMERS FOR THEIR USE ONLY AS SET FORTH BELOW.

**SOFTWARE LICENSE:** Handspring grants you a nonexclusive license to use the accompanying software program(s) (the "Software") subject to the terms and restrictions set forth in this End User Software License Agreement ("License Agreement"). You are not permitted to lease or rent, distribute or sublicense the Software or to use the Software in a time-sharing arrangement or in any other unauthorized manner. Further, no license is granted to you in the human readable code of the Software (source code). Except as provided below, this License Agreement does not grant you any rights to patents, copyrights, trade secrets, trademarks, or any other rights in respect to the Software.

The Software is licensed to be used solely on or in connection with Handspring products. With respect to the Desktop Software, you may reproduce and provide one (1) copy of such Software for each personal computer on which such Software is used as permitted hereunder. With respect to the Device Software, you may use such Software only on one (1) Handspring product. Otherwise, the Software and supporting documentation may be copied only as essential for backup or archive purposes in support of your use of the Software as permitted hereunder. You must reproduce and include all copyright notices and any other proprietary rights notices appearing on the Software on any copies that you make.

Notwithstanding any other provision of this License Agreement, this License Agreement shall not be deemed to apply to any applications software licensed to you by third parties that is included on the same media as Handspring's Software ("Other Software") if the Other Software provides that the use of the Other Software is subject to the terms and conditions of the third party's license agreement.

Portions of the Software are licensed to Handspring, and from Handspring to you, pursuant to the GNU Library General Public License ("GNU Software"), a copy of which is supplied herewith and incorporated herein in its entirety by this reference. Notwithstanding any other provision of this License Agreement, this License Agreement shall not be deemed to apply to the GNU Software. Source code versions of the GNU Software are available at Handspring's web site, currently located at [www.handspring.com](http://www.handspring.com).

**PAYMENT OF FEES:** The effectiveness of the licenses granted hereunder is conditioned on the receipt by Handspring of any applicable fees.

**NO ASSIGNMENT; NO REVERSE ENGINEERING:** You may transfer the Software and this License Agreement to another party in connection with a transfer of the Handspring product upon which the Software is used, if the other party agrees in writing to accept the terms and conditions of this License Agreement. If you transfer the Software, you must at the same time either transfer all copies of the Software as well as the supporting documentation to the same party or destroy any such materials not transferred. Except as set forth above, you may not transfer or assign the Software or your rights under this License Agreement.

Modification, reverse engineering, reverse compiling, or disassembly of the Software is expressly prohibited. However, if you are a European Union ("EU") resident, information necessary to achieve interoperability of the Software with other programs within the meaning of the EU Directive on the Legal Protection of Computer Programs is available to you from Handspring upon written request.

**EXPORT RESTRICTIONS:** You agree that you will not export or re-export the Software or accompanying documentation (or any copies thereof) or any products utilizing the Software or such documentation in violation of any applicable laws or regulations of the United States or the country in which you obtained them. The software covered by this License Agreement may contain strong data encryption code which cannot be exported outside of the U.S. or Canada. You agree that you will not export/reexport, either physically or electronically, the encryption software or accompanying documentation without obtaining written authorization from the U.S. Department of Commerce.

**UNITED STATES GOVERNMENT LEGEND:** If you are acquiring the Software on behalf of any unit or agency of the United States Government, the following provisions apply. The Software constitutes a "commercial item", as that term is defined at Federal Acquisition Regulation (FAR) 2.101 (Oct. 1995), consisting of "commercial computer software" and "commercial computer software documentation", as such terms are used in FAR 12.212 (Sept.

1995), and is provided to the U.S. Government only as commercial software (with "Restricted Rights", if applicable). Use, duplication, or disclosure by the U.S. Government is subject to restrictions set forth in this License Agreement and as provided in DFARS 227.7202-1(a) and 227.7202-3(a) (1995), DFARS 252.227-7013(c)(1)(ii) (OCT 1988), FAR 12.212(a) (1995), FAR 52.227-19, or FAR 52.227-14 (ALT III), as applicable.

**TERM AND TERMINATION:** This License Agreement is effective until terminated. You may terminate it at any time by destroying the Software and documentation together with all copies and merged portions in any form. It will also terminate immediately if you fail to comply with any term or condition of this License Agreement. Upon such termination you agree to destroy the Software and documentation, together with all copies and merged portions in any form.

**GOVERNING LAW:** This License Agreement shall be governed by the laws of the State of California as such laws are applied to agreements entered into and to be performed entirely within California between California residents and by the laws of the United States. You agree that the conflicts of laws principles of such laws and the United Nations Convention on Contracts for the International Sale of Goods (1980) are hereby excluded in its entirety from application to this License Agreement.

**LIMITED WARRANTY; LIMITATION OF LIABILITY:** All warranties and limitations of liability applicable to the Software are as stated on the Limited Warranty or in the product manual accompanying the Software. Such warranties and limitations of liability are incorporated herein in their entirety by this reference.

**SEVERABILITY:** In the event any provision of this License Agreement is found to be invalid, illegal or unenforceable, the validity, legality and enforceability of any of the remaining provisions shall not in any way be affected or impaired and a valid, legal and enforceable provision of similar intent and economic impact shall be substituted therefor.

**ENTIRE AGREEMENT:** This License Agreement sets forth the entire understanding and agreement between you and Handspring, supersedes all prior agreements, whether written or oral, with respect to the Software, and may be amended only in a writing signed by both parties.

## GNU Library General Public License

Version 2, June 1991

Copyright (C) 1991 Free Software Foundation, Inc.

59 Temple Place - Suite 330, Boston, MA 02111-1307, USA.

Everyone is permitted to copy and distribute verbatim copies of this license document, but changing it is not allowed.

[This is the first released version of the library GPL. It is numbered 2 because it goes with version 2 of the ordinary GPL.]

**PREAMBLE:** The licenses for most software are designed to take away your freedom to share and change it. By contrast, the GNU General Public Licenses are intended to guarantee your freedom to share and change free software--to make sure the software is free for all its users.

This license, the Library General Public License, applies to some specially designated Free Software Foundation software, and to any other libraries whose authors decide to use it. You can use it for your libraries, too.

When we speak of free software, we are referring to freedom, not price. Our General Public Licenses are designed to make sure that you have the freedom to distribute copies of free software (and charge for this service if you wish), that you receive source code or can get it if you want it, that you can change the software or use pieces of it in new free programs; and that you know you can do these things.

To protect your rights, we need to make restrictions that forbid anyone to deny you these rights or to ask you to surrender the rights. These restrictions translate to certain responsibilities for you if you distribute copies of the library, or if you modify it. For example, if you distribute copies of the library, whether gratis or for a fee, you must give the recipients all the rights that we gave you. You must make sure that they, too, receive or can get the source code. If you link a program with the library, you must provide complete object files to the recipients so that they can relink them with the library, after making changes to the library and recompiling it. And you must show them these terms so they know their rights.

Our method of protecting your rights has two steps: (1) copyright the library, and (2) offer you this license which gives you legal permission to copy, distribute and/or modify the library.

Also, for each distributor's protection, we want to make certain that everyone understands that there is no warranty for this free library. If the library is modified by someone else and passed on, we want its recipients to know that what they have is not the original version, so that any problems introduced by others will not reflect on the original authors' reputations.

Finally, any free program is threatened constantly by software patents. We wish to avoid the danger that companies distributing free software will individually obtain patent licenses, thus in effect transforming the program into proprietary software. To prevent this, we have made it clear that any patent must be licensed for everyone's free use or not licensed at all.

Most GNU software, including some libraries, is covered by the ordinary GNU General Public License, which was designed for utility programs. This license, the GNU Library General Public License, applies to certain designated libraries. This license is quite different from the ordinary one; be sure to read it in full, and don't assume that anything in it is the same as in the ordinary license.

The reason we have a separate public license for some libraries is that they blur the distinction we usually make between modifying or adding to a program and simply using it. Linking a program with a library, without changing the library, is in some sense simply using the library, and is analogous to running a utility program or application program. However, in a textual and legal sense, the linked executable is a combined work, a derivative of the original library, and the ordinary General Public License treats it as such.

Because of this blurred distinction, using the ordinary General Public License for libraries did not effectively promote software sharing, because most developers did not use the libraries. We concluded that weaker conditions might promote sharing better.

However, unrestricted linking of non-free programs would deprive the users of those programs of all benefit from the free status of the libraries themselves. This Library General Public License is intended to permit developers of non-free programs to use free libraries, while preserving your freedom as a user of such programs to change the free libraries that are incorporated in them. (We have not seen how to achieve this as regards changes in header files, but we have achieved it as regards changes in the actual functions of the Library.) The hope is that this will lead to faster development of free libraries.

The precise terms and conditions for copying, distribution and modification follow. Pay close attention to the difference between a "work based on the library" and a "work that uses the library". The former contains code derived from the library, while the latter only works together with the library.

Note that it is possible for a library to be covered by the ordinary General Public License rather than by this special one.

## Terms and Conditions for Copying, Distribution and Modification

1. This License Agreement applies to any software library which contains a notice placed by the copyright holder or other authorized party saying it may be distributed under the terms of this Library General Public License (also called "this License"). Each licensee is addressed as "you".

A "library" means a collection of software functions and/or data prepared so as to be conveniently linked with application programs (which use some of those functions and data) to form executables.

The "Library", below, refers to any such software library or work which has been distributed under these terms. A "work based on the Library" means either the Library or any derivative work under copyright law: that is to say, a work containing the Library or a portion of it, either verbatim or with modifications and/or translated straightforwardly into another language. (Hereinafter, translation is included without limitation in the term "modification".)

"Source code" for a work means the preferred form of the work for making modifications to it. For a library, complete source code means all the source code for all modules it contains, plus any associated interface definition files, plus the scripts used to control compilation and installation of the library.

Activities other than copying, distribution and modification are not covered by this License; they are outside its scope. The act of running a program using the Library is not restricted, and output from such a program is covered only if its contents constitute a work based on the Library (independent of the use of the Library in a tool for writing it). Whether that is true depends on what the Library does and what the program that uses the Library does.

2. You may copy and distribute verbatim copies of the Library's complete source code as you receive it, in any medium, provided that you conspicuously and appropriately publish on each copy an appropriate copyright notice and disclaimer of warranty; keep intact all the notices that refer to this License and to the absence of any warranty; and distribute a copy of this License along with the Library.
3. You may charge a fee for the physical act of transferring a copy, and you may at your option offer warranty protection in exchange for a fee.
4. You may modify your copy or copies of the Library or any portion of it, thus forming a work based on the Library, and copy and distribute such modifications or work under the terms of Section 1 above, provided that you also meet all of these conditions:
  - a) The modified work must itself be a software library.
  - b) You must cause the files modified to carry prominent notices stating that you changed the files and the date of any change.
  - c) You must cause the whole of the work to be licensed at no charge to all third parties under the terms of this License.
  - d) If a facility in the modified Library refers to a function or a table of data to be supplied by an application program that uses the facility, other than as an argument passed when the facility is invoked, then you must make a good faith effort to ensure that, in the event an application does not supply such function or table, the facility still operates, and performs whatever part of its purpose remains meaningful. (For example, a function in a library to compute square roots has a purpose that is entirely well-defined independent of the application. Therefore, Subsection 2d requires that any application-supplied function or table used by this function must be optional: if the application does not supply it, the square root function must still compute square roots.)

These requirements apply to the modified work as a whole. If identifiable sections of that work are not derived from the Library, and can be reasonably considered independent and separate works in themselves, then this License, and its terms, do not apply to those sections when you distribute them as separate works. But when you distribute the same sections as part of a whole which is a work based on the Library, the distribution of the whole must be on the terms of this License, whose permissions for other licensees extend to the entire whole, and thus to each and every part regardless of who wrote it.

Thus, it is not the intent of this section to claim rights or contest your rights to work written entirely by you; rather, the intent is to exercise the right to control the distribution of derivative or collective works based on the Library.

In addition, mere aggregation of another work not based on the Library with the Library (or with a work based on the Library) on a volume of a storage or distribution medium does not bring the other work under the scope of this License.

5. You may opt to apply the terms of the ordinary GNU General Public License instead of this License to a given copy of the Library. To do this, you must alter all the notices that refer to this License, so that they refer to the ordinary GNU General Public License, version 2, instead of to this License. (If a newer version than version 2 of the ordinary GNU General Public License has appeared, then you can specify that version instead if you wish.) Do not make any other change in these notices.

Once this change is made in a given copy, it is irreversible for that copy, so the ordinary GNU General Public License applies to all subsequent copies and derivative works made from that copy.

This option is useful when you wish to copy part of the code of the Library into a program that is not a library.

6. You may copy and distribute the Library (or a portion or derivative of it, under Section 2) in object code or executable form under the terms of Sections 1 and 2 above provided that you accompany it with the complete corresponding machine-readable source code, which must be distributed under the terms of Sections 1 and 2 above on a medium customarily used for software interchange.

If distribution of object code is made by offering access to copy from a designated place, then offering equivalent access to copy the source code from the same place satisfies the requirement to distribute the source code, even though third parties are not compelled to copy the source along with the object code.

7. A program that contains no derivative of any portion of the Library, but is designed to work with the Library by being compiled or linked with it, is called a "work that uses the Library". Such a work, in isolation, is not a derivative work of the Library, and therefore falls outside the scope of this License.

However, linking a "work that uses the Library" with the Library creates an executable that is a derivative of the Library (because it contains portions of the Library), rather than a "work that uses the library". The executable is therefore covered by this License. Section 6 states terms for distribution of such executables.

When a "work that uses the Library" uses material from a header file that is part of the Library, the object code for the work may be a derivative work of the Library even though the source code is not. Whether this is true is especially significant if the work can be linked without the Library, or if the work is itself a library. The threshold for this to be true is not precisely defined by law.

If such an object file uses only numerical parameters, data structure layouts and accessors, and small macros and small inline functions (ten lines or less in length), then the use of the object file is unrestricted, regardless of whether it is legally a derivative work. (Executables containing this object code plus portions of the Library will still fall under Section 6.)

Otherwise, if the work is a derivative of the Library, you may distribute the object code for the work under the terms of Section 6. Any executables containing that work also fall under Section 6, whether or not they are linked directly with the Library itself.

8. As an exception to the Sections above, you may also compile or link a "work that uses the Library" with the Library to produce a work containing portions of the Library, and distribute that work under terms of your choice, provided that the terms permit modification of the work for the customer's own use and reverse engineering for debugging such modifications.

You must give prominent notice with each copy of the work that the Library is used in it and that the Library and its use are covered by this License. You must supply a copy of this License. If the work during execution displays copyright notices, you must include the copyright notice for the Library among them, as well as a reference directing the user to the copy of this License. Also, you must do one of these things:

- a) Accompany the work with the complete corresponding machine-readable source code for the Library including whatever changes were used in the work (which must be distributed under Sections 1 and 2 above); and, if the work is an executable linked with the Library, with the complete machine-readable "work that uses the Library", as object code and/or source code, so that the user can modify the Library and then relink to produce a modified executable containing the modified Library. (It is understood that the user who changes the contents of definitions files in the Library will not necessarily be able to recompile the application to use the modified definitions.)
- b) Accompany the work with a written offer, valid for at least three years, to give the same user the materials specified in Subsection 6a, above, for a charge no more than the cost of performing this distribution.
- c) If distribution of the work is made by offering access to copy from a designated place, offer equivalent access to copy the above specified materials from the same place.
- d) Verify that the user has already received a copy of these materials or that you have already sent this user a copy.

For an executable, the required form of the "work that uses the Library" must include any data and utility programs needed for reproducing the executable from it. However, as a special exception, the source code distributed need not include anything that is normally distributed (in either source or binary form) with the major components (compiler, kernel, and so on) of the operating system on which the executable runs, unless that component itself accompanies the executable.



It may happen that this requirement contradicts the license restrictions of other proprietary libraries that do not normally accompany the operating system. Such a contradiction means you cannot use both them and the Library together in an executable that you distribute.

9. You may place library facilities that are a work based on the Library side-by-side in a single library together with other library facilities not covered by this License, and distribute such a combined library, provided that the separate distribution of the work based on the Library and of the other library facilities is otherwise permitted, and provided that you do these two things:
  - a) Accompany the combined library with a copy of the same work based on the Library, uncombined with any other library facilities. This must be distributed under the terms of the Sections above.
  - b) Give prominent notice with the combined library of the fact that part of it is a work based on the Library, and explaining where to find the accompanying uncombined form of the same work.
10. You may not copy, modify, sublicense, link with, or distribute the Library except as expressly provided under this License. Any attempt otherwise to copy, modify, sublicense, link with, or distribute the Library is void, and will automatically terminate your rights under this License. However, parties who have received copies, or rights, from you under this License will not have their licenses terminated so long as such parties remain in full compliance.
11. You are not required to accept this License, since you have not signed it. However, nothing else grants you permission to modify or distribute the Library or its derivative works. These actions are prohibited by law if you do not accept this License. Therefore, by modifying or distributing the Library (or any work based on the Library), you indicate your acceptance of this License to do so, and all its terms and conditions for copying, distributing or modifying the Library or works based on it.
12. Each time you redistribute the Library (or any work based on the Library), the recipient automatically receives a license from the original licensor to copy, distribute, link with or modify the Library subject to these terms and conditions. You may not impose any further restrictions on the recipients' exercise of the rights granted herein. You are not responsible for enforcing compliance by third parties to this License.
13. If, as a consequence of a court judgment or allegation of patent infringement or for any other reason (not limited to patent issues), conditions are imposed on you (whether by court order, agreement or otherwise) that contradict the conditions of this License, they do not excuse you from the conditions of this License. If you cannot distribute so as to satisfy simultaneously your obligations under this License and any other pertinent obligations, then as a consequence you may not distribute the Library at all. For example, if a patent license would not permit royalty-free redistribution of the Library by all those who receive copies directly or indirectly through you, then the only way you could satisfy both it and this License would be to refrain entirely from distribution of the Library.

If any portion of this section is held invalid or unenforceable under any particular circumstance, the balance of the section is intended to apply, and the section as a whole is intended to apply in other circumstances.

It is not the purpose of this section to induce you to infringe any patents or other property right claims or to contest validity of any such claims; this section has the sole purpose of protecting the integrity of the free software distribution system which is implemented by public license practices. Many people have made generous contributions to the wide range of software distributed through that system in reliance on consistent application of that system; it is up to the author/donor to decide if he or she is willing to distribute software through any other system and a licensee cannot impose that choice.

This section is intended to make thoroughly clear what is believed to be a consequence of the rest of this License.

14. If the distribution and/or use of the Library is restricted in certain countries either by patents or by copyrighted interfaces, the original copyright holder who places the Library under this License may add an explicit geographical distribution limitation excluding those countries, so that distribution is permitted only in or among countries not thus excluded. In such case, this License incorporates the limitation as if written in the body of this License.
15. The Free Software Foundation may publish revised and/or new versions of the Library General Public License from time to time. Such new versions will be similar in spirit to the present version, but may differ in detail to address new problems or concerns.

Each version is given a distinguishing version number. If the Library specifies a version number of this License which applies to it and "any later version", you have the option of following the terms and conditions either of that version or of any later version published by the Free Software Foundation. If the Library does not specify a license version number, you may choose any version ever published by the Free Software Foundation.

16. If you wish to incorporate parts of the Library into other free programs whose distribution conditions are incompatible with these, write to the author to ask for permission. For software which is copyrighted by the Free Software Foundation, write to the Free Software Foundation; we sometimes make exceptions for this. Our decision will be guided by the two goals of preserving the free status of all derivatives of our free software and of promoting the sharing and reuse of software generally.

## NO WARRANTY

17. BECAUSE THE LIBRARY IS LICENSED FREE OF CHARGE, THERE IS NO WARRANTY FOR THE LIBRARY, TO THE EXTENT PERMITTED BY APPLICABLE LAW. EXCEPT WHEN OTHERWISE STATED IN WRITING THE COPYRIGHT HOLDERS AND/OR OTHER PARTIES PROVIDE THE LIBRARY "AS IS" WITHOUT WARRANTY OF ANY KIND, EITHER EXPRESSED OR IMPLIED, INCLUDING, BUT NOT LIMITED TO, THE IMPLIED WARRANTIES OF MERCHANTABILITY AND FITNESS FOR A PARTICULAR PURPOSE. THE ENTIRE RISK AS TO THE QUALITY AND PERFORMANCE OF THE LIBRARY IS WITH YOU. SHOULD THE LIBRARY PROVE DEFECTIVE, YOU ASSUME THE COST OF ALL NECESSARY SERVICING, REPAIR OR CORRECTION.
18. IN NO EVENT UNLESS REQUIRED BY APPLICABLE LAW OR AGREED TO IN WRITING WILL ANY COPYRIGHT HOLDER, OR ANY OTHER PARTY WHO MAY MODIFY AND/OR REDISTRIBUTE THE LIBRARY AS PERMITTED ABOVE, BE LIABLE TO YOU FOR DAMAGES, INCLUDING ANY GENERAL, SPECIAL, INCIDENTAL OR CONSEQUENTIAL DAMAGES ARISING OUT OF THE USE OR INABILITY TO USE THE LIBRARY (INCLUDING BUT NOT LIMITED TO LOSS OF DATA OR DATA BEING RENDERED INACCURATE OR LOSSES SUSTAINED BY YOU OR THIRD PARTIES OR A FAILURE OF THE LIBRARY TO OPERATE WITH ANY OTHER SOFTWARE), EVEN IF SUCH HOLDER OR OTHER PARTY HAS BEEN ADVISED OF THE POSSIBILITY OF SUCH DAMAGES.

END OF TERMS AND CONDITIONS

## How to Apply These Terms to Your New Library

If you develop a new library, and you want it to be of the greatest possible use to the public, we recommend making it free software that everyone can redistribute and change. You can do so by permitting redistribution under these terms (or, alternatively, under the terms of the ordinary General Public License).

To apply these terms, attach the following notices to the library. It is safest to attach them to the start of each source file to most effectively convey the exclusion of warranty; and each file should have at least the "copyright" line and a pointer to where the full notice is found.

One line to give the library's name and an idea of what it does.  
Copyright (C) year name of author

This library is free software; you can redistribute it and/or modify it under the terms of the GNU Library General Public License as published by the Free Software Foundation; either version 2 of the License, or (at your option) any later version.

This library is distributed in the hope that it will be useful, but WITHOUT ANY WARRANTY; without even the implied warranty of MERCHANTABILITY or FITNESS FOR A PARTICULAR PURPOSE. See the GNU Library General Public License for more details.

You should have received a copy of the GNU Library General Public License along with this library; if not, write to the Free Software Foundation, Inc., 59 Temple Place - Suite 330, Boston, MA 02111-1307, USA.

Also add information on how to contact you by electronic and paper mail. You should also get your employer (if you work as a programmer) or your school, if any, to sign a "copyright disclaimer" for the library, if necessary. Here is a sample; alter the names:

Yoyodyne, Inc., hereby disclaims all copyright interest in the library 'Frob' (a library for tweaking knobs) written by James Random Hacker.

Signature of Ty Coon, 1 April 1990  
Ty Coon, President of Vice

That's all there is to it!

## FCC Statement

This device may cause TV or radio interference if used in close proximity to receiving equipment. The FCC can require you to stop using the device if such interference cannot be eliminated. If you need assistance, contact Handspring Customer Care.

This device complies with part 15 of the FCC rules. Operation is subject to the following two conditions: (1) This device may not cause harmful interference, and (2) this device must accept any interference received, including interference that may cause undesired operation.

This device has been tested and found to comply with the limits for a Class B digital device, pursuant to part 15 of the FCC Rules. These limits are designed to provide reasonable protection against harmful interference in a residential installation. This equipment generates, uses, and can radiate radio frequency energy and, if not installed and used in accordance with the instructions, may cause harmful interference to radio communications. However, there is no guarantee that interference will not occur in a particular installation. If this equipment does cause harmful interference to radio or television reception, which can be determined by turning the equipment off and on, the user is encouraged to try to correct the interference by one or more of the following measures:

- Reorient or relocate the receiving antenna
- Increase the separation between the equipment and receiver
- Connect the equipment into an outlet or circuit different from that to which the receiver is connected
- Consult the dealer or an experienced radio/TV technician for help and for additional suggestions.

The use of shielded I/O cables is required when connecting this equipment to any and all optional peripheral or host devices. Failure to do so may violate FCC rules.

Caution: Changes or modifications not covered in this manual must be approved in writing by the manufacturer's Regulatory Engineering Department. Changes or modifications made without written approval may void the user's authority to operate this equipment.

Responsible Party:  
Handspring, Inc.  
189 Bernardo Avenue  
Mountain View, California 94043-5203  
United States of America  
(650) 230-5000

## Canadian RFI Statement

This Class B digital apparatus meets all requirements of the Canadian Interference-Causing Equipment Regulations.

Cet appareil numérique de la classe B respecte toutes les exigences du Règlement sur le matériel brouilleur du Canada.



# Acknowledgments

We would like to thank the following developers whose contributions were an integral part of the Handspring product:

- C.E. Steuart Dewar  
Pimlico Software, Inc.  
[www.gorilla-haven.org/pimlico](http://www.gorilla-haven.org/pimlico)
- Darren Beck  
Code City  
[www.codecity.com.au](http://www.codecity.com.au)
- Rick Huebner  
[www.probe.net/~rhuebner/index.html](http://www.probe.net/~rhuebner/index.html)

# Index

## A

- ABA (Address Book archive file) 34
- Accented characters
  - entering 31
  - onscreen keyboard 33
- Add-on applications 40–43
- Address Book
  - archive files (.aba) 34
- Address Book. *See* Contacts
- Alarm
  - preset 99
  - reminder 99
  - setting 85
  - sound 99, 142
  - for untimed events 85
- Anniversaries. *See* Repeating events
- Application buttons 15, 37, 54, 55, 138
- Applications
  - beaming 78–80
  - Blazer 195
  - Calculator 59
  - categories 38
  - CityTime 58
  - Contacts 55
  - Date Book Plus 54
  - Expense 60
  - font style 76
  - installing 40–42
  - Memo Pad 57
  - opening 37
  - Palm SMS 204
  - preferences for 39
  - removing 42
  - security 47
  - To Do List 56
  - viewing as icons 38
  - viewing as list 38
  - See also* Add-on applications
- Applications Launcher 37–39
- Appointments. *See* Date Book Plus
- Archive files
  - importing data from 34
  - for main applications 34

- saving deleted records 63
  - saving purged records 64
- Automatic fill, in Expense 135
- Auto-off delay 141
- Autotext. *See* Keyboard ShortCuts

## B

- Backup. *See* HotSync
- Battery
  - charging 17
  - conserving power 141
  - gauge 37
- BCC (blind carbon copy) 180
- Beaming
  - See also* Infrared
- Beaming information 78–80
  - location of IR port 15
  - problems with 223
- Birthdays. *See* Repeating events
- Blazer
  - adding bookmarks 197, 198
  - Bookmark view 196
  - deleting bookmarks 199
  - editing bookmarks 198
  - menus 200
  - organizing bookmarks 199
  - overview 195
  - Preferences 202
  - Properties 201
  - Web Page view 195
- Bold font for text 76
- Bookmarks
  - adding 197, 198
  - arranging 199
  - deleting 199
  - editing 198
- Brightness Control 14, 16
- Business card for beaming 78
- Buttons
  - power 15
  - scroll 14
- Buttons preferences 138

## C

### Cable

- connecting to computer 23
- for local HotSync operations 76, 77
- mobile phone 193, 194
- serial 12, 23, 158, 222
- USB 12, 23

### Calculator

- Advanced mode 119
- Area view 125
- Basic mode 118
- buttons explained 118, 119–126
- Finance view 121
- Length view 124
- Logic view 123
- Math view 120
- memory 118
- menus 127
- opening 59, 118
- overview 59
- recent calculations 59, 119
- selecting mode 118
- Statistics view 123
- Trigonometry view 121
- Volume view 126
- Weight/Temp view 124

### Calibration 19, 140, 218

### Call Waiting, disabling 146, 166

### Calling card, using in phone settings 146, 166

### Capital letters 27

### Card. *See* Expansion Card

### Caring for the handheld 213

### Categories

- application 38
- assigning records to 65
- beaming 78–79
- creating 66–67
- default 65
- displaying 66, 107, 221
- folders for e-mail 185
- merging 67
- renaming 67
- using in Applications Launcher 38

### cc:Mail 173

### Chain calculations 119

### Charger

- connecting 17, 23
- connector on handheld 16

### Charging battery 17

### Check boxes 19

### CityTime

- adding cities 117
- home city 116
- menus 117
- opening 58
- overview 116
- remote cities 116

### Clearing Calculator entries 118, 120

### COM port. *See* USB, port *and* Serial port

### Combining categories 67

### Comma delimited files, importing data from 34

### Command buttons 19

### Command equivalents (keyboard) 30

### Compressing Day view 98

### Conduits 159

- for connecting to PIMs 25
- for modem HotSync operations 167
- for synchronizing applications 222, 159–160, 216

*See also* HotSync

### Confirming e-mail 181

### Conflicting events 93

### Connecting

- HotSync cable 23
- service templates 147
- to server or ISP 147
- travel charger 17, 23

### Connection preferences 139

### Contacts

- \*If Found Call\* entry 104
- adding custom fields 108
- business card for beaming 78
- copying 104
- copying records 104
- creating contact records 103–104
- creating records 61, 103
- deleting records 63
- dialing from 105
- Dialing Preferences 107
- displaying category 107
- finding records 68
- fonts 76
- menus 106
- notes for records 75
- opening 55
- overview 55
- private records 73
- sorting records 72

- Continuous events
  - changing 87
  - deleting from Date Book Plus 64, 87
  - scheduling 86
- Contrast control 14, 16
- Copying
  - contact information 104
- Copying text 63
- Country default setting 140
- Cradle. *See* Cable
- Creating
  - categories 38, 66–67
  - contact entries 103
  - currency symbols 130
  - custom fields in Contacts 108
  - Date Book Plus events 82
  - e-mail 176–177
  - Expense items 128
  - expense reports in Excel 132–134
  - memos 114
  - notes for records 75
  - records 61
  - To Do List items 109
- Currency
  - default 135
  - defining 130
  - for Expense items 130
- Current date 22, 221
- Current time 37
  - displaying in Date Book Plus 88
  - setting 21
- Customizing
  - categories 67
  - currencies and symbols 130
  - expense reports 225–232
  - fields in Contacts 108
  - HotSync settings 159
  - See also* Preferences
- Cutting text 62
- Cycling through views 54

## D

- Daily
  - calendar 82–84
  - events. *See* Repeating events
  - Journal 94
- Data
  - entry. *See* Entering data
  - transfer. *See* HotSync

- Date Book
  - archive files (.dba) 34
- Date Book Plus
  - adding Contacts data to records 69–70
  - alarm 85
  - changing event time 84
  - changing event to untimed 84
  - changing repeating events 87
  - conflicting events 93
  - continuous events 86–88
  - creating records 61, 82–84
  - Daily Journal 94
  - Day view 88
  - deleting records 63
  - deleting repeating events 87
  - end time for Day view 97
  - Event tracking 94
  - floating events 93
  - fonts 76
  - List View 92
  - menus 96
  - Month view 91
  - notes for records 75
  - opening 54
  - overview 54
  - private records 73
  - purging records 64
  - repeating events 64, 86–88
  - scheduling events 82–84
  - selecting dates 82
  - start time for Day view 97
  - Sunday or Monday to start week 141
  - switching views 88
  - templates 95
  - To Do List items 94
  - untimed events 83
  - Week view 89, 141, 221
  - Week View with Text 90
  - Year View 91
- Dates
  - Expense item 128
  - setting current 22, 221
  - showing in Mail list 185
  - To Do List record due 109–110, 110–111
- Day (Date Book Plus view) 83, 98
- Daylight savings 22
- DBA (Date Book archive file) 34
- Decimal point 141

- Default
  - categories 65
  - currency in Expense 135
  - settings. *See* Preferences
- Deleted
  - data, saving in archive files 63
  - e-mail, recovering 184
- Deleting
  - applications 40, 42
  - Bookmarks 199
  - Desktop software 43
  - e-mail 184
  - passwords 48
  - records 63
  - service templates 152
  - text 62
  - See also* Purging records
- Delivering e-mail 179, 181
- Desktop E-Mail application
  - applications supported 173
  - managing 172–191
  - support of Mail features 178
- Desktop software 24–25
  - configuring mail 173–174
  - linking to external files 170
  - removing 43
  - saving deleted data to an archive file 63
  - system requirements 12
  - upgrading 12
  - See also* PIM
- Dialing
  - applications 107
  - from Contacts list 105
- Digitizer 19, 140, 218
- Display, contrast (brightness) control 14
- DNS (Domain Naming System) 149
- Docking station. *See* Cable
- Double-booked events 93
- Draft e-mail 182
- Dragging
  - memos into other applications 57
  - using the stylus 19

## E

- Edit
  - SMS messages 208
- Editing
  - records 62–63
  - unsent e-mail 181

- E-mail addresses
  - in Contacts 104
  - looking up 177–178
- E-mail items. *See* Mail
- Entering data 27–35
  - importing from other applications 34–35
  - using keyboard 27–31
  - using the computer keyboard 33
  - using the onscreen keyboard 33

- Entries. *See* Contacts
- Eudora 173
- Events. *See* Date Book Plus
- Excel, transferring Expense data to 132–134
- Exchanging data. *See* HotSync
- Exclamation marks in To Do List 112

- Expansion Card
  - applications 45
  - copying applications 45
  - formatting 47
  - inserting 44
  - renaming 47
  - using 44–47

- Expense
  - adding Contacts data to records 71
  - categorizing records 65
  - creating records 61, 128
  - currency 130, 135
  - date of item 128
  - defining new currency 130
  - deleting records 63
  - menus 134
  - notes for records 75
  - opening 60
  - overview 60
  - purging records 64
  - receipt details 129
  - reports in Excel 132–134, 225–232
  - sorting records 72
  - templates for reports 133
  - type 129, 135
  - vendor 130

## F

- Files, linking to external 170
- Filing e-mail 183
- Filters for e-mail 187–190



Finding  
    applications 37  
    e-mail addresses 177–178  
    information in applications 67–71  
    phone numbers 69–70  
    using the Find application 69

Floating events 93

Folders for e-mail 185

Fonts 76

Formats preferences 140

Frozen handheld 218

## G

Games 142

General preferences  
    alarm sounds 142  
    auto-off delay 141  
    system sounds 142

Glossary. *See* Keyboard ShortCuts

GSM 154, 204–210, 220

## H

Handheld  
    contrast control 14, 16  
    overview 11

Hard reset 215

Header information (e-mail) 175, 176

Help  
    Keyboard 63  
    online tips 20

Hiding  
    records 73  
    *See also* Private records

High Priority e-mail filter 189

HotSync  
    buttons preferences 138  
    conduits for synchronizing  
        applications 159–160, 216  
    customizing 159  
    defined 76  
    first-time operation 77–78, 171–172  
    for managing desktop E-Mail  
        173–174  
    HotSync Manager 76  
    IR operation 160–164  
    linking to external files 170  
    local operation 77, 158  
    modem operation 158, 164–167  
    modem settings 165

network operation 168  
operations using IR port 160–164  
options for filtering e-mail 186–190  
problems with 222–223  
setting options 157–158  
for synchronizing data 24

## I

Icons  
    alarm 85  
    application 38  
    note 75  
    online Tips 20  
    onscreen 218  
    repeating event 87

Idle timeout of ISP or server  
connection 149

Ignoring e-mail. *See* Filters for e-mail

Importing data 34–35

Inbox 185

Indicators  
    battery 15

Infrared  
    HotSync operations 160–164  
    port 160  
    requirements for computer 160

Infrared port. *See* IR port

Installing  
    applications 40–42  
    conduit to install applications 159  
    Desktop software 24–25, 217  
    Mail. *See* Mail, desktop configuration

Instant Lookup 68

International characters  
    entering 31  
    onscreen keyboard 33

IP address 148, 150

IR port 15  
    *See also* Beaming information

IR. *See* Infrared

Items. *See* To Do List *or* Expense

## K

Keyboard  
    accented characters 31  
    capital letters 27  
    computer 33  
    location 15  
    locking 15, 16

- menu commands 30
- moving the cursor 29
- numbers 28
- online Help 63
- onscreen 33
- ShortCuts for entering data 30,  
154–155
- unlocking 15, 16

## L

- Lanyard holder 14
- LED 15, 17
- Letters
  - font style 76
  - onscreen keyboard 33
- Light, *see* LED 15
- Linking
  - external file 170
  - with desktop software. *See* HotSync
- List (Date Book Plus view) 92
- List, in Applications Launcher 38
- Locking
  - handheld with a password 49–50,  
153
  - keyboard 15, 16
  - records. *See* Security
- Login scripts 150, 233
- Looking up Address Book data
  - to add to e-mail addresses 177–178
- Looking up Contacts data
  - to add to other records 69–70
  - scrolling in Contacts 68
- Looking up. *See* Finding
- Lost handheld, contact for 104
- Lost records 221
- Lotus
  - 1-2-3, for expense reports 232
  - cc:Mail 173
  - Organizer, importing data from 34

## M

- Mail
  - address lookup 177–178
  - attachments 187
  - BCC (blind carbon copy) 178, 180
  - changing setup 174
  - closing 175
  - confirm delivery 178, 181
  - confirm read 178, 181

- creating 176–177
- deleting e-mail 184
- desktop configuration 173–174
- draft e-mail 182
- editing unsent e-mail 181
- filing e-mail 183
- filtering options 186–190
- folders 185
- HotSync options 173–174
- menus 191
- opening 174
- overview 172
- priority of delivery 178, 179
- purging deleted e-mail 184
- recovering deleted 184
- replying to e-mail 177
- sending 181
- showing dates 185
- signature 178, 180–181
- sorting 186
- synchronizing 174
- truncating 190
- viewing e-mail 175

- Main applications 37
- Maintenance information 213
- Meetings. *See* Date Book Plus
- Memo Pad
  - adding Contacts data to records  
69–70
  - archive files (.mpa) 34
  - categorizing records 65
  - creating records 61, 114
  - deleting records 63
  - dragging memos into other  
applications 57
  - fonts 76
  - menus 115
  - opening 57
  - overview 57
  - private records 73
  - reviewing memos 114
  - sorting records 72, 221
  - See also* Notes
- Memory
  - for beaming 223
  - Calculator 118
  - regaining 64
- Memos. *See* Memo Pad
- Menus 29–30, 218
  - Blazer 200
  - choosing 29

- command equivalents (keyboard) 30
- Contacts 106
- Date Book Plus 96
- Edit menu 62–63
- Expense 134
- Mail 191
- Memo Pad 115, 117, 127
- menu bar 19, 29
- Network Preferences 152
- Palm SMS 209
- To Do List 112

Messages

- receiving 205
- text 204

Microsoft

- Excel, transferring Expense data to 132–134
- Outlook 173
- Outlook, connecting to 223
- Windows 95, 98 160

Mobile phone

- connecting to 194
- using handheld with 193–211

Modem

- HotSync operations via 164–167

Monday, to start week 141

Month (Date Book Plus view) 91

Moving

- Date Book Plus events 84
- the cursor 29

MPA (Memo Pad archive file) 34

Multi-day events. *See* Repeating events

MultiMediaCard. *See* Expansion Card

## N

Network

- connecting 147
- connection type 148
- idle timeout 149
- login scripts 150
- password 144
- phone settings 145
- preferences 142–153
- primary DNS 149
- secondary DNS 149
- selecting service 142
- user name 143

Network HotSync operation 168

Notes

- attaching to records 75
- See also* Memo Pad

Numbers

- decimal point and thousands separator 141
- entering 28
- onscreen keyboard 33

## O

One-Touch Mail 211

1-2-3, for expense reports 232

Onscreen keyboard 33, 63

Opening

- applications 37
- Calculator 59, 118
- CityTime 58
- Contacts 55
- Date Book Plus 54
- Expense 60
- Mail 174
- Memo Pad 57
- To Do List 56

Organizer (Lotus PIM) 34

Outbox 181, 185

Outlook 173

Outlook, connecting to 223

Overlapping events 93

Overview

- handheld 11

Owner preferences 153

## P

Palm Desktop software. *See* Desktop software

Palm SMS

- changing messages 208
- creating messages 206
- menus 209
- overview 204
- receiving messages 205
- signature 207

Passwords 48–51

- changing 48
- creating 48
- deleting 48
- for network 144
- forgotten 50, 224

- Pasting text 63
- Payment, Expense item 129
- Personal information managers. *See* PIM
- Phone Lookup 69–70
- Phone numbers
  - selecting types 104
- Phone settings for ISP or dial-in server 145–147
- Pick lists 19
- PIM (personal information manager)
  - using with handheld 25
- Ports
  - IR on handheld 160
- Ports. *See* USB, port *and* Serial port
- Power button 15
- PPP 148
- PRC (application file extension) 41
- Preferences 21
  - Blazer 202
  - Buttons 138
  - choosing 39
  - Connection 139
  - Date & Time 140
  - dialing 107
  - Digitizer 140
  - Formats 140
  - General 141
  - HotSync buttons 138
  - Network 142–153
  - Owner 153
  - ShortCuts 154
- Primary DNS 149
- Printing
  - expense reports from Excel 132–134
  - records from applications 24
- Prioritizing To Do List records 109, 112
- Priority of delivery (e-mail) 179
- Private records
  - displaying and creating 73, 221
  - lost with forgotten password 50
  - See also* Security
- Profiles 171
- Proxy server 203
- Punctuation marks
  - onscreen keyboard 33
  - typing 28
- Purging
  - deleted e-mail 184
  - records 64
  - See also* Deleting

## Q

- Quattro Pro, for expense reports 232
- Quick Lookup 68

## R

- Range of times in Day view 97
- Reading e-mail on device 175
- Receipts, recording in Expense 129
- Receiving data. *See* Beaming information
- Records
  - beaming 78–79
  - choosing categories 65
  - Contacts 103
  - creating 61
  - Date Book Plus 82
  - defined 61
  - deleting 63, 87
  - displaying a category of 66
  - editing 62–63
  - Expense 128
  - fonts 76
  - hiding private 47, 73
  - lost 221
  - Memo Pad 114
  - notes for 75
  - private 73
  - purging 64
  - sorting 72
  - To Do List 109
- Recovering
  - deleted e-mail 184
  - filed mail 183
- Recurring events
  - deleting 64
  - scheduling 86
- Reminder. *See* Alarm
- Removing
  - applications 42
  - Desktop software 43
- Renaming categories 67
- Repeating events
  - deleting from Date Book Plus 64
  - scheduling 86
- Replying to e-mail 177
- Rescheduling events 84
- Reset button 16

Resetting handheld  
  hard reset 215  
  location of reset button 16, 214  
  soft reset 214  
  warm reset 215  
Retrieving e-mail. *See* Filters for e-mail

## S

Saving  
  data 38, 61, 63  
  draft e-mail 182  
Scheduling events 82–84  
Screen  
  blank 218  
  brightness control 14, 16  
  calibrating 19, 140  
  caring for 213  
  contrast control 14, 16  
  touching 15  
scroll 68  
Scroll bar 20  
Scroll buttons 14, 20  
SD. *See* Expansion Card  
Searching. *See* Finding  
Secondary DNS 149  
Secure Digital. *See* Expansion Card  
Security 47–51  
  changing password 48  
  deleting password 48  
  displaying owner's name 153  
  forgotten password 50  
  locking the handheld 49  
  private records 73  
Selecting  
  date for event 82  
  e-mail to be synchronized. *See* Filters  
    for e-mail  
  phone numbers in Contacts list 104  
  text 62, 63  
Sending  
  data. *See* Beaming information  
  e-mail 176–177, 181  
Serial port 12, 16, 158, 165, 222  
Service templates 147, 152  
Service, selecting for network 142  
Settings. *See* Preferences  
Short Message Service. *See* Palm SMS  
ShortCuts  
  backing up 159  
  managing 154–155

  menu commands 30  
  predefined 31  
  using 30  
Showing dates in Mail list 185  
Signature 207  
Signature for e-mail 180–181  
SMS. *See* Palm SMS  
Soft reset 214  
Sorting  
  applications 38  
  e-mail items 186  
  records 72, 221  
Standing Meetings. *See* Repeating events  
Starting applications 37  
Storing e-mail 183  
Strap 14  
Stylus 15  
  dragging with 19  
  holding 15  
  tapping with 19  
Sunday, to start week 141  
Symbols  
  for currency 130  
Synchronizing data. *See* HotSync  
System conduit 159  
System requirements for Desktop  
software 12  
System sounds 142

## T

Tab delimited files, importing data from 34  
Tapping 19, 218  
Task. *See* To Do List  
TCP/IP 142, 152, 154  
TDA (To Do List archive file) 34  
Technical Support 224  
Templates  
  for Date Book Plus 95  
  for expense reports 133  
Text  
  copying 63  
  cutting 62  
  entry. *See* Entering data  
  finding 67  
  fonts for 76  
  importing data from files 34  
  selecting all 63  
Thousands separator 141

## Time

- alarm setting 85
- format 141
- setting current 21
- setting event 82
- start and end for Date Book Plus Day view 97

Time bars in Date Book Plus 98

Time stamps 94

Tips, online 20

To Do List

- adding Contacts data to records 69–70
- archive files (.tda) 34
- categorizing records 65, 100, 112
- checking off items 94, 111
- completed items 112
- completion date 112
- creating items in Date Book Plus 94
- creating records 61, 109
- deleting records 63
- due date 109–110, 110–111, 112
- fonts 76
- menus 112
- notes for records 75
- opening 56
- overview 56
- prioritizing records 109, 112
- private records 73
- purging records 64, 112
- sorting records 72
- viewing items in Date Book Plus 90, 92

Today. *See* Current date

Tracking events 94

Transferring data. *See* HotSync

Transmitting data. *See* Beaming information

Troubleshooting 217–224

Truncating e-mail 190

Turning off handheld

- automatically 141
- problems with 218

Turning on handheld

- application buttons 15
- displaying owner's name 153
- problems with 218

Typing

- punctuation marks 28

Typing. *See* Entering data

## U

Undoing actions 62

Uninstalling Desktop software 43

Unlocking

- keyboard 16

Unresponsive handheld 218

Unsent e-mail, editing 181

Untimed events 83, 84, 85

Updating data. *See* HotSync

Upgrading Desktop software 12

USB

- connector 16
- HotSync operations 222
- port 24

User name

- for ISP 143
- identifying handheld 153

User profiles 171

## V

Vendor for Expense item 130

## W

Warm reset 215

Warranty 235

Web pages

- bookmarking 196
- viewing 195

Web sites 25

Week (Date Book Plus view) 89, 141, 221

Week with Text (Date Book Plus view) 90

Windows 95, NT 12, 23, 222

Wireless communication

- Blazer web browser 195–203
- installing software 193
- One-Touch Mail 211
- Palm SMS 204–210
- using mobile phone 194

Wireless Suite 193–211

## X

XLT (Expense report template in Excel) 133

## Y

Year (Date Book Plus view) 91