



**Handbook for
Palm™ Tungsten™ T2
Handheld**

Copyright

© 1998–2003 Palm, Inc. All rights reserved. Graffiti, HotSync, MultiMail, PalmModem, Palm OS, and the Palm logo are registered trademarks of Palm, Inc. Palm, Palm Powered, Tungsten, and VersaMail are trademarks of Palm, Inc. Palm, Inc. uses the Bluetooth trademark under express license from Bluetooth SIG, Inc., U.S.A. All other brands are trademarks of or registered trademarks of their respective owners.

Disclaimer and Limitation of Liability

Palm, Inc. assumes no responsibility for any damage or loss resulting from the use of this handbook.

Palm assumes no responsibility for any loss or claims by third parties which may arise through the use of this software. Palm, Inc. assumes no responsibility for any damage or loss caused by deletion of data as a result of malfunction, dead battery, or repairs. Be sure to make backup copies of all important data on other media to protect against data loss.

IMPORTANT Please read the End User Software License Agreement with this product before using the accompanying software program(s). Using any part of the software indicates that you accept the terms of the End User Software License Agreement.

Contents

About This Book	1
Chapter 1: Setting Up Your Palm™ Tungsten™ T2 Handheld	3
System requirements	4
Minimum requirements: Windows computers	4
Minimum requirements: Mac computers	4
Internet access requirements	5
Upgrade information	5
Step 1: Connect the HotSync cradle/cable to the computer	5
Step 2: Charge your handheld	6
Step 3: Set up your handheld	6
Step 4: Install software	7
Step 5: Perform a HotSync operation	8
Step 6: Register your handheld	8
Congratulations!	8
Chapter 2: Exploring Your Handheld	9
Locating handheld components	10
Opening and closing your handheld	10
Locating front panel controls	11
Locating top panel components	12
Adjusting screen brightness	13
Locating back panel components	14
Using the protective cover	15
Adding an expansion card	16
Tapping and typing	17
Elements of the handheld interface	18
Using the navigator	20
Chapter 3: Entering Data on Your Handheld	23
Using the onscreen keyboard	23
Using Graffiti 2 writing to enter data	24
Graffiti 2 tips	26
Graffiti 2 alphabet	27

Capital letters	28
Graffiti 2 numbers	28
Punctuation marks	28
Accented characters	30
Symbols and other special characters	30
Graffiti 2 Gestures	32
Graffiti 2 ShortCuts	32
Full-screen writing area	33
Beaming data	33
Beaming tips	36
Sending data	36
Sending data using Bluetooth communication	36
Sending data using e-mail or SMS communication	37
Using your computer keyboard	37
Importing data	37
Importing data from a Windows computer	38
Importing data from a Mac computer	39
Using Note Pad	40
Using a portable keyboard	40
Chapter 4: Working with Applications	41
Opening applications	41
Other ways to open applications	42
Opening expansion card applications	42
Switching between applications	43
Categorizing applications	44
Changing the Applications Launcher display	45
Copying applications to or from an expansion card	46
Selecting copy settings	47
Using menus	48
Choosing a menu	49
Choosing application preferences	50
Performing common tasks	50
Creating records	50
Editing records	51
Deleting records	52
Purging records	54
Categorizing records	55
Finding information	58

Sorting lists of records	63
Attaching notes	65
Choosing fonts	66
Receiving alerts	67
Hiding or masking private records	68
Installing and removing applications	68
Installing files and add-on applications	68
Installing applications and files on a Windows computer	69
Palm Quick Install tips	72
Installing applications and files on a Mac computer	73
Removing applications	75
Removing Palm Desktop software	75
Chapter 5: Using Address Book	77
Creating an Address Book entry	78
Selecting types of phone numbers	79
Changing Address Entry details	80
Making connections from Address Book	81
Using Address Book menus	83
Chapter 6: Using Calculator	87
Performing calculations	87
Viewing Recent Calculations	88
Using Calculator menus	89
Chapter 7: Using Card Info	91
Reviewing Card Information	91
Renaming a card	92
Formatting a card	92
Managing expansion cards	93
Using Card Info menus	93
Card menu	93
Chapter 8: Using Date Book	95
Scheduling an event	96
Selecting an event	99
Rescheduling an event	99
Setting an alarm for an event	100
Scheduling repeating or continuous events	101
Changing the Date Book view	103

Working in Week View	104
Working in Month View	105
Working in Agenda View	106
Spotting event conflicts	107
Using Date Book menus	107
Record menu	108
Options menu	108
Chapter 9: Using Palm™ Dialer	111
Configuring phone preferences and connecting to your mobile phone	111
Dialing a number	112
Redialing the most recently dialed number	112
Using speed dial	113
Adding a speed dial entry	113
Dialing a speed dial entry	114
Editing a speed dial entry	115
Dialing a number from the Call History list	116
Chapter 10: Using Expense	119
Adding expense items	120
Changing the date of an Expense item	121
Entering receipt details	121
Customizing the Currency pick list	122
Changing the default currency	123
Defining a custom currency symbol	123
Setting Show Options	124
Working with Expense data on your computer	125
Displaying the euro on your computer	125
Printing the euro	125
Using Expense menus	126
Record menu	126
Options menu	126
Chapter 11: Using Memo Pad	127
Creating memos	127
Reviewing memos	128
Using Memo Pad menus	129
Record menus	129
Options menus	129

Chapter 12: Using Note Pad	131
Creating a note	132
Reviewing notes	133
Changing Note Pad color settings	133
Setting an alarm for a note	134
Using Note Pad menus	136
Record menu	136
Options menus	136
Chapter 13: Using Palm™ Photos	137
Viewing photos	137
Viewing photos in Thumbnail view	138
Viewing photos in List view	138
Viewing a slide show	139
Rotating photos	140
Viewing photo information	140
Organizing photos	141
Sorting photos in List view	141
Creating an album	142
Filing photos in albums	142
Copying photos	143
Renaming or deleting an album	144
Beaming photos	145
Deleting photos	146
Working with photos on your computer	146
Using Palm Photos menus	147
Photo menu	147
Options menus	147
Chapter 14: Using Phone Link	149
What can you do with a phone connection?	149
Setting up a phone connection	150
Configuring network service settings for your phone	153
Updating the phone files on your handheld	156
Using phone connections	157
Chapter 15: Using SMS	159
Configuring phone preferences and connecting to your mobile phone	159
Using the navigator in SMS	160
Creating messages	160

Sending and receiving messages	161
Viewing messages	162
Working with draft messages	164
Adding a signature to a message	165
Sending data from another application	166
Setting SMS Preferences	167
Using SMS menus	169
Chapter 16: Using To Do List	171
Creating list items	172
Setting priority	172
Checking off a To Do List item	173
Changing To Do List item details	173
Setting a due date	174
Setting To Do Preferences	175
Using To Do List menus	176
Record menu	176
Options menu	176
Chapter 17: Using Palm™ VersaMail™ Personal E-mail Software	177
Palm™ VersaMail™ personal e-mail software features	177
Getting started with the VersaMail application	178
Synchronizing an existing username	178
Upgrading a MultiMail/VersaMail database	178
Setting up and managing e-mail accounts	179
Account and connection types	179
Network e-mail account prerequisites	180
Creating a network e-mail account	182
Creating a synchronize-only account	189
Editing e-mail accounts	196
Deleting an e-mail account	203
Selecting a different service for a given e-mail account	204
Troubleshooting account access problems	206
Getting, sending, and managing e-mail	206
Getting e-mail	206
Auto get mail with notification	209
Inbox icons in the VersaMail application	217
Reading e-mail	218
Creating and editing mail folders	228

Creating and sending new e-mail	229
Working with URLs	241
Working with attachments	241
Deleting messages	251
Emptying the trash	254
Marking messages as read or unread	256
Setting preferences for getting and deleting e-mail	257
Adding or updating an Address Book entry directly from a message ..	258
Synchronizing e-mail between the handheld and the desktop	259
Configuring an account in HotSync Manager	260
Setting synchronization options and account settings	261
Converting attached files	274
Synchronizing an account	276
Using SSL with the conduit	278
Going beyond the basics	278
Managing mail filters	279
Managing mail settings	283
Adding APOP to an account	291
Adding ESMTP to an account	293
Setting advanced account preferences	294
Cutting and copying text from an e-mail message for use in other applications	296
Using the command bar	297
E-mail header details	298
Backing up mail databases	299
Wireless IMAP folder synchronization	300
Using Secure Sockets Layer (SSL)	302
Five-way navigation in the VersaMail application	302
Keyboard shortcuts in the VersaMail application	304
Chapter 18: Using Voice Memo	307
Creating a voice memo	308
Recording a voice memo	308
Pausing and resuming a voice memo recording	309
Storing voice memos on an expansion card	311
Listening to voice memos	312
Setting an alarm for a voice memo	313

Using Voice Memo menus	315
V Memo menus	315
Options menus	315
Chapter 19: Using Web Browser Pro	317
What Web Browser Pro looks like	318
Getting help in Web Browser Pro	319
Disconnecting from and connecting to the Internet	319
Browsing the web on your handheld	320
Visiting a web page	320
Following a link	321
Returning to a web page you just visited	322
Returning to your home page	322
Downloading a file to your handheld	322
Refreshing a page	324
Viewing information about a web page	324
Using passwords	325
Copying and pasting text	326
Copying text	326
Pasting text	326
Communicating with other users	327
Sending e-mail	327
Beaming a URL	327
E-mailing a URL	328
Bookmarking your favorite pages	329
Adding a bookmark	329
Visiting a bookmarked page	329
Editing information about a bookmark	330
Deleting a bookmark	330
Saving pages	331
Saving a page	331
Opening a saved page	331
Editing information about a saved page	332
Deleting a saved page	333
Finding web pages you recently visited	333
Returning to a page you visited	333
Clearing the History list	334
Customizing Web Browser Pro	334
Changing the default size of text	334

Changing your home page	335
Changing how images are downloaded	336
Changing link colors	337
Enabling or disabling autofill	337
Enabling or disabling cookies	338
Enabling or disabling JavaScript	338
Changing the size and content of the cache	339
Controlling how Web Browser Pro accesses the Internet	340
Changing Network Preferences	340
Changing the host server	341
Chapter 20: Using World Clock	343
Viewing the time	344
Setting the primary location	344
Choosing a different primary location	346
Setting the secondary locations	346
Adding a location	347
Modifying a location	348
Removing a location	349
Setting an alarm	349
Using World Clock menus	350
Chapter 21: Performing HotSync® Operations	351
Selecting HotSync setup options	351
Customizing HotSync application settings	354
Conducting cradle/cable HotSync operations	357
Performing a cradle/cable HotSync operation: Windows computers ...	357
Performing a direct HotSync operation: Mac computers	359
Conducting IR HotSync operations	361
Preparing your computer for infrared communication	361
Performing an IR HotSync operation	363
Returning to cradle/cable HotSync operations	364
Conducting modem HotSync operations	365
Preparing your computer for a modem HotSync operation	365
Preparing your handheld for a modem HotSync operation	367
Selecting the conduits for a modem HotSync operation	369
Performing a modem HotSync operation	369
Conducting Bluetooth HotSync operations	370
Preparing your computer for a Bluetooth HotSync operation	370

Preparing your handheld for a Bluetooth HotSync operation	371
Performing a Bluetooth HotSync operation	372
Conducting network HotSync operations	372
Connecting to your company's dial-in server	373
Performing a network HotSync operation	375
Using File Link	375
Creating a user profile	376
Performing the first HotSync operation with a user profile	378
Chapter 22: Setting Preferences for Your Handheld	379
Setting General Preferences	380
Date & Time Preferences	381
Digitizer Preferences	382
Formats Preferences	382
Graffiti 2 Preferences	384
Power Preferences	384
Sounds & Alerts Preferences	386
Writing Area Preferences	388
Setting Communication Preferences	389
Bluetooth Preferences	389
Connection Preferences	398
Network Preferences	403
Phone Preferences	420
Setting Personal Preferences	420
Buttons Preferences	421
Pen Preferences	422
HotSync Buttons Preferences	423
Color Theme Preferences	424
Owner Preferences	424
Security Preferences	425
Locking your handheld	429
Recovering from a forgotten password	432
Making records private	433
ShortCuts Preferences	440
Appendix A: Maintaining Your Handheld	443
Caring for your handheld	443
Prolonging battery life	444
Resetting your handheld	444

Performing a soft reset	445
Performing a hard reset	445
Appendix B: Frequently Asked Questions	449
Software installation problems	450
Operating problems	451
Tapping and writing problems	452
Application problems	453
HotSync problems	454
Beaming and sending problems	461
Phone connection problems	462
VersaMail™ problems	463
Recharging problems	464
Password problems	465
Technical support	465
Product Regulatory Information	467
Index	471

About This Book

Congratulations on your purchase of a Palm™ Tungsten™ T2 handheld. This handbook is designed to quickly familiarize you with your handheld. It describes all you need to know about how to use your handheld and the applications that come with it. It guides you through:

- Locating all the parts of your handheld
- Viewing and entering data
- Setting up Bluetooth™ features and wireless communication features
- Working with expansion cards
- Using your handheld with your computer
- Personalizing your handheld with your own preference settings

After you become familiar with the basic functionality of your handheld, you can use the rest of this handbook as a reference guide for less common tasks, for maintenance of your handheld, and for any problems that might arise as you operate your handheld.

Setting Up Your Palm™ Tungsten™ T2 Handheld

Your new Palm™ Tungsten™ T2 handheld enables you to do the following:

- Access your data and view or look up information with one hand, using the navigator.
- Capture thoughts while you're on the go, with the voice recorder.
- Exchange data with other Bluetooth™ devices such as handhelds, phones, PCs, printers, networks, and more (other Bluetooth devices sold separately).
- Share data, make backups, and extend storage capacity with optional expansion cards (expansion slot included; expansion cards sold separately).
- View clear, sharp, colorful images on the high-resolution screen.
- Stay organized and on time by keeping your appointments, contact information, and to-do items in one place.
- Quickly jot notes or memos on the fly.
- Access the Internet and browse or search your favorite web sites.
- Send, receive, and compose e-mail and SMS messages.
- View and edit digital pictures.
- Read documents on the go.

To use the Bluetooth communication features, you must have a mobile phone that supports infrared or Bluetooth communication. For more information, see [Chapter 14](#). Web browsing and e-mail applications also require Internet access. See “[Internet access requirements](#)” later in this chapter for details.

System requirements

To install and operate Palm™ Desktop software, your computer system must meet the requirements described in this section.

Minimum requirements: Windows computers

The minimum requirements for Windows computers are as follows:

- IBM-compatible Pentium-class computer
- One of the following operating systems:
 - Windows NT 4.0 Workstation and SP6 or later (requires a serial cradle/cable—sold separately—and administrator rights to install Palm Desktop software)
 - Windows 98
 - Windows ME
 - Windows 2000 Pro (requires administrator rights to install Palm Desktop software)
 - Windows XP Home or Pro (requires administrator rights to install Palm Desktop software)
- Internet Explorer 4.01 with SP2 or later
- 50 megabytes (MB) available hard disk space
- VGA monitor or better (Palm Desktop software *Quick Tour* requires 256-color video display; 16 Bit or High Color, and 800 x 600 resolution recommended)
- CD-ROM or DVD-ROM drive.
- Mouse
- One available USB port or serial port (serial cradle/cable sold separately)

Minimum requirements: Mac computers

The minimum requirements for Mac computers are as follows:

- Mac computer or compatible with a PowerPC processor
- Mac OS 9, version 9.1 or later with 12MB available memory or Mac OS X, version 10.1.2 or later
- 25MB available hard disk space
- Monitor that supports screen resolution of 800 x 600 or better

- CD-ROM or DVD-ROM drive (you can also download Palm Desktop software from www.palm.com/intl).
- Mouse
- One available USB port or serial port (serial cradle/cable sold separately and compatible with Mac OS 9 only)

Internet access requirements

The requirements for Internet access are as follows:

- Any one of the following:
 - A Bluetooth mobile phone
 - An IR-enabled mobile phone
 - A mobile phone with a cable that connects to your handheld
 - A modem accessory for your handheld
 - A Bluetooth network connection with Internet access
- An account with an ISP, or Internet service provided by your company

NOTE A data connection service may also be required by some mobile phone network providers.

Upgrade information

If you already own a Palm OS® handheld, go to the web site www.palm.com/support/global-support for upgrade instructions.

Step 1: Connect the HotSync cradle/cable to the computer

- a. Locate the USB icon and ports on your computer.
- b. Plug the USB connector into a USB port on your computer.
- c. Connect the adapter cable to the back of the cradle/cable.

NOTE Your adapter may connect to the back of the USB connector, not to the cradle itself.

- d. Plug the adapter into a working electric outlet.

- e. Windows NT users cannot use a USB cradle/cable and port. You must use a cradle with a serial port connection (sold separately).

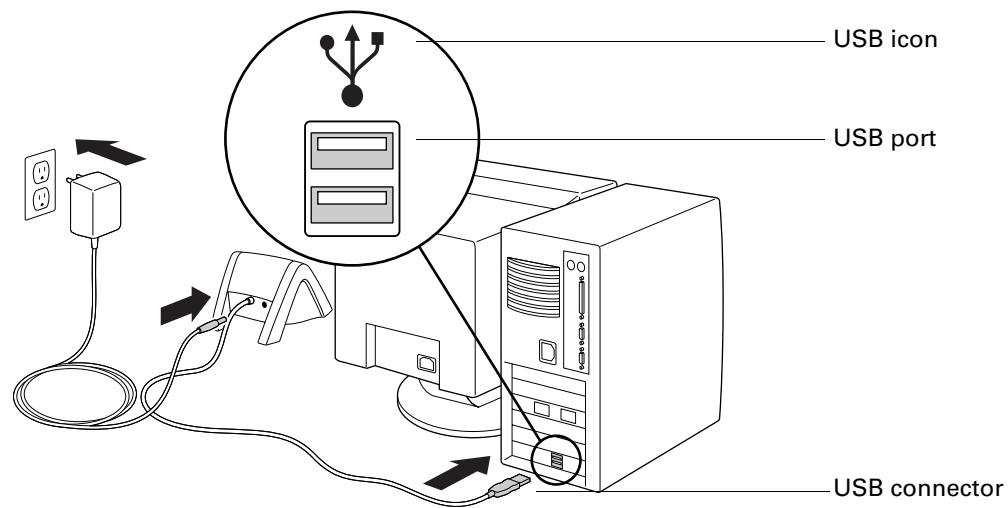

Step 2: Charge your handheld

- a. Place your handheld in the cradle/cable for at least two hours for an initial charge. Your handheld's indicator light glows steady green when it is charging.
- b. After it is charged, remove the handheld from the cradle/cable by gently tilting it forward and then lifting it from the cradle/cable.

Once your handheld is setup and in daily use it requires about 15 to 30 minutes of charge time per day, depending on usage. To keep the battery fully charged, we recommend placing your handheld in a cradle/cable that is connected to a power source whenever you are not using it.

Step 3: Set up your handheld

- a. Press the power button to turn on your handheld.
If your handheld did not turn on, see [“Operating problems”](#) in [Appendix B](#).
- b. Gently press the top of the stylus to release it from the slot, and then remove it from the slot.

- c. Hold the stylus like you would a pen or pencil, and use it to follow the onscreen directions.

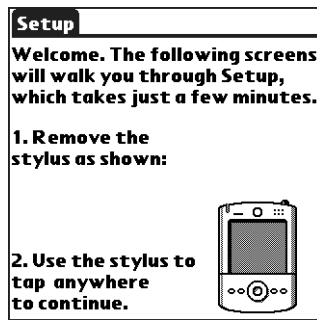

Step 4: Install software

- a. Insert the Desktop Software CD-ROM into your computer's CD-ROM drive.
- b. **Windows:** Follow the onscreen instructions which guide you through installing Palm Desktop software and entering your handheld business card information.

Mac: Double-click the Desktop Software CD-ROM icon that appears on the desktop, and then double-click the Palm Desktop Installer icon.

NOTE You need administrator rights to install Palm Desktop software on a computer running Windows NT/2000/XP or Mac OS X.

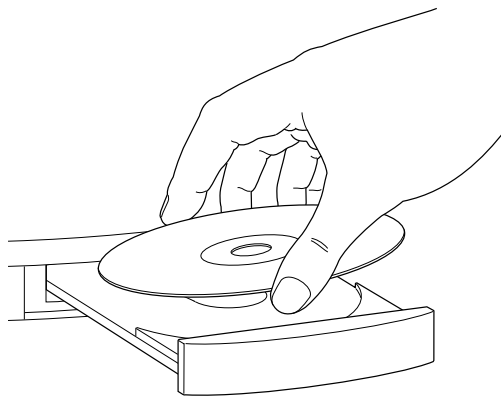

Step 5: Perform a HotSync operation

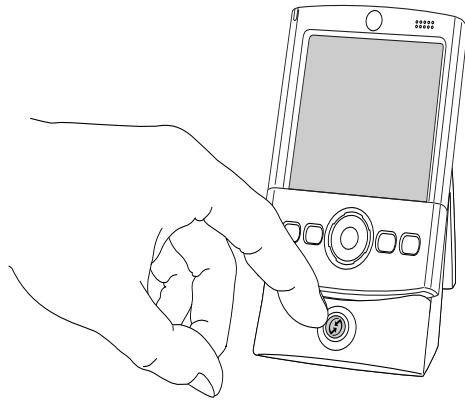

Windows: When prompted, place your handheld in the cradle/cable and press the HotSync button.

Mac: After the installation finishes, place your handheld in the cradle/cable and press the HotSync button.

Tip: You can also perform a HotSync operation using Bluetooth communication. For more information, see [“Performing a Bluetooth HotSync operation”](#) in [Chapter 21](#).

Step 6: Register your handheld

Windows: When the first HotSync operation is complete, the installer displays screens where you can select product registration options. After you complete these screens, the Congratulations! screen appears.

Macintosh: When the first HotSync operation is complete, double-click the Palm Desktop software icon in the Palm folder (inside the Applications folder by default) to access screens where you can select product registration options. After you complete these screens, the Congratulations! screen appears.

Congratulations!

You’ve set up your handheld, installed Palm Desktop software, performed your first HotSync operation, and registered your handheld. If you’re using a Windows computer, you also created your handheld business card. For comprehensive information about using your handheld, continue reading this electronic *handbook*.

For more information about using Palm Desktop software, see the following:

- The online help for Palm Desktop software. To access the online help, go to the Help menu in Palm Desktop software.
- **Mac:** The electronic *Palm Desktop Software for the Macintosh User’s Guide*. To access this guide, open the Palm folder, and then open the Documentation folder. Double-click the file Palm Desktop.pdf.

Exploring Your Handheld

Your Palm™ Tungsten™ T2 handheld can help you stay organized, on time, and up-to-date with daily tasks while you are away from your desk. Use your new handheld to do the following:

- Enter your schedule in Date Book.
- Keep all your contact names, addresses, and phone numbers in Address Book.
- Prioritize and assign your tasks a due date in To Do List.
- Jot quick notes directly on the screen in Note Pad.
- Record thoughts and listen to them later in Voice Memo.
- Track your expenses and create expense reports in Expense.
- Set alarms from World Clock, Date Book, Note Pad, and Voice Memo to keep yourself on schedule and remind yourself of appointments and notes.
- Set preferences for how you receive alarms: hearing a sound, seeing a blinking indicator light, or feeling your handheld vibrate. Choose any combination.
- Synchronize your data with Palm™ Desktop software on your Windows or Mac computer so you always have a backup copy.
- Insert an SD, SDIO, or MultiMediaCard expansion card to add more software or memory or to back up your data.
- Connect your handheld with a mobile phone to access the Internet, send SMS messages, and exchange e-mail messages.
- Share information with other devices that are capable of Bluetooth™ communication or that have an infrared (IR) port.
- View and edit digital pictures.
- Read books or other documents.

When you install the software from the Software Essentials CD-ROM that comes with your handheld, your handheld can also help you connect and collaborate with friends and co-workers, play video clips and MP3 files (expansion card

required, sold separately), and access productivity tools. This additional software enables you to use your handheld to do the following:

- Chat and collaborate with friends and co-workers who have Bluetooth devices.
- Play MP3 audio files (expansion card required, sold separately).

NOTE To install some software, you may need to download files from the Internet to your computer. Check the Software Essentials CD for details.

Locating handheld components

Take a few moments to learn how to access and locate the components of your handheld.

Opening and closing your handheld

When your handheld is open, you can access additional controls on the front and back panels. You can use your handheld in either the open or closed position.

To open your handheld:

- Slide the bottom portion of your handheld away from the screen.

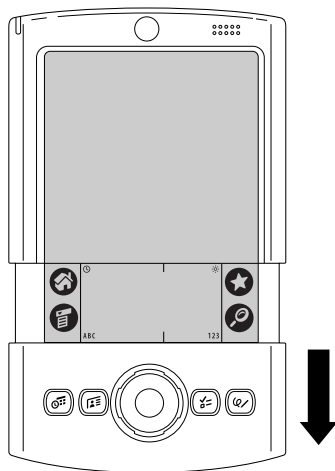

To close your handheld:

- Slide the bottom portion of your handheld toward the screen.

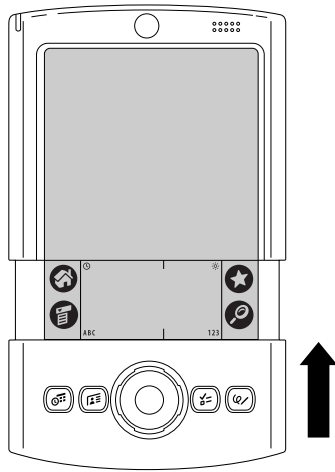

Locating front panel controls

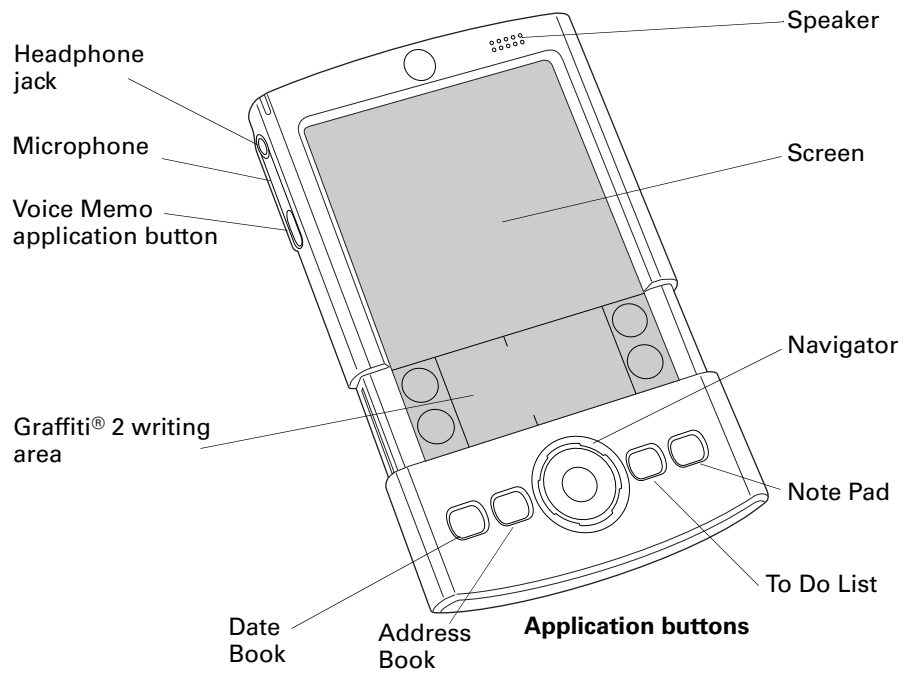

Navigator	Enables you to select and display records on your handheld screen. See “Using the navigator” later in this chapter for additional information, and look for tips throughout this handbook.
Application buttons	Activates the individual handheld applications that correspond to the icons on the buttons: Date Book, Address Book, To Do List, Note Pad, and Voice Memo. See “Buttons Preferences” in Chapter 22 for details on reassigning these buttons to activate any application on your handheld.
Headphone jack	Enables you to connect a standard 3.5mm stereo headset (sold separately) to your handheld for use with audio applications.
Speaker	Enables you to listen to alarms, voice memos, and game sounds on your handheld.
Microphone	Serves as an audio input device for applications such as Voice Memo.
Screen	Displays the applications and information stored in your handheld. It is touch sensitive, and it responds to the stylus.
Graffiti® 2 writing area	The area where you write letters and numbers using Graffiti 2. See “Using Graffiti 2 writing to enter data” in Chapter 3 to learn how to write Graffiti 2 characters.

Locating top panel components

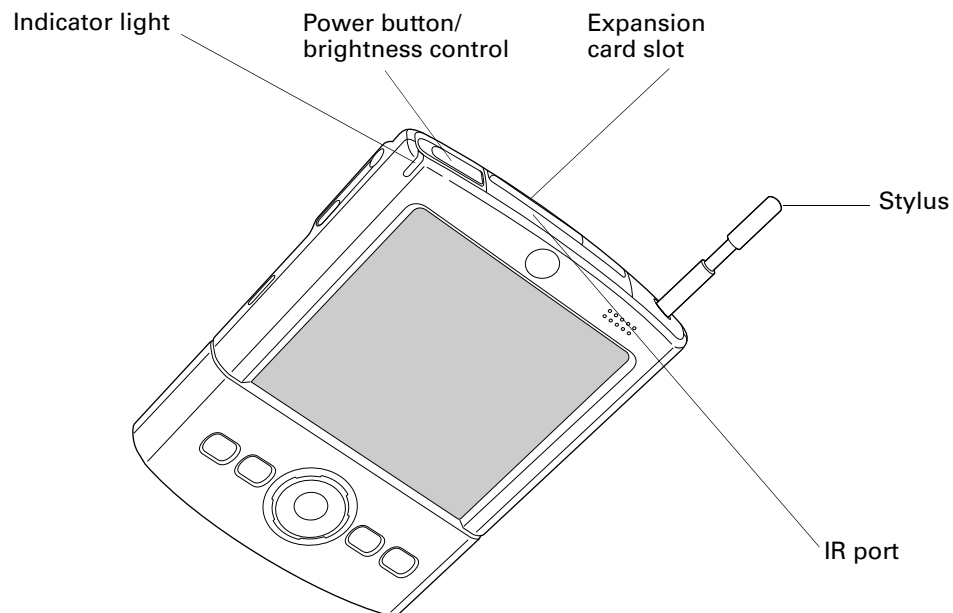

Indicator light	Serves as an alert for Date Book, World Clock, Note Pad, or Voice Memo alarms. It also indicates the battery-charging status when your handheld is in the cradle/cable.
Power button/ brightness control	<p>Turns your handheld on or off. If your handheld is turned off, pressing the power button turns the handheld on and returns you to the last screen you viewed.</p> <p>If your handheld is turned on, you can turn it off by pressing the power button. You can also press and hold the power button down for about two seconds to access brightness control. For more information, see “Adjusting screen brightness” later in this chapter.</p>
Expansion card slot	Accepts SD, SDIO, or MultiMediaCard (MMC) expansion cards. Expansion cards enable you to back up data, add more memory, add wireless communication features, or use additional applications. (Expansion cards sold separately.)
Stylus	Slides in and out of the slot on the top of your handheld. To use the stylus, gently press the top of the stylus to release it from the slot, and then pull it out of the slot and hold it as you would a pen or pencil.
IR port	Uses infrared technology to transmit data to and receive data from other infrared-enabled devices and to perform HotSync® operations. See “Beaming data” in Chapter 3 and see “Conducting IR HotSync operations” in Chapter 21 for more information.

Adjusting screen brightness

If lighting conditions make it difficult for you to see the information on your handheld, you can adjust the brightness of the screen backlight.

To adjust the brightness of the backlight:

1. Tap the Brightness icon  in the upper-right corner of the Graffiti 2 writing area.

TIP You can also press and hold the power button for about two seconds to access brightness control. In addition, you can assign the full-screen pen stroke to access the brightness control. See [“Pen Preferences”](#) in [Chapter 22](#) for details.

2. Drag the slider to adjust the brightness.



TIP You can also press Up or Down on the navigator to adjust the brightness.

3. Tap Done.

Locating back panel components

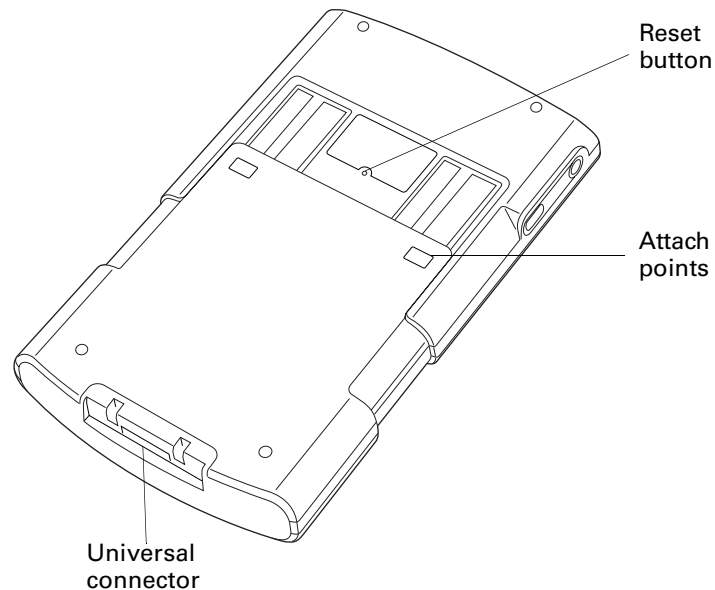

- Reset button** Resets your handheld. Under normal use, you should not have to use the reset button. See [“Resetting your handheld”](#) in [Appendix A](#) for information about when and how to use the reset button.
- Attach points** Enable you to connect optional accessories to your handheld, such as a modem or sled. These accessories are sold separately and are typically available from third-party developers.
- Universal connector** Connects your handheld to the cradle/cable, which in turn connects to the back of your computer and through the AC adapter to the wall current. This enables you to recharge your handheld as well as update the information between your handheld and your computer, using HotSync technology.
- The universal connector also connects peripheral hardware devices to your handheld, such as an external battery pack or keyboard (sold separately).

Using the protective cover

The cover protects your handheld screen when it is not in use. When the cover is on, you can still view information on your handheld and use the navigator to navigate through your data and accomplish tasks.

To remove the cover:

1. Gently lift one of the cover tabs from the side of your handheld.

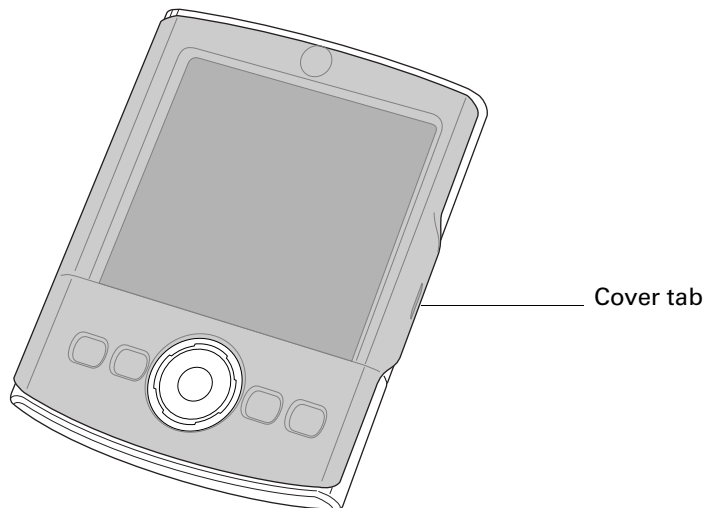

2. Store the cover by aligning the cover tabs with the notches on the sides of your handheld, and then gently pressing it onto the back of your handheld.

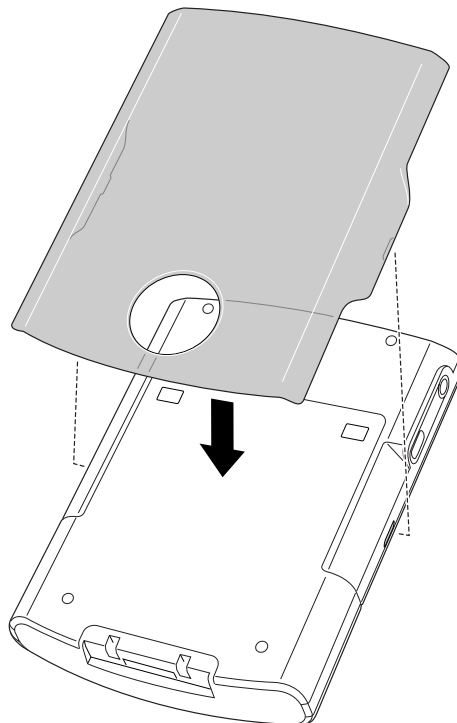

Adding an expansion card

An expansion card (sold separately) increases the variety of tasks you can do and the amount of space you have to store software and data on your handheld.

To insert a card:

1. Insert the card into the expansion slot with the label side facing the display.
2. Push lightly against the card with your thumb.

When the card is released, you hear the system sound if system sounds are turned on. See [“Sounds & Alerts Preferences”](#) in [Chapter 22](#) for more information on turning system sounds on and off.

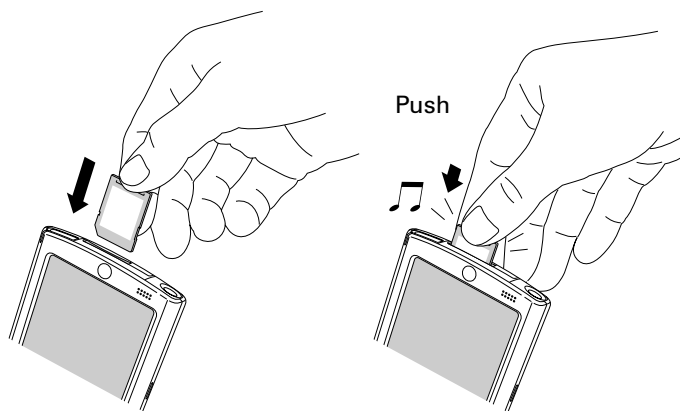

To remove a card:

1. Push lightly against the card with your thumb.

When the card is released, you hear the system sound.

2. Slide the card out of the expansion slot.

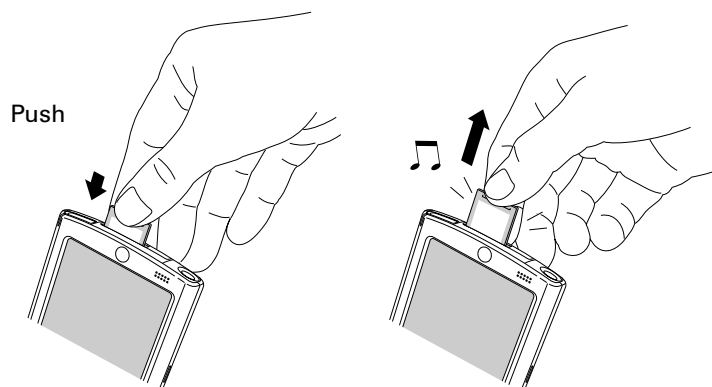

For complete information about working with expansion cards, see [Chapter 7](#).

Tapping and typing

Like using a mouse to click elements on a computer screen, using the stylus to tap elements on your handheld screen is the basic action you use to get things done on your handheld.

The first time you start your handheld, the setup instructions appear on the screen. These instructions include a calibration screen. Calibration aligns the internal circuitry of your handheld with its touch-sensitive screen so that when you tap an element on the screen, the handheld can detect exactly which task you want to perform.

IMPORTANT Always use the point of the stylus for tapping or for making strokes on the handheld screen. Never use an actual pen, pencil, or other sharp object to write on the handheld screen as this will scratch the screen.

With your handheld turned on, you can tap the handheld screen to perform many operations, such as the following:

- Open applications.
- Select menu commands.
- Initiate a Find operation to search through applications installed on your handheld for specific text (Find operations do not search through applications on expansion cards).
- Select options in dialog boxes.
- Open the onscreen keyboards.

Just as you can drag the mouse to select text or move objects on your computer, you can drag the stylus to select text. You can also use the stylus to drag the slider of any scroll bar.

Elements of the handheld interface



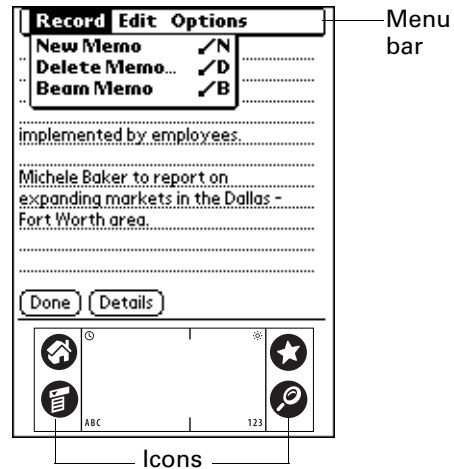

There are many common elements in the handheld interface. These elements are described in this section.



Menu bar

Use the menu bar to access a set of application-specific commands. Not all applications have a menu bar.

Icons

Tap the icons to open applications , menus , and a favorite application , and to find text anywhere in your data .

See [“Opening applications,”](#) [“Using menus,”](#) and [“Finding information”](#) in [Chapter 4](#), and see [“Buttons Preferences”](#) in [Chapter 22](#) for more information about using these icons.

Brightness control

Tap the Brightness icon  to open the Adjust Brightness dialog box. See [“Adjusting screen brightness”](#) earlier in this chapter for instructions on adjusting the brightness.

Clock

Tap the Clock icon  to display the current time and date. The display closes automatically after two seconds.

ABC

With the cursor in an input field, tap ABC to activate the alphabetic keyboard.

123

With the cursor in an input field, tap 123 to activate the numeric keyboard.

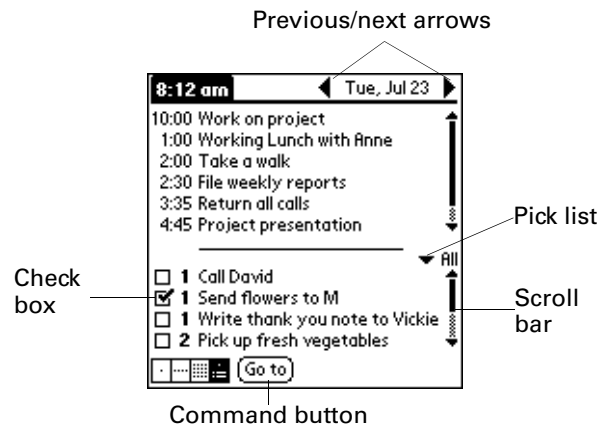

Check box Tap a check box to select or deselect it. When a check box contains a check mark, the corresponding option is selected and active. When a check box is empty, the corresponding option is deselected and inactive.

Command buttons Tap a button to perform a command. Command buttons appear at the bottom of dialog boxes and application screens.

Next/previous arrows Tap the left and right arrows to display the previous and next records; tap the up and down arrows to display the previous and next pages of information.

Pick list Tap the arrow to display a list of choices, and then tap an item in the list to select it.

Scroll bar Drag the slider, or tap the top or bottom arrow, to scroll the display one line at a time. To scroll to the previous page, tap the scroll bar just above the slider. To scroll to the next page, tap the scroll bar just below the slider.



You can also scroll to the previous and next pages within a record by pressing Up and Down on the navigator.

Displaying online tips

Many of the dialog boxes that appear on your handheld contain an online Tips icon in the upper-right corner. Online tips anticipate questions you might have in a dialog box, provide shortcuts for using the dialog box, or give you other useful information.

To display an online tip:

1. Tap the Tips icon ⓘ.
2. After you review the tip, tap Done.

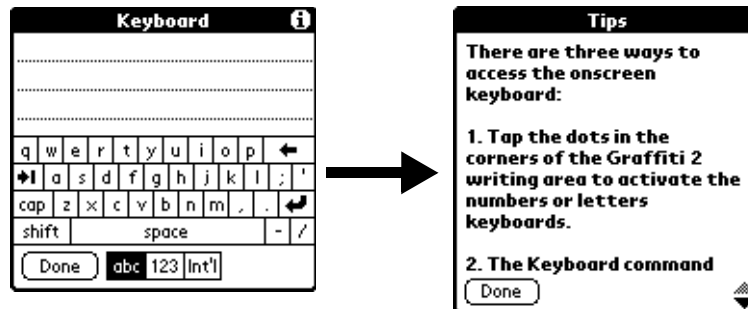

Using the navigator

When you work with most applications, the navigator on the front panel of your handheld makes it easy for you to navigate among and select your entries. You can use the navigator to perform tasks without the stylus using one hand.



Look for the navigator icon to find navigator tips throughout this guide. See [Chapter 4](#) and [Chapter 5](#) for additional information about using the navigator with Address Book, and [Chapter 8](#) for additional information on using the navigator with Date Book.

To navigate in list screens, do any of the following:

- Press Up or Down on the navigator to scroll an entire screen of records.
- Press and hold Up or Down on the navigator to accelerate the scrolling.
- Press Select, the middle button, on the navigator to insert the selection highlight. When the selection highlight is present, you can do the following:
 - Press Up or Down on the navigator to scroll to the previous or next records.
 - Press Select again to view the selected record.
 - Press Left on the navigator to remove the selection highlight.

To navigate in record screens:

1. Press Up or Down on the navigator to scroll within the current record.
2. Press Right or Left on the navigator to scroll to the previous or next record. (This feature is not available in Address Book.)
3. Press Select on the navigator to return to the list screen.

To navigate in dialog boxes:

- While a pick list is open, press Up or Down on the navigator to highlight an item, and then press Select on the navigator to select the item.
- Press Select on the navigator to close a dialog.
 - If there is only one button, pressing Select activates that button.
 - If there are two buttons, pressing Select activates the action button instead of Cancel, such as OK, Yes, or Delete.
 - If there are multiple buttons, Select activates affirming buttons such as OK, Yes, or Done.

IMPORTANT Read dialog boxes carefully. Sometimes, selecting a single button, OK or Yes results in canceling an operation or deleting data.

Entering Data on Your Handheld

This chapter explains several ways to enter data on your handheld, and it covers the following topics:

- Using the onscreen keyboard
- Using Graffiti® 2 writing
- Beaming data between devices with infrared (IR) ports
- Sending data between devices
- Entering or importing data in Palm™ Desktop software and then synchronizing with your handheld
- Using Note Pad
- Using a portable keyboard accessory, sold separately and attached to the universal connector

Using the onscreen keyboard

You can open the onscreen keyboard anytime you need to enter text or numbers on your handheld. You can also use Graffiti 2 writing when the keyboard is open, which makes it easy to switch between these two methods of entering data.

To use the onscreen keyboard:

1. Open any application (such as Memo Pad).
2. Tap any record, or tap New.
3. Tap ABC to open the alphabetic keyboard, or tap 123 to open the numeric keyboard.

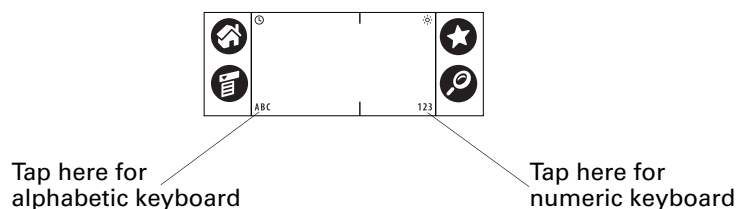

4. Tap the characters to enter text and numbers.

When a keyboard is open, you can tap the abc, 123, or Int'l boxes to open any of the other keyboards, including the international keyboard.

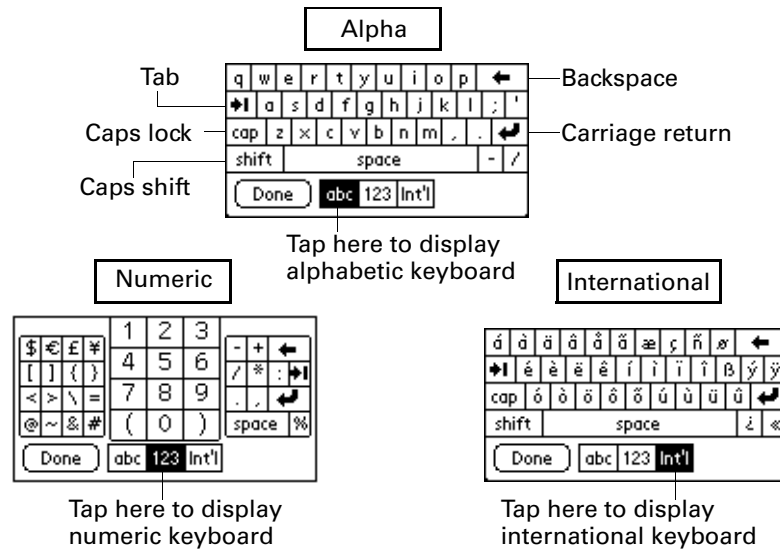

After you finish, tap Done to close the onscreen keyboard and place the text in the record.

Using Graffiti 2 writing to enter data

In this section you learn the procedures for creating letters, numbers, punctuation, and symbols, as well as some Graffiti 2 tips and tricks.

Most people find they can enter text quickly and accurately with only minutes of practice. Graffiti 2 writing includes any character you can type on a standard keyboard. The Graffiti 2 characters closely resemble the letters of the regular alphabet, which makes Graffiti 2 writing easy to learn. Graffiti 2 writing is different from the writing software found on earlier Palm™ handhelds. For example, some characters are formed using a single stroke while others are formed with more than one stroke.

There are four basic concepts for success with Graffiti 2 writing:

- If you draw the character shape exactly as shown in the tables later in this chapter (like the shapes shown in the following diagram), you can increase the accuracy of your writing.



- The heavy dot on each shape shows where to begin the stroke. Certain characters have similar shapes but different beginning and end points. Always begin the stroke at the heavy dot. (You should not create the heavy dot; it is there only to show you where to begin the stroke.)
- Graffiti 2 includes symbols made with a single stroke and symbols made with multiple strokes. With some multi-stroke symbols, the first stroke is the same as a single stroke symbol. As a result, the down stroke for the letter “i” cannot be recognized as an “i” at the end of the down stroke. The “i” will not be recognized as an “i” until you enter another symbol that establishes, by its shape or position, that the down stroke was not part of a two-stroke character (such as “t” or “k”), or until a limited time window expires. Similarly, recognition of a space symbol (a horizontal stroke from left to right) or a period symbol after a down stroke is dependent upon where the down stroke was drawn.
- The Graffiti 2 writing area is divided into two parts: one for writing lowercase letters and one for writing numbers. Capital letters are formed across the imaginary line that divides the two areas. The small marks at the top and bottom of the Graffiti 2 writing area indicate the two areas.

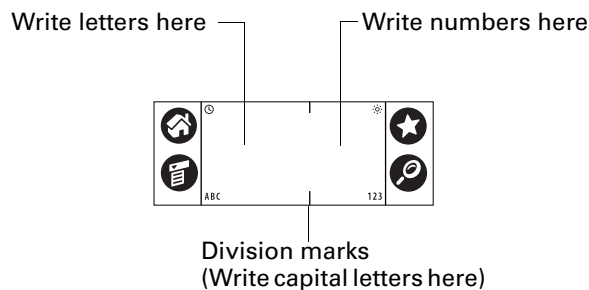

To write Graffiti 2 characters:

1. Tap the screen where you want your text to appear.
You need to tap above the Graffiti 2 writing area, and you must see a blinking cursor before you write the text.
2. Use the tables on the following pages to find the stroke shape for the letter you want to create. For example, the stroke shown below creates the letter *n*.

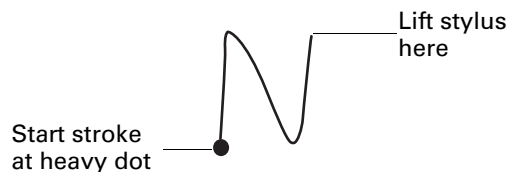

3. Position the stylus in the left side of the Graffiti 2 writing area.
4. Start your stroke at the heavy dot, and draw the first stroke shape as it appears in the tables.

5. Do one of the following:

- If you are drawing a single stroke character, lift the stylus from the screen at the end of the stroke shape. When you lift the stylus from the screen, your handheld recognizes your stroke and prints the letter at the insertion point on the screen.
- If you are drawing a multi-stroke character, draw the remaining strokes required for the character. The order of the strokes required is shown in the tables. When you lift the stylus from the screen after drawing the last stroke, your handheld prints the letter at the insertion point on the screen.

To delete Graffiti 2 characters:

- Set the insertion point to the right of the character you want to delete and make the backspace stroke in the Graffiti 2 writing area.

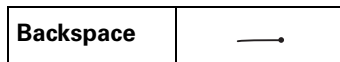



























Graffiti 2 tips

When using Graffiti 2 writing, keep these tips in mind:

- Accuracy improves when you write large characters. Draw strokes that nearly fill the Graffiti 2 writing area.
- Write at natural speed. Writing too slowly can generate recognition errors.
- Press firmly and do not write on a slant. Vertical strokes should be parallel to the sides of the Graffiti 2 writing area.
- Alternate stroke shapes are available for some characters. You can use the Graffiti 2 Preferences screen to choose the one that's easiest for you. See "[Graffiti 2 Preferences](#)" in [Chapter 22](#).

Graffiti 2 alphabet

The Graffiti 2 alphabet consists of the following letters:

Draw letters on LEFT side of Graffiti 2 writing area			
Letter	Strokes	Letter	Strokes
A		B	
C		D	
E		F	
G		H	
I		J	
K		L	
M		N	
O		P	
Q		R	
S		T	
U		V	
W		X	
Y		Z	

TIP A full-screen pen stroke brings up Graffiti 2 Help on your handheld. See [“Pen Preferences”](#) in [Chapter 22](#) for details.

Capital letters

Graffiti 2 writing automatically capitalizes the first letter of a new record or sentence but you can also write additional capital letters.

NOTE To cancel the automatic capitalization of the first letter of a new record or sentence, draw two Punctuation Shift strokes before drawing the first letter. For more information, see [“Symbols and other special characters”](#) later in this chapter.

To write additional capital letters:

- Draw the same stroke shapes used for a lowercase letter, but write across the division line in the middle of the Graffiti 2 writing area.

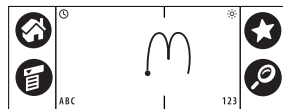

Division marks

Graffiti 2 numbers

Writing numbers with Graffiti 2 writing is similar to writing letters of the alphabet, except that you make the character strokes on the right side (numbers side) of the Graffiti 2 writing area.

Draw numbers on RIGHT side of Graffiti 2 writing area			
Number	Strokes	Number	Strokes
0		1	
2		3	
4		5	
6		7	
8		9	

Punctuation marks

With Graffiti 2 writing you can create any punctuation mark that you can enter from a standard keyboard. You can write the period and comma strokes on either side of the Graffiti 2 writing area. You must write other punctuation marks on a

designated side of the Graffiti 2 writing area. Punctuation marks that appear in the following table must be written on the left (letter) side of the Graffiti 2 writing area.

Draw these marks on LEFT side of Graffiti 2 writing area			
Mark	Stroke	Mark	Stroke
Period .		Ampersand &	
Comma ,		Carriage return	
Apostrophe '		At @	
Space		Straight quotes "	
Question ?		Tab	
Exclamation !			

Punctuation marks that appear in the following table must be written on the right (number) side of the Graffiti 2 writing area.

Draw these marks on RIGHT side of Graffiti 2 writing area			
Mark	Stroke	Mark	Stroke
Period .		Backslash \	
Comma ,		Slash /	
Tilde ~		Left Paren (
Dash -		Right Paren)	
Plus +		Equal =	
Asterisk *			

Accented characters

When writing letters with accent marks, first write the letter stroke on the left side (or aligned with the division marks for uppercase letters) of the Graffiti 2 writing area. Then quickly write the accent stroke on the right side of the Graffiti 2 writing area.

For example, the following diagram shows the strokes required to draw an accented *é*.

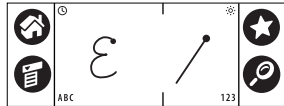

You can use the following accent strokes in combination with Graffiti 2 letters:

Draw accents on RIGHT side of Graffiti 2 writing area			
Accent	Stroke	Accent	Stroke
Acute á		Dieresis ä	
Grave à		Circumflex â	
Tilde ã		Ring å	

Using these accent strokes, you can write the following accented letters:

à á â ã ä å è é ê ë ì í î ï ò ó ô õ ö ù ú û ü ÿ ý ñ

Symbols and other special characters

You can write symbols and other special characters using the Punctuation Shift stroke.

NOTE You can also use the Punctuation Shift stroke to write punctuation marks.

To write symbols and special characters:

1. Enter the Punctuation Shift stroke:

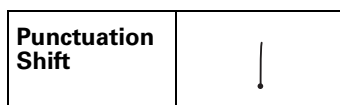

When Punctuation Shift is active, an up arrow symbol appears in the lower-right corner of the handheld screen. If you accidentally activate Punctuation Shift, another Punctuation Shift stroke will cancel it.

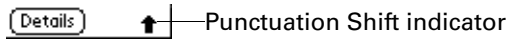

NOTE Drawing two Punctuation Shift strokes also cancels the automatic capitalization of the first letter of a new record or sentence.

2. Write the symbol or other special character shown in the table that follows. You can make a symbol stroke anywhere in the Graffiti 2 writing area.
3. Enter an additional Punctuation Shift stroke to finish writing the character and to make the character appear more quickly.



After the arrow disappears, the symbol appears.

Draw symbols on EITHER side of the Graffiti 2 writing area

.	,	'	?	!	&	@	\$	~	/	\	"
;	:	_		()	<	>	[]	{	}
+	-	*	÷	=	#	%	^	`	™	®	©
‘	’	“	”	§	•	¢	€	¥	£	ı	ı
°	ß	μ	f	Ø							

Graffiti 2 Gestures

Gestures enable you to use editing commands. To use gestures, draw the following strokes on the left (letter) side of the Graffiti 2 writing area:

Draw gestures on LEFT side of Graffiti 2 writing area			
Gesture	Stroke		Gesture
Cut			Paste
Copy			Undo

Graffiti 2 ShortCuts

Graffiti 2 ShortCuts make entering commonly used words or phrases quick and easy. ShortCuts are similar to the Glossary or Autotext features of some word processors.

Graffiti 2 writing comes with several predefined ShortCuts, and you can also create your own. Each ShortCut can represent up to 45 characters. For example, you might create a ShortCut for your name or for the header of a memo. See [“ShortCuts Preferences”](#) in [Chapter 22](#) to learn about creating ShortCuts.

To use a ShortCut, draw the ShortCut stroke followed by the ShortCut characters. The ShortCut symbol appears at the insertion point to show that you are in ShortCut mode.

ShortCut	
-----------------	---

Your handheld includes the predefined Graffiti 2 ShortCuts shown in the following table.

Entry	Shortcut
Date Stamp	ds
Time stamp	ts
Date/time stamp	dts
Meeting	me
Breakfast	br
Lunch	lu
Dinner	di

Full-screen writing area

When Writing Area Preferences are turned on and active, you do not have to write in the Graffiti 2 writing area. You can write letters anywhere on the left side of the screen, or write numbers anywhere on the right side of the screen. Capital letters are formed in the middle of the screen straddling the imaginary dividing line between the left and right sides.

When Writing Area Preferences are turned off or inactive, you must write character strokes in the Graffiti 2 writing area for your handheld to recognize them.

To use the full-screen writing area:

1. Turn on Writing Area Preferences. See [“Writing Area Preferences”](#) in [Chapter 22](#) for details.
2. Open the application in which you want to use the full-screen writing area.
A shaded box appears in the lower-right corner of the screen.
3. Position the cursor where you want the characters to appear.
4. Do any of the following:
 - Write lowercase Graffiti 2 letters anywhere on the left side of the screen.
 - Write numbers anywhere on the right side of the screen.
 - Write uppercase letters aligned with the division marks in the Graffiti 2 writing area.
 - Write the Punctuation Shift stroke before writing symbols and other special characters.
 - Access buttons and other controls that appear on the screen by tapping and holding the control until it activates.

To temporarily disable the full-screen writing area:

- Tap the shaded box in the lower-right corner.

The shaded box changes to an outline and Writing Area Preferences are deactivated.

Beaming data

Your handheld is equipped with an IR port that is located at the top of the handheld, behind the small dark shield. The IR port supports the IrCOMM implementation of the standards for infrared communication established by the Infrared Data Association (IrDA). This means that you can beam data to any nearby device that supports the IrCOMM implementation of the IrDA standards and that can read the type of data you’re beaming. For example, you can beam an Address Book entry to a Palm OS® handheld, a mobile phone, or a computer that’s equipped with an IR port and that can read vCard data.

You can beam the following information between devices:

- The record currently displayed in Date Book, Address Book, Note Pad, To Do List, Palm™ Photos, Palm™ Web Browser Pro, or Memo Pad
- All records of the category currently displayed in Address Book, To Do List, Note Pad, or Memo Pad, or all photos in the currently displayed album in Palm Photos
- A special Address Book record that you designate as your business card, containing information you want to exchange with business contacts
- An unlocked application installed in RAM memory
- An unlocked application installed on an expansion card that is seated in the card slot

TIP You can also perform HotSync® operations using the IR port. See “[Conducting IR HotSync operations](#)” in [Chapter 21](#) for more details.

To select a business card:

1. Create an Address Book record that contains the information you want on your business card.
2. Tap the Menu icon .
3. Tap Record, and then tap Select Business Card.
4. Tap Yes.

To beam a record, business card, or category of records:

1. Locate the record, business card, or category you want to beam.

NOTE The procedure for beaming photos and albums is slightly different from the procedure for beaming other records and categories. See [Chapter 13](#) for details.

2. Tap the Menu icon .
3. Tap one of the following from the Record menu:
 - The Beam command for an individual record.
 - In Address Book only: Beam Business Card.
 - In Note Pad only: If you are beaming to someone using an earlier version of Note Pad, tap Compatibility, and then tap Beam.
 - Beam Category.

TIP You can also press and hold the Address Book application button to instantly beam your business card to another device with an IR port.



4. When the Beam Status dialog box appears, point the IR port directly at the IR port of the receiving device.

For best results, Palm handhelds should be between 10 centimeters (approximately 4 inches) and 1 meter (approximately 39 inches) apart, and the path between the two handhelds must be clear of obstacles. The beaming distance to other devices may be different.



5. Wait for the Beam Status dialog box to indicate that the transfer is complete before you continue working on your handheld.

To beam an application:

1. Tap the Home icon .
2. Tap the Menu icon .
3. Tap App, and then tap Beam.
4. Tap the Beam From pick list.
5. Select either Handheld or Card.
6. Tap the application you want to transfer.

Some applications are copy-protected and cannot be beamed. These are listed with a lock icon next to them.

7. Tap Beam.
8. When the Beam Status dialog box appears, point the IR port directly at the IR port of the receiving device.
9. Wait for the Beam Status dialog box to indicate that the transfer is complete before you continue working on your handheld.

To receive beamed information:

1. Turn on your handheld.
2. Point the IR port directly at the IR port of the transmitting device to open the Beam dialog box.

- (Optional) Tap the category pick list and select a category for the incoming information. You can also create a new category or leave the information unfiled.



- Tap Yes.

Beaming tips

- You can set the full-screen pen stroke to beam the current entry. See [“Pen Preferences”](#) in [Chapter 22](#) for more information.
- You can draw the Graffiti 2 Command stroke to activate the Command toolbar, and then tap the beam icon.
- You can use the Graffiti 2 Command stroke “/ B” to beam the current entry.
- In Palm Photos you can select and beam multiple photos at the same time. See [“Beaming photos”](#) in [Chapter 13](#) for details.

Sending data

You can send data using Bluetooth™ communication or by using e-mail or SMS communication.

Sending data using Bluetooth communication

If you enable Bluetooth communication, you can send data to other Bluetooth devices. The Bluetooth device must be discoverable and within 10 meters (approximately 30 feet) of your handheld. For more information on enabling Bluetooth communication and Bluetooth settings, see [“Bluetooth Preferences”](#) in [Chapter 22](#).

To send data using Bluetooth communication:

1. Open the application you want to send data from.
2. Select the record or category you want to send.

3. Select the Send command from the application. For example, in Address Book, tap the Menu icon, tap Record, and then tap Send Address.

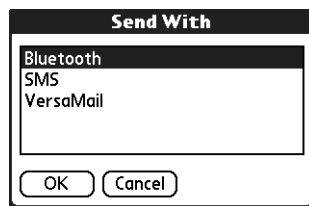

4. Select Bluetooth and tap OK.

Sending data using e-mail or SMS communication

In addition to beaming data, you can also use e-mail or SMS communication to send information to and receive information from other devices.

To use your handheld for e-mail communication, you need to perform a HotSync operation with your computer, use a Bluetooth local area network (LAN) access point or modem, or use a mobile phone. For more information, see [Chapter 17](#).

To use your handheld for SMS communication, you need a Global System for Mobile Communications (GSM) phone (sold separately) and you need to establish a connection with your GSM mobile phone. For additional information about connecting to your GSM phone, see [Chapter 14](#). For additional information about sending SMS data, see [Chapter 15](#).

Using your computer keyboard

If you have a lot of data to enter, or prefer to use the computer keyboard, you can use Palm Desktop software or any supported personal information manager (PIM), such as Microsoft Outlook, to enter information. You can then perform a HotSync operation to synchronize the information on your computer with the information on your handheld. Many of the applications that came with your handheld are also available in Palm Desktop software and in most PIMs, so you don't need to learn different applications. For more information on entering data on your computer, refer to the online Help in Palm Desktop software and the *Palm Desktop Software for the Macintosh User's Guide* on the Desktop Software CD-ROM.

Importing data

If you have data stored in computer applications such as spreadsheets and databases, or if you want to import data from another handheld, you can transfer the data to your handheld without having to type it. Save the data in one of the file formats listed in the next section, import it into Palm Desktop software, and then perform a HotSync operation to transfer the data to your handheld.

Importing data from a Windows computer

Palm Desktop software can import data in the following file formats:

- Comma-delimited (.csv, .txt): Address Book and Memo Pad only
- Tab-delimited (.tab, .tsv, .txt): Address Book and Memo Pad only
- CSV (Lotus Organizer 2.x/97 Mapping): Address Book only
- vCal (.vcs): Date Book only
- vCard (.vcf): Address Book only
- Date Book archive (.dba)
- Address Book archive (.aba)
- To Do List archive (.tda)
- Memo Pad archive (.mpa)

Archive formats can be used only with Palm Desktop software. Use the archive file formats to share information with other people who use a Palm OS handheld or to create a copy of your important Palm Desktop information.

To import data from a Windows computer:

1. Open Palm Desktop software.
2. Click the application into which you want to import data.
3. If you are importing records that contain a field with category names, do the following:

Select All in the Category box.

Be sure that the same categories that appear in the imported file also exist in the application. If the categories do not exist, create them now; otherwise, the records are imported into the Unfiled category.

4. From the File menu, select Import.
5. Select the file you want to import.
6. Click Open.
7. To import data into the correct Palm Desktop fields, drag fields in the left column so that they are opposite the corresponding imported field on the right.
8. If you don't want to import a field, click the check box for that field to deselect it.
9. Click OK.

The imported data is highlighted in the application.

10. To add the imported data to your handheld, perform a HotSync operation.

See Palm Desktop online Help for more information on importing and exporting data.

Using File Link

The File Link feature enables you to import Address Book and Memo Pad information, such as a company phone list, to your handheld from a separate external file on your Windows computer. You can configure the File Link feature to check for changes to the external file when you perform a HotSync operation. HotSync Manager stores the data in a separate category in Palm Desktop software and on your handheld.

With File Link, you can import data stored in any of the following formats:

- Comma-separated (*.csv)
- Memo Pad archive (*.mpa)
- Address Book archive (*.aba)
- Text (*.txt)

For information on how to set up a file link, see the Palm Desktop online Help.

Importing data from a Mac computer

Palm Desktop software can import data from any applications that can export the data in any of the following file formats:

- Tab-delimited file
- Text
- Palm Desktop software for Mac
- vCal (.vcs)
- vCard (.vcf)

For example, you can export tab-delimited files from applications such as: FileMaker Pro, Meeting Maker, Now Contact, and Now Up-to-Date.

To import data from a Mac computer:

1. Open Palm Desktop software.
2. From the File menu, select Import.
3. Select the file you want to import.
4. Click Open.
5. If you want to change the order of the fields you're importing, point to a field, wait for the cursor to change to a double arrow, and then drag the field to a new location.
6. If you do not want to import a field, click the arrow between the field names.
7. From the Fields pop-up menu, select the appropriate field.

8. From the Delimiters pop-up menu, select the appropriate delimiter.
9. Click OK.
10. To add the imported data to your handheld, perform a HotSync operation.

See Palm Desktop online Help for more information on importing and exporting data.

Using Note Pad

In addition to using Graffiti 2 characters and the onscreen keyboard, you can enter data on your handheld using the Note Pad application. When you use Note Pad, you write quick notes directly on the handheld screen in your own handwriting. See [Chapter 12](#) for more information and instructions.

Using a portable keyboard

You can connect a portable keyboard accessory to the universal connector on your handheld so that you can type data directly into your handheld. Portable keyboards are very helpful when you need to enter large amounts of data quickly and accurately while you are away from your computer, such as writing an e-mail message. For additional information about this optional accessory, go to the web site www.palm.com/intl.

Working with Applications

This chapter explains how to open and switch between applications on your handheld, how to change application settings so they are personalized to your work methods, and how to categorize applications so you view them in related groups.

Opening applications

You can use the Applications Launcher to open any application installed on your handheld or an expansion card. You can also open Date Book, Address Book, To Do List, Note Pad, and Voice Memo with the application buttons on your handheld.

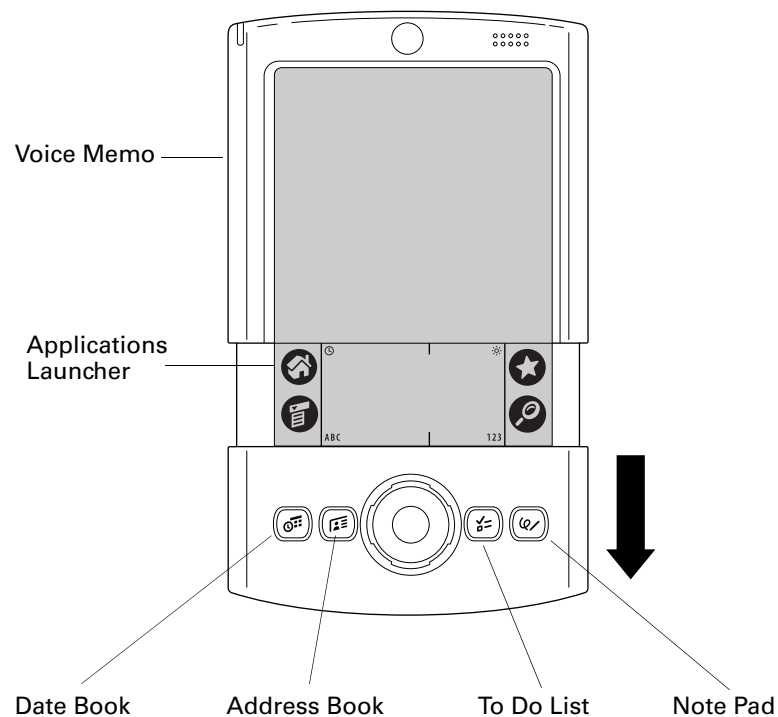

In addition to providing a way for you to open applications, the Applications Launcher displays the current time, battery level, and application category.

To open an application on your handheld:

1. Tap the Home icon .



2. Tap the icon of the application that you want to open. If you have many applications installed on your handheld, tap the scroll bar to see all your applications.

Other ways to open applications

You can also open applications on your handheld in either of the following ways:



- Press and hold Select on the navigator to open the Applications Launcher. Press Select on the navigator to insert the highlight. Press Up, Down, Right, and Left on the navigator to highlight the icon of the application you want to open. Press Select on the navigator to open the application.
- In the Applications Launcher, write the Graffiti® 2 character for the first letter of its name. The Applications Launcher scrolls to the first application with a name that begins with that letter.

Opening expansion card applications

When an expansion card is properly seated in the expansion card slot, your handheld responds based on the contents of the card and the application that is active when you insert the card. In some cases the application on the card opens automatically upon insertion, or if you insert a card containing data from the current application, the application displays the data on the card. In other cases the Applications Launcher switches to the card and displays its contents, and the pick list in the upper-right corner of the screen displays the name of the card.

To open an application on an expansion card:

- Select the icon of the application that you want to open.

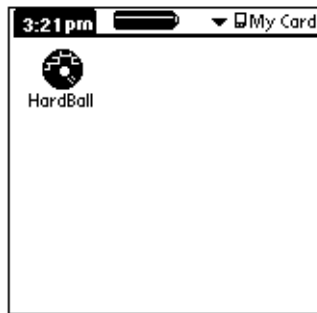

Switching between applications

When working with any application, select the Home icon  or press an application button on your handheld to switch to another application. Your handheld automatically saves your work in the current application and displays it when you return to that application.



You can also press and hold Select on the navigator to switch to the Applications Launcher at any time.

When you use an expansion card, your handheld creates and displays a new category that matches the name of the expansion card. You can easily switch between applications installed on your handheld and on the expansion card.

To switch to an expansion card:

1. Tap the pick list in the upper-right corner.



TIP You can also press and hold Select on the navigator to open the category pick list.

2. Select the category item that matches the name of the expansion card.

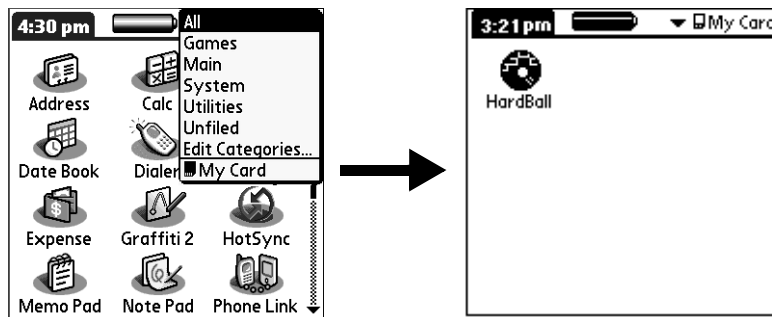

Categorizing applications



The category feature enables you to manage the number of application icons that appear onscreen in the Applications Launcher. You can assign an application to a category and then display a single category or all your applications.

By default, your handheld includes system-defined categories, such as All and Unfiled, and user-defined categories, such as Games, Main, and System.

You cannot modify the system-defined categories, but you can rename and delete the user-defined categories. In addition, you can create your own user-defined categories. You can have a maximum of 15 user-defined categories.

When you have an expansion card properly seated in the expansion card slot, the expansion card name appears as the last item in the category pick list. You can assign applications to the expansion card, but you cannot otherwise categorize applications that reside on an expansion card.

To categorize an application:

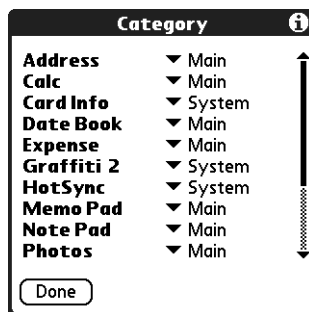

1. Tap the Home icon .
2. Tap the Menu icon .
3. Select Category on the App menu.
4. Tap the pick list next to each application to select a category.



TIP To create a new category, tap Edit Categories from the pick list. Tap New, enter the category name, and then tap OK to add the category. Tap OK again to close the Edit Categories dialog box.

5. Tap Done.

To display applications by category:

1. Tap the Home icon .
2. Do one of the following:
 - Tap the Home icon  repeatedly to cycle through all your categories.
 - Tap the pick list in the upper-right corner of the screen, and select the category you want to display.





- Press and hold Select on the navigator to open the category list, press Up or Down on the navigator to highlight a category, and then press Select on the navigator to view that category.



Changing the Applications Launcher display

By default, the Applications Launcher displays each application as an icon. As an alternative, you can choose to show a list of applications. You can also choose to view the same category of applications each time you open the Applications Launcher.

To change the Applications Launcher display:

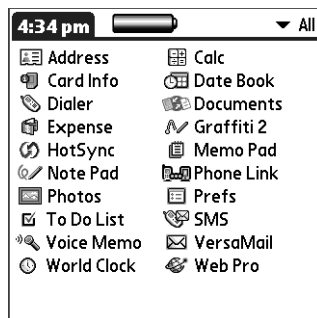
1. Tap the Home icon .
2. Tap the Menu icon .
3. Select Options, and then select Preferences.
4. Tap the View By pick list and select List.
5. Tap OK.



**To open the Applications Launcher to the last opened category:**

1. Tap the Home icon .
2. Tap the Menu icon .
3. Select Options, and then select Preferences.
4. Tap the Remember Last Category check box to select it.
5. Tap OK.

Copying applications to or from an expansion card

You can copy applications from your handheld to an expansion card, or from an expansion card to your handheld.

To copy an application to an expansion card:

1. Tap the Home icon .
2. Tap the Menu icon .
3. Select Copy on the App menu.



4. Tap the Copy From pick list and select Handheld.
5. Tap the Copy To pick list and select the card name.
The Copy To pick list appears only if there are multiple cards available.
6. Tap an application to copy.
7. Tap Copy.
8. Tap Done.

You can install applications to a card that is seated in the expansion card slot during a HotSync® operation. See [“Installing files and add-on applications”](#) later in this chapter for details.

NOTE If you view your applications on the card using a Card Reader on your Windows or Mac computer, the actual file names may differ from those displayed in the Applications Launcher.

To copy an application from an expansion card:

1. Tap the Home icon .
2. Tap the Menu icon .

3. Select Copy on the App menu.

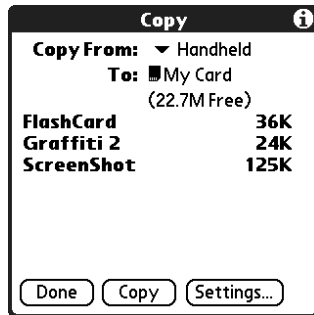

4. Tap the Copy From pick list and select the card name.
5. Tap the Copy To pick list and select Handheld.
6. Tap the application you want to copy.
7. Tap Copy.
8. Tap Done.



You can also beam applications from expansion cards to your handheld or send applications from expansion cards to your handheld. See [“Beaming data”](#) and [“Sending data”](#) in [Chapter 3](#) for details.

Selecting copy settings

When using the copy feature, you can set the following:

- How applications are sorted and listed
- Whether to copy only the application or both the application and its data files

To select copy settings:

1. Tap the Home icon .
2. Tap the Menu icon .
3. Select Copy on the App menu.
4. Tap Settings.



5. Tap the Sort By pick list and select Name or Size.

6. Tap the Copy Application Only check box to select it if you want to copy only the application files. Leave it deselected if you want to copy both the application file and its associated data file(s).
7. Tap OK.

NOTE The Sort By setting is in effect each time you use the copy feature. Each time you want to copy an application only, you must select the Copy Applications Only check box.

Using menus

Menus on your handheld are easy to use. Once you have mastered them in one application, you can use them the same way in all other applications.

The menus of each application are illustrated in the chapter that discusses that application.

To open the menu bar:

1. Open an application (such as Memo Pad).
2. Do one of the following:
 - Tap the Menu icon .
 - Tap the inverted title area at the top of the screen.

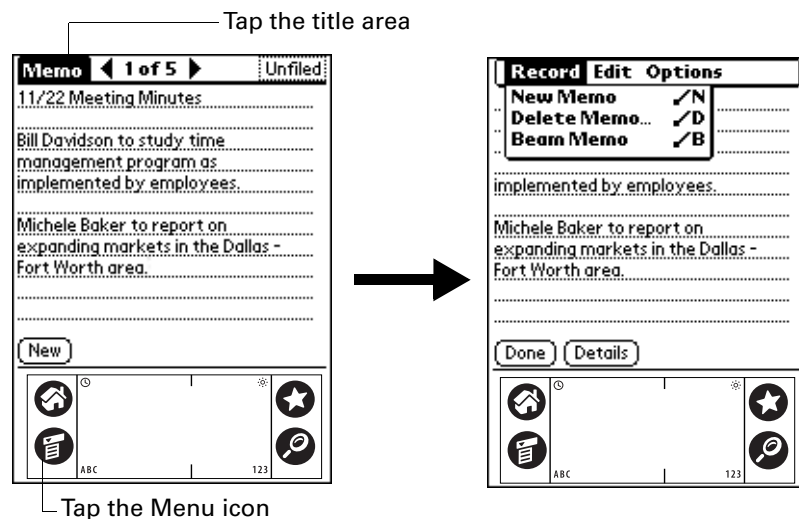

In this example, three menus are available: Record, Edit, and Options. The Record menu is selected and contains the commands New Memo, Delete Memo, Beam Memo, and Send Memo.

Choosing a menu

The menus and menu commands that are available depend on the application that is currently open. Also, the menus and menu commands vary depending on *which part* of the application you're currently using. For example, in Memo Pad, the menus are different for the Memo list screen and the Memo record screen.

To select a menu command with the stylus:

1. Open the menu bar for an application.
2. Tap the menu that contains the command you want to use.
3. Tap the command you want to use.



TIP After you open the menu bar, you can also press Right and Left on the navigator to select a menu, press Down on the navigator to select the command you want to use, and then press Select on the navigator to run the command.

Graffiti 2 menu commands

Most menu commands have an equivalent Graffiti 2 Command stroke, which is similar to the keyboard shortcuts used to execute commands on computers. The command letters appear to the right of the command names.

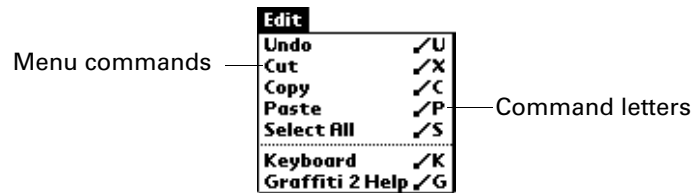

When you draw the Command stroke anywhere in the Graffiti 2 area, the Command toolbar appears just above the Graffiti 2 writing area to indicate that you are in Command mode.

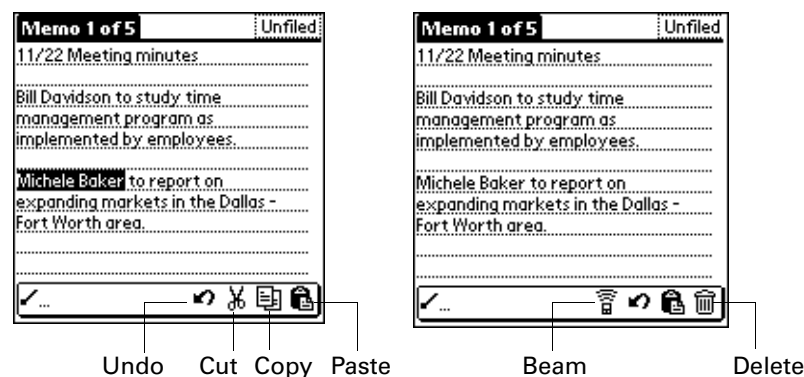

The Command toolbar displays context-sensitive menu commands for the active screen. For example, if text is selected, the menu icons displayed may be Undo, Cut, Copy, and Paste. Tap an icon to select the command, or immediately write the corresponding command letter for an appropriate command in the Graffiti 2 writing area.

For example, to select Paste from the Edit menu, draw the Command stroke, followed by the letter *p*.

Command mode is active only for a short time, so you must tap an icon or write the command letter immediately to select the menu command.

Choosing application preferences

You can set options that affect an entire application in the application's Preferences dialog box.

To change preferences for an application:

1. Open an application.
2. Tap the Menu icon .
3. Select Options, and then select Preferences.

NOTE Not all applications have a Preferences command.

4. Make changes to the settings.
5. Tap OK.

Performing common tasks

The tasks described in this section use the term *records* to refer to an individual item in any of the applications: a single Date Book event, Address Book entry, To Do List item, Note Pad note, Palm™ Photos photo, voice memo, Memo Pad memo, SMS message, Palm™ Web Browser Pro page, or Expense item.

Creating records

You can use the following procedure to create a new record in Date Book, Address Book, To Do List, Note Pad, Memo Pad, and Expense.

In SMS, you use a different procedure to create a message. For more information, see [“Creating messages” in Chapter 15](#).

In Palm Web Browser Pro, you can either save a web page or bookmark it so you can return to it later. For more information, see [Chapter 19](#).

To create a record:

1. Select the application in which you want to create a record.
2. Tap New.
3. In Date Book only: Select start and end times for your appointment, and tap OK.
4. Enter text for the record.
5. (Optional) Tap Details to select attributes for the record. (In Note Pad the Details command is located on the Options menu.)
6. In Address Book, Note Pad, and Memo Pad only: Tap Done.

There's no need to save the record because your handheld saves it automatically.

Editing records

After you create a record, you can change, delete, or enter new text at any time. Two screen features tell you when your handheld is in Edit mode:

- A blinking cursor
- One or more dotted edit lines

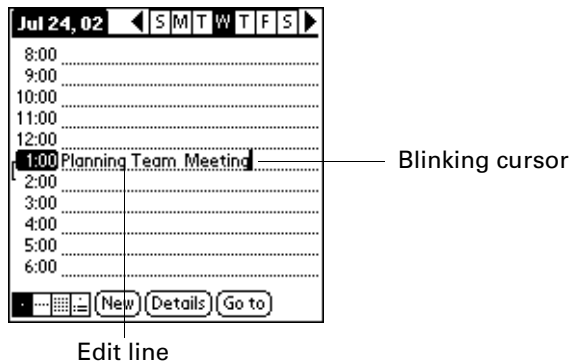

NOTE In Note Pad you can write anywhere on the screen. Therefore, you will not see an edit line or blinking cursor unless the cursor is in the title line.

Entering text

For information on how to enter text using Graffiti 2 writing, the onscreen keyboard, or the keyboard attached to your computer, see [Chapter 3](#). For information on entering text in Note Pad, see [“Creating a note”](#) in [Chapter 12](#).

Using the Edit menu

The Edit menu is available with any screen where you enter or edit text. In general, commands available in the Edit menu apply to text that you *select* in an application.

To select text in an application:

1. Tap the beginning of the text that you want to select.
2. Drag the stylus over the text to highlight it (in yellow).

NOTE You can also double-tap to select a word, or triple-tap to select a line of text. You can also drag *across* the text to select additional words, or drag *down* to select a group of lines.

The following commands may appear in an Edit menu:

Undo	Reverses the action of the <i>last edit</i> command. For example, if you used Cut to remove text, Undo restores the text you removed. Undo also reverses deletions you made using backspace.
Cut	Removes the selected text and stores it temporarily in the memory of your handheld. You can paste the text you cut into another area of the current application or into a different application.
Copy	Copies the selected text and stores it temporarily in the memory of your handheld. You can paste the text that you copy into another area of the current application or into a different application.
Paste	Inserts the text that you cut or copied at the selected point in a record. The text you paste replaces any selected text. If you did not previously cut or copy text, Paste does nothing.
Select All	Selects all of the text in the current record or screen. This enables you to cut or copy all of the text and paste it elsewhere.
Keyboard	Opens the onscreen keyboard. After you finish with the onscreen keyboard, tap Done.
Graffiti 2 Help	Opens screens that show all the Graffiti 2 character strokes. Use this command anytime you forget a stroke for a character.

Deleting records

To delete a record:

1. Select the record you want to delete.
2. Tap the Menu icon .
3. Select the Delete command on the Record menu. In Voice Memo, the delete command is on the V Memo menu. In Palm Photos, the delete command is on the Photo menu:

Date Book: Delete Event

Address Book: Delete Address

To Do List: Delete Item

Note Pad: Delete Note

Voice Memo: Delete V Memo

Palm Photos: Delete Photo

Memo Pad: Delete Memo

Expense: Delete Item

In SMS, the delete command is available when you have a message open. In Palm Web Browser Pro, the delete command is available from the View Saved Pages dialog box.

A confirmation dialog box appears. If you want to save a copy of the deleted item to an archive file in Palm Desktop software, be sure that the check box is selected. If you don't want to save a copy, tap the check box to deselect it.

The archive option is not available in Note Pad, Palm Photos, Palm Web Browser Pro, and Voice Memo. In SMS, you must tap Archive in the Message menu to archive a message.

4. Tap OK.

If you chose to save a copy of the selected item, your handheld transfers it to the archive file on your desktop the next time you perform a HotSync operation.

To delete a record with alternate methods:

- Delete the text of the record.
- In Date Book, Address Book, Palm Photos, To Do List, and Memo Pad, open the Details dialog box for the record, tap Delete, and then tap OK.

NOTE When deleting a repeating event in Date Book, you can choose to delete the current repeating event, current and future events, or all instances of that event.

- In Palm Photos, you can select and delete multiple photos at the same time. See [“Deleting photos”](#) in [Chapter 13](#) for details.
- In Note Pad and Voice Memo, open the note or voice memo you want to delete, and then tap Delete.
- In Palm Web Browser Pro, you can delete your list of bookmarked pages or clear the history list of the web pages you've visited. You can also clear the cache of web pages stored on your handheld so you can view them without accessing the Internet again. See [Chapter 19](#) for details.
- In SMS, tap Empty Trash on the Message menu to permanently delete messages in the Trash category.

Purging records

Over time, as you use Date Book, To Do List, and Expense, you'll accumulate records in these applications that have outlived their usefulness. For example, events that occurred months ago remain in the Date Book, and To Do List items that you marked as completed remain in the list, as do Expense items.

All these outdated records take up memory on your handheld, so it's a good idea to remove them by using Purge. If you think Date Book or To Do List records might prove useful later, you can purge them from your handheld and save them in an archive file on your computer.

Purging is not available in Address Book, Note Pad, Palm Photos, Voice Memo, SMS, or Memo Pad. You must delete outdated records manually from these applications.

In Palm Web Browser Pro, you can purge stored web pages by clearing the cache. See ["Changing the size and content of the cache"](#) in [Chapter 19](#).

To purge records:

1. Open the application.
2. Tap the Menu icon .
3. Select Purge on the Record menu.

A confirmation dialog box appears.

Date Book: Tap the pick list and select how old a record must be to be purged. Purge deletes repeating events if the last of the series ends before the date that you purge records.

Date Book, To Do List: If you want to save a copy of the purged records to an archive file on your desktop, be sure that the check box is selected. If you don't want to save a copy, tap the check box to deselect it.

Expense: Select the category you want to purge. All data in the selected category will be purged and there is no archive option.

4. Tap OK, or in Expense, tap Purge.

If you chose to save a copy of the purged records, your handheld transfers them to an archive file on your desktop the next time you perform a HotSync operation.

NOTE Purging does not happen automatically. You must select the command to make it happen.

Categorizing records

You can categorize records in the Address Book, To Do List, Note Pad, Voice Memo, Memo Pad, and Expense applications so that they are grouped logically into categories and are easy to review. In Palm Photos, categories are called *albums*. As we refer to categories throughout this section, we are also referring to albums unless otherwise noted.

When you create a record, your handheld automatically places it in the category that is currently displayed. If the category is All, your handheld assigns it to the Unfiled category. You can leave an entry as Unfiled or assign it to a category at any time.

When you have an expansion card properly seated in the expansion card slot, the last item in the category pick list becomes the name of the expansion card. You cannot otherwise categorize applications that reside on an expansion card. The expansion card serves as its own category. To further categorize records, the records must reside on your handheld.

By default, your handheld includes system-defined categories, such as All and Unfiled, and user-defined categories, such as Business and Personal.

You cannot modify the system-defined categories, but you can rename and delete the user-defined categories. In addition, you can create your own user-defined categories. You can have a maximum of 15 user-defined categories in each application.

Address Book contains the QuickList user-defined category, in which you can store the names, addresses, and phone numbers you might need in emergencies (doctor, fire department, lawyer, and so on).

Expense contains two user-defined categories, New York and Paris, to show how you might sort your expenses according to different business trips.

Palm Photos contains three user-defined albums—Vacation, Friends, and Family—that you can use to organize your photos.

Palm Web Browser Pro allows you to save web pages and bookmarks in categories. See [Chapter 19](#) for details.

SMS has set categories you can place messages in: Outbox, Inbox, Trash, Archive, and Draft.

The illustrations in this section come from Address Book, but you can use these procedures in all the applications in which categories are available. The only exception is that the steps for moving photos into albums is slightly different. See [“Filing photos in albums”](#) in [Chapter 13](#) for details.

To move a record into a category:

1. Select the record you want to categorize.
2. In Address Book only: Tap Edit.
3. Tap Details.
4. Tap the Category pick list to display the list of available categories.



5. Select the category for the record.
6. Tap OK.

NOTE In Address Book, Note Pad, Voice Memo, and Memo Pad you can select the category name in the upper-right corner of the screen to assign the item to a different category.

To display a category of records:

1. Tap the category pick list in the upper-right corner of the list screen.

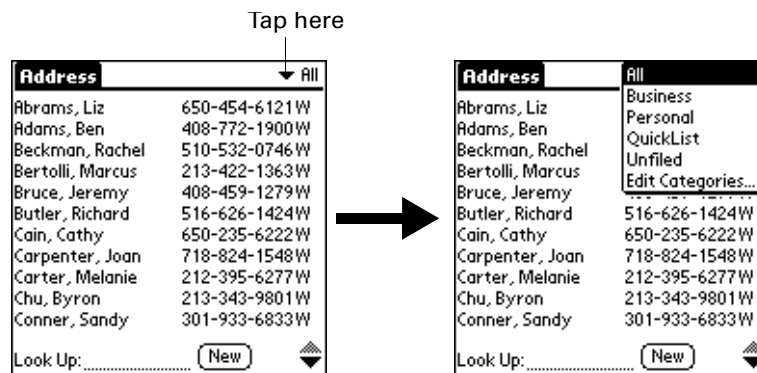

NOTE In the Date Book Agenda view, the pick list is in the upper right of the To Do list.

2. Select the category you want to view.

The list screen now displays only the records assigned to that category.

TIP Pressing an application button on your handheld scrolls through all the categories of that application except for Unfiled. This feature is not available in Date Book.

To define a new category:

1. Tap the category pick list in the upper-right corner of the screen or list.

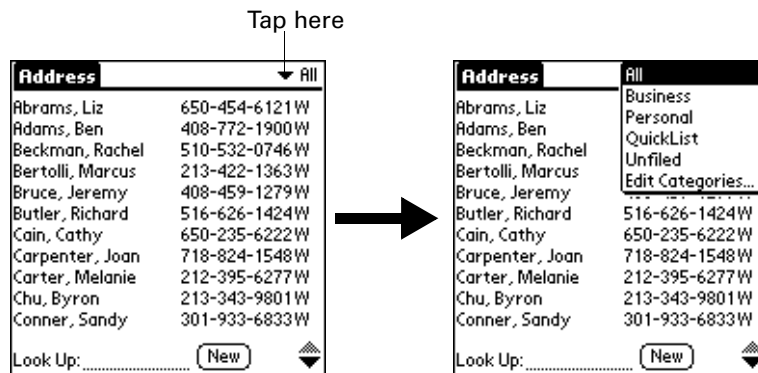

2. Select Edit Categories.
3. Tap New.



4. Enter the name of the new category, and then tap OK.



5. Tap OK.

You can assign any of your records to the new category.

To rename a category:

1. Tap the category pick list in the upper-right corner of the screen or list.
2. Select Edit Categories.

3. Select the category that you want to rename, and then tap Rename.



4. Enter the new name for the category, and then tap OK.



5. Tap OK.

TIP You can group the records within two or more categories into one category by giving the categories the same name. For example, if you change the name of the Personal category to Business, all records formerly in the Personal category appear in the Business category.

Finding information

Your handheld offers several ways for you to find information quickly:

- **All applications that reside on your handheld:** Find locates any text that you specify, always starting with the current application. However, Find does not search through applications on expansion cards.
- **Date Book, To Do List, Memo Pad, SMS:** Phone Lookup displays the Address list screen and enables you to add to a record the information that appears in this list.
- **Address Book:** The Look Up line enables you to scroll immediately to a name when you enter the first letters of that name. For more information, see [“Looking up Address Book records”](#) next.

You can also use Quick Connect and Tap-to-Connect in Address Book to dial a phone number listed in an Address Book record or to create an e-mail message addressed to an Address Book contact. For more information, see [“Making connections from Address Book”](#) in [Chapter 5](#).

- **Expense:** Lookup displays the names in your Address Book that have data in the Company field. You can add these names to a list of attendees associated with an Expense record.

Looking up Address Book records

In Address Book you can use the Look Up line with the stylus or navigator to look up and quickly scroll to any of your Address Book entries.



To look up an Address Book record with the navigator:

1. From the Address list screen, press Right on the navigator to display the Quick Look Up line.
2. Press Up and Down on the navigator to select the first letter of the name you want to find.

The list scrolls to the first entry that begins with that letter.

3. Press Right on the navigator to move to the next letter box.

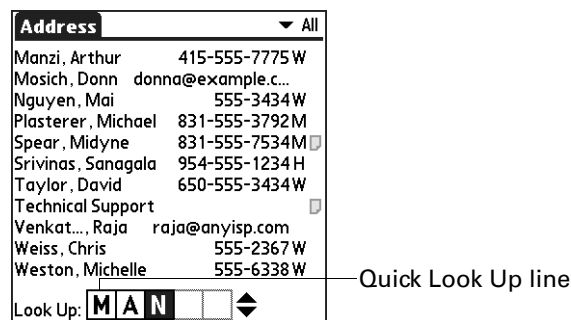

The Quick Look Up line displays only letters that are a possible match for that position. For example, in the screen shown here, if you enter *c* in the first box, only the letters *a*, *h*, and *o* appear in the second box.

If there is only one possible match for a particular position, the highlight jumps to the next position.

4. Press Up or Down on the navigator to select the next letter of the name you want to find.

The list then scrolls to the first entry that starts with those *two* letters. For example, selecting *s* scrolls to “Sands,” and selecting *sm* scrolls further to “Smith.” If you sort the list by company name, the Quick Look Up feature scrolls to the matches for the company name.

5. Repeat steps 3 and 4 until the entry you want appears in the list.
6. Press Select on the navigator to highlight the record you want.
7. Press Select on the navigator to view the contents of the selected record.

TIP If there is only one possible match for the letters you selected, the contents of the record automatically display.

To look up an Address Book record with the stylus:

1. From the Address list screen, enter the first letter of the name you want to find.

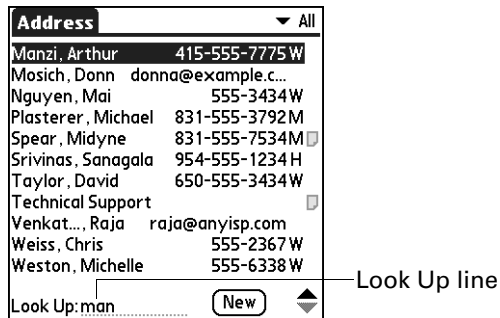

The list scrolls to the first entry that begins with that letter. If you write another letter, the list scrolls to the first entry that starts with those *two* letters. For example, writing an *s* scrolls to “Sands,” and writing *sm* scrolls further to “Smith.” If you sort the list by company name, the Look Up feature scrolls to the first letter of the company name.

2. Tap the record to view its contents.

Using Find

You can use Find to locate any text that you specify, in any application that resides on your handheld. Find does not search applications that reside on an expansion card.

To use Find:

1. Tap the Find icon .

TIP If you select text in an application before you tap Find, the selected text automatically appears in the Find dialog box.

2. Enter the text that you want to find.

Find is *not* case sensitive. For example, searching for the name “davidson” also finds “Davidson.”

Find locates any words that begin with the text you enter. For example, searching for “plane” finds “planet” but not “airplane.”

3. Tap OK.

Find searches for the text in all records and all notes.

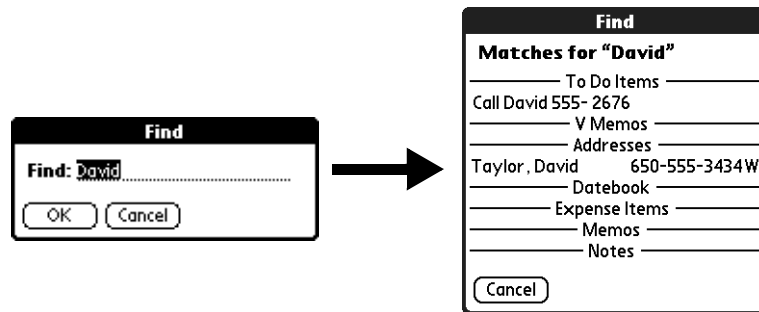

As your handheld searches for the text, you can tap Stop at any time. You may want to do this if the entry you want appears before your handheld finishes the search. To continue the search after you tap Stop, tap Find More.

4. Tap the text that you want to review.

Using Phone Lookup

Phone Lookup displays the Address list screen. You can add to a record the information that appears in this list.

To use Phone Lookup:

1. Display the record in which you want to insert a phone number. The record can be in Date Book, To Do List, Memo Pad, SMS, or any other application that takes advantage of this feature.
2. Tap the Menu icon .
3. Select Options, and then select Phone Lookup.
4. Begin to spell the last name of the name you want to find.

The list scrolls to the first record in the list that starts with the first letter you enter. Continue to spell the name you're looking for, or when you see the name, tap it.

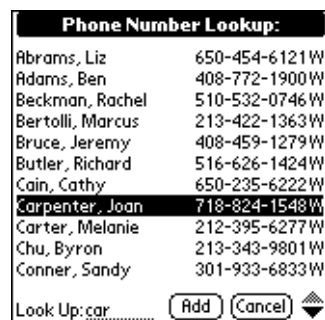

5. Tap Add.

The name you selected, along with the information associated with it, is pasted into the record you selected in step 1.

Using Graffiti 2 commands with Phone Lookup

Write the Graffiti 2 Command stroke “/L” to activate the Phone Lookup feature. You can also activate it in the following circumstances:

- **While entering text:** For example, to insert the full name and phone number for someone with the last name Williams, write the Graffiti 2 characters for *Wi* and then the Phone Lookup Command stroke “/L.”

If you have only one Address Book record that begins with *Wi*, your handheld inserts the full name, such as Fred Williams (and its associated information). If you have more than one name that begins with *Wi*, the Phone Lookup screen appears and highlights the first record that begins with *Wi*.

- **For selected text:** Drag to highlight the text, and then write the Phone Lookup Command stroke “/L.” Your handheld replaces the selected text and adds the name and its associated information.

Looking up names to add to Expense records

In Expense, Lookup displays the names in your Address Book that have data in the Company field. You can add these names to a list of attendees associated with an Expense record.

To add names to an Expense record:

1. Tap the Expense record to which you want to add names.
2. Tap Details.

The screenshot shows a 'Receipt Details' screen with the following fields and controls:

- Category:** ▾ Unfiled
- Type:** ▾ Lunch
- Payment:** ▾ Unfiled
- Currency:** ▾ \$
- Vendor:**
- City:**
- Attendees:** Who...

At the bottom, there are four buttons: OK, Cancel, Delete, and Note, followed by an upward-pointing arrow.

3. Tap Who.

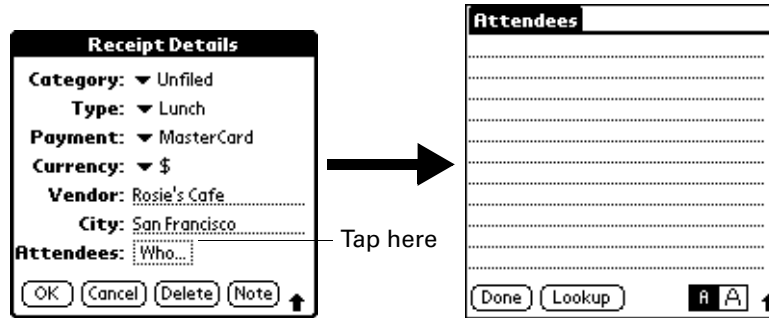

4. Tap Lookup.

The Attendees Lookup screen displays all the names in your Address Book that have data in the Company field.

5. Select the name you want to add, and then tap Add.

The name appears in the Attendees screen.

6. Repeat steps 4 and 5 to add more names.
7. Tap Done.
8. Tap OK.

Sorting lists of records

You can sort lists of records in various ways, depending on the application. Sorting is available in applications that have list screens: Address Book, To Do List, Note Pad, Voice Memo, Memo Pad, and Expense. You can also sort photos in Palm Photo. See [“Sorting photos in List view”](#) in [Chapter 13](#) for details.

NOTE You can also assign records to categories. See [“Categorizing records”](#) earlier in this chapter.

To sort records in To Do List and Expense:

1. Open the application to display the list screen.
2. Tap Show.
3. Tap the Sort by pick list and select an option.
4. Tap OK.

To sort records in Address Book, Note Pad, Voice Memo, and Memo Pad:

1. Open the application to display the list screen.
2. Tap the Menu icon .

3. Select Options, and then select Preferences.

Address Book

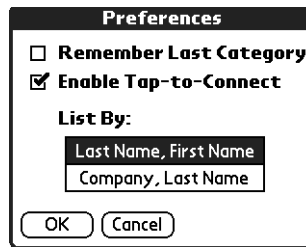

Note Pad

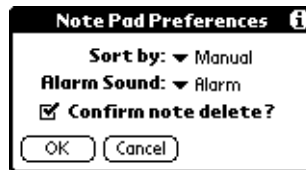

Voice Memo

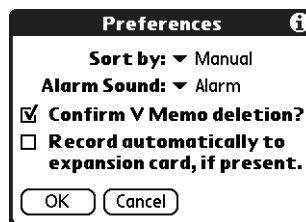

Memo Pad

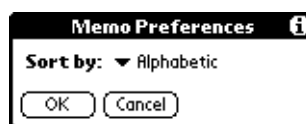

4. Do one of the following:

Address Book: Tap the setting you want.

Note Pad: Tap the Sort by pick list and select Alphabetic, Date, or Manual.

Voice Memo: Tap the Sort by pick list and select Date, Alphabetic, Duration, or Manual.

Memo Pad: Tap the Sort by pick list and select Alphabetic or Manual.

5. Tap OK.

To sort the Note Pad, Voice Memo, or Memo list manually, tap and drag a note, voice memo, or memo to a new location in the list.

To make the list appear in Palm Desktop software as you manually sorted it on your handheld, open the application in Palm Desktop software and click Sort by. Then select Order on Handheld.

Attaching notes

In Address Book, Date Book, To Do List, Palm Photos, and Expense, you can attach a note to a record. A note can be up to several thousand characters long. For example, for an appointment in Date Book, you can attach a note with directions to the location.

To attach a note to a record:

1. Display the entry to which you want to add a note.



To display an entry, tap it or press Up or Down on the navigator to highlight it, and then press Select on the navigator.

2. In Address Book only: Tap Edit.
3. Tap Details.
4. Tap Note.
5. Enter your note.
6. Tap Done.

A small note icon appears at the right side of any item that has a note.

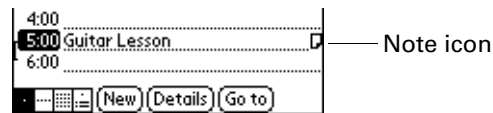

To review or edit a note:

- Tap the Note icon .



TIP In Date Book, you can also highlight the event that contains the note, press Select on the navigator to open the note, and then press Select on the navigator again to close the note.

To delete a note:

1. Tap the Note icon .
2. Tap Delete.
3. Tap Yes.

Choosing fonts

In many applications, you can change the font style to make text easier to read. You can choose small, small bold, large, or large bold fonts in each application that enables you to change the font style.

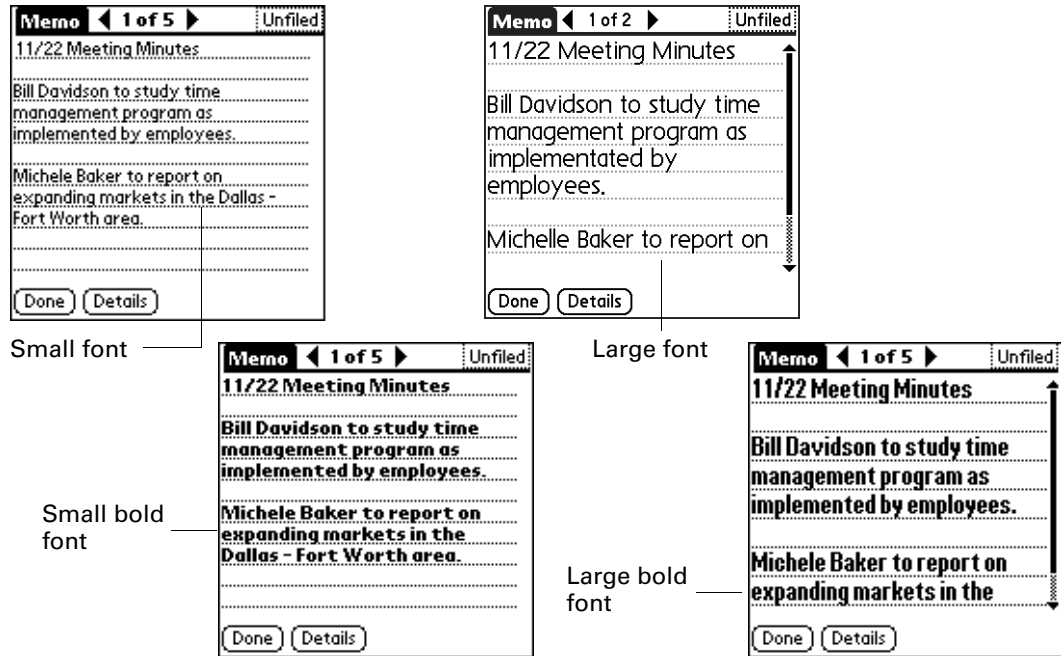

To change the font style:

1. Open an application.
2. Tap the Menu icon .
3. Select Options, and then select Font.
4. Tap the font style you want to use.

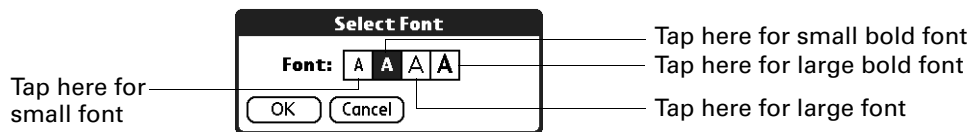

5. Tap OK.

Receiving alerts

You can receive alerts on your handheld and in Palm Desktop software.

Receiving alerts on your handheld

When you use certain application settings, your handheld can alert you to any of the following:

- An appointment set in Date Book
- A note created in Note Pad
- A voice memo created in Voice Memo
- An alarm set in World Clock

When an alert occurs, your handheld displays a reminder message. If you tap Snooze in response to an alert message, your handheld reminds you of the item again in five minutes. The Reminder screen displays alerts that await attention.

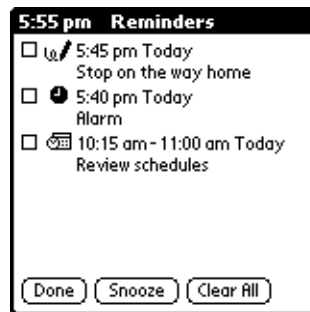

To respond to alerts, do one of the following:

- Select an item's check box to clear the item.
- Tap an item (either the icon or the text description) to open the application where the alarm was set. The application opens to the entry associated with the alarm.
- Tap Done to close the reminder list and return to the current screen. An attention indicator will blink in the upper-left corner of the screen; tap it to view the alert list again.
- Tap Snooze to see the list again in five minutes.

If you tap Done or Snooze and view the reminder list later, the current time appears in the Reminder bar and the original alert time appears with each list item.

- Tap Clear All to dismiss all alerts in the list.

Receiving alerts from Palm Desktop software

You can also set an option to receive Date Book event alerts from Palm Desktop software. The feature is disabled by default, so you must enable it within Palm Desktop software.

To enable an event alert from Palm Desktop software:

1. Double-click the Palm Desktop icon.
2. From the Tools menu, select Options, and then select Alarms.
3. Set Alarm Configuration options, either Always Available or Available only when the Palm Desktop is running.
4. (Optional) To hear an alert sound as well as receive an alert message, select the check box Play audible notification with alarm dialog box.
5. Click OK.

Hiding or masking private records

You can use Security Preferences to set a password and select whether to mask your private records or hide them completely. See [“Hiding or masking your private records automatically”](#) in [Chapter 22](#) for details.

Installing and removing applications

This section explains how to install and remove applications and other files on your handheld or on an expansion card, and how to remove Palm Desktop software from your computer.

Installing files and add-on applications

Your handheld comes with many applications installed and ready to use. During a HotSync operation you can also install additional applications, such as games and other software, on your handheld or on a card that is seated in the expansion card slot. Applications or games that you install on your handheld reside in RAM memory, and you can delete them at any time.

You can also install other files that are associated with an application on your handheld, such as Microsoft Office documents, photos, or audio files. Files that are not associated with an application on your handheld may not be installed during a HotSync operation.

Both applications and files are easy to install during a HotSync operation. You can install the following types of files:

- Palm OS® file types, including PRC and PDB
- Image files, including BMP and JPG
- Microsoft Office files, such as Word, Excel, and PowerPoint documents.

- Audio files, including MP3 (requires the audio application from the Software Essentials CD-ROM, and audio files must reside on an expansion card which is sold separately)

NOTE To install some software, you may need to download files from the Internet to your computer. Check the Software Essentials CD for details.

- Kinoma video files (requires the Kinoma application from the Software Essentials CD-ROM)

There are a variety of third-party applications available for your handheld. To learn more about these applications, go to the web site: www.palm.com/intl.

NOTE Palm works with developers of third-party add-on applications to ensure the compatibility of these applications with your new Palm handheld. Some third-party applications, however, may not have been upgraded to be compatible with your new Palm handheld. If you suspect that a third-party application is adversely affecting the operation of your handheld, contact the developer of the application.

Installing applications and files on a Windows computer

Palm Quick Install makes it easy to install applications and files during the next HotSync operation. You can even install compatible files directly from a Zip file. Depending on the file type, Palm Quick Install determines whether to install the files on your handheld or on an expansion card.

You can use any of the following methods to install applications and files with Palm Quick Install:

- Drag and drop files onto the Palm Quick Install icon on the Windows desktop.
- Drag and drop files onto the Palm Quick Install window.
- Use the commands or buttons in the Palm Quick Install window.
- Right-click a file and send it to Palm Quick Install.

The procedures that follow explain how to install applications and files using each of these methods.

To drag and drop applications or files onto the Palm Quick Install icon:

1. Copy or download the application(s) or file(s) you want to install onto your computer.
2. From My Computer or Windows Explorer, select the file(s) or folder that you want to install.

3. Drag and drop the file(s) or folder onto the Palm Quick Install icon on the Windows desktop.



Palm Quick Install displays a confirmation dialog box that shows whether the files will be installed on your handheld or on an expansion card, and you can choose the user name to which the files will be installed.

4. Click OK.

The selected files are placed in the Handheld or Expansion Card file list, based on the file extension.

5. Perform a HotSync operation to install the files. See [Chapter 21](#) for details.

NOTE Files that remain in the list after you perform a HotSync operation were not installed. This can happen if your handheld is too full to install the file or if the file type was not recognized during the HotSync operation. If files are unrecognized, try launching the associated application from your handheld and then performing another HotSync operation. If the files still remain in the list, they are not associated with an application on your handheld and cannot be installed. Expansion cards may also hold files that are not Palm application files.

To drag and drop applications or files onto the Palm Quick Install window:

1. Copy or download the application(s) or file(s) you want to install onto your computer.
2. Double-click the Palm Quick Install icon on the Windows desktop.

Handheld file list

Name	Size	Type
MultiMail.prc	409.79 KB	Palm Application
Palm Reader.prc	220.67 KB	Palm Application
PhotoCapture.prc	44.32 KB	Palm Application
Photos.prc	200.89 KB	Palm Application
thefictionwritersgui...	3.82 KB	Palm Database

Expansion card file list

Name	Size	Type
babypics.JPG	60.28 KB	JPG File
BB_Cruisin' Tunes...	3.58 MB	MP3 Format Sound
Rose006.jpg	282.30 KB	JPG File
SnowedInDa.jpg	71.17 KB	JPG File
Sunrise2.jpg	625.78 KB	JPG File
Surfing_22_Plac...	2.22 MB	MP3 Format Sound

Status bar

1 item, 71.17 KB

3. From My Computer or Windows Explorer, select the file(s) or folder that you want to install.

4. Drag and drop the file(s) or folder onto the handheld or expansion card file list.

If a No symbol appears when you attempt to drag a file onto a file list, that file is not supported on that destination.

The status bar shows the number of files selected and their total size. However, since some file types are compressed during synchronization, they may actually require less space than the amount shown in the file size column or status bar.

5. Perform a HotSync operation to install the files. See [Chapter 21](#) for details.

NOTE Files that remain in the list after you perform a HotSync operation were not installed. This can happen if your handheld is too full to install the file or if the file type was not recognized during the HotSync operation. If files are unrecognized, try launching the associated application from your handheld and then performing another HotSync operation. If the files still remain in the list, they are not associated with an application on your handheld and cannot be installed. Expansion cards may also hold files that are not Palm application files.

To use the command buttons in the Palm Quick Install window:

1. Copy or download the application(s) or file(s) you want to install onto your computer.
2. Double-click the Palm Quick Install icon on the Windows desktop.

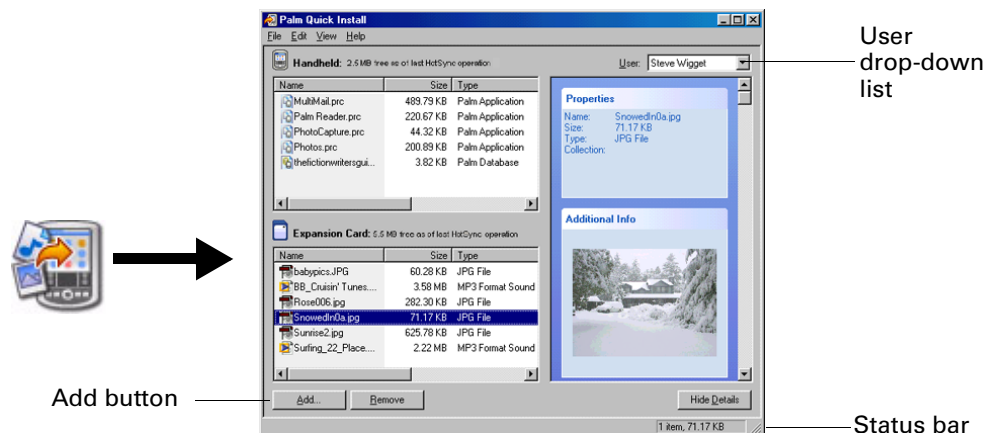

3. In the User drop-down list, select the name that corresponds to your handheld.

4. Click Add.

TIP To install a folder, open the File menu and select Add Folder.

5. Select the application(s) or file(s) that you want to install.

If you do not see the application(s) or file(s) in the default folder, navigate to the folder that contains the application(s) or file(s) that you want to install.

6. Click OK.

7. If you need to change the destination of the application you are installing, drag the files to move applications between the handheld and expansion card file list.

The status bar shows the number of files selected and their total size. However, since some file types are compressed during synchronization, they may actually require less space than the amount shown in the file size column or status bar.

8. Perform a HotSync operation to install the selected application(s). See [Chapter 21](#) for details.

NOTE Files that remain in the list after you perform a HotSync operation were not installed. This can happen if your handheld is too full to install the file or if the file type was not recognized during the HotSync operation. If files are unrecognized, try launching the associated application from your handheld and then performing another HotSync operation. If the files still remain in the list, they are not associated with an application on your handheld and cannot be installed. Expansion cards may also hold files that are not Palm application files.

To use the right-click menu to send the file to Palm Quick Install:

1. Copy or download the application(s) or file(s) you want to install onto your computer.
2. From My Computer or Windows Explorer, right-click the file(s) or folder that you want to install.
3. Select Send To and then select Palm Quick Install.

Palm Quick Install displays a confirmation dialog box that shows whether the files will be installed on your handheld or on an expansion card.

4. Click OK.

The selected files are placed in the Handheld or Expansion Card file list, based on the file extension.

5. Perform a HotSync operation to install the files. See [Chapter 21](#) for details.
Any unrecognized files are not installed.

Palm Quick Install tips

The following tips can help you use Palm Quick Install most effectively:

- Audio files are automatically placed in the expansion card file list. If you attempt to place audio files in the handheld file list, a No symbol appears.
- By default, video files are placed in the expansion card file list. If you prefer to store these files on your handheld you can move them to the handheld file list.
- When you drag and drop a folder, Palm Quick Install looks at files in the first level of subfolders only; it does not look at folders nested inside the subfolders.

- To install files in a different location, start Palm Quick Install and drag the files to a different file list.
- You can also access the Palm Quick Install window by clicking Quick Install on the Palm Desktop Launch bar.

Installing applications and files on a Mac computer

The Install Tool makes it easy to install applications and files during a HotSync operation. You can specify whether to install the files on your handheld or on an expansion card.

To install add-on software on your handheld using a Mac computer:

1. On your Mac computer, copy or download the application you want to install into the Add-on folder in your Palm folder.
2. Double-click the HotSync Manager icon in the Palm folder.
3. From the HotSync menu, select Install Handheld Files.
4. From the User pop-up menu, select the name that corresponds to your handheld.

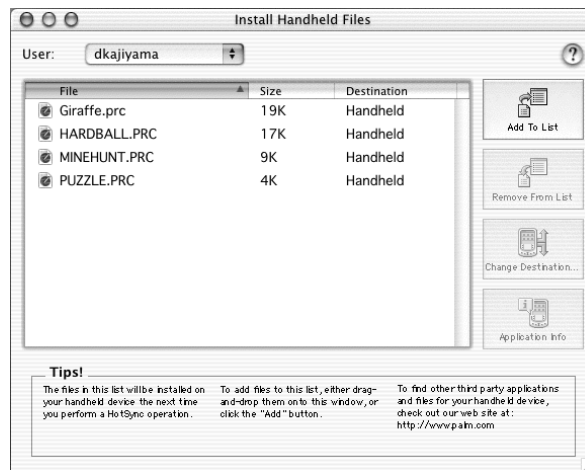

5. Click Add To List.

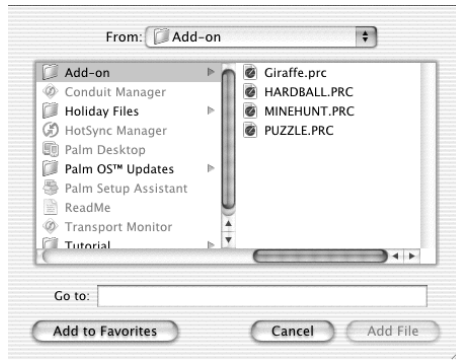

If the file you want to install is not listed in the dialog box, go to the folder to which you copied the file. Most handheld application files have the extension PRC or PDB.

6. Select the application(s) you want to install.
7. Click Add File to add the selected application to the Install Handheld Files list.

TIP You can also drag files or folders of files to the list in the Install Handheld Files dialog box. The files are copied to the Files To Install folder.

8. If you need to change the destination of the application you are installing, click Change Destination in the Install Handheld Files window, and then use the arrows to move applications between your handheld and an expansion card.





9. Click OK to close the Change Destination window.
10. Close the Install Handheld Files window.
11. Perform a HotSync operation to install the selected application(s) on your handheld. See [Chapter 21](#) for details.

NOTE Files that remain in the list after you perform a HotSync operation were not installed. This can happen if the file type was not recognized during the HotSync operation. Expansion cards may hold applications that use files other than the Palm application files. For your handheld to recognize such a file, you must first launch the associated application at least once.

Removing applications

If you run out of memory or decide that you no longer need an application you installed, you can remove applications from your handheld or from an expansion card. From your handheld, you can remove only add-on applications, patches, and extensions that you install; you cannot remove the applications that reside in the ROM portion of your handheld.

To remove an add-on application:

1. Tap the Home icon .
2. Tap the Menu icon .
3. Select Delete on the App menu.
4. Tap the Delete From pick list and select either Handheld or Card. If you want to delete applications from a card, the card must be seated in the expansion card slot.
5. Tap the application that you want to remove.



6. Tap Delete.
7. Tap Yes.
8. Tap Done.

Removing Palm Desktop software

If you no longer want to use Palm Desktop software, you can remove it from your computer.

This process removes only the application files. The data in your Users folder remains untouched.

IMPORTANT If you remove Palm Desktop software, you also remove the HotSync Manager synchronization software and can no longer synchronize with your computer. If you want to synchronize data with another personal information manager (PIM), you need to install HotSync Manager from the Desktop Software CD-ROM after you remove Palm Desktop software. During the installation, select the Custom option and then choose to install only HotSync Manager.

NOTE You may need to modify the steps shown here to accommodate the version of the operating system installed on your computer.

To remove Palm Desktop software from a Windows computer:

1. From the Windows Start menu, select Settings and then click Control Panel.
2. Double-click the Add/Remove Programs icon.
3. Click the Change or Remove Programs button.
4. Select Palm Desktop.
5. Click Change/Remove.

This process removes only the application files. The data in your Users folder remains untouched.

6. Click Yes in the Confirm File Deletion box.
7. Click OK.
8. Click Close.

To remove Palm Desktop software from a Mac computer:

1. Insert the Desktop Software CD-ROM into the CD-ROM drive on your computer.
2. Double-click the Desktop Software CD-ROM icon on your desktop.
3. Double-click the Palm Desktop Installer icon.
4. From the Easy Install screen, select Uninstall from the pop-up menu.
5. Select the software you want to remove.
6. Click Uninstall.
7. Select the folder that contains your Palm Desktop software files.
8. Click Remove.
9. Restart your computer.

Using Address Book

 Address Book enables you to keep names, addresses, phone numbers, and other information about your personal or business contacts. Use Address Book to do the following:

- Quickly look up or enter names, addresses, phone numbers, and other information. See “[Finding information](#)” in [Chapter 4](#) for details.
- Enter up to five phone numbers (home, work, mobile, fax, and so on) or e-mail addresses for each name.
- Dial a phone number and send an e-mail or SMS message directly from Address Book using the Quick Connect feature. See “[Making connections from Address Book](#)” later in this chapter.
- Define which phone number appears in the Address list for each Address Book entry.
- Attach a note to each Address Book entry, in which you can enter additional information about the entry.
- Assign Address Book entries to categories so that you can organize and view entries in logical groups.
- Create your own digital business card that you can beam or send to other devices with an application that can read the data.

To open Address Book:

- Press the Address Book application button on the front panel of your handheld. Address Book opens to display the list of all your records.

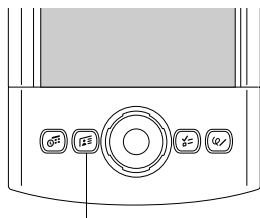

Address Book button

TIP Press the Address Book application button repeatedly to cycle through the categories in which you have records. You can also press and hold the Address Book application button to instantly beam your business card to another device with an IR port. The receiving device must also have an application that can read the Address Book data.

Creating an Address Book entry

A record in Address Book is called an *entry*. You can create entries on your handheld, or you can use Palm™ Desktop software or Microsoft Outlook to create entries on your computer and then transfer the entries to your handheld with your next HotSync® operation.

Palm Desktop software also has data import capabilities so that you can load database files into Address Book on your handheld.

See “Importing data” in Chapter 3 and Palm Desktop online Help for more information.

To create a new Address Book entry:

1. Press the Address Book application button  on the front of your handheld to display the Address list.
2. Tap New.

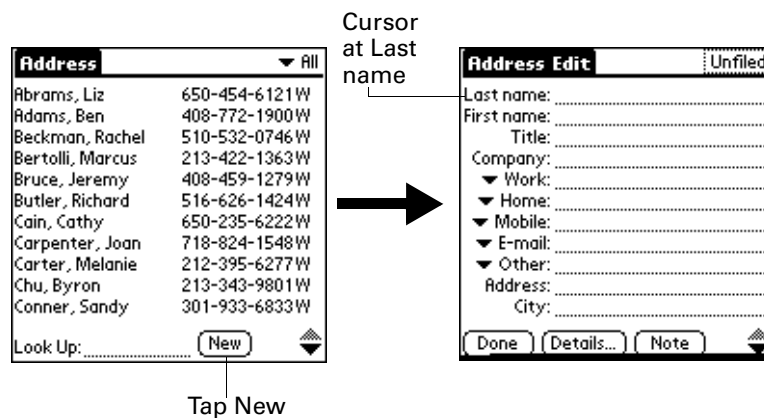

3. Enter the last name of the person you want to add to your Address Book.

The handheld automatically capitalizes the first letter of each field (except numeric and e-mail fields). You do not have to use the Graffiti® 2 capital stroke to capitalize the first letter of the name.

4. Tap the First Name field.
5. Enter the first name of the person in the First Name field.

6. Enter the other information that you want to include in this entry.

As you enter letters in the Title, Company, City, and State fields, text appears for the first logical match that exists in your Address Book. As you enter more letters, a closer match appears. For example, you may already have Sacramento and San Francisco in your Address Book. As you enter *S*, Sacramento appears, and as you continue entering *a* and *n*, San Francisco replaces Sacramento. As soon as the word you want appears, tap the next field to accept the word.

7. Tap the scroll arrows \blacktriangleup to move to the next page of information.
8. After you finish entering information, tap Done.

The screenshot shows a form titled 'Address Edit' with a 'Business' category. The fields are filled with the following information: Last name: Weston, First name: Michelle, Title: (empty), Company: Example, Inc., Work: 555-6338, Home: (empty), Fax: (empty), Other: (empty), and E-mail: (empty). At the bottom of the form are three buttons: 'Done', 'Details...', and 'Note', followed by a scroll arrow.

Tap Done

TIP To create an entry that always appears at the top of the Address list, begin the Last name or Company field with a symbol, as in *If Found Call*. This entry can contain contact information in case you lose your handheld.

TIP To attach a note to an entry and work with attached notes, see [“Attaching notes”](#) in [Chapter 4](#).

Selecting types of phone numbers

You can select the types of phone numbers or e-mail addresses that you associate with an Address Book entry. Any changes you make apply only to the current entry.

To select other types of phone numbers in an entry:

1. Tap the entry that you want to change.
2. Tap Edit.

3. Tap the pick list next to the label you want to change.

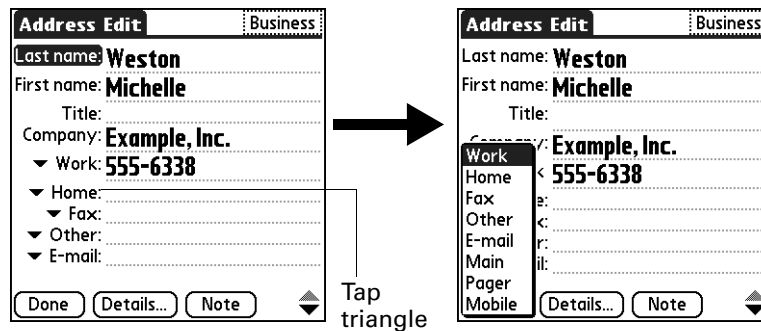

4. Select a new label.

Changing Address Entry details

The Address Entry Details dialog box provides a variety of options that you can associate with an entry.

To open the Address Entry Details dialog box:

1. Tap the entry whose details you want to change.



TIP You can also use the navigator to open an Address entry. See [“Using the navigator”](#) in [Chapter 2](#) for instructions.

2. Tap Edit.
3. Tap Details.

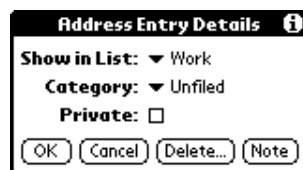

4. Select any of the following settings:

- | | |
|---------------------|--|
| Show in List | Select which type of phone or other information appears in the Address list screen. Your options are Work, Home, Fax, Other, E-mail, Main, Pager, and Mobile. The identifying letters <i>W</i> , <i>H</i> , <i>F</i> , <i>O</i> , <i>M</i> , or <i>P</i> appear next to the record in the Address list, depending on which information is displayed. If you select E-mail, no identifying letter is displayed. |
| Category | Assign the entry to a category. |
| Private | Hide this entry when Security is turned on. See “Sounds & Alerts Preferences” in Chapter 22 for more information, |

Making connections from Address Book

You can use the entries in your Address Book to launch applications that perform tasks such as dialing a phone number or creating an e-mail or SMS message. Some of the applications you can launch are included on your handheld, others on the Software Essentials CD-ROM that comes with your handheld, and yet others may be available from third-party developers and are sold separately. Most of these applications require a Global System for Mobile Communications (GSM) phone or an optional modem accessory that is compatible with your handheld (mobile phone and modem accessory sold separately).

NOTE Palm works with developers of third-party add-on applications to ensure the compatibility of these applications with your new Palm handheld. Some third-party applications, however, may not have been upgraded to be compatible with your new Palm handheld. If you suspect that a third-party application is adversely affecting the operation of your handheld, contact the developer of the application.



Quick Connect

You can use Quick Connect to select an entry and initiate a related task with one hand, using the navigator. You can also configure which application opens when you choose a specific Address record field, and whether to add a prefix to all phone numbers.

To use Quick Connect from an Address entry:

1. Open the Address entry to which you want to connect.
2. Press Right on the navigator to open the Quick Connect dialog box.

TIP You can also tap the Quick Connect icon in the title bar of the Address record.

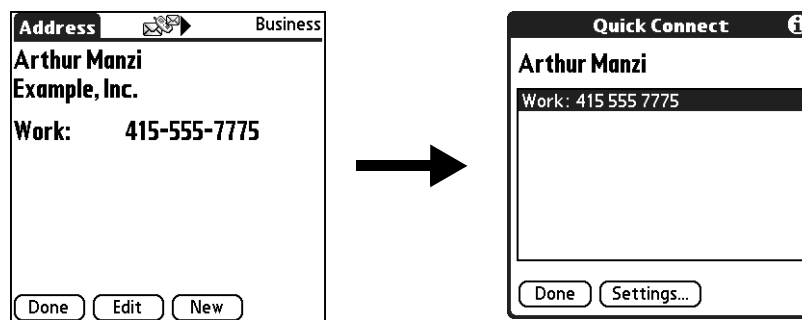

3. Select the method you want to use to connect.

Quick Connect initiates the related task. For example, if you tap a phone number, Quick Connect sends the selected phone number to your mobile phone.

To use Quick Connect from the Address list:

1. Highlight the Address entry to which you want to connect.
2. Tap the Menu icon .
3. Select Connect on the Record menu.
4. Select the method you want to use to connect.

Quick Connect initiates the related task. For example, if you tap a phone number, Quick Connect sends the selected phone number to your mobile phone.

To configure Quick Connect settings:

1. From the Quick Connect dialog box, tap Settings.

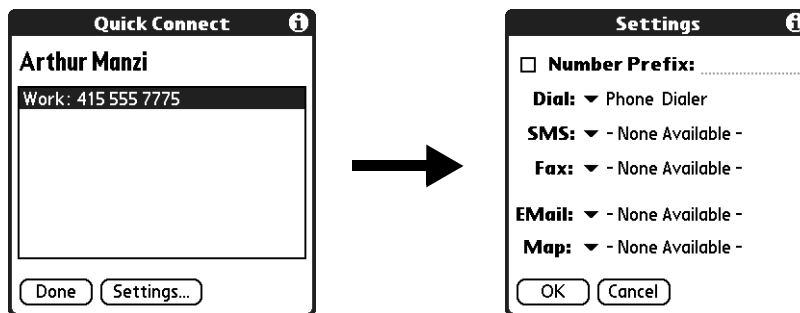

2. (Optional) Tap the Number Prefix check box and enter a prefix.

For example, to dial 1 before all phone numbers, select this check box and enter a "1" in this field. The prefix is not added to a number that begins with the "+" character.

3. Tap each of the pick lists and select the application you want to associate with that task.
4. Tap OK.

Tap-to-Connect

With Tap-to-Connect you can select an entry and initiate a related task by tapping it with the stylus. By default, Tap-to-Connect is not enabled.

To enable Tap-to-Connect:

1. From the Address list, tap the Menu icon .
2. Select Option, and then select Preferences.
3. Tap Enable Tap-to-Connect.
4. Tap OK.

TIP You can also configure which application opens when you tap a specific Address record field, and whether to add a prefix to all phone numbers. See [“Quick Connect”](#) earlier in this chapter to learn how to configure these settings.

To make a connection with Tap-to-Connect:

1. Open the Address entry to which you want to connect.
2. Tap an item.

For example, to dial a phone number, tap the number you want to dial. To address an e-mail message, tap an e-mail address.

3. (Optional) Tap the number to edit it.

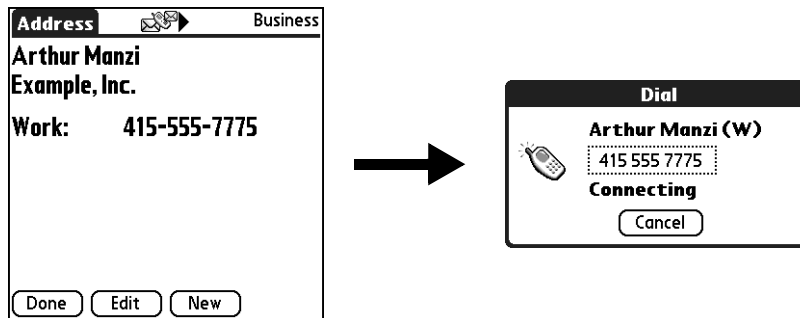

For example, you might want to add an area code, a “1,” or a country code before a phone number.

Using Address Book menus

Address Book menus are shown here for your reference, and Address Book features that are not explained elsewhere in this book are described here.

See [“Using menus”](#) in [Chapter 4](#) for information about selecting menu commands.

The Record and Options menus differ depending on whether you’re displaying the Address list screen or the Address view screen.

Record menus

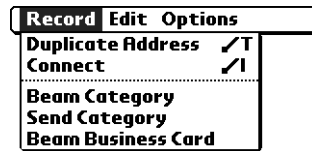

Address list

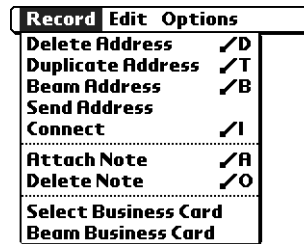

Address view

- Duplicate Address** Makes a copy of the current record and displays the copy in Address Edit so you can make changes to the copied record. The copy has the same category and attached notes as the original record.
- Connect** Opens the Quick Connect dialog box, where you can choose which application you want to use to make the connection.
- Send Category** Opens a dialog box where you can choose how you want to send all records in the selected category to another device. The options available depend on the software installed on your handheld.
- Send Address** Opens a dialog box where you can choose how you want to send the selected entry to another device. The options available depend on the software installed on your handheld.

Options menus



Address list



Address Edit view

Preferences Opens a dialog box where you can choose Address Book display options.

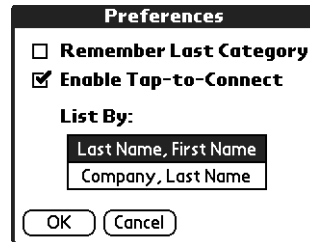

Remember last category. Determines how Address Book appears when you return to it from another application. If you select this check box, Address Book shows the last category you selected. If you deselect it, Address Book displays the All category.

Rename Custom Fields These custom fields appear at the end of the Address Edit screen. Rename them to identify the kind of information you enter in them. The names you give the custom fields appear in all entries.

You can use these custom fields to track additional information in your Address records such as names of spouses, children, or any other details.

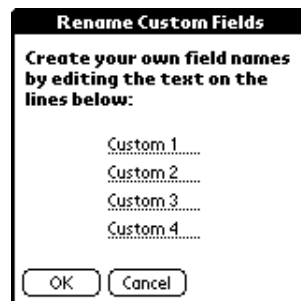



About Address Book Shows version information for Address Book.

Using Calculator

 Calculator enables you to perform basic calculations. Use Calculator to do the following:

- Perform addition, subtraction, multiplication, division, and square root operations.
- Store and retrieve values.
- Display the last series of calculations, which is useful for confirming a series of “chain” calculations.

To open Calculator:

1. Tap the Home icon .
2. Tap the Calculator icon .

Performing calculations

The Calculator includes several buttons to help you perform calculations.

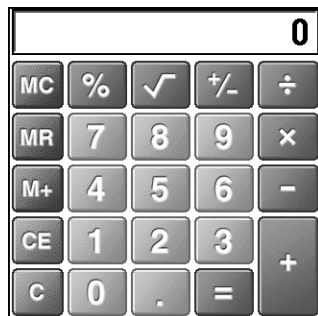

Clears the entire calculation so that you can begin a fresh calculation.



Clears the last number you entered. If you make a mistake while entering a number in the middle of a calculation, you can use this button to reenter the number without starting the calculation over.



Toggles the current number between a negative and positive value. If you want to enter a negative number, enter the number first *and then* press the +/- button.



Places the current number into memory. Each new number you enter with the M+ button is *added to the total* already stored in memory. The number that you add can be either a calculated value or any number you enter by pressing the number buttons. Pressing this button has no effect on the current calculation (or series of calculations); it merely places the value into memory until it is recalled.



Recalls the stored value from memory and inserts it in the current calculation.



Clears any value that is stored in the Calculator memory.



Calculates the square root of a number. Enter the number, and then tap the square root button.

Viewing Recent Calculations

The Recent Calculations command enables you to review the last series of calculations and is particularly useful for confirming a series of “chain” calculations.

To display recent calculations:

1. Tap the Menu icon .
2. Select Options, and then select Recent Calculations.

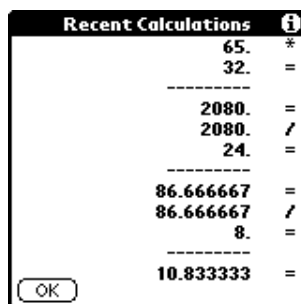

3. After you finish reviewing the calculations, tap OK.

Using Calculator menus

The Calculator menu is shown here for your reference, and Calculator features that are not explained elsewhere in this book are described here.

See “Using menus” in [Chapter 4](#) for information about choosing menu commands.

Options menu

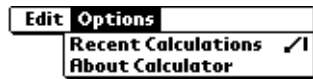

About Calculator Shows version information for Calculator.

Using Card Info



 Card Info enables you to review general information about an expansion card. Use Card Info to do the following:

- Review card contents.
- Rename a card.
- Format a card.

Reviewing Card Information

You can view the card name, type, available storage space, and a summary of its contents.

To review Card Information:

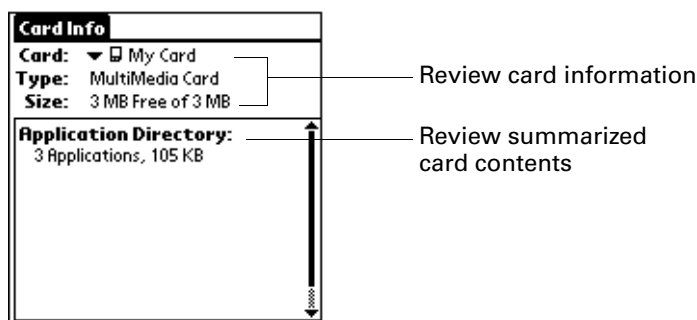

1. Tap the Home icon .
2. Tap the Card Info icon .
3. Review Card name, Type, and Size.
4. Review card contents summarized by directory.



Renaming a card

The expansion card name appears in the Category pick list and in other lists that enable you to choose where to store information on your handheld. You can assign a name to each expansion card that indicates its contents.

To rename a card:

1. Tap the Home icon .
2. Tap the Card Info icon .
3. Tap the Menu icon .
4. Select Rename Card from the Card menu.
5. Enter the new name for the card.

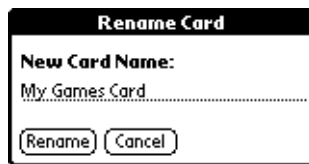



6. Tap Rename.

Formatting a card

Formatting a card destroys all its data and prepares it to accept new applications and data.

To format a card:

1. Tap the Home icon .
2. Tap the Card Info icon .
3. Tap the Menu icon .
4. Select Format Card from the Card menu.
5. Tap OK.

Managing expansion cards

- When writing data to an expansion card, wait for your handheld to complete the operation before removing the card from the slot. This prevents data corruption or accidental damage to the expansion card.
- You can install applications to an expansion card after performing an initial HotSync® operation. See “Installing files and add-on applications” in [Chapter 4](#) for information. For optimal performance, we recommend that you do not install more than fifty applications to a single expansion card.
- Reading and writing information on an expansion card uses more battery power than performing the same task on your handheld. If you have ample storage space on your handheld, consider copying the information to your handheld.

NOTE You must store and access MP3 files from an expansion card.

- When your handheld’s battery level becomes very low, access to the expansion card may be disabled to protect your data. If this occurs, recharge your handheld as soon as possible.

Using Card Info menus

The Card Info menu is shown here for your reference, and Card Info features that are not explained elsewhere in this book are described here.

See “Using menus” in [Chapter 4](#) for information about selecting menu commands.

Card menu

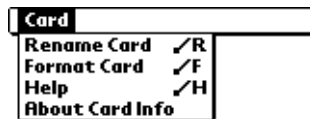

Help Provides help text.

About Card Info Shows version information for Card Info.

Using Date Book



Date Book enables you to quickly and easily schedule appointments or any kind of activity associated with a time and date. Use Date Book to do the following:

- Display an agenda showing appointments, untimed events, and your To Do items for the day.
- Enter a description of your appointment, and assign it to a specific time and date.
- Display a chart of your appointments for an entire week. The Week View makes it easy to spot available times and potential scheduling overlaps or conflicts.
- Display a monthly calendar to quickly spot days where you have morning, lunch, or afternoon appointments.
- Set an alarm to notify you of the scheduled activity.
- Create reminders for events that are based on a particular date, rather than on time of day. Birthdays and anniversaries are easy to track with your handheld.
- Attach notes to individual events for a description or clarification of the entry in your Date Book.

To open Date Book:

- Press the Date Book application button on the front panel of your handheld. Date Book opens to today's schedule.

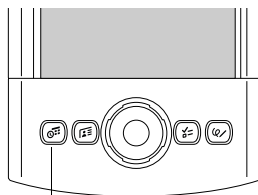

Date Book button

TIP Press the Date Book application button repeatedly to cycle through the Day, Week, Month, and Agenda views.

When you open Date Book, the screen shows the current date and a list of times for a normal business day.

Scheduling an event

A record in Date Book is called an *event*. An event can be any kind of activity that you associate with a day. You can enter a new event on any of the available time lines.

When you schedule an event, its description appears on the time line, and its duration is automatically set to one hour. You can easily change the start time and duration for any event.

It's possible to schedule events that overlap, but Date Book makes it easy to find such conflicts. See [“Spotting event conflicts”](#) later in this chapter.

You can also schedule events in your Date Book that occur on a particular date but have no specific start or end times, such as birthdays, holidays, and anniversaries. These are referred to as “untimed events.” Untimed events appear at the top of the list of times, marked with a diamond. You can have more than one untimed event on a particular date.

You can also schedule a repeating event, such as a weekly meeting, and continuous events, such as a three-day conference or a vacation.

To schedule an event for the current day:

1. Tap the time line that corresponds to the beginning of the event.

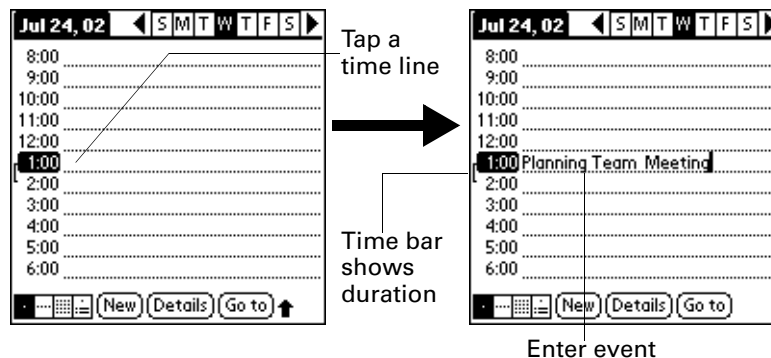

2. Enter a description of the event. You can enter up to 255 characters.
3. If the event is one hour long, skip to step 5. If the event is longer or shorter than an hour, tap the time of the event to open the Set Time dialog box.

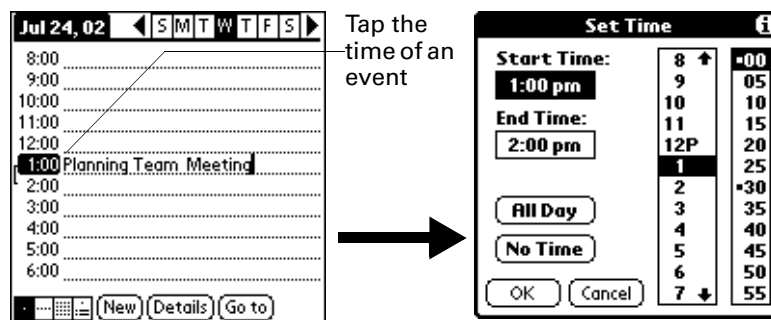

TIP You can also use the Graffiti® 2 writing area to open the Set Time dialog box. Make sure that no event is selected, and then on the number side of the Graffiti 2 writing area, write a number for the start time of the event.

4. Do one of the following:

- Tap the time columns on the right side of the Set Time dialog box to set the start time, and then tap the End Time box and tap the time columns to set the end time.
- Tap All Day to automatically insert the start and end time of the event as defined in your Date Book Preferences.

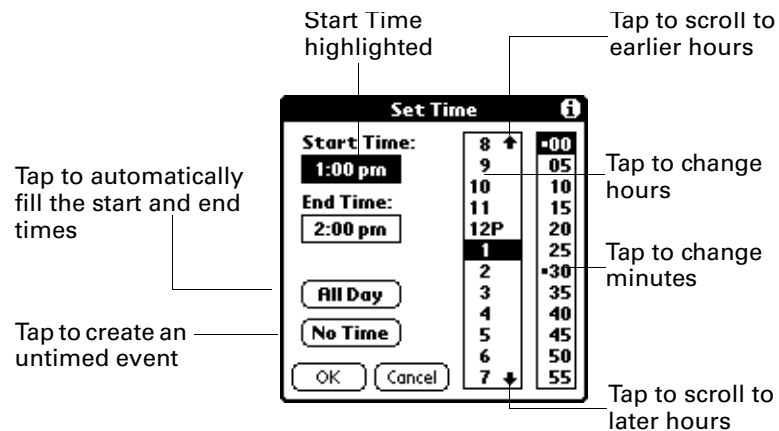

5. Tap OK.

6. Tap a blank area of the screen to deselect the event. A vertical line appears next to the time, indicating the duration of the event.

If two or more events have the same start and end time, the time appears only once.

To schedule an event for another day:

1. Select the date you want for the event by doing one of the following:

- Tap the day of the week that you want in the date bar at the top of the screen. If necessary, tap the Previous week or Next week scroll arrows to move to another week.

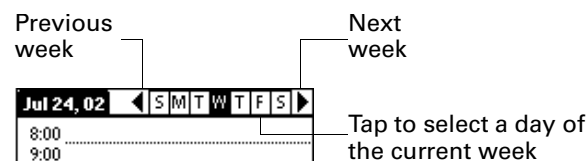

- Press Right or Left on the navigator to scroll to the next or previous day.



- Press Up or Down on the navigator to scroll within the current day.
- Tap Go To at the bottom of the screen to open the Go to Date dialog box. Select a date by tapping a year, month, and day in the calendar.

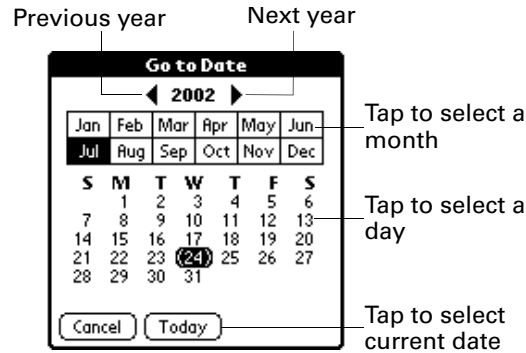

2. After you locate the date, follow the steps for scheduling an event for the current day.

To schedule an untimed event:

1. Select the date that you want for the event.
2. Tap New.
3. Tap No Time, so that no start or end times are defined for the new event.

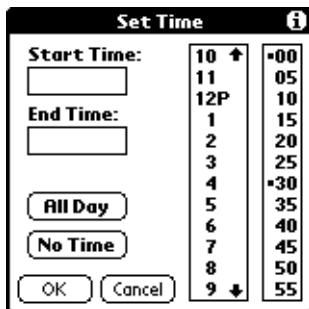

TIP You can also create a new untimed event by making sure no event is selected and then writing letters in the Graffiti 2 writing area.

4. Enter a description of the event.

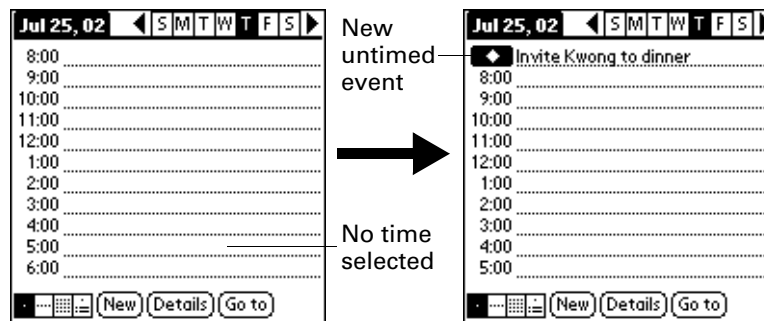

5. Tap a blank area on the screen to deselect the untimed event.

If you create an event and decide later that there is no particular start or end time, you can easily change it to an untimed event. Tap the time of the event in the Date Book screen, tap No Time, and then tap OK.

TIP To attach a note to an entry and work with attached notes, see [“Attaching notes”](#) in [Chapter 4](#).

Selecting an event

After you create an event, you can select an event to view its contents, reschedule it, make it a repeating event, and add alarms or notes.

To select an event:

1. Go to the day on which the event is scheduled.
2. Tap the event.



TIP You can also press Select on the navigator to insert the highlight on the next event in the current day or on the first event of another day. To scroll through the events in the selected day, press Up and Down on the navigator.

Rescheduling an event

You can easily make changes to your schedule with your handheld.

To reschedule an event:

1. Select the event you want to reschedule.
2. Tap Details.
3. To change the time, tap the Time box and tap a new time.
4. To change the date, tap the Date box and tap a new date.
5. Tap OK.

Setting an alarm for an event

The Alarm setting enables you to set an alarm for events in your Date Book. You can set an alarm to notify you minutes, hours, or days before an event. The default Alarm setting is 5 minutes before the time of the event, but you can change this to any number of minutes, hours, or days.

When you set an alarm, the Alarm icon  appears at the far right of the event. When the alarm is triggered, a reminder message also appears onscreen.

To set an alarm for an event:

1. Select the event to which you want to assign an alarm.
2. Tap Details.
3. Tap the Alarm check box to select it.

The default setting, 5 Minutes, appears.

4. Tap the pick list to select Minutes, Hours, or Days.
5. Select the 5 and enter any number from 0 to 99 (inclusive) as the number of time units.

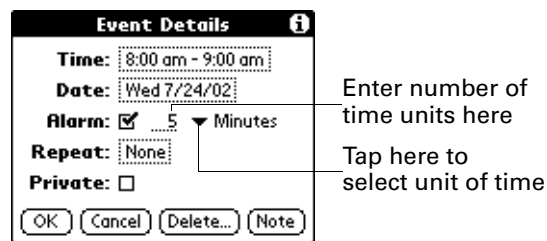

6. Tap OK.
7. When the reminder message appears onscreen, do one of the following:
 - Tap OK to permanently dismiss the reminder and return to the current screen.
 - Tap Snooze to dismiss the reminder and return to the current screen. An attention indicator blinks in the upper-left corner of the screen to remind you of the pending alarm, and the reminder message appears again five minutes later.

- Tap Go To to open Date Book. Date Book will open and display the event associated with the alarm.

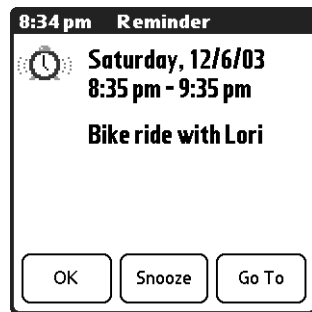

Alarm for untimed events: You can set a silent alarm for an untimed event. In this case the alarm is triggered at the specified period of minutes, hours, or days before midnight (beginning) of the day of the untimed event. When the alarm is triggered, the reminder list displays the alarm message until you clear it. See [“Receiving alerts”](#) in [Chapter 4](#) for details.

For example, you set an alarm for an untimed event that occurs on February 4. If the alarm is set for 5 minutes, the reminder message appears at 11:55 PM on February 3. The reminder remains in the reminder list until you turn on your handheld and dismiss it.

Scheduling repeating or continuous events

The Repeat function enables you to schedule events that recur at regular intervals or that extend over a period of consecutive days.

A birthday is a good example of an event that repeats annually. Another example is a weekly guitar lesson that falls on the same day of the week and the same time of day.

A business trip or a vacation is an example of a continuous event.

To schedule a repeating or continuous event:

1. Select the event.
2. Tap Details.

3. Tap the Repeat box to open the Change Repeat dialog box.

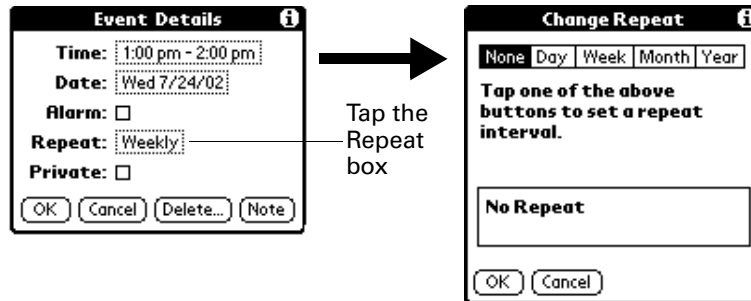

4. Tap Day, Week, Month, or Year to set how often the event repeats.
For a continuous event, tap Day.
5. On the Every line, enter a number that corresponds to how often you want the event to repeat
For example, if you select Month and enter the number 2, the event repeats every other month.
6. To specify an end date for the repeating or continuous event, tap the End on pick list and tap Choose Date. Use the date picker to select an end date.
7. Tap OK.

After you schedule a repeating or continuous event, the Repeat icon  appears at the far right of the event.

Changing repeating or continuous events

When you make changes to a repeating or continuous event, such as deleting or adding notes or changing the time of an event, you can decide which of the events you want to change—all events in the series, just the current event, or the current and future events.

To delete repeating events:

1. Select the record you want to delete.
2. Tap the Menu icon .
3. Select Delete Event from the Record menu.

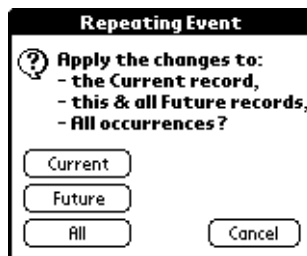

4. Do one of the following:
 - Tap Current to delete only the current event item.
 - Tap Future to delete the current and all future event items and reset the end date of the repeating event to the last shown date.
 - Tap All to delete all occurrences of the repeating event.
5. Tap OK.

Considerations for repeating or continuous events

Keep the following points in mind:

- If you change the start date of a repeating event, your handheld calculates the number of days you moved the event. Your handheld then automatically changes the end date to maintain the duration of the repeating event.
- If you change the repeat interval of a repeating event (such as from daily to weekly) previous occurrences of that event are not changed, and your handheld creates a new repeating event.
- If you change the date of an occurrence of a repeating event (such as from January 14 to January 15) and apply the change to all occurrences, the new date becomes the start date of the repeating event. Your handheld adjusts the end date to maintain the duration of the event. If you apply the change to current and future occurrences, past occurrences are not changed.
- If you change other settings of a repeating event (such as time, alarm, private) and apply the change to all occurrences, your handheld creates a new event. The start date of this new event is the day on which the setting is changed.
- If you apply a change to a single occurrence of a repeating event (such as time), that occurrence no longer shows the Repeat icon .

Changing the Date Book view

In addition to displaying the time list for a specific day, you can also display a whole week, a month, or an agenda.

To cycle through Day, Week, Month, and Agenda views:

- Press the Date Book application button repeatedly to display the next view.
- Tap the appropriate view icon in the lower-left corner of Date Book.

Working in Week View

Week View shows the calendar of your events for an entire week. You can use this view to quickly review your appointments and available time slots. In addition, the graphical display helps you spot overlaps and conflicts in your schedule.

To display the Week View:

1. Tap the Week View icon.

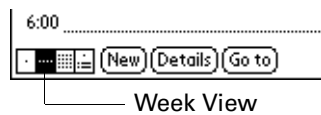

2. Tap the navigation controls to move forward or backward a week at a time, or tap on a column to display details of an event.

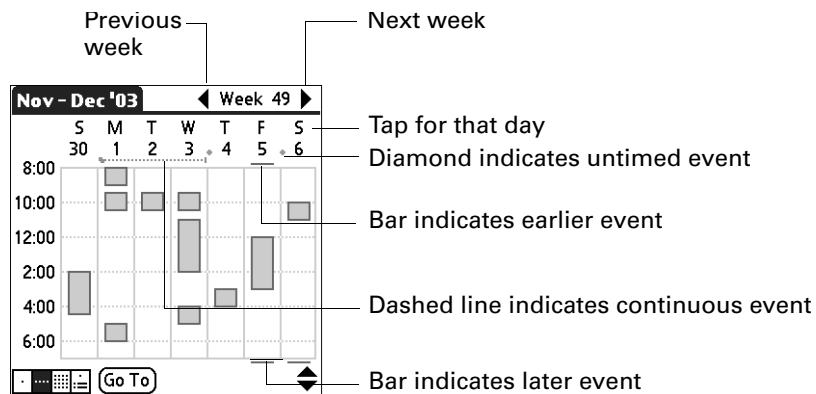

The Week View also shows untimed events and events that are before and after the range of times shown. Continuous events appear in green with the Repeat icon

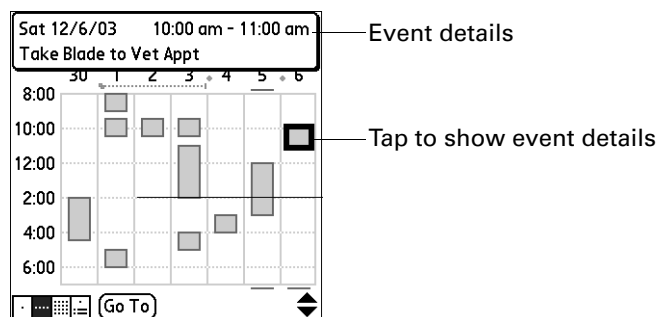

3. Tap an event to show a description of the event.



Keep the following points in mind:

- To reschedule an event, tap and drag the event to a different time or day.
- Tap a blank time on any day to move to that day and select that time for a new event.
- Tap any day or date that appears at the top of the Week View to move directly to that day without selecting an event.
- 
 - Press Right and Left on the navigator to scroll to the next or previous week.
- 
 - Press Select on the navigator to insert the highlight, and then press Right and Left to select a day within the selected week. To view the events on the selected day, press Select on the navigator again.
- 
 - The Week View shows the time span defined by the Start Time and End Time in the Date Book Preferences settings. If you have an event before or after this time span, a bar appears at the top or bottom of that day's column. Use the onscreen scroll arrows to scroll to the event, or press Up and Down on the navigator to scroll to earlier and later time slots within the selected week.

Working in Month View

The Month View screen shows which days have events scheduled. Lines in the Month View indicate events and repeating events. Diamonds indicate untimed events, and green dashed lines with a Repeat icon indicate continuous events.

2003							◀ Dec ▶	
S	M	T	W	T	F	S		
	1	2	3	4	5	6		
7	8	9	10	11	12	13		
14	15	16	17	18	19	20		
21	22	23	24	25	26	27		
28	29	30	31					

Previous/next month

Diamond below date indicates untimed event



Dashed line below date indicates continuous event

Dashes on right side indicate events

Month View button

You can control the types of events that appear in the Month View. See [“Display Options”](#) later in this chapter.

Keep the following points in mind:

- Tap a day in the Month View to display that day in the Day View.
- 
 - Tap the scroll arrows in the upper-right corner, or press Left or Right on the navigator to move forward or backward a month.
- 
 - Press Select on the navigator to insert the highlight, and then press Left or Right on the navigator to scroll to a specific day. Press Select on the navigator to display that day in the Day View.

Working in Agenda View

The Agenda View shows you your untimed events, appointments, and To Do items in one screen. When you tap on an untimed event or appointment in the Agenda View, the Day View appears so that you can see more detailed information about the event. You can tap the check box next to a To Do item to mark it as completed. When you tap a To Do item, your To Do list appears. To return to the Agenda View, press the Date Book button.

NOTE Which To Do items appear and how you can change them depend on the settings in your To Do Preferences. See “[Setting To Do Preferences](#)” in [Chapter 16](#) for more information.

To display the Agenda View:

1. Tap the Agenda View icon.

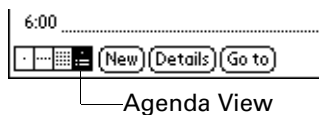

2. Tap the navigation controls to move forward or backward a day at a time, or to display more events and To Do items.



TIP You can also press Up and Down on the navigator to scroll through the events on the selected day, or press Right or Left on the navigator to scroll to the next or previous day.

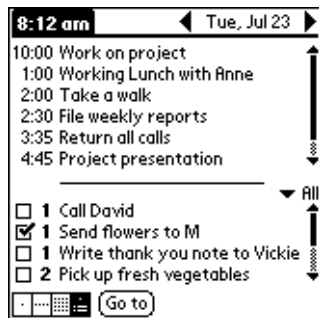

Day with appointments

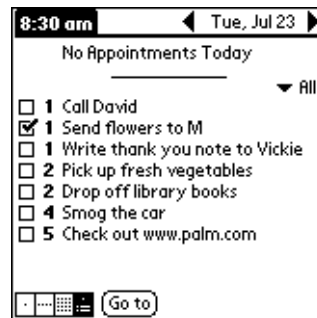

Same day without appointments

NOTE You can also change the category of To Do items shown. Tap the pick list to select another category. See [Chapter 16](#) for more information on working with To Do items.

Spotting event conflicts

With the ability to define specific start and end times for any event, it's possible to schedule events that overlap (an event that starts before a previous event finishes).

An event conflict (time overlap) appears in the Week View as overlapping bars. The first event created appears as a gray bar, and any subsequent conflicting events appear as a single red bar. The Day View displays overlapping red brackets to the left of the conflicting times. The Month View displays conflicting appointments in red.

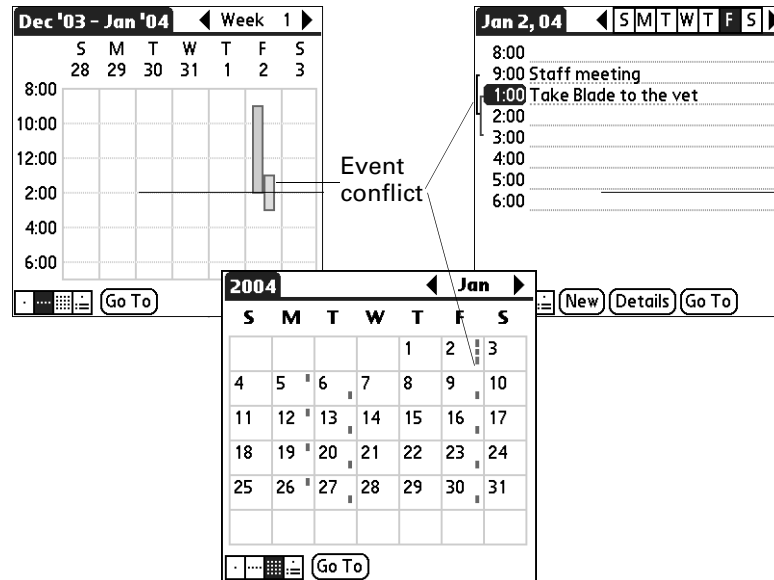

Using Date Book menus

Date Book menus are shown here for your reference, and Date Book features that are not explained elsewhere in this book are described here.

See "Using menus" in [Chapter 4](#) for information about choosing menu commands.

Record menu

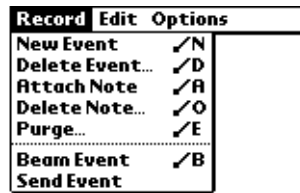

- Purge** Opens a dialog where you can choose which old events to purge from your handheld and whether you want to archive purged events on your computer.
- Send Event** Opens a dialog where you can choose how you want to send the selected event to another device. The options available depend on the software installed on your handheld.

Options menu

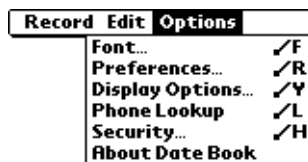

Display Options

Opens the Display Options dialog box where you can change the appearance of Date Book's Day View and control which type of events appear in Month View.



- Show Time Bars** Activates the time bars that appear in the Day View. The time bars show the duration of an event and illustrate event conflicts.
- Compress Day View** Controls how times appear in the Day View. When Compress Day View is off, all time slots appear. When it is on, start and end times appear for each event, but blank time slots toward the bottom of the screen disappear to minimize scrolling.
- Month View settings** Applies to the Month View of Date Book. You can deselect any or all of these check boxes to hide Timed, Untimed, or Daily Repeating events in the Month View *only*.

Preferences

Opens the Preferences dialog box where you can customize Date Book's default time display and alarm settings.

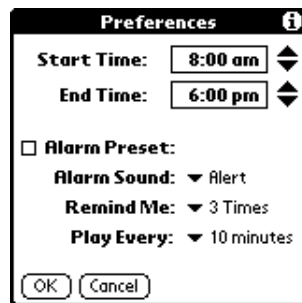

- Start/End Time** Defines the start and end times for Date Book screens. If the time slots you select do not fit on one screen, you can tap the scroll arrows  to scroll up and down.
- Alarm Preset** Automatically sets an alarm for each new event. The silent alarm for untimed events is defined by minutes, days, or hours before midnight at the beginning of the date of the event.
- Alarm Sound** Sets the tone of the alarm.
- Remind Me** Defines how many times the alarm will occur after the initial occurrence. The choices are Once, Twice, 3 Times, 5 Times, and 10 Times.
- Play Every** Defines how often the alarm sounds. The choices are Minute, 5 minutes, 10 minutes, and 30 minutes.

About Date Book

Shows version information for Date Book.

Using Palm™ Dialer





Palm™ Dialer is a fast and simple way to use your handheld to dial a telephone number on your mobile phone. The Palm Dialer also allows you to speed dial frequently called numbers and log recently called numbers.

Dialer is a good way to dial phone numbers that are not listed in Address Book. To dial numbers in Address Book, use Quick Connect. For more information, see [“Making connections from Address Book”](#) in [Chapter 5](#).

IMPORTANT Your mobile phone plan must be a Global System for Mobile Communications (GSM) phone to use Palm Dialer.

To open Palm Dialer:

1. Tap the Home icon .
2. Tap the Palm Dialer icon .

TIP The Buttons Preferences screen enables you to assign Palm Dialer to the Favorite icon or to one of the application buttons on the front of the handheld. For more information, see [“Buttons Preferences”](#) in [Chapter 22](#). Once Palm Dialer is assigned, pressing the icon or button opens the Palm Dialer application at the Speed Dial screen (see [“Dialing a speed dial entry”](#) later in this chapter).

Configuring phone preferences and connecting to your mobile phone

You need to configure the phone preferences of your handheld and connect your handheld to your mobile phone before you use Palm Dialer.

For more information on configuring your phone preferences, see [Chapter 22](#). For more information on connecting your handheld to your mobile phone, see [“Setting up a phone connection”](#) in [Chapter 14](#).

Dialing a number

Palm Dialer allows you to directly dial a number from your handheld.

To dial a number:

1. Tap the telephone number on the keypad.

TIP You can also enter the telephone number using your onscreen keyboard or Graffiti® 2 writing.

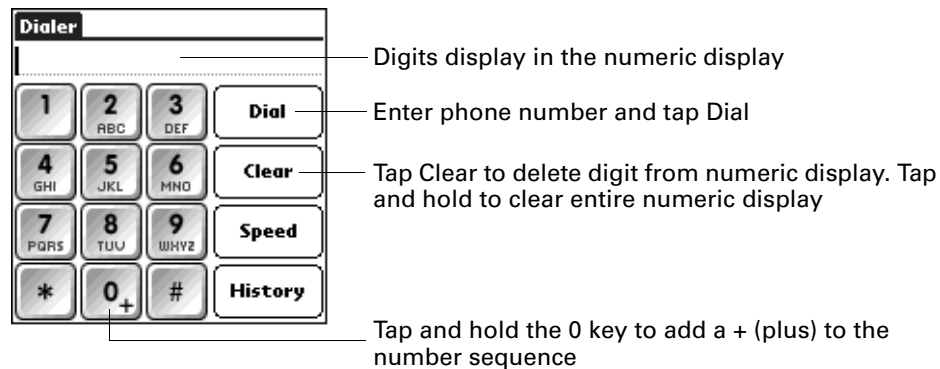

2. Tap Dial.

The number is dialed and added to the Call History list. You are now ready to communicate over your mobile phone.

Redialing the most recently dialed number

You can quickly redial the most recently dialed number from the Dialer screen.

To redial the most recently dialed number:

1. Tap Dial when the numeric display is empty.

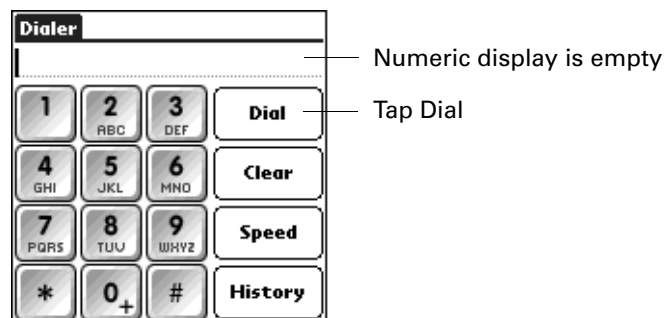

2. Tap Dial again.

The number is dialed and added to the Call History list. You are now ready to communicate over your mobile phone.

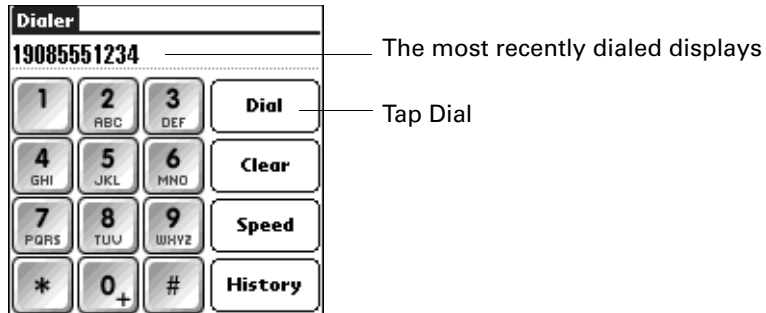

Using speed dial

Speed dialing allows you to quickly dial your most commonly used numbers. You can enter up to 10 numbers into the Speed Dial screen.

Adding a speed dial entry

To add a speed dial entry:

1. Tap Speed.

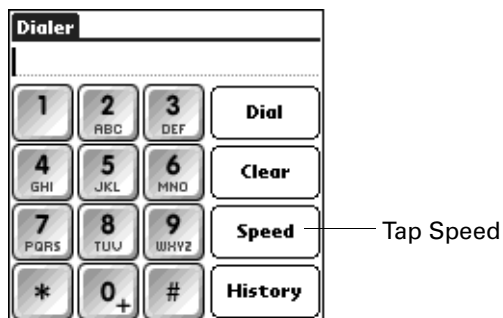

2. Tap an empty speed dial button.

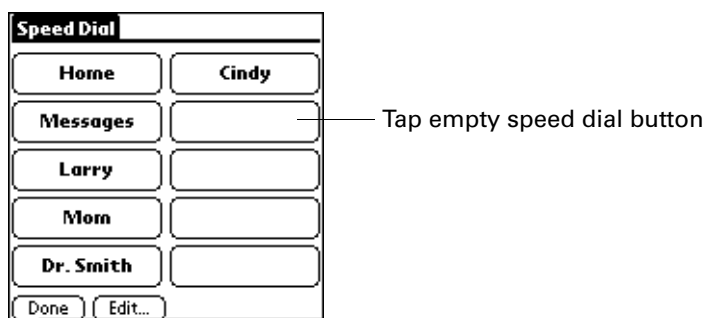

3. Enter a name and telephone number.

TIP You can add a number from your Palm Dialer numeric display or from other Palm applications by using the cut and paste feature on the Edit menu.

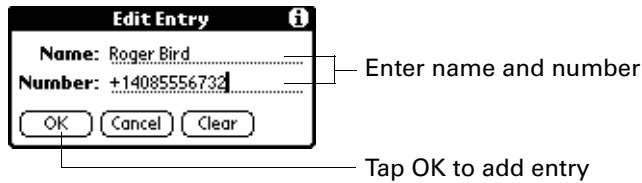

4. Tap OK.

The name appears on the speed dial button.

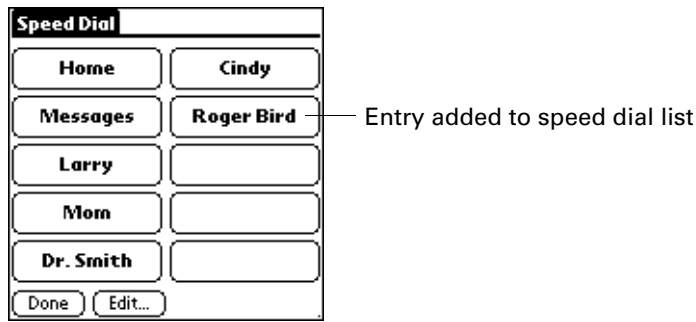

5. Tap Done.

Dialing a speed dial entry

To dial a speed dial entry:

1. Tap Speed.

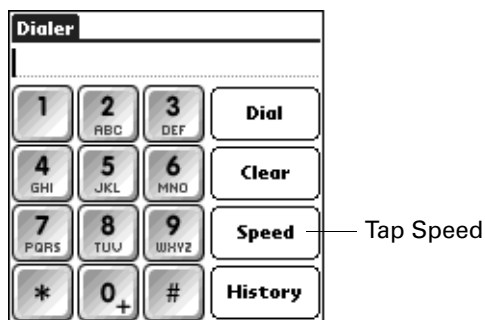

2. Tap one of the speed dial buttons.

The number is dialed and added to the Call History list. You are now ready to communicate over your mobile phone.



Tap a speed dial button to dial the number

Editing a speed dial entry

To edit a speed dial entry:

1. Tap Speed.

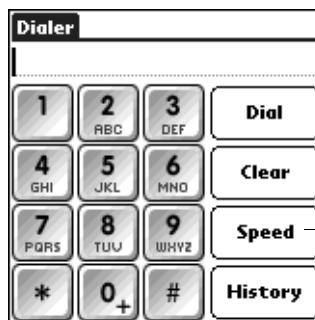

Tap Speed

2. Tap Edit.

TIP You can also go directly to the Edit Entry dialog box by tapping and holding a speed dial button.



Tap Edit

3. Tap an entry.

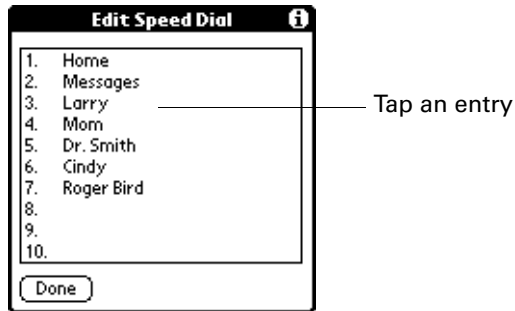

4. Edit the entry and tap OK.

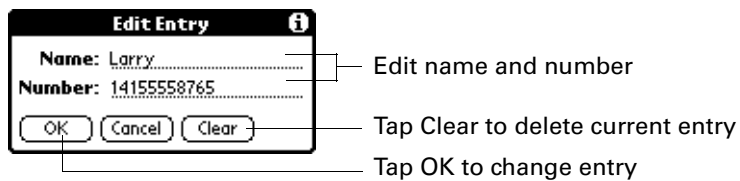

Dialing a number from the Call History list

Palm Dialer keeps a list of 11 of the most recently dialed numbers. If the number is a speed dial entry, the name from the speed dial entry appears in the Call History list.

You can dial a number using the Call History list.

To dial a number from the Call History list:

1. Tap History.

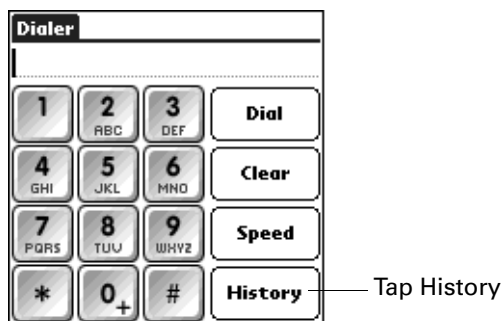

2. Tap an entry from the list.

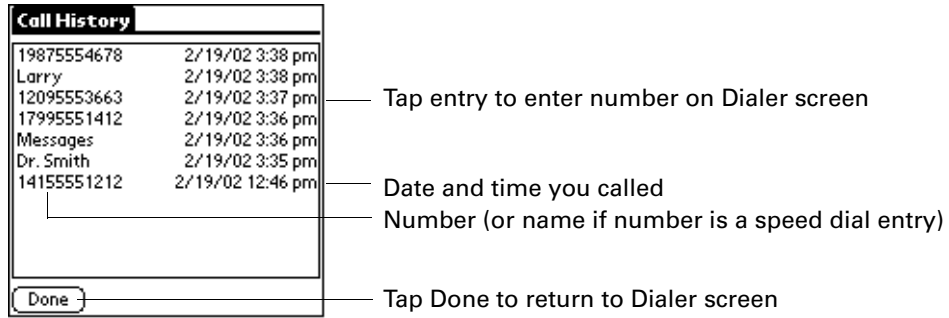

3. Tap Dial.

The number is dialed and you are now ready to communicate over your mobile phone.

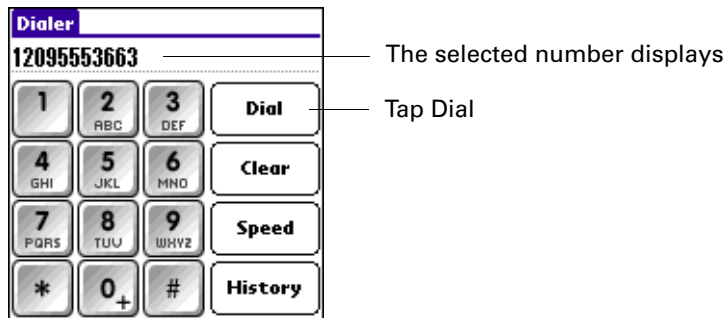

Using Expense



Expense enables you to keep track of your expenses and then transfer the information to a spreadsheet on your computer. In Expense you can do the following:

- Record dates, types of expenses, amount spent, payment method, and other details associated with any money that you spend.
- Assign expense items to categories so that you can organize and view them in logical groups.
- Keep track of vendors (companies) and people involved with each expense.
- Log miles traveled for a particular date or expense category.
- Sort your expenses by date or expense type.
- Send or export your expense information to popular computer applications, such as Microsoft Excel or Microsoft Word, using Palm™ Desktop software and HotSync® technology on a Windows computer.

To open Expense:

1. Tap the Home icon .
2. Select the Expense icon .

Expense		▼ All
4/4	Breakfast	\$ 23.00
4/4	Dinner	\$ 65.00
4/4	Hotel	\$ 88.33
4/4	Mileage	mi 366
4/4	Taxi	\$ 23.00
4/5	Business Meals	\$ 269.00

Adding expense items

A record in Expense is called an *item*. You can sort your Expense items into categories or add other information that you want to associate with the item.

To add an expense item:

1. Tap New.

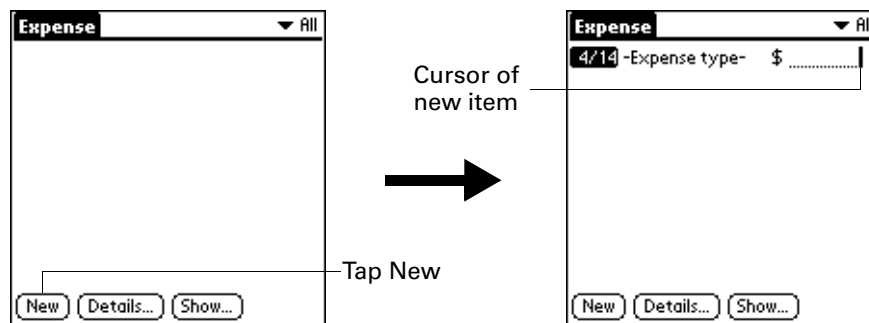

TIP You can also create a new Expense item by writing on the number side of the Graffiti® 2 writing area while in the Expense list screen. The first number you write begins the amount of your new Expense item.

2. Enter the amount of the expense.
3. Tap the Expense type pick list and select a type from the list.

As soon as you select an expense type, your handheld saves your entry. If you do not select an expense type, it does not save the entry.

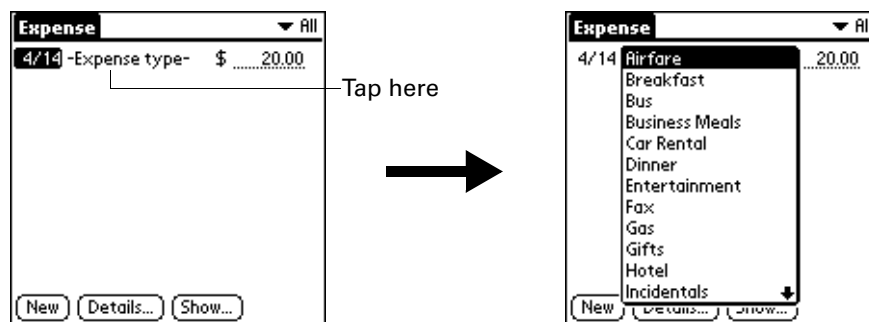

TIP Another quick way to create a new Expense item is to make sure that no Expense item is selected in the Expense list, write the first letter(s) of the expense type, and then write the numerical amount of the Expense item. This technique takes advantage of the automatic fill feature. See [“Options menu”](#) later in this chapter for details.

TIP To attach a note to an entry and work with attached notes, see [“Attaching notes”](#) in [Chapter 4](#).

Changing the date of an Expense item

Initially, Expense items appear with the date on which you enter them. You can change the date associated with any Expense item.

To change the date of an Expense item:

1. Tap the Expense item you want to change.
2. Tap the date of the selected item.

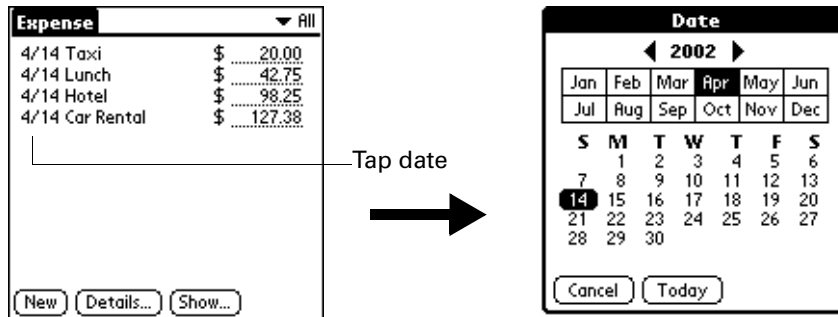

3. Tap the new date.

Entering receipt details

Expense provides a variety of options that you can associate with an item. These options appear in the Receipt Details dialog box.

To open the Receipt Details dialog box:

1. Tap the Expense item to which you want to assign details.
2. Tap Details.

The screenshot shows the Receipt Details dialog box with the following fields and options:

- Category:** Unfiled
- Type:** Lunch
- Payment:** Unfiled
- Currency:** \$
- Vendor:**
- City:**
- Attendees:** Who...

Buttons at the bottom: OK, Cancel, Delete, Note

3. Select any of the following options:

Category Opens a pick list of system and user-defined categories. See [“Categorizing records”](#) in [Chapter 4](#) for more information.

Type Opens a pick list of expense types.

- Payment** Enables you to choose the payment method for the Expense item. If the item is prepaid (such as airline tickets supplied by your company), you can choose Prepaid to place your expense in the appropriate company-paid cell of your printed expense report.
- Currency** Enables you to choose the type of currency used to pay the Expense item. The default currency unit is defined in the Preferences dialog box. You can also display up to four other common types of currency. See [“Customizing the Currency pick list”](#) later in this chapter for more information.
- Vendor and City** Enables you to record the name of the vendor (usually a company) associated with the expense and the city where the expense was incurred. For example, a business lunch might be at Rosie’s Cafe in San Francisco.
- Attendees** See [“Looking up names to add to Expense records”](#) in Chapter 4 for more information.

4. Tap OK.

Customizing the Currency pick list

You can select the currencies and symbols that appear in the Currency pick list.

To customize the Currency pick list:

1. Tap the Currency pick list in the Receipt Details dialog box, and then select Edit currencies.

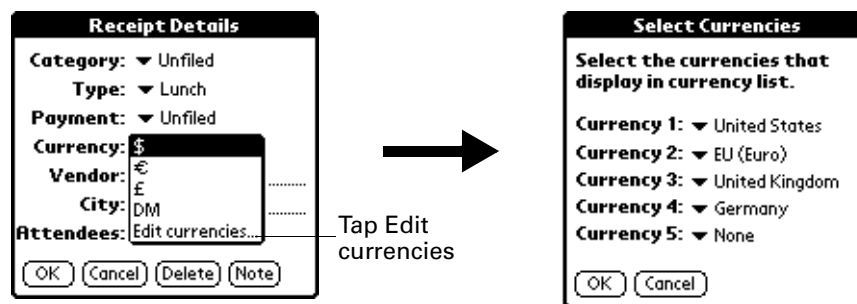

2. Tap each Currency pick list and select the country whose currency you want to display on that line.
3. Tap OK to close the Select Currencies dialog box.
4. Tap OK.

Changing the default currency

You can select which currency appears by default when you're entering Expense items. You can override this setting when entering individual expense items.

To change your default currency:

1. Open Expense.
2. Tap the Menu icon .
3. Select Options, and then select Preferences.
4. Tap the Default Currency pick list.
5. Tap the currency symbol you want to appear in Expense.

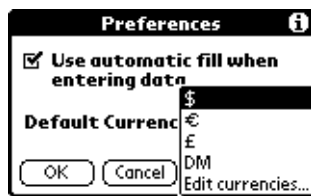

6. Tap OK.

Defining a custom currency symbol

If the currency you want to use is not in the list of countries, you can create your own custom country and currency symbol.

To define a custom currency symbol:

1. Tap the Menu icon .
2. Select Options, and then select Custom Currencies.
3. Tap one of the four Country boxes.

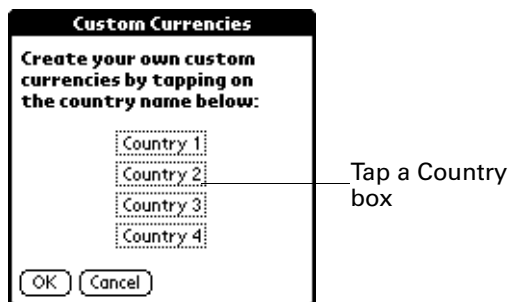

4. Enter the name of the country and the symbol that you want to appear in Expense.



5. Tap OK to close the Currency Properties dialog box.
6. Tap OK.

NOTE If you want to use your custom currency symbol as the default for all Expense items, select the symbol in the Preferences dialog box. If you want to use your custom currency symbol only for a particular Expense item, select the symbol in the Receipt Details dialog box associated with that item.

Setting Show Options

Show Options defines the sort order and other settings that relate to your Expense items.

To open the Show Options dialog box:

1. In the Expense list, tap Show.
2. Select any of the options.

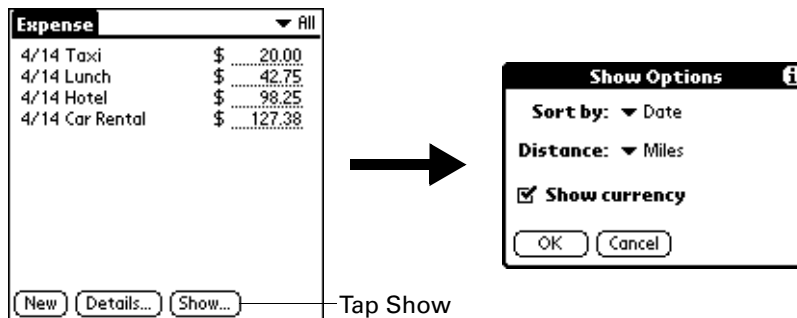

- | | |
|----------------------|--|
| Sort by | Enables you to sort expense items by date or type. |
| Distance | Enables you to display Mileage entries in miles or kilometers. |
| Show currency | Shows or hides the currency symbol in the Expense list. |

3. Tap OK.

Working with Expense data on your computer

After you enter your expenses into the Expense application on your handheld and perform a HotSync operation, Palm Desktop software enables you to do any of the following on your Windows computer. See the Palm Desktop software online help for details. This feature is not available on Mac computers.

- Add, modify, and delete your Expense data.
- Organize your Expense data by category, amount, date, type, or notes.
- View Expense data in various formats: List, Large Icons, or Small Icons.
- Record individual expenses in various currencies and display the total in one selected currency type.
- Print Expense reports.
- Transfer Expense data to other applications, such as Microsoft Excel, using the Send command or Export command, and import data in popular file formats.

Displaying the euro on your computer

When you perform a HotSync operation, the euro symbol is transferred to Palm Desktop software like any other piece of data on your handheld. The symbol appears in Palm Desktop software, however, only if you are using fonts that support the euro symbol.

These fonts are part of the operating system on your computer. They do not reside with your Desktop application, and they are not produced by Palm, Inc. For more information, refer to the documentation that accompanies your desktop computer's operating system.

Printing the euro

Even with operating system support, problems may arise when you print documents that contain the euro. When a font is present on both the printer and the computer, the printer font is used by default to increase printing speed. If the printer font does not include the euro, a box is printed instead of the euro symbol.

You can work around this problem by transferring the expense data to another application and inserting a bitmap image of the euro into the document in the appropriate places, or by not using the printer's built-in fonts (if allowed).

Using Expense menus

Expense menus are shown here for your reference, and Expense features that are not explained elsewhere in this book are described here.

See “Using menus” in [Chapter 4](#) for information about selecting menu commands.

Record menu

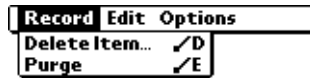

Options menu



Preferences Opens the Preferences dialog box where you can select automatic fill and default currency options.

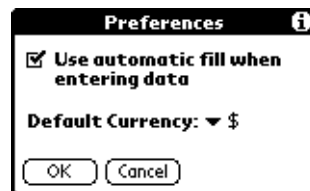

Use automatic fill. Enables you to select an expense type by writing the first letter of an expense type in the Graffiti 2 writing area. For example, if you write the letter *T*, it enters the “Taxi” expense type. Writing *T* and then *E* enters “Telephone” which is the first expense type beginning with the letters *TE*.

About Expense Shows version information for Expense.



Using Memo Pad



Memo Pad provides you with a place to take notes that are not associated with records in Date Book, Address Book, or To Do List. The number of memos you can store depends only on the memory available on your handheld. Use Memo Pad to do the following:

- Use Graffiti® 2 characters to store memos, lists, or any other text message on your handheld.
- Send memos to popular computer applications like Microsoft Word when you synchronize using Palm™ Desktop software and HotSync® technology.
- Assign memos to categories so that you can organize and view them in logical groups.
- Write down phone numbers and other types of information that you can later copy and paste into other applications.

To open Memo Pad:

1. Tap the Home icon .
2. Select the Memo Pad icon .

Creating memos

A record in Memo Pad is called a *memo*. You can assign memos to categories and mark them private as described in [Chapter 4](#). This section covers how to create a memo.

To create a new memo:

1. Open Memo Pad.
2. Tap New.

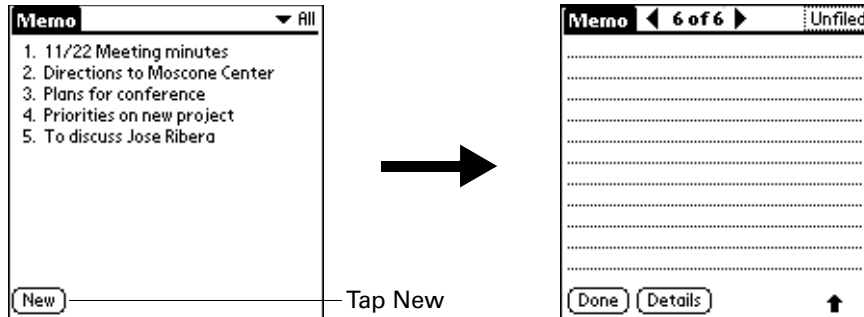

TIP In the Memo list screen, you can also begin writing in the Graffiti 2 writing area to create a new memo. The first letter is automatically capitalized and begins your new memo.

3. Enter the text you want to appear in the memo. Use the carriage return stroke to move down to new lines in the memo.
4. Tap Done.

Reviewing memos

The first line of a memo appears in the Memo list. This makes it easy to locate and review your memos.

To review a memo:

1. From the Memo list, select the text of the memo.



TIP You can also select, review, and move between memos with the navigator. See [“Using the navigator”](#) in [Chapter 2](#) for details.

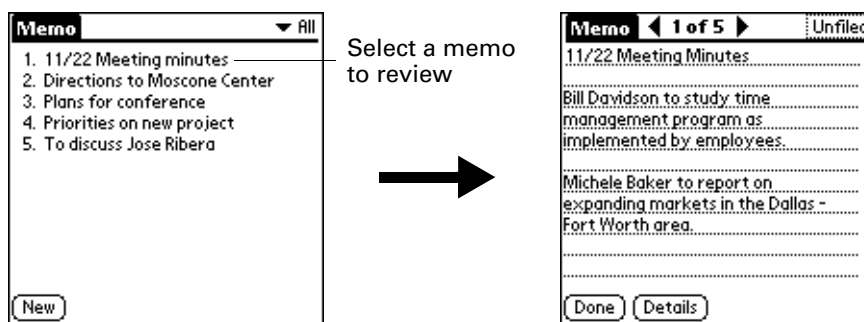

2. Review or edit the text in the memo.
3. Tap Done.

Using Memo Pad menus

Memo Pad menus are shown here for your reference, and Memo Pad features that are not explained elsewhere in this book are described here.

See “Using menus” in [Chapter 4](#) for information about selecting menu commands.

The Record and Options menus differ depending on whether you’re displaying the Memo list or an individual memo.

Record menus

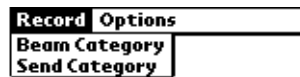

Memo list

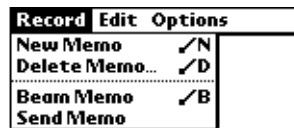

Memo screen

Send Category Opens a dialog box where you can choose how you want to send all records in the selected category to another device. The options available depend on the software installed on your handheld.

Send Memo Opens a dialog box where you can choose how you want to send the selected memo to another device. The options available depend on the software installed on your handheld.

Options menus



Memo list



Memo screen

Preferences Displays the Memo Preferences dialog box, where you define the sort order for memos.

About Memo Pad Shows version information for Memo Pad.

Using Note Pad



Note Pad provides a place to take notes in your own handwriting. You can use Note Pad to do everything you might do with a piece of paper and a pencil. Use Note Pad to do the following:

- Take notes, draw a sketch, or write any kind of message directly on your handheld screen. Later, you can enter this information into other applications.
- Set an alarm to use your notes as reminder messages.
- Assign notes to categories so that you can organize and view them in logical groups.
- Exchange notes with other devices that have Note Pad 2.x installed and that use SMS or Bluetooth™ technology.
- Use Palm™ Desktop software and HotSync® technology to copy and paste notes into popular computer applications like Microsoft Word, or to send notes as e-mail attachments.

To open Note Pad:

- Press the Note Pad application button on the front panel of your handheld. Note Pad opens to display the list of all your records.

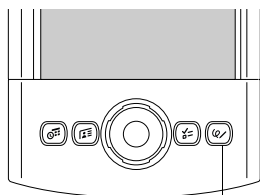

Note Pad button

TIP Press the Note Pad application button repeatedly to cycle through the categories in which you have records.

Creating a note

A record in Note Pad is called a *note*. You can assign notes to categories and mark them private as described in [Chapter 4](#). This section covers how to create a note.

To create a new note:

1. Tap New.

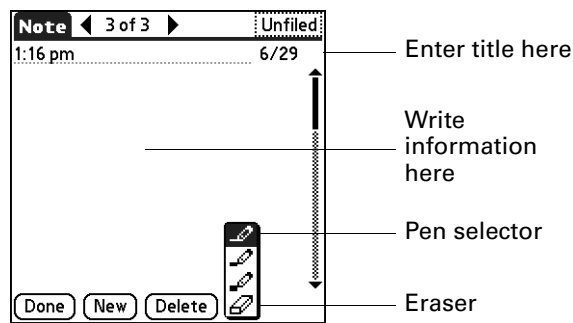

2. Write the information directly on the handheld screen.

Tap the pen selector to select a different pen width, or select the eraser to remove unwanted strokes.

3. (Optional) Select the time at the top of the screen, and then enter a title using Graffiti® 2 writing.
4. Tap Done.

To clear the screen:

1. Tap the Menu icon .
2. Select Edit, and then select Clear Note.

Reviewing notes

The note title and the date you created the note appear in the Note Pad list. If you did not assign a title to your note, the time you created the note appears as the note title. This makes it easy to locate and review your notes.

To review a note:

1. In the Note Pad list, select the note title.



TIP You can also select, review, and move between notes with the navigator. See [“Using the navigator”](#) in [Chapter 2](#) for details.

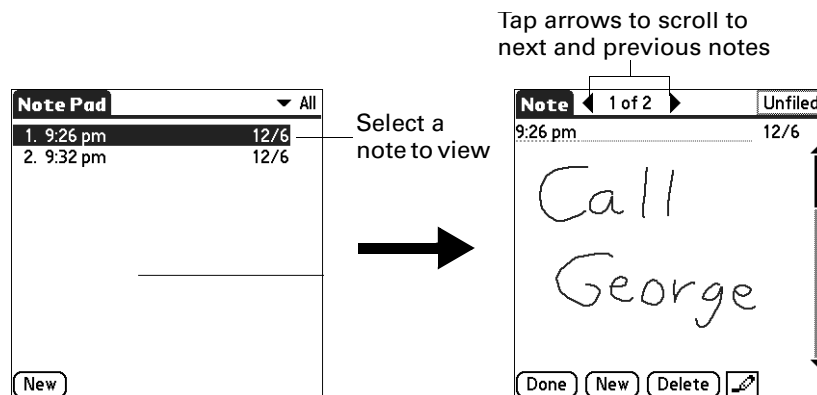

2. Review or edit the contents of the note.
3. Tap Done.

Changing Note Pad color settings

By default, your notes appear with a white “paper” background, and the ink from the pen is blue. You can change the color of both the paper and the ink from the pen. Your color selections apply to all your notes. You cannot change the color settings for individual notes.

To set the colors:

1. In the Note Pad list, tap the Menu icon .
2. Select Options, and then select Preferences.

3. Tap Color.

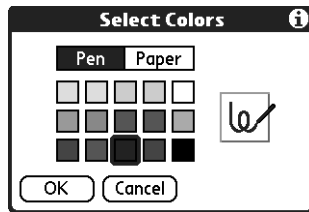

4. Tap Pen, and then tap the color of ink you want to use.
5. Tap Paper, and then tap the color of paper you want to use.
6. Tap OK.

Setting an alarm for a note

You can set an alarm for a specific time and date to remind you to follow up on a note.

To set an alarm for a note:

1. Tap the note to which you want to assign an alarm.
2. Tap the Menu icon .
3. Select Options, and then select Alarm.
4. Tap the Date box.

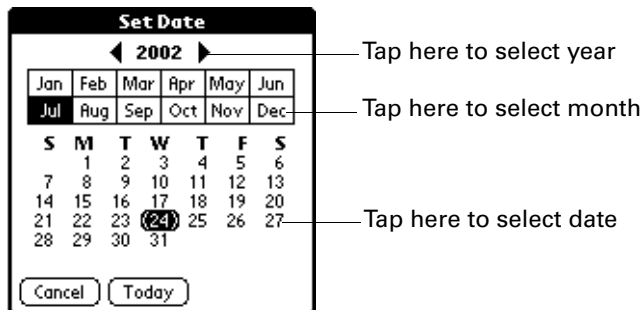

5. Tap the year, month, and date you want the alarm to sound.
After you tap the date, the Set Alarm dialog box reappears.
6. Tap the Time box.

7. Tap the hour and minute columns to select the time you want the alarm to occur.

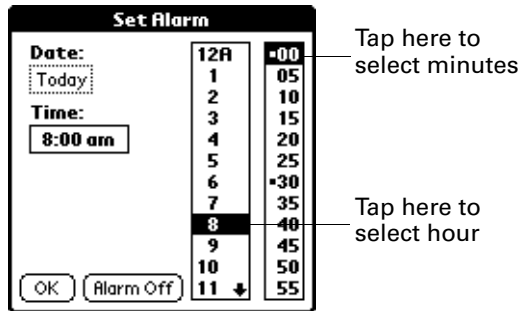

8. Tap OK.
9. When the alarm goes off and the reminder message appears onscreen, do one of the following:
- Tap OK to permanently dismiss the reminder and return to the current screen.
 - Tap Snooze to dismiss the reminder and return to the current screen. An attention indicator blinks in the upper-left corner of the screen to remind you of the pending alarm, and the reminder message appears again in five minutes. When the reminder message reappears, the current time appears in the Reminder bar and the note title appears on the screen.
 - If you did not title the note, the time the note was created appears on the screen.
 - Tap Go To to open Note Pad. Note Pad will open and display the note associated with the alarm.

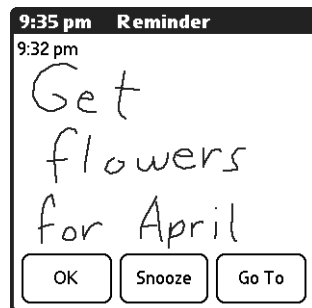

Using Note Pad menus

Note Pad menus are shown here for your reference, and Note Pad features that are not explained elsewhere in this book are described here.

See “Using menus” in Chapter 4 for information about selecting menu commands.

The Record menu is the same when you’re viewing the Note Pad list and an individual note. The Options menu differs depending on whether you’re viewing the Note Pad list or an individual note.

Record menu

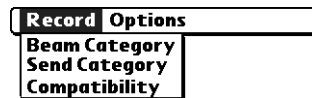

Note Pad list

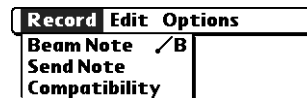

Note screen

- Send Category** Opens a dialog box where you can choose how you want to send all records in the selected category to another device. The options available depend on the software installed on your handheld.
- Send Note** Opens a dialog box where you can choose how you want to send the selected note to another device. The options available depend on the software installed on your handheld.
- Compatibility** Displays the Compatibility dialog box, where you can choose to beam notes to a previous version of Note Pad.

Options menus

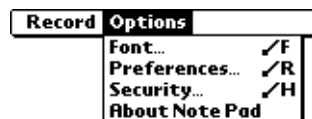

Note Pad list



Note screen

- Preferences** Displays the Note Pad Preferences dialog box, where you define the pen and paper color, the sort order for notes, and the alarm sound.
- Details** Displays the Note Details dialog box, where you assign a category and privacy option for a note.
- About Note Pad** Shows version information for Note Pad.



Using Palm™ Photos

 Palm™ Photos enables you to view and manage photos on your handheld or on an expansion card. Use Palm Photos to do the following:

- Locate photos quickly with the Thumbnail and List views.
- Organize photos into albums.
- Play a slide show of your photos.
- Sort photos by name or date.
- View details for each photo.
- Keep track of your thoughts about a photo by entering notes.
- Exchange photos with other devices that use infrared or e-mail communication.
- Use Palm™ Desktop software and HotSync® technology to transfer photos to your handheld, to copy and paste photos into popular computer applications, and to send photos as e-mail attachments or to other applications.

To open Palm Photos:

Palm Photos is available after the first time you HotSync your handheld.

1. Tap the Home icon .
2. Select the Palm Photos icon .

Palm Photos opens to display the most recently viewed screen.

Viewing photos

A record in Palm Photos is called a *photo*. Photos can be a file that you transfer from your computer, store on an expansion card, or receive from another device.

This section covers how to view, manage, and exchange photos that are stored on your handheld or on an expansion card that is seated in the expansion slot. For information on transferring photos from your computer, see [“Installing files and add-on applications”](#) in [Chapter 4](#) and the online Help in Palm Desktop software.

You can use Palm Photos to view the following types of photos:

- JPG files
- BMP files

Viewing photos in Thumbnail view

Thumbnail view displays miniature versions of your photos so that you can see several photos on the screen at the same time. Use this view to browse through photos or to locate a photo when you don't know the name of the photo.

To view photos in Thumbnail view:

1. Tap the Thumbnail icon .

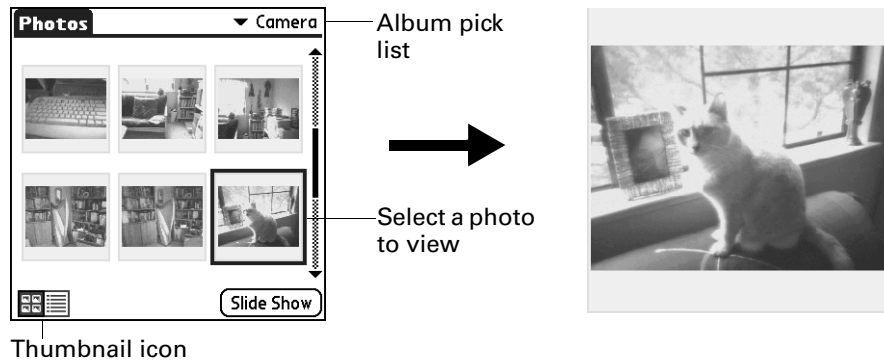

2. Tap the Album pick list in the upper-right corner and select the album you want to view.
3. Tap the thumbnail of the photo you want to view.



TIP You can also select a photo with the navigator. Press Select on the navigator to insert the highlight, press Up, Down, Right, or Left to highlight a specific photo, and then press Select to view the photo.

4. Tap anywhere on the screen to return to Thumbnail view.

Viewing photos in List view

List view displays a list of your photos so that you can see the names and dates associated with your photos. Use this view to locate a photo when you know the name or the date the photo was created.

To view photos in List view:

1. Tap the List icon .
2. Tap the Album pick list in the upper-right corner and select the album you want to view.

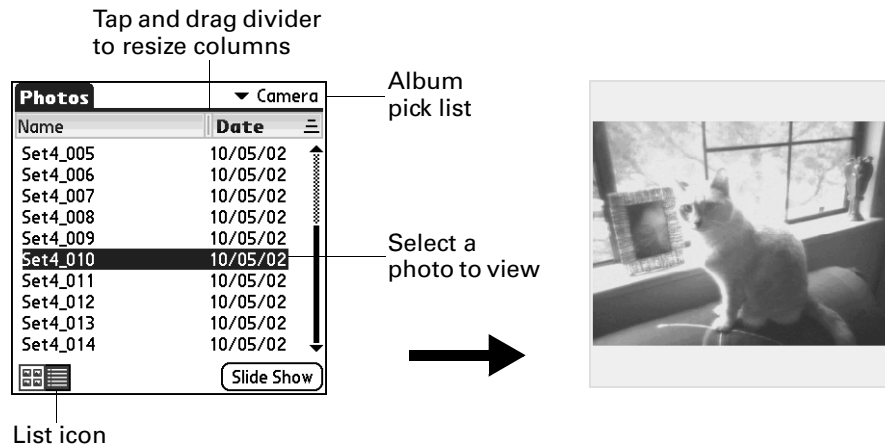

3. Tap the name of the photo you want to view.



TIP You can also browse and select a photo with the navigator. See [“Using the navigator”](#) in [Chapter 2](#) for details.

4. Tap anywhere on the screen to return to List view.

Viewing a slide show

A slide show is a sequential presentation of each of the photos in the current album. You can set the length of time each photo remains on the screen in the Preferences dialog box.

To view a slide show:

1. Tap the Album pick list in the upper-right corner and select the album you want to view.
2. Tap Slide Show.

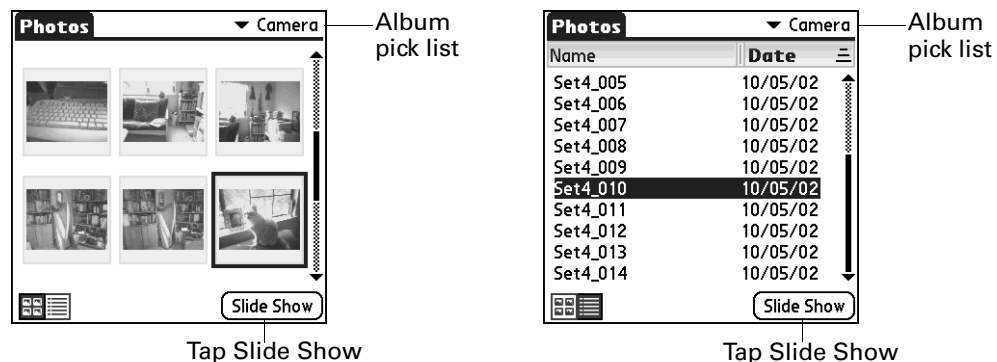

To adjust the delay between photos during a slide show:

1. Tap the Menu icon .
2. Select Options, and then select Preferences.



3. Tap the pick list and select the delay interval: 1 second, 2 seconds, 3 seconds, 5 seconds, or 1 minute.
4. Tap OK.

Rotating photos

If a photo appears in the wrong orientation, you can rotate the photo.

To rotate a photo:

1. Tap the Menu icon .
2. Select Photo, and then select Rotate.

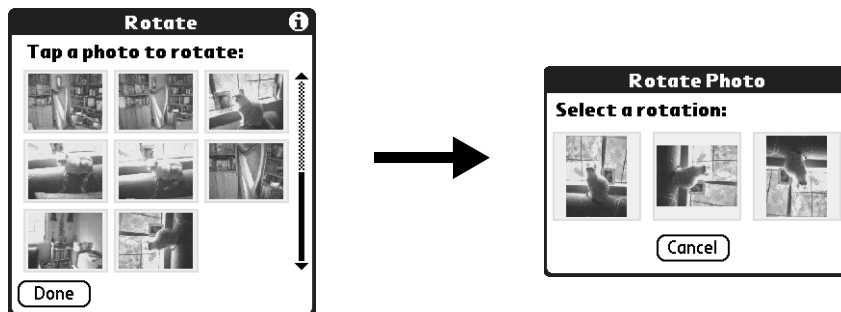

3. Tap the photo you want to rotate.



TIP You can also select a photo with the navigator. Press Select on the navigator to insert the highlight, press Up, Down, Right, or Left to highlight a specific photo, and then press Select to view the photo.

4. Select the new orientation.
5. Tap Done.

Viewing photo information

The Photo Details dialog box enables you to view information about a photo and to change the photo name, assign it to an album, add a note about the photo, and delete a photo.

To review photo information:

1. Tap the Menu icon .
2. Select Photo, and then select Details.

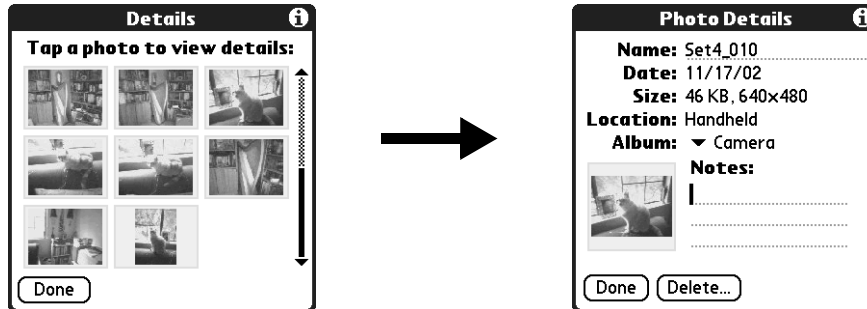

3. Tap the photo for which you want to view information.



TIP You can also select a photo with the navigator. Press Select on the navigator to insert the highlight, press Up, Down, Right, or Left to highlight a specific photo, and then press Select to view the photo.

4. Review or edit the information.
5. Tap Done twice.

Organizing photos

There are several ways you can organize your photos. You can sort photos in the List view, file photos in albums, and copy photos to an expansion card.

Sorting photos in List view

In List view you can sort photos in ascending or descending order by name or date.

To sort photos in List view:

1. Tap a column heading to sort the photos based on that item.

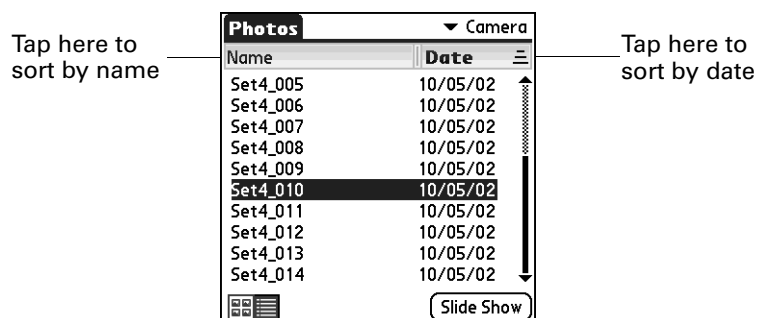

2. Tap the column heading to sort the photos in reverse order.

Creating an album

The process for creating a new photo album is identical to creating a new category in your other handheld applications.

To create an album:

1. Tap the Album pick list in the upper-right corner.
2. Select Edit Albums.

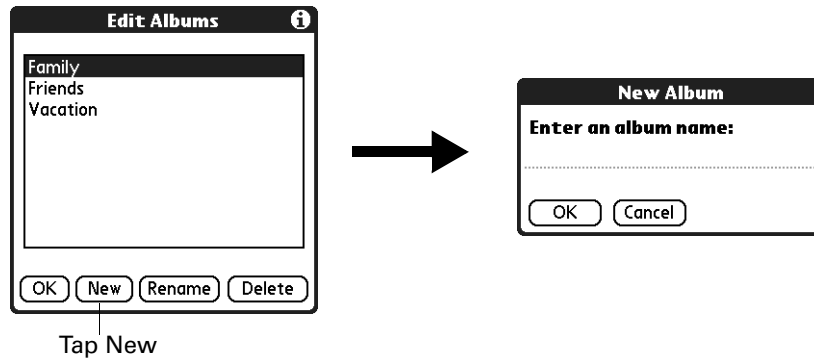

3. Tap New.
4. Enter a title for the album.
5. Tap OK.
6. Tap Done.

Filing photos in albums

You can organize the photos on your handheld by filing them into different albums. Since each expansion card is viewed as its own album, you cannot file photos stored on an expansion card in albums.

To file photos in albums:

1. Tap the Album pick list in the upper-right corner and select the album to which you want to add photos.

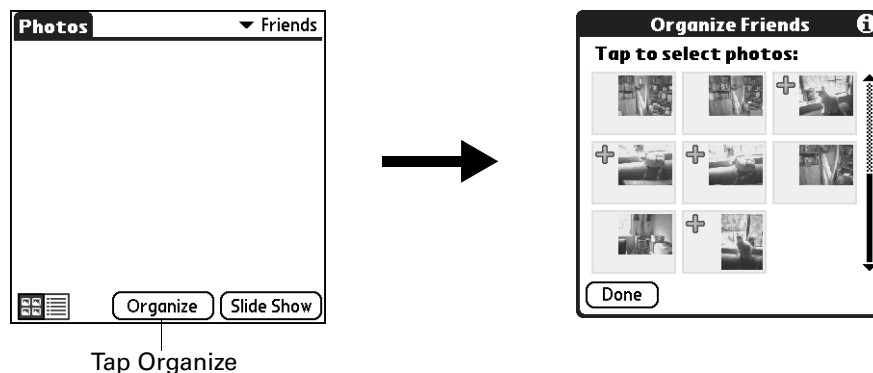

2. Tap Organize.
Plus signs appear next to the photos that are part of the selected album.
3. Tap any photos you want to add to the current album.
A plus sign appears next to each photo you select.
4. Tap any photos you want to remove from the current album.
The plus signs next to the selected photos disappear.
5. Tap Done.

Copying photos

The Copy command enables you to make a copy of a photo on your handheld or on an expansion card. If the photo is currently located on your handheld, it is copied to an expansion card, and vice versa.

When you copy a photo from an expansion card to your handheld, a number is appended to the photo name. If a photo was originally larger than 320 x 320 pixels, then the photo is scaled to a maximum of 320 x 320 pixels and the aspect ratio is maintained.

To copy photos:

1. Tap the Menu icon .
2. Select Photo, and then select Copy.
3. Tap the photo(s) you want to copy.
A plus sign appears next to the photo(s) you select.



TIP You can also select a photo with the navigator. Press Select on the navigator to insert the highlight, press Up, Down, Right, or Left to highlight a specific photo, and then press Select to view the photo.

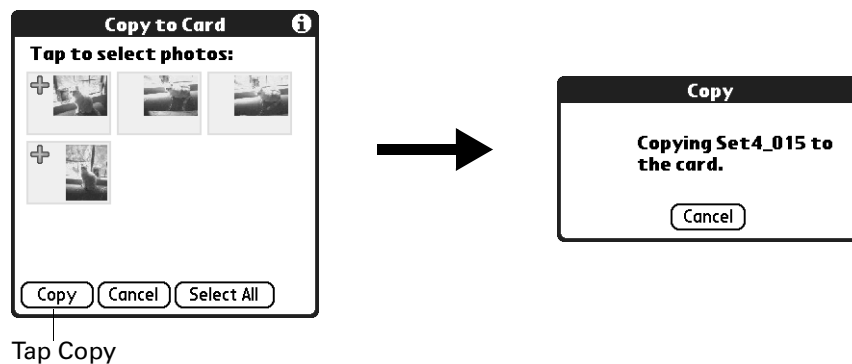

4. Tap Copy.

Renaming or deleting an album

You can rename or delete any of the albums that you create. You cannot rename or delete the Unfiled album. For information about renaming an expansion card, see “Renaming a card” in Chapter 7.

When you delete an album, all the photos in that album are reassigned to the Unfiled album.

To rename an album:

1. Tap the Album pick list in the upper-right corner.
2. Select Edit Albums.

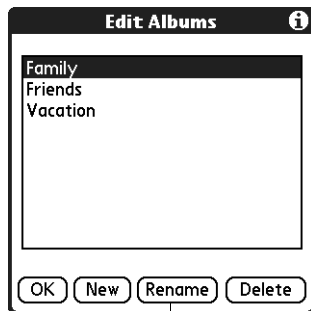

Tap Rename

3. Select the album you want to rename.
4. Tap Rename.
5. Enter the new name.
6. Tap OK.
7. Tap Done.

To delete an album:

1. Tap the Album pick list in the upper-right corner.
2. Select Edit Albums.

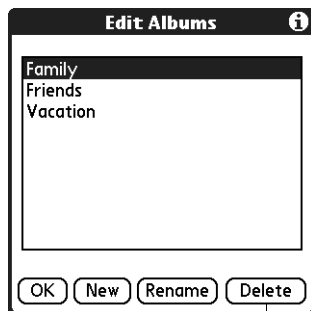

Tap Delete

3. Select the album you want to delete.
4. When the confirmation dialog box appears, tap Delete.
5. Tap Done.

Beaming photos

The Beam command enables you to beam photos to other devices that are enabled with infrared technology. The receiving device must have an application that can display photos. For instructions on beaming a single photo, see “[Beaming data](#)” in [Chapter 3](#). Follow the steps below to beam multiple photos.

To beam photos:

1. Tap the Menu icon .
2. Select Photo, and then select Beam.

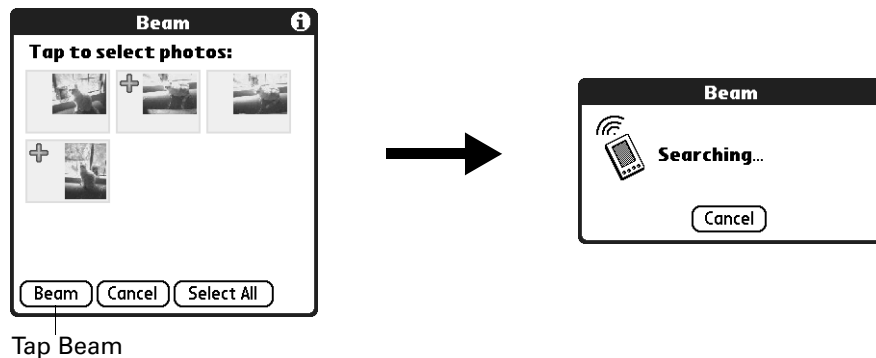

3. Tap the photos you want to beam.
A plus sign appears next to the photos you select.



TIP You can also select a photo with the navigator. Press Select on the navigator to insert the highlight, press Up, Down, Right, or Left to highlight a specific photo, and then press Select to select the photo.

4. Tap Beam.
5. Point the IR port on your handheld at the IR port on the receiving device.
See “[Beaming tips](#)” in [Chapter 3](#) for additional information on beaming data.

Deleting photos

If you no longer want a photo on your handheld or expansion card, you can delete the photo.

To delete photos:

1. Tap the Menu icon .
2. Select Photo, and then select Delete.

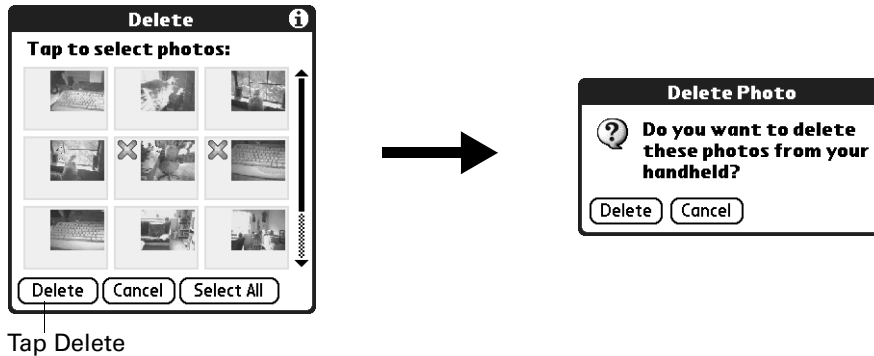

3. Tap the photo(s) you want to delete.
An X sign appears next to the photo(s) you select.



TIP You can also select a photo with the navigator. Press Select on the navigator to insert the highlight, press Up, Down, Right, or Left to highlight a specific photo, and then press Select to view the photo.

4. Tap Delete.
5. When the confirmation dialog box appears, tap Delete.

Working with photos on your computer

After you copy photos onto your handheld and perform a HotSync operation, Palm Desktop software enables you to do any of the following on your Windows computer. See the Palm Desktop software online Help for details.

- View photos in various formats: List, Thumbnails, Details, and Editor with a Handheld preview.
- Drag photos onto the Palm Quick Install icon or the Palm Photos desktop window to install them on your handheld or on an expansion card during the next HotSync operation.
- Modify and delete your photos.

- Organize your photos and add notes.
- Transfer photos to other applications using the Send command or Export command, and import data in popular file formats.

For information on working with photos on your Mac computer, open the Palm folder, open the Documentation folder, and double-click the Photo and Audio Readme file.

Using Palm Photos menus

Palm Photos menus are shown here for your reference, and Palm Photos features that are not explained elsewhere in this book are described here.

See “Using menus” in [Chapter 4](#) for information about selecting menu commands.

The Photo menu varies slightly when you’re viewing the Palm Photos list or thumbnails and an individual photo.

Photo menu

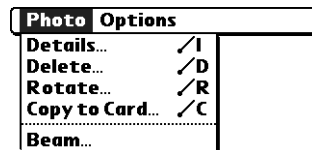

Thumbnail and List view

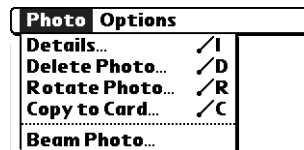

Photo view

Options menus



About Photos Shows version information for Palm Photos.

Using Phone Link



Phone Link helps you configure a connection between your handheld and a compatible mobile phone. You can connect to a compatible mobile phone using any of the following methods:

- **Bluetooth™ technology:** A wireless link that enables you to connect to a Bluetooth mobile phone that is within 10 meters (approximately 30 feet) of your handheld. See [“Bluetooth Preferences”](#) in [Chapter 22](#) for additional information on Bluetooth technology.
- **Infrared communication:** A wireless link that enables you to connect to an infrared-enabled mobile phone within 1 meter (approximately 39 inches) of your handheld. The infrared ports on the two devices must be aligned and the path between the two devices must be clear of obstacles. See [“Beaming data”](#) in [Chapter 3](#) for more information about your handheld’s infrared capabilities.
- **A serial cable connection:** A wire-based link that connects your handheld to a mobile phone with a physical cable.

Serial cables and mobile phones that are enabled with infrared or Bluetooth technology are sold separately.

What can you do with a phone connection?

When your handheld is linked to a mobile phone and your mobile phone carrier supports the required services, you can do the following:

- **Access the Internet:** Use a high-speed wireless data service—such as General Packet Radio Service (GPRS)—or data services and an Internet service provider (ISP) dial-up account, to access the Internet and browse the web. See [Chapter 19](#) for more information.
- **Check and send e-mail:** Use a high-speed wireless data service, or data services and a dial-up connection to access your POP3 or IMAP e-mail account. See [Chapter 17](#) for more information.
- **Dial telephone numbers from your Address Book:** Use the Quick Connect and Tap-to-Connect features with a GSM mobile phone to dial directly from your Address Book. See [“Making connections from Address Book”](#) in [Chapter 5](#) for details.

- **Exchange SMS messages:** Use a Global System for Mobile Communications (GSM) phone carrier service to send and receive short text messages. See [Chapter 15](#) for more information.
- **Use Palm™ Dialer to dial numbers on your phone:** Send telephone numbers from your handheld to your GSM mobile phone. See [Chapter 9](#) for more information.
- **Perform wireless HotSync® operations:** Use your mobile phone as a modem, and synchronize data with your computer from anywhere within your mobile phone service area. To use this feature, your mobile phone service must include data services. See “[Conducting modem HotSync operations](#)” in [Chapter 21](#) for additional information.



A GSM mobile phone, GSM network service, data service, high-speed wireless data service, and an ISP account with a dial-up connection are not included with your handheld.

Setting up a phone connection

To set up a phone connection, you must configure connection information on your handheld. If you want to connect to the Internet and send and receive e-mail, you must also configure the network service settings. The Phone Link and Phone Link Updater applications guide you through this process. For information on how to enter or modify these settings manually, see “[Setting Communication Preferences](#)” in [Chapter 22](#) and see “[Network Preferences](#)” in [Chapter 22](#).

The instructions in this section assume that you already installed the desktop software that came with your handheld and performed at least one HotSync operation.

To configure a phone connection on your handheld:

1. If you are establishing a Bluetooth connection with a phone, you must first turn on Bluetooth communication and turn on the Discoverable setting on your handheld. See “[Bluetooth Preferences](#)” in [Chapter 22](#) for instructions.
2. Tap the Home icon .
3. Select the Phone Link icon .

4. Tap the Phone Connection box.

The Connection Setup screen appears.

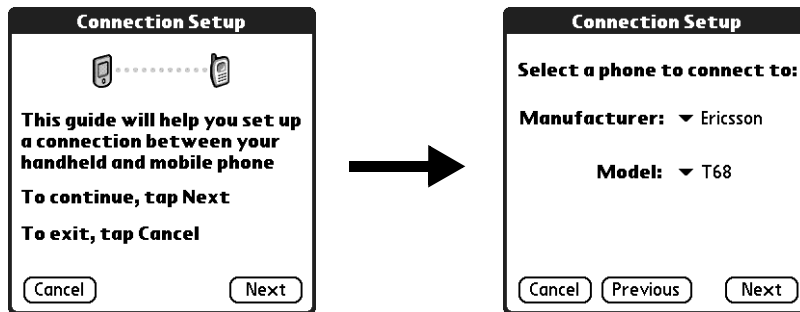

5. Tap the Manufacturer pick list and select your phone's manufacturer.
6. Tap the Model pick list and select your phone model.

If your phone model does not appear on the list, you either need to download and install a driver for your phone (see ["Updating the phone files on your handheld"](#) later in this chapter) or your phone is not supported at this time.

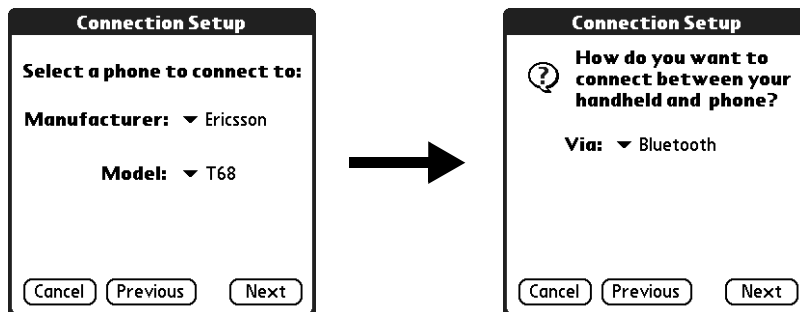

7. Tap Next.
8. Tap the Via pick list and select the method you want to use to connect: Bluetooth, Infrared, or Cable.
The Via pick list options will vary based on the phone model.
9. Tap Next.
10. If you selected Infrared or Cable in step 8, skip to ["Configuring network service settings for your phone"](#) later in this chapter. If you selected Bluetooth in step 8, complete the steps in the procedure that follows.

To configure Bluetooth settings for your phone connection:

1. Place your phone into the mode where it can accept Bluetooth pairing from another device. See the documentation that came with your phone for details.
2. Wait for your handheld to discover your phone.

When your handheld discovers a Bluetooth phone, it displays a screen similar to the screen that follows.

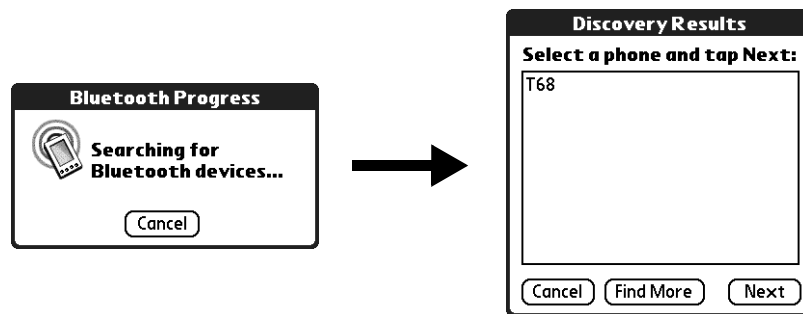

3. Select your phone from the list.

If your phone doesn't appear on the list, tap Find More, and select your phone's name when it appears on the list.

4. Tap Next.

Your handheld connects to your phone.

5. When prompted to create a trusted connection, tap Next.

6. Enter a passkey for this connection on your phone, and then tap OK.

A passkey is a unique identifier that enables secure data exchange between two Bluetooth devices that have formed a connection with one another. The passkey is stored on both devices. You must enter the same passkey on both your handheld and phone. If Phone Link is unable to validate the same passkey on both your handheld and your phone, an error message appears and you are given the option to try connecting again. If you need additional information about connecting your phone, refer to the *Phone Pairing Handbook* at www.palm.com/support/globalsupport.

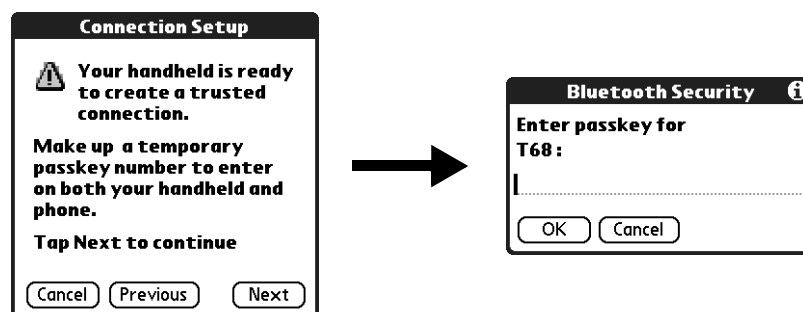

7. When prompted, to create a trusted connection, tap Next.
8. Enter a passkey for this connection on your handheld, and then tap OK.
9. When the Confirmation dialog box appears, tap Yes.

IMPORTANT If you tap No in the Confirmation dialog box, the link between your phone and handheld will not work.

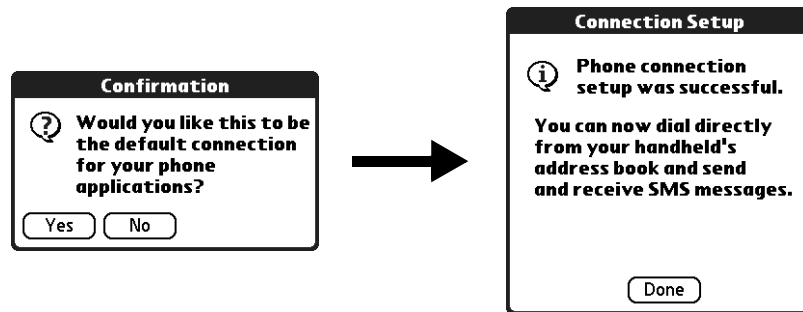

10. Tap Done.
The Network Service dialog box appears.

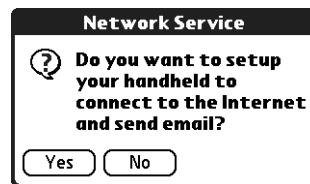

11. Tap Yes, and then follow the instructions in the next section to set up network services for your phone.

Configuring network service settings for your phone

If you want to use your handheld to connect to the Internet, and to send and receive e-mail, you must configure network service settings for your phone. To connect to the Internet, your mobile phone carrier must support data services and you must also have one of the following:

- Access to a GPRS high-speed wireless data service network
- A dial-up account with an ISP
- Dial-up or Bluetooth access to a corporate network with Internet access

To configure a GPRS high-speed wireless data service connection for your phone:

1. After completing step 11 in the preceding procedure, tap Next on the Network Service Setup screen.

If you do not see the Network Service Setup screen, tap the Home icon , select the Phone Link icon , and then tap the Network Service box.

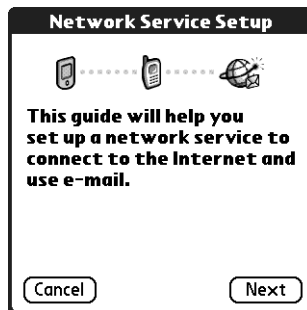

2. Tap Yes when asked if you subscribe to a high-speed data service.

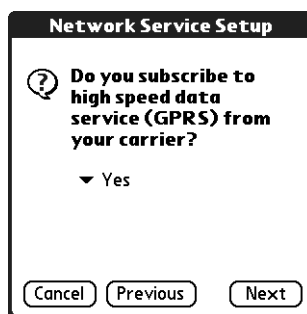

3. Tap Next.
4. Tap the Select the area... pick list and select your mobile phone carrier's location.
5. Tap the Select your carrier pick list and select your mobile phone carrier.



If your mobile phone carrier does not appear on the list, you either need to download and install the settings for your mobile phone carrier (see [“Updating the phone files on your handheld”](#) later in this chapter) or your carrier is not supported at this time.



6. Tap Next.



7. Tap Done.

To configure a dial-up connection:

1. After completing step 11 of the [“To configure Bluetooth settings for your phone connection:”](#) procedure, tap Next on the Network Service Setup screen.

If you do not see the Network Service Setup screen, tap the Home icon , select the Phone Link icon , and then tap the Network Service box.

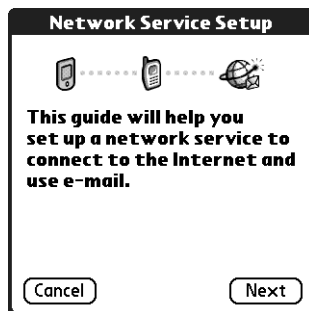

2. Tap No when asked if you subscribe to a high-speed data service.

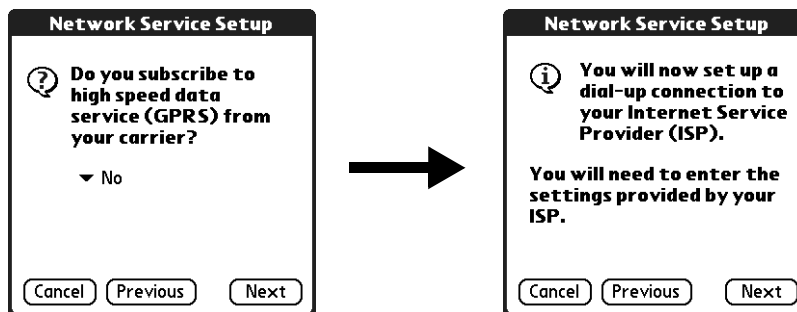

3. Tap Next.

A screen appears to inform you that you are about to set up a dial-up connection for your ISP.

4. Tap Next.

5. Tap the Phone # field and enter the phone number you use to connect to your ISP.



6. Tap the Username field and enter the name you use when you log into your ISP account.
7. Tap the Password box and enter the password for your ISP account.
8. Tap Next.

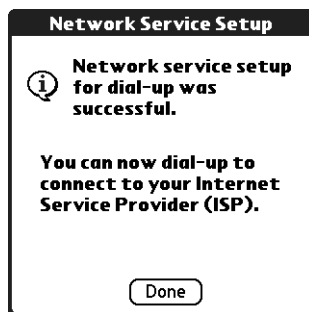

9. Tap Done.

Updating the phone files on your handheld

The Phone Link Updater application on your computer guides you through the process of updating the telephony files on your handheld.

The instructions in this section assume that you have already installed the desktop software that came with your handheld and have performed at least one HotSync operation. You will also need Internet access to download the most recent phone files during the installation.

To install the phone files from your Windows computer:

1. If you are establishing a Bluetooth connection with a phone, you must first turn on Bluetooth communication and turn on the Discoverable setting on your handheld. See [“Bluetooth Preferences”](#) in [Chapter 22](#) for instructions.
2. From the Windows Start menu, select Programs, select Palm Desktop, and then click Phone Link Updater.

3. Follow the instructions on the screen and click Next and Back to navigate between the screens as you do the following:
 - a. Download phone driver updates from the Internet.
 - b. Select your phone's manufacturer and model.

If your phone is not listed, you cannot create a connection to your phone at this time; try running Phone Link Updater again at a later date to see if a new driver is available.
 - c. Select the region where you are located.
 - d. Select your mobile phone carrier service.
 - e. Select your handheld's user name.
4. When prompted, perform a HotSync operation.

After the HotSync operation is complete, the phone files are now installed on your handheld.
5. Click Finish.

If you need additional information about connecting your phone, refer to the *Phone Pairing* at www.palm.com/support/globalsupport.

To install the phone files from your Mac computer:

1. If you are establishing a Bluetooth connection with a phone, you must first turn on Bluetooth communication and turn on the Discoverable setting on your handheld. See "Bluetooth Preferences" in Chapter 22 for instructions.
2. Download the correct driver for your phone from www.palm.com/support/globalsupport.
3. Install the phone driver as you would install any other add-on application. See "Installing files and add-on applications" in Chapter 4 for details.
4. Perform a HotSync operation.

If you need additional information about connecting your phone, refer to the *Phone Pairing* at www.palm.com/support/globalsupport.

Using phone connections

After you install the phone files and configure a link between your handheld and your phone, you are ready to make connections. Depending on the type of link you configured (infrared, cable, or Bluetooth), refer to the appropriate set of instructions below.

By default, your handheld disconnects automatically when the connection is inactive for 1 minute.

If you used the Network Preferences screen to set up multiple network service profiles, you can choose a different service when you establish a connection.

See “[Network Preferences](#)” in [Chapter 22](#) for information on setting up multiple network service profiles.

To make an infrared connection:

1. Turn on your handheld and your mobile phone.
2. Activate the infrared port on your phone.
3. Align the infrared port on your handheld with the infrared port on your phone.
4. Launch the application that requires the phone connection.

For example, to access the Internet, launch a web browser application.

To make a cable connection:

1. Connect the cable to your handheld and mobile phone.
2. Turn on your handheld and your mobile phone.
3. Launch the application that requires the phone connection.

For example, to access the Internet, launch a web browser application.

To make a Bluetooth connection:

1. Turn on your handheld and your mobile phone.
2. Activate Bluetooth on your handheld and phone.
3. Make sure your phone is within 10 meters (approximately 30 feet) of your handheld.
4. Launch the application that requires the phone connection.

For example, to access the Internet, launch Palm™ Web Browser Pro.

Using SMS



SMS enables you to send and receive short text messages using your handheld and a Global System for Mobile Communications (GSM) phone. SMS allows you to do the following:

- Create SMS messages using Graffiti® 2 characters or the onscreen keyboard on your handheld rather than your mobile phone keypad.
- Send and receive SMS messages.
- Receive records associated with other applications, such as Date Book events, Memo Pad memos, and so forth. You can add such records to the associated application or view the information as a text message.

IMPORTANT Your mobile phone plan must be a GSM phone and must include the ability to send and receive SMS messages in order to use SMS.

To open SMS:

1. Tap the Home icon .
2. Tap the pick list in the upper-right corner of the screen.
3. Tap Main.
4. Tap the SMS icon .

Configuring phone preferences and connecting to your mobile phone

You need to configure the phone preferences of your handheld and connect your handheld to your mobile phone before you use SMS. Whenever you send or receive messages in SMS, your handheld must be connected to your mobile phone.

For more information on configuring your phone preferences, see [Chapter 22](#). For more information on connecting your handheld to your mobile phone, see “[Setting up a phone connection](#)” in [Chapter 14](#).

Using the navigator in SMS

You can use the navigator on your handheld to work in SMS.

To navigate in SMS list screens:



- Press Up or Down on the navigator to scroll an entire screen of messages.
- Press and hold Up or Down to scroll quickly.
- Press Select to insert a highlight.
- When a message is highlighted, the navigator works as follows:
 - Press Select again to view the selected message.
 - Press Up or Down to scroll to the previous or next message.
 - Press Left to remove the selection highlight.

To navigate in message screens:

- Press Up or Down to scroll within the current message.
- Press Right or Left to scroll to the previous or next message.
- Press Select to return to the list screen.

Creating messages

When you create a message, the title bar indicates the number of characters the message contains.

NOTE Try to keep your messages shorter than 160 characters. If a message exceeds 160 characters, it is split into multiple messages. When the recipient receives the message, it is reassembled into a single message (provided the recipient's SMS software supports assembling multi-part messages).

To create a message:

1. From any SMS list view, tap New.
2. Tap To.

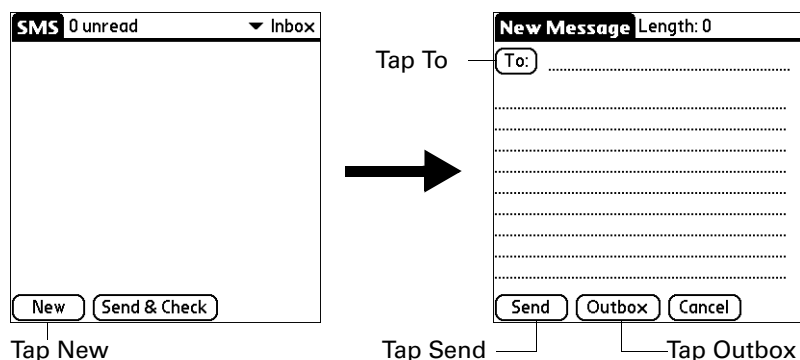

3. Tap the recipient's name, and then tap Add.

TIP To send a message to someone who isn't in your Address Book, enter their mobile phone number on the To line.

4. Enter the message text.
5. Connect to your phone. See ["Setting up a phone connection"](#) in [Chapter 14](#).
6. Tap Send to send the message now, or tap Outbox to send the message later.

NOTE Tapping Send does not send any of the other messages in your Outbox. It sends only the current message.

Sending and receiving messages

You can send all the messages in your Outbox and retrieve all the new messages from your mobile phone at the same time.

To send and receive messages at the same time:

1. Connect to your phone. See ["Setting up a phone connection"](#) in [Chapter 14](#).
2. From any SMS list view, tap Send & Check.

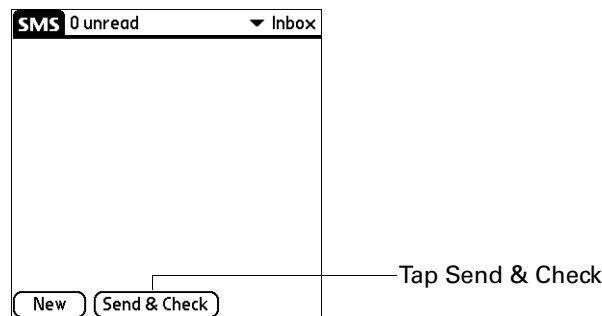

When the transmission finishes, a message appears indicating the number of new messages you received.

To send all messages in your Outbox:

1. Connect to your phone. See ["Setting up a phone connection"](#) in [Chapter 14](#).
2. From any SMS list view, tap the Menu icon .
3. Tap Send from the Message menu.

To download all messages from your phone:

1. Connect to your phone. See ["Setting up a phone connection"](#) in [Chapter 14](#).
2. From any SMS list view, tap the Menu icon .
3. Tap Check from the Message menu.

Viewing messages

SMS stores your messages in five different categories:

Inbox	Stores messages downloaded from your phone.
Outbox	Stores messages waiting to be sent.
Trash	Stores messages you deleted. You can restore deleted messages to their original category.
Archive	Files messages you want to keep.
Draft	Stores messages you want to change or review before you send them.

In the Inbox and Outbox, icons appear next to the message to indicate whether it has been read or sent. In the Inbox, additional icons indicate whether the message is incomplete and whether it contains data other than text that requires another application to read it.

To view text messages in your Inbox:

1. Tap the category pick list in the upper-right corner.
2. Tap Inbox.

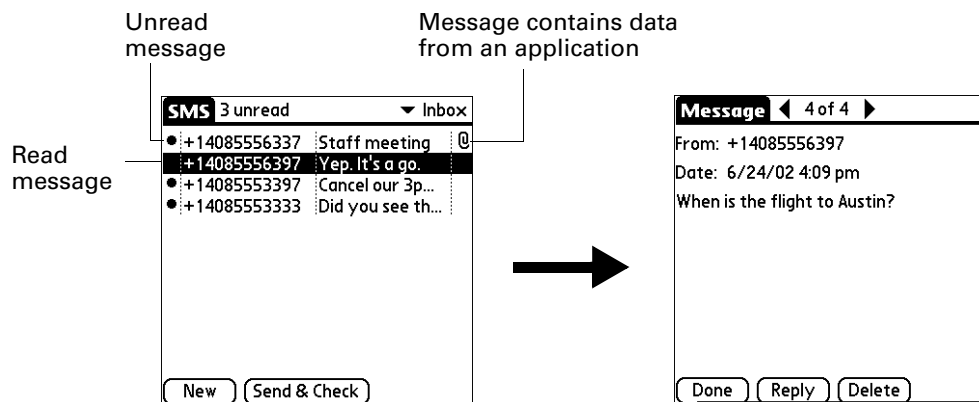

3. Tap the message you want to view.
4. Tap one of the following:

Done	Returns to the list view.
Reply	Creates a message to the sender and copies any selected text into the new message.
Delete	Moves the message to the Trash category.

To view data messages in your Inbox:

1. Tap the category pick list in the upper-right corner.
2. Tap Inbox.

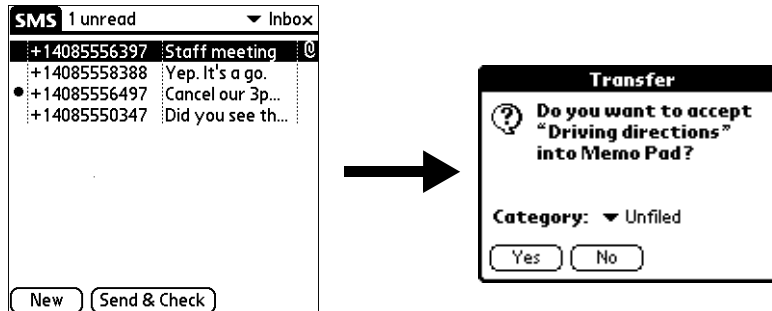

3. Tap the message you want to view.
4. Tap Yes to add the data to the appropriate application, or tap No to view the raw data.

To view messages in your Outbox or Archive categories:

1. Tap the category pick list in the upper-right corner.
2. Tap Outbox or tap Archive.

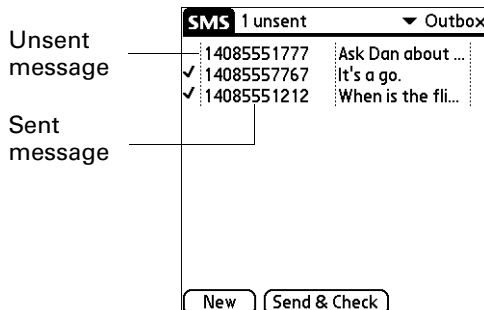

3. Tap the message you want to view.
4. Tap one of the following:

- Done** Returns to the list view.
- Edit** Opens the message so you can modify the contents.
- Delete** Moves the message to the Trash category.

To view messages in your Trash:

1. Tap the category pick list in the upper-right corner.
2. Tap Trash.
3. Tap the message you want to view.

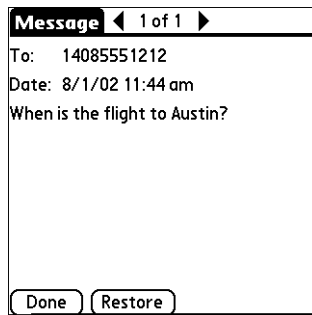

4. Tap one of the following:

Done	Returns to the list view without moving or changing the message.
Restore	Moves the message back to the category it was in before you deleted it.

Working with draft messages

When you create a message, you can save it as a draft message. SMS does not send draft messages when you transmit the messages in your Outbox. You can store draft messages for as long as you like and review and edit them before you send them.

To place a message in the Draft category:

1. Create or open the message you want to store in the Draft category.
2. From the Message view, tap the Menu icon .
3. Tap Draft from the Message menu.

To view or edit draft messages:

1. Tap the category pick list in the upper-right corner.
2. Tap Draft.
3. Tap the message you want to edit.

- In the message view, tap Edit.

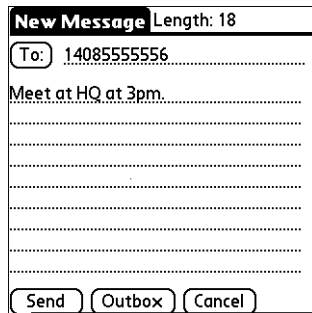

- Edit the message.
- Tap one of the following:

Send	Sends the message now.
Outbox	Moves the message to the Outbox to be sent later.
Cancel	Opens a dialog box that asks if you want to save the message in the Draft category. Tap Yes to keep your changes and return the message to the Draft category. Tap No to discard your changes and return the message to the Draft category.

Adding a signature to a message

A signature is text that appears at the end of a message. You can define your own personal signature and then add it to a message using menu commands.

To define a signature:

- Tap the Menu icon .
- Tap Options, and then tap Preferences.

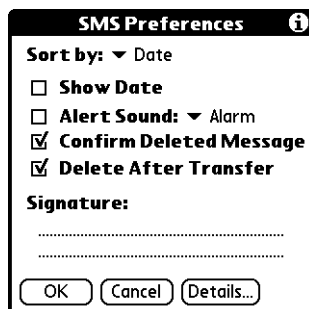

3. Enter your signature.

NOTE Try to keep your signature brief. If a message, including your signature, exceeds 160 characters, it is split into multiple messages. When the recipient receives the message, it is reassembled into a single message (provided the recipient's SMS software supports assembling multi-part messages).

4. Tap OK.

To add your signature to a message:

1. Create or edit the message where you want to add your signature.
2. From the New or Edit Message view, tap the Menu icon .
3. Tap Options, and then tap Add signature.

Sending data from another application

In addition to creating text messages, you can create a message that contains data from an application on your handheld. For example, you can send a Date Book event to someone to remind them to add a meeting to their calendar. If the recipient receives the message on a Palm OS® handheld, they can transfer the message directly to the appropriate application. If the recipient receives the message on another device, the data will appear as text.

NOTE Not all applications include a send command.

To send data from another application:

1. Open the record you want to send.
2. Tap the Menu icon .
3. Tap Send from the Record menu. (The name of the menu may be different depending on which application you're sending data from. For example, tap Send from the Note menu in Note Pad.)
4. If necessary, tap SMS to send the data using SMS rather than Bluetooth™ technology, and then tap OK.

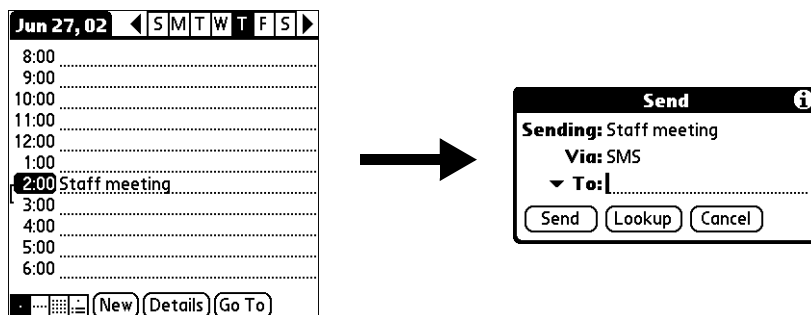

5. Tap To to select from a list of recent recipients or tap Lookup to select a number from your Address Book.
6. Tap Send.

Setting SMS Preferences

The SMS Preferences screen enables you to customize several of the settings in the SMS application.

To view or change SMS Preferences:

1. Tap the Menu icon .
2. Tap Options, and then tap Preferences.

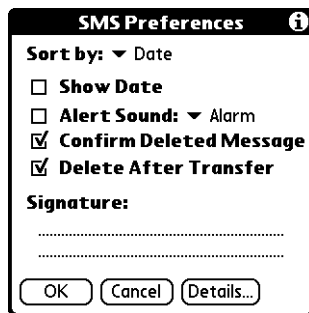

3. Change any of the following options:

Sort by Tap the pick list to sort messages in one of the following orders: Alphabetic, Date, Phone Number, and Status.

Show Date To display dates in list views, select this check box.

Alert Sound Indicates whether new messages trigger an alert and which alert it triggers. To trigger a new message alert, select this check box. Tap the pick list to select one of the following sounds: Alarm, Alert, Bird, Concerto, Phone, Sci-fi, and Wake up.

NOTE When a new message triggers an alert sound, tap anywhere on your handheld screen to stop the sound.

Confirm Deleted Message Indicates whether a confirmation message appears each time you delete a message or you select the Empty Trash option from the Message menu. To display confirmation messages, select this check box.

Delete After Transfer Indicates whether data messages are deleted after you accept the data in the appropriate application. To keep data messages after you transfer them to the application, deselect this check box.

Signature Enables you to enter a personal signature that you can add to your messages.

4. Tap Details.

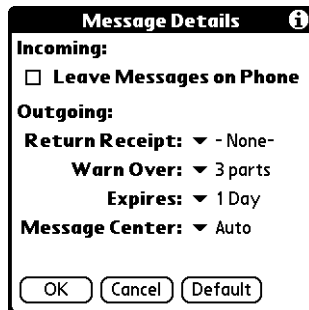

5. Change any of the following options:

NOTE Outgoing SMS message settings may depend on the service offered by your SMS carrier.

Leave Messages on Phone Indicates whether messages are deleted from your phone after you download them to your handheld. To keep messages on your phone after you transfer them to your handheld, select this check box.

Return Receipt Determines whether you receive receipt confirmation notices. Tap the pick list to select from the following options: None and Requested.

Warn Over Determines whether you receive a warning when multi-part messages exceed more than the specified number of parts. Tap the pick list to select from the following options: 1 part, 3 parts, 5 parts, 10 parts, 50 parts, and Never warn.

Expires	Indicates how long unsent messages remain in your Outbox. Tap the pick list to select from the following options: 4 Hours, 1 Day, 1 Week, 2 Weeks, 1 Month, and Max. Time.
Message Center	Indicates whether your handheld obtains your mobile phone service provider's Message Center number directly from the phone, or whether you need to enter the number manually. If your phone is already configured to use SMS, you do not need to change this setting. Tap the pick list to select from the following options: Auto and Custom.

TIP To restore all of these options to the original settings, tap Default.

6. Tap OK to close the Message Details dialog box.
7. Tap OK.

Using SMS menus

SMS menus are shown here for your reference, and application features that are not explained elsewhere are described here.

See “Using menus” in [Chapter 4](#) for information about selecting menu commands.

Message menu

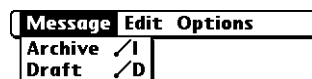

Message view

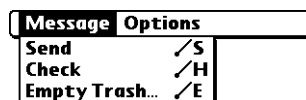

List view

Send	Sends all messages in the Outbox.
Check	Retrieves all messages stored on the phone.
Empty Trash	Permanently removes all messages in the Trash category from your handheld.
Archive	Moves the current message to the Archive category.

Options menu

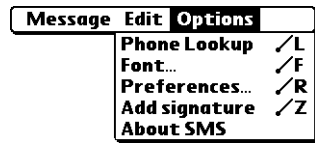

New Message view

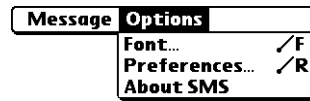

List view

Phone Lookup Opens the Phone Lookup dialog box where you can select a mobile phone number where you want to send a message.

Font Opens the Font dialog box where you can choose different fonts for the list and message views.

About SMS Shows version information for the SMS application.

Using To Do List

 To Do List is a convenient place to create reminders and prioritize the things you need to do. Use To Do List for the following:

- Make a quick and convenient list of things to do.
- Assign a priority level to each task.
- Assign a due date for any or all of your To Do List items.
- Assign To Do List items to categories so that you can organize and view them in logical groups.
- Sort your To Do List items by due date, priority level, or category.
- Attach a note to an individual To Do List item for a description or clarification of the task.

To open To Do List:

- Press the To Do List application button on the front panel of your handheld. To Do List opens to display the list of all your records.

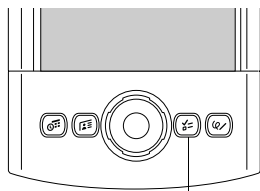

To Do List button

TIP Press the To Do List application button repeatedly to cycle through the categories in which you have records.

Creating list items

A To Do List item is a reminder of a task that you must complete. A record in To Do List is called an *item*.

To create a To Do List item:

1. Tap New.

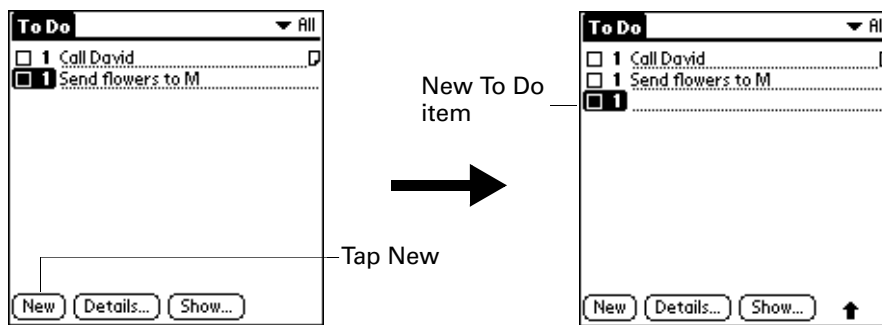

2. Enter the text of the To Do List item. The text can be longer than one line.
3. Tap anywhere onscreen to deselect the To Do List item.

TIP If no To Do List item is currently selected, writing in the Graffiti® 2 writing area automatically creates a new item.

Setting priority

You can use the priority setting for items to arrange the tasks in your To Do List according to their importance or urgency. The default setting for the To Do List is to arrange items by priority and due date, with priority 1 items at the top. If you have a number of items in your list, changing an item's priority setting may move its position in the list.

When you create a new To Do List item, its priority is automatically set to level 1, the highest (most important) level. If you select another item first, however, the item you create appears beneath the selected item and is given the same priority as the selected item.

To set the priority of a To Do List item:

1. Tap the Priority number on the left side of the To Do List item.

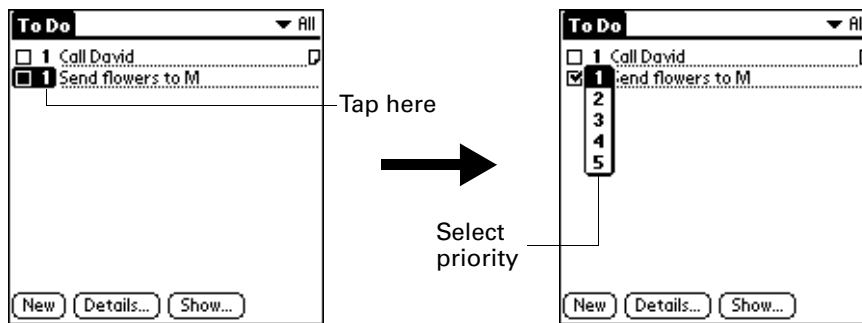

2. Select the Priority number that you want to set (1 is most important).

Checking off a To Do List item

You can check off a To Do List item to indicate that you've completed it. You can set the To Do List to record the date that you complete the To Do item, and you can show or hide completed items. See ["Setting To Do Preferences"](#) later in this chapter.

To check off a To Do List item:

- Tap the check box on the left side of the item.



TIP You can also highlight the item you want to check off, and then press Select on the navigator.

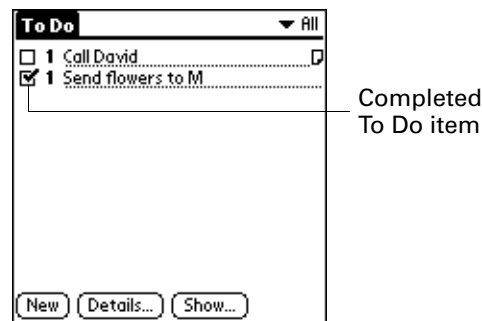

Changing To Do List item details

The To Do Item Details dialog box enables you to change settings for individual items.

To display the To Do Item Details dialog box:

1. Tap the text of the item whose details you want to change.



TIP You can also select an item with the navigator. See [“Using the navigator”](#) in [Chapter 2](#) for details.

2. Tap Details.



Setting a due date

You can associate a due date with any To Do List item. You can also sort the items based on their due dates.

To set a due date for a To Do List item:

1. In the Details dialog box, tap No Date to open the Due Date pick list.

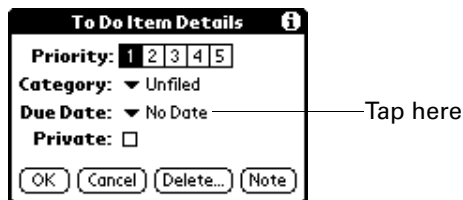

2. Tap the date that you want to assign the item:

Today	Assigns the current date.
Tomorrow	Assigns tomorrow's date.
One week later	Assigns the date exactly one week from the current date.
No Date	Removes the due date from the item.
Choose date	Opens the date selector, where you can choose any date that you want for the item.

3. Tap OK.

TIP If you turn on the Show Due Dates option in the To Do Preferences dialog box, you can tap directly on the due date in the To Do List to open the pick list shown in step 2.

Setting To Do Preferences

The To Do Preferences dialog box enables you to control the appearance of To Do List, and To Do items in Date Book Agenda view.

To change the Preferences settings:

1. In To Do List, tap Show.



2. Select any of the following settings:

Show Completed Items Displays your completed items in the To Do List. If you turn off this setting, your To Do items disappear from the list when you complete (check) them.

Items that no longer appear on the list because you turn off this setting have not been deleted. They are still in the memory of your handheld. You can purge completed items to remove them from memory.

Show Only Due Items Shows only the items that are currently due, past due, or have no due date specified. When this setting is active, items that are not yet due do not appear in the list until their due date.

Record Completion Date Replaces the due date with the actual date when you complete (check) the item. If you do not assign a due date to an item, the completion date still records when you complete the item.

Show Due Dates Displays the due dates associated with items in the To Do List and displays an exclamation mark next to items that remain incomplete after the due date passes.

Show Priorities Shows the priority setting for each item.

Show Categories Shows the category for each item.

3. Tap OK.

Using To Do List menus

To Do List menus are shown here for your reference, and To Do List features that are not explained elsewhere in this book are described here.

See “Using menus” in [Chapter 4](#) for information about selecting menu commands.

Record menu

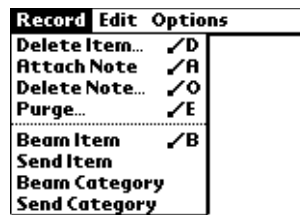

Send Item Opens a dialog box where you can choose how you want to send the selected item to another device. The options available depend on the software installed on your handheld.

Send Category Opens a dialog box where you can choose how you want to send all records in the selected category to another device. The options available depend on the software installed on your handheld.

Options menu



About To Do List Shows version information for To Do List.

Using Palm™ VersaMail™ Personal E-mail Software

With Palm™ VersaMail™ personal e-mail software, you can send, receive, and manage e-mail on your handheld. This chapter describes how to set up different types of e-mail accounts and explains how to use the many e-mail features in the VersaMail application.

The VersaMail application version 2.5 is the newest offering in the line of Palm™ personal e-mail software applications. Formerly known as MultiMail® software, the VersaMail 2.5 application contains new features that make sending and receiving e-mail messages and managing e-mail accounts easier than ever.

Palm™ VersaMail™ personal e-mail software features

Key features of the VersaMail 2.5 application include the following:

- Support for the Palm™ Tungsten™ T2 navigator, simplifying data entry and navigation
- Support for the built-in Bluetooth™ radio in your handheld, enabling wireless e-mail connectivity
- Enhanced use of color, fonts, styles, and user-selected display options
- Basic HTML formatting display for e-mail messages received in HTML format
- Increased number of file types supported for being sent and received as attachments
- Scheduled retrieval of new e-mail, with notification
- Improved message-addressing capabilities
- Enhanced security

Getting started with the VersaMail application

To start using the application, simply tap the VersaMail icon  in the Applications Launcher on your handheld.

If you are using a Windows computer, the Palm VersaMail HotSync® Conduit is installed automatically when you install the Palm Desktop software. See [“Synchronizing e-mail between the handheld and the desktop”](#) later in this chapter for information on using the conduit.

Synchronizing an existing username

If you plan to synchronize your Palm Tungsten T2 handheld with an existing username by performing a HotSync operation, you must do so before you enter your e-mail account information in the VersaMail application. If you enter the e-mail account information first and then synchronize your handheld to an existing username, the e-mail account information you entered is overwritten.

Upgrading a MultiMail/VersaMail database

If you have previously used a Palm personal e-mail application such as MultiMail SE or MultiMail Deluxe, or used version 2.0 of the VersaMail application, you can upgrade your e-mail database for use with the VersaMail 2.5 application.

To upgrade an existing e-mail database for use with the VersaMail application:

1. Perform a HotSync operation with a user profile that contains the existing e-mail database. To do so, press the HotSync button , and then select a profile that contains an e-mail database from the displayed list of users.

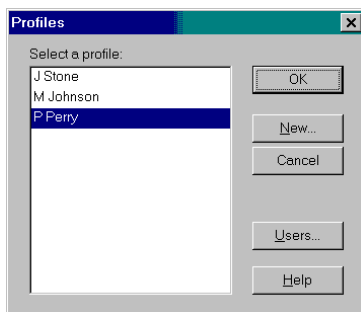

2. Tap the VersaMail icon  in the Applications Launcher on your handheld.
3. Tap Yes to accept the upgrade.

Setting up and managing e-mail accounts

With the VersaMail application, you can access e-mail accounts from providers such as Earthlink or Yahoo. You may also access your corporate e-mail with the appropriate mail server configuration. See [“Using a corporate e-mail account”](#) later in this chapter for more information.

You can add up to eight e-mail accounts on your handheld by setting up a connection to an e-mail service provider or synchronizing to a desktop e-mail application. For example, if you have a Yahoo e-mail account with POP access, you can create a new account in the VersaMail application and name that new account Yahoo, so that you can send and receive e-mail on your handheld using your Yahoo account.

Account and connection types

Two types of e-mail accounts are supported:

- **Network:** You can send and receive e-mail directly to and from your handheld by connecting with an e-mail service provider.
- **Synchronize Only (Windows computers only):** You can download, view, and manage e-mail between the handheld and a desktop e-mail application, such as Microsoft Outlook, by performing a HotSync operation using the cradle/cable. You can't send and receive messages wirelessly or with a modem for an account of this type.

Using a network account, you can set up or access an e-mail account using any of the following connection methods:

- Built-in Bluetooth radio
- PalmModem® accessory (sold separately)
- External modem sled (sold separately)
- Infrared (IR) port on the handheld to infrared port on a mobile phone
- Direct connection to a mobile phone by means of a physical cable
- Handheld cradle connected to your desktop (Windows users only)

Network e-mail account prerequisites

Before you can set up a network e-mail account, you must do the following:

- Establish the e-mail account with an e-mail service provider. Common providers include Internet service providers (ISPs) such as Earthlink and Prodigy. A provider can also be a wireless GSM or GPRS carrier such as VoiceStream, Cingular, or Vodafone. You may also use a corporate e-mail account.
- Configure the service connection settings for this account on your handheld using your handheld's Network Preferences and Connection Preferences screens. See [Chapter 22](#) for more information.

You must also have the appropriate prerequisite for the type of connection you want to make, as follows.

Connection Type	Prerequisite
Built-in Bluetooth radio via a mobile phone	Active wireless service with a GSM or GSM/GPRS carrier, and GSM or GPRS mobile phone enabled with Bluetooth technology. Note that some GSM carriers require you to order a special data service (separate from voice service) in order to make a network connection.
Built-in Bluetooth radio via a LAN access point	Proximity to a LAN access point
PalmModem accessory	PalmModem accessory
External modem sled	Wireless modem accessory
IR to IR phone	IR-enabled mobile phone
Direct connection to a phone by means of a physical cable	Connector cable and mobile phone
Handheld cradle connected to desktop	Handheld cradle and cable (Windows users only)

Using an ISP

If you are setting up a new e-mail account and have a well-known ISP such as Earthlink or Mindspring, many of the required settings during the account setup are automatically configured.

For other ISPs, you need the following information:

- The protocol used for incoming mail, such as POP or IMAP
- The name of the incoming mail server

- The name of the outgoing mail (SMTP) server
- Whether your e-mail account requires any security, such as SSL, APOP, or ESMTP
- Your e-mail address and password
- The login script (if any) that you need for connecting to your ISP or mail server

NOTE Information about your e-mail account is available from the e-mail provider. Depending on the type of e-mail service you have, you may be able to access this information by going to the e-mail provider's web site or by contacting the provider's customer support.

Using a corporate e-mail account

If you want to access e-mail on your handheld using your corporate e-mail account, you create this account on your handheld in exactly the same way as any other account (see "[Network e-mail account prerequisites](#)" later in this chapter), with one exception: for a corporate e-mail account, you may need to set up a virtual private network (VPN). See "[VPNs](#)" later in this chapter for information.

NOTE If your company has a Bluetooth network located behind the corporate firewall, or if you are using an 802.11b SDIO card, sold separately, in your handheld and your company has an 802.11b network located behind the corporate firewall, you may not need to set up a VPN to access your corporate e-mail account. See the following section for details.

The following considerations apply when setting up a corporate e-mail account:

Username and password	These might be your Windows NT or Windows 2000 username and password, your Lotus Notes ID username and password, or something else. Check with your company's server administrator to obtain the correct username and password. The VersaMail 2.5 application provides strong 128-bit AES encryption for your password.
Protocol	Most corporate mail servers use the IMAP protocol for retrieving mail. In rare cases, your company server may use the POP protocol. Check with your company's server administrator to verify the protocol.
Incoming and outgoing mail server settings	Check with your company's server administrator to obtain these settings.

See "[Creating a network e-mail account](#)" later in this chapter for steps for inputting your username, password, protocol, and incoming and outgoing server settings when you set up your corporate e-mail account.

With a corporate e-mail account, you can access the following types of mail servers, among others:

- Microsoft Exchange
- Lotus Domino
- Sun iPlanet

VPNs

If you want to access e-mail on your handheld using your corporate e-mail account, you may need to set up a virtual private network (VPN) on your handheld. A VPN enables you to log in to your corporate mail server through the company's firewall (security layer). Without a VPN, you cannot "break through" the firewall to gain access to the mail server.

You need to set up a VPN to access corporate e-mail in either of the following two situations:

- Your company's wireless LAN network is located outside the firewall.
- Your company's wireless LAN network is located inside the firewall, but you are trying to access the network from outside the firewall (for example, from a public location or at home).

Check with your company's server administrator to see if a VPN is required to access the corporate network.

NOTE You cannot use auto get mail with notification or scheduled sending retry of e-mail with accounts that use a VPN connection. See "[Auto get mail with notification](#)" and "[Send retry](#)" later in this chapter for information.

Creating a network e-mail account

You create a new account in Account Setup, which guides you through the process.

To create a network e-mail account:

1. Tap the Menu icon .
2. Tap Accounts.
3. Select Account Setup.

Message	Options	Accounts
Sam Yahoo		✓1
Sam IMAP		✓2
Sam Sync		✓3
Speakeasy		✓4
Account Setup...		✓W

4. Tap New.

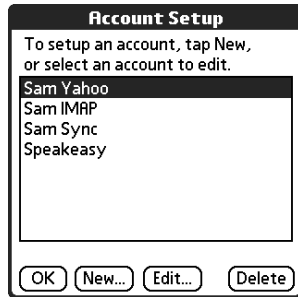

5. Enter the following:

- Account Name** Enter a descriptive name for the account, such as “My Yahoo.”
- Mail Service** Tap the Mail Service pick list and select the provider to which you are connecting. Select Other if your ISP is not listed.
- Protocol** Tap the Protocol pick list and select POP or IMAP. (Most e-mail providers use the POP protocol.)

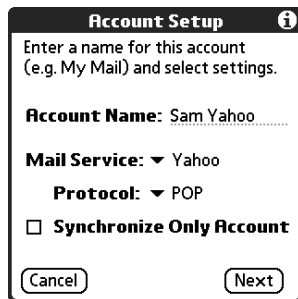

If the VersaMail application knows the protocol for the mail service you selected, it displays the correct protocol.

6. Tap Next.

Entering the account username and password

In the next part of the VersaMail Account Setup, you enter the username and password for this account. The VersaMail 2.5 application provides strong 128-bit AES encryption for your password.

To enter the account username and password:

1. Enter the username you use to access your e-mail. This is generally the part of your e-mail address appearing before the @ symbol; it is usually not your entire e-mail address.

2. Tap the Password box, and then enter your password.
3. Tap OK. The Password box displays the word “Assigned” to indicate that a password has been entered.
4. Tap Next.

Entering the name of the outgoing and incoming mail server

You need to verify your e-mail address for the account you are accessing, as well as enter the names of the outgoing and incoming mail servers.

To enter mail server settings:

1. If you chose a preconfigured service from the Mail Services pick list on the Account Setup screen, the e-mail address field is completed automatically, based on the username and mail service you entered. Check the address to verify that it is correct, and edit it if necessary.

If you chose Other from the Mail Services pick list on the Account Setup screen, enter the e-mail address for your account.

E-mail address will be filled in automatically if you chose a preconfigured mail service

Mail servers will be filled in automatically if the VersaMail application knows the names based on the mail service you chose

2. Enter the name of your incoming (POP) mail server, such as pop.mail.yahoo.com.

If the VersaMail application knows the incoming mail server name based on the mail service you selected, the correct server name is displayed.

3. Enter the name of your outgoing (SMTP) mail server, such as smtp.mail.yahoo.com.

If the VersaMail application knows the outgoing mail server name based on the mail service you selected, the correct server name is displayed.

4. Tap Next.
5. Do one of the following:
 - To accept these mail options and begin using the VersaMail application, tap Done. This takes you to the Inbox of the account you set up. See [“Getting, sending, and managing e-mail”](#) later in this chapter for information on getting and sending e-mail.
 - To set up additional mail options, tap Next. Continue with the next set of procedures.

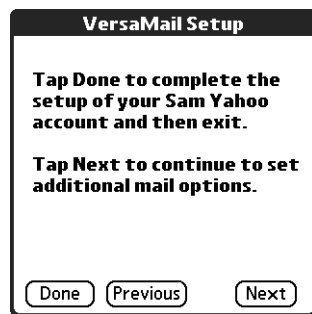

Setting mail retrieval options for a POP or IMAP account

The next VersaMail Setup screen displays different options depending on whether your mail service uses a POP or an IMAP protocol.

To set mail retrieval server options for a POP or IMAP account:

1. (Optional) Select any of the following:

Get unread mail **NOTE** The POP protocol does not support retrieval of unread mail only from the server. If you have a POP e-mail account, the VersaMail application downloads all messages from the server regardless of whether you have read them (for example, on your desktop or on the web), and regardless of whether this check box is selected.

For IMAP accounts, select Get unread mail ONLY to download only unread mail to your handheld. If you don't choose this option and you tap Get & Send, all of your e-mail messages on your provider's mail server are downloaded to your Inbox, including messages you have already read. To get all mail (including mail you have already read) and not just unread mail, deselect Get unread mail ONLY.

- Delete messages on server** To delete messages on your provider’s mail server when they are deleted in the VersaMail application, select the Delete messages on the server when they are deleted in VersaMail check box.
- Leave mail on server (POP account only)** To get e-mail on your handheld but also leave it on the server so you can view it later on your desktop, select the Leave mail on server check box. For example, if you create an account to receive e-mail from your Yahoo account and select this option, your old Yahoo e-mail is still visible the next time you visit Yahoo.com to access your Yahoo e-mail Inbox.
- Port Number** The port number setting defaults to 110 for POP and to 143 for IMAP servers, respectively. You may need to change the port number if you choose to retrieve incoming mail over a secure connection (see the next bullet item). If you are not sure about the correct port number, check with your mail server administrator.
- Use Secure Connection** To retrieve incoming mail over a secure (Secure Sockets Layer, or SSL) connection, select the Use Secure Connection check box. See [“Using Secure Sockets Layer \(SSL\)”](#) later in this chapter for information on SSL.
- Maximum Message Size** To limit the maximum size of an incoming e-mail message, enter the size in kilobytes (KB) for Maximum Message Size. The maximum size of an incoming message is 5KB by default, but you can enter a smaller size. The maximum message size that you can retrieve is 60KB for the body text and 2MB total, including attachments.

POP accounts

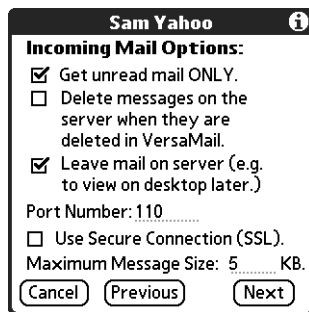

IMAP accounts

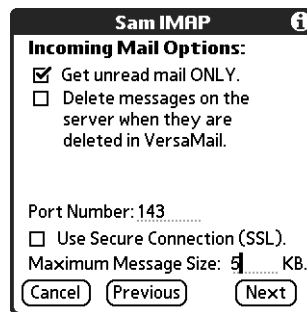

2. Tap Next.

Setting outgoing mail options

Outgoing mail options are the same for POP and IMAP accounts.

To set outgoing mail options:

1. (Optional) Do any of the following:

- Display Name** Enter the name you want to appear on your outgoing messages, such as "Joe Smith."
- Reply To Address** Enter the e-mail address that you want recipients to see and reply to on your e-mail messages, only if this is different from the e-mail address from which you are sending the message. For example, if you are sending a message from me@yahoo.com but you want recipients to reply to me@earthlink.net, enter the reply-to address here. Reply To Address makes it look as though the e-mail came from the address you entered.
- BCC** Select the BCC check box to send a blind copy of any e-mail message you send to another e-mail address. The blind copy e-mail address is not seen by the other recipients of the message. For example, if you want a copy of all messages you send from your handheld to be sent to your corporate e-mail account, enter that e-mail address.

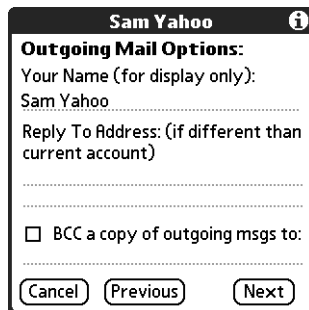

The screenshot shows a dialog box titled "Sam Yahoo" with an information icon. It contains the following text and fields:

- Outgoing Mail Options:**
- Your Name (for display only):
Sam Yahoo
- Reply To Address: (if different than current account)
.....
- BCC a copy of outgoing msgs to:
.....
- Buttons: Cancel, Previous, Next

2. Tap Next.

Adding a signature

If you want, you can add a signature to each e-mail message you send. For example, you can enter your name and telephone number so that they appear on each message you send.

To add a personal signature:

1. Tap the Attach Signature to messages check box, and then enter the text of the signature.

This signature is attached to all your outgoing e-mail.

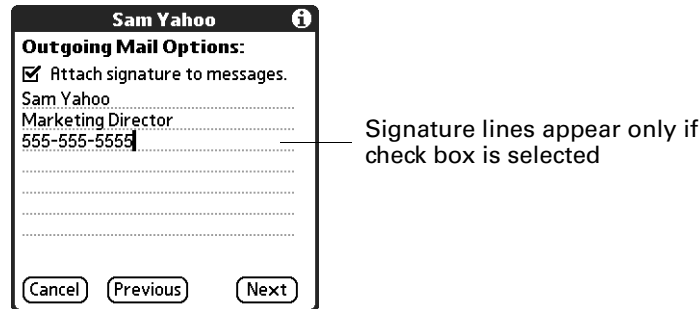

2. Tap Next.

Setting advanced outgoing mail options

You can set additional outgoing mail options.

To set advanced outgoing mail options:

1. (Optional) Select any of the following:

Port Number The default is 25, the port number most SMTP servers use. If you are not sure about the correct port number, check with your mail server administrator.

Authentication Select the My server requires authentication (ESMTP) check box if the outgoing server (SMTP) requires authentication. Check with your system administrator before selecting this option. See [“Adding ESMTP to an account”](#) later in this chapter for information. If you select this option, username and password fields appear. These fields are prepopulated based on the account information you entered previously. In most cases, the prepopulated information is correct; however, occasionally your authentication username and/or password is different from your account username or password. Check with your e-mail service provider for authentication username and password information.

If you need to enter new information, enter a username and/or tap the Password box and enter a password, and then tap OK.



Username and Password fields appear only if ESMTP check box is selected

2. Tap Done.

Testing your new account

After you finish setting up a new e-mail account, the Inbox of the account you just created is displayed. You can test whether the e-mail account is set up and working properly by tapping Get Mail. See [“Getting e-mail by subject or getting the entire message”](#) later in this chapter for more information.

Creating a synchronize-only account

NOTE You must be using a Windows computer to use a synchronize-only account.

A synchronize-only e-mail account enables you to download, view, and manage e-mail between the handheld and a desktop e-mail application, such as Microsoft Outlook, by performing a HotSync operation by means of the cradle/cable. You can't send and receive messages wirelessly or with a modem for any account of this type.

To create a synchronize-only e-mail account:

1. Tap the Menu icon .
2. Tap Accounts.
3. Select Account Setup.

Message	Options	Accounts
Sam Yahoo		✓1
Sam IMAP		✓2
Sam Sync		✓3
Speakeasy		✓4
Account Setup...		✓W

4. Tap New.



5. Do the following:

- Account Name** Enter a descriptive name for this account, such as "My Yahoo."
- Mail Service** Tap the Mail Service pick list and select the provider to which you are connecting. Select Other if your ISP is not listed.
- Protocol** Tap the Protocol pick list and select POP or IMAP. (Most mail providers use the POP protocol.)

If the VersaMail application knows the protocol for the mail service you selected, it displays the correct protocol.

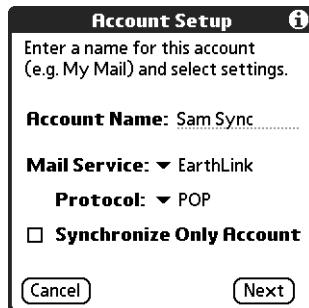

6. On the same screen, select the Synchronize Only Account check box.

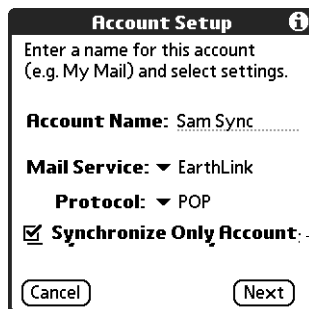

Select check box for a synchronize-only account

7. Tap Next.

Entering the account username and password

In the next part of the VersaMail Account Setup, you enter the username and password for this account. The VersaMail 2.5 application provides strong 128-bit AES encryption for your password.

To enter the account username and password:

1. Enter the username you use to access your e-mail. This is generally the part of your e-mail address appearing before the @ symbol; it is usually not your entire e-mail address.

2. Tap the Password box, and then enter your password.
3. Tap OK. The Password box displays the word “Assigned” to indicate that a password has been entered.
4. Tap Next.

Entering the name of the outgoing and incoming mail server

You need to enter your e-mail address for the account you are accessing, as well as the names of the outgoing and incoming mail servers.

To enter mail server settings:

1. If you chose a preconfigured service from the Mail Services pick list on the Account Setup screen, the e-mail address field is completed automatically, based on the username and mail service you entered. Check the address to verify that it is correct, and edit it if necessary.

If you chose Other from the Mail Services pick list on the Account Setup screen, enter the e-mail address for your account.

E-mail address will be filled in automatically if you chose a preconfigured mail service

Mail servers will be filled in automatically if the VersaMail application knows the names based on the mail service you chose

2. Enter the name of your incoming (POP) mail server, such as pop.mail.yahoo.com.

If the VersaMail application knows the incoming mail server name based on the mail service you selected, the correct server name is displayed.

3. Enter the name of your outgoing (SMTP) mail server, such as smtp.mail.yahoo.com.

If the VersaMail application knows the outgoing mail server name based on the mail service you selected, the correct server name is displayed.

4. Tap Next.

5. Do one of the following:

- To accept these mail options and begin using the VersaMail application, tap Done. After you finish setting up a synchronize-only e-mail account, you need to configure this account on your desktop. See [“Configuring an account in HotSync Manager”](#) later in this chapter for information. You will not be able to synchronize e-mail between your handheld and your desktop until you configure the account on your desktop.
- To set up additional mail options, tap Next. Continue with the next set of procedures.

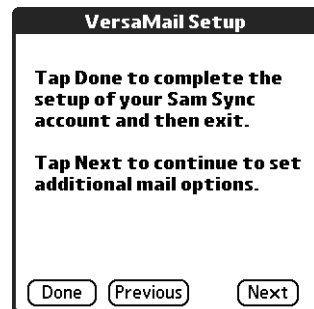

Setting mail retrieval options for a POP or IMAP account

The next VersaMail Setup screen displays different options, depending on whether your mail service uses a POP or an IMAP protocol.

To set mail retrieval server options for a POP or IMAP account:

1. (Optional) Select any of the following:

Get unread mail **NOTE** The POP protocol does not support retrieval of unread mail only from the server. If you have a POP e-mail account, the VersaMail application downloads all messages from the server regardless of whether you have read them (for example, on your desktop or on the web), and regardless of whether this check box is selected.

For IMAP accounts, select Get unread mail ONLY to download only unread mail to your handheld. If you don't choose this option and you tap Get & Send, all of your e-mail messages on your provider's mail server are downloaded to your Inbox, including messages you have already read. To get all mail (including mail you have already read) and not just unread mail, deselect Get unread mail ONLY.

Delete messages on server To delete messages on your provider's mail server when they are deleted in the VersaMail application, select the Delete messages on the server when they are deleted in VersaMail check box.

Leave mail on server (POP account only) To get e-mail on your handheld but also leave it on the server so you can view it later on your desktop, select the Leave mail on server check box. For example, if you create an account to receive e-mail from your Yahoo account and select this option, your old Yahoo e-mail is still visible the next time you visit Yahoo.com to access your Yahoo e-mail Inbox.

Port Number The port number setting defaults to 110 for POP and to 143 for IMAP servers, respectively. You may need to change the port number if you choose to retrieve incoming mail over a secure connection (see the next bullet item). If you are not sure about the correct port number, check with your mail server administrator.

Use Secure Connection To retrieve incoming mail over a secure (Secure Sockets Layer, or SSL) connection, select the Use Secure Connection check box. See ["Using Secure Sockets Layer \(SSL\)"](#) later in this chapter for information on SSL.

Maximum Message Size To limit the maximum size of an incoming e-mail message, enter the size in kilobytes (KB) for Maximum Message Size. The maximum size of an incoming message is 5KB by default, but you can enter a smaller size. The maximum message size that you can retrieve is 60KB for the body text and 2MB total, including attachments.

POP accounts

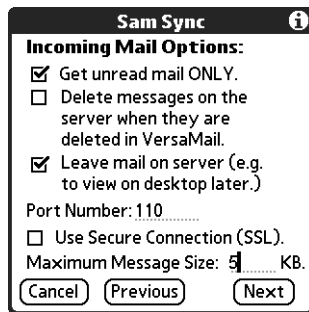

IMAP accounts

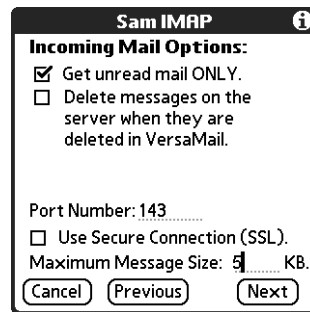

2. Tap Next.

Setting outgoing mail options

Outgoing mail options are the same for POP and IMAP accounts.

To set outgoing mail options:

1. (Optional) Enter or select any of the following:

Display Name Enter the name you want to appear on your outgoing messages, such as “Joe Smith.”

Reply To Address Enter the e-mail address that you want recipients to see and reply to on your e-mail messages, only if this is different from the e-mail address from which you are sending the message. For example, if you are sending a message from “me@yahoo.com” but you want recipients to reply to “me@earthlink.net,” enter the reply-to address here. Reply To Address makes it look as though the e-mail came from the address you entered.

BCC Select the BCC check box to send a blind copy of any e-mail message you send to another e-mail address. The blind copy e-mail address is not seen by the other recipients of the message. For example, if you want a copy of all messages you send from your handheld to be sent to your corporate e-mail account, enter that e-mail address.

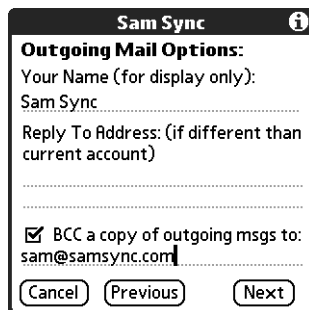

2. Tap Next.

Adding a signature

If you want, you can add a signature to each e-mail message you send. For example, you can enter your name and telephone number so that they appear on each message you send.

To add a personal signature:

1. Tap the Attach Signature to messages check box, and then enter the text of the signature.

This signature is attached to all your outgoing e-mail.

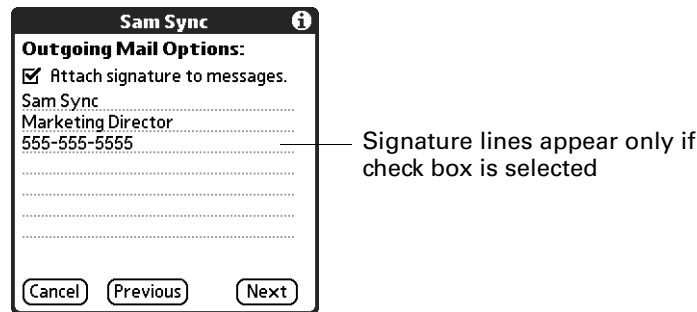

2. Tap OK.

Setting advanced outgoing mail options

You can set additional outgoing mail options.

To set advanced outgoing mail options:

1. (Optional) Select any of the following:

Port Number The default is 25, the port number most SMTP servers use. If you are not sure about the correct port number, check with your mail server administrator.

Authentication Select the My server requires authentication (ESMTP) check box if the outgoing server (SMTP) requires authentication. Check with your system administrator before selecting this option. See [“Adding ESMTP to an account”](#) later in this chapter for information. If you select this option, username and password fields appear. These fields are prepopulated based on the account information you entered previously. In most cases, the prepopulated information is correct; however, occasionally your authentication username and/or password is different from your account username or password. Check with your e-mail service provider for authentication username and password information.

If you need to enter new information, enter a username and/or tap the Password box and enter a password, and then tap OK.

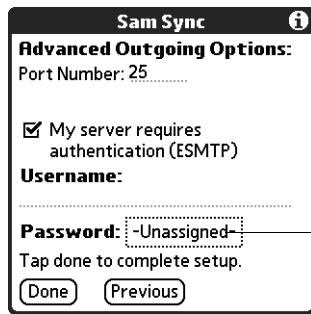

Username and Password fields appear only if ESMTP check box is selected

2. Tap Done.

Configuring your synchronize-only account

After you finish setting up a synchronize-only e-mail account, you need to configure this account on your desktop. See [“Configuring an account in HotSync Manager”](#) later in this chapter for information. You will not be able to synchronize e-mail between your handheld and your desktop until you configure the account on your desktop.

Editing e-mail accounts

From time to time, you may need to edit information about one of the e-mail accounts you set up.

To select the account to edit:

1. Tap the Menu icon .
2. Tap Accounts.
3. Select Account Setup.
4. Tap the name of the account to edit, and then tap Edit.



To edit an account:

1. On the Account Setup screen, change any of the following:

Account Name	Enter a descriptive name for this account, such as “My Yahoo.”
Mail Service	Tap the Mail Service pick list and select the provider to which you are connecting. Select Other if your ISP is not listed.
Protocol	Tap the Protocol pick list and select POP or IMAP. (Most mail providers use the POP protocol.)

If the VersaMail application knows the protocol for the mail service you selected, it displays the correct protocol.

2. Tap Next.

Changing the account username and password

In the next part of the VersaMail Account Setup, you can change the username and/or password for this account. The VersaMail 2.5 application provides strong encryption for your password.

To edit the account username and password:

1. (Optional) Enter a new username for accessing your e-mail. This is generally the part of your e-mail address appearing before the @ symbol; it is usually not your entire e-mail address.

2. (Optional) Tap the Password box, and then enter a new password. The Password box displays the word “Assigned” to indicate that a password has been entered.
3. Tap OK. The Password box displays the word “Assigned” to indicate that a password has been entered.
4. Tap Next.

Editing the names of the outgoing and incoming mail servers

If your e-mail address or the names of the outgoing and incoming mail servers have changed or have been entered incorrectly, you can edit the address or the server names.

To edit mail server settings:

1. (Optional) Enter a new e-mail address for the account you are accessing, such as “`examplename@yahoo.com`.”

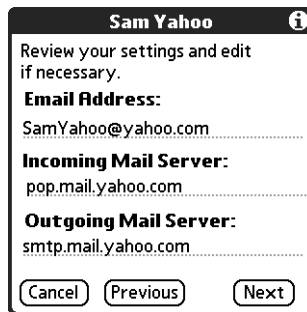

2. (Optional) Enter the new or correct name of your incoming (POP) mail server, such as `pop.mail.yahoo.com`.

If the VersaMail application knows the incoming mail server name based on the mail service you selected, the correct server name is displayed.
3. (Optional) Enter the new or correct name of your outgoing (SMTP) mail server, such as `smtp.mail.yahoo.com`.

If the VersaMail application knows the outgoing mail server name based on the mail service you selected, the correct server name is displayed.
4. Tap Next.

5. Do one of the following:
 - To accept these mail options and begin using the VersaMail application, tap Done. This takes you to the Inbox of the account you set up. See [“Getting, sending, and managing e-mail”](#) later in this chapter for information on getting and sending e-mail.
 - To edit additional mail options, tap Next. Continue with the next set of procedures.

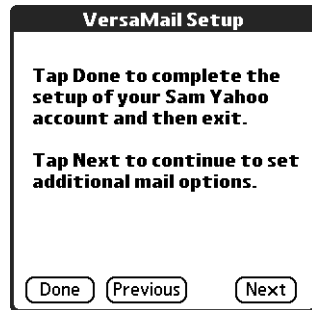

Editing mail retrieval options for a POP or IMAP account

The next VersaMail Setup screen displays different options, depending on whether your mail service uses a POP or an IMAP protocol.

To edit mail retrieval server options for a POP or IMAP account:

1. (Optional) Change any of the following:

Get unread mail **NOTE** The POP protocol does not support retrieval of unread mail only from the server. If you have a POP e-mail account, the VersaMail application downloads all messages from the server regardless of whether you have read them (for example, on your desktop or on the web), and regardless of whether this check box is selected.

For IMAP accounts, select Get unread mail ONLY to download only unread mail to your handheld. If you don't choose this option and you tap Get & Send, all of your e-mail messages on your provider's mail server are downloaded to your Inbox, including messages you have already read. To get all mail (including mail you have already read) and not just unread mail, deselect Get unread mail ONLY.

Delete messages on server To delete messages on your provider's mail server when they are deleted in the VersaMail application, select the Delete messages on the server when they are deleted in VersaMail check box.

- Leave mail on server (POP account only)** To get e-mail on your handheld but also leave it on the server so you can view it later on your desktop, select the Leave mail on server check box. For example, if you create an account to receive e-mail from your Yahoo account and select this option, your old Yahoo e-mail is still visible the next time you visit Yahoo.com to access your Yahoo e-mail Inbox.
- Port Number** The port number setting defaults to 110 for POP and to 143 for IMAP servers, respectively. You may need to change the port number if you choose to retrieve incoming mail over a secure connection (see the next bullet item). If you are not sure about the correct port number, check with your mail server administrator.
- Use Secure Connection** To retrieve incoming mail over a secure (Secure Sockets Layer, or SSL) connection, select the Use Secure Connection check box. See [“Using Secure Sockets Layer \(SSL\)”](#) later in this chapter for information on SSL.
- Maximum Message Size** To limit the maximum size of an incoming e-mail message, enter the size in kilobytes (KB) for Maximum Message Size. The maximum size of an incoming message is 5KB by default, but you can enter a smaller size. The maximum message size that you can retrieve is 60KB for the body text and 2MB total, including attachments.

POP accounts

Sam Yahoo ⓘ

Incoming Mail Options:

- Get unread mail ONLY.
- Delete messages on the server when they are deleted in VersaMail.
- Leave mail on server (e.g. to view on desktop later.)

Port Number: 110.....

Use Secure Connection (SSL).

Maximum Message Size: 5.....KB.

Cancel Previous Next

IMAP accounts

Sam IMAP ⓘ

Incoming Mail Options:

- Get unread mail ONLY.
- Delete messages on the server when they are deleted in VersaMail.

Port Number: 143.....

Use Secure Connection (SSL).

Maximum Message Size: 5.....KB.

Cancel Previous Next

2. Tap Next.

Editing outgoing mail options

Outgoing mail options are the same for POP and IMAP accounts.

To edit outgoing mail options:

1. (Optional) Change any of the following:

Display Name Enter the name you want to appear on your outgoing messages, such as “Joe Smith.”

Reply To Address Enter the e-mail address that you want recipients to see and reply to on your e-mail messages, only if this is different from the e-mail address from which you are sending the message. For example, if you are sending a message from me@yahoo.com but you want recipients to reply to me@earthlink.net, enter the reply-to address here. Reply To Address makes it look as though the e-mail came from the address you entered.

BCC Select the BCC check box to send a blind copy of any e-mail message you send to another e-mail address. The blind copy e-mail address is not seen by the other recipients of the message. For example, if you want a copy of all messages you send from your handheld to be sent to your corporate e-mail account, enter that e-mail address.

The screenshot shows a dialog box titled "Sam Yahoo" with an information icon. The dialog is titled "Outgoing Mail Options:" and contains the following fields and options:

- "Your Name (for display only):" with the text "Sam Yahoo" entered.
- "Reply To Address: (if different than current account)" with a blank text field.
- A checkbox labeled "BCC a copy of outgoing msgs to:" which is currently unchecked.
- At the bottom, there are three buttons: "Cancel", "Previous", and "Next".

2. Tap Next.

Editing a signature

If you added a signature to the e-mail messages you send, you can edit the signature. For example, you can change your name or the telephone number that appears in each message you send.

To edit a personal signature:

1. (Optional) To add a signature, select the Attach Signature to messages check box, and then enter the text of the signature.

To edit an existing signature name, phone number, and so on, edit the information on the signature lines.

To remove a signature, deselect the Attach Signature to messages check box.

This signature is attached to all your outgoing e-mail.

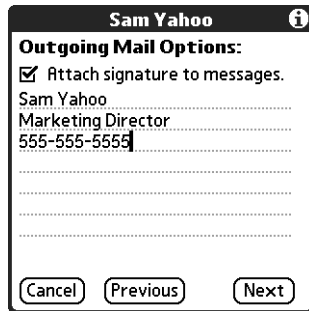

2. Tap Next.

Editing advanced outgoing mail options

You can change additional outgoing mail options.

To edit advanced outgoing mail options:

1. (Optional) Change any of the following:

Port Number The default is 25, the port number most SMTP servers use. If you are not sure about the correct port number, check with your mail server administrator.

Authentication Select the My server requires authentication (ESMTP) check box if the outgoing server (SMTP) requires authentication. Check with your system administrator before selecting this option. See [“Adding ESMTP to an account”](#) later in this chapter for information. If you select this option, username and password fields appear. These fields are prepopulated based on the account information you entered previously. In most cases, the prepopulated information is correct; however, occasionally your authentication username and/or password is different from your account username or password. Check with your e-mail service provider for authentication username and password information.

If you need to enter new information, enter a username and/or tap the Password box and enter a password, and then tap OK.

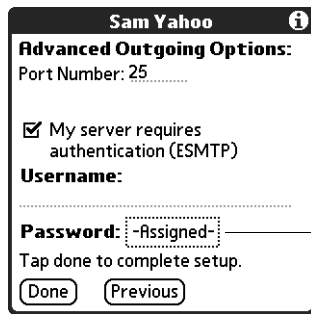

Username and Password fields appear only if ESMTP check box is selected

2. Tap OK.

Deleting an e-mail account

When you delete an account in the VersaMail application, the account is removed from your handheld. The account still exists on the server. For example, deleting your Yahoo account from the VersaMail application deletes only the account from your handheld. Your e-mail account still exists at Yahoo.com.

NOTE You can delete all but one of your e-mail accounts; you must have at least one account.

To delete an account:

1. Tap the Menu icon .
2. Tap Accounts.
3. Select Account Setup.

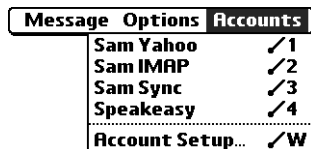

4. Tap the name of the account you want to delete, and then tap Delete.



5. Tap Yes in the Delete Confirmation dialog box to delete the account and all associated e-mail messages.



6. Tap OK.

After you perform the next HotSync operation, the memory associated with an account and its messages is released.

Selecting a different service for a given e-mail account

When you set up connections on your handheld (using the Phone Link application on your handheld), you pair each connection with a network service and then select one of these services to be the default for all network activity (sending and receiving e-mail, surfing the web, and so on) on your handheld. By default, the VersaMail application uses this service for sending and receiving messages for all e-mail accounts you set up. See [Chapter 22](#) for information on setting up the default service for your handheld.

However, for any given e-mail account, you have the option of switching to a different service for use with that account only. For example, the default service you have selected for your handheld may be called My Bluetooth and may use your handheld's built-in Bluetooth radio to make a connection to your corporate mail server. However, for your Earthlink account, you may want to switch to the service called Earthlink, which uses an external modem accessory (sold separately) to make a connection to your e-mail service provider.

To set up a service for a given e-mail account (different from the default service for your handheld):

1. From the Inbox of the account you want to switch, tap Get Mail.

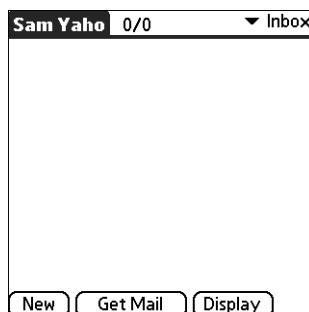

2. Tap Details.

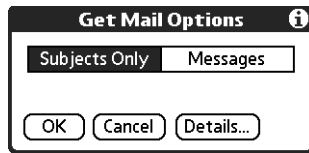

3. Tap the Always connect using check box. A pick list of available services appears. The currently used connection is displayed by default.



Tap to change the service connection for this e-mail account only from your default handheld service connection

4. Select the connection you want to switch to from the Service pick list.

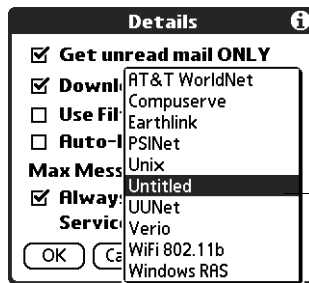

Select a new service connection for this e-mail account only

5. Tap OK, and then tap OK again. If there is an existing service connection, it is disconnected and the new connection is initiated. The VersaMail application sends and checks for any new e-mail using the new connection.

When you exit the VersaMail application, the new service disconnects (unless you are using the default service for your handheld). When you reopen the application, the e-mail account you selected (My Earthlink in this example) continues to connect using the new connection (Earthlink GPRS in this example) until you either select a new service or deselect the Always connect using check box. If you deselect the Always connect using check box, the e-mail account (My Earthlink) connects using the default handheld service (My Bluetooth in this example).

The Always connect using check box changes the connection service for the selected e-mail account only. You must follow the preceding procedure for each e-mail account whose connection you want to switch from the default connection on your handheld.

Troubleshooting account access problems

Occasionally you may experience problems using an e-mail account after you set it up. If you followed the account setup procedures described in “[Setting up and managing e-mail accounts](#)” earlier in this chapter but experience problems using the account, you may need to verify that the account complies with your e-mail provider’s requirements. See [Appendix B](#) for troubleshooting information for account access problems.

Getting, sending, and managing e-mail

Getting and sending e-mail on your handheld is easy and helps you keep your business and personal life organized.

You can manage the messages in your e-mail accounts by moving messages between folders, deleting old e-mail messages individually or in groups, and marking messages as read or unread.

This section describes how to do the following:

- Get and send e-mail for your e-mail accounts
- View and send e-mail attachments, such as text or Microsoft Word documents, wirelessly

Getting e-mail

You can get e-mail subjects only—the message size, author, and subject—or you can get entire messages immediately. If you choose to get message subjects only and want to read a full message, you can get more of the message. If you choose to get the entire message, the body text of the message will be downloaded up to the maximum message size you select. See “[Reading e-mail](#)” later in this chapter for information.

Choosing the e-mail account and displaying the Inbox

To view the e-mail in an account, you must switch to that account and then get the e-mail. For example, if you want to collect and view the e-mail from your Yahoo account, you switch to the account created to retrieve e-mail from your Yahoo account.

To display an account and its Inbox:

1. In your Inbox or another folder screen, tap the Menu icon .
2. Tap Accounts.

3. Select Account Setup.

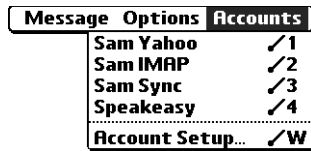

4. Tap the name of the account you want from the list.
5. Tap the folders pick list, and tap Inbox if the Inbox is not displayed.

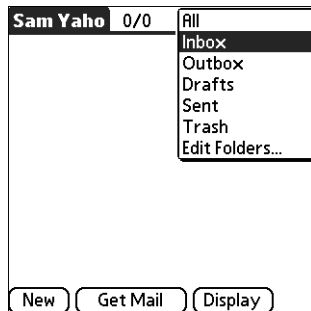

Getting e-mail by subject or getting the entire message

When you get e-mail messages, you can choose to get the subject only or to get the entire message. You can also use the Details dialog box to select options for getting unread e-mail only, downloading attachments, using filters, and more.

To get e-mail messages:

1. Tap Get Mail.
If you have e-mail stored in your Outbox, tap Get & Send.
2. In the Get Mail dialog box, tap Subjects Only to download subjects only, or tap Messages to download entire messages.



TIP You can turn off the Get Mail dialog box in VersaMail Preferences. See [“Setting preferences for getting and deleting e-mail”](#) later in this chapter.

- (Optional) Tap Details and select options for retrieving unread e-mail, downloading attachments, using filters, auto-disconnect, maximum download size, and default connection type for this account. Tap OK.

NOTE See [“Creating mail filters”](#) later in this chapter for more information about filters. See [“Setting advanced account preferences”](#) later in this chapter for information on the auto-disconnect feature. See [“Selecting a different service for a given e-mail account”](#) earlier in this chapter for information on setting a default connection type.

- (Optional) For IMAP accounts, you have the option of synchronizing IMAP folders from the Get Mail dialog. See [“Wireless IMAP folder synchronization”](#) later in this chapter for information.

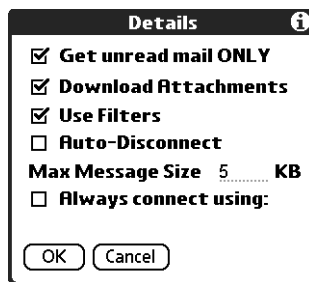

NOTE The maximum size of an incoming message is 5KB by default.

- Tap OK.
- (Optional) If you are retrieving mail using a VPN connection, you may be asked to enter the username and password you use to log in to the VPN. If so, enter the username and password. See [“VPNs”](#) earlier in this chapter for more information.
- The Getting Messages dialog box shows updates as your e-mail is downloaded. When the Getting Messages dialog box disappears, another dialog box appears and displays the number of new e-mail messages.



Tap OK.

A list of your e-mail appears in the Inbox.

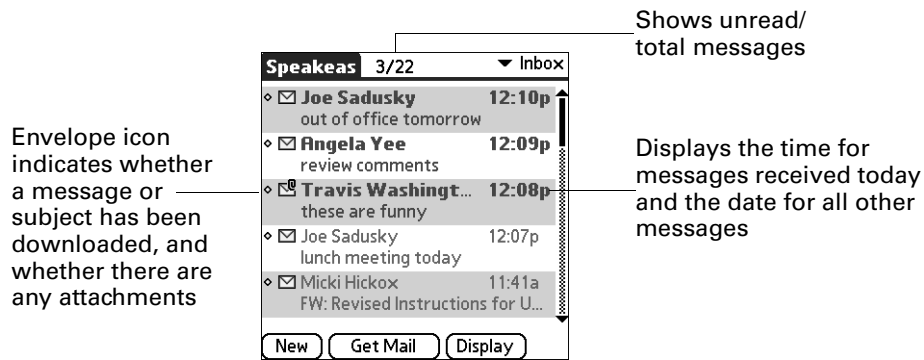

Auto get mail with notification

You can set up the VersaMail application to automatically search for new mail on a regular schedule for a given e-mail account. The auto get mail feature automatically retrieves new messages and downloads them to your handheld, without needing to tap Get Mail.

CAUTION Your handheld must be connected to an e-mail service provider in order for the auto get mail feature to work. Auto get mail only retrieves mail over an already-operating connection. For example, you must be connected to a service provider through a LAN access point or through your mobile phone using a GPRS or Bluetooth connection.

If auto get downloads any new messages, your handheld notifies you by blinking an indicator light, beeping, or vibrating. The handheld also displays a visual list of notifications, called the Reminders screen.

The auto get feature downloads the first 3KB of each message. If a message is larger than 3KB, tap the More button on the message screen to download and view the entire message.

Auto get mail recognizes any filter criteria you have set up for downloading messages to your handheld. See [“Managing mail filters”](#) later in this chapter for information. Any messages that do not meet the filter criteria will not be downloaded during an auto get. To retrieve messages that do not conform to filter criteria, perform a manual get with all filters turned off.

If auto get is taking place and you turn your handheld off or the connection to your e-mail service provider is disconnected, the auto get fails. If you are attempting an auto get over a network from a public location, you must be in range of a network access point for the auto get to work.

Scheduling auto get mail

When setting up a schedule, you select the interval for retrieving mail, the start and end times for retrieving mail, and the days on which scheduled e-mail retrieval should take place.

You can set up different schedules for each of your e-mail accounts, but you can set up only one schedule for a given account. For example, if you set up a schedule for mail retrieval on weekdays for your Yahoo account, you cannot set up a separate schedule for weekends on the same account.

If more than one scheduled auto get takes place at the same time (for example, for two separate e-mail accounts), the retrievals take place in the following order:

- Any past-due auto get (for example, a retry of an earlier failed auto get)
- Current retrievals according to the order of e-mail accounts (#1, #2, and so on)

NOTE The auto get feature is not supported for VPN or SSL connections. It is also not supported if you have configured the security preferences on your handheld to encrypt databases on the handheld. For some nonsupported connection types, the Options menu does not display the auto get mail option; for others, if you try to set up an auto get schedule, an error message appears.



To set up a scheduled auto get mail:

1. On the message screen, Tap the Menu icon .
2. Select Options.



3. Select Auto Get Mail.

4. Select the Get mail automatically check box.



5. Set schedule options:

- Interval** Tap the Every pick list and select the time interval, from 15 minutes to 12 hours. See [“Resource issues with auto get mail”](#) later in this chapter for information on setting the interval.
- Start Time** Tap the Start Time box, tap to enter the start time hour and minute, and tap to enter AM or PM. Tap OK.

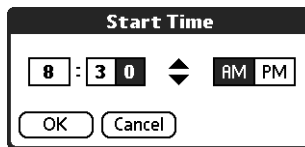

- End Time** Tap the End Time box, tap to enter the end time hour and minute, and tap to enter AM or PM. Tap OK.
- Days** Tap the days you want the schedule to be active. You can choose any number of days, but you can set up only one schedule per a given e-mail account.

6. Tap OK.
7. (Optional) Tap Get Mail. You should perform a manual Get Mail after setting up scheduled auto get. This ensures that only new messages will be retrieved during auto get.

TIP Alternately, if you have configured an e-mail account to synchronize messages between your handheld and your desktop, you can perform a HotSync® operation after setting up a scheduled auto get to ensure that only new messages will be retrieved during auto get. See [“Synchronizing e-mail between the handheld and the desktop”](#) later in this chapter for configuration information.



Auto get notifications

The auto get mail feature provides three different types of alerts during and after message retrieval:

- Depending on the connection type, a series of status messages may appear during the auto get connection and mail retrieval process.
- You can choose to have your handheld alert you when a new message arrives in your account. The beep or alert sound you hear is called a *notification*. Your handheld also notifies you of a new message's arrival by blinking an indicator light or vibrating if the right preferences are turned on. For more information, see [“Making your handheld buzz or blink when you get new e-mail”](#) later in this chapter.

NOTE You must turn the Notification option on to have your handheld notify you when new messages are received. See [“Setting notification options”](#) later in this chapter for more information.

- If auto get discovers and downloads new messages for a given e-mail account, a notification appears in the Reminders screen, displaying the account name and the number of new messages. If auto get is scheduled for more than one account, a separate notification appears for each account. See [“Viewing and using the Reminders screen”](#) later in this chapter.

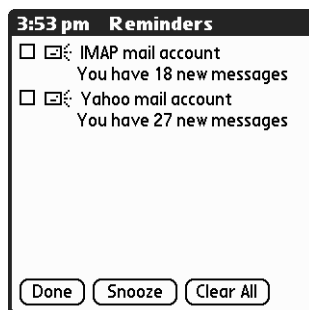

Setting notification options

You can turn the notification sound on or off to notify you when new e-mail arrives. You can choose from a variety of sounds, such as birds, bumble bees, or simply an alarm.

To set notification options:

1. From the Inbox or another folder screen, tap the Menu icon .
2. Tap Options.

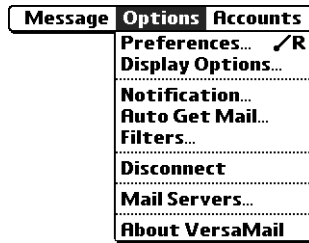

3. Tap Notification.
4. Tap the Notify me of new mail and mail alerts check box.



5. Tap the Notify Sound pick list and select a sound. The handheld plays a brief demonstration of the sound.

NOTE If you install a custom sound on your handheld, it will appear on the Notify Sound pick list.

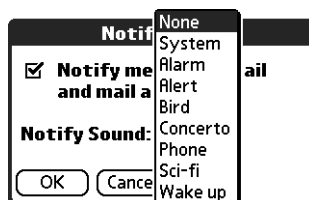



6. Tap OK.

You can follow these procedure steps to change the notification sound or to turn the sound on or off at any time.

Making your handheld buzz or blink when you get new e-mail

In addition to setting a notification sound, you can also choose to have your handheld's indicator light blink or to have your handheld vibrate when you receive new e-mail. You select how your handheld notifies you of new e-mail in your handheld's General preferences.

To make your handheld buzz or blink when you get new e-mail:

1. Tap the Home icon .
2. Tap the Prefs icon .
3. From the General Preferences list, select Sound & Alerts.

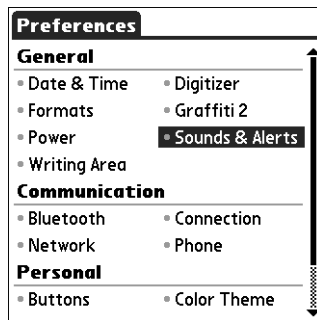

4. Do any of the following:
 - To change the volume of the Alarm Sound, tap the Alarm Sound pick list and select Low, Medium, High, or Off.
 - To change whether or not the handheld indicator light blinks when you receive new e-mail, tap the Alarm LED pick list and select On or Off.
 - To change whether or not the handheld vibrates when you receive new e-mail, tap the Alarm Vibrate pick list and select On or Off.

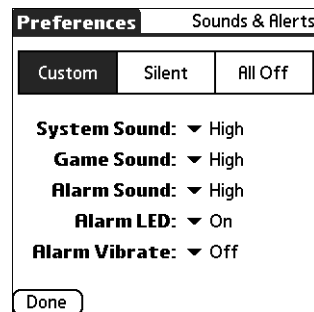

5. Tap Done.

Viewing and using the Reminders screen

Your handheld displays a Reminders screen that shows summary information about new e-mail messages and alerts from other applications, such as alerts to remind you of Date Book appointments.

To view the Reminders screen:

- Tap the blinking asterisk  in the upper-left corner of any screen.

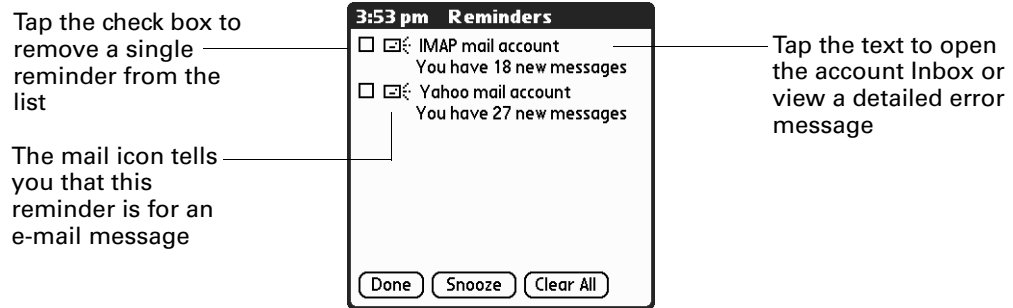

If you set up a scheduled auto get mail and you receive new e-mail messages, they are downloaded into the Inbox. As you work with e-mail messages in the Inbox, the Reminders screen doesn't display a reminder for any new messages that arrive, because the messages are already displayed in the Inbox.

NOTE A broken envelope icon  appears next to a message when an auto get mail or automatic send retry fails.

To respond to the reminders, do one of the following:

- Tap the check box to clear a reminder from the list.
- Tap the reminder (either the mail icon or the text description) to go to the Inbox of that account or read a detailed error message.
- Tap Done to close the Reminders screen and return to whatever you were doing on your handheld before the Reminders screen appeared.
- Tap Clear All to dismiss all reminders in the Reminders screen.

When a notification appears in the Account Manager, tap the notification to go to the Inbox of that account, or launch the VersaMail application and go to that account. Once you view a message in the Inbox it is removed from the Reminders screen notification, even if you do not open the message. Auto get then starts at the next scheduled interval, with the Reminders screen counter reset to 1.

If you do not view the Inbox of the selected account and another scheduled e-mail retrieval takes place and finds new messages, the Reminders screen will add the number of new messages to the notification for that account. For example, if scheduled auto get #1 finds two new messages and, before you view the Inbox, scheduled auto get #2 takes place and finds three more new messages, the Reminders screen notification indicates five new messages for that account.

If auto get discovers new messages but then fails for any reason, a notification appears in the Reminders screen, displaying the account name and an error message.

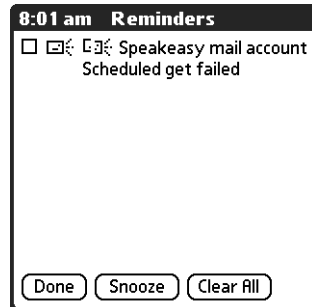

You can tap the error message or open the VersaMail application to the given account for more detailed information on the failed auto get.

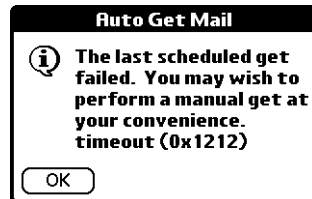

If auto get discovers no new messages for a given account, no notifications appear in the Reminders screen for that account.

The Reminders screen displays only the most recent notification for a given account. For example, if one scheduled auto get failed, but the next one succeeded and downloaded two new messages, the Reminders screen would first display the error message, but would display the number of messages retrieved after the successful retrieval.

Reminders screen notifications are specific for each account. For example, if auto get fails for one account but succeeds in downloading new messages for a separate account, the Reminders screen displays an error message for the first account and a message indicating the number of messages downloaded for the second account.

Auto get mail retries

If the interval for scheduled auto get is set at “Every 1 hour” or less frequently, and an auto get fails for any reason, the VersaMail application continues attempting to retrieve e-mail at 30-minute intervals until either the next scheduled auto get occurs or the end time for scheduled e-mail retrieval is reached. If the interval is set for more frequently than one hour and an auto get fails, the VersaMail application waits until the next scheduled auto get.

Resource issues with auto get mail

If you use the auto get mail feature, you should be aware of the following potential resource constraints:

Decreased battery life If you set the auto get interval for more frequently than once per hour, you may drain your handheld's battery charge more quickly, and thus need to recharge the battery more frequently.

Increased monthly charges If your e-mail service provider is a wireless provider such as Cingular or T-Mobile that charges a fee for data transactions, using the auto get feature can substantially add to your monthly charges. This issue is especially noticeable for POP accounts, because the size of the IDs used to locate POP account messages is much larger (and thus POP messages take longer to download) than for IMAP accounts.

NOTE If you primarily retrieve messages over your company's network (Bluetooth or 802.11b network), monthly charges should not be an issue.

If you set the auto get mail interval for more frequently than once per hour, an alert message appears.

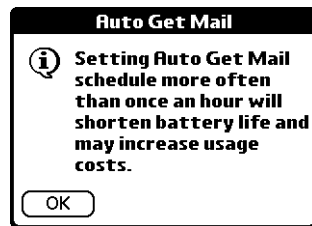

To minimize resource concerns, set your interval for e-mail auto get to no more frequently than once per hour.

Inbox icons in the VersaMail application

The icons to the left of a message in the Inbox indicate the message's status.



Only the subject header information is downloaded.



Part or all of the message text is downloaded.



Part or all of the message text and attachment information is downloaded.

Reading e-mail

To read e-mail, tap the e-mail message in the Inbox or the folder where the message is located.

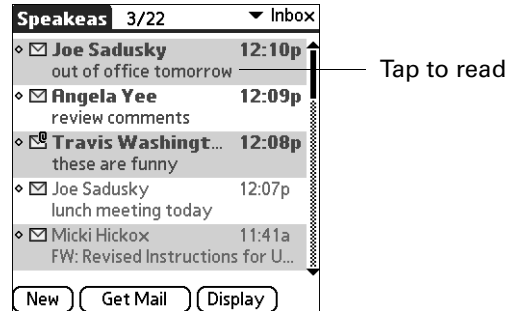

Alternately, you can use the navigator for one-hand message viewing.



To read a message using the navigator:

1. Press Select on the navigator to highlight the first message displayed on the screen, and then press Up or Down to scroll one message at a time to the message you want to read.
2. Press Select to open the message.
3. After reading the message, press Select to close the message.

If you chose to get messages by subjects only, tap the More button  to view the body of the e-mail message, plus any attachments, up to the maximum message size you select. If the downloaded message exceeds your maximum message size, only a partial message is displayed. Tap the More button to view the entire message. See [“Getting e-mail by subject or getting the entire message”](#) earlier in this chapter.

If you chose to get entire messages, the body of the e-mail message is displayed. However, if the downloaded message exceeds your maximum message size, only a partial message is displayed. Tap the More button to view the entire message.

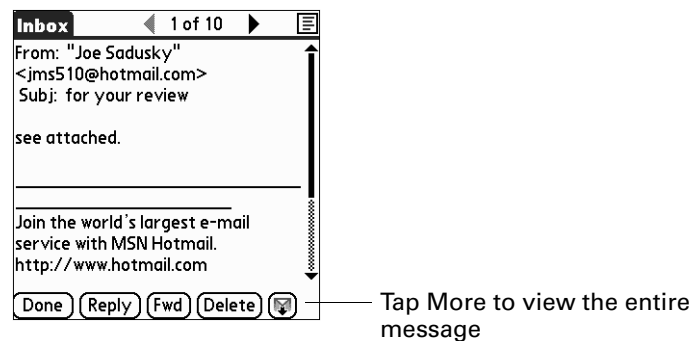

Plain text and HTML e-mail

By default, the VersaMail application is set to receive mail in HTML format. This means that any e-mail messages sent as HTML will be displayed on your handheld with basic HTML formatting intact, including the following:

- Boldface
- Italics
- Underlining
- Colored words
- Bullet lists
- Numbered lists
- Line breaks

Most formatting not displayed is stripped of its HTML tags and shown as plain text. For certain types of graphic images (for example, JPG or GIF files), the graphic may be displayed as a URL in the body of the e-mail message. In some cases, you can tap the URL to open the graphic image. See [“Working with URLs”](#) later in this chapter for more information.

When you set the VersaMail application to receive e-mail messages as HTML, any messages sent as plain text will be displayed as plain text only. You can also set the application to receive all messages as plain text only, regardless of the format in which they were sent. If you choose this option, only the text of any messages sent in HTML format will be displayed.

NOTE The VersaMail application sends all messages as plain text only, with all HTML tags stripped, even if you are forwarding or replying to a message that was originally received as HTML.

To select whether to receive e-mail messages in HTML or in plain text format:

1. Tap the Menu icon .
2. Tap Options.
3. Select Preferences.

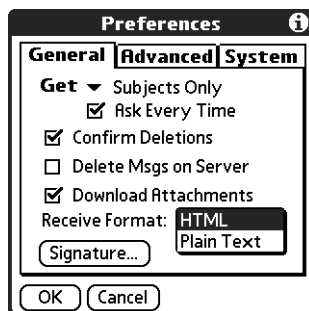

4. Tap the Receive Format pick list and select HTML or Plain Text. The default is HTML.
5. Tap OK.

Viewing other folders

When you get new e-mail, it appears in the account's Inbox folder. You can move an e-mail message from one folder to another and then view it in the destination folder.

To view other folders:

1. Tap the folders pick list in the upper-right corner of the screen.

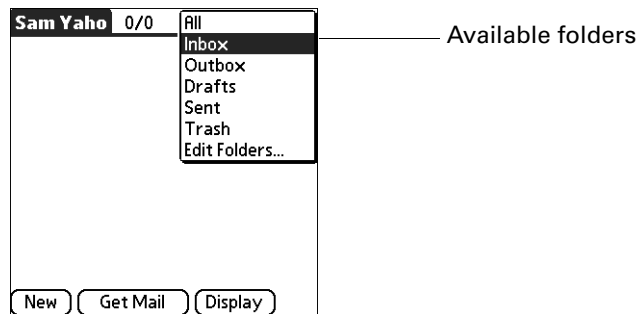

2. Tap the folder you want to view.

Managing display options in the folder's list view

You can customize the way in which messages appear in the list view of your mail folders. The options you choose apply to all folders.

The display options you can customize, and the default settings, are as follows:

Option	Default
Sort by	Date
Sort order	Descend
Summary view	Two-line view
Summary view columns	Sender, Date, Subject
Font	Palm 9
Unread message color	Black
Read message color	Black

To change the sort order:

1. Tap Display.
2. Tap the Sort by pick list, and then tap the column name.

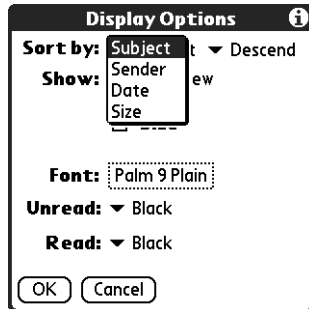

3. Tap Descend or Ascend to change the sort order.

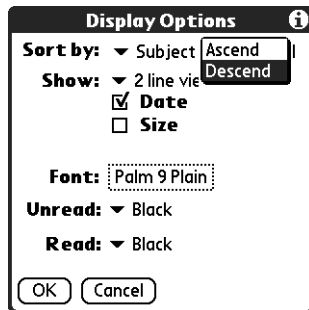

4. Tap OK.

To select a one-line or two-line view:

1. Tap Display
2. Tap the Show pick list, and then tap the view you want.

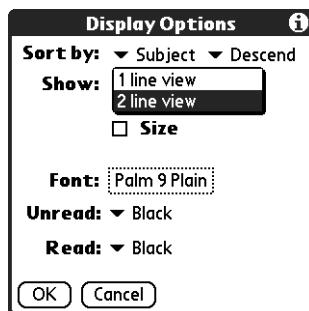

3. Tap OK.

To display or hide a column in a folder's list view:

1. Tap Display.
2. Tap the check box for each column that you want to show. The column options will change depending on whether you choose a one-line or a two-line view.

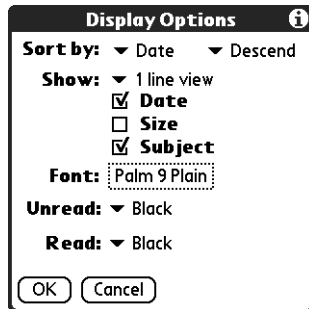

NOTE If you select Date, the Date column displays the message *time* for any messages received today—that is, any message received after 12:01 A.M. Otherwise, the Date column shows the date the message was received.

3. Tap OK.

To change the font:

1. Tap Display.
2. Tap in the Font field.

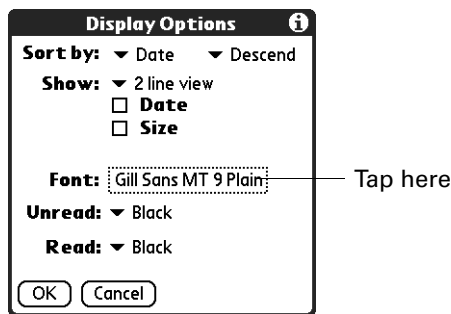

3. Tap the Font pick list and select the font you want.

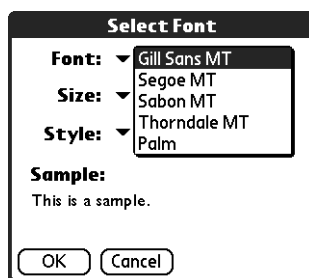

4. Tap the Size pick list and select the font size you want.

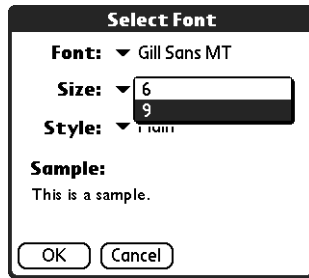

5. Tap the Style pick list and select the font style you want.

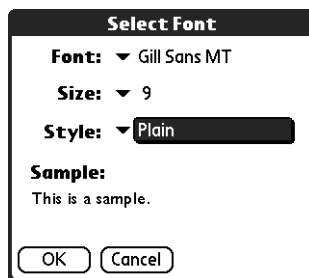

6. Tap OK.

To select colors for read and unread mail:

1. Tap Display.
2. Tap the Unread pick list, and then tap the color you want to use to display unread messages.
3. Tap the Read pick list, and then tap the color you want to use to display read messages.

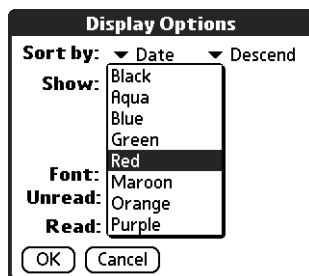

4. Tap OK.

In the list view itself, you can also change the size of the columns.

To change the size of a column in the folder's list view:

NOTE Changing column size is available for one-line message view only.

1. Tap and hold the stylus on the column divider.
2. Drag the column divider to change the width of the column.

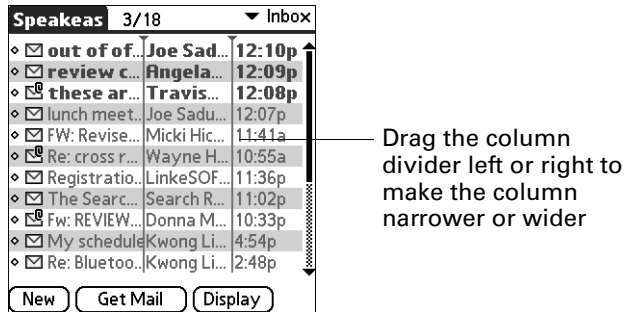

3. Tap OK.

You can also change the font within an individual message. This change affects the the font of all messages you compose.

To change the font of a composed message:

1. On the message screen, tap the Menu icon .
2. Select Options.

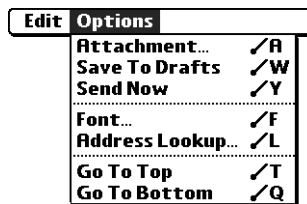

3. Tap Font.
4. Tap the Font pick list and select the font you want.

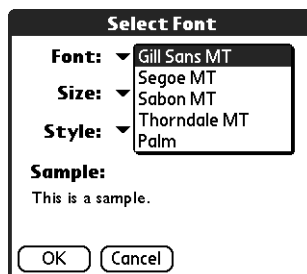

5. Tap the Size pick list and select the font size you want.

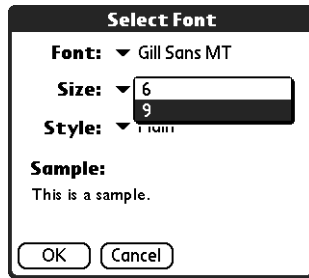

6. Tap the Style pick list and select the font style you want.

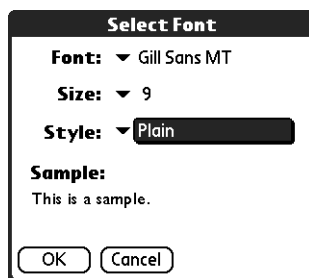

7. Tap OK.

Moving e-mail between folders

You can move one or more e-mail messages between folders.

To move one e-mail message:



1. Tap the folders pick list in the upper-right corner of the screen, and then tap the folder name, or press Up or Down on the navigator to move to the folder you want, and then press Select to select the folder.

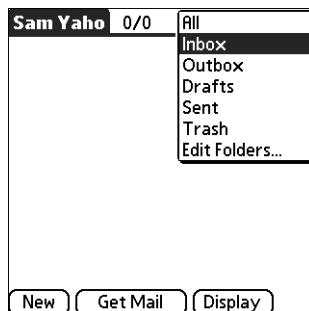

2. Press Right on the navigator to open the Message menu, press Down to move to the Move To option, and then press Select to select this option.

Alternately, tap the icon to the left of the message, and then tap Move To from the pop-up menu.

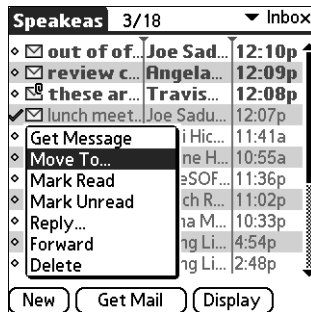

The folders pick list appears.

3. Press Up or Down on the navigator to move to the folder you want, and then press Select to select the folder.

Alternately, tap the folder that you want.

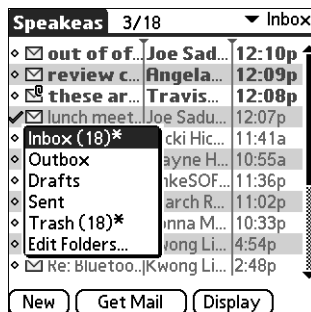

TIP You can also move a single e-mail message from within the body of the message by pressing the command bar stroke in the Graffiti® 2 writing area, tapping the folder icon, and selecting the destination folder from the pick list. See [“Using the command bar”](#) later in this chapter for more information on the command bar.

To move multiple e-mail messages:

1. Tap the folder that contains the e-mail messages you want to move.
2. Select the messages by tapping to the left of each message icon.

TIP To select a group of adjacent messages, drag the stylus to the left of the message icons.

A checkmark appears next to the selected messages.

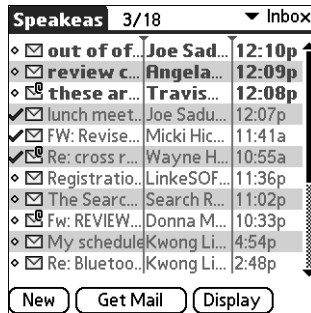

3. Do one of the following:

- Tap the Menu icon , and then tap Move To.
- Tap a message icon next to a selected message, and then tap Move To on the pick list.

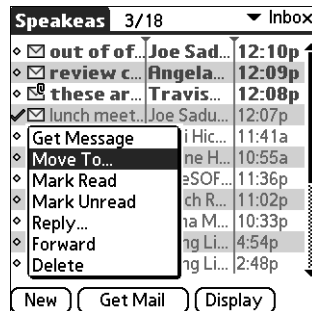

4. Tap the folders pick list, and select a destination folder.

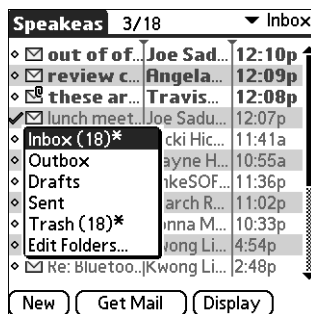

5. Tap OK.

Creating and editing mail folders

You can also create new folders so that you can store e-mail messages by subject, person, or project. The VersaMail application has certain existing folders, such as Inbox, Outbox, Drafts, and Trash.

The procedure for creating and editing folders varies slightly between POP and IMAP e-mail accounts, as described in the following procedure.

To create and edit e-mail folders:

1. Tap the folders pick list in the upper-right corner of the screen, and then tap Edit Folders.
2. On the Edit Folders or Edit IMAP Folders screen, select any of the following:

POP accounts

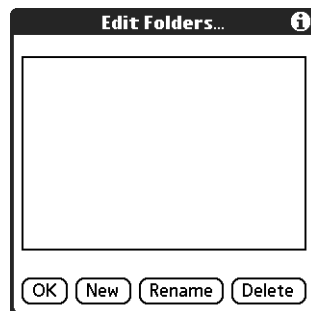

IMAP accounts

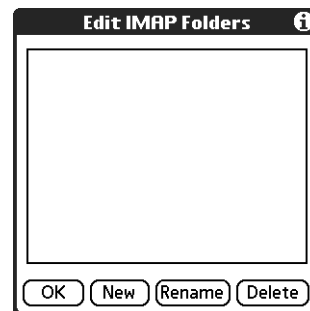

- To create a new folder, tap New, and then enter the new folder name. For IMAP accounts only, select the check box if you also want to create the folder on the server. When finished, tap OK.

POP accounts



IMAP accounts

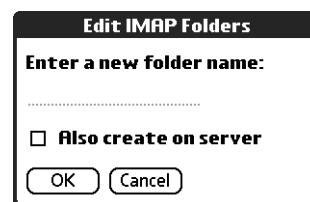

- To rename a folder, tap the folder name from the list on the screen, tap Rename, and then enter the new folder name. For IMAP accounts only, you have the option of renaming the folder on the server. Select the check box if you also want to rename the folder on the server. When finished, tap OK.

POP accounts

IMAP accounts

- To delete a folder, tap the folder name from the list on the screen, and then tap Delete. For IMAP accounts only, you have the option of deleting the folder on the server. Select the check box if you also want to delete the folder on the server, and then tap OK. For POP accounts, the folder will be deleted immediately and you will not see a confirmation screen.

Delete confirmation appears for IMAP accounts only

Creating and sending new e-mail

When you create a new e-mail message, you can enter the person's e-mail address or use the Lookup screen to find a particular address.

To create a new e-mail message:

1. Tap New.

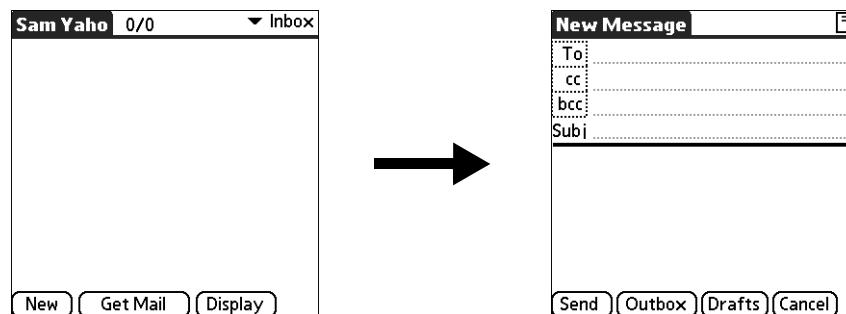

2. Enter the recipient's name using one of the methods described in the next procedures.

NOTE When you address a message to several recipients, you do not see all the recipients on the To list because the list is truncated on the To line. If you tap the To field, a dialog box shows all recipients for the current message.

Addressing a message by typing the address

You can address a message by entering the complete address.

To enter the address:

1. In the New Message screen, tap or navigate to the To field and enter the address, and then tap Done.



For multiple recipients, type a semicolon (;) and then a space between recipient names. The To field expands to two lines during address entry for addresses longer than the one-line display.

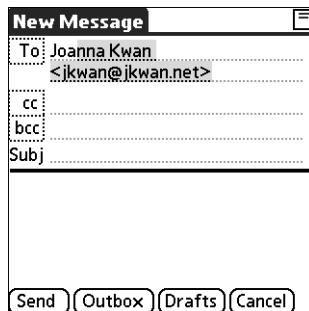

After address entry, addresses longer than one line are shown on a single line with an ellipsis symbol to the right of the address line.

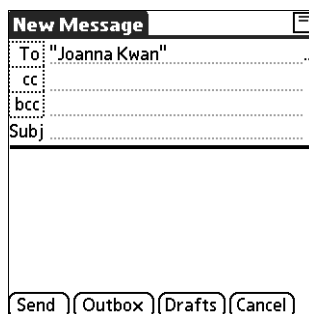

Ellipsis indicates address is longer than one line

Alternately, in the New Message screen, tap the word To and enter the address on the Recipient List screen, and then tap Done. Use the shortcut buttons at the bottom of the screen for quick address entry.

For multiple recipients, type a semicolon (;) or tap the semicolon button at the bottom of the screen, and then type a space between recipient names.

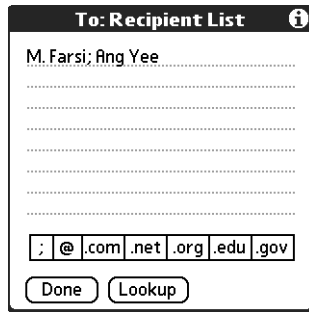

NOTE If you enter a comma instead of a semicolon, it is automatically changed to a semicolon. If you enter a space with no punctuation between names, semicolons are not inserted and the e-mail message is improperly addressed.

If you want to edit an e-mail address that is longer than the line provided in the New Message screen, tap the To field and edit the address.

2. To send copies, tap cc: or bcc: and enter the recipient's address.

Copies (cc:) allow recipients to see the addresses of the other recipients, but addresses in the blind copies (bcc:) field are hidden from all other recipients.

TIP To automatically fill in the address as you type, see ["Using Smart Addressing to address a message"](#) later in this chapter.

Addressing a message using Address Book

You can enter a recipient's address by using the Lookup screen to select the address. The names and addresses in the Lookup screen come from Address Book.

To use an address from Address Book:

1. In the New Message screen, tap the word To.
2. On the Recipient List screen, tap Lookup.

3. On the Address Lookup screen, tap the address you want, and then tap Add.

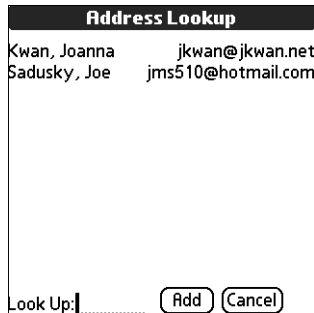

4. (Optional) Repeat steps 2 and 3 for each address you want to add.
5. To enter an address in the cc: or bcc: field, tap the field name and follow the steps given for the To field.

Using Smart Addressing to address a message

Smart Addressing types ahead and completes a recognized e-mail address. Smart Addressing automatically fills in fields when the recipient's name and e-mail address are in your Address Book.

By default, Smart Addressing is selected in VersaMail Preferences.

To use Smart Addressing to address a message:

1. In the New Message screen, tap in the To field.
2. Start entering the person's name, such as Joe Smith.

Once the name is recognized from your Address Book, the name and e-mail address are automatically completed on the recipient list. For example, if you have a Joe Smith and a Joan Smith in your Address Book (and no other names starting with J), once you type "Joe," the entry "Joe Smith" is completed with the correct e-mail address.

3. If Smart Addressing recognizes more than one name for the typed entry, or if the recognized name has more than one e-mail address associated with it, all of the names or e-mail addresses are displayed. Navigate or tap to select the name/e-mail address you want.

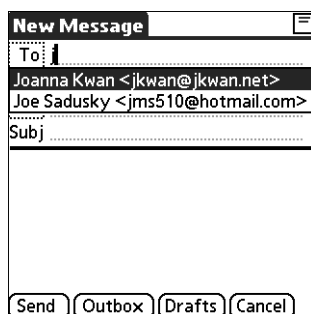

4. Tap Done.

Turning Smart Addressing on or off

You can turn Smart Addressing on or off in VersaMail Preferences. By default, Smart Addressing is turned on.

To turn Smart Addressing on or off in VersaMail Preferences:

1. In the Inbox, tap the Menu icon .
2. Tap Options
3. Select Preferences.
4. Tap Advanced.

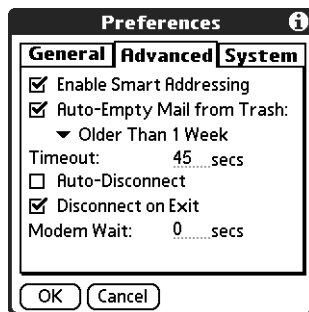

5. Tap the Enable Smart Addressing check box if it is not selected. A checkmark means it is turned on.
6. Tap OK.

Composing and sending e-mail

After you enter your recipient addresses, you can compose the rest of the e-mail message.

To compose the rest of the e-mail and send it:

1. Tap the Subject field and enter the subject of your e-mail.

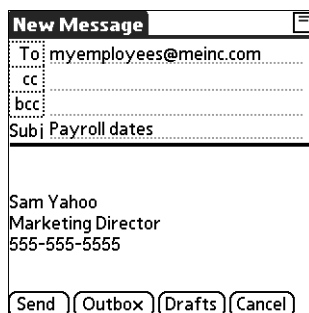

2. Tap the area below the Subject line and enter the text of your e-mail.



To access the editing features available on the Edit menu, tap the Menu icon . The first character of each sentence is automatically capitalized for you.

3. (Optional) Tap the Options menu and select Add Attachments. See [“Attaching files from a handheld application”](#) later in this chapter.
4. Tap one of the following to send the e-mail:

Send Sends the e-mail immediately.

Outbox Stores e-mail in the Outbox so you can compose e-mail offline and then send all e-mail during one connection with the server. To send your e-mail later, tap Get & Send. A connection is made to the mail server, and all the e-mail in the Outbox is delivered.

TIP You can also tap Drafts to save this message in the Drafts folder rather than send it.

Send retry

When you tap Send on the message menu, the VersaMail application automatically attempts to send the message. If the send attempt fails for any reason (for example, your handheld is out of range, or the application cannot connect to the mail server), you can choose to have the application move the message to the Outbox and continue to try to send the message at 30-minute intervals, a maximum of three times.

If you put a message in the Outbox, you must perform a manual send to send the message on the first attempt. The VersaMail application attempts automatic send retry only after a manual send attempt fails.

If automatic send retry succeeds on any attempt, the message is moved to the Sent folder.

NOTE Automatic send retry occurs only if you tap Send to send the message manually. It does not work if you tap Get & Send.

To select automatic send retry:

- Tap Yes on the dialog box notifying you that manual send has failed.



NOTE Automatic send retry is not supported for VPN or SSL connections, or for accounts for which your ISP requires you to log in to the mail server before sending mail. It is also not supported if you have configured the security preferences on your handheld to encrypt databases on the handheld.

Send retry notifications

If automatic send retry fails after the third attempt, a notification appears in the Reminders screen. A separate notification appears for each e-mail account for which a send retry has failed.

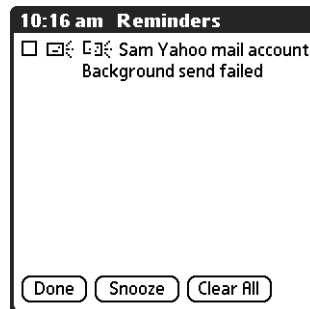

Tap the notification or open the account in the VersaMail application to view a detailed error message.



Viewing the error message deletes the notification from the Reminders screen. The Reminders screen shows only the most recent notification for a given e-mail account, no matter how many automatic send retries have been attempted for that account.

If automatic send retry fails after the third attempt, you must send the message manually.

NOTE If you perform a HotSync operation or a soft reset during automatic send retry, the retry cancels. You must manually send any messages in the Outbox after the soft reset.

Modifying messages in the Outbox

A message in the Outbox waiting for the next automatic send retry can be edited, moved, or deleted. However, if you edit the message, you will need to perform a manual send in order to send the message. If the manual send fails, you can choose to store the message in the Outbox to await the next automatic send retry.

During automatic send retry, any message that the VersaMail application is attempting to send is in a locked state and cannot be edited, moved, or deleted. If you try to modify a message in the locked state, an error message appears.



If a send retry fails after the third attempt, the message is stored in the Outbox in the error state. You can send the message again manually, or edit, move, or delete the message. However, if you edit the message, you will need to perform a manual send in order to send the message. If the manual send fails, you can choose to store the message in the Outbox to await the next automatic send retry.

See “[Outbox icons in the VersaMail applications](#)” later in this chapter for icons that indicate messages awaiting the next automatic send retry as well as messages in the locked and error state.

Outbox icons in the VersaMail applications

The icons to the left of a message in the Outbox indicate the message’s status.



Message is waiting either to be manually sent or to be sent during the next send retry. You can edit, move, or delete a message in this state.



Send retry is currently in process; you cannot edit, move, or delete a message in this state.



Third automatic send retry has failed. You must manually send a message in this state.

Completing drafts

If you are composing an e-mail message and you exit the VersaMail application before tapping Outbox, Send, or Cancel, the e-mail automatically moves to the Drafts folder. To finish editing the e-mail, tap the folders pick list and select Drafts. Select the e-mail you want to complete or edit, and tap Edit. You can also delete the e-mail in the Drafts folder.

Attaching a personal signature

You can include a personal signature, such as your name, e-mail address, and telephone number, with each e-mail you send.

To create a personal signature:

1. Tap the Menu icon 
2. Tap Options
3. Select Preferences.
4. Tap Signature.

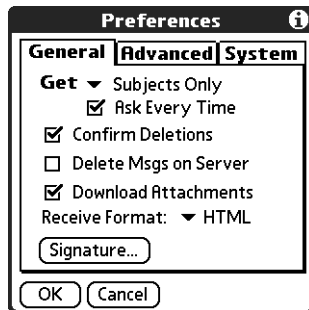

5. Tap the Attach Signature check box to select it.



6. Enter your signature information.
7. Tap OK.

Forwarding e-mail

You can quickly forward e-mail messages from any folder other than the Outbox folder.

To forward e-mail:

1. Tap the folders pick list and select the folder that contains the e-mail.
2. Tap the e-mail message to display it.

3. Tap the Forward button.



Tap Forward

4. Tap To.
5. On the Recipient List screen, enter or look up the recipient address. See the procedure for creating new e-mail earlier in this chapter for more information on addressing messages.

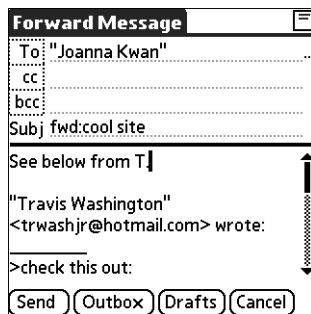

6. (Optional) Enter some text describing the forwarded message.
7. Tap Send to send the message, or tap Outbox to store it in the Outbox.

NOTE Forwarded messages are always sent as text only, even if you received the original message in HTML format.

Replying to e-mail

You can reply to an e-mail as you are reading it, or start the reply when viewing messages in the folders list view.

To reply to an e-mail that you are reading:

1. Tap the e-mail you want to reply to.
2. Tap Reply.



3. In the Reply Options dialog box, select options for replying to the sender only or to all e-mail recipients, and for including original message text.

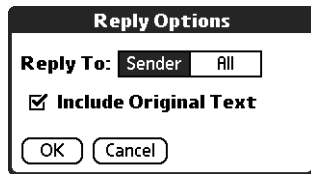

4. Tap OK.
5. Enter a reply.

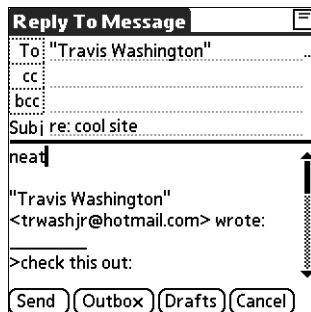

6. Tap Send to send the message, or tap Outbox to send it later.

NOTE Replies are always sent as text only, even if you received the original message in HTML format.



To reply to an e-mail from the folders list:

1. On the message screen, tap the folder name in the upper-left corner to open the message menus, and then press Right on the navigator to move to and open the Options menu.
2. Press Down on the navigator to move to the Reply option, and then press Select to select this option.

TIP Alternately, you can tap the folders pick list, select the folder that contains the e-mail, tap the envelope icon next to the message, and then tap Reply on the pick list.

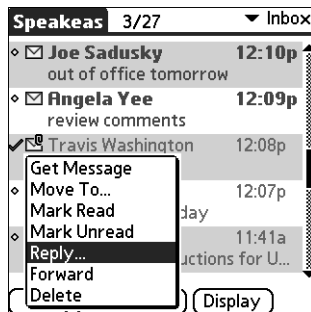

3. In the Reply Options dialog box, select options for replying to the sender only or to all e-mail recipients, and for including original message text.

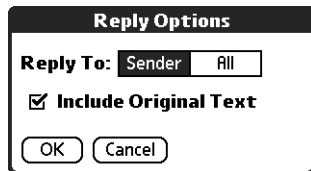

4. Tap OK.
The e-mail is addressed.
5. Enter a reply.

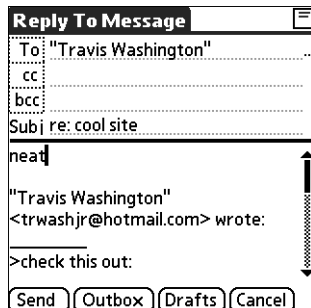

6. Tap Send to send the message, or tap Outbox to send it later.

NOTE Replies are always sent as text only, even if you received the original message in HTML format.

Working with URLs

You can tap on a URL in a received message to view the web page or file associated with the URL. Tapping the URL opens a browser window (using the default browser on your handheld) to view the page or file. This feature only works with certain types of browsers; if you do not have the right type of browser installed on your handheld and set as the default, you cannot open URLs in e-mail messages.

You can also tap an embedded e-mail address to open a new message screen with the address in the To field.

Depending on whether the received message is displayed in HTML or plain text format, URLs and e-mail addresses will appear in slightly different forms, as follows:

- HTML** URLs and e-mail addresses appear as blue underlined text.
- Plain text** URLs appear as any text beginning with "http://" or "www." You cannot view the page or file associated with a URL that does not begin with "http://" or "www" in a plain text message.
- E-mail addresses appear in the form "username@mailservice.com" (or other three-letter extension such as .net, .org, and so on).

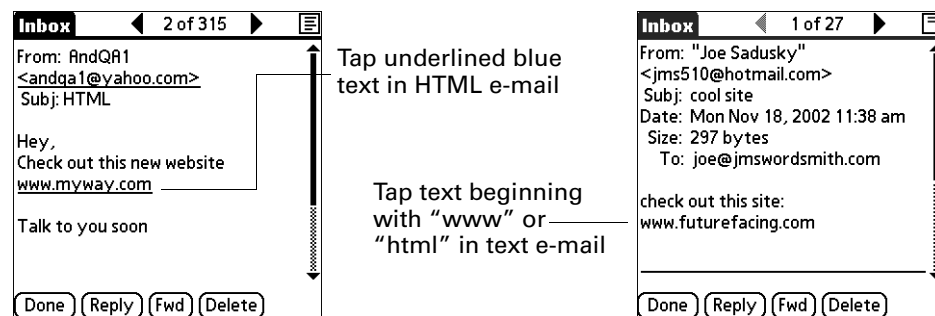

Working with attachments

You can easily download, view, and send attachments with e-mail messages.

Downloading attachments to your handheld

At times e-mail contains attached files, such as Microsoft Word or text files, that you want to view or install on your handheld. You can download and work with the following attached files:

- vCard (.vcf)** This is an address.
- vCal (.vcs)** This is usually a calendar appointment or a To Do task.

Text (.txt)	This is usually a memo or another plain text file.
HTML (.html or .htm)	Usually a web page or a formatted text file. Your handheld displays HTML attachments with full formatting intact.
Microsoft Word (.doc)	The formatting is stripped and the text of most Microsoft Word documents is shown.
JPG (.jpg), bitmap (.bmp), and TIFF (.tif) files	These are graphics files. You can download these files and view them using the Photo Viewer application on your handheld.
Other application files	For other types of application files, your handheld may contain a viewer that allows other applications to pass it a file for viewing. For example, your handheld may contain an image viewer that allows another application to pass it a GIF attachment for viewing. You do not need to do anything different in the steps for downloading and viewing attachments; if your handheld contains such a viewer, the attachment is automatically opened. If your handheld does not contain such a viewer, you cannot view the attachment. Among the file types that may be supported are GIF, MP3, and AAC files. NOTE Your handheld requires an expansion card, sold separately, to store and play MP3 files.
PRC (.prc)	This is a Palm OS® application that you can install and run on your handheld.
PDB (.pdb)	This is a file that works with specific Palm OS applications.

Among the types of attachments you can receive are the following handheld application files:

- Address Book entries
- Date Book appointments
- To Do list items
- Text memos

You can also save downloaded files to an expansion card. See [“Saving attachments to an expansion card”](#) later in this chapter for information.

NOTE The maximum message size that you can retrieve is 60KB for the body text and 2MB total, including attachments. If the attachment is too large, it cannot be downloaded to the handheld.

To download an attachment:

1. In the Inbox, tap the message with the attachment.

A paper clip icon appears on the message's icon if the message has an attachment that has been downloaded.

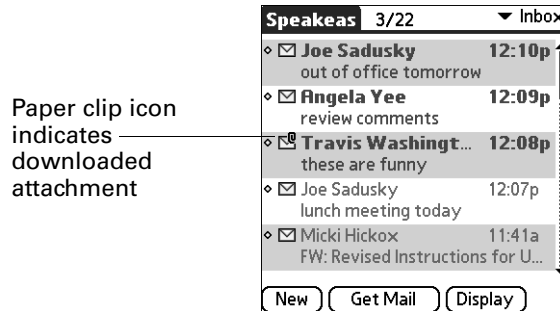

If you choose to get messages by subject only, you must tap More for each downloaded message in order to view the body of the e-mail message plus any attachments, up to the maximum message size. If the downloaded message (either body text alone or body text plus any attachments) exceeds your maximum message size, you see a message showing that the message and/or attachments were too large and asking if you would like to continue downloading them.

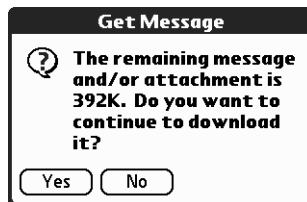

For example, if the maximum message size is 5KB and you download a body of 2KB, then any attachment under 3KB is also downloaded, and any attachment over 3KB is not. See [“Downloading large attachments”](#) later in this chapter.

2. Click the red paper clip icon in the upper-right corner. If the attachment is not downloaded, a paper clip icon will not appear even though the message was sent with an attachment. You must download the attachment for the paper clip icon to appear.

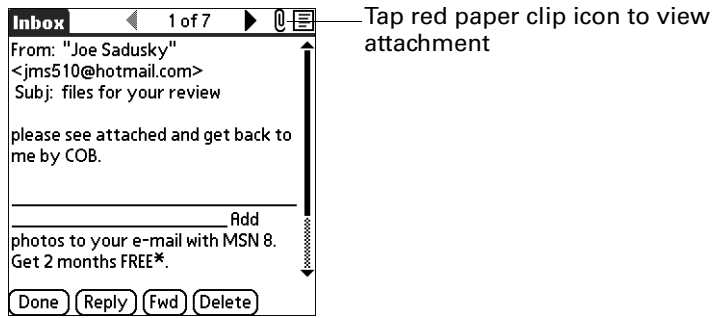

- Your options for working with a downloaded attachment vary according to the file type.

Type	Action
Viewable file: text, Word doc, To Do task, HTML, graphic, and so on	Tap the name of the attachment you want to view, and then tap View. If there are multiple viewers registered on your handheld for the attachment file type, either use the default viewer shown, or select a viewer from the list. For example, if you have two photo viewing applications on your handheld and you select a photo attachment on the list, the Viewer pick list appears containing the names of the photo viewing applications. Tap the pick list and select the application you want to use to view the photo attachment. If there is only one viewer registered for the attachment file type, the viewer is shown without a list.
Palm OS application or database file (.prc or .pdb)	Tap the name of the attachment you want, and then tap Install. The file installs automatically.

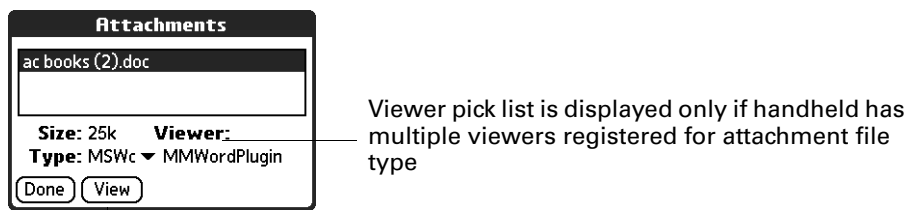

Button displays View or Install, depending on the attachment file type

4. When you have finished viewing or installing the attachment, tap Done. This returns you to the Attachments dialog box, where you can select another attachment if you want to.

If there is no Done button on the attachment screen, tap the VersaMail icon  in the Applications Launcher to return to the Inbox of the account you were in.

5. When you have finished viewing or installing all attachments, tap Done on the Attachments dialog box. This returns you to the Message screen.

Downloading large attachments

Downloading and viewing a message with a single attachment that exceeds your maximum message size, or a message with multiple attachments whose total size exceeds your maximum message size, requires some extra steps.

To determine if a message has an attachment or multiple attachments that exceed the maximum message size:

- In the Inbox, tap the message title.



More button indicates that message plus any attachments exceeds maximum message size

If the message plus attachments exceeds the maximum message size, the More button  appears on the Message screen. In the case of multiple attachments, if some of the attachments were downloaded completely, you see both the red paper clip icon (indicating fully downloaded attachments) and the More button (indicating incompletely downloaded attachments).

To download a single attachment that exceeds the maximum message size:

1. Tap the More button.



Tap More

2. Tap No to stop downloading and return to the Message screen.
Tap Yes to continue downloading the entire message with attachment.

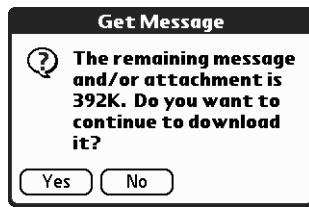

3. (Optional) Tap Cancel to stop downloading and return to the Message screen.
When downloading is complete, the paper clip icon appears and the More button is no longer displayed. Follow the procedure for viewing an attachment presented earlier in this chapter.

To download multiple attachments whose total size exceeds the maximum message size:

1. Tap the red paper clip icon.

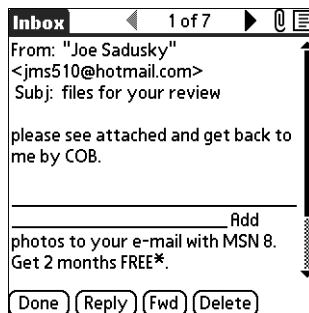

2. Select one of the following:
 - To return to the Message screen, tap Cancel.
 - To view any fully downloaded attachments without continuing to download additional attachments, tap No. Follow the procedure for viewing an attachment presented earlier in this chapter.
 - To continue downloading all messages, tap Yes.

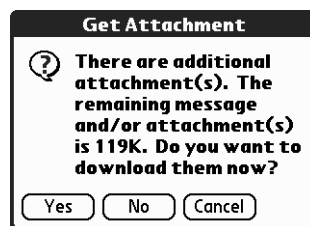

3. (Optional) Tap Cancel to stop downloading and return to the Message screen.

When downloading is complete, the Attachments dialog box appears, showing all downloaded messages. Follow the procedure for viewing an attachment presented earlier in this chapter.

Saving attachments to an expansion card

If you have purchased an expansion card that provides extra memory, you can save downloaded attachments to the expansion card.

To save an attachment to an expansion card:

1. Insert the expansion card into the slot on your handheld.
2. Follow the procedure for downloading attachments described earlier in this chapter.
3. On the Attachments screen, tap Save to Card.

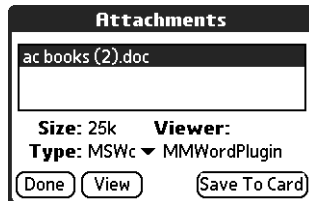

4. Tap OK.

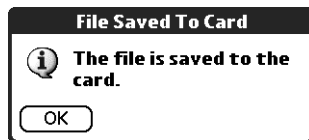

Attaching files from a handheld application

You can attach files on your handheld to e-mail messages you send. For example, you can attach files from the various handheld applications, such as any Date Book appointment (.vcs), To Do List tasks (.vcs), or text memos (.txt).

NOTE The maximum size message you can send is 60KB for the body text and 2MB total, including attachments. The maximum number of attachments for any e-mail is ten, regardless of the attachments' total size.

You can attach the following types of files from a handheld application:

- vCard (.vcf)
- vCal (.vcs)
- Memo/Text (.txt)
- PRC (.prc)
- PDB (.pdb)

To attach a file from a handheld application:

1. Tap the Menu icon .
2. Tap Options.
3. Select Attachment.

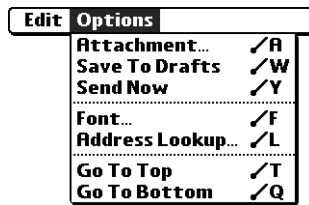

4. Tap the Type pick list and select the file type.

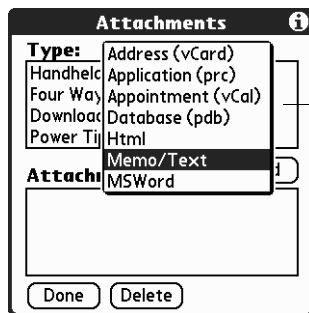

Select type of file you want to attach

All files of the selected type appear in the Type box. For example, if you select Appointments (vCal), tap Date Book to see a list of appointments from a particular date that you can attach, or tap To Do to see To Do List tasks.

5. Tap the file that you want to attach, and then tap Add.



The selected file appears in the Attachments box.

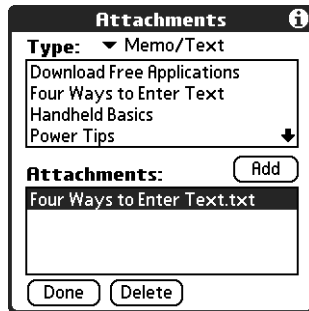

- Repeat steps 2 and 3 for each attachment you want to add, and then tap Done.

TIP To delete an attachment from an e-mail message, tap the attached file in the Attachments box and then tap Delete.

- Tap Send or Outbox.

Attaching files from an expansion card

If you have purchased an expansion card and have saved files to the card, you can attach files from the card to an e-mail message you are sending. The types of files you can attach from an expansion card include the following:

- Word docs
- HTML files
- JPG and GIF graphics files
- MP3 and WAV audio files
- Any other file type

To attach a file from an expansion card:

- Insert the expansion card into the slot on your handheld.
- On the New Message screen, tap the Menu icon .
- Tap Options.
- Tap Add Attachment.

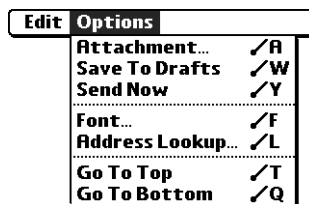

5. Tap the From pick list and select Files on Card.

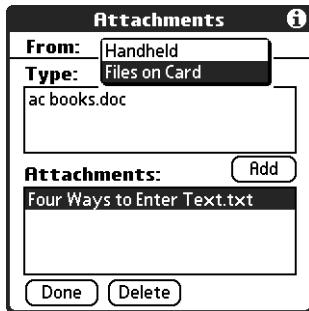

6. Tap the Type pick list and select the file type.

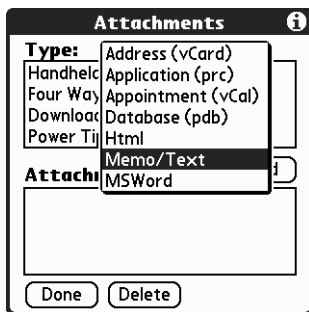

Only file types that correspond to the types of files on the card will be displayed on the list. For example, if the card contains only Word docs and Address Book entries, only the file types “doc” and “vCard” will be listed. You can select a particular file type, or select All Files to view all files on the card.

7. Tap the file that you want to attach, and then tap Add.

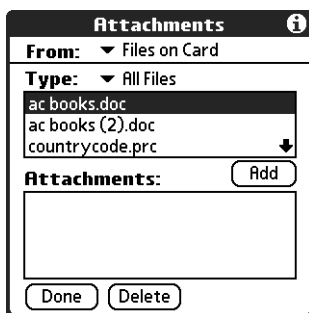

The selected file appears in the Attachments box.

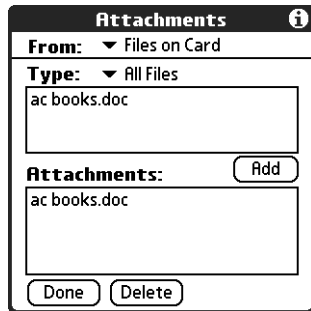

8. Repeat steps 6 and 7 for each attachment you want to add, and then tap Done.

TIP To delete an attachment from an e-mail message, tap the attached file in the Attachments box and then tap Delete.

9. Tap Send or Outbox.

Forwarding an attachment

You can include an attachment on any message you forward, up to the maximum message size.

To forward a message with an attachment:

1. Tap the folders pick list and select the folder that contains the e-mail.
2. Tap the e-mail message to display it.
3. Tap the Forward button.
4. Tap the word To. On the Recipient List screen, enter or look up the recipient address. See the procedure for creating e-mail earlier in this chapter for more information on addressing messages.
5. Follow the procedure for attaching files presented earlier in this chapter.

Deleting messages

You can delete one or more e-mail messages from any folder. For example, you can delete old messages in the Inbox or messages that you were working on in the Drafts folder. When you delete a message, it is placed in the Trash folder. See [“Emptying the trash”](#) later in this chapter.

To delete messages on the server when you empty the trash on your handheld, you can select the Delete Msgs on Server setting in VersaMail Preferences. If you don't periodically empty the trash and delete messages on the server, any incoming e-mail may “bounce” back to the sender. See [“Setting preferences for getting and deleting e-mail”](#) later in this chapter.

To delete one or more messages:

1. Tap the folders pick list and select the folder that contains the message you want to delete.
2. Do one of the following:

Item to delete	Action
One message	Tap the bullet next to the message's icon.
Multiple messages	Tap the bullet next to the icon of each message that you want to delete.
A group of adjacent messages	Drag the stylus along the left of the message icons. To select another group, lift the stylus and select the next group of messages.

3. Press Right on the navigator to move to and open the Message menu.
4. Press Down on the navigator to move to the Delete option, and then press Select to delete the message.

TIP Alternately, you can tap the message icon next to a selected e-mail message and then tap Delete, or tap the Menu icon  and then select Delete.



5. Tap OK.
6. (Optional) Tap Also delete message(s) on server if you want to delete the message from the server now.



If you selected the setting Delete Msgs on Server in VersaMail Preferences, this check box is selected

The selected messages move to the Trash folder and are deleted from your handheld when you empty the trash. If you set the preference to automatically empty the trash, the messages are deleted when the trash is emptied. By default,

the trash auto-empties all deleted e-mail older than one week. See [“Emptying the trash”](#) later in this chapter for more information.

IMPORTANT If you delete a message on the server, you cannot retrieve it and view it again later.

To delete messages before a certain date:

1. Tap the Menu icon , and then select Delete Old from the Message menu.

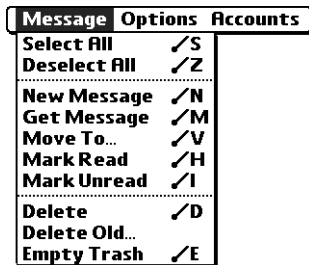

2. Tap the Folder pick list and select the folder that contains the messages you want to delete.

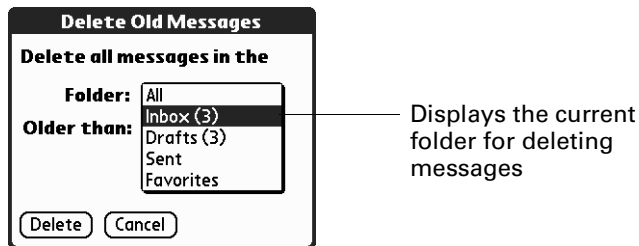

3. Tap the Older than pick list, and then tap One Week, One Month, or Choose Date.



If you tap Choose Date, you can select a date from the calendar.

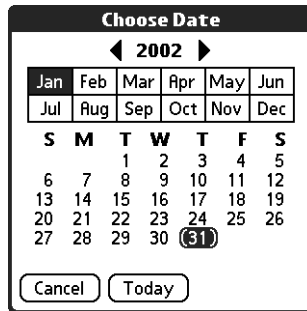

Tap a date to select it,
or tap Today

4. Tap Delete.
5. (Optional) Tap Also delete message(s) on server if you want to delete the message from the server now.



6. Tap OK.

Emptying the trash

Deleted e-mail accumulates in the Trash folder and takes up space on your handheld. To increase memory, you should empty the trash regularly. If you want to automatically empty the trash, you can set a preference to empty the trash immediately or empty any e-mail older than a certain number of days.

To empty the trash:

1. Tap the Menu icon , and then select Empty Trash from the Message menu.



NOTE If Auto-Empty Mail from Trash is selected in VersaMail Preferences, a message asks if you want to delete the trash.

- (Optional) Tap Details to see how many messages are in the trash and whether the messages are set to be deleted on the server.



- If you want to delete messages from the handheld as well as from the server, tap Both. A message asks if you want to update the server now.

To delete the message from only the handheld now, tap Handheld.

NOTE Many e-mail providers, such as Yahoo, have size restrictions for mail storage. If your mailbox on the server becomes full, messages are returned to the senders.

To have the trash emptied automatically:

- Tap the Menu icon , tap Options, and then select Preferences.
- Tap Advanced.

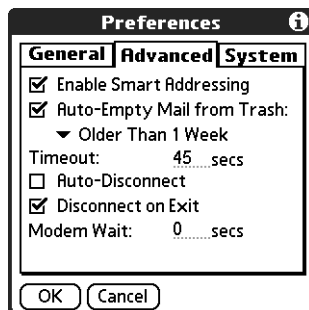

By default, Auto-Empty Mail from Trash is selected, and the time interval is set at Older Than 1 Week.

- Tap the pick list, and select how often you want the e-mail messages automatically emptied from the trash.
 - Immediately
 - Older Than 1 Day
 - Older Than 3 Days
 - Older Than 1 Week
 - Older Than 1 Month
- Tap OK.

Marking messages as read or unread

You can mark messages as read or unread. When you tap a message to read it, it is automatically marked as read.

To mark messages as read or unread:

1. Tap the folders pick list and select the folder you want.
2. Tap the icon next to the message you want to mark.
3. Tap Mark Read or tap Mark Unread.

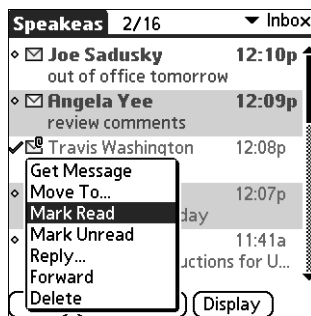

TIP To mark multiple messages, tap the bullets next to the messages you want, tap the Menu icon , and then select Mark Read or Mark Unread.



4. For IMAP accounts only: Tap Handheld to mark the messages as read or unread on your handheld. Tap Both to mark the messages on both the handheld and the server.



If you tap Both, this message appears.



Tap OK to connect with the server and immediately mark the messages as read or unread on the server. This action also processes any other pending actions on the server, such as messages not yet deleted.

Tap Cancel if you want the messages marked during the next HotSync operation or the next time you connect to the server.

NOTE Because POP servers do not support the read or unread message feature, the message is in bold or regular typeface for POP accounts on the handheld, but you can't connect with the server to change the message state.

Read messages appear in plain text; unread messages appear in bold text.

Setting preferences for getting and deleting e-mail

VersaMail Preferences determine how the VersaMail application gets, sends, and deletes e-mail.

To set e-mail preferences:

1. Tap the Menu icon , tap Options, and then select Preferences.

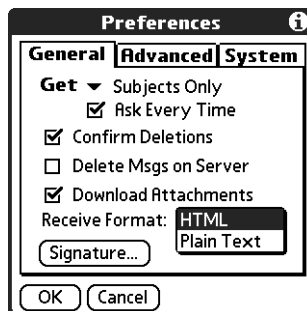

2. Select preferences:

Get Enables you to retrieve the subject only or the entire message.

Ask Every Time Displays a dialog box for choosing subjects only or entire messages each time you retrieve e-mail. If deselected, messages are retrieved according to the option you select in the Get pick list.

Confirm Deletions	Displays a confirmation dialog before deleting e-mail.
Delete Msgs on Server	If selected, automatically deletes messages on the server that you have deleted on your handheld. If not selected, you will be asked each time you delete messages on your handheld whether you want to also delete them on the server. Because mailboxes on the server usually have size restrictions, we recommend periodically deleting messages on the server.
Download Attachments	Causes files attached to e-mail to be automatically downloaded to your handheld. Attachments that exceed the maximum message size cannot be downloaded. See “Working with attachments” earlier in this chapter for more information.
Receive Format	Enables you to retrieve messages in HTML format or in plain text format. If you choose HTML, any messages sent to you in HTML format will be displayed with basic HTML formatting intact. Other messages will be displayed as plain text. If you choose Plain Text, all messages will be displayed as plain text, regardless of the format in which they were sent. Default setting is HTML. See “Working with URLs” earlier in this chapter for more information on receiving e-mail in HTML format.
Signature	Enables you to attach a default signature to all your outgoing messages. See “Attaching a personal signature” earlier in this chapter for more information.

Adding or updating an Address Book entry directly from a message

You can add or update an e-mail address in the Address Book directly from the body of a received e-mail message.

To add a new Address Book entry:

1. On the Message screen, tap the Menu icon , tap Options, and then select Add to Address Book.

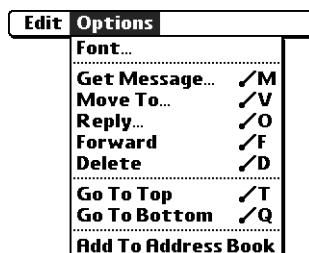

A dialog box appears with the “From” address displayed. If a Display Name exists for this Address Book entry, the Last name and First name fields show the display name.

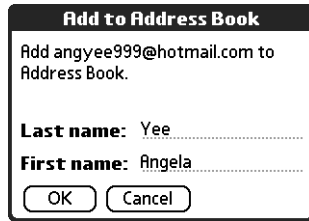

Add to Address Book

Add angyee999@hotmail.com to Address Book.

Last name: Yee

First name: Angela

OK Cancel

2. (Optional) If the Last name and First name fields are blank, enter the first and last name associated with the “From” e-mail address.
3. Tap OK to add the e-mail address to the Address Book, and then tap OK in the confirmation dialog box.

You can also update an existing Address Book entry with a new e-mail address, or create a second Address Book entry for a name that has an existing record. The procedure is the same as for adding a new Address Book entry. If you tap Add to Address Book from the body of an e-mail message and a record already exists for the recipient name, you are prompted either to update the e-mail address for the recipient or to create a new record for the recipient.

Synchronizing e-mail between the handheld and the desktop

IMPORTANT You must have a Windows computer to synchronize e-mail between your handheld and your computer.

To manage your e-mail on your desktop as well as on your handheld, you can synchronize an e-mail account on the handheld with an e-mail application on the desktop. You can use many popular e-mail applications, called *clients*, such as Microsoft Outlook, Eudora, Lotus Notes, Outlook Express, or any other e-mail clients that use MAPI.

This chapter describes the following:

- Starting the Palm VersaMail HotSync Conduit
- Configuring and activating accounts in the HotSync Manager
- Synchronizing e-mail on the handheld with a desktop e-mail application
- Converting attached files using attachment conversion plug-ins

Configuring an account in HotSync Manager

Before synchronizing an e-mail account, you configure the account's settings in the Palm VersaMail HotSync Conduit. The settings have to be specified only once unless you need to make changes.

To start Palm VersaMail HotSync Conduit:

1. Click the HotSync Manager icon  in the Windows system tray.
2. Select Custom.
3. Select VersaMail in the Conduit list.

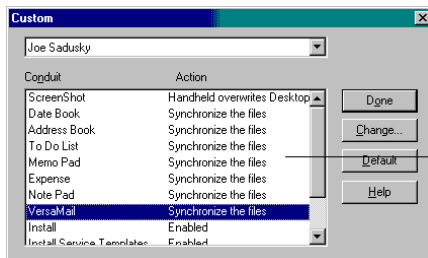

4. Click Change.
5. Select Synchronize Active Accounts.

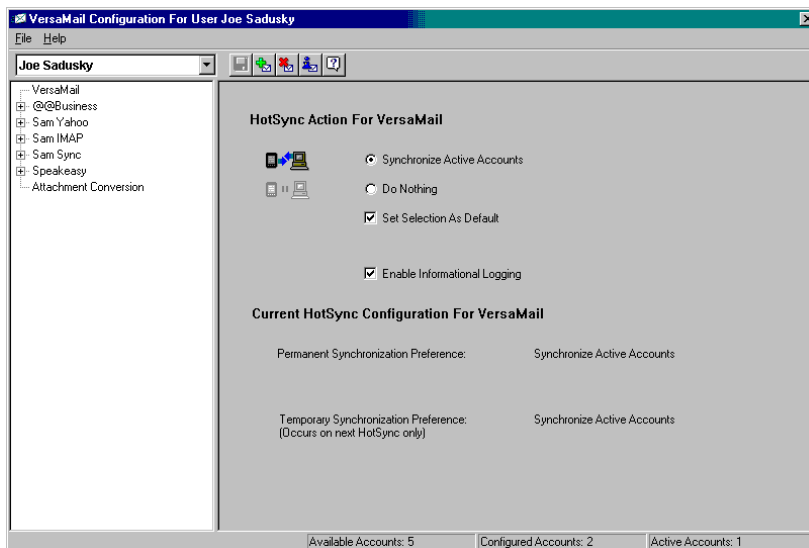

6. (Optional) Select the check box Enable Informational Logging if you want the HotSync log to record information, such as errors encountered, about the conduit during a HotSync operation.
7. (Optional) Select the check box Set Selection As Default to make the current settings the default settings for all accounts.

Setting synchronization options and account settings

Next, you must configure each e-mail account's general synchronization settings. For example, if you created an Earthlink e-mail account on the handheld and want to synchronize that with the desktop, set the synchronization options for the Earthlink account. During a HotSync operation, the Earthlink account on the handheld and the e-mail application specified in the conduit are synchronized.

To configure an account and set the synchronization options:

1. On the VersaMail Configuration For User ... screen, click the plus sign to the left of the account you want to configure.

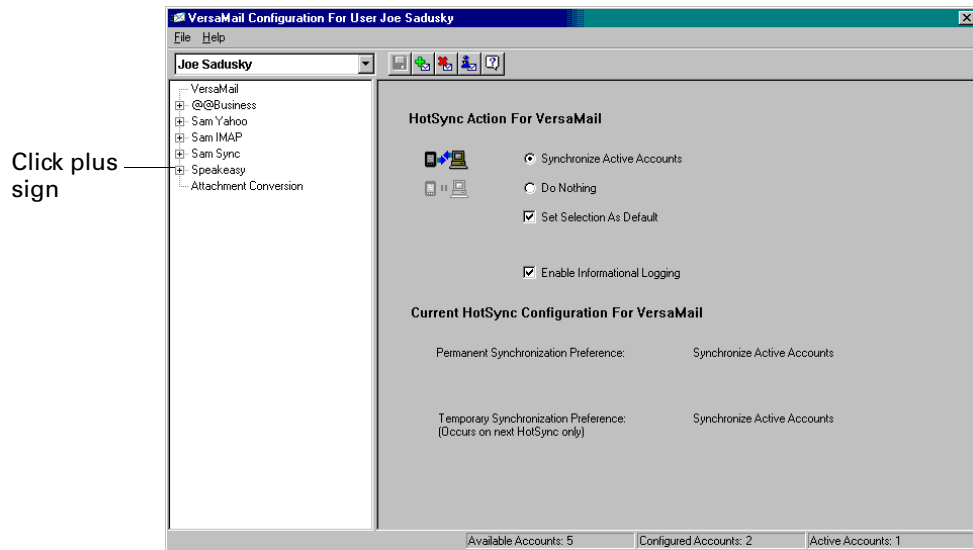

2. Under the account name, click Mail Client Sync Setup.

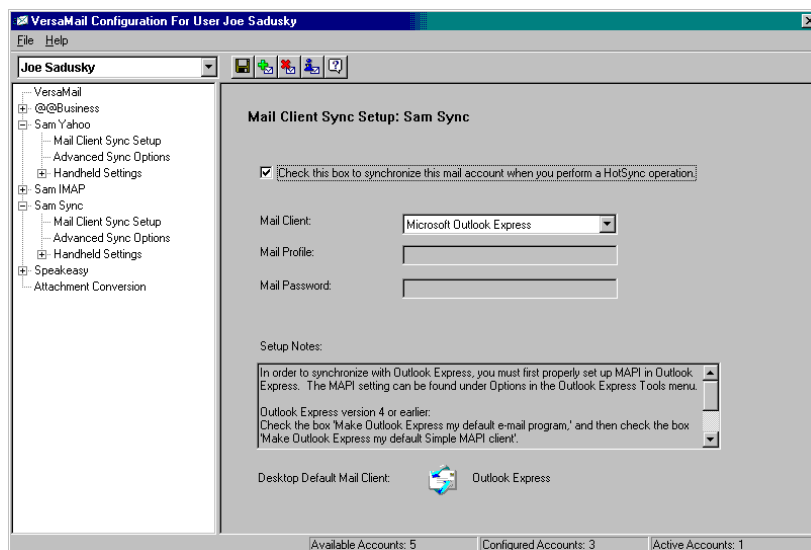

3. Select the option Check this box to synchronize this mail account when you perform a HotSync operation; otherwise, the account cannot be synchronized.
4. Click the Mail Client pick list and select the desktop e-mail application you will use to synchronize the selected account with your handheld. For each application, additional setup information is displayed in the Setup Notes box. See the following table for additional setup information for each client.

TIP If your e-mail application is compatible with Extended MAPI, try Microsoft Exchange 5.0 or later as a choice for the Mail Client option. If your e-mail application is compatible with Simple MAPI (SMAPI), try Microsoft Outlook Express as a choice for the Mail Client option. Although Netscape uses SMAPI, Netscape is not supported.

(Optional) If prompted, enter profile and password information for the client you selected.

IMPORTANT You must select the synchronize check box and select a mail client in order to synchronize the account between your desktop and your handheld.

Mail Client	Action
Microsoft Exchange 5.0 or later	Select a MAPI profile to access the mail server. The conduit displays any existing MAPI profiles in the list. Enter your password for Exchange.
Microsoft Outlook 97 or later	Select the MAPI profile to access the mail server. The conduit checks for any existing MAPI profiles and displays them in the list. Enter your password for Outlook. See “Configuring Microsoft Outlook” later in this chapter for the changes you need to make in Outlook.
Microsoft Outlook Express 5.5 or later	If you select Microsoft Outlook Express, enter the password for your e-mail account. See “Configuring Microsoft Outlook Express” later in this chapter for details.

Mail Client	Action
Lotus Notes	<p data-bbox="630 285 1422 348">Enter your Lotus Notes ID and password. Click Browse if you need to locate your Notes ID.</p> <p data-bbox="630 359 1422 485">If you want to synchronize to a local mail file instead of a server mail file, select the Synchronize to local (replicated) mail file check box. You must do all of the following in order to synchronize to a local mail file:</p> <ul data-bbox="630 495 1422 747" style="list-style-type: none"><li data-bbox="630 495 1422 527">■ Replicate the server mail file to the desktop.<li data-bbox="630 537 1422 600">■ Make sure the replicated mail file is in the Notes data directory.<li data-bbox="630 611 1422 747">■ If you have performed a custom Notes installation and have replicated the server mail file to another directory on your desktop, make sure that it is the path found in the notes.ini file.
Eudora 5.0 or later	<p data-bbox="630 779 1422 842">See “Configuring Eudora” later in this chapter for more information about the settings to make in Eudora.</p>
Direct POP connection to server	<p data-bbox="630 873 1422 1188">Select this option to synchronize an account by connecting directly with a POP server. You must enter the information about the server in the VersaMail application on your handheld when you create the e-mail account to access the server. You will enter information about the incoming (POP) server, the outgoing (SMTP) server, your e-mail username, your password, and your e-mail address. You can change these settings under Handheld Settings in the conduit; see the procedure for setting handheld synchronization settings later in this chapter.</p> <p data-bbox="630 1199 1422 1482">During the HotSync operation, the conduit reads the settings you made. If the settings do not exist or all server information is wrong, an error is reported in the HotSync.log file. However, if the incoming server (POP) is correct, the Inbox is synchronized if the option to synchronize the Inbox is selected. If the outgoing server (SMTP) is correct, the Outbox is synchronized (send e-mail) if you selected the option to synchronize the Outbox. If neither is correct, then nothing happens.</p> <p data-bbox="630 1514 1422 1640">If you want to synchronize e-mail for an account that requires APOP authentication, you must select the option to use APOP on your handheld. See “Adding APOP to an account” later in this chapter for details.</p> <p data-bbox="630 1650 1422 1808">If you want to synchronize e-mail for an account that requires ESMTP authentication (for example, Yahoo accounts require ESMTP authentication), you must select the option to use ESMTP on your handheld. See “Adding ESMTP to an account” later in this chapter for details.</p> <p data-bbox="630 1818 1422 1873">The conduit does not support SSL for accounts set up as direct POP.</p>

Mail Client	Action
Direct IMAP connection to server	<p>Select this option to synchronize an account by connecting directly with an IMAP server. You must enter the information about the server in the VersaMail application on your handheld when you create the e-mail account to access the server. You will enter information about the incoming (IMAP) server, the outgoing (SMTP) server, your e-mail username, your password, and your e-mail address. You can change these settings under Handheld Settings in the conduit; see the procedure for setting handheld synchronization settings later in this chapter.</p> <p>During the HotSync operation, the conduit reads the settings you made. If the settings do not exist or all server information is wrong, an error is reported in the HotSync.log file. However, if the incoming server (IMAP) is correct, the Inbox is synchronized if the option to synchronize the Inbox is selected. If the outgoing server (SMTP) is correct, the Outbox is synchronized (send e-mail) if you selected the option to synchronize the Outbox. If neither is correct, then nothing happens.</p> <p>If you want to synchronize e-mail for an account that requires ESMTP authentication (for example, Yahoo accounts require ESMTP authentication), you must select the option to use ESMTP on your handheld. See “Adding ESMTP to an account” later in this chapter for details.</p> <p>The conduit does not support SSL for accounts set up as direct IMAP.</p>
Other e-mail applications	<p>Select Microsoft Exchange 5.0 or later as a choice for the Mail Client option if your e-mail application is compatible with extended MAPI. If your e-mail application is compatible with SMAIL, select Microsoft Outlook Express as a choice for the Mail Client option.</p>

NOTE A profile contains configuration information, such as the location of incoming e-mail, your personal address book, and other information services that you can use. The profile may be MS Exchange Settings, your name, or something different. For more information on profiles, see your e-mail application’s documentation.

- Under the account name, click Advanced Sync Options.

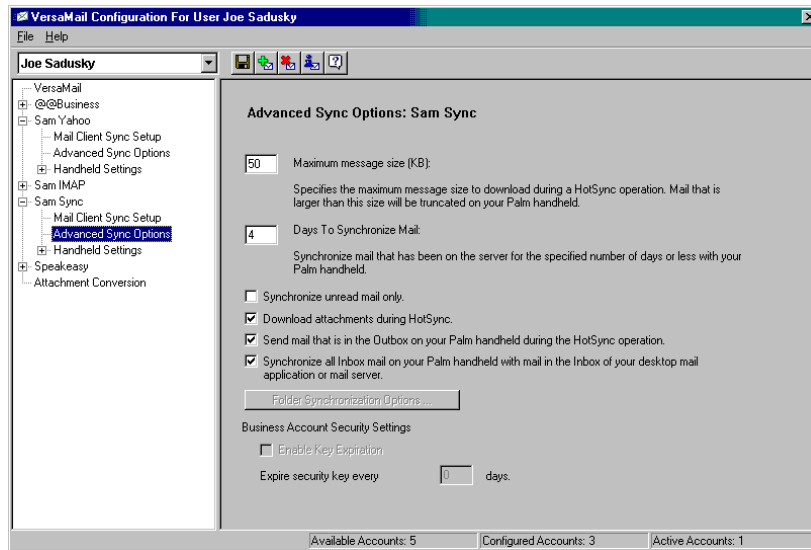

- Enter the synchronization options you want:

Maximum message size (KB)

Enter the maximum message size from 1 to 2048KB. If the message exceeds the maximum size, the conduit truncates the message. For example, the maximum message size might be 50KB, and the message might have the following:

- Message header: 1KB
- Body: 20KB
- Attachment: 140KB
- Attachment: 20KB

In this case the conduit puts the message header, body, and attachment 2—totaling 41KB—on the handheld. Attachment 1 is removed because adding it to the message causes the message to exceed the maximum.

Days To Synchronize Mail

Set how many days of e-mail, between 0 and 999, that e-mail should be synchronized. A value of 0 synchronizes all e-mail in the Inbox during the next HotSync operation. For other values, the conduit synchronizes e-mail for today and the number of days preceding today. For example, if you enter a value of 2, e-mail is synchronized for today and yesterday, but if you enter 3, e-mail is synchronized for today, yesterday, and the day before.

Synchronize unread mail only Select whether to synchronize all e-mail between your desktop and your handheld, or unread e-mail only. By default, the check box is unselected, meaning that all e-mail will be synchronized.

Download attachments Select whether to download attachments during synchronization. By default, the check box is selected; if unselected, only the body text of any message containing an attachment will be downloaded to your handheld during synchronization.

Send e-mail from Outbox Select the check box to send any e-mail in the handheld's Outbox during the next HotSync operation.

Synchronize incoming e-mail Select the check box to synchronize the Inbox during the next HotSync operation.

7. (Optional) If you chose Microsoft Outlook, Microsoft Exchange, Lotus Notes, or Direct IMAP as your mail client, click Folder Synchronization Options.

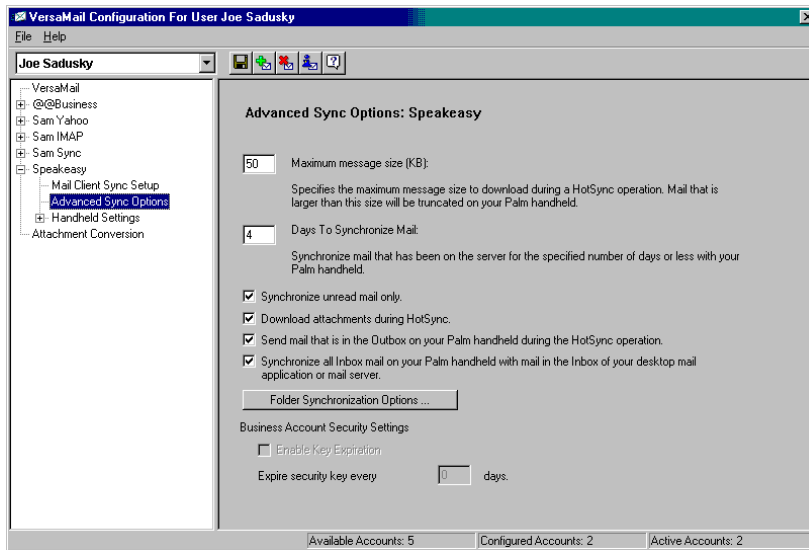

Set folder synchronization options as follows:

- Click the name of the folder you want.



- Click in the Synchronize column to the right of the folder name.
- Click the arrow to open the drop-down list, and click Yes or No to synchronize the folder or not.

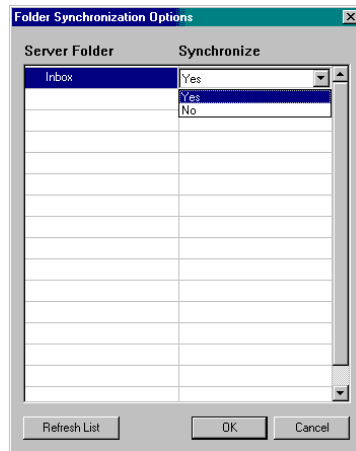

8. Click OK.

You can now set synchronization options for your handheld for the selected account.

To set handheld synchronization settings:

1. Under the selected account name, click the plus sign to the left of Handheld Settings.

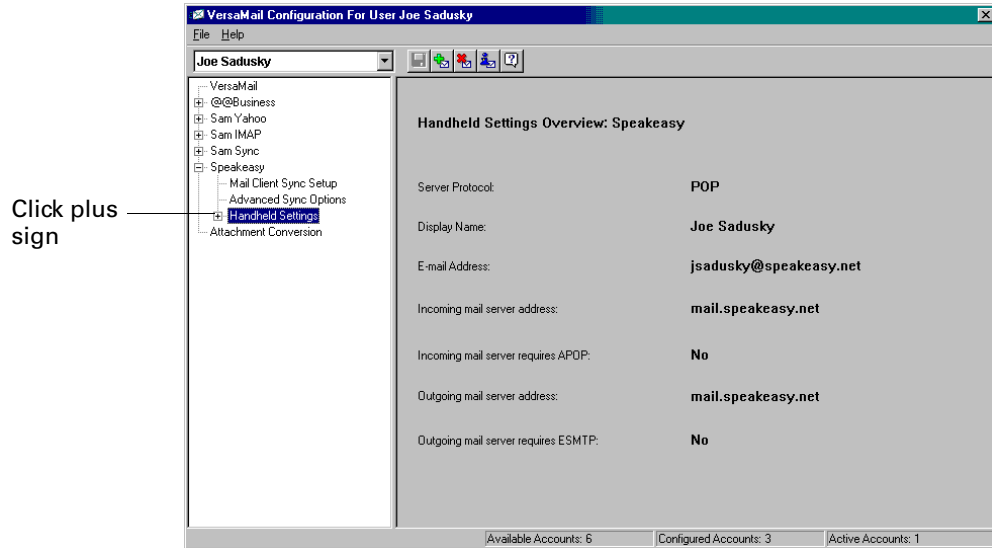

2. Click Account Information.

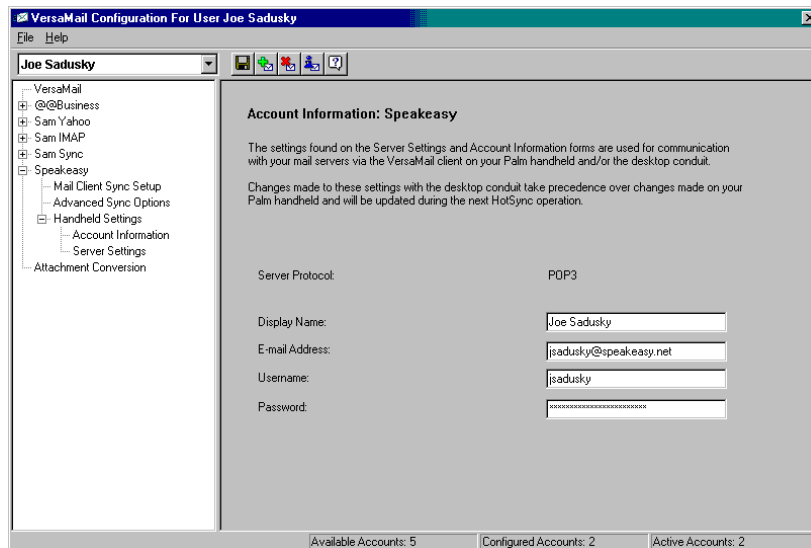

3. If you are using an account that is already configured on your handheld, the account information will already be entered. If not, enter the following:

NOTE You do not need to fill in these fields if the account is a synchronize-only account and the mail client is *not* Direct POP or Direct IMAP.

- Display Name** Enter the name you want to appear on your outgoing messages, such as "Joe Smith".
- E-mail Address** Enter the e-mail address of the account you are accessing, such as `examplename@yahoo.com`.
- Username** Enter the username you use to access your e-mail. This is generally the part of your e-mail address appearing before the @ symbol; it is usually not your entire e-mail address.
- Password** Enter the password for this account.

4. Under Handheld Settings, click Server Settings.

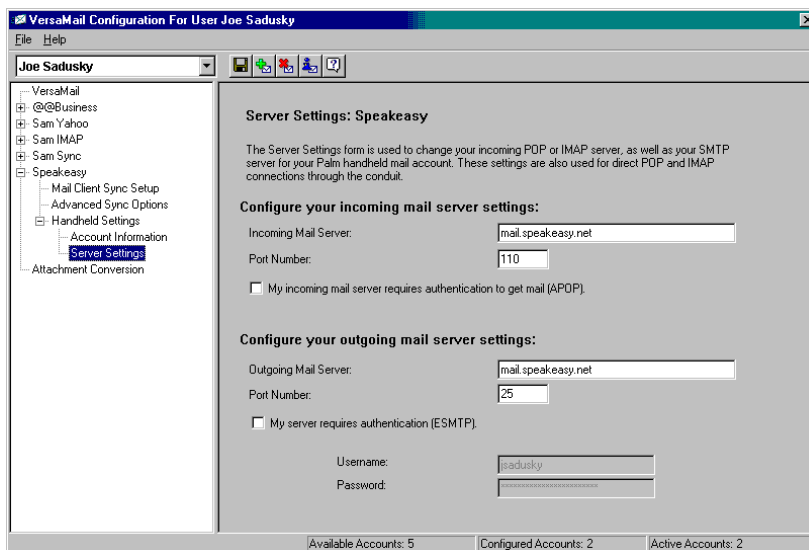

5. If you are using an account that is already configured on your handheld, the account information will already be entered. If not, enter the following:

NOTE You do not need to fill in these fields if the account is a synchronize-only account and the mail client is *not* Direct POP or Direct IMAP.

Incoming Mail Server	Enter the name of your incoming (POP) mail server, such as pop.mail.yahoo.com.
Incoming Mail Server Port Number	The default is 110 for POP and 143 for IMAP servers, respectively. If you are not sure about the correct port number, check with your mail server administrator.
Whether this account requires APOP authentication (POP accounts only)	Selecting this check box encrypts your username and password when traveling over the network. Some services require APOP to work properly, while others do not work properly if APOP is used. If you aren't sure if your ISP or web e-mail provider supports APOP, check with your e-mail provider. See " Adding APOP to an account " later in this chapter for information.
Outgoing Mail Server	Enter the name of your outgoing (SMTP) mail server, such as smtp.mail.yahoo.com.
Outgoing Mail Server Port Number	The default is 25, the port number most SMTP servers use. If you are not sure about the correct port number, check with your mail server administrator.
Whether this account requires ESMTP authentication	<p>Select this check box if the outgoing server (SMTP) requires authentication. Check with your system administrator before selecting this option. See "Adding ESMTP to an account" later in this chapter for information. If you select this option, username and password fields appear. These fields are prepopulated based on the account information you entered previously. In most cases, the prepopulated information is correct; however, occasionally your authentication username and/or password is different from your account username or password. Check with your e-mail service provider for authentication username and password information.</p> <p>If you need to enter new information, enter a username and/or tap the Password box and enter a password, and then tap OK.</p>

6. Click the Save icon  on the toolbar to save the settings for this account.

Account information screens

Two screens in the Palm VersaMail HotSync Conduit provide summary information on your accounts:

- The Account Overview screen indicates whether the account is active; whether the account has been synchronized and, if so, the last synchronization date; the mail client for this account; and whether the mail client and/or the incoming mail server has been changed since the last HotSync operation.

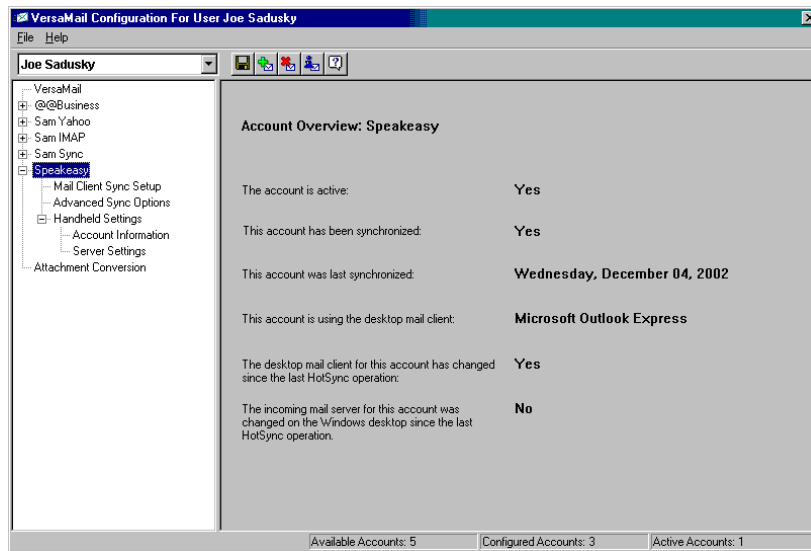

- The Handheld Settings Overview screen lists the server protocol, display name, e-mail address, incoming and outgoing mail server addresses, and whether APOP or ESMTP authentication is required.

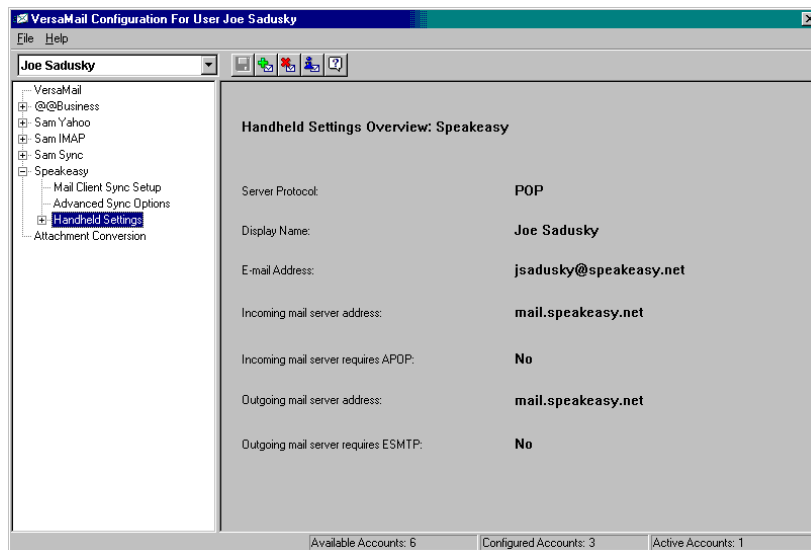

To view the Account Overview screen:





- Click the selected account name.

To view the Handheld Settings Overview screen:

- Under the selected account name, click Handheld Settings.

Palm VersaMail HotSync Conduit shortcuts

You can use the icons in the toolbar to perform certain tasks quickly, such as saving account configuration settings.

Icon	Action
	Save account settings. Saves any changes you have made to an account.
	Add a new account. You are prompted to enter the account name and protocol.
	Delete an account. You are prompted to select the account to delete from a drop-down list.
	Quick Account Reference. Lists all accounts and shows whether they are active and the date they were last synchronized.
	Help. Displays the Help window with complete online help.

Verifying handheld account settings before synchronizing accounts

Certain settings you configure on your handheld for a given e-mail account must be set correctly for the synchronization process as well. Before configuring an e-mail client on your desktop for synchronization, be sure to verify the following settings on your handheld:

- **APOP, ESMTP, and SSL:** If you want to synchronize e-mail for an account that requires either APOP or ESMTP authentication (for example, Yahoo accounts require ESMTP authentication) or a secure (SSL) connection for incoming mail, you must select the option to use APOP, ESMTP, or a secure connection on your handheld. See [“Adding APOP to an account,”](#) [“Adding ESMTP to an account,”](#) and [“Using Secure Sockets Layer \(SSL\)”](#) later in this chapter for details.
- **Mail filters:** Any mail filters you have configured for a given e-mail account on your handheld also apply during the synchronization process. For example, if you have set filters to accept only e-mail containing the subject words “Current Software Project,” only those same messages are synchronized between your desktop and your handheld. Be sure to turn mail filters off if you want to synchronize all messages between your desktop and your handheld. See [“Turning filters on and off”](#) later in this chapter for details.

Configuring Microsoft Outlook

You can synchronize Microsoft Outlook 97/98/2000/XP with a VersaMail e-mail account, but you must set Microsoft Outlook as the default e-mail handler. You must check your username and password.

To configure Microsoft Outlook:

1. In the Control Panel, click Internet Options.

NOTE For Windows XP, click Network and Internet Connections, and then click Internet Options.

2. Click the Programs tab.
3. Select Microsoft Outlook as the default e-mail program.
4. Click OK.

NOTE Make sure your username and password are set up correctly within Microsoft Outlook.

Configuring Microsoft Outlook Express

You can synchronize a VersaMail e-mail account with Microsoft Outlook Express 5.5 or 6.0, but you must set Outlook Express as the default e-mail handler.

NOTE Make sure your username and password are set up correctly within Outlook Express.

To configure Outlook Express:

1. In the Control Panel, click Internet Options.

NOTE For Windows XP, click Network and Internet Connections, and then click Internet Options.

2. Click the Programs tab.
3. Select Outlook Express as the default e-mail program.
4. Click OK.

TIP You can also make Outlook Express the default e-mail handler within the e-mail application. From the Tools menu, select Options. Click the General tab, and then click Make Default.

Configuring Eudora

If you are using Eudora as your e-mail application, you must set up MAPI in Eudora.

To set up MAPI in Eudora:

1. From the Eudora Tools menu, select Options.
2. Do one of the following:
 - If Eudora is the only e-mail application that you use, select Always as the MAPI setting.
 - If you use more than one e-mail application, select When Eudora is running as the MAPI setting.
3. Ensure that your username and password are set up correctly within Eudora. This information is needed to log in to Eudora to retrieve and synchronize your e-mail.

IMPORTANT Eudora must be running in order for you to perform a HotSync operation. The VersaMail application synchronizes with your Dominant Personality in Eudora 5.1 or later.

Converting attached files

You can use attachment conversion plug-ins to convert attached files that you are receiving. DataViz Documents To Go plug-ins enable you to convert attachments using HotSync operations. With Documents To Go, you can view, create and edit Word, Excel, and PowerPoint attachments on your handheld. DataViz Documents To Go version 5 is included on the Palm™ Desktop software that came with your handheld. You must install the software and perform a HotSync operation in order to use Documents To Go. See the *Documents To Go Getting Started Manual* for more information.

When you receive a message with an attachment on your handheld, the file is converted to the DataViz format on the handheld when you perform a HotSync operation. You can then read and edit the file in Documents To Go on the handheld.

In the Palm VersaMail HotSync Conduit, you can turn off DataViz Documents To Go plug-ins or select other plug-ins.

To turn off attachment conversion plug-ins:

1. Click the HotSync Manager icon  in the Windows system tray.
2. Select Custom.

3. Select VersaMail in the Conduit list.

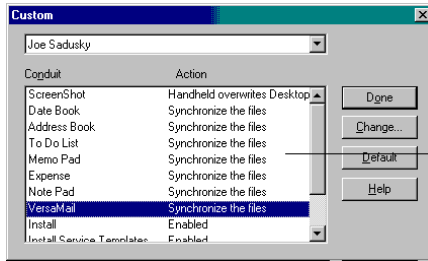

4. Click Attachment Conversion.

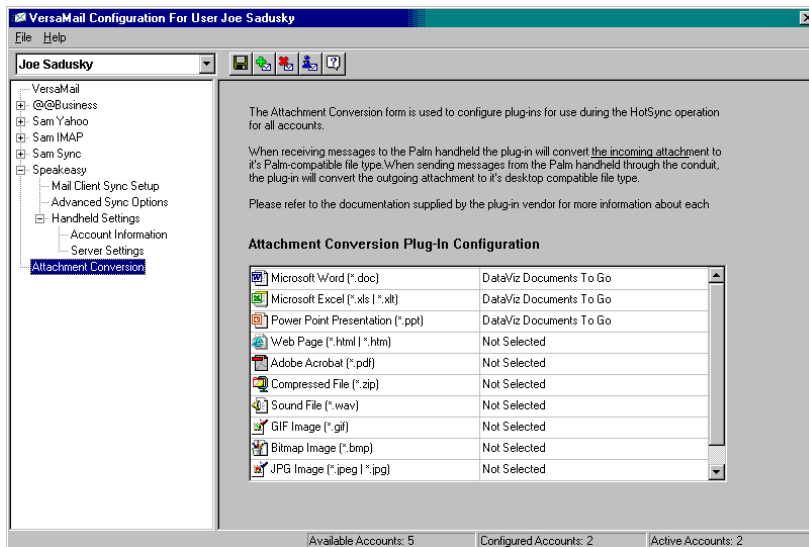

5. Plug-in types are listed in the left column. If the plug-in is selected, the right column shows the name of the company supplying the plug-in. If a plug-in is not selected, the right column reads Not Selected.

NOTE The drop-down lists in the right column display only the companies currently supplying plug-ins for a particular type. If more than one company supplies a plug-in of a particular type (for example, Word doc), then multiple company names appear on the list. If no company is currently supplying a plug-in of a particular type, then the only option that appears on the list is Not Selected.

Do one of the following:

Item	Action
To deselect a plug-in	Click the right column next to the plug-in type name, and then select Not Selected from the drop-down list.
To select a plug-in	Click the right column next to the plug-in type name, and then select the name of the company supplying the plug-in from the drop-down list.
To change the company supplying a plug-in of a particular type	Click the right column next to the plug-in type name, and then select the name of the company you want to supply the plug-in from the drop-down list.

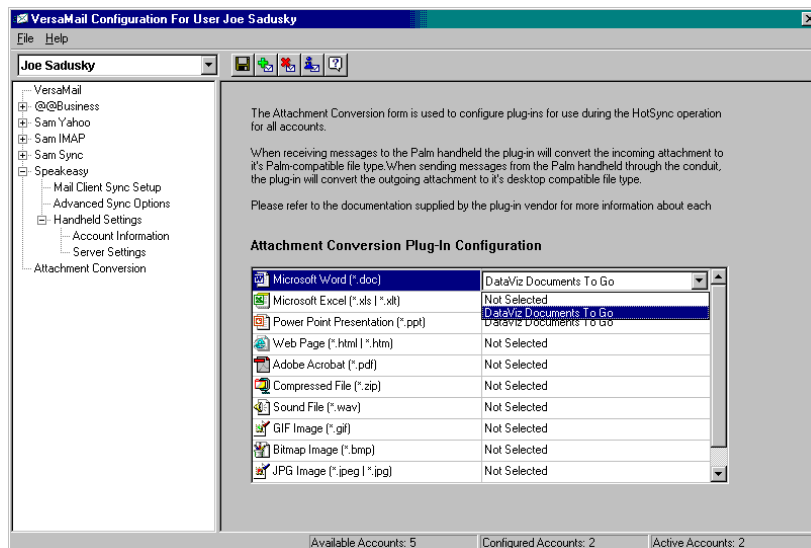

6. Click save.

Synchronizing an account

To synchronize accounts, you must set the HotSync action for the VersaMail application in the HotSync Manager. You can, however, exclude e-mail accounts from a HotSync operation.

TIP If you don't want an account synchronized, deselect the check box Select this check box to synchronize this e-mail account when you perform a HotSync operation.

To select which accounts are synchronized during a HotSync operation:

1. Click the HotSync Manager icon  in the Windows system tray.
2. Select Custom.

3. Select VersaMail in the Conduit list.

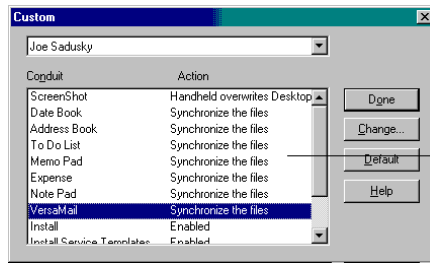

4. Click Change.

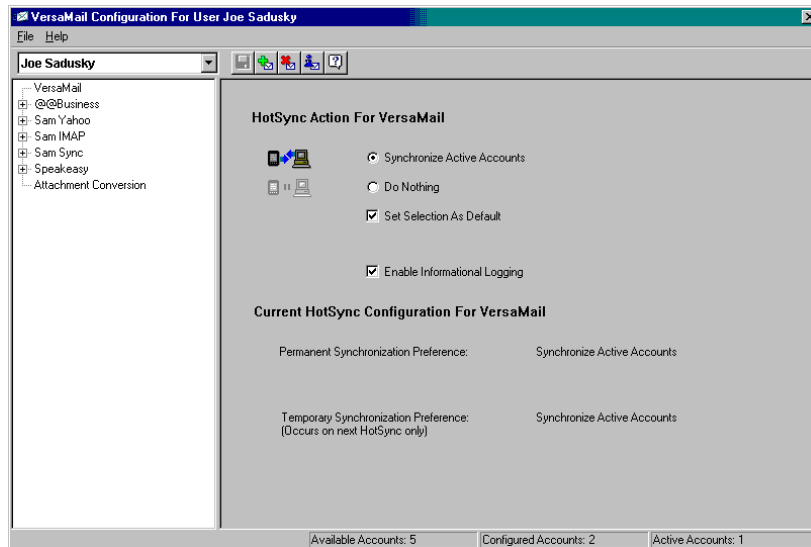

5. Select one of the following:

Synchronize Active Accounts

Select this option to include active accounts in the next HotSync operation. For an account to be synchronized, you must have selected the option Check this box to synchronize this mail account when you perform a HotSync operation.

Do Nothing

Select this option to exclude e-mail accounts from the next HotSync operation.

6. (Optional) Select Set Selection As Default to apply the options you selected to all subsequent HotSync operations. Otherwise, the settings apply to the next HotSync operation only.
7. Click OK.
8. Perform a HotSync operation.

Synchronizing multiple accounts

You can synchronize more than one account during the same HotSync operation.

NOTE If you want to synchronize both a Microsoft Outlook and a Microsoft Outlook Express account, you must have Microsoft Outlook set as the default e-mail client on the desktop.

The maximum number of accounts you can synchronize are as follows:

- 1 Simple MAPI account (for example, an account set up using Outlook Express or Eudora)
- 1 Extended MAPI account (for example, an account set up using Outlook)
- 1 Lotus Notes account
- 5 combined direct POP or direct IMAP accounts

If you attempt to synchronize more than the limit for a particular type of account during a HotSync operation, you will receive an alert prompting you to deactivate any accounts over the allowed number.

Using SSL with the conduit

When you set up an e-mail account, you can choose to use a secure connection (Secure Sockets Layer, or SSL) for sending and receiving e-mail messages. The Palm VersaMail HotSync Conduit supports SSL when synchronizing with an e-mail account only if that account uses one of the following desktop e-mail applications (mail clients):

- Outlook
- Outlook Express
- Eudora

The conduit does not support SSL for accounts set up as direct POP or direct IMAP or for Microsoft Exchange or Lotus Notes accounts.

Going beyond the basics

Many of the VersaMail application features, such as getting and sending e-mail, you use daily. Other features are used less frequently but are especially valuable in certain situations. For example, filtering e-mail is helpful if you are traveling and want to receive messages only from certain people or about specific subjects. Filters and other special features are discussed in this chapter.

This section describes the following:

- Creating and using filters to determine which e-mail you actually view
- Managing mail settings
- Adding APOP to an account

- Adding ESMTP to an account
- Setting advanced e-mail account options
- Cutting and copying text from an e-mail message for use in other applications
- Using the command bar
- Viewing e-mail header details
- Backing up your mail databases
- Synchronizing IMAP folders wirelessly
- Using Secure Sockets Layer (SSL)

The section ends with a summary of the VersaMail application navigator controls and keyboard shortcuts.

Managing mail filters

Filters provide efficient ways to manage e-mail retrieval and storage. When you tap Get Mail or Get & Send, filters determine which e-mail messages are downloaded to your handheld and in which folder the downloaded messages are stored.

For example, you may want to file e-mail about sales meetings in a Sales folder. You can create a filter that automates this action, so that whenever you receive e-mail about sales meetings, it is immediately sent to the Sales folder, which you created in the filters screen.

Creating mail filters

To create a mail filter, you select various criteria, such as To, From, and Contains. This information makes up the filter statement.

For example, if you want stock quotes from your online brokerage service sent to a folder you created called Finance, you can filter those e-mail messages and store them in the Finance folder. The filter statement, which is displayed in the Filter Editor, is shown in the following figure.



IMPORTANT If you create a filter, only messages that meet the filter criteria are downloaded to your handheld. You do not see any other messages that have been sent to you, even in your Inbox. To avoid this, you must set up two filters as described in the following procedure. Using the example above, the first filter would have all mail containing “onlinebroker” in the “From” field moved to the “Finance” folder. For the second filter, you should specify that all mail NOT containing “onlinebroker” in the “From” field should be moved to the Inbox (or other folder you designate). If you do not create this second filter, then only messages containing “onlinebroker” in the “From” field are downloaded to your handheld.

To create a filter:

1. From the Inbox or another folder, tap the Menu icon .
2. Select Options, and then select Filters.

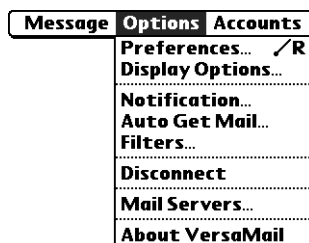

3. Tap New.
4. Enter a short description of the filter in the Name field.



5. Use the If the pick lists to create criteria for the filter.

The three pick lists and the edit line combine to create a statement that identifies the type of e-mail and where you want the e-mail stored. For example, a filter might read, “If the [Subject] [Contains] sales meeting, Then get mail and move

to [Sales].” When you use this filter to sort incoming e-mail, any e-mail containing sales meetings in the subject line is filed in the Sales folder.

- To pick list** Select the message header field with the information contained in the edit line: To, From, Subject, cc, Date, Size. For example, you might select Date to download only messages that are less than a certain number of days old.
- Contains pick list** Select a filter action: Contains, Starts with, Does NOT Contain.
- Edit line** Enter the text that must be found in the header field. For example, if you want to sort e-mail with the subject Sales, enter “Sales.” If you enter more than one criteria, separate each with a comma—for example, Sales, New York.
- Then get mail and move to pick list** Select the folder or mailbox into which you want your filtered e-mail to go. You can also create a new folder for storing the incoming e-mail. Tap Edit Folders, and then create a new folder or delete or rename existing ones.

6. Tap OK.

The filter appears in the Filters list.

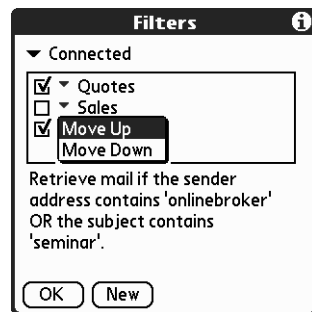

Selected filters execute in the order in which they appear on the list. Move filters up and down the list to ensure that they execute in the correct order.

NOTE Filters created on the handheld also apply to e-mail synchronization. See [“Synchronizing an account”](#) earlier in this chapter for more information.

Turning filters on and off

By default, a filter that is turned on or selected affects all subsequent downloads of e-mail until you deselect it. More than one filter can be in effect at once. Before you download e-mail, be sure to turn on the filters you want and turn off those you don’t want.

To turn a filter on or off:

1. Tap the Menu icon .
2. Select Options, and then select Filters.

The Filters dialog box appears with the filters you created.

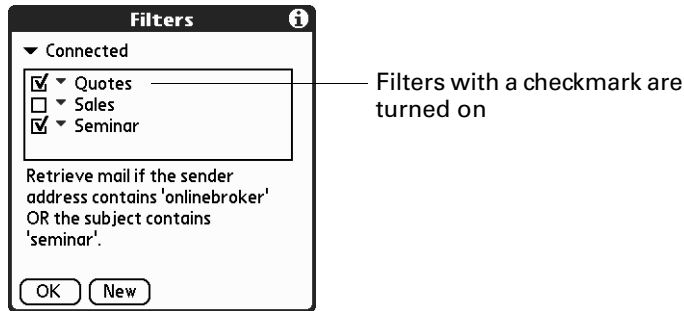

3. Tap the pick list in the upper-left corner, and select Connected or Synchronize.

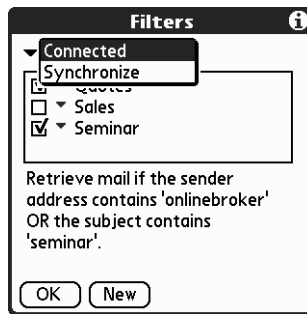

- Connected applies a filter to messages downloaded to your handheld over a modem or network connection.
- Synchronize applies a filter to messages downloaded to your handheld during a HotSync operation.

4. Tap the filter check boxes to select the filters you want to use for subsequent e-mail transactions.

IMPORTANT If you deselect a filter listed under Connected, be sure that the filter is deselected also under Synchronize.

5. Tap OK.

Editing or deleting a filter

You can edit a filter to change its name or the criteria in the filter.

To edit or delete a filter:

1. Tap the Menu icon .
2. Select Options, and then select Filters.
3. Tap the name of the filter.
4. Do one of the following:
 - To edit the filter, revise your entry in the Name field and/or your selections in the pick lists, and revise the text in the edit line. Tap OK.
 - To delete the filter, tap Delete, and then tap Yes to confirm the deletion.
5. Tap OK.

Managing mail settings

You can configure advanced mail settings such as server information, incoming and outgoing mail server options, and more, for each e-mail account.

To select the account whose settings you want to manage:

1. In your Inbox or another folder screen, tap the Menu icon .
2. Tap Options.

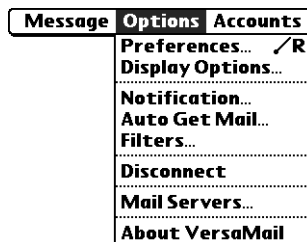

3. Select Mail Servers.



Shows server settings for current account. Tap the Account pick list to edit the account.

4. Tap the Account pick list, and then tap Edit Accounts.

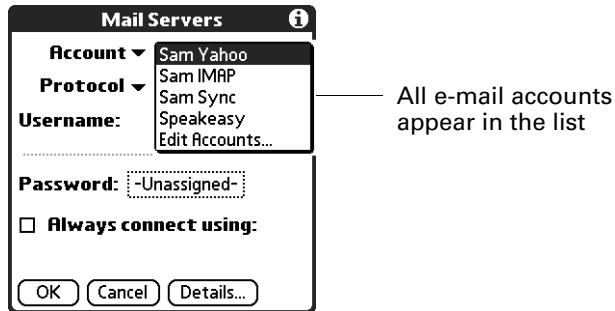

5. Tap the name of the account whose settings you want to manage, and then tap OK.

To change the protocol type:

1. In the Server Settings screen, tap the Protocol pick list, and then tap POP or IMAP.

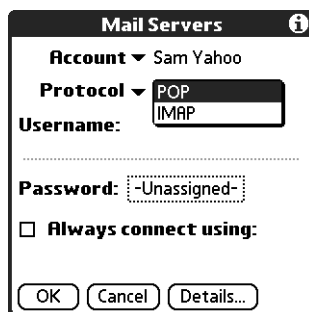

2. Tap OK.

To change your username or password:

1. In the Server Settings screen, enter a new username.

Your username is typically the first part of your e-mail address, which appears before the @ symbol.



2. Tap the Password box, and enter a new password in the Password Entry dialog box. The VersaMail 2.5 application provides strong encryption for your password.
3. Tap OK.

To set a default service for this account (different from the default service for your handheld):

1. In the Server Settings screen, tap the Always Connect Using check box.

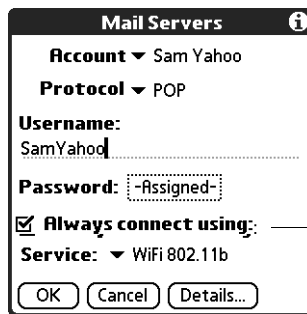

Tap to change the service connection for this e-mail account only from your default handheld service connection

2. Tap the connection type you want from the Services pick list.

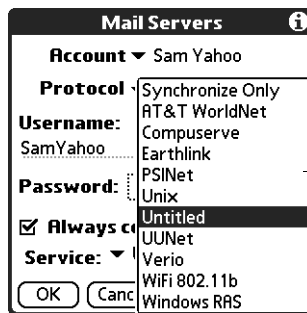

Select a service connection for this e-mail account only

3. Tap OK.

NOTE Select this option only if you want a given e-mail account to use a different service from the default service you set for your handheld. For example, you may have selected a default service that uses the built-in Bluetooth radio on your handheld to make a connection with your corporate account through a VPN. However, for your Earthlink account, you may want to switch to the Earthlink service, which uses an external modem accessory to make a connection with your e-mail service provider. To do this, tap the Always connect using check box, and then select Earthlink from the Services pick list. Leave this box deselected if you want to use your default handheld service for this e-mail account.

See [Chapter 22](#) for information on setting connection types and selecting a default service for your handheld. See [“Selecting a different service for a given e-mail account”](#) earlier in this chapter for details on using a different service for a specific e-mail account.

To change e-mail address/mail server settings:

1. In the Server Settings screen, tap Details.
2. Tap the Options pick list and select Address/Servers.



3. Edit any of the following:

- | | |
|-----------------------------|---|
| Email address | Enter the e-mail address of the account you are accessing, such as <code>examplename@yahoo.com</code> . |
| Incoming mail server | Enter the name of your incoming (POP) mail server, such as <code>pop.mail.yahoo.com</code> . |
| Outgoing mail server | Enter the name of your outgoing (SMTP) mail server, such as <code>smtp.mail.yahoo.com</code> . |



4. Tap OK.

To change incoming mail server settings:

1. In the Server Settings screen, tap Details.
2. Tap the Options pick list and select Incoming Mail.

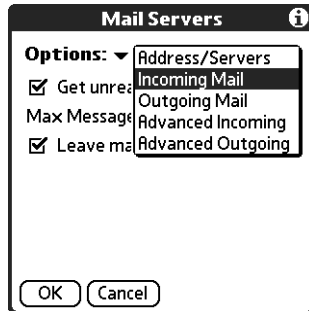

3. Select or enter either of the following:

Get unread mail ONLY

NOTE The POP protocol does not support retrieval of unread mail only from the server. If you have a POP e-mail account, the VersaMail application downloads all messages from the server regardless of whether you have read them (for example, on your desktop or on the web), and regardless of whether this check box is selected.

For IMAP accounts, retrieves unread e-mail only. To get all e-mail and not just unread e-mail, deselect Get unread mail ONLY.

Maximum Message Size

Shows the maximum message size that you can receive.

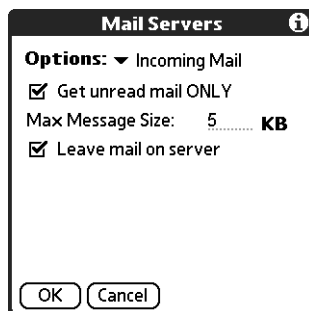

4. Tap OK.

To set additional incoming mail options:

1. In the Server Settings screen, tap Details.
2. Tap the Options pick list and select Advanced Incoming.

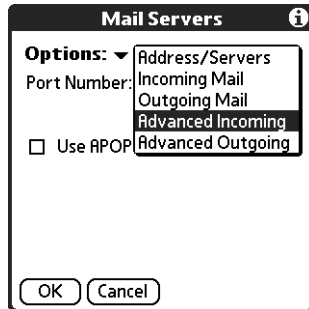

3. The incoming mail options are different depending on the connection type you selected and the server protocol—POP or IMAP.

POP accounts

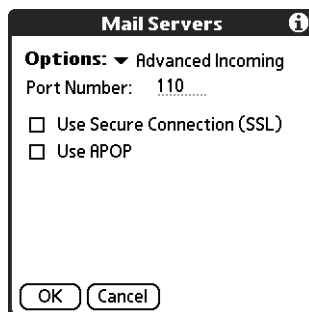

IMAP accounts

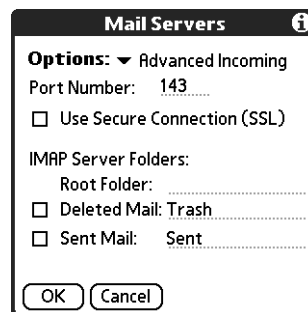

Port Number	Defaults to 110 for POP and to 143 for IMAP servers, respectively. If you are not sure about the correct port number, check with your mail server administrator.
Secure Connection	Retrieves incoming mail over a secure (Secure Sockets Layer, or SSL) connection. See “Using Secure Sockets Layer (SSL)” later in this chapter for information on SSL.
Leave mail on server (POP only)	Leaves e-mail that you receive on the handheld on the server also.
Use APOP (POP only)	Encrypts your username and password when traveling over the network. Some services require APOP to work properly, while others do not work properly if APOP is used. If you aren’t sure if your ISP or web e-mail provider supports APOP, check with your e-mail provider. See “Adding APOP to an account” later in this chapter.

Mailbox (IMAP only)	Defines the root mailbox on your IMAP server.
Deleted Mail (IMAP only)	Stores deleted e-mail in the folder you specify on the server. This field is case sensitive, so spell the folder name exactly as it is on the server. For example, if your Deleted Mail folder is called Trash on the server, you must enter Trash in this space.
Sent Mail (IMAP only)	Shows the name of your Sent Mail folder on the server. This field is case sensitive, and the folder name should be spelled exactly as it is on the server.

If you are using the Palm VersaMail HotSync Conduit and have an IMAP account, you must configure the outgoing mail settings to send mail.

To set outgoing mail server (SMTP) settings:

1. In the Server Settings screen, tap Details.
2. Tap the Options pick list and select Outgoing Mail.

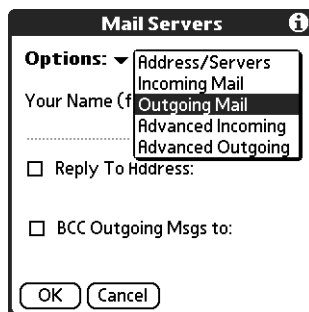

3. Enter any of the following:

Display Name	Enter the name you want to appear on your outgoing messages, such as "Joe Smith."
Reply To Address	Enter the e-mail address that you want recipients to see and reply to on your e-mail messages, only if it is different from the e-mail address from which you are sending the message. For example, if you are sending a message from me@yahoo.com but you want recipients to reply to me@earthlink.net, enter the reply-to address here. Reply To Address makes it look like the e-mail came from the address you entered.

BCC

Select the BCC check box to send a blind copy of any e-mail message you send to another e-mail address. The blind copy e-mail address is not seen by the other recipients of the message. For example, if you want a copy of all messages you send from your handheld to be sent to your desktop e-mail account, enter that e-mail address.

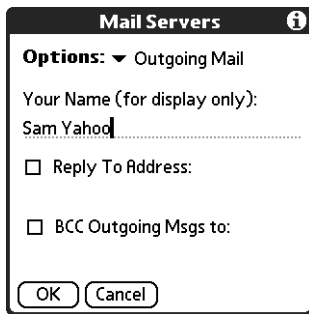

4. Tap OK.

To set additional outgoing mail options:

1. In the Server Settings screen, tap Details.
2. Tap the Options pick list and select Advanced Outgoing.

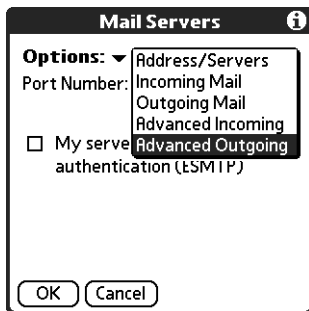

3. Set additional options for outgoing e-mail:

Port Number The default is 25, the port number most SMTP servers use. If you are not sure about the correct port number, check with your mail server administrator.

My server requires authentication (ESMTP) Select the My server requires authentication (ESMTP) check box if the outgoing server (SMTP) requires authentication. Check with your system administrator before selecting this option. See [“Adding ESMTP to an account”](#) later in this chapter for information. If you select this option, username and password fields appear. These fields are prepopulated based on the account information you entered previously. In most cases, the prepopulated information is correct; however, occasionally your authentication username and/or password is different from your account username or password. Check with your e-mail service provider for authentication username and password information.

If you need to enter new information, enter a username and/or tap the Password box and enter a password, and then tap OK.

Username and Password fields appear only if ESMTP check box is selected

4. Tap OK twice.

Adding APOP to an account

To encrypt your username and password when they are traveling over the network, some services require APOP to work properly, while others do not work properly if APOP is used. If you aren't sure if your ISP or web e-mail provider supports APOP, check with your e-mail provider.

NOTE APOP works only with accounts that use the POP protocol.

To edit an account and add APOP:

1. In your Inbox or another folder screen, tap the Menu icon .
2. Tap Options.
3. Select Mail Servers.

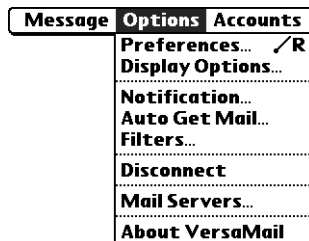

4. Tap the Account pick list and select Edit Accounts.

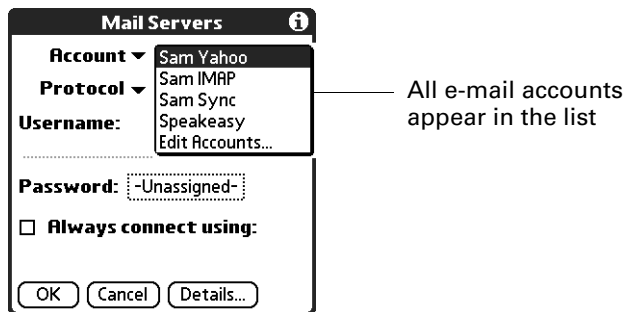

5. Tap the name of the account you want to change, and then tap OK.
6. In the Server Settings screen, tap Details.
7. Tap the Options pick list and select Advanced Incoming.

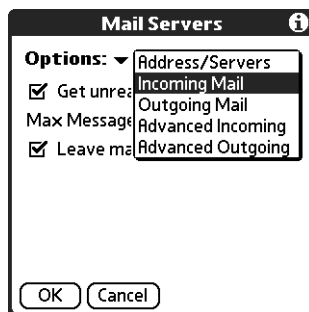

8. Select the Use APOP check box.

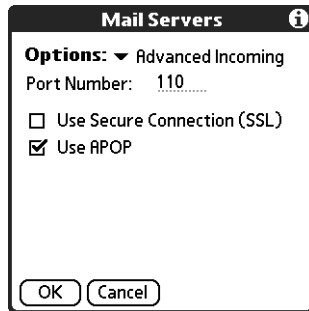

9. Tap OK.

Adding ESMTP to an account

Some services require ESMTP authentication to validate your username and password on a given SMTP server. If you aren't sure if your ISP or web e-mail provider supports ESMTP, check with your e-mail provider.

To edit an account and add ESMTP:

1. In your Inbox or another folder screen, tap the Menu icon .
2. Select Options.
3. Select Mail Servers.

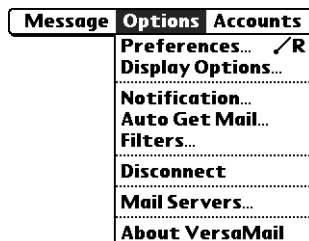

4. Tap the Account pick list and select Edit Accounts.

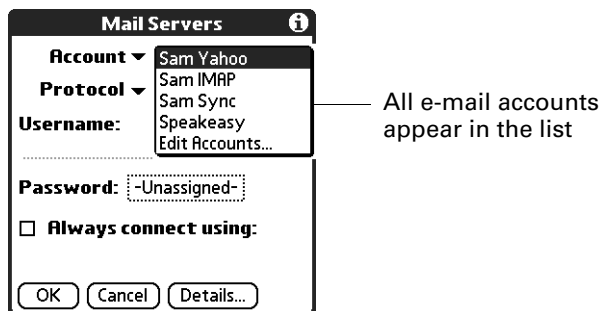

5. Tap the name of the account you want to change, and then tap OK.

6. In the Server Settings screen, tap Details.
7. Tap the Options pick list and select Advanced Outgoing.

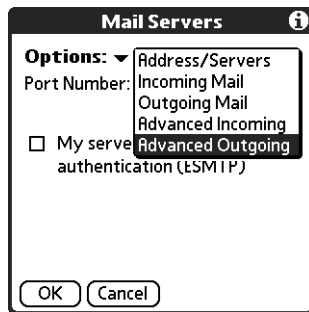

8. Select the My server requires authentication (ESMTP) check box if the outgoing server (SMTP) requires authentication. Check with your system administrator before selecting this option. If you select this option, username and password fields appear. These fields are prepopulated based on the account information you entered previously. In most cases, the prepopulated information is correct; however, occasionally your authentication username and/or password is different from your account username or password. Check with your e-mail service provider for authentication username and password information.

If you need to enter new information, enter a username and/or tap the Password box and enter a password, and then tap OK.

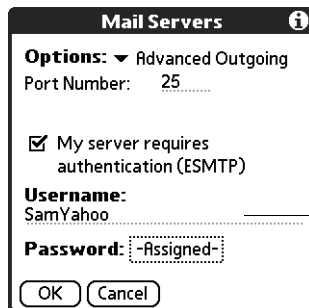

Username and Password fields appear only if ESMTP check box is selected

9. Tap OK.

Setting advanced account preferences

You can set advanced preferences for each e-mail account. Any preferences you set are account-specific; they apply only to the account you are currently in.

To set advanced account preferences:

1. In your Inbox or another folder screen, tap the Menu icon .
2. Tap Options.
3. Select Preferences.

4. Tap Advanced.

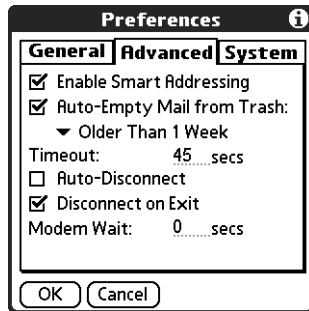

5. Select any of the following preferences:

- | | |
|-----------------------------------|--|
| Enable Smart Addressing | Types ahead and completes a recognized e-mail address. See the procedure for creating new e-mail later in this chapter for more information. |
| Auto-Empty Mail from Trash | Determines how often e-mail messages in the trash are automatically deleted. See “Emptying the trash” later in this chapter for more information. |
| Timeout | Sets the number of seconds to try to connect before timing out. This value can be any number greater than 0 seconds; however, if you set the number too low, your connection attempt may time out before you make a connection with the e-mail service provider.

The default setting is 45 seconds. To change, tap the Timeout field and enter a new value. |
| Auto-Disconnect | Automatically disconnects your remote connections after each command. Each command you perform initiates a new call to your ISP. This setting is not recommended if you plan to perform multiple e-mail transactions in a short amount of time. |
| Disconnect on Exit | Disconnects the connection to your e-mail service provider only after you leave the VersaMail application. This feature is an alternative to Auto-Disconnect. This option keeps your connection active while you perform multiple transactions in the VersaMail application, but automatically disconnects when you move on to a different application on your handheld. If this option is not selected, you must manually disconnect from your ISP. |

Modem Wait Displays the number of seconds that the modem uses to initialize itself. If you have a modem, tap and enter a number of seconds for the wait. The typical setting for a wireless modem is 3, and the typical setting for most normal modems is 0.

Cutting and copying text from an e-mail message for use in other applications

You can copy any text from an e-mail message, either from one you have composed or have read or from an attachment you have downloaded and opened (such as a Word doc), for use elsewhere in the VersaMail application or in another application. Text you can select and copy includes:

- A name
- An e-mail address
- Body text of an e-mail message or a downloaded attachment

To copy and paste text from an e-mail message:



1. Select the text by dragging the stylus over it.
2. Tap the Menu icon .
3. Tap Edit and select Copy.

To paste the text elsewhere in the VersaMail application or in another application:

1. Go to the new location, and tap the Menu icon .
2. Tap Edit and select Paste.

You can also cut or copy text from a Word document that you download as an attachment and view on your handheld. You can then paste this text in another part of the Word document, another Word document, or another application on your handheld.

To cut/copy and paste text from within a Word document:

1. Select the text by dragging the stylus over it.
2. Tap the Menu icon .
3. Tap Edit and select Cut or Copy.
4. To paste the text in another location, go to the new location, tap the Menu icon , tap Edit, and select Paste.

See [Chapter 3](#) for more information on copying and pasting.















Using the command bar

The command bar provides shortcuts for performing numerous tasks. The options presented on the command bar may change, depending on which screen is displayed in the application. For example, if you are viewing a message in the Inbox, the command bar gives you the option of quickly moving the message to another folder. See [“Moving e-mail between folders”](#) earlier in this chapter.

To access the command bar on your handheld:

- Enter the command bar stroke in the Graffiti 2 writing area.

For each type of screen, the command bar offers various options.

View	Options
List (Inbox, Outbox, and so on showing list of messages)	<ul style="list-style-type: none">  Select all messages.  Deselect all messages.  Change display font (toggles between large and small font).  Delete messages from the handheld; icon appears only if you have previously selected at least one message.  Empty the trash; icon appears only if you have previously deleted at least one message.
Reading a message	<ul style="list-style-type: none">  Delete message from the handheld.  Move message to a different folder; select folder from pick list.  Change display font (toggles between large and small font).
Composing a message	<ul style="list-style-type: none">  Insert the @ symbol into a recipient's e-mail address.  Add attachment.  Undoes last action; icon appears in command bar only if you have previously performed one of the actions above or any of the cut/copy/paste functions described below.
Reading or composing a message	<ul style="list-style-type: none">  Cuts selected text.  Copies selected text.  Pastes selected text.

See [Chapter 3](#) for more information on the command bar.

E-mail header details

When viewing a message in any folder, you can change the view of the message header. The e-mail header options are as follows:

- **Short header:** Shows sender's name or address (From field) and subject line (Subj field).

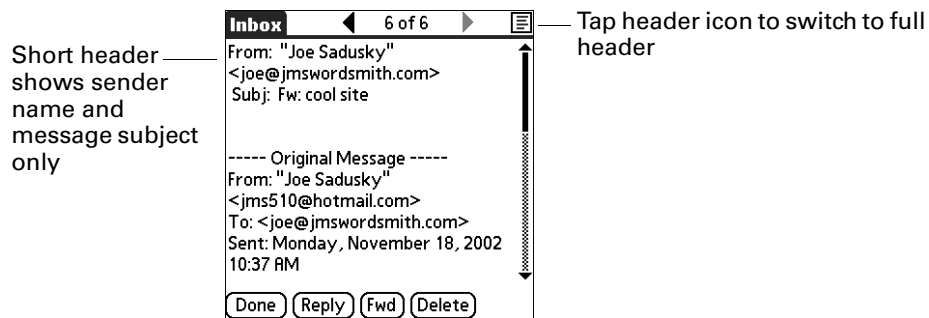

- **Full header:** Shows the following:
 - Sender's name or e-mail address (From field)
 - Subject line (Subj field)
 - Date message was composed, sent, or received (Date field)
 - Size of message including any attachments (Size field)
 - Recipient's name or e-mail address (To field)

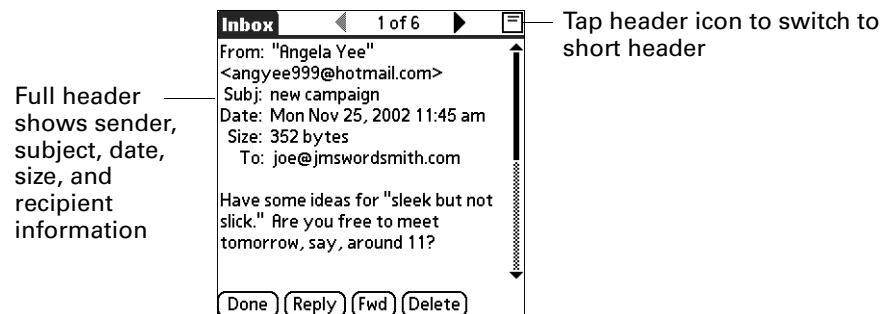

You can also switch between a short header and a full header for a message you are composing. Short header shows the To and Subject fields only; full header shows the To, cc:, bcc:, and Subject fields.

Message short header



Tap header icon to switch to full header

Message long header

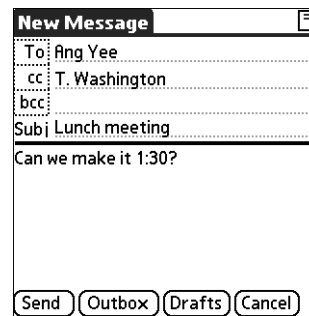

Tap header icon to switch to short header

To switch between short header and full header view:

- Tap the header icon in the upper-right corner of the message screen.

Backing up mail databases

In most cases your e-mail is on your server, so you do not need to back up your e-mail database from your handheld. If you want to make sure you have a current copy of all your e-mail, you can back up all the e-mail databases from the handheld.

To back up the e-mail database:

1. Tap the Menu icon , tap Options, and then select Preferences.
2. Tap System.

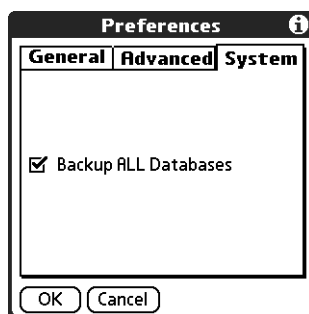

3. Tap Backup ALL Databases to select it.

NOTE If you don't select this option, HotSync operations are faster.

4. Tap OK.

Wireless IMAP folder synchronization

If you create an IMAP folder in an account on your handheld that matches a folder on the mail server, you can wirelessly synchronize e-mail messages that you move into or out of the IMAP folder, or delete in the folder.

When you synchronize a folder, any e-mail messages in the selected folder on the mail server will be downloaded to the same folder on your handheld. Any messages moved out of the selected folder on your handheld or deleted on your handheld will be moved or deleted in the folder on the mail server.

Depending on how you have set up IMAP folders on your handheld and/or the mail server, you may have to perform some steps before you can wirelessly synchronize e-mail messages between your handheld and the server, as follows:

- If you need to create a folder on both your handheld and the server, see [“Creating and editing mail folders”](#) earlier in this chapter. Be sure to select the Also create on server check box as described in that section. After creating the folders, continue with the following procedures for synchronizing IMAP folders.
- If there is a folder on the mail server but you need to create it on your handheld, see [“Creating and editing mail folders”](#) earlier in this chapter. You do not need to select the Also create on server check box as described in that section. After creating the folder, continue with the following procedures for synchronizing IMAP folders.
- If you have a folder on your handheld that matches a folder on the mail server, continue with the following procedures for synchronizing IMAP folders.

You can synchronize server folders either during a Get Mail operation, or from a menu.

NOTE You can synchronize folders whose names are up to 16 characters in length. You can synchronize up to 11 custom folders you create, in addition to the default folders Inbox, Outbox, Drafts, Sent, and Trash.

To wirelessly synchronize handheld/mail server IMAP folders during a Get Mail operation:

1. From within an IMAP e-mail account, tap Get Mail.
2. Select the Sync IMAP Folders check box and then tap OK.

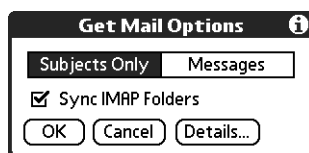

3. Select the check box next to each folder you want to synchronize. You can select more than one folder.

4. (Optional) The Subjects Only check box is selected or deselected based on the preference you set for getting mail. Select or deselect the check box to change this preference for the IMAP e-mail account only.
5. (Optional) Select the Use Filters check box to apply any filters you have created to the IMAP e-mail account. See “Managing mail filters” later in this chapter for information.
6. Tap OK.

To wirelessly synchronize handheld/mail server IMAP folders from the Options menu:

1. In your Inbox or another folder screen of an IMAP e-mail account, tap the Menu icon .
2. Select Options.

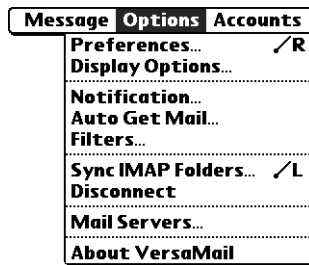

3. Select Sync IMAP Folders.
4. Select the folders you want to synchronize from the pick list either by tapping the folder name or by using the navigator, as follows:

Button	Action
Select	If no folder is selected, the Select button highlights the first visible folder on the list. If a folder is selected, the Select button toggles the check box between selected and deselected.
Up or Down	If a folder is selected, use Up and Down to scroll up or down one folder on the list. If no folder is selected, use Up and Down to scroll up or down one page.
Left	If a folder is selected, deselects the folder. No function if no folder is selected.
Right	No function.

A connection is made to your e-mail service provider to update the server with changes from your handheld, and to have your handheld updated with changes from the server.

Using Secure Sockets Layer (SSL)

Secure Sockets Layer (SSL) is a protocol designed to ensure that data you receive from a network or the Internet is secure and authentic. The VersaMail application uses SSL to help guarantee the secure transmission of e-mail messages that you receive. When you set up an account in the VersaMail application, you are given the option of selecting SSL for incoming mail. See [“Setting up and managing e-mail accounts”](#) earlier in this chapter for instructions.

The VersaMail application supports SSL for incoming mail only; for example, if AT&T is your e-mail service provider, you can receive messages over a secure (SSL) connection. You cannot send messages over a secure connection. However, there is a way that you can make it appear as though messages are being sent over a secure connection.

To send messages so that they appear to have been sent over a secure connection:

1. Set your outgoing mail (SMTP) server to the correct server for your e-mail account. See [“Entering the name of the outgoing and incoming mail server”](#) earlier in this chapter for information on entering the outgoing mail server.
2. Set the reply-to address to an e-mail address from an e-mail service provider that supports sending messages over a secure connection (for example, AT&T). See [“Setting outgoing mail options”](#) earlier in this chapter for information on entering a reply-to address.

If you set up an account that uses an SSL connection on Outlook, Outlook Express, or Eudora, then SSL is supported in the Palm VersaMail HotSync Conduit when you synchronize with that account as well.

NOTE You cannot use auto get mail with notification or scheduled sending retry of e-mail with accounts that use an SSL connection. See [“Auto get mail with notification”](#) and [“Send retry”](#) earlier in this chapter for information.

Five-way navigation in the VersaMail application



The following table summarizes the controls for the 5-way navigator on your handheld that are specific to the VersaMail application. See [Chapter 3](#) for general navigator information.

View	Selection	Navigation	Function
Main List (Inbox or other folder list)	No message selected	Up/Down	Scrolls between messages in list.
		Select	Highlights the first message in the list.
		Right	No function.

View	Selection	Navigation	Function
		Left	No function.
	Message selected	Select	Opens messages for viewing.
		Right	Displays popup menu that normally appears when you click on the e-mail icon for each message.
		Left	Deselects the highlighted message.
Compose New Message	N/A	Up/Down	In To, cc, bcc, and Subject fields: Tabs to the next/previous field. In message body text: Scrolls the text viewed on the text list.
		Select	No function.
		Right	In To, cc, bcc, and Subject fields: Moves to the next character. In message body text: No function.
		Left	In To, cc, bcc, and Subject fields: Moves to previous character. In message body text: No function.
Read Message	N/A	Up/Down	Scrolls the message text.
		Select	Returns you to list view.
		Right	Displays the next message. If you are viewing the last message, returns you to the folder list view.
		Left	Displays the previous message. If you are viewing the first message in the folder, returns you to the folder list view.

When you return to the list view (Inbox or other folder) after viewing a message, the message you were viewing may or may not be selected in the list, according to the following:

- If you pressed Select to view the message, the message will be highlighted on the list when you return to the list view.
- If you used the stylus or pressed Right or Left to view the message, it will not be highlighted when you return to the list view. If you press Select, the first message in the list will be selected.

The following sample procedure shows how to use the navigator to read and delete a message.

To read and delete a message:

1. Press Up or Down on the navigator to scroll to the message you want to read.
2. Press Select to select the message, and then press Select again to open the message.
3. After reading the message, press Select to close the message.
4. (Optional) The cursor should remain on the selected message. If not, press Up or Down to scroll to the message, and press Select to select the message.
5. Press Right to open the pop-up menu.
6. Press Down to scroll to Delete Message.
7. Press Select to delete the message.
8. Press Select to confirm that you want to delete the message.

Keyboard shortcuts in the VersaMail application

You may purchase an optional add-on keyboard for use with your handheld. With this keyboard, you can use shortcuts to perform many tasks in various handheld applications. The following table summarizes the keyboard shortcuts specific to the VersaMail application.

To use a keyboard shortcut:

1. Press Command .
2. Press the letter of the shortcut.

ShortCut	Feature
C	Copy
D	Delete
E	Empty Trash
F	Forward Message
H	Mark Read
I	Mark Unread
K	Keyboard
L	Address Lookup
M	Get Message
N	Create New Message

ShortCut	Feature
O	Reply to Message
P	Paste
Q	Go to Bottom
R	Preferences ...
S	Select All
T	Go to Top
U	Undo
V	Move To ...
W	Save to Draft
X	Cut
Y	Send
Z	Deselect All
Press & hold Mail	Get & Send

Using Voice Memo



Voice Memo provides a place for you to record your thoughts while you're on the go. You can use Voice Memo to do things you might do with a voice recorder, and more:

- Record and play back voice memos directly on your handheld.
- Set an alarm to use your voice memos as reminder messages.
- Assign your voice memos to categories so that you can organize and view them in logical groups.
- Synchronize with your computer using Palm™ Desktop software and HotSync® technology, and then listen to voice memos on your computer or send them as e-mail attachments.
- Share voice memos with other people when you use the Send or Beam commands.
- Conserve space on your handheld by storing voice memos on expansion cards.

To open Voice Memo:

- Press the Voice Memo application button on the side panel of your handheld. Voice Memo opens to display the list of all your voice memos.

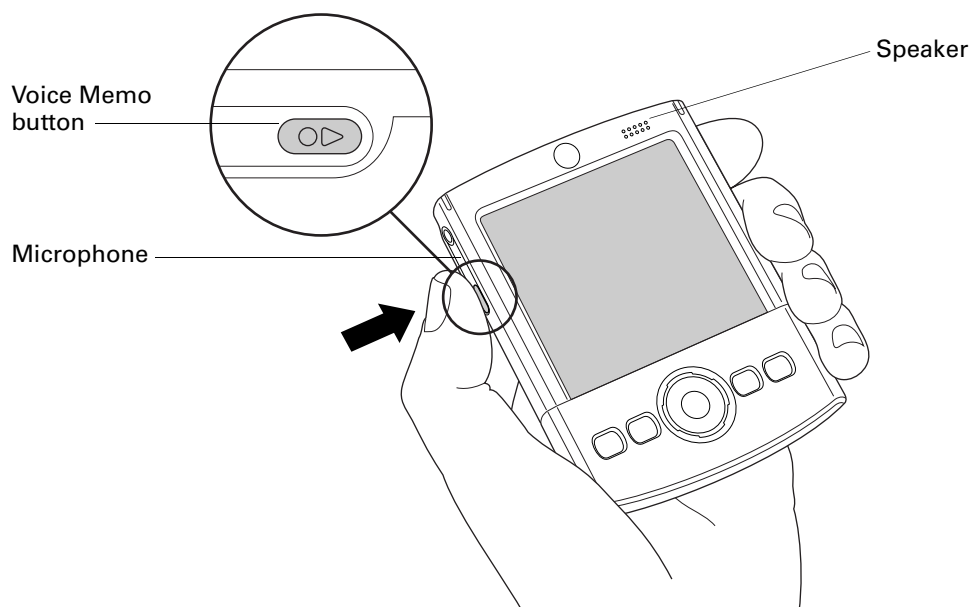

Creating a voice memo

To record a voice memo, you can use the Voice Memo application button or the onscreen controls. To pause and resume while recording a voice memo, you must use the onscreen controls. After you finish recording a voice memo, you cannot add to or change the content, but you can assign the voice memo to a category or change the voice memo title.

To conserve storage space on your handheld, you can also store your voice memos on an expansion card.

Recording a voice memo

This section covers how to record a voice memo using the Voice Memo application button.

To record a voice memo on your handheld:

1. Press and hold the Voice Memo application button .

IMPORTANT Continue holding the Voice Memo application button until you finish recording. If you are recording a long voice memo and don't want to continue holding the Voice Memo application button, see "[Pausing and resuming a voice memo recording](#)" later in this chapter to make a recording with the onscreen controls. For optimum results, hold your handheld within 30 centimeters (approximately 1 foot) of your face while recording.

A tone sounds to indicate that recording has started.

2. Face your handheld and begin speaking.
3. Release the Voice Memo application button to stop recording.

A tone sounds to indicate that recording has stopped.

4. (Optional) Select the time at the top of the screen and enter a title.

- (Optional) Tap the category pick list in the upper-right corner and select the category where you want to store the voice memo.

TIP To automatically store voice memos on an expansion card, see [“Storing voice memos on an expansion card”](#) later in this chapter.

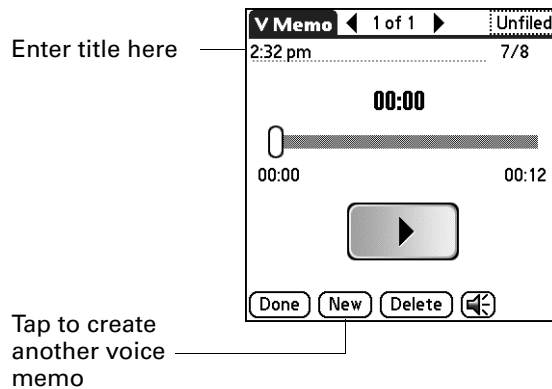

- Tap Done.

Pausing and resuming a voice memo recording

To pause and resume while recording a voice memo, you must use the onscreen controls. This section covers how to use the onscreen controls to pause and resume while recording a voice memo.

To pause and restart while creating a voice memo:

- In the Voice Memo list, tap New.
- (Optional) Tap the category pick list in the upper-right corner and select the category in which you want to store the voice memo.

TIP To automatically store voice memos on an expansion card, see [“Storing voice memos on an expansion card”](#) later in this chapter.

3. Tap Record.

A tone sounds to indicate that recording has started.

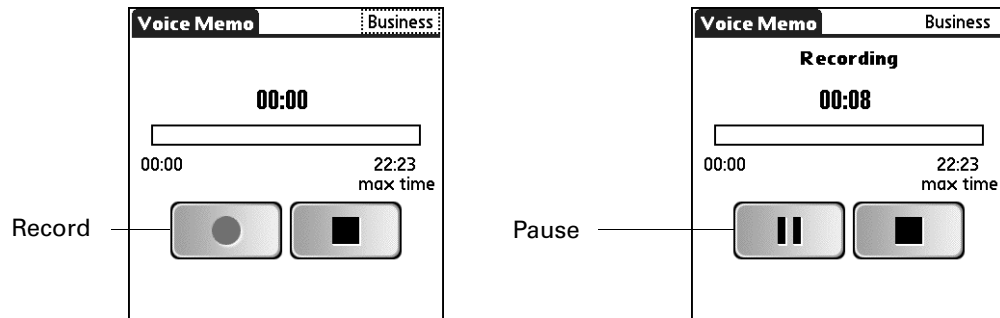

4. Face your handheld and begin speaking.

5. Tap Pause to stop recording.

A tone sounds to indicate that recording has paused.

NOTE If you use other applications on your handheld while pausing the recording, press (and release) the Voice Memo application button  to resume recording later.

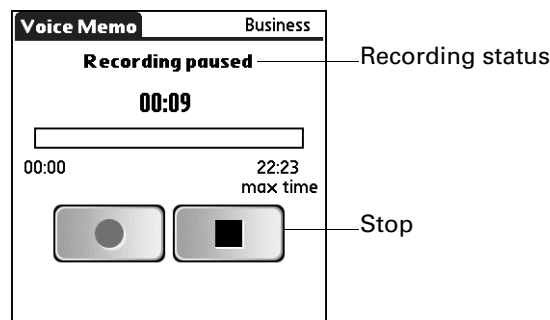

6. Tap Record.

A tone sounds to indicate that recording has restarted.

7. Tap Stop.

A tone sounds to indicate that recording has stopped.

8. (Optional) Select the time at the top of the screen and enter a title.

9. Tap Done.

Storing voice memos on an expansion card

You can conserve storage space on your handheld, or create voice memos for others, by storing your voice memos on an expansion card. Voice Memo enables you to store specific voice memos on an expansion card, or to configure your handheld to always store voice memos on an expansion card when one is present.

Keep in mind that when you store voice memos on an expansion card, they do not appear in the Voice Memo portion of Palm Desktop software after a HotSync operation and are not backed up. So, if you give your expansion card to a friend, you do not have another copy of your voice memo(s). You must use a card reader (sold separately) to view the contents of the expansion card on your computer, and use a third-party application to back up data stored on an expansion card. Additionally, you cannot mark voice memos private or attach alarms to voice memos that are stored on an expansion card.

NOTE Palm works with developers of third-party add-on applications to ensure the compatibility of these applications with your new Palm handheld. Some third-party applications, however, may not have been upgraded to be compatible with your new Palm handheld. If you suspect that a third-party application is adversely affecting the operation of your handheld, contact the developer of the application.

To store specific voice memos on an expansion card:

1. Create or open a voice memo.
2. Tap the category pick list in the upper-right corner and select Card.
3. Tap Done.

To automatically store voice memos on an expansion card:

1. From the Voice Memo list, tap the Menu icon .
2. Select Options, and then select Preferences.

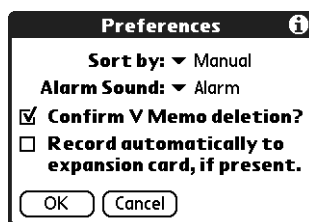

3. Select the check box Record automatically to expansion card, if present.
4. Tap OK.

Listening to voice memos

The Voice Memo list displays the title, creation date, and duration of each voice memo. If you did not assign a title to a voice memo, the title appears as the time you created the voice memo. This makes it easy to locate and listen to your voice memos.

To listen to a voice memo:

1. In the Voice Memo list, select the voice memo title.



TIP You can also select a voice memo with the navigator. See [“Using the navigator”](#) in [Chapter 2](#) for details.

The voice memo begins to play after a few seconds. To start playing immediately, tap Play.

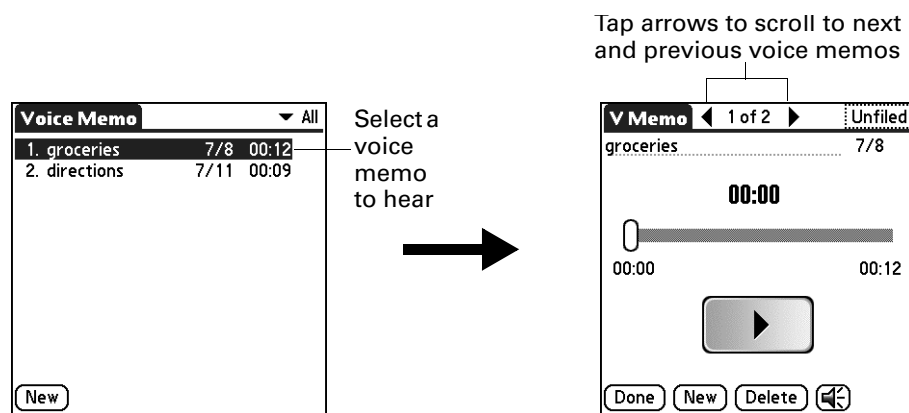

2. Tap the arrows at the top of the screen to listen to the next or previous voice memo.



TIP You can also press Right or Left on the navigator to listen to the next or previous voice memo.

3. Tap Done.

To adjust the volume:

1. In the V Memo screen, tap the Speaker icon .



2. Drag the slider or press Up or Down on the navigator to adjust the volume.

3. Tap Done.



TIP When a voice memo is playing, you can also press Up or Right on the navigator to increase the volume, or press Down or Left to decrease the volume.

To play a portion of a voice memo:

1. In the Voice Memo list, select the voice memo title.
2. Drag the slider to the portion you want to hear.

TIP You can also tap the slider bar to jump the slider to that position.

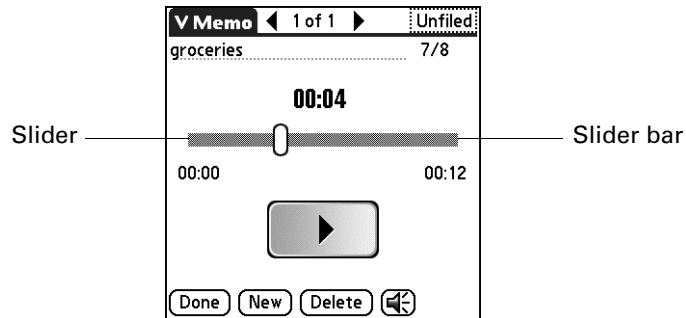

3. Tap Play.
4. Tap Done.

Setting an alarm for a voice memo

You can set an alarm for a specific time and date to remind you to follow-up on a voice memo.

To set an alarm for a voice memo:

1. Select the voice memo to which you want to assign an alarm.
2. Tap the Menu icon .
3. Select Options, and then select Alarm.
4. Tap the Date box.

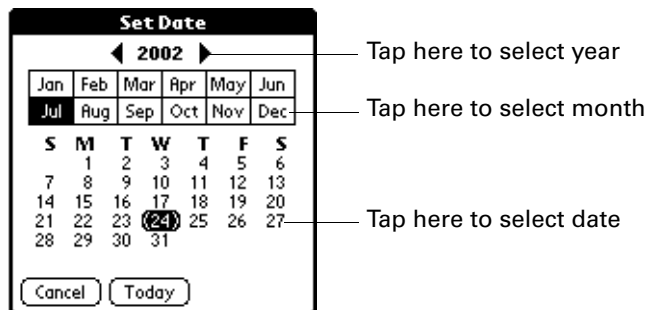

5. Tap the year, month, and date you want the alarm to sound.
After you tap the date, the Set Alarm dialog box reappears.
6. Tap the Time box.

7. Tap the hour and minute columns to select the time you want the alarm to occur.

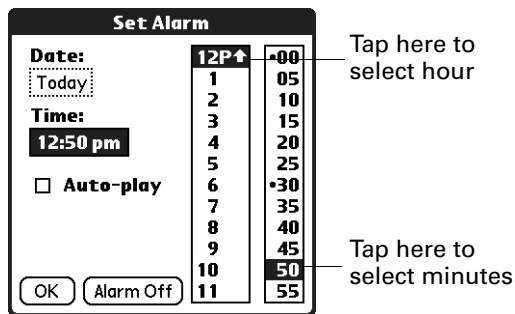

8. (Optional) Tap the Auto-play check box to automatically play the voice memo when the alarm goes off.
9. Tap OK.
10. When the alarm goes off and the reminder message appears onscreen, do one of the following:
- Tap OK to permanently dismiss the reminder and return to the current screen.
 - Tap Snooze to dismiss the reminder and return to the current screen. An attention indicator blinks in the upper-left corner of the screen to remind you of the pending alarm, and the reminder message appears again in five minutes. When the reminder message reappears, the current time appears in the Reminder bar and the voice memo title appears on the screen. If you did not title the voice memo, the time the voice memo was created appears on the screen.
 - Tap Go To to open Voice Memo. Voice Memo opens and displays the voice memo associated with the alarm. Wait a moment for the voice memo to begin playback, or tap Play.

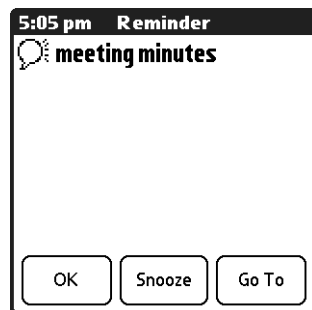

Using Voice Memo menus

Voice Memo menus are shown here for your reference, and Voice Memo features that are not explained elsewhere in this book are described here.

The Voice Memos and Options menus differ depending on whether you're displaying the Voice Memo list or an individual voice memo.

V Memo menus

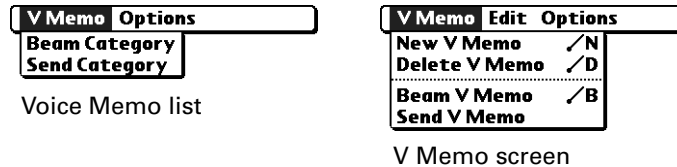

Send Category Opens a dialog box where you can choose how to send the category. You can send the category using Bluetooth™ communication, SMS, or the VersaMail™ application.

Send V Memo Opens a dialog box where you can choose how to send the voice memo. You can send the voice memo using Bluetooth communication, SMS, or the VersaMail application.

Options menus

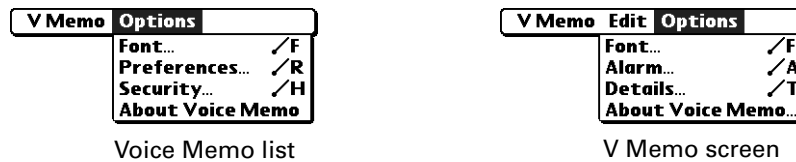

Preferences Displays the Voice Memo Preferences dialog box, where you define the sort order for voice memos, the alarm sound, deletion confirmation setting, and whether to automatically store voice memos on an expansion card if one is present.

Security Displays the Change Security dialog box, where you set a privacy option for all voice memos.

Details Displays the V Memo Details dialog box, where you assign a category and privacy option for a voice memo.

About Voice Memo Shows version information for Voice Memo.

Using Web Browser Pro



IMPORTANT To use Web Pro browser, you must first install the application from the Software Essentials CD.

 Palm™ Web Browser Pro allows you to view and save Internet web pages. Use Web Browser Pro to do the following:

- Open a web page.
- Return to a web page you've recently visited.
- Bookmark a web page so you can visit it later.
- Save a web page on your handheld.
- Download files from the Internet.
- Change how Web Browser Pro accesses, saves, and displays web pages.

IMPORTANT To use Web Browser Pro, you must first configure and establish a connection with the Internet, such as through a mobile phone. For more information on connecting to the Internet using a mobile phone, see [“Setting up a phone connection”](#) in [Chapter 14](#).

To open Web Browser Pro:

1. Tap the Home icon .
2. Select All in the Category pick list in the upper-right corner of the screen.
3. Tap the Web Browser Pro icon .

Web Browser Pro may take a moment to load the first page.

NOTE The rest of the instructions in this chapter assume that you're already running Web Browser Pro and that you've successfully connected to the Internet.

What Web Browser Pro looks like

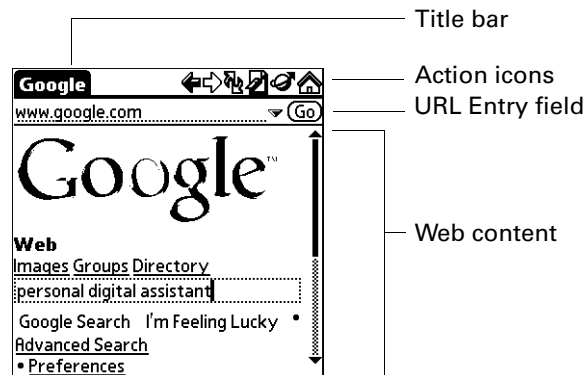

The Web Browser Pro screen has four parts:

- The title bar displays the name of the current web page or shows the status of actions, such as “Searching...”, “Saving...”, “Receiving...”, and so forth.
- The action icons allow you to navigate in the browser, to refresh pages, and to bookmark pages.
- The URL Entry field allows you to quickly enter web page addresses. URL stands for uniform resource locator.
- The rest of the screen is devoted to displaying the content of the web page.

You can perform other actions by tapping items in menus. Like in other Palm OS® applications, when you select the title bar, it is replaced by the menu bar.

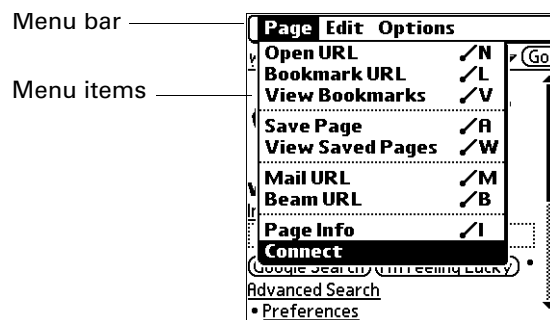

Getting help in Web Browser Pro

Help is available in the following locations:

- Most dialog boxes in Web Browser Pro have help about the options in the dialog box. To see that information, tap the Tips icon ⓘ.
- For an onscreen keyboard to help you input text, tap the Menu icon ☰, tap Edit, and then tap Keyboard.
- For help with drawing Graffiti® 2 characters, tap the Menu icon ☰, tap Edit, and then tap Graffiti 2 Help.

Disconnecting from and connecting to the Internet

While you're working with stored information in Web Browser Pro, such as saved pages, stored versions of pages, and so forth, you can disconnect from the Internet in order to reduce usage charges. You can connect to the Internet again when you need access again.

To disconnect from the Internet:

1. Tap the Menu icon ☰.
2. Tap Disconnect in the Page menu.

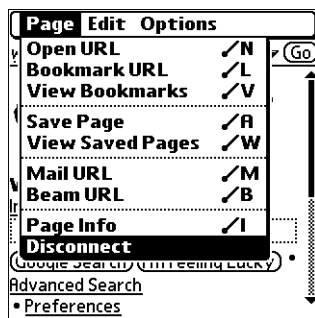

To connect to the Internet:

1. Tap the Menu icon ☰.
2. Tap Connect in the Page menu.

The Service Connection Progress dialog opens.

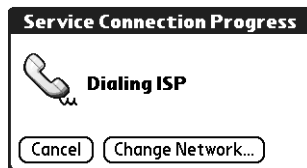

3. If the connection is not established, do one of the following:
 - Tap Cancel to stop the connection process.
 - Tap Change Network to select a different service to connect to.



Browsing the web on your handheld

Just like the web browser you use on your desktop computer, Web Browser Pro lets you browse the web in several ways:

- Visit a web page by entering its URL.
- Visit another web page by tapping a link.
- Go back to the pages you already visited by using the Back and Forward icons.
- Return to your home page.

Visiting a web page

You can visit web pages using the Open URL dialog box or using the URL Entry field.

To visit a web page using the Open URL dialog box:

1. Tap the Open URL icon .
2. Enter the URL of the web page you want to visit.

The field in the Open URL dialog box already contains the characters “www.” If the web address you want to enter starts with another set of letters, just drag over the “www.” and backspace to erase them.

Tap buttons to enter other characters commonly used in web addresses.

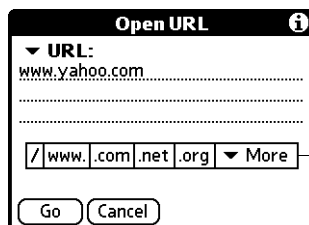

(Optional) Tap buttons to complete the web address

3. Tap Go.

During the short delay while the new page is being downloaded, the title bar displays information about the download process.

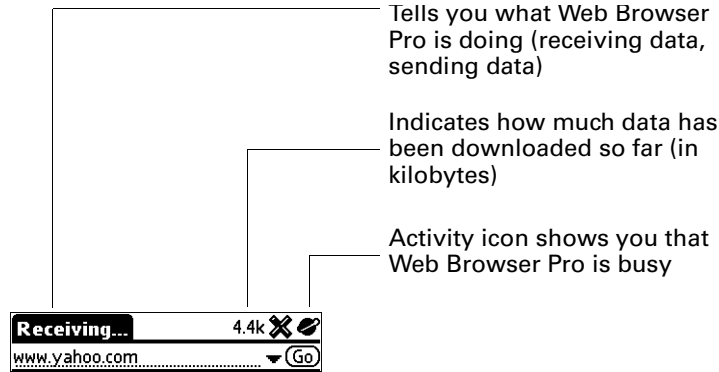

To visit a web page using the URL Entry field:

1. Tap the URL Entry field at the top of the screen.

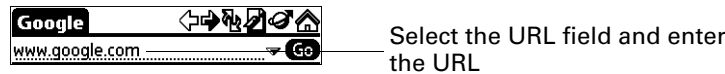

2. Enter the URL in the field.
3. Tap Go.

TIP If autofill is enabled, when you enter the first few letters of a URL that you've entered before in the URL Entry field, Web Browser Pro completes the URL for you. For more information on autofill, see ["Enabling or disabling autofill."](#)

Following a link

Many web pages contain links, which are text or pictures that when clicked, take you to another web page or to another part of the same page. Like many other web browsers, Web Browser Pro highlights these links by underlining them.



To follow a link:

- Tap the link.

Returning to a web page you just visited

To go back to the last web page you visited:

- Tap the Back icon .

To go back to an earlier page:

- Tap the Back icon until you return to the page you want.

The list of visited pages (which is limited by your handheld's memory) is called the *cache*. See [“Finding web pages you recently visited”](#) for more information on the cache.

To go forward through the cached pages:

- Tap the Forward icon .



TIP You can also press Left on the navigator to go back to an earlier page and Right to go forward through the cache.

Returning to your home page

Your home page is the web page that is displayed first every time you start Web Browser Pro. No matter where you navigate on the Internet, you can always return to your home page quickly and easily.

To return to your home page:

- Tap the Home Page icon in the Web Browser Pro action bar .

If you want a different web page to be your home page, see [“Changing your home page.”](#)

Downloading a file to your handheld

Web Browser Pro can download files such as applications (PRCs), databases (PDBs), and query applications (PQAs) for Palm OS software. Downloading a file is much like visiting a web page.

NOTE Some handhelds do not support PQA files.

To download a file by following a link from a web page:

1. Tap the link.
2. A message appears asking you to confirm the file you want to download. If the file is the one you want, tap OK.



3. A message is displayed showing you the progress of the download.

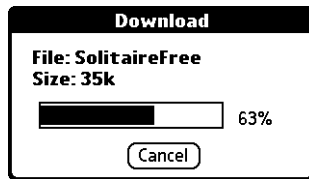

4. When the file download is complete, a message is displayed.



5. Tap OK.

If you decide that the download process is taking too long, you can stop it.

To stop a web page from downloading:

- Tap the Stop icon  in the Web Browser Pro action bar.

To stop a file from downloading:

- Tap Cancel in the Download dialog box.

You can make changes to improve the download speed, such as not downloading images that appear on web pages. See [“Changing how images are downloaded.”](#)

Refreshing a page

Some web pages, such as news sites, change frequently. If you visit a page and spend several minutes reading an article, the web site may change during that time. To make sure you have the latest content, refresh the page.

To refresh a page:

- Tap the Refresh icon .

You can also view old content instead of accessing the Internet. (See “[Controlling how Web Browser Pro accesses the Internet.](#)”) Web Browser Pro lets you know you’re looking at old content by displaying a dialog box when you open the web page.



Tap Yes to view the stored version, or force the latest content to be downloaded by tapping Update Content.

Viewing information about a web page

Because of the limited space on the handheld screen, sometimes the current web address (URL) gets truncated. To find the full URL, name, and size of the current web page, open the Web Page Info dialog box.

To view information about the current web page:

1. Tap the Menu icon .
2. Tap Page Info in the Page menu.



3. Tap OK.

Using passwords

Some web sites require that you use a password to gain access to information. Passwords in Web Browser Pro work in a slightly different way from those in typical desktop browsers.

To enter a password:

1. Open the web page where you must enter the password. The password field contains the word "Unassigned."



2. Enter your sign-in name in the appropriate field.
3. Tap the password field.



4. Enter your password and tap OK.

NOTE Your password is visible only when you enter it.

5. The password field now contains the word "Assigned." Tap the sign-in button (Enter, Go, and so forth) on the web page to gain access to the password-protected information.



Copying and pasting text

You'll often find text on web pages, in web page fields, and in dialog boxes that you'd like to copy and use elsewhere in Web Browser Pro or in another application.

Copying text

To copy text, select the text and use the options from the Edit menu. Note that none of the Edit options copy images, only text.

Cut	Removes the selected text from a field in a web page or dialog box and stores it temporarily in the memory of your handheld. If you select text on a web page rather than in a field, Cut functions just like Copy.
Copy	Copies selected text from a field or web page and stores it temporarily in the memory of your handheld.
Select All	If the cursor is in a URL, input, or text field, selects all the text in the field. If the cursor is not in a field, selects all the text on the web page.

To undo the last Cut, Copy, or Select All action:

- Select Undo from the Edit menu.

Pasting text

Once you've copied text, you can paste that text in a web page field, dialog box, or another application.



To paste text in a web page field or dialog box:

1. Place the cursor where you want the text pasted.
2. Tap the Menu icon .
3. Tap Edit, and then tap Paste.

To paste text in another application:

1. Open the application.
2. Place the cursor where you want the text pasted.
3. Use the paste option in the application. For example, in Address Book, tap the Menu icon , tap Edit, and then tap Paste.

To undo a Paste action:

- Do one of the following:
 - In Web Browser Pro, tap the Menu icon , tap Edit, and then tap Undo.
 - In other applications, if available, choose the undo option in the application. For example, in Address Book, tap the Menu icon , tap Edit, and then tap Undo.

Communicating with other users

Web Browser Pro allows you to communicate with other users in several ways:

- Use a mailto link in a web page to compose and send e-mail.
- Beam a URL to another Web Browser Pro user.
- E-mail a URL to another user.

Sending e-mail

Some web pages include “mailto” links. You can use these links to send e-mail to others if you use the VersaMail™ application or another application that supports this functionality. For more information on the VersaMail application, see [Chapter 17](#).

To send e-mail:

1. Tap a mailto link in a web page.

The e-mail application opens and a new e-mail message is created. The message is already addressed to the mailto address, and the subject line may be filled out for you, as well.
2. Compose your e-mail message in the e-mail application. For more information on composing e-mail messages in the VersaMail application, see [Chapter 17](#).
3. Tap Send to send the e-mail message, Outbox to send the e-mail message later, or Cancel.

You are returned to Web Browser Pro and to the web page you were viewing.

Beaming a URL

You can share your favorite web pages with other Web Browser Pro users by beaming URLs to their handhelds.

To beam a web page's URL:

1. Navigate to the web page.
2. Tap the Menu icon .
3. Point the IR port of your handheld directly at the IR port of the receiving device.
4. Tap Beam URL in the Page menu.

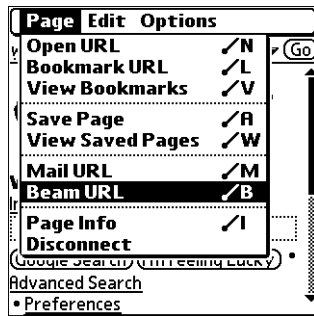

The receiver can choose to accept the beamed URL or not. If they choose not to accept the URL, the beaming process ends.

5. While the URL is prepared for beaming, a message is displayed.
6. While the URL is being beamed, a message is displayed.

When the message closes, the URL is finished being beamed to the receiving handheld.

E-mailing a URL

You can also e-mail the URLs of your favorite web pages to other users.

To e-mail a web page's URL:

1. Navigate to the web page.
2. Tap the Menu icon .
3. Tap Mail URL in the Page menu.

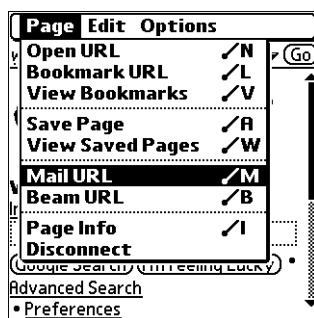

The e-mail application opens.

4. Compose your mail message in the e-mail application. For more information on composing e-mail messages in the VersaMail application, see [Chapter 17](#).
5. Tap Send to send the e-mail message, Outbox to send the e-mail message later, or Cancel.

You are returned to Web Browser Pro and to the web page you were viewing.



Bookmarking your favorite pages

When you read a printed book, you place a bookmark at the page where you stopped reading so that you can remember where you stopped. In the same way, you can bookmark a web page for later reference. A bookmark in Web Browser Pro doesn't store the actual page; instead, it stores a reference to the page's URL.

Adding a bookmark

If you would like to visit the current page again, add a bookmark to the Bookmark list.

To add a bookmark for the current page:

1. Do one of the following:
 - Tap the Bookmark icon .
 - Tap the Menu icon , and then tap Bookmark URL from the Page menu.
2. (Optional) Change the bookmark name, URL, or category.

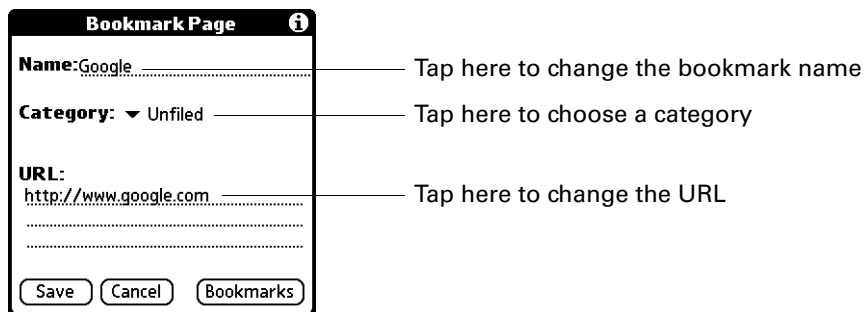

3. Tap Save.

Visiting a bookmarked page

Use your list of bookmarks to visit a particular page again.

To visit a bookmarked page:

1. Press Select on the navigator.

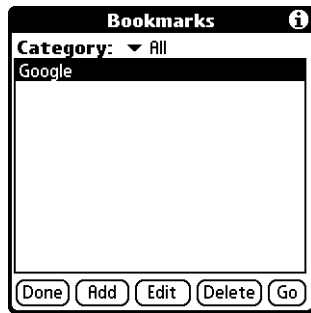

2. Press Up and Down on the navigator to scroll through the list of bookmarks, and then press Select to visit the bookmarked page you've chosen.

Editing information about a bookmark

You can edit the name and URL of a bookmark, and change its category.

To edit information about a bookmark:

1. Press Select on the navigator.
2. Press Up and Down on the navigator to scroll through the list of bookmarks to the bookmark you want to edit.
3. Tap Edit.
4. Edit the bookmark:
 - Tap the Name field, and then enter a new name.
 - Tap the URL box to change the address.
 - Tap the Category pick list to change the category or to create a new category.
5. Tap Save.

A confirmation dialog box appears.
6. Tap Yes to confirm your changes.
7. Tap Done.

Deleting a bookmark

You can delete bookmarks that you no longer want.

To delete a bookmark:

1. Press Select on the navigator.
2. Press Up and Down on the navigator to scroll through the list of bookmarks to the bookmark you want to delete.

3. Tap Delete.
A confirmation dialog box appears.
4. Tap OK.
5. Tap Done.

Saving pages

If you want to save a page (such as a travel itinerary or Internet order receipt) indefinitely, you can create a saved page. A saved page is a copy of the page. The copy is stored on the handheld until you delete it.

NOTE By default, Web Browser Pro only has a certain amount of memory allocated to storing saved pages. To increase or decrease the amount of memory allocated, see [“Changing the size and content of the cache.”](#)

Saving a page

To save a web page:

1. Open the web page you want to save.
2. Tap the Menu icon .
3. Tap Save Page in the Page menu.



4. (Optional) Change the page name or category.
5. Tap Save.

Opening a saved page

When you open a saved page, remember that you're seeing a copy of the actual page. To view the current version of the web page, enter the URL of the page again.

To open a saved page:

1. Tap the Menu icon .
2. Tap View Saved Pages in the Page menu.

3. Tap the name of the saved page you want to open.

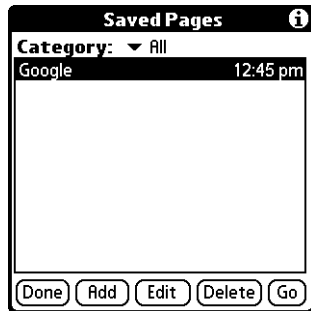

Shows when you saved the page. If you saved it today, it shows the time. If you saved it before today, it shows the date.

4. Tap Go.

Editing information about a saved page

You can edit the name of a saved page and change its category.

To edit information about a saved page:

1. Tap the Menu icon .
2. Tap View Saved Pages in the Page menu.
3. Tap the name of the saved page you want to edit.
4. Tap Edit.
5. Edit the information about the saved page:
 - Tap the Name field, and then enter a new name.
 - Tap the Category pick list to change the category or to create a new category.



Tap here to enter a new name

Tap here to change the category

6. Tap Save.
A confirmation dialog box appears.
7. Tap Yes.
8. Tap Done.

Deleting a saved page

You can delete saved pages you no longer want in order to make more free space available on your handheld.

To delete a saved page:

1. Tap the Menu icon .
2. Tap View Saved Pages in the Page menu.
3. Tap the name of the saved page you want to delete.
4. Tap Delete.

A confirmation dialog box appears.

5. Tap OK.
6. Tap Done.

Finding web pages you recently visited

Using the Back and Forward icons to browse through the pages you recently visited, one page at a time, can be tedious. Instead, you can use the History list to view a list of the pages you visited and go directly to any page in that list. The History list contains a record of the last 50 pages you have visited and is saved even when you exit Web Browser Pro.

Returning to a page you visited

To return to a page you visited:

1. Tap the Menu icon .
2. Tap Options, and then tap History.
3. Tap the name of the web page you want to visit.



4. Tap Go.

Clearing the History list

If you've recently visited web pages you have no intention of visiting again, you can clear the History list.

IMPORTANT Clearing the History list removes the record of your recent browsing history. Pages you've recently visited are still available in the cache and you can visit those pages by using the Back and Forward icons in the Web Browser Pro action bar. If you want to save the location or content of a web page indefinitely, create a bookmark or a saved page for that page before clearing the History list. For more information on the cache, see [“Changing the size and content of the cache.”](#) For more information on the Back and Forward icons, see [“Returning to a web page you just visited.”](#)

To clear the History list:

1. Tap the Menu icon .
2. Tap Options, and then tap History.
3. Tap Clear.

A confirmation dialog box appears.

4. Tap OK.

NOTE This action clears only the contents of the History list. Your bookmarks and saved pages are not deleted.

5. Tap Done.

Customizing Web Browser Pro

You can change Web Browser Pro to improve the speed, ease-of-use, and security of your browsing experience.

Changing the default size of text

If the default size of the text is too small, you can increase the size.

To change the default size of text:

1. Tap the Menu icon .
2. Tap Options, and then tap Font.
3. Choose font size and check the sample text.
4. When you're satisfied with your choice, tap OK.

Changing your home page

Your home page is the web page that appears when you first open Web Browser Pro. You can change your home page to any web address.

NOTE Your service provider has the option to disable this choice. If the choice is disabled, your changes have no effect.

To change your home page:

1. Tap the Menu icon .
2. Tap Options, and then tap Preferences.
3. Tap Default.
4. Do one of the following:
 - Enter the address of the new home page.
 - Tap Current URL to make the page currently displayed in Web Browser Pro your home page.

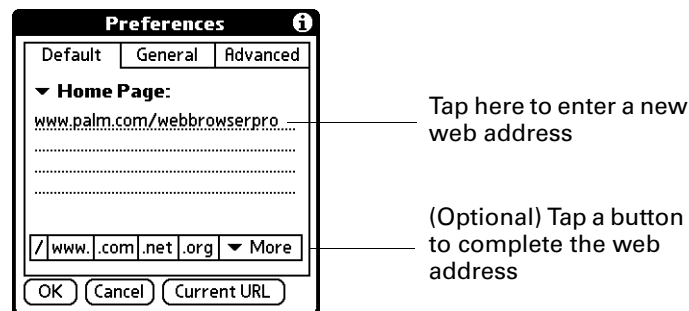

- Use the drop down list to choose one of the last five home pages you've used as your home page.

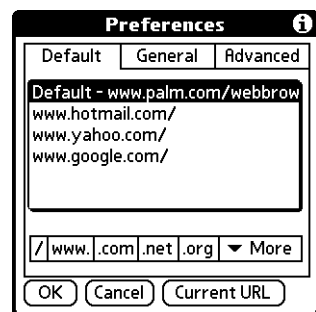

5. Tap OK.

Changing how images are downloaded

Images in web pages can be very large. You can make web pages download faster by reducing image quality or removing images altogether. Alternatively, if you have a fast Internet connection, you can have images downloaded so that they appear at their highest quality.

To change how images are downloaded and displayed:

1. Tap the Menu icon .
2. Tap Options, and then tap Display Options.

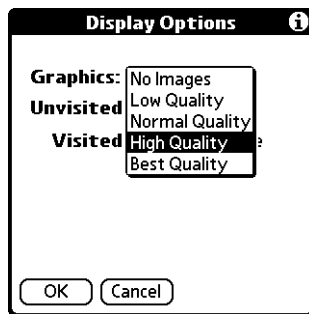

3. Select one of the following items from the Graphics pick list:

No Images	All web pages are downloaded without images.
Low Quality	Images are compressed and shown in grayscale rather than color. This makes downloading faster but results in reduced image quality.
Normal Quality	Image quality is average. This is the default setting and the best compromise between speed and image quality.
High Quality	Image quality is better than average. This setting sacrifices some speed for better image quality.
Best Quality	Images are downloaded at their highest quality. This may result in longer download times.

4. Tap OK.

Changing link colors

You can change the colors that are used to display visited and unvisited links on the web pages you view.

To change link colors:

1. Tap the Menu icon .
2. Tap Options, and then tap Display Options.

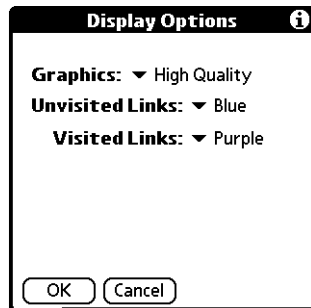

3. Change the display colors for visited and/or unvisited links. The default display color for unvisited links is blue; for visited links it is purple.
4. Tap OK.

Enabling or disabling autofill

Filling out an order form or application on the web usually requires entering several pieces of information: your name, address, phone number, and so on. By default, Web Browser Pro stores the information you entered in these fields. The next time you use that order form and type the first few letters in a field, Web Browser Pro remembers the last item you entered in that field that started with those letters, and fills in the field.

This also applies to URLs. If autofill is enabled, when you enter the first few letters of a URL you've entered before in the URL Entry field, Web Browser Pro completes the URL for you.

To enable or disable autofill:

1. Tap the Menu icon .
2. Tap Options, and then tap Preferences.
3. Tap General.
4. In the Autofill Text check box, do one of the following:
 - To turn off autofill, tap to remove the checkmark.
 - To turn on autofill, tap to select it.
5. Tap OK.

Enabling or disabling cookies

Some web sites store information in a small text file, called a *cookie*. Cookies usually contain information about you and your preferences for that web site. A site can use this information to customize the pages you see the next time you visit.

Allowing a web site to create a cookie does not give the site access to the rest of your handheld. A cookie stores only the information you provide while visiting the web site.

By default, Web Browser Pro saves the cookies it receives. You can tell it not to accept cookies.

To enable or disable cookies:

1. Tap the Menu icon .
2. Tap Options, and then tap Preferences.
3. Tap Advanced.
4. In the Accept cookies check box, do one of the following:
 - To not store cookies, tap to remove the checkmark.
 - To accept cookies, tap to select it.
5. Tap OK.

Enabling or disabling JavaScript

Web Browser Pro supports JavaScript code on web pages. JavaScript is often used on web pages for interactive content.

NOTE Some JavaScript implementations are not supported, such as mouse rollovers and form validation.

To enable or disable JavaScript:

1. Tap the Menu icon .
2. Tap Options, and then tap Preferences.
3. Tap Advanced.
4. In the Enable JavaScript check box, do one of the following:
 - To disable JavaScript, tap to remove the checkmark.
 - To enable JavaScript, tap to select it.
5. Tap OK.

Changing the size and content of the cache

The *cache* in Web Browser Pro consists of web pages that are stored so you can view them again without accessing the Internet. By default, this cache is saved, thereby saving the content you've viewed even when you exit Web Browser Pro.

Pages that you explicitly save are also stored in the cache, although they are not deleted when the cache is cleared. You must delete saved pages separately to clear that portion of the cache. See ["Deleting a saved page."](#)

You can change the size of the cache to increase the number of web pages stored, you can choose to clear the cache immediately, or you can choose to clear the cache each time you exit Web Browser Pro so it starts fresh at the beginning of each session.

To change the size and content of the cache:

1. Tap the Menu icon .
2. Tap Options, and then tap Preferences.
3. Tap Advanced.

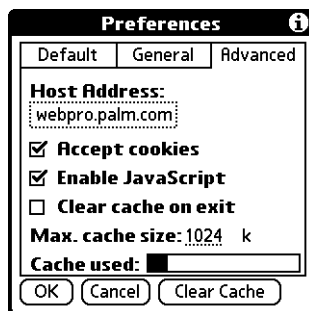

4. Use one or more of the following options:

- | | |
|----------------------------|---|
| Clear Cache | Tap to clear the cache immediately. |
| Clear cache on exit | Select the check box to clear the cache each time you exit Web Browser Pro. Deselect the check box to keep the cache from session to session. |
| Max. cache size | Tap to change the maximum cache size used to store web pages. The default size of the cache is 1,024KB and the maximum size is 9,999KB. |

NOTE Remember that your handheld has a limited amount of memory. Choose a cache size that lets you store at least a few pages but still leaves room on your handheld for other data and applications. A value of at least 500KB is recommended.

5. Tap OK.

Controlling how Web Browser Pro accesses the Internet

Because some wireless Internet service providers (ISPs) charge by the amount of data you download, Web Browser Pro is careful to limit how often it accesses the Internet. If you have a faster or more permanent connection to the Internet, the default settings should work for you.

If you have a slower or more expensive Internet connection, you can enable three settings that can help reduce your access costs.

To change connection settings:

1. Tap the Menu icon .
2. Tap Options, and then tap Preferences.
3. Tap General.
4. Tap the check box next to the following options to enable or disable that option:

Ask before connecting

You're notified each time before you access the Internet.

Offer old content if available

Old pages from cache are displayed instead of new versions being retrieved from the Internet, even if the old pages are outdated. A dialog box is displayed to inform you when the page you are viewing is old.

Disconnect on Exit

Your handheld disconnects from the Internet when you exit Web Browser Pro.

By default, these options are disabled (that is, there are no checks in the check boxes).

5. Tap OK.

Changing Network Preferences

Web Browser Pro includes many options you can use to change the way in which you access the network.

To change Network Preferences:

1. Tap the Menu icon .
2. Tap Options, and then tap Network.

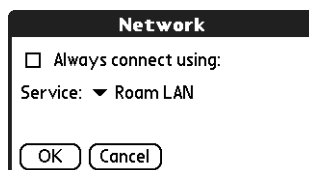

3. Change one or more of the following settings:

Always connect using Check if you always want to use the same ISP to connect to the Internet.

Service Select the ISP you want to use to connect to the Internet.

4. Tap Done.

Changing the host server

Your handheld uses a host, or in other words, proxy server to access the Internet. You can change your host server.

IMPORTANT You should not change this setting from its default, "webpro.palm.com", unless you are told to do so by your system administrator.

To access a new host server:

1. Tap the Menu icon .
2. Tap Options, and then tap Preferences.
3. Tap Advanced.

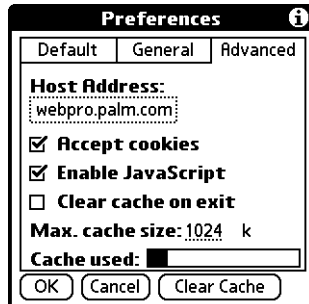

4. Tap the Host Address field.



5. Enter the Internet Protocol (IP) address or host name of the new server.

NOTE If you enter the IP address of the new server, make sure you enter the address exactly, including periods.



6. Tap OK to save your changes.
7. Tap OK.

Using World Clock

 World Clock enables you to view the current time and date in multiple locations and to set an alarm. Use World Clock to do the following:

- View the current time and date in three locations.
- Open a preferences screen where you can set the time and date for all the applications on your handheld.
- Set an alarm.
- Set Daylight Saving options.

To open World Clock:

1. Tap the Home icon .
2. Select the World Clock icon .



TIP You can also open World Clock by tapping the Clock icon  in the upper-left corner of the Graffiti® 2 writing area and then tapping Go to Clock, or when your handheld is off, you can press Select on the navigator and then tap Go to Clock.



Viewing the time

There are several ways for you to easily check the current time and date.

To view the time:

Do one of the following:

- When your handheld is on, tap the Clock icon  in the upper-left corner of the Graffiti 2 writing area.

Your handheld displays the time for two seconds and then returns to the previous application.



- When your handheld is off, press Select on the navigator.

Your handheld turns on, displays the time, and then turns off after a few seconds.

- Tap the Home icon , and then select the World Clock icon .

Setting the primary location

You can use World Clock to select the location, date and time for the primary location. Keep in mind that the primary location settings are also your system date and time and that these settings are used by all the applications on your handheld. The primary Location settings also appear in the Date & Time Preferences screen. Similarly, if you change the settings in the Date & Time Preferences screen, those settings become your system date and time and also appear under the primary location in World Clock. The primary Location settings also serve as a point of reference for the secondary locations.

The following steps show you how to set the location, date and time from within World Clock. See [“Date & Time Preferences”](#) in [Chapter 22](#) for details on changing these settings from the Preference screen.

To set the primary location:

1. Tap the primary location pick list.

Primary location
pick list



2. Tap the location you want to use as the primary location.

The location you select is typically a large city in the same time zone as the one where you live. If an appropriate choice does not appear in the list, see [“Adding a location”](#) later in this chapter to create a new location.

3. Tap OK.

To set the date:

1. Tap Set Date & Time.
2. Tap the Set Date box.
3. Tap the arrows to select the current year.

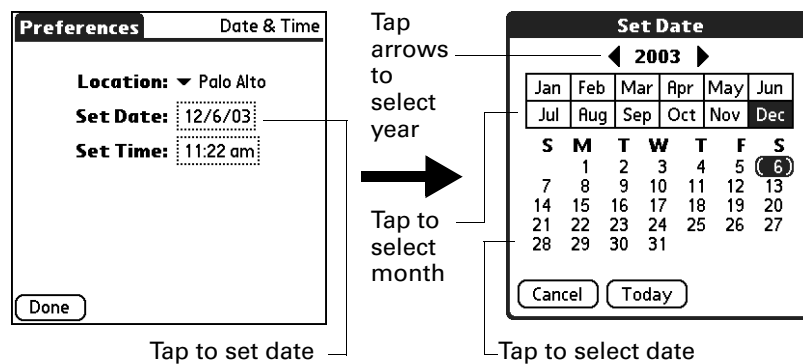

4. Tap the current month.
5. Tap the current date.
6. Tap Done.

To set the time:

1. Tap Set Date & Time.
2. Tap the Set Time box.

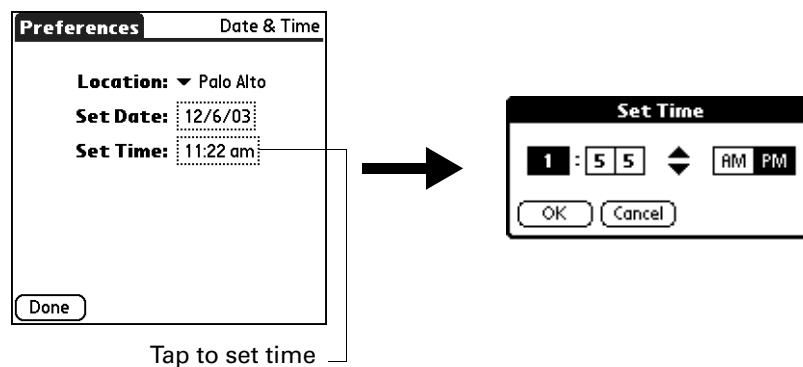

3. Tap the up or down arrows to change the hour.
4. Tap each number of the minute, and then tap the arrows to change the minutes.
5. Tap OK.
6. Tap Done.

Choosing a different primary location

If you travel to another location and you want alerts to appear based on local time, you need to change the primary location to update the system time. You may prefer, however, to use the secondary locations to view the local date and time, and to leave the primary location unchanged.

To change the primary location:

1. Tap the pick list next to the current primary location.

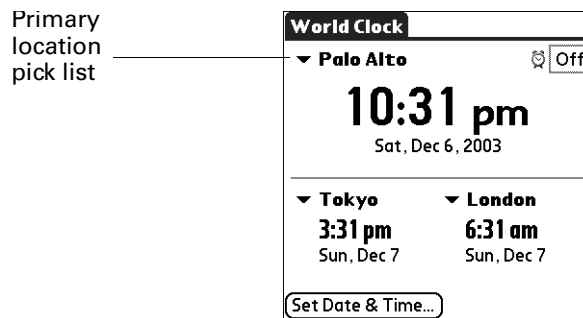

2. Tap the location you want to use as the new primary location.

If the new location is in another time zone, World Clock automatically updates the date and time in all the applications on your handheld.

Setting the secondary locations

The secondary locations display the date and time in two locations other than the primary location. You can use the secondary locations to view the time in places to which you travel or need to contact people.

The date and time in the secondary locations are based on the date and time settings in the primary location.

To select the secondary locations:

1. Tap the pick list next to the secondary location.

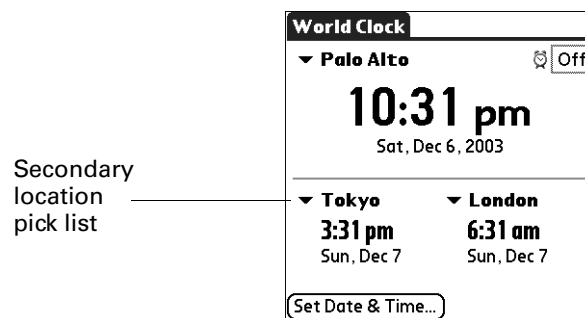

2. Tap the location you want to use as the new secondary location.

If an appropriate location does not appear in the list, see the next section, [“Adding a location”](#).

Adding a location

If an appropriate location does not appear in the Location pick list, you can add a new location to the list. When you add a location, the default Time Zone and Daylight Saving settings are usually correct. However, you can adjust these settings if necessary. When the Daylight Saving options are active, the time change automatically occurs at 1:00 AM on the selected start and end dates.

To add a location:

1. Tap a Location pick list.
2. Select Edit List.
3. Tap Add.
4. Select a location that is in the same time zone as the city you want to add.
5. Tap OK.
6. (Optional) Tap the Name field and modify the location name.
7. (Optional) Tap the Time Zone box and select a time zone.

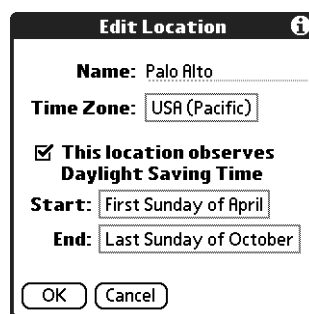

8. Tap OK.
9. Tap Done.

To set Daylight Saving options:

1. From the Edit Location dialog box, tap the This location observes Daylight Saving Time check box to select it.
2. Tap the Start box.

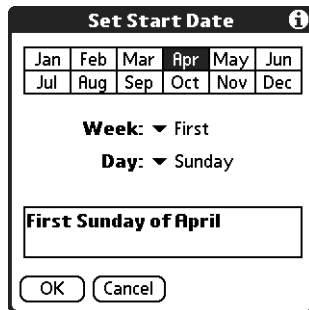

3. Tap the month when daylight saving begins.
4. Tap the Week pick list.
5. Select the week when daylight saving begins within the selected month.
6. Tap the Day pick list.
7. Select the day of the week when daylight saving begins within the selected week.
8. Tap OK.
9. Tap the End box and repeat steps 3 through 8 to select when daylight saving ends.
10. Tap OK.

Modifying a location

If you add a location and later realize you did not use the correct settings, you can modify the location.

To modify a location:

1. Tap a Location pick list.
2. Select Edit List.
3. Select the location you want to modify.
4. Tap Edit.

5. Adjust the settings. See “Adding a location” earlier in this chapter for details.
6. Tap OK.
7. Tap Done.

Removing a location

If you no longer need a location that appears in the Location list, you can remove it. However, you cannot remove a location that is currently assigned to the primary location.

To remove a location:

1. Tap a Location pick list.
2. Select Edit List.
3. Select the location you want to remove.
4. Tap Remove.
5. Tap OK to confirm the deletion.
6. Tap Done.

Setting an alarm

In addition to setting and displaying the date and time, World Clock also provides a convenient travel alarm feature. You can set an alarm to sound during the next 24-hour period.

To set an alarm:

1. Tap the box next to the Alarm  icon to open the Set Alarm dialog box.

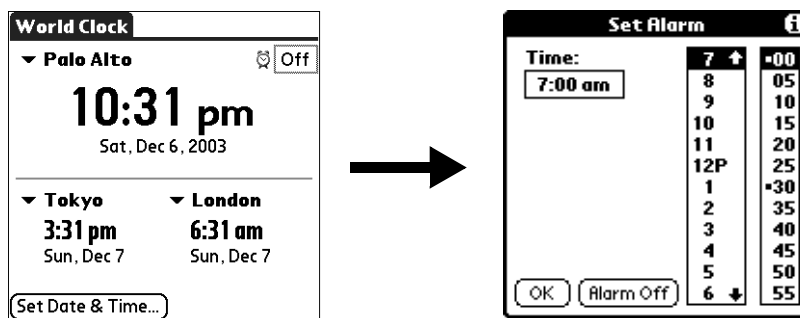

2. Tap the time columns to set the hour and minute.
3. Tap OK.

4. When the alarm reminder message appears, do one of the following:

Tap OK to permanently dismiss the reminder and return to the current screen.

Tap Snooze to dismiss the reminder and return to the current screen. An attention indicator blinks in the upper-left corner of the screen to remind you of the pending alarm, and the reminder message appears again in five minutes. When the reminder message reappears, the current time appears in the Reminder bar and the alarm time appears on the screen.

Tap Go To to open World Clock and to dismiss the alarm.

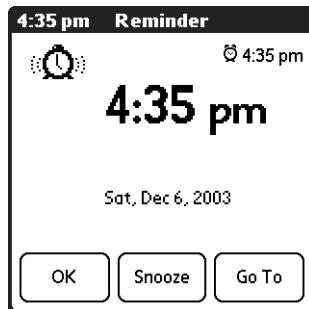

Using World Clock menus

World Clock menus are shown here for your reference, and World Clock features that are not explained elsewhere in this book are described here.

See “Using menus” in [Chapter 4](#) for information about choosing menu commands.

Options menu



Display Options Opens a dialog box where you can choose which information appears on the World Clock screen.

Show Multiple Locations: Activates the secondary location displays. When it is selected, the secondary locations appear below the primary location.

Date: Activates the date display. When it is selected, the date appears below the time for each location.

Alarm Preferences

Sound: Sets the sound of the alarm. The choices are Alarm, Bumble Bee, Reveille, Sonata, Wake Up, and Warbler.

Volume: Defines how loud the alarm sounds. The choices are Low, Medium, and High.

About World Clock

Shows version information for World Clock.

Performing HotSync® Operations

HotSync® technology enables you to synchronize data between one or more Palm OS® handhelds and Palm™ Desktop software or another personal information manager (PIM) such as Microsoft Outlook. To synchronize data, you must connect your handheld and your computer either directly or indirectly. Direct methods include placing your handheld in the cradle/cable attached to your computer, using infrared communications, or using a Bluetooth™ connection. Indirect methods include using a modem or network HotSync technology.

Selecting HotSync setup options

You can choose when HotSync Manager will run. If necessary, you can adjust the local and modem HotSync settings as well.

To set the HotSync options on a Windows computer:

1. Click the HotSync icon  in the Windows system tray (bottom-right corner of the taskbar).

If you do not see the HotSync icon, you need to start HotSync Manager: On the Windows desktop, click Start, and then select Programs. Navigate to the Palm Desktop software program group, and select HotSync Manager.

Alternatively, you can start the Palm Desktop software, which automatically opens the HotSync Manager.

2. Select Setup.

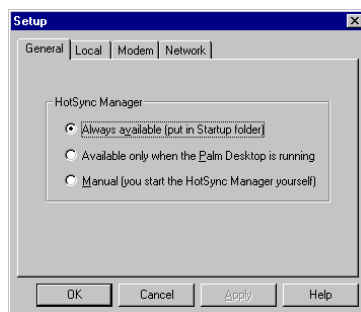

- Click the General tab, and select one of the following options:

Always available	Adds HotSync Manager to the Startup folder and constantly monitors the communication port for synchronization requests from your handheld. With this option the HotSync Manager synchronizes data even when Palm Desktop software is not running.
Available only when the Palm Desktop software is running	Starts HotSync Manager and monitors requests automatically when you open Palm Desktop software.
Manual	Monitors requests only when you select HotSync Manager from the Start menu.

If you're not sure which option to use, keep the default setting: Always available.

- If you are using a serial cradle/cable, click the Local tab to display the settings for the connection between your computer and the handheld cradle/cable, and adjust the following options as needed.

If you are using the USB cradle/cable, you do not need to use the settings on the Local tab for a direct HotSync operation.

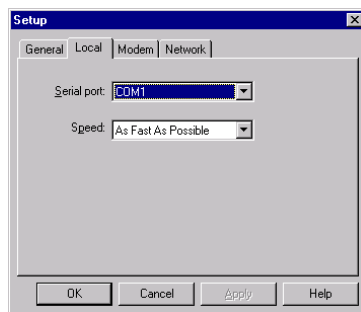

Serial Port Identifies the port that HotSync Manager uses to communicate with the cradle/cable. If necessary, you can change the port selection.

Your handheld cannot share this port with an internal modem or other device.

Speed Determines the speed at which data is transferred between your handheld and Palm Desktop software. Try the As Fast As Possible rate first, and adjust downward if you experience problems. This setting allows your handheld to synchronize with computer at the fastest speed possible.

5. Click the Modem tab to display the modem settings and adjust the options as needed. For more information, see [“Conducting modem HotSync operations”](#) later in this chapter.
6. If you are attached to a network, click the Network tab to display the network settings and adjust the options as needed. For more information, see [“Conducting network HotSync operations”](#) later in this chapter.
7. Click OK.

To set the HotSync options on a Mac computer:

1. Double-click the HotSync Manager icon in the Palm folder.
2. Click the HotSync Controls tab, and select any of the following options.

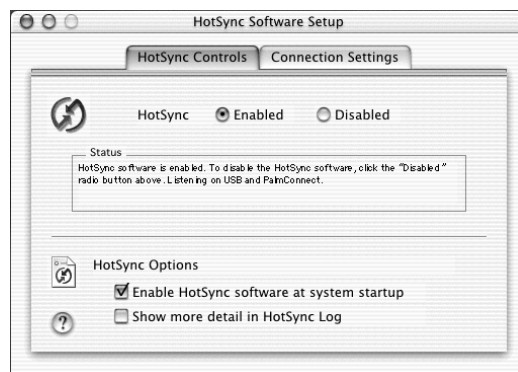

Shown with Mac OS X

HotSync Enabled/Disabled

Activates the transport monitor and prepares your Mac computer to synchronize with your handheld. By default, the transport monitor is enabled listen on USB and PalmConnect whenever you start your computer.

If you are using Mac OS 9.1 and the optional serial HotSync cradle/cable and you use the same serial port for other devices besides the HotSync cradle/cable, disable the transport monitor and then enable it manually only when you connect the cradle/cable to perform a HotSync operation.

Enable HotSync software at system startup

Activates the transport monitor automatically each time you start your computer. If this option is not selected, you must open HotSync Manager and select the Enabled option before you can perform a HotSync operation.

Show more detail in HotSync Log

Includes more troubleshooting information in the log that is generated when you perform a HotSync operation.

- If you are using the USB cradle/cable, you do not need to adjust the settings on the Connection Settings tab for a direct HotSync operation; they are set automatically when you perform the first HotSync operation.

If you are using Mac OS 9.1 and the optional serial cradle/cable, click the Connection Settings tab and select the port where you attached the cradle/cable.

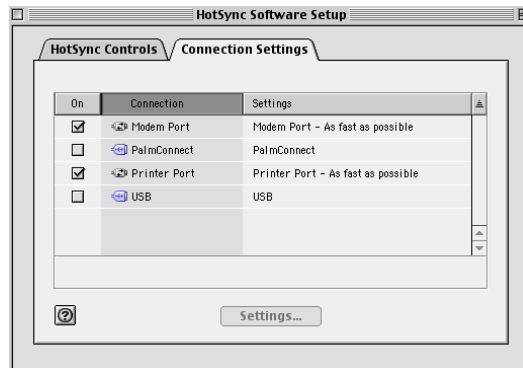

Shown with Mac OS 9.1

You can set both Modem and Printer port settings and prepare your computer to synchronize with your handheld using the HotSync cradle/cable or a modem. However, choosing both setups prevents you from using either port for other operations such as printing, faxing, or AppleTalk networking.

- Close the HotSync Software Setup window.

Customizing HotSync application settings

For each application, you can define a set of options that determines how records are handled during synchronization. These options are called a *conduit*. By default, a HotSync operation synchronizes all files between the handheld and Palm Desktop software.

In general, you should leave the settings to synchronize all files. The only reason you might want to change these settings is to overwrite data on either your handheld or Palm Desktop software, or to avoid synchronizing a particular type of file because you don't use it.

In addition to the conduits for Date Book, Address Book, To Do List, Memo Pad, Note Pad, Voice Memo, and Palm™ Photos, Palm Desktop software includes System and Install conduits. The System conduit backs up the system information stored on your handheld, including Graffiti® 2 ShortCuts. The Install conduit installs add-on applications on your handheld.

To customize HotSync application settings on a Windows computer:

1. Click the HotSync icon  in the Windows system tray (bottom-right corner of the taskbar).

You can also click the HotSync command on the Palm Desktop software menu bar.

2. From the HotSync Manager menu, select Custom.
3. Select the appropriate user name from the list.
4. Select an application in the Conduit list.
5. Click Change.

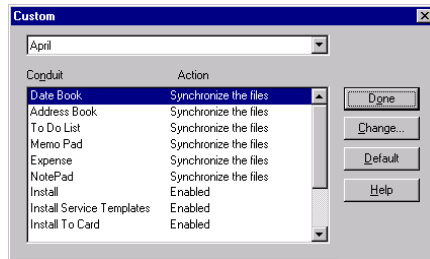

6. For each application, click the direction in which you want to write data, or click Do Nothing to skip data transfer for an application.

Changing the HotSync setting from the default affects only the *next* HotSync operation. Thereafter, the HotSync Actions revert to their default settings. To use a new setting on an ongoing basis, select the Set As Default box. Thereafter, whatever you selected as the default setting is used when you click the Default button in the Custom dialog box.

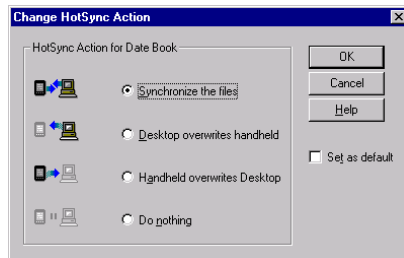

7. Click OK.
8. Click Done to activate your settings.

To customize HotSync application settings on a Mac computer:

1. Double-click the Palm Desktop icon in the Palm folder.
2. From the HotSync menu, select Conduit Settings.
3. From the User pop-up menu, select the appropriate user name.
4. Select an application in the Conduit list.
5. Click Conduit Settings.

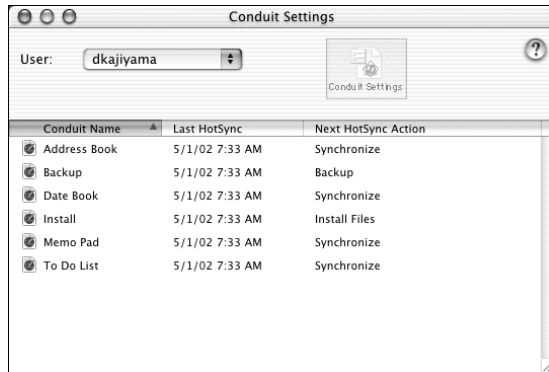

Shown with Mac OS X

6. For each application, click the direction in which you want to write data, or click Do Nothing to skip data transfer for an application.

Changing the HotSync setting from the default affects only the *next* HotSync operation. Thereafter, the HotSync Actions revert to their default settings. To use a new setting on an ongoing basis, click Make Default. Thereafter, whatever you selected as the default setting is used for HotSync operations.

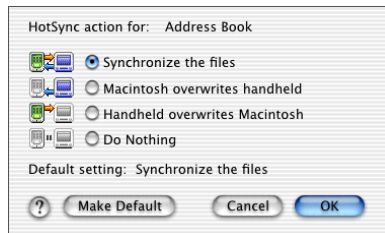

Shown with Mac OS X

7. Click OK.
8. Close the Conduit Settings window.

Conducting cradle/cable HotSync operations

The simplest way to synchronize data is to perform a direct HotSync operation by seating your handheld in the cradle/cable and pressing the HotSync button.

Performing a cradle/cable HotSync operation: Windows computers

The first time you synchronize your data, you need to enter user information on Palm Desktop software. After you enter this information and synchronize with your handheld, the HotSync Manager recognizes your handheld and doesn't ask for this information again.

If you are a system administrator preparing several handhelds for a group of users, you may want to create a user profile. See [“Creating a user profile”](#) later in this chapter before performing the following steps.

IMPORTANT You must perform your *first* HotSync operation with a local, direct connection or with infrared communication, rather than with a modem or network.

The following steps assume that you have already installed Palm Desktop software. If you have not installed this software, see [“Step 4: Install software”](#) in [Chapter 1](#) for instructions.

To perform a local HotSync operation on a Windows computer:

1. Place your handheld in the cradle/cable.

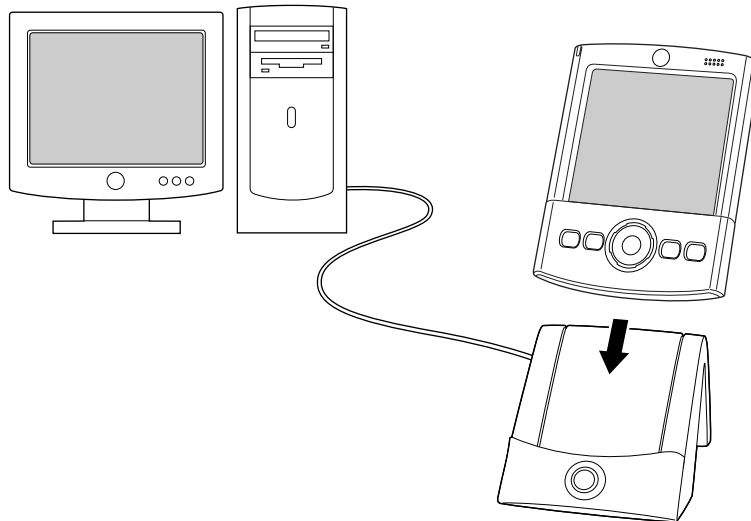

2. If the HotSync Manager is not running, start it: On the Windows desktop, click Start, and then select Programs. Navigate to the Palm Desktop software program group, and select HotSync Manager. Alternatively, you can start the Palm Desktop software, which automatically opens the HotSync Manager.

3. Press the HotSync button  on the cradle/cable.

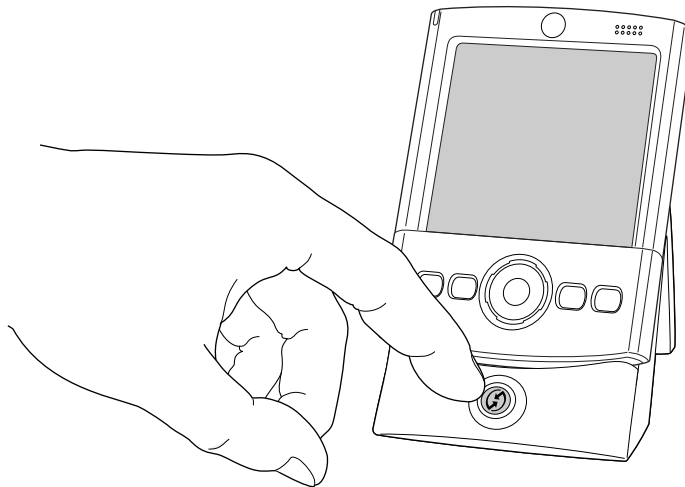

IMPORTANT The first time you perform a HotSync operation, you must enter a user name in the New User dialog box and click OK. Every handheld should have a unique name. To prevent loss of a user's records, never try to synchronize more than one handheld to the same user name.

The HotSync Progress dialog box appears, and synchronization begins.

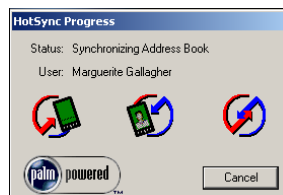

4. Wait for a message on your handheld indicating that the process is complete.
After the HotSync process is complete, you can remove your handheld from the cradle/cable. Gently tilt your handheld forward in the cradle/cable, and then lift it up to remove it.

Performing a direct HotSync operation: Mac computers

When you installed Palm Desktop software, you entered a user name. This user name is the connection between your handheld and your computer.

The first time you perform a HotSync operation the Palm Desktop software does the following:

- Adds a user name to your handheld.
- Creates a folder for the user name in the Users folder inside the Palm folder. For example, if you entered Jane Garcia as your user name, a folder named Jane Garcia is created in the Users folder.

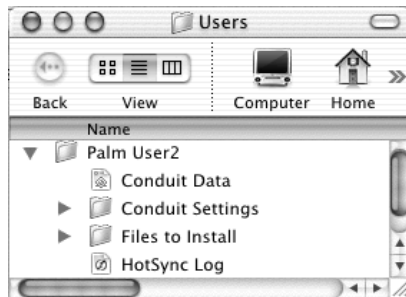

Shown with Mac OS X

- Creates a file named User Data in your user name folder.

User names appear in the User pop-up menu on the right side of the toolbar. You can change users by selecting a new name in the pop-up menu.

Each subsequent time you perform a HotSync operation, HotSync Manager reads the user name from your handheld and synchronizes the data in the folder of the same name.

Be sure you select the correct user name from the User pop-up menu before entering data on Palm Desktop or performing a HotSync operation.

If you are a system administrator preparing several handhelds for a group of users, you may want to create a user profile. See [“Creating a user profile”](#) later in this chapter before performing the following steps.

IMPORTANT You must perform your *first* HotSync operation with a local, direct connection or with infrared communication, rather than with a modem.

The following steps assume that you have already installed Palm Desktop software. See [“Step 4: Install software”](#) in [Chapter 1](#) if you have not installed this software.

To perform a local HotSync operation on a Mac computer:

1. Place your handheld in the HotSync cradle/cable.

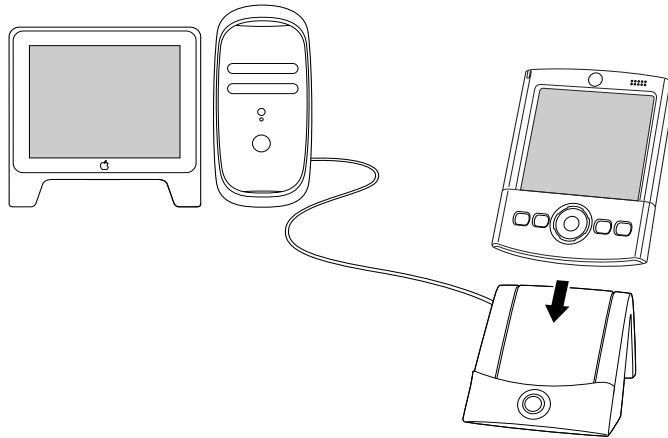

2. Make sure that HotSync Manager is enabled: Double-click the HotSync Manager icon in the Palm folder. Click the HotSync Controls tab, and make sure the Enabled option is selected.
3. Press the HotSync button  on the cradle/cable.

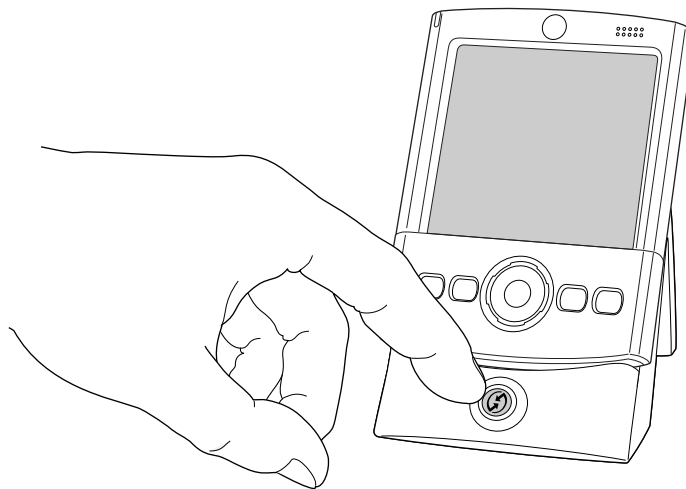

The HotSync Progress dialog box appears, followed by the Select User dialog box.

- In the Select User dialog box, select the user name you entered when you installed the Palm Desktop software, and click OK.

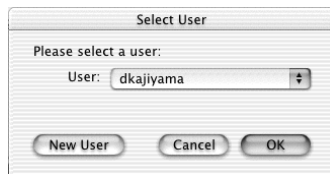

Shown with Mac OS X

The HotSync Progress dialog box reappears, and synchronization begins.

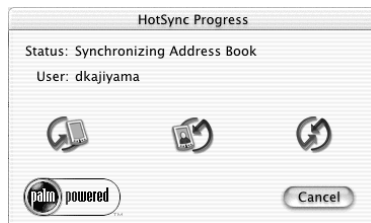

Shown with Mac OS X

- Wait for a message on your handheld indicating that the process is complete.

After the HotSync process is complete, you can remove your handheld from the cradle/cable. Gently tilt your handheld forward in the cradle/cable, and then lift it up to remove it.

Conducting IR HotSync operations

You can use the infrared (IR) port on your handheld to perform HotSync operations. When you perform an IR HotSync operation, you don't need your cradle/cable. However, you must have a computer that's equipped with an IR port and that supports the IrCOMM implementation of the Infrared Data Association (IrDA) standards. This is especially useful if you travel with an infrared-enabled laptop. You simply enable infrared communication on your laptop and handheld and follow the steps in ["Performing an IR HotSync operation"](#) later in this section.

Preparing your computer for infrared communication

Before you can perform a HotSync operation using the IR port, the computer with which you want to synchronize must fulfill these requirements:

- Your computer must support the IrCOMM implementation of the IrDA standards.
- Your computer must have an enabled infrared port that's built into the computer, or an enabled infrared device attached to the computer.

- Some desktop computers may require an infrared device attached to a physical COM port. Laptops are likely to have a built-in IR port, so no external device is necessary.
- Your computer must have an installed infrared driver.
- If you have an external infrared device attached to your computer, a driver is probably included with the device. Consult the documentation included with the device for information on installing the required driver.

Check your computer's documentation to learn if the computer supports infrared communication.

To configure HotSync Manager for infrared communication on a Windows computer:

- Click the HotSync Manager icon  in the Windows system tray, and make sure that Infrared is selected.
 - If you have an Infrared option on the HotSync Manager menu, and that option is selected, skip to [“Performing an IR HotSync operation.”](#)
 - If you do not have an Infrared option on the HotSync Manager menu, complete the following steps:
 - a. Make sure that Local Serial is selected on the menu.
 - b. From the HotSync Manager menu, select Setup.
 - c. Click the Local tab.
 - d. In the Serial Port drop-down box, select the simulated port that your computer uses for infrared communication.

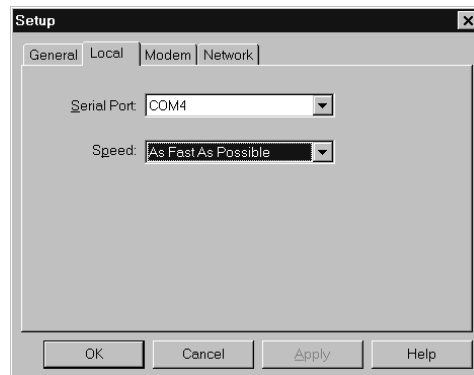

See the documentation for your operating system for instructions on finding the simulated port. This information is usually located in the Control Panel.

- e. Click OK.

NOTE If your cradle/cable is connected to a USB port, you can continue using the cradle/cable while HotSync Manager is configured for infrared communication. If your cradle/cable is connected to a serial port, you cannot use your HotSync cradle/cable again until you reconfigure the HotSync Manager to communicate with the port defined for cradle/cable synchronization.

To configure HotSync Manager for infrared communication on a Mac computer:

1. Double-click the HotSync Manager icon in the Palm folder.
2. In the HotSync Controls tab, select Enabled.
3. Click the Connection Settings tab.
4. Select the On check box next to IR port.

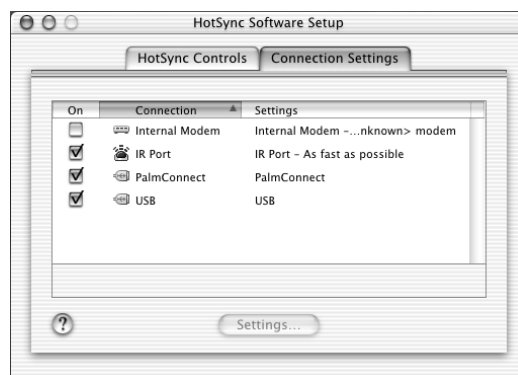



Shown with Mac OS X

5. Close the HotSync Software Setup window.

Performing an IR HotSync operation

After you complete the steps to prepare for performing an IR HotSync operation, it's easy to perform the actual operation.

To perform an IR HotSync operation:

1. Tap the Home icon .
2. Select the HotSync icon .
3. Tap Local.
4. Tap the pick list below the HotSync icon and select IR to a PC/Handheld.
5. Position the IR port of your handheld within a couple of inches of the infrared port of your computer.

6. Tap the HotSync icon to start the IR HotSync operation.

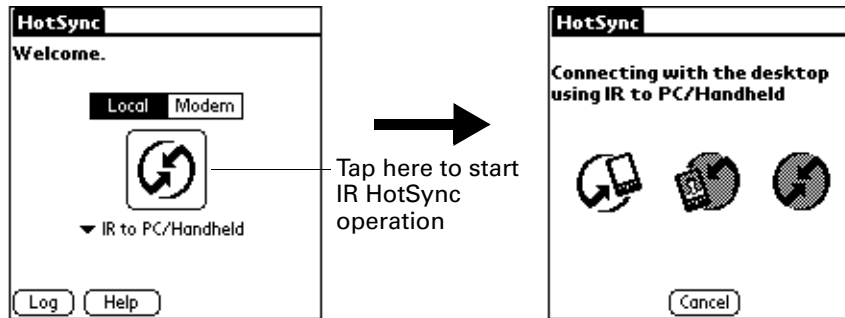

Returning to cradle/cable HotSync operations

It's easy to return to using the cradle/cable for HotSync operations.

If your cradle/cable is connected to a USB port, you can continue using it while HotSync Manager is configured for infrared communication. Use the following instructions to return to Local USB cradle/cable HotSync operations only when necessary, such as when you have disconnected the cradle/cable from the USB port.

To return to local USB cradle/cable HotSync operations on a Windows computer:

1. If necessary, connect the cradle/cable to the USB port of the computer you use for HotSync operations.
2. Click the HotSync Manager icon  in the Windows system tray, and select Local USB if it is not already selected.

To return to local Serial cradle/cable HotSync operations on a Windows computer:

1. If necessary, connect the cradle/cable to the port of the computer you use for HotSync operations.
2. Click the HotSync Manager icon  in the Windows system tray.
3. Select Setup, and then click Local.
4. Select the COM port where your cradle/cable is connected.
5. Click OK.

On a Mac computer, the HotSync Manager software monitors all ports at the same time. However, you may want to turn off the IR port when you're not using it to improve performance of HotSync operations.

To return to local serial cradle/cable HotSync operations on a Mac computer:

1. If necessary, connect the cradle/cable to a serial port on your computer.
2. Double-click the HotSync Manager icon in the Palm folder.
3. In the HotSync Controls tab, select Enabled.

4. Click the Connection Settings tab, and select the correct connection.
5. Close the HotSync Software Setup window.

The next time you want to perform a HotSync operation, just press the HotSync button on the cradle/cable, as you always did before.

Conducting modem HotSync operations

You can use a modem to synchronize your handheld when you are away from your computer.

IMPORTANT You must perform the first HotSync operation by using a local, direct connection or infrared communication. After that, you can perform a modem HotSync operation.

To perform a modem HotSync operation you need the following:

- A modem connected to your computer.
- Palm Desktop software configured for use with the modem.
- A modem connected to your handheld.
- A configuration for the kind of modem connection you want to make. See [“Connection Preferences”](#) in [Chapter 22](#) for more information.

Preparing your computer for a modem HotSync operation

There are a few steps you must perform to prepare your computer for a modem HotSync operation. Be sure to perform these steps before you leave your office so that your computer is ready to receive a call from your handheld.

To prepare a Windows computer for a modem HotSync operation:

1. Confirm that the computer modem is connected and turned on and that no communications applications, such as fax or telephony software, are running on a COM port.

Make sure the computer is disconnected from all online services, such as America Online (AOL). This helps to avoid conflicts with the COM port.

2. Start HotSync Manager if it is not already running, and from the HotSync Manager menu, select Modem.

- Adjust the following options as needed.

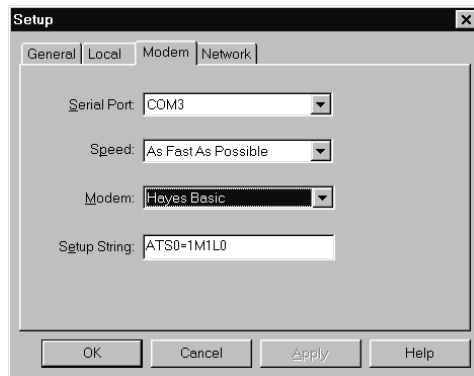

- | | |
|---------------------|---|
| Serial Port | Identifies the port for the modem. If you are unsure of the port assignment, look at the Modem Properties in the Windows Control Panel. |
| Speed | Determines the speed at which data is transferred. Try the As Fast As Possible rate first, and adjust downward if you experience problems. This setting allows your handheld to synchronize with your computer at the fastest speed possible. |
| Modem | Identifies the modem type or manufacturer. Refer to your modem manual or faceplate for its type or settings. If you're not sure of your modem type or if your modem doesn't match any that appear in the list, select Hayes Basic. |
| Setup String | Identifies the setup string for your particular modem. Not all modems require a setup string. Refer to your modem manual, and enter the setup string if it is recommended by the manufacturer. |

- Click OK.

To prepare a Mac computer for a modem HotSync operation:

- Confirm that the computer modem is connected and turned on, and that no communications applications, such as fax or telephony software, or AppleTalk networking are running on that serial port.

Make sure your computer is disconnected from all online services, such as CompuServe and America Online (AOL). This helps to avoid conflicts with the serial port. In addition, your computer must be on, and it should not be in sleep mode when receiving a call from a remote handheld.

- Double-click the HotSync Manager icon in the Palm folder.
- Click the HotSync Controls tab and enable the Transport Monitor, if it is not already enabled.

4. Click the Connection Settings tab.
5. Select the On check box for the modem connection you're using, and then click Settings.
6. In the Settings dialog box, select Modem as the connection type, if it is not already selected.

NOTE This step is not necessary for internal modems.

7. Adjust the following options as needed.

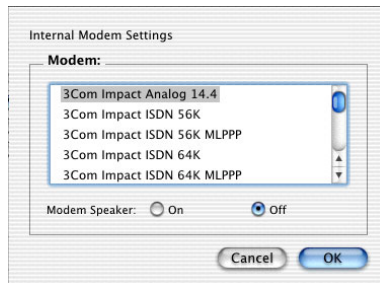

Shown with Mac OS X

Modem Identifies the type of modem connected to your computer. If your modem does not appear on the list, use the Hayes Basic setting, or select Custom to enter a command string. Refer to the manual that came with your modem to find the appropriate command string.



Modem Speaker Activates the modem's speaker. If you are having trouble connecting, turn on this option to make sure that the modem connected to your computer is responding to incoming calls.

8. Click OK.
9. Close the HotSync Software Setup window.

Preparing your handheld for a modem HotSync operation

There are a few steps you must perform to prepare your handheld for a modem HotSync operation.

To prepare your handheld for a modem HotSync operation:

1. Tap the Home icon .
2. Select the HotSync icon .
3. Tap Modem.

4. Tap the pick list below the icon and select a modem configuration.

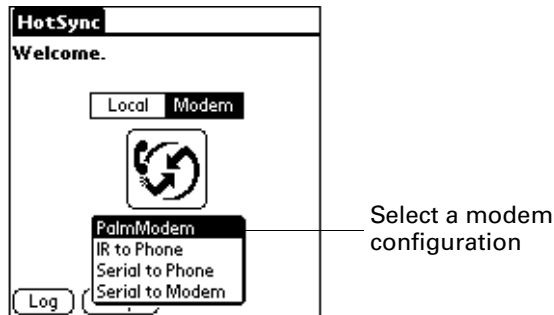

If you need to create a configuration, tap the Menu icon , and then select Connection Setup on the Options menu. See [“Connection Preferences”](#) in [Chapter 22](#) for more information.

5. Tap the Enter phone # field.

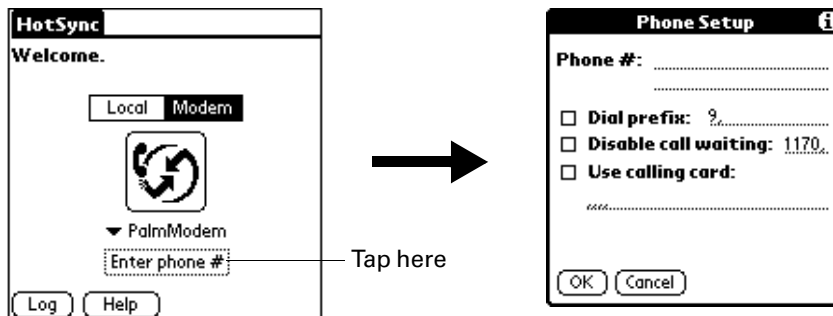

If you plan to connect to your company’s dial-in server (network modem) instead of connecting to a computer modem, see [“Conducting network HotSync operations”](#) later in this chapter.

6. Enter the telephone number to access the modem connected to your computer.
7. If necessary, enter a dial prefix (such as “9”) to access an outside line, and then tap the Dial Prefix check box.



TIP You can enter a comma in the field to introduce a “pause” in the dialing sequence. Each comma equals a two-second pause.

8. If the phone line you’re using for the handheld has Call Waiting, select the Disable call waiting check box to avoid an interruption during the modem HotSync operation.
9. If you want to use a calling card to place the call, select the check box and enter the calling card number.
10. Tap OK.

Selecting the conduits for a modem HotSync operation

The Conduit Setup dialog box on your handheld enables you to define which files and/or applications synchronize during a modem HotSync operation. You can use these settings to minimize the time required to synchronize data with a modem.

To change the Conduit Setup for a modem HotSync operation:

1. Tap the Home icon .
2. Select the HotSync icon .
3. Tap the Menu icon .
4. Select Conduit Setup on the Options menu.
5. Tap the check boxes to deselect the files and applications that you do *not* want to synchronize during a modem HotSync operation. The default setting is to synchronize all files.

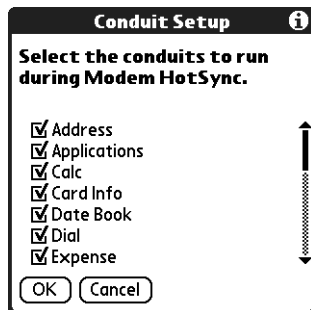



Applications that do not have a database (such as games) do not synchronize, even if you select the item in the Conduit Setup dialog box.

6. Tap OK.

Performing a modem HotSync operation

After you prepare your computer and your handheld and select your Conduit Setup options, you are ready to perform a modem HotSync operation.

To perform a modem HotSync operation:

1. Tap the Home icon .
2. Select the HotSync icon .
3. Tap the Modem icon  to dial the Palm Desktop modem and synchronize the applications.
4. Wait for the HotSync operation to complete. If you have any problems conducting a successful HotSync operation, see [“HotSync problems”](#) in [Appendix B](#).

Conducting Bluetooth HotSync operations

If you have a Bluetooth computer running Windows 98/Me/NT/2000 or Mac OS X, version 10.1.2 or later with the Apple Bluetooth software, you can use Bluetooth technology to perform wireless HotSync operations.

NOTE Go to the web site www.palm.com/support/globalsupport for additional information on compatibility with other versions of the Windows operating system.

Preparing your computer for a Bluetooth HotSync operation

There are a few steps you must perform to prepare your computer for a Bluetooth HotSync operation.

To prepare your Windows computer for a Bluetooth HotSync operation:

1. Use the Bluetooth setup software on your computer to open or create a virtual serial port for Bluetooth communication. See the documentation included with your computer for instructions on changing port settings or configuring the Bluetooth serial host.
2. Click the HotSync Manager icon  in the Windows system tray, and then select Setup.

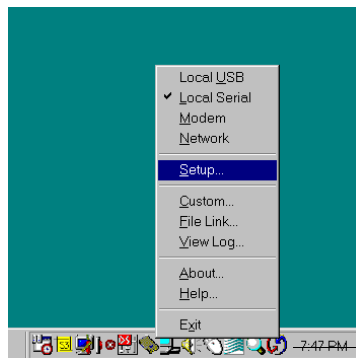

Click the HotSync Manager icon

3. Click the Local tab.

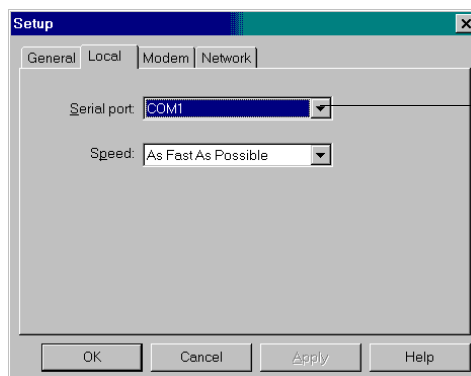

Select the port from the drop-down list

4. In the Serial port drop-down box, select the virtual serial port you chose or created in step 1.
5. Click OK.

To prepare your Mac computer for a Bluetooth HotSync operation:

1. Double-click the HotSync Manager icon in the Palm folder.
2. In the HotSync Controls tab, select Enabled.
3. Click the Connection Settings tab, and select the On check box next to bluetooth-pda-sync-port.

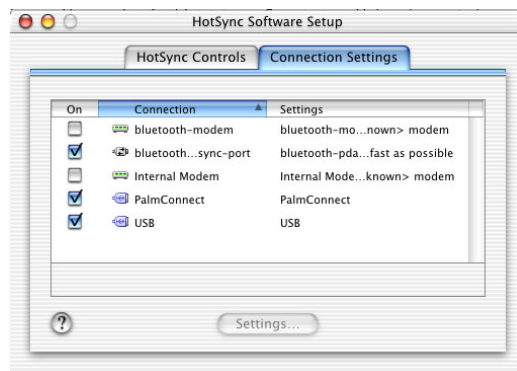

Shown with Mac OS X

4. Close the HotSync Software Setup window.

Preparing your handheld for a Bluetooth HotSync operation

There are a few steps you must perform to prepare your handheld for a Bluetooth HotSync operation.

To prepare your handheld for a Bluetooth HotSync operation:

1. Create a trusted pair with your computer. See [“Adding trusted devices”](#) in [Chapter 22](#) for details.
2. Create a connection with your computer. See [“Creating Bluetooth connections”](#) in [Chapter 22](#) for details.
3. Tap the Home icon .

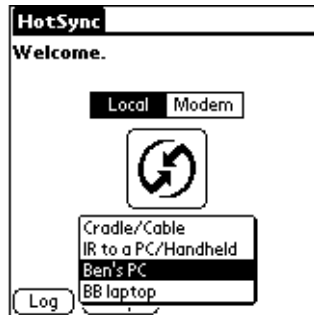

4. Select the HotSync icon .
5. Tap the pick list in the center of the screen and select the connection settings you just created.



Performing a Bluetooth HotSync operation

After you prepare your computer and your handheld, you are ready to perform a Bluetooth HotSync operation.

To perform a Bluetooth HotSync operation:

1. Tap the Home icon .
2. Select the HotSync icon .
3. Tap the HotSync icon in the center of the screen.

Conducting network HotSync operations

When you use the network HotSync technology, you can take advantage of the LAN and WAN connectivity available in many office environments. Network HotSync technology enables you to perform a HotSync operation by using Bluetooth technology or an 802.11 accessory to make a wireless connection to a network, by dialing in to a network, or by using a cradle/cable that is connected to any computer on your LAN or WAN (provided that the computer connected to the cradle/cable also has the network HotSync technology installed, your computer is on, and the HotSync Manager is running).

IMPORTANT Network HotSync technology is available only on Windows computers. You must perform the first HotSync operation by using a local, direct connection or infrared communication. After that, you can perform a network HotSync operation.

Connecting to your company's dial-in server

A network HotSync operation requires the following (consult your system administrator for assistance):

- Your computer has TCP/IP support installed.
- Both your company's network system and its remote access server support TCP/IP.
- You have a remote access account.

Everything you need for connecting to your company's dial-in server (network modem) is included with Palm Desktop software and handheld software. You need to activate the feature, however, on both Palm Desktop software and your handheld.

To prepare your Windows computer for a network HotSync operation:

1. Click the HotSync Manager icon  in the Windows system tray.
2. From the HotSync Manager menu, select Network.

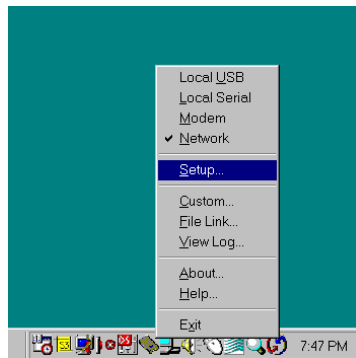

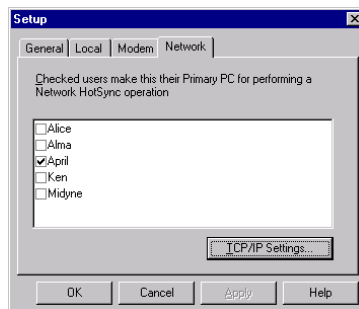

3. From the HotSync Manager menu, select Setup.
4. Click the Network tab and make sure your user name has a checkmark next to it. If the checkmark is not there, click the check box next to your user name.



5. Click OK.
6. Put your handheld in the cradle/cable, and perform a HotSync operation.

The HotSync operation records network information about your computer on your handheld. With this information, your handheld can locate your computer when you perform a HotSync operation over the network.

To prepare your handheld for a network HotSync operation:

1. Tap the Home icon .
2. Select the HotSync icon .
3. Tap the Menu icon .
4. Select Modem Sync Prefs on the Options menu.
5. Tap Network.

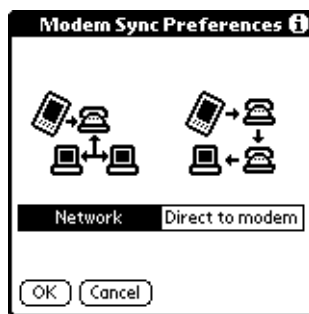

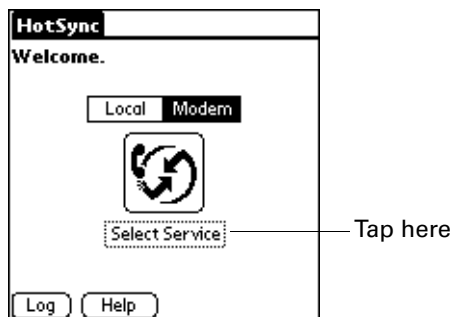

6. Tap OK.
7. Tap Select Service.

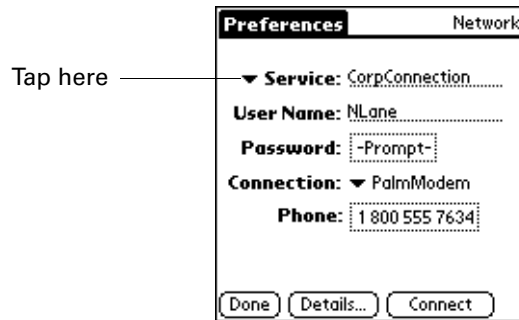

NOTE See “Network Preferences” in [Chapter 22](#) for information on creating a network or Bluetooth connection.

8. Tap Service and select a service.



9. Tap Done.
10. Tap the Menu icon .
11. Select Conduit Setup on the Options menu.

For instructions, see [“Selecting the conduits for a modem HotSync operation”](#) earlier in this chapter.

Performing a network HotSync operation

After you prepare your computer and your handheld and select your Conduit Setup options, you are ready to perform a network HotSync operation.

To perform a network HotSync operation:

- Tap the modem HotSync icon to begin the operation.

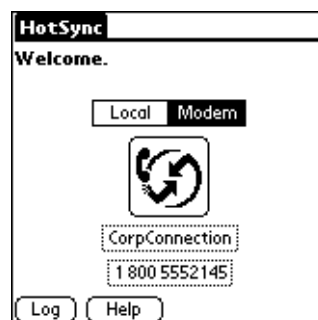

Using File Link

The File Link feature enables you to import Address Book and Memo Pad information onto your handheld from a separate external file such as a company phone list. HotSync Manager stores the data in a separate category on your Palm Desktop software and your handheld. You can configure the File Link feature to check for changes to the external file when you perform a HotSync operation.

With File Link you can import data stored in any of the following formats:

- Comma-separated (*.csv)
- Memo Pad archive (*.mpa)
- Address Book archive (*.aba)
- Text (*.txt)

For information on how to set up a file link, see the Palm Desktop online Help.

NOTE The File Link feature is not available in Palm Desktop software for Mac.

Creating a user profile

A user profile enables you to install the same set of data onto multiple Palm OS handhelds before each handheld is individualized with a specific user name and data file.

A handheld that is preconfigured with a user profile can be given to anyone because the handheld is not yet identified by a unique user name. The handheld acquires a unique user name when the new user performs his or her first local HotSync operation.

For example, suppose a sales organization wants to distribute two dozen handhelds that all have a common company phone list, a set of memos, and several key applications. A user profile can be created to install the common data before the handhelds are distributed to the employees who will use them. Then when the employees perform their first HotSync operation, the common data becomes part of their individual data file.

NOTE The handhelds that are synchronized with a user profile must be either new ones that have never been synchronized or handhelds that have had their user names and data removed by a hard reset.

To create a user profile on a Windows computer:

1. Open Palm Desktop software.
2. From the Tools menu, select Users.
3. Click Profiles.
4. Click New.

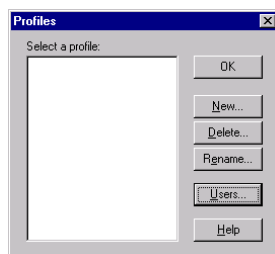

5. Enter a unique name for the profile, and click OK.



6. Repeat steps 3 and 4 for each profile that you want to create, and then click OK to return to Palm Desktop software.
7. Select the profile from the User list, and create the data for the profile (such as a company phone list, and so on).

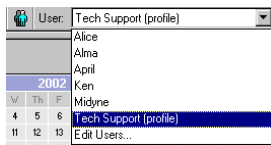

To create a user profile on a Mac computer:

1. Open Palm Desktop software.
2. From the User pop-up menu, select Edit Users.
3. Click New Profile.

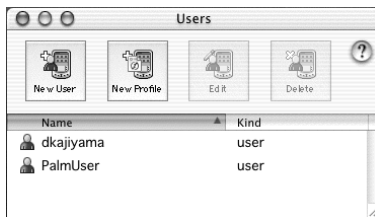

Shown with Mac OS X

4. Enter a unique name for the profile, and click OK.



Shown with Mac OS X

5. Close the Users window.
6. From the User pop-up menu, select the new profile.
7. Create the data for the profile (such as a company phone list).
8. From the HotSync menu, select Conduit Settings.
9. Select the conduit settings for the profile. For details, see [“Customizing HotSync application settings”](#) earlier in this chapter.

Performing the first HotSync operation with a user profile

After you create a user profile, you are ready to transfer the information to the new handheld during the first HotSync operation.

To use a profile for a first-time HotSync operation on a Windows computer:

1. Place the new handheld in the cradle/cable.
2. Press the HotSync button  on the cradle/cable.
3. Click Profiles.
4. Select the profile you want to load on the handheld, and click OK.



5. Click Yes to transfer all the profile data to the handheld.

The next time you perform a HotSync operation, Palm Desktop software prompts you to assign a user name to the handheld.

To use a profile for a first-time HotSync operation on a Mac computer:

1. Connect the new handheld to the HotSync cradle/cable.
2. Press the HotSync button  on the cradle/cable.
3. Select the profile you want to load on the handheld, and click OK to transfer all the profile data to the handheld.

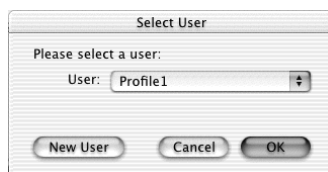

Shown with Mac OS X

The next time you perform a HotSync operation, Palm Desktop software prompts you to assign a user name to the handheld.

Setting Preferences for Your Handheld

Preferences enable you to customize the configuration options on your handheld. The options are grouped into three categories: General, Communication, and Personal. Each category provides access to a list of relevant Preferences screens. Use preferences to do the following:

- Access the General Preferences screens to customize any of the following settings:

Date & Time	Set the location, date, and time.
Digitizer	Calibrate the screen on your handheld.
Formats	Set the country default and the formats for times, dates, calendar, and numbers.
Graffiti 2	Select alternate strokes for selected Graffiti® 2 characters.
Power	Set these features: auto-shutoff interval, Stay on in cradle, Beam receive, Power on when opened, and Power off when closed.
Sounds & Alerts	Select system, game, and alarm options from three profiles: Custom, Silent, and All Off.
Writing Area	Enable and disable Writing Area Preferences and show or hide penstrokes while writing Graffiti 2 characters.

- Access the Communication Preferences screens to customize any of the following settings:

Bluetooth	Turn Bluetooth™ communication on and off, assign a name to your handheld, and configure device discovery and wakeup settings.
Connection	Configure communication settings.
Network	Configure your handheld for use with a network.
Phone	Select a connection for use with wireless data and phone applications on your handheld.



- Access the Personal Preferences screens to customize any of the following settings:

Buttons	Assign an application to the Favorites icon. Reassign various applications to the following: the application buttons on the front and side panels of your handheld, the HotSync® button on the cradle/cable, and the full-screen pen stroke command.
Color Theme	Select a color theme to change the appearance of your handheld screen.
Owner	Enter your name, phone number, and other owner information to your handheld.
Security	Set a password, privacy options, and locking options.
ShortCuts	Define a list of Graffiti 2 abbreviations.

Setting General Preferences

The General Preferences category enables you to access screens where you can modify Date & Time, Digitizer, Formats, Graffiti 2, Power, Security, Sounds & Alerts, and Writing Area settings. This section provides details about each of these screens.

To open the General Preferences screens:

1. Tap the Home icon .
2. Tap the Prefs icon .
3. From the General Preferences list select the name of the Preferences screen you want to view.



TIP You can also press Left, Right, Up, and Down on the navigator to highlight a Preferences screen name and then press Select on the navigator to open that Preferences screen.

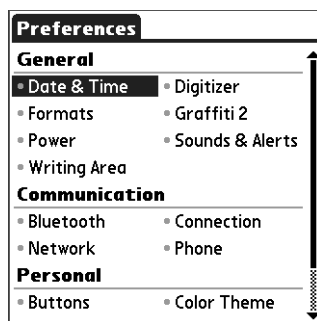

Date & Time Preferences

The Date & Time Preferences screen enables you to choose a primary location and to set the date, time, and time zone for that location. You can also indicate whether this location observes daylight saving time and the dates daylight saving time starts and ends. All of these settings also appear as the primary location in the World Clock application and are used by all the applications on your handheld.

Although you can change the primary location settings from the Date & Time Preferences screen, we recommend that you use the World Clock application to change these settings. See [“Setting the primary location”](#) in [Chapter 20](#) for details.

To set the location:

1. From the General Preferences list, select Date & Time.
2. Tap the Location pick list and select the location you want to use as your primary location.

The location you select should be a large city in the same time zone as the one where you live. If an appropriate choice does not appear in the list, see [“Adding a location”](#) in [Chapter 20](#) to create a new location.

3. Tap Done.

When you travel, changing the primary Location setting automatically resets the date and time on your handheld based on the local time zone, but it does not change the time of appointments set in Date Book.

To set the date:

1. From the General Preferences list, select Date & Time.
2. Tap the Set Date box.
3. Tap the arrows to select the current year.

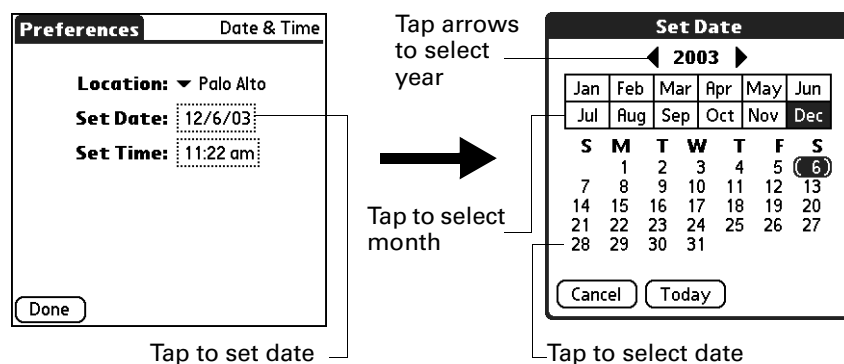

4. Tap the current month.
5. Tap the current date.
6. Tap Done.

To set the time:

1. From the General Preferences list, select Date & Time.
2. Tap the Set Time box.

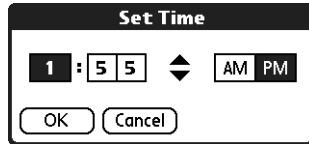

3. Tap the up or down arrows to change the hour.
4. Tap each minute number, and then tap the arrows to change them.
5. Tap OK.
6. Tap Done.

To set the time zone and daylight saving time:

1. From the General Preferences list, select Date & Time.
2. Tap the Location pick list.
3. Select Edit List.
4. Select the location where you want to set the time zone.
5. Tap Edit to open the Edit Location dialog box.
6. Follow the steps under [“Adding a location”](#) in [Chapter 20](#) to select the time zone and daylight saving time settings.
7. Tap Done.

Digitizer Preferences

The Digitizer Preferences screen opens the digitizer calibration screen. This is the same screen that appears when you start your handheld for the first time.

You can recalibrate your screen after a hard reset or if your digitizer drifts. You may need to repeat this process a few times until the calibration registers.

To calibrate your handheld screen:

1. From the General Preferences list, select Digitizer.
2. Tap the targets as indicated on the screen as precisely as possible.

Formats Preferences

Use the Formats Preferences screen to set the country default and the display format of the dates, times, and numbers on your handheld.

Country default

The country default sets date, time, week start day, and number conventions based on geographic regions where you might use your handheld. For example, in the United Kingdom, time often is expressed using a 24-hour clock. In the United States, however, time is expressed using a 12-hour clock with an AM or PM suffix.

All your handheld applications use the Country default settings. You can, however, customize your own preferences as described in [“Time, date, week start, and numbers formats”](#) later in this chapter.

To set the country default:

1. From the General Preferences list, select Formats.
2. Tap the country name pick list.

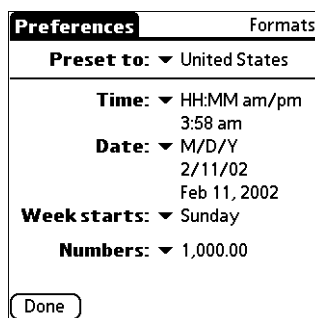

3. Select the setting you want to use.
4. Tap Done.

Time, date, week start, and numbers formats

The Time setting defines the format for the time of day. The time format that you select appears in all applications on your handheld.

To select the time, date, week start, and numbers format:

1. From the General Preferences list, select Formats
2. Tap the Time pick list and select a format.
3. Tap the Date pick list and select a format.
4. Tap the Week starts pick list, and select whether you want the first day of the week to be Sunday or Monday.

This setting controls the Day, Week, and Month views in Date Book and all other aspects of your handheld that display a calendar.

5. Tap the Numbers pick list, and select formats for the decimal point and thousands separator.
6. Tap Done.

Graffiti 2 Preferences

The Graffiti 2 Preferences screen enables you select an alternate stroke shape for specific characters.

To select alternate strokes:

1. From the General Preferences list, select Graffiti 2.
2. Tap the letter you want to change.

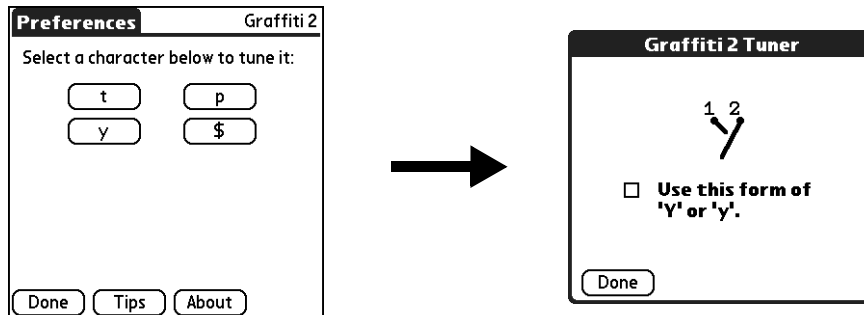

3. Tap the check box to activate the alternate stroke.
4. Tap Done.
5. Repeat steps 2 through 4 for other letters.
6. Tap Done.

Power Preferences

The Power Preferences screen enables you to set power consumption options. You can control when your handheld turns on or automatically turns off, and whether to receive beamed information.

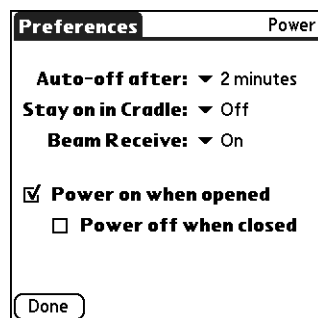

Auto-off after

Your handheld has an automatic shutoff feature that turns off the power after a period of inactivity. This feature helps conserve battery power in case you forget to turn off your handheld.

If you find that your handheld shuts itself off before you finish reviewing the information on the screen, you can increase the time setting of the automatic shutoff feature.

To set the Auto-off after interval:

1. From the General Preferences list, select Power.
2. Tap the Auto-off after pick list.
3. Select the setting you want to use for the automatic shutoff feature: 30 seconds, 1 minute, 2 minutes, or 3 minutes.
4. Tap Done.

Stay on in Cradle

You can choose to leave your handheld on when it is in the cradle/cable, so that you can continue to view your data. By default, your handheld remains on when it is in the cradle/cable and is connected to a power source.

To change the cradle/cable setting:

1. From the General Preferences list, select Power.
2. Tap the Stay on in Cradle pick list.
3. Select Off to turn off your handheld when it is in the cradle/cable.
4. Tap Done.

Beam Receive

You can choose to turn off the Beam Receive feature. This prohibits anyone from beaming information to your handheld. It also results in a slight saving of battery power. By default, Beam Receive is enabled.

To turn off the Beam Receive feature:

1. From the General Preferences list, select Power.
2. Tap the Beam Receive pick list.
3. Select Off to disable receiving beamed information.
4. Tap Done.

Power on when opened and Power off when closed

You can choose to automatically turn your handheld on and off when you open and close the Graffiti 2 writing area. By default, your handheld turns on when you open it and remains on when you close it. The Power off option is available only when the Power on when opened setting is active.

To change the power on setting:

1. From the General Preferences list, select Power.
2. Tap the check box, Power on when opened, to deselect it.
3. Tap Done.

To change the power off setting:

1. From the General Preferences list, select Power.
2. Tap the check box, Power off when closed, to select it.
3. Tap Done.

Sounds & Alerts Preferences

You can choose from three Sound & Alert profiles:

- Custom** Configure this profile with your own personal settings.
- Silent** Select this profile to use the vibrate and indicator light alerts without sound.
- All Off** Select this profile to turn off all sounds and alerts.

TIP When you connect a headset to your handheld, the external speaker is automatically silenced, the Sounds & Alerts settings are maintained, and all volume levels are automatically adjusted for use with a headset.

To select a profile:

1. From the General Preferences list, select Sound & Alerts.
2. Tap the Custom, Silent, or All Off profile box.



TIP You can also press Right or Left on the navigator to select a profile box.

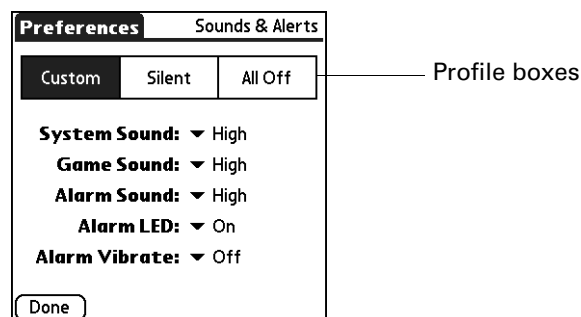

3. Tap Done.

System Sound, Game Sound, and Alarm Sound settings

Your handheld uses a variety of sounds. The System Sound, Game Sound, and Alarm Sound settings enable you to turn the sounds on or off and to adjust the volume level.

To set the sound settings:

1. From the General Preferences list, select Sound & Alerts.
2. Tap Custom.
3. Tap the System Sound pick list and select the sound level.

IMPORTANT When you turn off the System Sounds, you also turn off the “chime” tones associated with the HotSync operation.

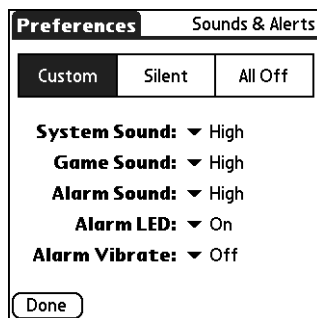

4. Tap the Game Sound pick list and select the sound level.
5. Tap the Alarm Sound pick list and select the sound level.
6. Tap Done.

The Game Sound setting works only with games that are programmed to respond to this setting. Older games typically do not respond to this setting.

Alarm LED and Alarm Vibrate settings

You can set alarms in Date Book, World Clock, Note Pad, and Voice Memo to remind yourself of important meetings or notes. When you enable the Alarm Vibrate and indicator light settings, your handheld vibrates and the indicator light blinks to notify you of alarms. This is useful when you want to turn the Alarm Sound off but still be notified by alarms.

To set the Alarm LED and Alarm Vibrate settings:

1. From the General Preferences list, select Sound & Alerts.
2. Tap Custom.

3. Tap the Alarm LED pick list and select On or Off.

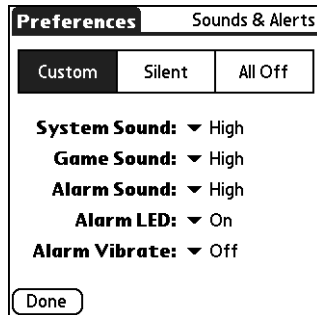

4. Tap the Alarm Vibrate pick list and select On or Off.
5. Tap Done.

Writing Area Preferences

Writing Area Preferences offer you the option of using the full screen to enter Graffiti 2 characters. When Writing Area Preferences are turned on and active, you can write letters anywhere on the left side of the screen, write numbers anywhere on the right side of the screen, and write capital letters across the imaginary division line in the middle of the screen. You access buttons and other controls that appear on the screen by tapping and holding the control until it activates.

To turn Writing Area Preferences on and off:

1. From the General Preferences list, select Writing Area.

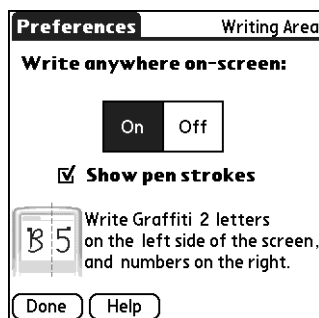



2. Tap On or Off.
3. If you selected On in the previous step, select the Show penstrokes check box to display penstrokes while writing, or deselect this check box to hide penstrokes.
4. Tap Done.

See “[Full-screen writing area](#)” in [Chapter 3](#) for details on using full-screen writing to enter data.

Setting Communication Preferences

The Communication Preferences category enables you to access screens where you can modify Bluetooth, Connection, Network, and Phone settings. This section provides details about each of these screens.

1. Tap the Home icon .
2. Tap the Prefs icon .
3. From the Communication Preferences list select the name of the Preferences screen you want to view.



TIP You can also press Left, Right, Up, and Down on the navigator to highlight a Preferences screen name and then press Select on the navigator to open that Preferences screen.

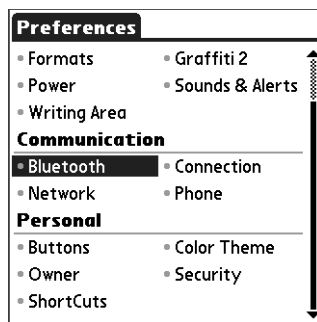

Bluetooth Preferences

When another Bluetooth device is within range (typically 10 meters or approximately 30 feet) of your handheld, you can connect your handheld with Bluetooth devices such as:

- Mobile phones
- Computers
- LAN access points
- Palm OS® handhelds

The Bluetooth Preferences screen enables you to configure settings that determine how your handheld communicates with other Bluetooth devices. You can turn Bluetooth communication on and off, assign a name to your handheld for Bluetooth communication, and choose device discovery and wakeup settings.

Turning Bluetooth communication on and off

By default, the Bluetooth communication feature on your handheld is turned off. The default setting is designed to conserve battery power. When Bluetooth communication is off, you cannot communicate with other Bluetooth devices. You must turn on Bluetooth communication to use any of the Bluetooth communication features. Keep in mind that when Bluetooth communication is on, your battery will drain more quickly than when Bluetooth communication is off.

To turn on Bluetooth communication:

1. From the Communications Preferences list, select Bluetooth.
2. Tap the Bluetooth pick list and select On.

NOTE Switching Bluetooth On and Off may take several seconds. Please wait before continuing to step 3 below.

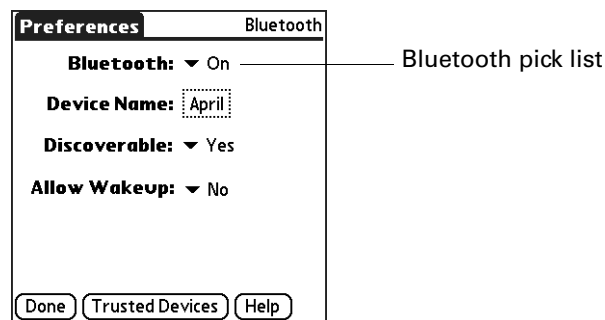

3. Tap Done.

Assigning a Bluetooth device name

The Bluetooth device name is similar to wearing a name tag. The name you assign to your handheld identifies you to other Bluetooth devices. When other users search for Bluetooth devices, your Bluetooth device name appears on their screen as a discovered device. If you do not enter a device name, your handheld sends the default name *Palm OS handheld*.

To assign a Bluetooth name to your handheld:

1. From the Communications Preferences list, select Bluetooth.
2. Tap the Device Name box.

3. Enter a name for your device.

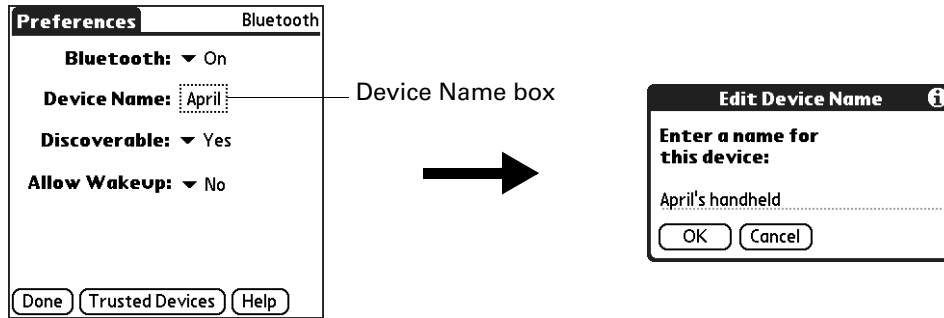

4. Tap OK.
5. Tap Done.

Setting device discovery

Discovery is the process that Bluetooth devices use to find each other when they are within range of each other. When you initiate the discovery process, you find and select the devices with which you want to connect.

The discovery process is typically initiated by an application. For example, when you connect your handheld with a mobile phone using the Phone Link application, Phone Link discovers phones equipped with Bluetooth technology within range in order to connect with one of those phones.

You can use the Discoverable and Bluetooth settings to achieve three discovery states on your handheld. The following is a description of setting combinations and the resulting discovery states:

- **Bluetooth Off:** When the Bluetooth setting is off, other users cannot discover your handheld. This is similar to locking your door with a dead bolt, a security chain, and disabling the door bell. When Bluetooth is off, you cannot access the Discoverable setting. See [“Turning Bluetooth communication on and off”](#) earlier in this chapter for instructions on turning Bluetooth communication on and off.
- **Bluetooth On and Discoverable No:** When your handheld and Bluetooth are on and the Discoverable setting is set to No, you can receive connections only from devices with which you have previously formed a trusted pair. This is similar to locking your door with a dead bolt and disabling the door bell, but any friends who already have the key can enter. By default, the Discoverable setting is enabled when Bluetooth is on.
- **Bluetooth On and Discoverable Yes:** When your handheld is on, Bluetooth is on, and the Discoverable setting is set to Yes, you can receive connections from *any* Bluetooth device. You are automatically connected with devices with which you have previously formed a trusted pair, but you can refuse invitations to connect with unrecognized devices. This is similar to locking your front door with a dead bolt and enabling the door bell. Friends who already have the key can

enter freely, and if someone without a key rings the bell to request a connection, you can choose to open the door or ignore the request.

To disable discovery:

1. From the Communications Preferences list, select Bluetooth.
2. Tap the Discoverable pick list and select No.

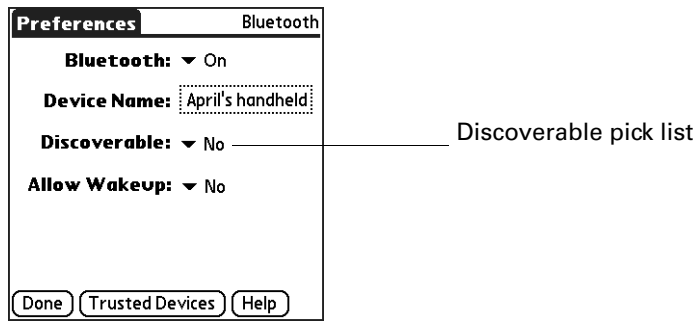

3. Tap Done.

Allowing Wakeup

When your handheld is off, the Allow Wakeup setting determines whether your handheld wakes up when you receive a connection request from another Bluetooth device that knows your device name. When this setting is enabled, you can receive requested information when your handheld is off, and then review it later. You can allow wakeup at any time, during specific hours of the day, or not at all. By default, your handheld is set to not wake up.

For another Bluetooth device or application to wake up your handheld, the application must “remember” your device name. The BlueBoard and BlueChat applications on the Software Essentials CD-ROM can remember device names; however, Address Book, Memo Pad, Note Pad, and To Do List cannot remember device names and therefore cannot wake up another handheld.

NOTE Enabling the Allow Wakeup setting uses battery power even when your handheld is turned off. Be sure to monitor your battery level.

To enable wakeup:

1. From the Communications Preferences list, select Bluetooth.
2. Tap the Allow Wakeup pick list and select Yes.

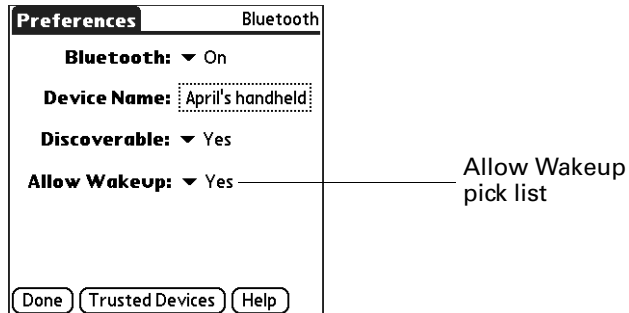

3. Tap Done.

To enable wakeup during specific hours:

1. From the Communications Preferences list, select Bluetooth.
2. Tap the Allow Wakeup pick list.
3. Select Scheduled.
4. Tap the hours box.

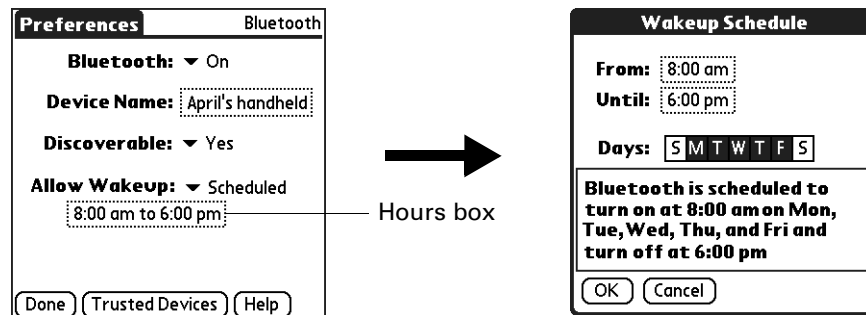

5. Tap the From box, select the start time, and then tap OK.
6. Tap the Until box, select the end time, and then tap OK.
7. Tap the Days boxes to select the days when you want the wakeup feature to be active.
8. Tap OK.
9. Tap Done.

Adding trusted devices

When you create a trusted pair, you enter an identical secret code on both devices. This secret code is called a *passkey*. The passkey enables you to create a list of Bluetooth devices from which you automatically accept communication. If a device with a recognized passkey attempts to communicate with your handheld, it bypasses the discovery and authentication process and automatically accepts the communication. If a device without a recognized passkey attempts to communicate with your handheld, it goes through the discovery and authentication process, and you can choose to accept or reject the communication.

To add a trusted device:

1. From the Communications Preferences list, select Bluetooth.
2. Tap Trusted Devices.
3. Tap Add Device.

The discovery process begins, and the discovery screens appear.

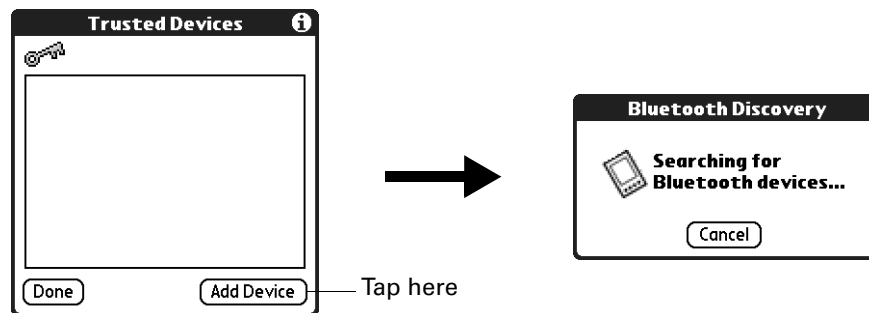

4. When the Discovery Results screen appears, select the device you want to add as a trusted device.

If the device you want to add as a trusted device does not appear on the discovery results list, tap Find More.

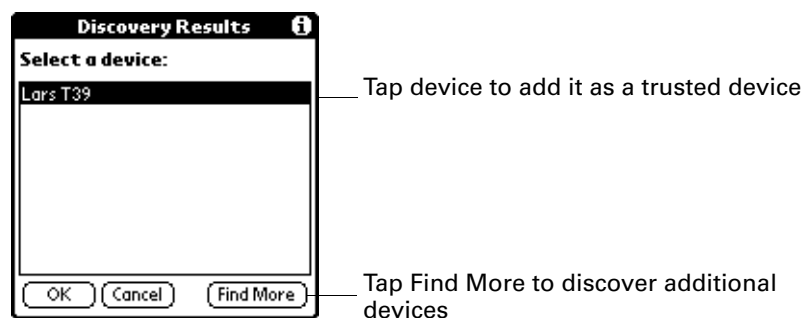

5. Tap OK.

6. Enter the same passkey on your handheld and the trusted device.

Some Bluetooth devices have a built-in passkey; others enable you to choose the passkey; see the documentation included with your Bluetooth device for information. In either case you must use the same passkey for both the device and your handheld.

Many phones also require you to put the phone into a mode where it can accept a key exchange for bonding in a trusted pair. See the documentation included with your phone for information.

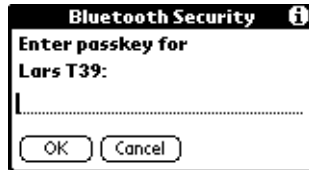

7. Tap OK.
8. Tap Done to return to the Bluetooth Preferences screen.
9. Tap Done again.

To view details about a trusted device:

1. From the Communications Preferences list, select Bluetooth.
2. Tap Trusted Devices.
3. Select the device you want to view.



4. Tap Details.

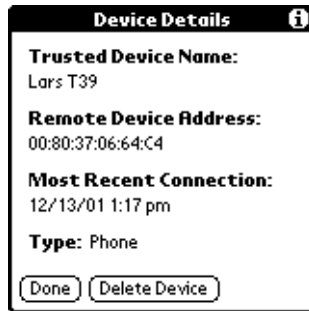

5. Tap Done to return to the Trusted Devices screen.
6. Tap Done again to return to the Bluetooth Preferences screen.
7. Tap Done again.

To delete a trusted device:

1. From the Communications Preferences list, select Bluetooth.
2. Tap Trusted Devices.
3. Select the device you want to delete.
4. Tap Details.



5. Tap Delete Device.



6. Tap OK.
7. Tap Done to return to the Bluetooth Preferences screen.
8. Tap Done again.

Enabling/disabling the user cache

When you enable or disable the user cache you control whether or not your handheld retrieves the names of remote devices each time the discovery process takes place. By default, the user cache is enabled. This means that the names of devices found during one round of discovery are stored in your handheld's user cache. The next time your handheld discovers a device that is listed in the user cache, the device name appears very quickly.

Using cached names saves time, because it eliminates the extra step of retrieving a name remotely. Disabling this feature is useful only if the name of a remote device has changed, because it forces your handheld to retrieve the new device name.

To disable the user cache:

1. From the Bluetooth Preferences screen, tap the Menu icon .
2. Select Disable device name cache from the Options menu.

Making Bluetooth connections

There are several ways you can make Bluetooth connections. The method you use determines the types of devices your handheld can discover. The following methods enable you to discover the types of Bluetooth devices that are within range:

- **Using an Internet application:** Access the Internet using Palm Web Browser Pro. See [Chapter 19](#) for details.
- **Using the Send command:** Connect to a Palm OS handheld or a computer to exchange data or applications. See ["Sending data"](#) in [Chapter 3](#) for details on using this method.
- **Using HotSync Manager software:** Connect to your computer to synchronize data with your handheld. See ["Conducting Bluetooth HotSync operations"](#) in [Chapter 21](#) for details.
- **Using a collaborative application:** Connect to a Palm OS handheld using applications such as BlueBoard and BlueChat included on the Software Essentials CD-ROM. See the *BlueBoard 2.0 Handbook* and the *BlueChat 2.0 Handbook* on the Software Essentials CD-ROM to learn more about these applications. Other third-party applications may be available. Visit www.palm.com/intl for information about downloading third-party applications, and refer to the documentation that comes with these applications for details on using them.

NOTE Palm works with developers of third-party add-on applications to ensure the compatibility of these applications with your new Palm handheld. Some third-party applications, however, may not have been upgraded to be compatible with your new Palm handheld. If you suspect that a third-party application is adversely affecting the operation of your handheld, contact the developer of the application.

Connection Preferences

The Connection Preferences screen enables you to define the settings used to connect your handheld to other devices. The screen displays a list of available configurations that are ready to be further defined; the list varies depending on the kind of software you've added to your handheld.

For example, a modem connection appears on the list. If you have this modem, you need only to specify the phone setup (and network connection, if required) to complete the configuration.

You can also create custom configurations, which include the following:

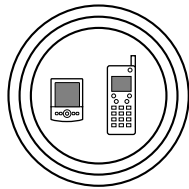

Phone to Bluetooth: A connection between your handheld and a Bluetooth phone.

TIP For Global System for Mobile Communications (GSM) phones, use Phone Link to quickly establish a connection with a Bluetooth GSM phone. For more information, see [Chapter 14](#).

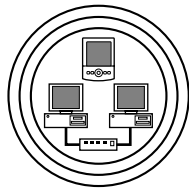

LAN to Bluetooth: A connection between your handheld and a Bluetooth Local Area Network.

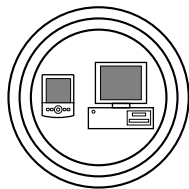

PC to Bluetooth: A connection between your handheld and a Bluetooth computer or laptop.



PC to Cradle/Cable: A local HotSync connection—the direct connection between your handheld and your desktop computer. Your handheld is connected by its universal connector to the cradle/cable, and the cradle/cable is attached to a USB port of your desktop computer. (If you are using the optional serial cradle/cable, the cradle attaches to a serial [COM] port of your computer.)

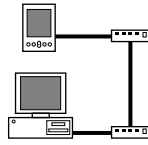

Modem to Universal connector: A cable connection between your handheld's universal connector and a modem for dialing in to a modem that is part of your computer or laptop.



PC to Infrared: A connection between the IR port of your handheld and the infrared device of your computer or laptop.

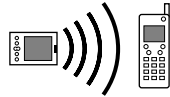

Modem to Infrared: A connection between the IR port of your handheld and a modem. The modem can be attached to or within a mobile phone or other device containing an IR port. (Some IR phones contain modems.)

Editing connections

The following example shows you how to edit the IR to GSM Phone connection to adjust the communication speed; you can similarly edit other connections or settings or create a custom connection. You can use the IR to GSM Phone connection to perform a remote IR HotSync operation. To accomplish the HotSync operation, your handheld sends data through its IR port to a modem within your mobile phone, which then dials a modem attached to or within your desktop computer, to synchronize with your Desktop application.

To edit the IR to Phone connection:

1. From the Communications Preferences list, select Connection.
2. Select the IR to GSM Phone connection.

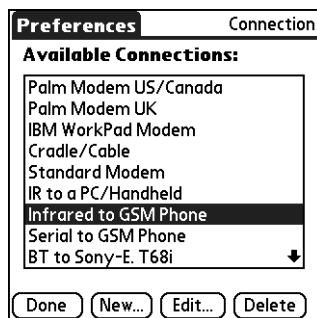

3. Tap Edit.

4. Tap Details.

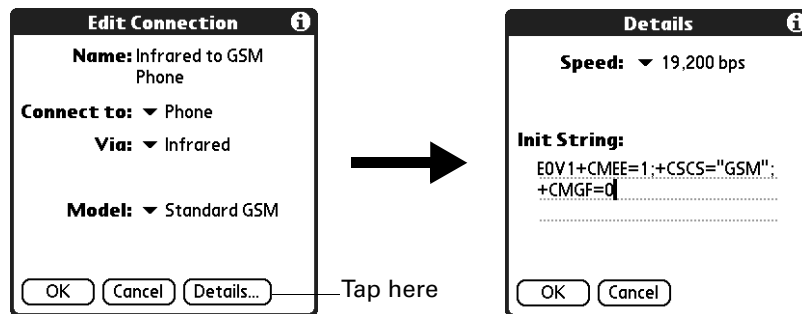

5. Tap the Speed pick list and select the appropriate speed.

6. Enter the initialization string supplied by the documentation for the modem in your mobile phone, if necessary.

7. Tap OK.

8. Tap OK again to save the configuration.

After you create the configuration, you need to set up the HotSync Manager of your Desktop application and the HotSync application of your handheld to perform a modem HotSync operation.

Creating Bluetooth connections

You can use the Connection Preferences screen to create connections to the following types of Bluetooth devices:

- GSM mobile phones (See “[Connecting to non-GSM phones](#)” later in this chapter for information on connecting to other mobile phones.)

TIP For Global System for Mobile Communications (GSM) phones, use Phone Link to quickly establish a connection with a Bluetooth GSM phone. For more information, see [Chapter 14](#).

- Computers
- LAN access points
- High-speed wireless data networks [such as a General Packet Radio Service (GPRS) network]

High-speed wireless data networks provide an “always on” network connectivity and high-speed wireless data transmission. To connect to a high-speed wireless data network, you must have a GSM mobile phone, the correct driver for your phone, a subscription to high-speed wireless data network services with your mobile phone carrier, and the correct high-speed wireless data network settings for your carrier.

TIP You can also create a connection with a GSM phone using the Phone Link application. We recommend using Phone Link to create phone connections. See [Chapter 14](#) for details. Use the steps described in these sections only if you are unable to create a connection with Phone Link.

To create a Bluetooth to LAN connection:

1. From the Communications Preferences list, select Connection.
2. Tap New.

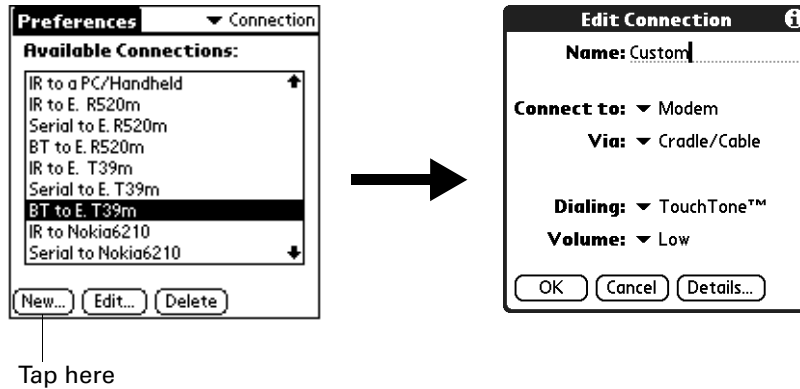

3. Enter a name for the connection, such as BT to LAN.
4. Tap the Connect to pick list and select Local Network.
5. Tap the Via pick list and select Bluetooth.
6. Make sure the network access point is ready to accept a Bluetooth connection.

NOTE See the documentation included with the network access point device for information on how to prepare it to accept a Bluetooth connection. The documentation might refer to a Bluetooth connection as a Bluetooth pairing or a Bluetooth link.

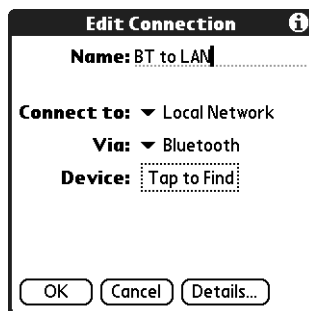

7. Tap the Device box.
The discovery process begins, and the discovery screen appears.

- When the Discovery Results screen appears, select the device to which you want to connect.

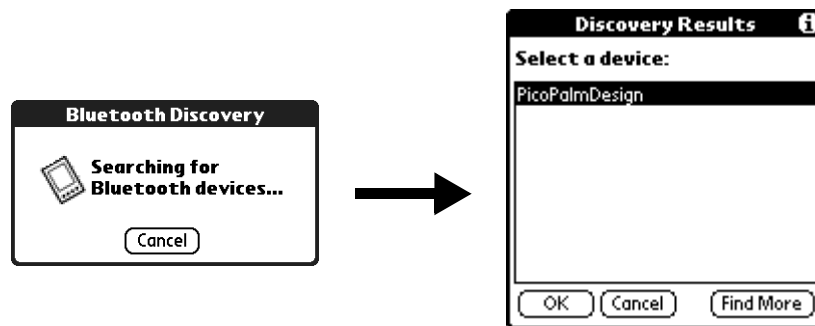

If the device to which you want to connect does not appear on the discovery results list, tap Find More.

- Tap OK.

If prompted, create a trusted pair with the device. See [“Adding trusted devices”](#) earlier in this chapter for details.

Connecting to non-GSM phones

If you have a non-GSM phone enabled with Bluetooth technology, you can connect with the phone from your handheld to access the Internet and use Internet-based applications such as e-mail or a web browser. To access the Internet and use Internet-based applications, you must subscribe to data services from your mobile phone carrier and must also have an Internet access account. These services are not included with your handheld.

To create a connection with a non-GSM phone:

- From the Communications Preferences list, select Connection.
- Tap New.

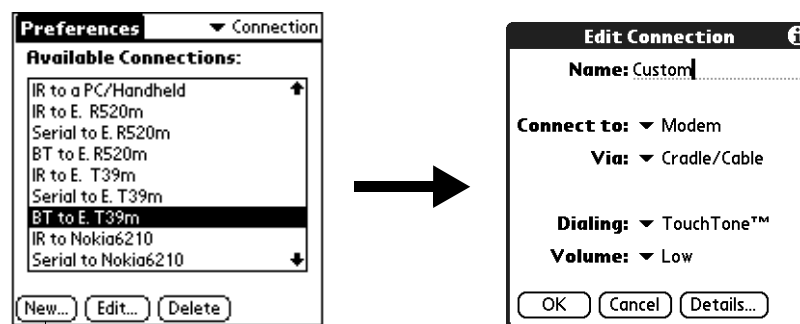

Tap here

- Enter a name for the connection.
- Tap the Connect to pick list and select Modem.

5. Tap the Via pick list and select Bluetooth.



You must select Modem rather than Phone in the Connect to field to connect with a non-GSM phone

6. Prepare your phone to accept a Bluetooth connection.

NOTE See the documentation that was included with your phone for how to prepare your phone to accept a Bluetooth connection. The documentation might refer to a Bluetooth connection as a Bluetooth pairing or a Bluetooth link.

7. Tap the Device box.

The discovery process begins, and the discovery screen appears.

8. When the Discovery Results screen appears, select the phone with which you want to connect, and then tap OK.



Tap here to select the phone with which you want to connect

Tap Find More to discover additional phones

9. Create a trusted pair with the phone. See [“Adding trusted devices”](#) earlier in this chapter for details.

Network Preferences

You can use your handheld’s Bluetooth technology and the software that is included in the handheld operating system to connect with Internet service providers (ISPs) or dial-in (remote access) servers using a mobile phone or optional modem accessory. Your mobile phone must be equipped with one of the following: an IR port, Bluetooth technology, or a serial cable that connects to your handheld’s universal connector. You also need an ISP account or corporate remote access account and a mobile phone carrier account that supports dial-up connections, or a mobile phone carrier account with high-speed wireless data network services.

You can also use your handheld's Bluetooth technology and the software that is included in the handheld operating system to connect with a LAN access point.

To use the e-mail or web browser software included with your handheld, you must create a configuration in Connection Preferences and then create Network Preferences settings. See "[Connection Preferences](#)" earlier in this chapter for a complete explanation of how to define Connection configurations that enable your handheld to communicate with remote devices.

After you configure both the Connection and Network Preferences, you can establish a PPP (Point-to-Point Protocol) connection with your ISP or dial-in server. You can do this either by using menu commands from the Network Preferences screen or by using a third-party application.

NOTE Palm works with developers of third-party add-on applications to ensure the compatibility of these applications with your new Palm handheld. Some third-party applications, however, may not have been upgraded to be compatible with your new Palm handheld. If you suspect that a third-party application is adversely affecting the operation of your handheld, contact the developer of the application.

The Network Preferences settings give you the ability to connect to your ISP or dial-in server with applications that support viewing the transmitted data. Visit the web site www.palm.com/intl for information on third-party applications that take advantage of TCP/IP.

Creating and selecting network service profiles

Use network service profiles to store the configuration settings for your ISP or a dial-in server. You can create, save, and reuse network service profiles. You can create additional network service profiles from scratch or by duplicating existing profiles and editing information. After you create a new or duplicate profile, you can add and edit settings. You can also duplicate and rename a profile that you created with Phone Link. This preserves the current Phone Link settings when you use Phone Link to create a new phone connection. Otherwise, Phone Link erases the current settings when it creates the new settings.

To add a new network service profile:

1. From the Communications Preferences list, select Network.
2. Tap New.
An Untitled network service profile appears in the Service pick list.
3. Tap Done.

To select a network service profile:

1. From the Communications Preferences list, select Network.
2. Tap the Service pick list.

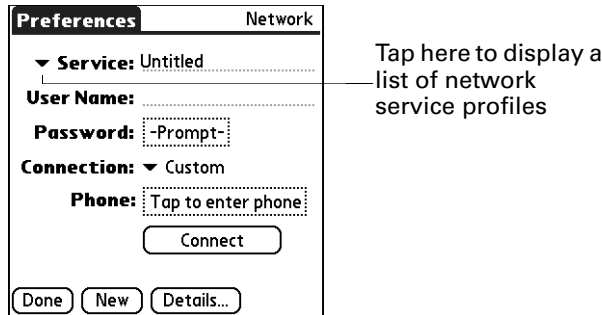

3. Select the network service profile you want to use.
4. Tap Done.

To duplicate an existing network service profile:

1. From the Communications Preferences list, select Network.
2. Tap the Service pick list.
3. Select the predefined network service profile you want to duplicate.
4. Tap the Menu icon .
5. Select Service, and then select Duplicate.

A copy of the network service profile is added to the Service pick list.

Entering a user name

The User Name setting identifies the name you use when you log into your ISP or your dial-in server. Although this field can contain multiple lines of text, only two lines appear onscreen.

To enter a user name:

1. From the Communications Preferences list, select Network.
2. Tap the User Name field.

3. Enter your user name.

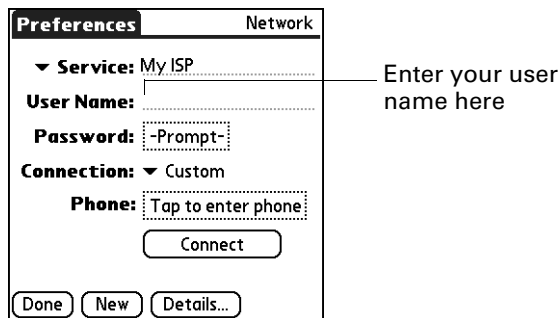

NOTE Most dial-in servers do not accept spaces in the user name.

4. Tap Done.

Entering a password

The Password box identifies the password you use to log into your server or ISP. Your entry in this field determines whether your handheld prompts you to enter a password each time you log into your network.

- If you do not enter a password, your handheld displays the word “Prompt” in this field and asks you to enter a password during the login procedure. If you are concerned about security, select the Prompt option.
- If you enter a password, your handheld displays the word “Assigned” in this field and does not prompt you to enter a password during the login procedure.

To enter a password:

1. From the Communications Preferences list, select Network.
2. Tap the Password field.
3. Enter the password you use to log into your server.

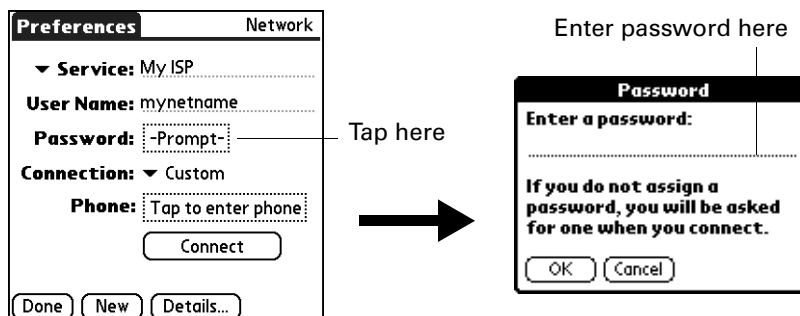

4. Tap OK.

The word “Assigned” appears in the Password field.

5. Tap Done.

Selecting a connection

Use the Connection setting to select the method you want to use to connect to your ISP or to a dial-in server. See “[Connection Preferences](#)” earlier in this chapter for information about creating and configuring connection settings.

To select a connection:

1. From the Communications Preferences list, select Network.
2. Tap the Connection pick list.

Tap here to display a list of available connections

3. Select the connection you want to use.
4. Tap Done.

Adding telephone settings

The Phone field enables you to store the telephone number you use to connect with your ISP or dial-in server. You can also define a prefix, disable Call Waiting, and give special instructions for using a calling card.

To enter your server phone number:

1. From the Communications Preferences list, select Network.
2. Tap the Phone box.
3. Enter the phone number for your ISP or dial-in server.

Enter your ISP phone number here

4. If you need to enter a prefix or to disable Call Waiting, skip to those procedures. Otherwise, tap OK.
5. Tap Done.

Entering a prefix

A prefix is a number that you dial before the telephone number to access an outside line. For example, many offices require that you first dial “9” to dial a number outside the building.

To enter a prefix:

1. From the Communications Preferences list, select Network.
2. Tap the Phone box.
3. Tap the Dial Prefix check box to select it.

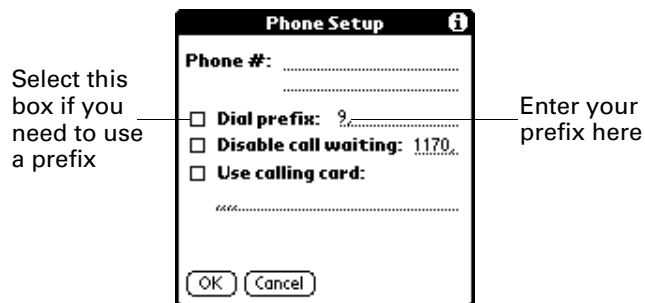

4. Enter the prefix.
5. Tap OK.
6. Tap Done.

Disabling Call Waiting

Call Waiting can cause your session to terminate if you receive a call while you are connected. If your telephone has Call Waiting, you need to disable this feature before logging into your ISP or dial-in server.

To disable Call Waiting:

1. From the Communications Preferences list, select Network.
2. Tap the Phone box.
3. Tap the Disable call waiting check box to select it.

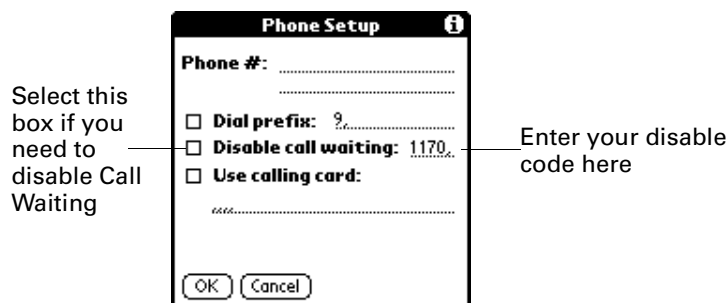

4. Enter the code to disable Call Waiting on the Disable call waiting line.

Each telephone company assigns a code to disable Call Waiting. Contact your local telephone company for the code that is appropriate for you.

5. Tap OK.
6. Tap Done.

Using a calling card

The Use calling card field enables you to use your calling card when dialing your ISP or Intranet server. Keep in mind that there is usually a delay before you enter your calling card number. When you define your calling card number, you need to add commas at the beginning to compensate for this delay. Each comma delays transmission of your calling card number for two seconds.

To use a calling card:

1. From the Communications Preferences list, select Network.
2. Tap the Phone box.
3. Tap the Use calling card check box to select it.



4. Enter your calling card number on the Use calling card line.

NOTE The Phone Setup dialog box works correctly for AT&T and Sprint long-distance services. However, because MCI works differently, MCI customers need to enter the calling card number in the Phone # field and the phone number in the Use calling card field.

TIP It's a good idea to add at least three commas before your calling card number to compensate for the cue delay.

5. Tap OK.
6. Tap Done.

Connecting to your service

After you set your Connection and Network Preferences, establishing a connection to your ISP or your company's network (dial-in server) is easy.

To establish a connection:

1. From the Communications Preferences list, select Network.
2. Tap Connect to dial the current service and display the Service Connection Progress messages.
3. (Optional) From the Service Connection Progress dialog box, tap the box that displays the service name, select another service, and then tap Done.



To see expanded Service Connection Progress messages, press Down on the navigator.

4. Tap Done.

To close a connection:

1. From the Communications Preferences list, select Network.
2. Tap Disconnect to terminate the connection between your handheld and your service.
3. Tap Done.

LAN access points

A LAN access point enabled with Bluetooth technology provides an entry point into a local area network. You can log onto these networks from your handheld to access services such as e-mail and the Internet.

LAN access points can be located in private, corporate or in public areas. In some cases there may be a fee to use a LAN access point. To access a LAN access point from your handheld, you must set your Network Preferences as described in the sections that follow.

Accessing the Internet with a Bluetooth phone or LAN access point

With your handheld's built-in Bluetooth technology, you can connect to the Internet using a Bluetooth mobile phone or a LAN access point. To connect to a Bluetooth mobile phone or LAN access point, you must be within range of these devices. If you have a GSM mobile phone and subscribe to high-speed wireless data services with your mobile phone carrier, you can use these services to connect to the Internet when you are within range of the high-speed wireless data network.

You can also configure Internet access with a GSM phone or high-speed wireless data network using the Phone Link application. We recommend using Phone Link to enter these settings. See ["Setting up a phone connection"](#) in [Chapter 14](#) for details. Use the steps described in this section only if you are unable to create a connection with Phone Link and you have already used the Connection Preferences screen to create a trusted pair for your phone, high-speed data network, or LAN access point. See ["Creating Bluetooth connections"](#) earlier in this chapter for additional information.

To configure Internet access with a Bluetooth phone or LAN access point:

1. From the Communications Preferences list, select Network.
2. Tap the Service pick list and select the name of your ISP or network service. See [“To select a network service profile:”](#) earlier in this chapter for details.

If the name of your service does not appear on the list, see [“Adding detailed information to a network service profile”](#) later in this chapter for information on adding an item to the Service pick list.

3. Enter your User Name and Password for your ISP or network service. See [“Entering a user name”](#) and [“Entering a password”](#) earlier in this chapter for details.

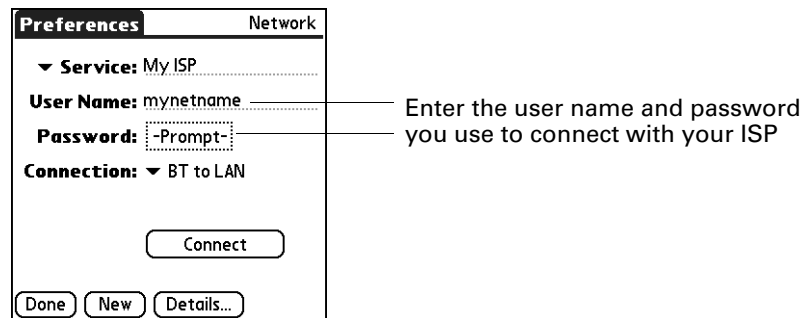

4. Tap the Connection pick list and select a connection to a Bluetooth GSM phone, a high-speed wireless data network, or a LAN access points for which you have already created a trusted pair. The Connection name is based on the model of your phone (if you used Phone Link to create the connection) or the name you assigned to the high-speed wireless data network or LAN access point connection when you created it.
5. If you selected a Bluetooth phone connection in step 4, tap Phone and enter the dial-up connection number for your ISP, and then tap OK. See [“Adding telephone settings”](#) earlier in this chapter for details.

If you are using a Bluetooth Phone or LAN access point, you can now connect and disconnect as described earlier in this chapter. If you are using a high-speed wireless data network connection, you must send an initialization (INIT) string as described in the following procedure.

To enter an INIT string for a high-speed wireless data network connection:

1. After completing step 5 in the preceding procedure, tap Details.



2. Tap Script.

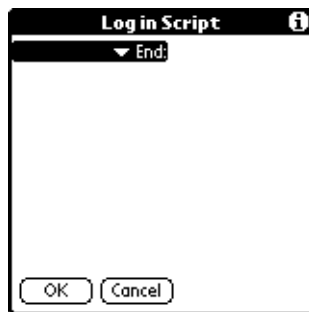

3. Tap End to expand the pick list, and then tap Send.

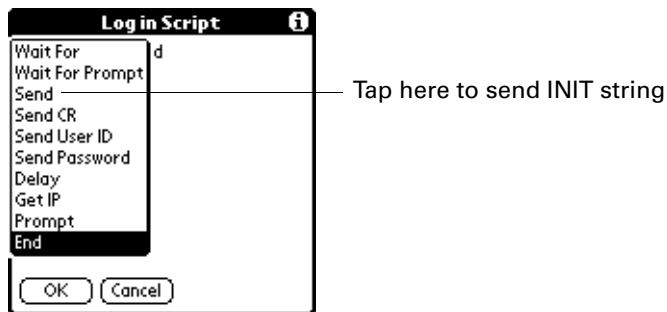

4. In the Send field, enter the INIT string provided by your wireless operator.

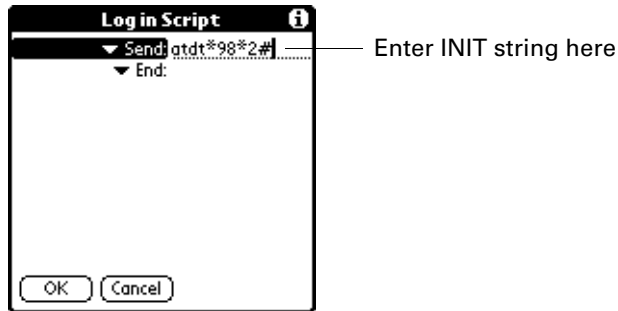

5. Tap OK.

High-speed wireless data network services are not available in all locations. If you pass from an area with coverage into one without coverage, you will lose your network connection with no notice.

If your network connection drops unexpectedly, check your phone to see if a high-speed wireless data network is active and available for the area you are in. If a high-speed wireless data network is available, reconnect to the network using the preceding steps.

If a high-speed wireless data network is not available, you must switch your phone to a standard (non-GPRS) phone connection and access the Internet using your ISP. You can do this only if you have previously created a standard connection with your phone. For instructions on creating a standard connection, see [“Setting up a phone connection”](#) in [Chapter 14](#).

Adding detailed information to a network service profile

If you are using one of the predefined network service profiles, you probably need to enter only your user name, password, and telephone number. If you are creating a new network service profile, you may need to provide additional information to your ISP or dial-in server. You use the Details dialog box to add more information to a selected network service profile.

To add connection details:

1. From the Communications Preferences list, select Network.
2. Tap the service field.

3. Tap Details.



Idle timeout

The Idle timeout setting defines how long your handheld waits before dropping the connection with your ISP or dial-in server when you switch out of a TCP/IP application.

To set the Idle timeout:

1. Tap the Idle timeout pick list and select one of the following options:

- | | |
|------------------|---|
| 1 minute | Waits one minute for you to open another application before it drops the connection. |
| 2 minutes | Waits two minutes. |
| 3 minutes | Waits three minutes. |
| Never | Keeps your PPP or SLIP connection until you turn off your handheld (or until it times out). |

2. Tap OK.

Defining primary and secondary DNS

The domain name system (DNS) is a mechanism in the Internet for translating the names of host computers into IP addresses. When you enter a DNS number (or IP address), you are identifying a specific server that handles the translation services.

Each IP address has four sections, separated by periods. In the Details dialog box, you enter each section separately. Each section of an IP address is made up of a number from 0 to 255; numbers are the only allowable characters in this field.

Ask your ISP or system administrator for the correct primary or secondary DNS IP address.

Many systems do not require that you enter a DNS IP address. If you are not sure, leave the DNS field blank.

To enter a primary and secondary DNS:

1. Tap the Query DNS check box to deselect it.
2. Tap the space to the left of the first period in the Primary DNS field, and then enter the first section of the IP address.
Each section must be a number from 0 to 255.
3. Repeat step 2 for the second, third, and last sections of the Primary DNS field.
4. Repeat steps 2 and 3 for the Secondary DNS field.
5. Tap OK.

IP address

Everyone who logs on to the Internet needs to have a unique identifier (an IP address), whether permanent or temporary. Some networks dynamically assign a temporary IP address when clients log in. You can use the IP Address field to indicate whether your network provides automatic (dynamic) temporary IP addressing.

If your IP address is permanently assigned, you need to get that information from your system administrator. If you are not sure, select Automatic.

To identify dynamic IP addressing:

- Tap the IP Address check box to select it.

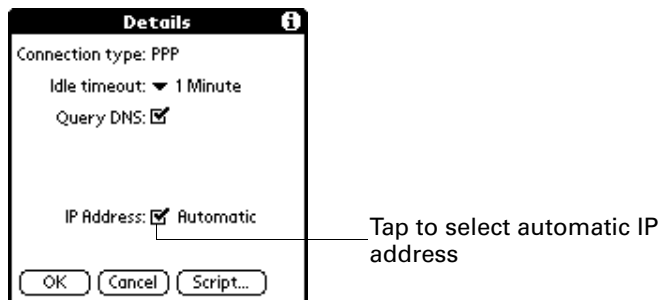
**To enter a permanent IP address:**

1. Tap the IP Address check box to deselect it and to display a permanent IP address field below the check box.
2. Tap the space to the left of the first period, and then enter the first section of the IP address.
Each section must be a number from 0 to 255.
3. Tap and enter the remaining sections of the IP address.
4. Tap OK.

Login scripts

A login script is a series of commands that automates logging in to a network server—for example, your corporate network or your ISP. A login script is associated with a specific network service profile created in Network Preferences.

A login script is something that you are likely to receive from your system administrator if your company has a system in which you log in to the corporate servers from your handheld using a modem or network connection. The script is generally prepared by the system administrator and distributed to users who need it. It automates the events that must take place to establish a connection between your handheld and the corporate servers.

You can create login scripts in two ways:

- In a text editor on your desktop computer, in which you create a file with the extension PNC, which you then install on your handheld using the Install Tool. (This method is not available to Mac computer users.)
- In the Login Script dialog box on your handheld, accessed from the Details dialog box in Network Preferences.

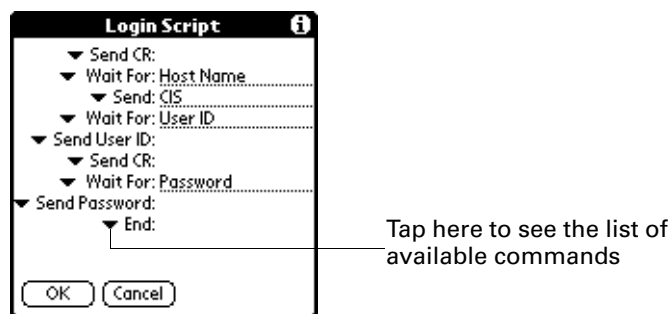

NOTE You can also use non-ASCII and literal characters in your login script.

Creating a login script on your handheld

You can create login scripts by selecting commands from the Command pick list in the Login Script dialog box. Some commands, such as Send, require you to supply additional information. Those commands have a parameter field so that you can add the necessary data.

To create a login script:

1. Tap Script.
2. Tap the End pick list.

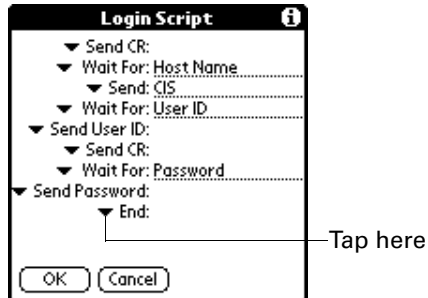

3. Select the command you want from the Command list. If the command requires additional information, a field appears to the right of it for you to enter the information. The following commands are available:

Wait For	Tells your handheld to wait for specific characters from the TCP/IP server before executing the next command.
Wait For Prompt	Detects a challenge-response prompt coming from the server and then displays the dynamically generated challenge value. You then enter the challenge value into your token card, which in turn generates a response value for you to enter on your handheld. This command takes two arguments, separated by a vertical bar () on the input line.
Send	Transmits specific characters to the TCP/IP server to which you are connecting.
Send CR	Transmits a carriage return or line feed (LF) character to the TCP/IP server to which you are connecting.
Send User ID	Transmits the user ID information entered in the User ID field of the Network Preferences screen.
Send Password	Transmits the password entered in the Password field of the Network Preferences screen. If you did not enter a password, this command prompts you to enter one. The Password command is usually followed by a Send CR command.
Delay	Tells your handheld to wait a specific number of seconds before executing the next command in the login script.
Get IP	Reads an IP address and uses it as the IP address for your handheld. This command is used with SLIP connections.

Prompt	Opens a dialog box and prompts you to enter certain text (for example, a password or a security code).
End	Identifies the last line in the login script.

4. Repeat steps 2 and 3 until the login script is complete.
5. Tap OK.

Plug-in applications

You can create plug-in applications containing script commands that extend the functionality of the built-in script commands. A plug-in application is a standard PRC application that you install on your handheld just like any other application. After you install the plug-in application, you can use the new script commands in a login script.

Plug-in applications have the following characteristics:

- Written in C language
- Compiled into a device executable
- Called properly from a login script
- Able to return control to a login script after it terminates
- Created using a development environment that supports Palm OS software, such as Metrowerks CodeWarrior for Palm™ Platform

For additional information on creating plug-in applications, send e-mail to Palm Developer Support at devsupp@palm.com.

Deleting a network service profile

There is only one way to delete a network service profile: Use the Delete command from the Service menu.

To delete a network service profile:

1. From the Communications Preferences list, select Network.
2. Tap the Service pick list.
3. Select the network service profile you want to delete.
4. Tap the Menu icon .
5. Select Delete from the Service menu.
6. Tap OK.
7. Tap Done.

Network Preferences menu commands

The Network Preferences screen includes menu commands to make it fast and easy to create and edit network service profiles. TCP/IP application menus are shown here for your reference. See “Using menus” in Chapter 4 for more information about choosing menu commands.

Service menu

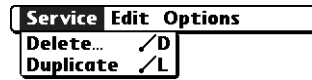

Options menu



TCP/IP troubleshooting

If you have problems establishing a network connection using TCP/IP, check the troubleshooting tips in this section and try the suggestions listed.

Displaying expanded Service Connection Progress messages



It's helpful to identify at what point in the login procedure the connection fails. An easy way to do this is to display the expanded Service Connection Progress messages. These messages describe the current stage of the login procedure. Press Down on the navigator at any point during login to display these messages.

Viewing the Network Log

If viewing the expanded Service Connection Progress messages does not give you enough information to find out why you cannot connect to your ISP or dial-in server, take a look at the Network Log. The Network Log lists all of the communication that occurs between your modem and your dial-in server during the login procedure. The information in the Network Log can help your ISP or your system administrator pinpoint where the login procedure communication fails and why.

To view the Network Log:

1. From the Network Preferences screen, tap the Menu icon .
2. Select Options, and then select View Log.
3. Tap the up and down arrows of the scroll bar to see the entire Network Log.
4. Tap Done.

Adding a DNS number

If your ISP or dial-in server requires a DNS number and you did not enter that information in the Network Preferences screen, it will appear that you successfully logged into your network. When you try to use an application or look up information, however, the connection fails. If this occurs, try adding a DNS IP address. Ask your ISP or your system administrator for the correct primary and secondary DNS IP address.

Phone Preferences

The Phone Preferences setting enables you to configure your handheld to exchange SMS messages and dial phone numbers when your handheld is connected to a GSM mobile phone (sold separately). To use this feature, you must first install the appropriate files for your carrier and phone. For more information, see [Chapter 14](#).

To set Phone Preferences:

1. From the Communications Preferences list, select Phone.
2. Tap the Connection pick list.

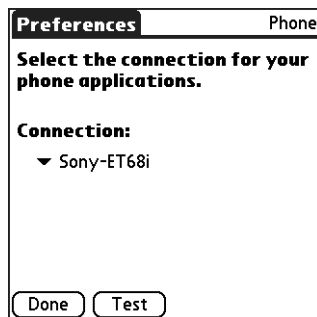



3. Select the appropriate connection for your phone.
If you do not see a connection for your phone, see [“Setting up a phone connection”](#) in [Chapter 14](#) for instructions.
4. Tap Test to confirm that the selected driver works properly with your phone.
5. Tap Done.

Setting Personal Preferences

The Personal Preferences category enables you to access screens where you can customize the buttons, owner information, and Graffiti 2 shortcuts on your handheld. This section provides details about each of these screens.

To open the Personal Preferences screens:

1. Tap the Home icon .
2. Tap the Prefs icon .

- From the Personal Preferences list select the name of the Preferences screen you want to view.



TIP You can also press Left, Right, Up, and Down on the navigator to highlight a Preferences screen name and then press Select on the navigator to open that Preferences screen.

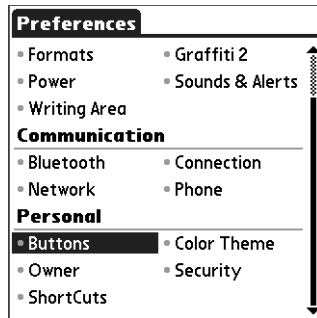

Buttons Preferences

The Buttons Preferences screen enables you to assign a frequently used application to the Favorite icon, and to associate various applications with the buttons on the front and side of the handheld.

Preferences is assigned to the Favorite icon by default. But if you use Memo Pad more frequently, you can assign Memo Pad to the icon so that you don't have to scroll through the Applications Launcher whenever you want to use Memo Pad.

Any changes you make in the Buttons Preferences screen become effective immediately; you do not have to change to a different screen or application.

If you assign a different application to a button, you can still access the original application using the Applications Launcher.

To change the Buttons Preferences:

- From the Personal Preferences list, select Buttons
- Tap the pick list next to the button you want to reassign.

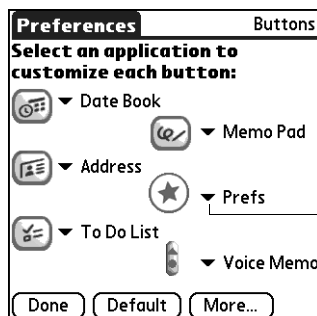

Tap arrow to show pick list

3. Select the application that you want to assign to the button.
To restore all the buttons to their factory settings, tap Default.
4. Tap Done.

Pen Preferences

The Buttons Preferences screen enables you to change the assignment of the full-screen pen stroke. By default, the full-screen pen stroke activates Graffiti 2 Help.

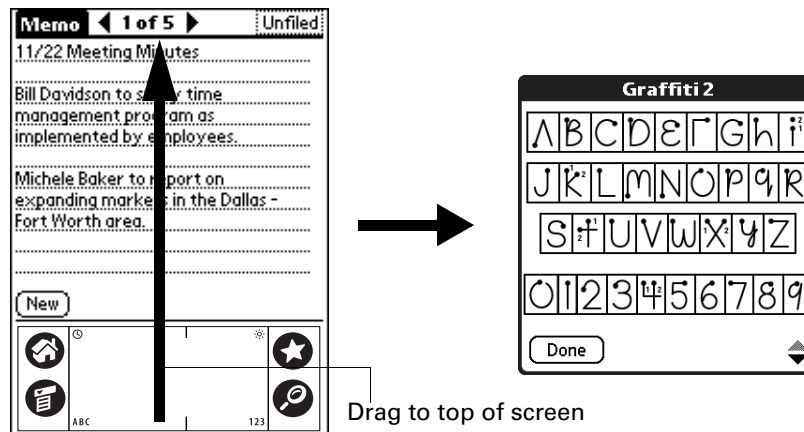

To change the pen preferences:

1. From the Personal Preferences list, select Buttons.
2. Tap More.

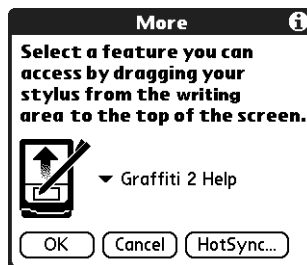

3. Tap the pick list and select one of the following settings for the full-screen pen stroke:

- | | |
|-----------------------|--|
| Brightness | Opens the brightness control dialog box. |
| Keyboard | Opens the onscreen keyboard for entering text characters. |
| Grffiti 2 Help | Opens a series of screens that show the complete Graffiti 2 character set. |

- Turn Off & Lock** Turns off and locks the handheld. You must assign a password to lock the handheld. When it is locked, you need to enter the password to use your handheld.
- Beam Data** Beams the current record to another device with an IR port.

4. Tap OK.
5. Tap Done.

HotSync Buttons Preferences

The Buttons Preferences screen also enables you to associate various applications with the HotSync button on the cradle/cable and the HotSync button on an optional modem accessory. Any changes that you make in the HotSync Buttons dialog box become effective immediately; you do not have to change to a different screen or application.

To change the HotSync buttons preferences:

1. From the Personal Preferences list, select Buttons.
2. Tap More.
3. Tap HotSync.
4. Tap the pick list next to the button you want to assign.

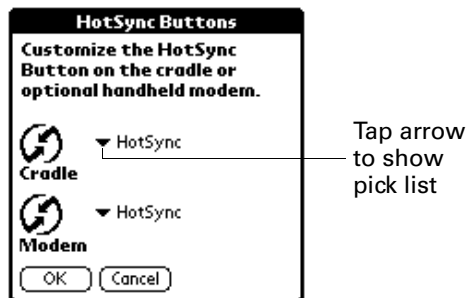

5. Select the application that you want to assign to each button.

The default setting for each button is the HotSync setting, which means that the cradle/cable and optional modem accessories perform their normal HotSync functions.

6. Tap OK twice to return to the Buttons Preferences screen.
7. Tap Done.

Color Theme Preferences

The Color Theme Preferences screen enables you to select a different set of pre-defined colors for your handheld screen.

To select a color theme:

1. From the Personal Preferences list, select Color Theme.



2. Select a theme.

The new colors immediately appear on the screen. You can scroll through the various color selections until you find the one you want to use.

3. Tap Done.

Owner Preferences

The Owner Preferences screen enables you to update the name, company name, phone number, or any other information that you want to associate with your handheld. This information could help someone contact you if you ever lose your handheld and there is sufficient battery power to turn it on.

By default the Owner Preferences screen contains the information that you supplied when you installed the Palm Desktop software and set up your handheld.

If you use Security Preferences to turn off and lock your handheld with a password, the first three lines that you entered in the Owner Preferences appear the next time you turn on your handheld. See [“Security Preferences”](#) earlier in this chapter for additional information.

To customize the Owner Preferences:

1. From the Personal Preferences list, select Owner.
2. Modify or enter the text that you want to associate with your handheld.

If you enter more text than can fit on one screen, a scroll bar automatically appears on the right side of the screen.

If you assign a password using Security Preferences, the information on the Owner Preferences screen cannot be changed. In this case an Unlock button appears at the bottom of the screen.

3. Tap Done.

To unlock the Owner Preferences screen:

1. From the Personal Preferences list, select Owner.
2. Tap Unlock.
3. Enter the password that you defined in Security Preferences.
4. Tap OK.
5. Tap Done.

Security Preferences

Your handheld comes with a security feature so that unauthorized users cannot view the entries that you want to protect. Use the security feature to do the following:

- Lock and turn off your handheld so that it does not operate until you enter the correct password.
- Mask all records that you mark as private so that the information appears grayed out.
- Hide all records that you mark as private so they do not appear on any screen.
- Encrypt records.

You can mask and hide private records with or without a password. Without a password, private records are hidden or masked until you set the Security Preference to show them. With a password, you must enter the password to view the private entries.

Assigning a password

You can assign a password to protect your private records and to lock your handheld. You can mask the password from accidental viewing. To quickly log in, you can also assign a short, quick password that works only at your first login attempt and for a limited amount of time. You can set the amount of time you need to enter the quick password.

To assign a password:

1. From the Personal Preferences list, select Security.
2. Tap the Password box.

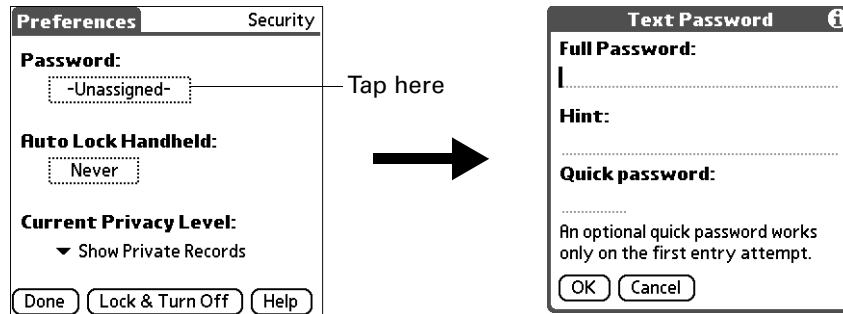

3. Enter a password.
4. Enter a hint to help you remember your password if you forget it. This is optional.
5. Enter a quick password. This is optional.
6. Tap OK.
7. Enter the *same* password a second time, and tap OK.
8. Tap Done.

Changing or deleting a password

Once you define a password for your handheld, you can change or delete it at any time. You must enter the current password before you can change or delete it.

To change or delete your password:

1. From the Personal Preferences list, select Security.
2. Tap the Password box.

3. Enter the current password.

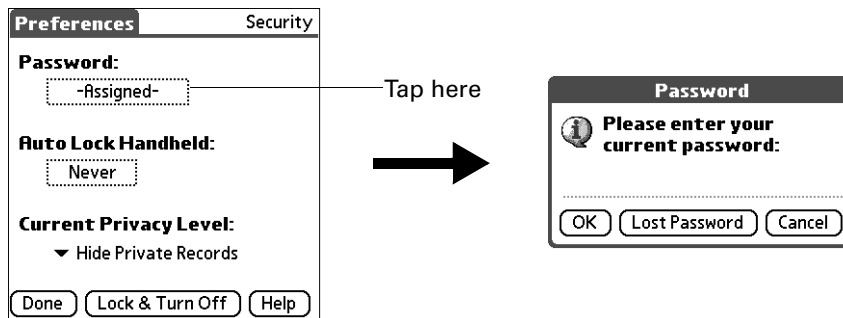

4. Tap OK.
5. Do one of the following:
 - To change the password, hint, or quick password, enter the new information, and tap OK.
 - To remove the password, tap Unassign.



6. Tap Done.

Masking your password entry

Masking your password entry secures your password against accidental viewing by another person. The password only shows asterisks as you are entering the characters.

To mask your password entry:

1. From the Personal Preferences list, select Security.
2. From the Options menu, select Security Options.

3. Tap the check box for Mask password entry.

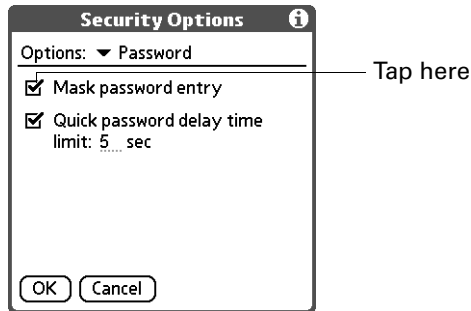

4. Tap OK.

NOTE Turn off and then turn on your handheld to enable this change.

Setting the quick password delay time limit

You can set a quick password delay time limit to accommodate your personal preference. After the delay limit has been reached, you must enter the full password. For more information about the quick password, see [“Changing or deleting a password”](#) earlier in this chapter.

To set the quick password delay time limit:

1. From the Personal Preferences list, select Security.
2. Tap the check box for Quick password delay time limit.

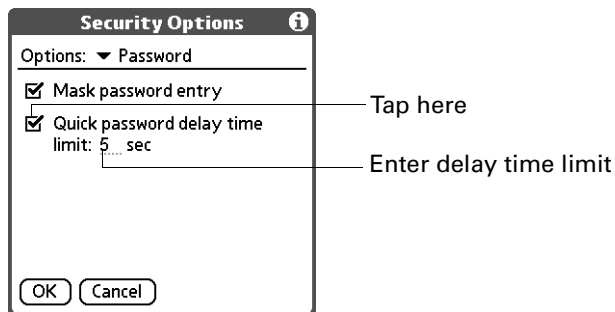

3. Tap OK.

NOTE Turn off and then turn on your handheld to enable this change.

Locking your handheld

You can lock your handheld so that it cannot be operated until your password is entered. In the event that your handheld is lost or stolen, this helps protect your data from unauthorized use. You can set your handheld to lock automatically, or you can lock it manually.

Locking your handheld automatically

You can set your handheld to lock automatically when any one of the following occurs:

- When you turn off the power
- At a time you specify
- After a period of inactivity you specify

To set your handheld to lock when you turn it off:

1. Tap the Auto Lock Handheld box.

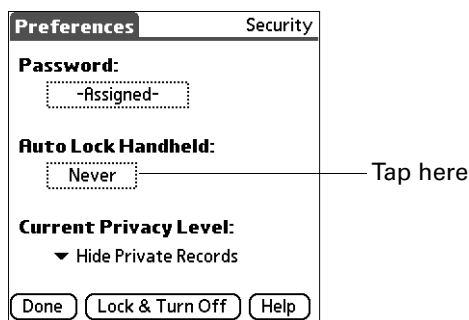

2. Enter your password.
3. Select On power off.

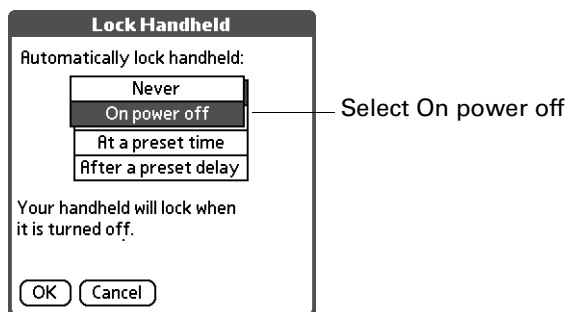

4. Tap OK.

NOTE Turn off and then turn on your handheld to enable this change.

To set your handheld to lock at a preset time:

1. Tap the Auto Lock Handheld box.

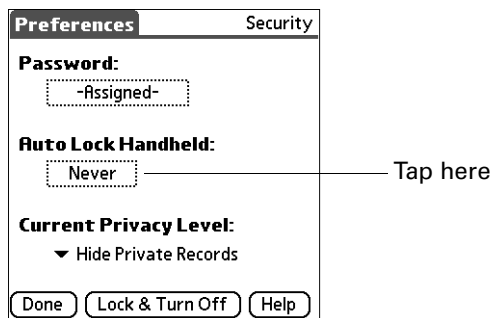

2. Enter your password.
3. Select At a preset time, and then use the arrows to set the time.

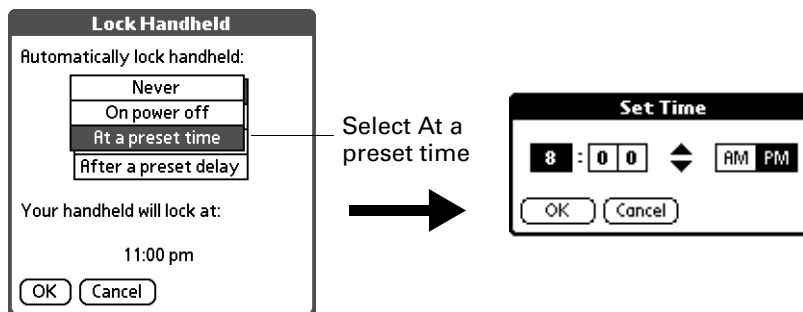

4. Tap OK.

NOTE Turn off and then turn on your handheld to enable this change.

To set your handheld to lock after a period of inactivity:

1. Tap the Auto Lock Handheld box.

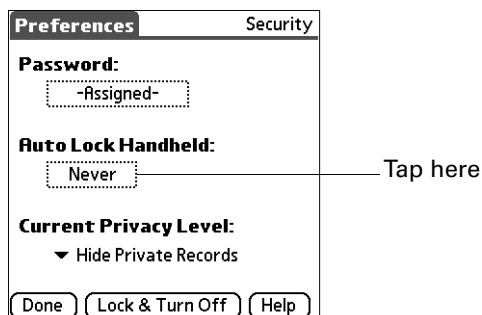

2. Enter your password.

3. Select After a preset delay.

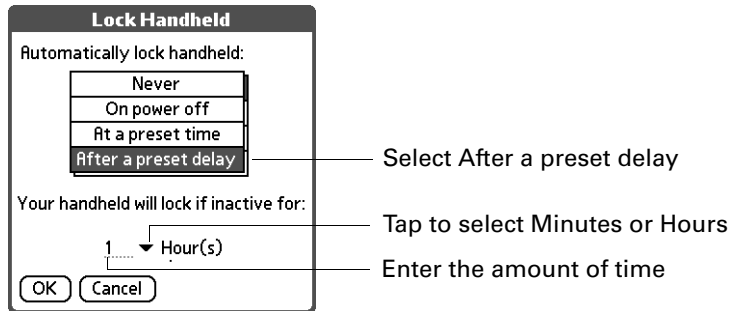

4. Enter the inactive period, and then select Minute(s) or Hour(s) from the pick list.

5. Tap OK.

NOTE You need to turn off and then turn on your handheld before this change is enabled.

IMPORTANT If you lock your handheld, you must enter the exact password to reactivate your handheld. If you forget the password, your handheld will present the hint you have entered to help you remember the password. If you still cannot remember the password, you must perform a hard reset to resume using your handheld. Performing a hard reset deletes all the records in your handheld; however, you can restore all synchronized data at the next HotSync operation. See [“Performing a hard reset”](#) in [Appendix A](#) for more information.

Locking your handheld manually

You can turn off and lock your handheld manually.

To lock and turn off your handheld:

1. Tap Lock & Turn Off.

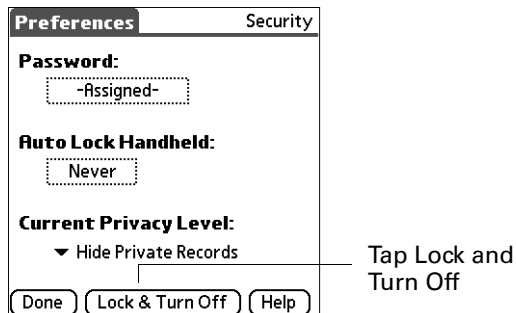

2. To use your handheld, turn it on and then enter the password.

Recovering from a forgotten password

IMPORTANT Deleting a forgotten password also deletes all entries and files marked as Private.

If you are *not* locked out of your handheld and you forgot your password, your handheld displays a hint, if you entered one, to help you remember the password. If you are still unable to remember the password, you can delete it from your handheld.

IMPORTANT If you synchronize with your computer before deleting a forgotten password, your handheld restores your private entries the next time you perform a HotSync operation, but it does not restore the password.

If you locked your handheld, you must enter the exact password to reactivate your handheld. If you forget the password, your handheld will present the hint you have entered to help you remember the password.

If you still cannot remember the password, you must perform a hard reset to resume using your handheld. Performing a hard reset deletes all the records in your handheld; however, you can restore all synchronized data at the next HotSync operation. See [“Performing a hard reset”](#) in [Appendix A](#) for more information.

To delete a forgotten password:

1. Tap the Password box.
2. Tap Lost Password.

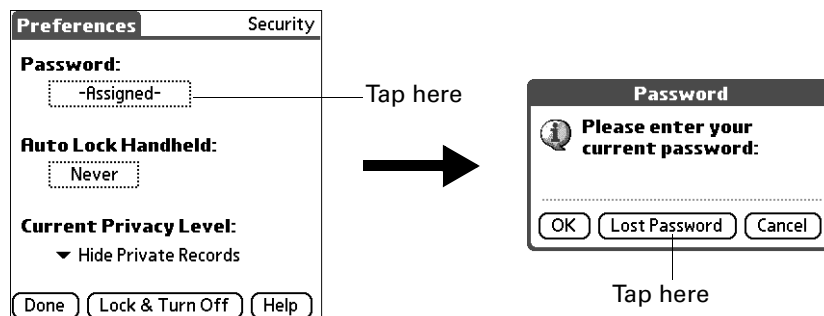

3. Tap Delete Password.

Making records private

In many applications, you can make individual records private. Private records remain visible and accessible, however, until you select the Security setting to hide or mask all private records.

Masked records appear as gray placeholders in the same position they would appear if they were not masked, and are marked with a lock icon. Hidden records disappear completely from the screen. If you define a password for your handheld, you must enter it to display private records.

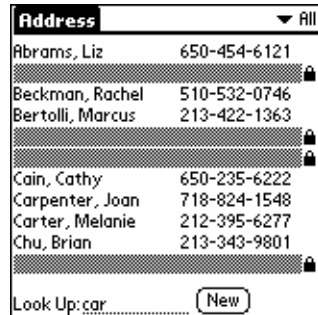

To hide all private records:

1. From the Personal Preferences list, select Security.
2. Tap the Current Privacy pick list and select Hide Private Records.

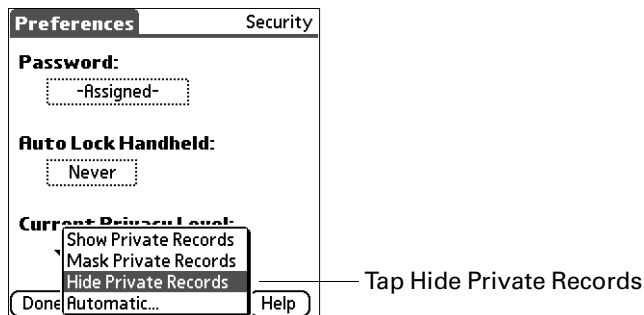

3. Tap OK to confirm that you want to hide private records.
4. Tap Done.

To mask all private records:

1. From the Personal Preferences list, select Security.
2. Tap the Current Privacy pick list and select Mask Records.

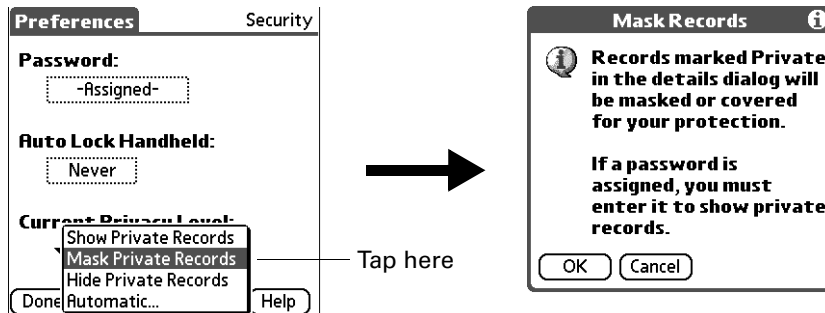

3. Tap OK to confirm that you want to mask private records.
4. Tap Done.

To display all private records:

1. From the Personal Preferences list, select Security.
2. Do one of the following:
 - Tap the Current Privacy pick list and select Show Private Records.
 - If you do not have a password, hidden and masked records become visible. If you have a password, the Show Private Records dialog box appears. Go to step 3.

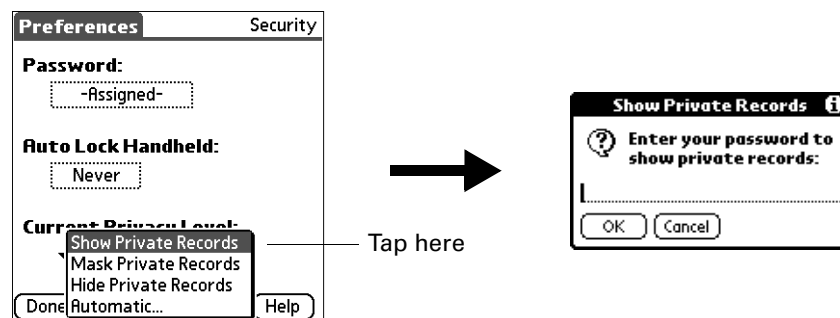

3. Enter your password, and then tap OK.
4. Tap Done.

To unmask individual records:

1. Select a masked record.
2. Do one of the following:
 - If you do not have a password, a masked record becomes visible.
 - If you have a password, the Show Private Records dialog box appears. Go to step 3.
3. Enter your password.
4. Tap OK.

To make a record private:

1. Display the entry that you want to make private.
2. Tap Details.
3. Tap the Private check box.
4. Tap OK.

Hiding or masking your private records automatically

You can set your handheld to automatically hide or mask your private records when any one of the following occur:

- When you turn off the power
- At a time you specify
- After a period of inactivity you specify

To hide or mask your records when you turn your handheld off:

1. Select Automatic.

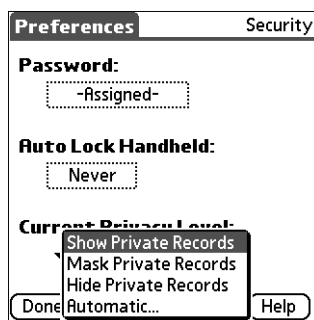

Select Automatic

2. Tap the Automatically pick list and select either Mask Private Records or Hide Public Records.

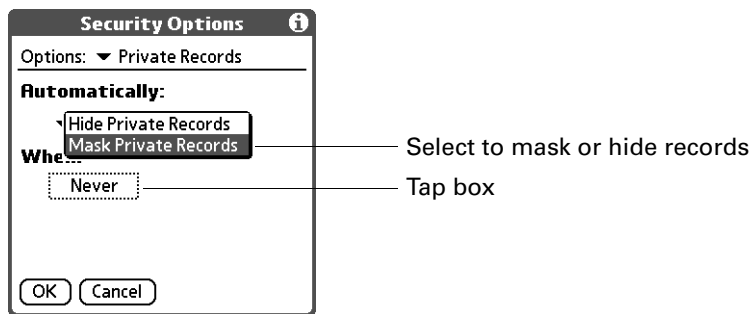

3. Tap When box.
4. Select On power off.

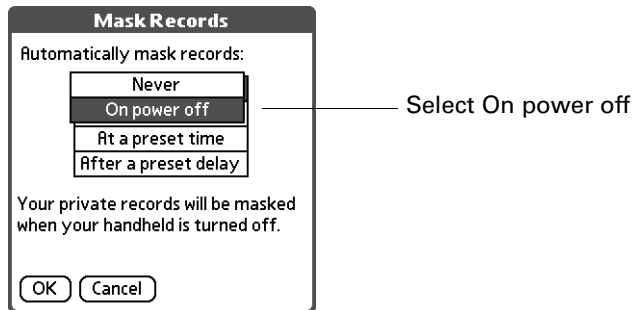

5. Tap OK.

NOTE Turn off and then turn on your handheld to enable this change.

To automatically hide or mask records at a preset time:

1. Select Automatic.

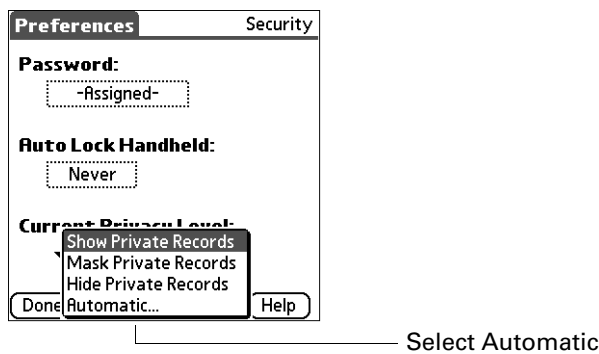

2. Tap the Automatically pick list and select either Mask Private Records or Hide Public Records.

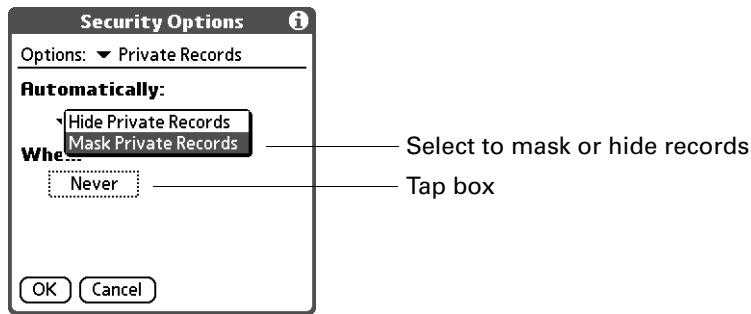

3. Tap When box.
4. Select At a preset time, and then use the arrows to set the time.

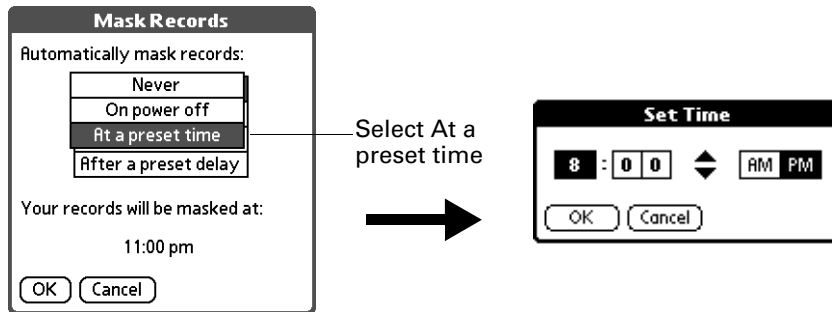

5. Tap OK.

NOTE Turn off and then turn on your handheld to enable this change.

To automatically hide or mask your records after a period of inactivity:

1. Select Automatic.

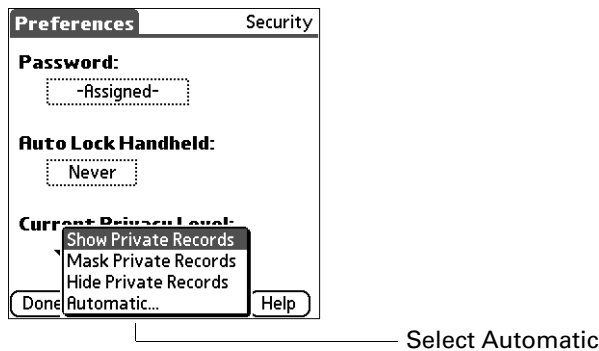

2. Tap the Automatically pick list and select either Mask Private Records or Hide Public Records.

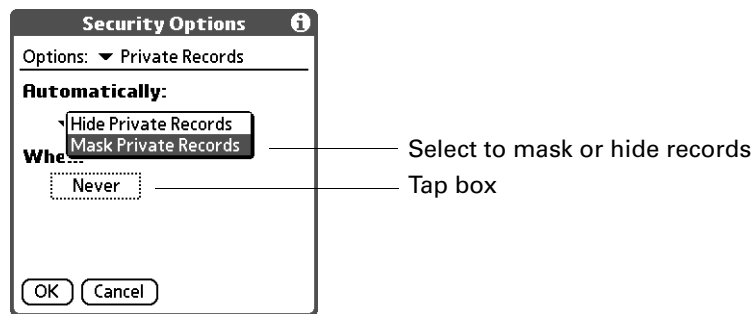

3. Tap When box.
4. Select After a preset delay.

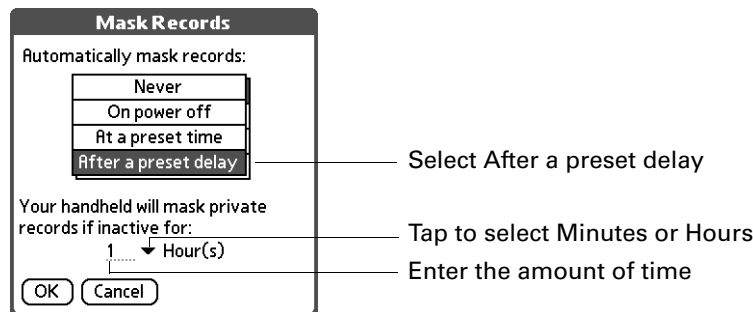

5. Enter the inactive period, and then select Minute(s) or Hour(s) from the pick list.
6. Tap OK.

NOTE Turn off and then turn on your handheld to enable this change.

Encrypting your data

You can encrypt selected data whenever your handheld locks. The more applications and data that are selected, the longer the encryption process.

When you unlock the handheld and enter a valid password, the encrypted data is decrypted. The more applications and data that are selected for encryption, the longer the decryption process.

To encrypt your data when the handheld locks:

1. From the Personal Preferences list, select Security.
2. Tap the Menu icon .
3. Select Options, and then select Security Options.
4. Tap the Options pick list and select Encryption.

5. Tap the check box for Encrypt data when locked.

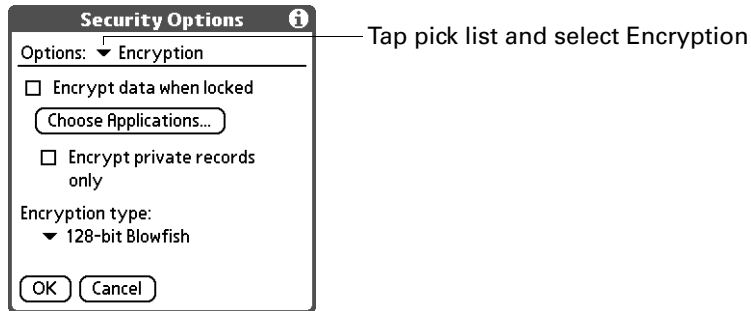

6. Tap the Choose Applications button.
7. Select the applications whose data you want to encrypt and tap OK.

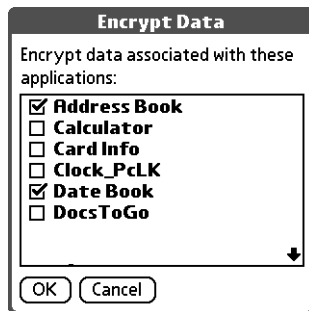

8. If you want to encrypt only private records, select Encrypt private records only.
9. Tap the Encryption type pick list and select a type.

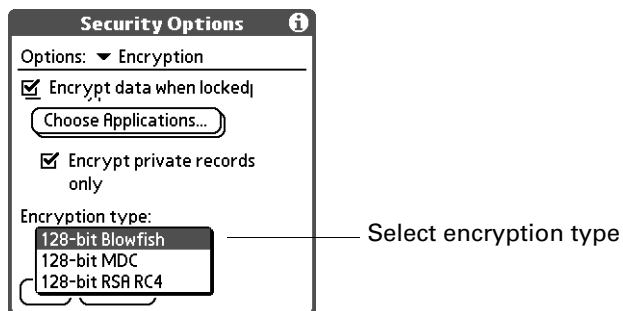

10. Tap OK.

Using security shortcuts

You can create shortcuts to activate certain security features, such as locking the handheld or masking private records. For information on using shortcuts, see “Graffiti 2 ShortCuts” in Chapter 3.

To create and activate security shortcuts:

1. From the Personal Preferences list, select Security.
2. Tap the Menu icon .
3. Select Options, and then select Security Options.
4. Tap the Options pick list and select Shortcuts.
5. Tap the check box for the security shortcut you want to activate.

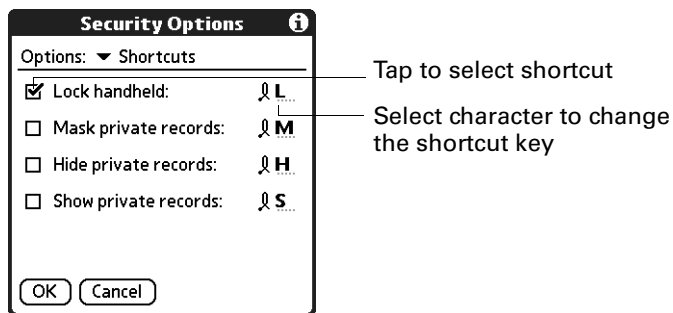

6. If you want to change the current character, tap and drag the stylus to select the character, and type the new character.

ShortCuts Preferences

The ShortCuts Preferences screen enables you to define abbreviations for entering text with Graffiti 2 strokes. This section describes how to create, edit, and delete a ShortCut.

Creating a ShortCut

You can create a ShortCut for any words, letters, or numbers. All ShortCuts you create appear on the list in the ShortCut Preferences screen. All the ShortCuts are available in any of your handheld applications and are backed up on your computer when you perform a HotSync operation.

To create a ShortCut:

1. From the Personal Preferences list, select Shortcuts.
2. Tap New.

- On the ShortCut name line, enter the letters you want to use to activate the ShortCut.

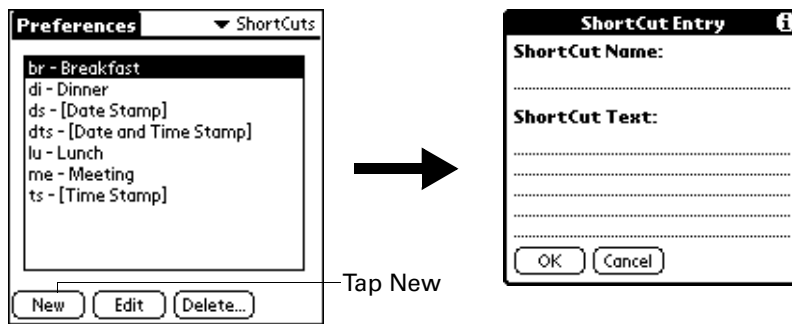

- Tap the ShortCut Text area, and enter the text that you want to appear when you write the ShortCut characters.

TIP You may want to add a space character after the last word in your ShortCut text. This way, a space automatically follows the ShortCut text.

- Tap OK.

To use a ShortCut, draw the ShortCut stroke followed by the ShortCut characters. When you draw the ShortCut stroke, the ShortCut symbol appears at the insertion point to show that you are in ShortCut mode.

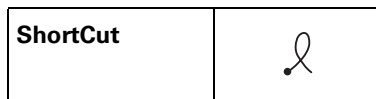

- Tap Done.

Editing a ShortCut

After you create a ShortCut, you can modify it at any time.

To edit a ShortCut:

- From the Personal Preferences list, select Shortcuts.
- Select the ShortCut you want to edit.
- Tap Edit.
- Make the changes you want.
- Tap OK.
- Tap Done.

Deleting a ShortCut

If you no longer need a ShortCut, you can delete it from the list of ShortCuts.

To delete a ShortCut:

1. From the Personal Preferences list, select Shortcuts.
2. Select the ShortCut you want to delete.
3. Tap Delete.
4. Tap Yes.
5. Tap Done.

Maintaining Your Handheld

This chapter provides information on the following:

- Caring for your handheld
- Prolonging battery life
- Resetting your handheld

Caring for your handheld

Your handheld is designed to be rugged and reliable and to provide years of trouble-free service. Observe the following general tips when using your handheld:

- Take care not to scratch the screen of your handheld. Keep the screen clean. When working with your handheld, use the supplied stylus or plastic-tipped pens intended for use with a touch-sensitive screen. Never use an actual pen or pencil or other sharp object on the surface of the handheld screen.
- Your handheld is not waterproof and should not be exposed to rain or moisture. Under extreme conditions, water may enter the circuitry through the front panel buttons. In general, treat your handheld as you would a pocket calculator or other small electronic instrument.
- Take care not to drop your handheld or subject it to any strong impact. Do not carry your handheld in your back pocket; if you sit on it, you may damage it.
- Protect your handheld from temperature extremes. For example, do not leave your handheld on the dashboard of a car on a hot day or on a day when temperatures are below freezing, and keep it away from heaters and other heat sources.
- Do not store or use your handheld in any location that is extremely dusty, damp, or wet.
- Use a soft, damp cloth to clean your handheld. If the surface of the handheld screen becomes soiled, clean it with a soft cloth moistened with a diluted window-cleaning solution.

Prolonging battery life

Note the following considerations for the battery in your handheld:

- Under normal conditions your handheld battery should remain charged when you place it in the cradle/cable for just a few minutes each day. You can conserve battery life by doing any of the following:
 - Reduce the brightness of the screen display. See [“Adjusting screen brightness”](#) in [Chapter 2](#) for more information.
 - Change the Auto-off setting that automatically turns the handheld off after a period of inactivity. See [“Auto-off after”](#) in [Chapter 22](#) for more information.
 - Turn off the Bluetooth™ feature when you’re not using it. See [“Bluetooth Preferences”](#) in [Chapter 22](#) for more information.
 - Minimize accessing the expansion card slot.
 - Moderate how often you access multimedia files, such as MP3 files (expansion card required, sold separately) and video files.
- If the battery becomes low in the course of normal use, an alert appears on the handheld screen, describing the low battery condition. If this alert appears, perform a HotSync® operation to back up your data; then leave your handheld in the cradle/cable to recharge the unit. This helps prevent accidental data loss.
- If the battery drains to the point where your handheld does not operate, it stores your data safely for about a week. In this case there is enough residual energy in the battery to store the data, but not enough to turn on your handheld. If your handheld does not turn on when you press the power button, you should recharge the unit immediately. The battery may not have enough residual energy to power the indicator light, which is normally green when the battery is charging.
- If your battery drains and you have the unit in an uncharged state for an extended period of time, you can lose all your stored data.
- There are no serviceable parts inside your handheld, so do not attempt to open the unit.
- If you ever dispose of your handheld, please dispose of it without damaging the environment. Take your handheld to your nearest environmental recycling center.

Resetting your handheld

Under normal circumstances you will not have to use the reset button. On rare occasions, however, your handheld may no longer respond to buttons or to the screen. In this case you need to perform a reset to get your handheld running again.

Performing a soft reset

A soft reset tells your handheld to stop what it's doing and start over again. All records and entries stored in your handheld are retained with a soft reset. After a soft reset, the Preferences screen appears and the Date and Time option is highlighted so you can reset the date and time if needed.

To perform a soft reset:

1. Open your handheld. See [“Opening and closing your handheld”](#) in [Chapter 2](#) for details.
2. Use the tip of your stylus or an unfolded paper clip (or similar object *without* a sharp tip), to gently press the reset button inside the hole on the back panel of your handheld.

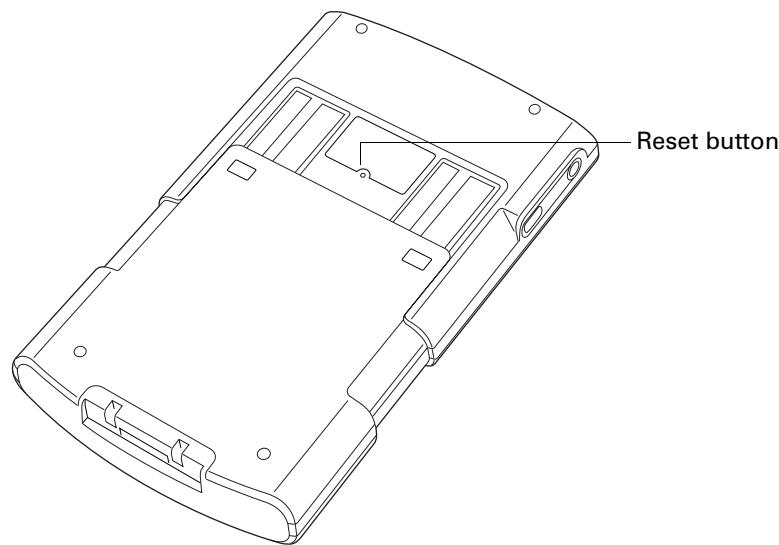

Performing a hard reset

With a hard reset, all records and entries stored in your handheld are erased. Never perform a hard reset unless a soft reset does not solve your problem.

NOTE You can restore any data previously synchronized with your computer during the next HotSync operation.

To perform a hard reset:

1. Open your handheld. See [“Opening and closing your handheld”](#) in [Chapter 2](#) for details.
2. Press and hold the power button on the top panel of the handheld.
3. While holding the power button, use the tip of your stylus or an unfolded paper clip (or similar object *without* a sharp tip) to gently press and release the reset button.

4. Wait for the Palm Powered™ logo to appear; then release the power button.
5. When a message appears on the handheld screen warning that you are about to erase all the data stored on your handheld, do one of the following:



- Press Up on the navigator to complete the hard reset and display the Digitizer screen.
- Press any other button to perform a soft reset.

NOTE With a hard reset, the current date and time are retained. Formats Preferences and other settings are restored to their factory default settings.

To restore your data from a Windows computer after a hard reset:

1. Click the HotSync icon  in the Windows system tray (bottom-right corner of the taskbar).

You can also click the HotSync command on the Palm Desktop software menu bar.

2. From the HotSync Manager menu, select Custom.
3. Select the appropriate user name from the list.
4. Select an application in the Conduit list.
5. Click Change.
6. Select Desktop overwrites handheld for each conduit.

Changing the HotSync setting from the default affects only the *next* HotSync operation. Thereafter, the HotSync Actions revert to their default settings. To use a new setting on an ongoing basis, select the Set As Default box. Thereafter, whatever you selected as the default setting is used when you click the Default button in the Custom dialog box.

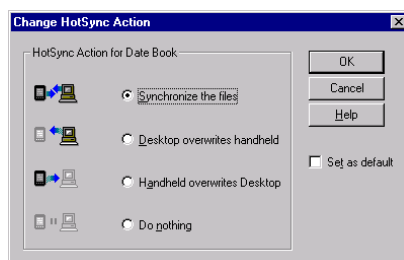

7. Click OK.
8. Repeat steps 4 through 6 to change conduit settings for other applications.
9. Click Done to activate your settings.
10. Perform a HotSync operation.

To restore your data from a Mac computer after a hard reset:

1. Double-click the HotSync Manager in the Palm folder.
2. From the HotSync menu, select Conduit Settings.
3. From the Users pop-up menu, select the appropriate user name.
4. Select an application from the list.
5. Click Conduit Settings.
6. Click Macintosh overwrites handheld for each conduit.

Changing the HotSync setting from the default affects only the *next* HotSync operation. Thereafter, the HotSync Actions revert to their default settings. To use a new setting on an ongoing basis, click Make Default. Thereafter, whatever you selected as the default setting is used for HotSync operations.

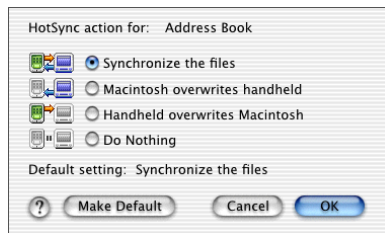

7. Click OK.
8. Repeat steps 4 through 6 to change conduit settings for other applications.
9. Close the Conduit Settings window.
10. Perform a HotSync operation.

Frequently Asked Questions

If you encounter a problem with your handheld, do not call Technical Support until you have reviewed the frequently asked questions in this appendix and you have also reviewed the following:

- The readme file located in the folder where you installed the Palm™ Desktop software on your Windows computer or on your installation CD for Mac users
- The Palm Desktop online Help
- The *Palm Desktop software for the Macintosh User's Guide* located in the Documentation folder on your installation CD
- The *Palm Knowledge Library*, accessible at www.palm.com/intl in the Support section
- The most recent Palm™ Tungsten™ T2 handheld HelpNotes on your regional web site

If you are still having problems, contact Technical Support or go to www.palm.com/support/globalsupport.

NOTE Palm works with developers of third-party add-on applications to ensure the compatibility of these applications with your new Palm™ handheld. Some third-party applications, however, may not have been upgraded to be compatible with your new Palm handheld. If you suspect that a third-party application is adversely affecting the operation of your handheld, contact the developer of the application.

Software installation problems

Problem	Solution
The installation menu did not appear when I inserted the Desktop Software CD-ROM (or the Software Essentials CD-ROM) into my Windows computer.	<ol style="list-style-type: none">1. From the Windows desktop, click Start.2. Select Run.3. Click Browse.4. Locate your CD-ROM drive, and select the Autorun file.5. Click Open.6. Click OK.
I cannot install Palm Desktop software on my Windows computer.	Try the following: <ol style="list-style-type: none">1. Disable any virus scanning software on your computer.2. Close any open applications3. Make sure your computer has at least 50MB of disk space available.4. Delete all temporary files.5. Run ScanDisk (or another disk verification tool) on your computer.6. Uninstall, and then reinstall Palm Desktop software.
I cannot install Palm Desktop software on my Mac computer.	Try the following: <ol style="list-style-type: none">1. Disable any virus scanning software on your computer.2. Quit any open applications.3. Make sure your computer has at least 50MB of disk space available.4. Uninstall, and then reinstall Palm Desktop software.
My files didn't install during a HotSync® operation.	If files do not install after you perform a HotSync operation the file type was not recognized. Try launching the associated application from your handheld and then performing another HotSync operation. If the files still remain in the list, they are not associated with an application on your handheld and cannot be installed.
I can't add more files to the Palm™ Quick Install list.	Make sure the dialog box that confirms where the files will be installed is closed. You cannot add more files to the list when the confirmation dialog box is open. For details, see "Installing applications and files on a Windows computer" in Chapter 4 .

Operating problems

Problem	Solution
I don't see anything on my handheld's screen.	<p>Try each of these in turn:</p> <ul style="list-style-type: none"> ■ Press an application button to ensure that your handheld is turned on. ■ Tap the Brightness icon  in the upper-right corner of the Graffiti® 2 writing area. If the Brightness dialog box appears, adjust the brightness by pressing and holding Up on the navigator for a few seconds. If this doesn't work, press and hold Down on the navigator for a few seconds. ■ If your handheld was exposed to cold, make sure it is at room temperature. ■ Charge your handheld. ■ Perform a soft reset. If your handheld still doesn't turn on, perform a hard reset. See "Resetting your handheld" in Appendix A.
I get a warning message telling me my handheld memory is full.	<p>IMPORTANT With a hard reset, all records and entries stored in your handheld are erased. Never perform a hard reset unless a soft reset does not solve your problem. You can restore any data previously synchronized with your computer during the next HotSync operation.</p> <ul style="list-style-type: none"> ■ Purge records from Date Book and To Do List. This deletes To Do List items and past Date Book events from the memory of your handheld. See "Purging records" in Chapter 4. You must perform a HotSync operation to recover the memory. ■ Delete unused memos and records. If necessary, you can save these records. See "Deleting records" in Chapter 4. You must perform a HotSync operation to recover the memory. ■ If you have installed additional applications on your handheld, remove them to recover memory. See "Removing applications" in Chapter 4.
My handheld keeps turning itself off.	<p>Your handheld is designed to turn itself off after a period of inactivity. This period can be set at 30 seconds or at one, two, or three minutes. Check the Auto-off after setting on the Power Preferences screen. See "Power Preferences" in Chapter 22.</p>

My handheld is not making any sounds.	Check the System, Alarm, and Game Sound settings. See “Sounds & Alerts Preferences” in Chapter 22 .
My handheld’s indicator light is not blinking when alarms occur.	Check the Alarm indicator light setting. See “Alarm LED and Alarm Vibrate settings” in Chapter 22 .
My handheld does not vibrate when alarms occur.	Check the Alarm Vibrate setting. See “Alarm LED and Alarm Vibrate settings” in Chapter 22 .
My handheld has frozen.	<ul style="list-style-type: none">■ If a network connection was improperly terminated, your handheld may appear to be frozen for up to 30 seconds. If it is still frozen after 30 seconds, perform a soft reset.■ Perform a soft reset. See “Resetting your handheld” in Appendix A.

Tapping and writing problems

Problem	Solution
When I tap the buttons or screen icons, my handheld activates the wrong feature.	Calibrate the screen. See “Digitizer Preferences” in Chapter 22 .
When I tap the Menu icon  , nothing happens.	Not all applications or screens have menus. Try changing to a different application.
I can’t get my handheld to recognize my handwriting.	<ul style="list-style-type: none">■ For your handheld to recognize handwriting input with the stylus, you need to use Graffiti 2 writing. See “Using Graffiti 2 writing to enter data” in Chapter 3.■ Make the Graffiti 2 character strokes in the Graffiti 2 writing area, not on the display part of the screen. If you want to write on the display part of the screen you must turn on and activate Writing Area Preferences. See “Full-screen writing area” in Chapter 3.■ Write Graffiti 2 strokes for lowercase letters in the left side, strokes for capital letters in the middle, and strokes for numbers in the right side of the Graffiti 2 writing area.■ Make sure that Graffiti 2 is not in shift mode. See “Symbols and other special characters” in Chapter 3.■ See “Graffiti 2 tips” in Chapter 3 for tips on increasing your accuracy when you write Graffiti 2 characters.

Application problems

Problem	Solution
I tapped the Today button, but it does not show the correct date.	Your handheld is not set to the current date. Make sure the Set Date box on the Date and Time Preferences screen displays the current date. See “Date & Time Preferences” in Chapter 22 for more information.
I know I entered some records, but they do not appear in the application.	<ul style="list-style-type: none"> ■ Check the Categories pick list (upper-right corner). Select All to display all the records for the application. ■ Check Security and confirm that Private Records is set to Show private records. ■ In To Do List, tap Show and see if Show Only Due Items is selected.
I’m having problems listing memos, notes, or voice memos the way I want to see them.	<ul style="list-style-type: none"> ■ If you cannot manually arrange the order of memos, notes, or voice memos on the list screen, select Preferences from the Options menu and make sure that Sort by is set to Manual. ■ If you choose to view your memos, notes, or voice memos alphabetically on Palm Desktop software and then perform a HotSync operation, the memos on your handheld still appear in the order defined in the Preferences setting. In other words, the sort settings you use with Palm Desktop software <i>are not</i> transferred to your handheld.
I created an event in Date Book, but it doesn’t appear in the Week View.	If you have two or more events with the same start time, the first event created appears as a gray bar, and any subsequent conflicting events appear as a single red bar. To see the overlapping events select the Day View.
My vCard or vCal e-mail attachment isn’t forwarding correctly.	<p>Palm Desktop software provides several features that interact with e-mail client software on a Windows computer. For these features to work correctly, the e-mail client software must be properly configured. Follow these steps to check the configuration:</p> <ol style="list-style-type: none"> 1. Click the Windows Start menu, and then select Settings. 2. Select Control Panel. 3. Select Internet Options, and then click the Programs tab. 4. Make sure that the E-mail field is set to the correct e-mail client software.

My vCard or vCal e-mail attachment isn't forwarding correctly (continued).

5. Click OK.
6. Start the e-mail client software and make sure it is configured as the default MAPI client. Consult the documentation for your desktop e-mail application for more information.

The current date and time are incorrect.

The current date and time are tied to the Location setting. If you change the date and time without changing the Location setting, the current date and time may appear incorrect. See ["Date & Time Preferences"](#) in [Chapter 22](#) for information on setting the current location, date, and time.

HotSync problems

Problem

I cannot perform a HotSync operation. What should I check to make sure I'm doing it correctly?

Solution

- Make sure the HotSync cradle/cable is connected securely.

On a Windows computer try these steps:

1. Check the Windows system tray to make sure the HotSync Manager is running. If it is not, click Start on the Windows taskbar, and then select Programs. Navigate to the Palm Desktop software program group, and select HotSync Manager. You should also see ["Selecting HotSync setup options"](#) in [Chapter 21](#) for instructions on selecting the correct HotSync Manager settings.
2. Make sure you selected Local USB or Local Serial, as appropriate, from the HotSync Manager menu.
3. If you are using the serial cradle/cable, make sure you selected the correct serial port on the Local tab in the Setup dialog box. It should be set to the port where you connected the HotSync cradle/cable.

I cannot perform a HotSync operation. What should I check to make sure I'm doing it correctly (continued)?

On a Mac computer try these steps:

1. Make sure HotSync Manager is enabled. If it is not, double-click the HotSync Manager icon in the Palm folder and enable HotSync Manager on the HotSync Controls tab.
2. If you are using a USB cradle/cable, disconnect the cradle/cable from your computer, and then reconnect the cradle/cable and restart your computer.
3. If you are using the optional serial cradle/cable, double-click the HotSync Manager icon in the Palm folder and then click the Connection Settings tab. Make sure the port selection matches the port where your HotSync cradle/cable is attached.

I did a HotSync operation, but one of my applications did not synchronize.

- On a Windows computer, click the HotSync Manager and select Custom. Check that the correct conduit is active.
- On a Mac computer, double-click the HotSync Manager icon. From the HotSync menu, select Conduit Settings. Select your user name from the User pop-up menu, and check that the correct conduit is active.

I am using Outlook as my PIM, but I cannot do a HotSync operation.

- Click the HotSync Manager and select Custom. Check that the correct conduit is active.
- Check that the correct conduit is installed. Reinstall the HotSync Manager and make sure that the correct conduit is selected.
- Reinstall Palm Desktop software and select the option to synchronize with Microsoft Outlook.

I cannot launch the HotSync Manager.

- If you are using the optional serial cradle/cable, or if you are performing a HotSync operation using a modem, make sure you are not running another program, such as America Online, that uses the serial port you selected in the Setup dialog box.
- Make a backup copy of your Palm Desktop data, and then reinstall Palm Desktop software.

I tried to do a local HotSync operation, but it did not complete successfully.

- Make sure your handheld is seated in the cradle/cable correctly.
- Check the connection between the HotSync cradle/cable and the USB or serial port on your computer.
- Make sure the user name you selected in Palm Desktop software matches the user name assigned to your handheld.
- Make sure the date on your computer matches the date on your handheld.
- Read the HotSync Log for the user account for which you are performing a HotSync operation

On a Windows computer, try each step in turn:

- Make sure that HotSync Manager is running. If it is running, close it and restart it.
- Make sure you selected Local USB or Local Serial, as appropriate, from the HotSync Manager menu.
- If you are using the serial cradle/cable, make sure you selected the correct serial port on the Local tab in the Setup dialog box. It should be set to the port where you connected the HotSync cradle/cable.
- If you are using the serial cradle/cable, try a lower baud rate setting on the Local tab in the Setup dialog box.
- If you are using the serial cradle/cable, make sure you aren't running a program, such as America Online, that uses the serial port you selected in the Setup dialog box.

On a Mac computer, try each step in turn:

- Make sure HotSync Manager is enabled on the HotSync Controls tab in the HotSync Software Setup window.
- If you are using the optional serial cradle/cable, double-click the HotSync Manager icon in the Palm folder and then click the Connection Settings tab. Make sure the port selection matches the port where your HotSync cradle/cable is attached.
- If you are using the optional serial cradle/cable, try a lower Speed setting on the Connection Settings tab
- If you are using the optional serial cradle/cable, make sure you aren't running a program, such as America Online, fax or telephony software, or AppleTalk networking, that uses the serial port you selected in the Connection Settings tab.

I tried to do a modem HotSync operation, but it did not complete successfully.

Check the following on your computer:

- Make sure your computer is turned on and that it does not shut down automatically as part of an energy-saving feature.
- Make sure the modem connected to your computer is turned on and is connected to the outgoing phone line.
- Make sure the modem you are using with your handheld has an on-off switch. Your handheld cannot “wake up” a modem that has an auto-off feature.
- Make sure the modem is connected properly to your computer and is connected to the incoming phone line.

On a Windows computer, check the following:

- Make sure that Modem is selected in the HotSync Manager menu.
- Confirm that the Setup String in the Setup dialog box configures your modem correctly. You may need to select a different Modem Type or enter a custom setup string. Most modems have a setup string that causes them to send initial connection sounds to a speaker. You can use these sounds to check the modem connection.
- Confirm that the Speed setting in the Setup dialog box works for your modem. If you have problems using the As Fast As Possible option or a specific speed, try using a slower speed.
- Make sure you are not running another program, such as WinFax, CompuServe, or America Online, that uses the serial port you selected in the Setup dialog box.
- Make sure your modem resets before you try again. (Turn off your modem, wait a minute, and then turn it back on.)



I tried to do a modem HotSync operation, but it did not complete successfully (continued).

On a Mac computer, check the following:

- Make sure that Internal Modem is selected on the Connection Settings tab in the HotSync Software Setup window.
- You may need to select a different modem type or enter a custom setup string from the Connection Settings tab. Most modems have a setup string that causes them to send initial connection sounds to a speaker. You can turn on the Modem Speaker option and use these sounds to check the modem connection.
- Make sure you are not running another program, such as America Online, fax or telephony software, or AppleTalk networking, that uses the serial port you selected in the Connection Settings tab.
- Make sure your modem resets before you try again. (Turn off your modem, wait a minute, and then turn it back on.)

Check the following on your handheld:

- Confirm that the telephone cable is securely attached to your modem.
- Make sure the dialing instruction specifies the correct phone number.
- If you need to dial an outside line prefix, make sure you selected the Dial Prefix option on your handheld and entered the correct code.
- If the telephone line you are using has Call Waiting, make sure you selected the Disable call waiting option under Modem Sync Phone Setup on your handheld and entered the correct code.
- Make sure the telephone line you are using is not noisy, which can interrupt communications.
- Check the batteries in your modem, and replace them if necessary.

- I can't perform an IR HotSync operation.
- On a computer running Windows 98, be sure that the HotSync Manager is running, that Infrared is selected on the HotSync Manager menu, and that the Serial Port for local operations is set to the simulated port for infrared communication. See [“Conducting IR HotSync operations”](#) in [Chapter 21](#) for details.
 - On a computer running Windows 2000/ME/XP, select IR in the HotSync Manager. See [“Preparing your computer for infrared communication”](#) in [Chapter 21](#) for details.
 - On a Mac computer, make sure the infrared communications extensions have been installed in the Extensions folder inside the System folder. Next, open the HotSync Software Setup window, and be sure that HotSync Manager is enabled and that the Local Setup Port is set to Infrared Port. See [“Conducting IR HotSync operations”](#) in [Chapter 21](#) for more information.
 - On your handheld, be sure the HotSync application is set to Local, with the option IR to PC/Handheld.
 - Be sure the IR port of your handheld is aligned directly opposite to, and within a few inches of, the infrared device of your computer.
 - IR HotSync operations do not work after you receive a low battery warning. Check the battery power of your handheld. Recharge the internal battery.
- My handheld appears to freeze when I place it near my computer.
- Move your handheld away from the computer's infrared port.
- When I press the HotSync button on the cradle/cable, nothing happens on Palm Desktop software, and my handheld times out.
- Make a copy of your Palm folder. Uninstall, and then reinstall Palm Desktop software.
 - Turn on your handheld, and tap the Home icon . Select the HotSync icon , and then tap Local.

When I perform a HotSync operation, my information does not transfer to Palm Desktop software.

- If you have performed a HotSync operation successfully but you cannot find the data from your handheld on Palm Desktop software, check to see that you have the correct user name selected for viewing data.
- On a Windows computer, click the HotSync Manager and select Custom. Check that all conduits are set to synchronize files.
- On a Mac computer, double-click the HotSync Manager icon. From the HotSync menu, select Conduit Settings. Select your user name from the User pop-up menu, and check that the correct conduit is active.

My handheld displays the message “Waiting for sender” when it’s near my computer’s infrared port.

- Your computer’s infrared port may be set to search automatically for the presence of other infrared devices. Consult the documentation for your operating system for information about turning off this option.
- In some cases simply moving your handheld away from the computer’s infrared port solves the problem.

I want to synchronize my computer with more than one handheld.

- If the computer running Palm Desktop software synchronizes with more than one handheld, each handheld must have a unique name. Assign a user name to your handheld the first time you perform a HotSync operation.
- Be aware that synchronizing more than one handheld with the same user name causes unpredictable results and, potentially, loss of your personal information.

I can’t perform a Bluetooth™ HotSync operation.

- Make sure that Bluetooth communication is enabled on both your handheld and your computer.
- When you perform a Bluetooth HotSync operation, your handheld attempts to connect to a Bluetooth virtual serial port on your computer. First it looks for a Bluetooth serial HotSync port. If it cannot find that port, it then looks for a generic Bluetooth serial port. However, some generic Bluetooth serial ports do not support HotSync operations.
- Your handheld may not be able to recognize the virtual serial port on your Windows computer. Try validating the virtual serial port you’re using, or create a different virtual port and change the HotSync Manager settings to use the new virtual port. Refer to the documentation that came with your computer operating system for instructions.

I can't perform a Bluetooth HotSync operation (continued).

- Some computers have a dedicated virtual serial port number, such as COM5, and other computers enable you to choose a port number such as COM8 or COM12. Refer to the documentation that came with your computer for information on dedicated versus flexible virtual ports.
- If the virtual serial port you want to use is used by other applications, exit those applications before setting up your computer for a Bluetooth HotSync operation.

I receive an authentication error when I try to perform a HotSync operation using Bluetooth and a wireless LAN access point.

- Make sure you entered the correct user name and password for the selected network service profile in the Network Preferences screen. See [“Network Preferences”](#) in [Chapter 22](#) for details.

When I try to perform a HotSync operation using Bluetooth and a wireless LAN access point, it connects but nothing happens.

- Make sure that Network is selected on the HotSync Manager menu on your computer.
- Contact your system administrator to make sure you network computer is properly set up.

Beaming and sending problems

Problem

Solution

I cannot beam data to another device with an IR port.

- If you are beaming to another Palm handheld, confirm that your handheld and the other handheld are between ten centimeters (approximately 4") and one meter (approximately 39") apart and that the path between the two handhelds is clear of obstacles. Beaming distance to other devices with an IR port may be different.
- Move your handheld closer to the receiving device.
- Make sure the receiving device has enabled beam receive.

When someone beams data to my handheld, I get a message telling me it is out of memory.

- Your handheld requires at least twice the amount of memory available as the data you are receiving. For example, if you are receiving a 30KB application, you must have at least 60KB free.
- Perform a soft reset. See [“Performing a soft reset”](#) in [Appendix A](#) for more information.

I cannot send data to another Bluetooth device.

- Make sure that Bluetooth communication is enabled on both your handheld and the other device.
- Make sure that the receiving device has a compatible, Bluetooth application installed.

Phone connection problems

Problem



My passkey is rejected when I attempt to pair (or bond) my mobile phone with my handheld.

Solution

- Some mobile phones require that you enter the passkey within a specific timeframe. Make sure you have a passkey in mind and that you enter it immediately when prompted.
- If your passkey is rejected, your phone may have a preassigned passkey; see the documentation included with your phone for information. The documentation might refer to a Bluetooth connection as a Bluetooth pair or a Bluetooth link.
- If you need additional information about pairing your phone and handheld, refer to the *Phone Pairing Handbook* at www.palm.com/support/globalsupport.

My handheld cannot connect to my mobile phone.

Use the following steps to test the connection:

1. Tap the Home icon .
2. Select the Phone Link icon .
3. Tap Connect.
4. If the connection is successful, open the application that requires the connection and complete the desired task.

If the connection is not successful, try the steps that follow.

- If you have a Bluetooth phone, you may need to go through the pairing process on both your handheld and your phone. See “[Setting up a phone connection](#)” in [Chapter 14](#) for information on completing the pairing process on your handheld. See the documentation included with your phone for assistance with completing the pairing process on your phone. If you need additional information about connecting your phone, refer to the *Phone Pairing Handbook* at www.palm.com/support/globalsupport.
- Make sure the Connection for your mobile phone is selected in the Connection Preferences screen and the Phone Preferences screen.
- If you are using a Bluetooth connection, make sure that your phone is equipped with Bluetooth technology, that Bluetooth is enabled, and that the power is on.

My phone connection drops before I finish using it.

- You need to increase the Idle timeout setting on the Network Preferences Details screen. See [“Adding detailed information to a network service profile”](#) in [Chapter 22](#) for instructions.

I get an error message when I try to dial a phone number using my handheld.

- Make sure that the proper phone driver is installed on your handheld. See [“Updating the phone files on your handheld”](#) in [Chapter 14](#) for instructions.
- You may need to go through the pairing process on both your handheld and your phone. See [“Connection Preferences”](#) in [Chapter 22](#) for information on completing the pairing process on your handheld. See the documentation included with your phone for assistance with completing the pairing process on your phone.
- Check the Phone Preferences screen and make sure the correct phone connection is selected.

VersaMail™ problems

Problem

I am having problems accessing my account.

Solution

Occasionally you may experience problems using an e-mail account after you set it up. Be sure to follow the account setup procedures in [Chapter 17](#). If you followed the procedure and are experiencing problems using the account, verify that the account complies with your e-mail provider’s requirements by following these steps:

- Verify both your password and your username for your e-mail account.
- If you are connecting using an external modem device such as a PalmModem® accessory, verify that you have an account with an ISP and are able to dial in over a voice phone line.
- If you are connecting using a mobile phone through either the built-in Bluetooth radio on your handheld, a cable, or the IR port on your handheld, verify that you have either a data-enabled GSM or a high-speed GPRS account with your wireless service provider.
- Some wireless service providers require you to be on their network to use your e-mail account. If this is the case, be sure to use your provider's network as the connection type for the account.

I am having problems accessing my account (continued).

- Some wireless service providers have other requirements specific to their service. For example, Yahoo! requires you to set up POP mail forwarding for your Yahoo! account in order to download e-mail messages to your handheld. Check with your service provider to see if any provider-specific requirements exist.
- Service provider settings frequently change. If your e-mail account was working, but you are currently experiencing problems, check with your service provider to see if any of the account settings have changed.

I am having difficulty sending and receiving mail using a synchronize-only account.

Make sure you have chosen the same settings for the account on both your handheld and your desktop. For example, if the account is set up on the handheld to use the POP protocol, check the HotSync manager on the desktop to make sure that POP is selected as the protocol for that account.

Recharging problems

Problem

When I connect my handheld to the cradle/cable, it does not charge.

Solution

- Confirm that your handheld is firmly connected to the cradle/cable.
- Confirm that your recharger cable is properly connected to the back of the cradle/cable's USB or serial port connector that plugs into your computer.
- Confirm that your recharger is plugged into an AC outlet that has power.
- If you have not used your handheld for a long period, such as an extended vacation, the battery may not contain enough charge to power the indicator light. After your handheld has recharged, the indicator light will function normally.

Password problems

Problem	Solution
I forgot the password, and my handheld is not locked.	<ul style="list-style-type: none"> ■ First, use the password hint to try and remember the password. If this doesn't help or if you do not have a password hint, you can use Security to delete the password, but your handheld deletes all entries marked as private. However, if you perform a HotSync operation <i>before</i> you delete the password; the HotSync process backs up all entries, whether or not they are marked private. Then you can follow these steps to restore your private entries: <ol style="list-style-type: none"> a. Use the Palm Desktop software and the cradle/cable or infrared communication to synchronize your data. b. Tap Forgotten Password in Security to remove the password and delete all private records. c. Perform a HotSync operation to synchronize your data and restore the private records by transferring them from your computer to your handheld.
I forgot the password, and my handheld is locked.	<ul style="list-style-type: none"> ■ First, use the password hint to try to remember the password. If this doesn't help or if you do not have a password hint, you must perform a hard reset to continue using your handheld. See “Performing a hard reset” in Appendix A for more information.



Technical support

If, after reviewing the sources listed at the beginning of this appendix, you cannot solve your problem, go to www.palm.com/support/globalsupport or send an e-mail to your regional Technical Support office.

Before requesting support, please experiment a bit to reproduce and isolate the problem. When you do contact support, please provide the following information:

- The name and version of the operating system you are using
- The actual error message or state you are experiencing
- The steps you take to reproduce the problem
- The version of handheld software you are using and available memory

To find version and memory information:

1. Tap the Home icon .
2. Tap the Menu icon .
3. Select Info from the App menu.

NOTE Palm works with developers of third-party add-on applications to ensure the compatibility of these applications with your new Palm handheld. Some third-party applications, however, may not have been upgraded to be compatible with your new Palm handheld. If you suspect that a third-party application is adversely affecting the operation of your handheld, contact the developer of the application.

Product Regulatory Information

FCC Statement

This device complies with part 15 of the FCC rules. Operation is subject to the following two conditions: (1) This device may not cause harmful interference, and (2) this device must accept any interference received, including interference that may cause undesired operation.

NOTE This equipment has been tested and found to comply with the limits for a Class B digital device, pursuant to Part 15 of the FCC rules. These limits are designed to provide reasonable protection against harmful interference in a residential installation. This equipment generates, uses, and can radiate radio frequency energy and, if not installed and used in accordance with the instructions, may cause harmful interference to radio communications. However, there is no guarantee that interference will not occur in a particular installation. If this equipment does cause harmful interference to radio or television reception, which can be determined by turning the equipment off and on, the user is encouraged to try to correct the interference by one or more of the following measures:

- Reorient or relocate the receiving antenna.
- Increase the separation between the equipment and receiver.
- Connect the equipment into an outlet on a circuit different from that to which the receiver is connected.
- Consult the dealer or an experienced radio/TV technician for help.

The use of shielded I/O cables is required when connecting this equipment to any and all optional peripheral or host devices. Failure to do so may violate FCC rules.

CAUTION Changes or modifications not covered in this manual must be approved in writing by the manufacturer's Regulatory Engineering Department. Changes or modifications made without written approval may void the user's authority to operate this equipment.

Responsible Party:

Palm Solutions Group
400 N. McCarthy Boulevard
Milpitas, California 95035
United States of America
(408) 503-7500

Palm™ Tungsten™ T2 Product Family

 Tested to Comply
With FCC Standards

FOR HOME OR OFFICE USE

MPE (Maximum Permissible Exposure) Statement

RF Exposure Compliance:

In order for this device to comply with FCC rules, under the provision of Part 15.247(b)(c), it must operate in a manner that ensures that the public is not exposed to radio frequency energy levels in excess of the Maximum Permissible Limits (MPE).

It is recommended that the antenna of this device be placed at 20 cm or more from its user and any nearby persons, during continuous and extended data transmission. The users of this device should ensure that the operation of this device is in compliance with these provisions.

Canadian IC Notice

Certification No: 3905-550007A

To prevent radio interference to the licensed service, this device is intended to be operated indoors and away from windows to provide maximum shielding. Equipment that is installed outdoors is subject to licensing.

Canadian ICES-003 Statement

This Class B digital apparatus meets all requirements of the Canadian Interference-Causing Equipment Regulations.

Cet appareil numérique de la classe B respecte toutes les exigences du Règlement sur le matériel brouilleur du Canada.

FAA Statement

Whenever you use the wireless features of your handheld, please observe the guidelines or prohibitions on the use of wireless devices in your current location. For example, when you are on an airplane, do not use the Bluetooth™ communication features of your handheld at times when government or airline regulations prohibit the use of cellular phones. You can, of course, use all other applications on your handheld in accordance with airline regulations for electronic devices.

Electrical Transmission Statement

This product has been certified as conforming to technological standards for a wireless device as a small electrical data transmission under electrical transmission law. Therefore, you do not need a license from a government agency to operate this product.

This product has been certified as conforming to technological standards. Therefore, the following action are punishable by law:

Disassembly or modification of this product.

Removal of identification labels on the back of this product.

ARIB STD-T66 Statement (Japan)

This product uses a radio wave in the 2.4 GHz bandwidth. This frequency is also used by the microwave ovens industry, scientific and medical devices, in addition to wireless transmitters for motion detectors, such as those requiring licenses used on manufacturing lines or similar radio transmitters. It is also used in specified amateur radio stations or small radio stations not requiring licenses (all these wireless devices will be called "other wireless transmitters" below).

1. Before using this product, confirm that other wireless transmitters are not in use nearby.
2. In the unlikely event that there is electronic interference between this product and other wireless transmitters, quickly change the operating frequency of this product, change the location of operation, or stop operating the product (cease transmission of a signal).
3. If other electrical interference or related problems should occur, contact the responsible party.

Europe R&TTE Directive (Europe)

Declaration of Conformity

Application of Council Directive(s): 1999/5/EEC, R&TTE EU Directive

Standards to which Conformity is Declared:

EMC standard ETSI 300 826
Radio standard ETSI 300 328-2
Safety standard EN69950

Manufacturer's Name: Palm, Inc.

Manufacturer's Location: 400 N. McCarthy Boulevard
Milpitas, CA 95035
USA

Importer's Name: Palm Germany GmbH

Importer's Location: Landsberger Strasse 155
D-80687 Munchen, Germany

Type of Equipment: Palm handheld with Bluetooth capability

Model Number: Tungsten T2

Year of Manufacture: 2003

Applicable countries complying with this declaration: Austria, Belgium, Denmark, Finland, France, Germany, Greece, Iceland, Ireland, Italy, Luxembourg, Norway, Portugal, Spain, Sweden, Switzerland, Holland, UK.

I, the undersigned hereby declare that the equipment specified above conforms to the above Directive(s) and Standard(s)

Place: Milpitas, CA

Date: April, 21, 2003

Typed Name: David Woo

Title: Global Compliance Manager

Taiwan Statement

Article 14: Unless approved, for any model accredited low power radio frequency electric machinery, any company, trader, or user shall not change the frequency, increase the power, or change the features and functions of the original design.

Article 17: Any use of lower power radio frequency electric machinery shall not affect the aviation safety and interfere with legal communications. In even that any interference is found, the use of such electric machinery shall be stopped immediately, and reusing of such products cannot be resumed until no interference occurs after improvement.

The legal communications mentioned in the above item refer to radio communications operated in accordance with telecommunication laws and regulations.

Low power radio frequency electric machinery shall resist against interference from legal communications or from industrial, scientific, and medical radio electric machinery.

Battery Warning

Do not mutilate, puncture, or dispose of batteries in fire. The batteries can burst or explode, releasing hazardous chemicals. Discard used batteries according to the manufacturer's instructions and in accordance with your local regulations.

Varning

Eksplotionsfara vid felaktigt batteribyte. Använd samma batterityp eller en ekvivalent typ som rekommenderas av apparattillverkaren. Kassera använt batteri enligt fabrikantens instruktion.

Advarsel!

Lithiumbatteri—Eksplotionsfare ved fejlagtig håndtering. Udskiftning må kun ske med batteri af samme fabrikat og type. Levér det brugte batteri tilbage tilleverandøren.

Varoitus

Paristo voi räjähtää, jos se on virheellisesti asennettu. Vaihda paristo ainoastaan valmistajan suosittelemaan tyyppiin. Hävitä käytetty paristo valmistajan ohjeiden mukaisesti.

Advarsel

Ekspløsjonsfare ved feilaktig skifte av batteri. Benytt samme batteritype eller en tilsvarende type anbefalt av apparatfabrikanten. Brukte batterier kasseres i henhold til fabrikantens instruksjoner.

Waarschuwing!

Bij dit produkt zijn batterijen geleverd. Wanneer deze leeg zijn, moet u ze niet weggooien maar inleveren als KCA.

Uwaga

Nie kroić lub przekłuwać baterii, ani nie wrzucać ich do ognia. Mogą się rozerwać lub wybuchnąć wydzielając trujące środki chemiczne. Zużytych baterii należy pozbywać się w sposób opisany przez producenta i zgodnie z miejscowymi przepisami.

אזהרה
יש סכנת התפוצצות אם מחליפים את הסוללה בצורה לא נכונה.
יש להחליף את הסוללה בסוללה זהה או דומה, בהתאם להמלצת היצרן.
יש להשליך סוללות משומשות בהתאם להוראות היצרן

A

ABA. *See* Address Book archive files

Accented characters, Graffiti 2 writing 30

Account. *See* E-mail account

Add/Remove Programs icon 76

Add-on applications 68–75

Address Book

- *If Found Call* entry 79
- adding custom fields 85
- adding e-mail address from 231
- adding entry from e-mail 258–259
- archive files (.aba) 38
- business card for beaming 34
- categorizing records 55
- conduit for synchronizing 354
- creating records 50
- deleting records 52
- displaying category 85
- displaying data in the Address list 80
- finding records 20–60
- fonts 66
- menus 83
- notes for records 65
- opening 77
- overview 77
- private records 435
- sorting records 63
- using to address e-mail 231

Addressing e-mail

- displaying another address 187, 194, 201, 290
- message 230–233
- using Smart Addressing 232

Addressing SMS messages 160

Advanced VersaMail preferences 255

Agenda (Date Book view) 106

Alarm

- indicator light 13
- LED 13, 387, 388
- lists 67

- preset 109
- setting in Date Book 100
- setting in Note Pad 134
- setting in Voice Memo 313
- setting in World Clock 349
- sound 109, 214, 350, 387, 452
- Vibrate setting 387, 388

Alerting for new mail 213

Alphabet

- Graffiti 2 writing 27
- onscreen keyboard 18

APOP

- adding to an account 288, 291, 293
- and synchronization 263
- requirement 181, 287

Application buttons 12, 41, 78, 95, 111, 131, 171, 421

Applications

- Address Book 77
- beaming 33–35
- Calculator 87
- Card Info 91
- categories 44–45
- Date Book 95
- Dialer 111
- downloading 322
- Expense 119
- font style 66
- installing 68–74
- Launcher 41–45
- Memo Pad 127
- Note Pad 131
- opening 42
- Palm Photos 137
- Phone Link 149
- plug-in 418
- preferences for 50
- removing 75
- sending data from 166
- size in kilobytes 465
- SMS 159

- To Do List 171
- VersaMail 177
- version of 465
- viewing as icons 45
- viewing as list 45
- Voice Memo 307
- Web Browser Pro 317
- World Clock 343
- See also* Add-on applications
- Archive files
 - importing data from 37
 - for main applications 38
 - messages in SMS 163
 - saving deleted records 53
 - saving purged records 54
- Attaching a signature to messages 188, 195, 202
- Attachments 163
 - attaching files from an expansion card 249
 - attaching files from applications 247
 - downloading 258
 - icon for 217
 - saving to expansion card 247
 - selecting plug-ins 275
 - sending 233
 - using Documents To Go 274–276
- Audio files 69, 72
- Auto get mail 209
 - notification options 213
 - notifications 212
 - Reminders screen 215
 - resource issues 217
 - scheduling 210
 - VPN connections 182
- Autofill, enabling or disabling 337
- Automatic fill, in Expense 126
- Automatic sending of messages. *See* Send retry
- Auto-off delay 385
- Autotext. *See* Graffiti 2, shortcuts for entering text
- B**
- Background sending of messages. *See* Send retry
- Backing up
 - e-mail databases 299
 - See also* Archive files and HotSync
- Battery
 - conserving power 385
 - disposal 470
 - gauge 41
 - life and use 444
 - recharging 6
 - recycling 444
 - warning 470
- Bcc field 230
 - See also* Blind copies
- Beaming
 - information 33–36
 - location of IR port 13
 - pen stroke to activate 423
 - problems with 461
 - URLs 327
 - See also* Infrared
- Beep for new e-mail 212
- Blind copies 187, 188, 194, 195, 201, 202, 231, 290
- Blinking asterisk 215
- Bluetooth
 - entering passkey 152, 462
 - HotSync operations 370–372
 - making connections 397
 - phone connection 149–158
 - preferences 389–398
- Bold font for text 66
- Bookmarking web pages 329–331
- Brightness control 13, 18, 422
- Broken envelope icon 215
- Browsing the web 320–322
- Business card for beaming 34
- Buttons preferences 111, 421–423
- C**
- Cache 339
- Calculator
 - buttons explained 87–88
 - memory 88
 - overview 87
 - recent calculations 87, 88
- Calibration 17, 382
- Call Waiting, disabling 368, 408
- Calling card, using in phone settings 368, 409
- Capital letters (Graffiti 2 writing) 28

- Card Info 91
- Caring for the handheld 443
- Categories 162
 - application 44–45
 - assigning records to 55–56
 - beaming 33–35
 - bookmarks 329
 - creating 57
 - default 44, 55
 - displaying 56, 85, 453
 - merging 58
 - renaming 57
 - saved web pages 332
 - sending 37
 - using in Applications Launcher 44, 45
- Cc field 231
- Chain calculations 88
- Characters, Graffiti 2 24
- Charging handheld 6
- Check boxes 19
- Clearing
 - cache 339
 - Calculator entries 87
 - History list 334
 - reminders 215
- Color Theme preferences 424
- Combining categories 58
- Comma-delimited files, importing data
 - from 38
- Command
 - buttons 19
 - equivalents (Graffiti 2 writing) 49
 - stroke 36, 49, 62
 - toolbar 49
- Command toolbar
 - activating 49
 - in VersaMail 297
- Communication preferences 379
 - Bluetooth 389–397
 - Connection 398–403
 - Network 403–420
 - Phone 420
- Compressing
 - Day view 109
 - images 336
- Conduits
 - account information screens 271
 - for modem HotSync operations 369
 - for synchronizing applications 455
 - for synchronizing applications, Mac 356
 - shortcuts 272
 - SSL and 278
 - for synchronizing applications 354–355, 446, 447
 - synchronizing multiple accounts 278
- Conflicting events 107
- Connecting
 - service templates 404
 - to server or ISP 410
 - to the Internet 319
 - with a GPRS network 400–402, 403–413
 - with a non-GSM phone 402–403
 - with a phone 400–403
- Connection
 - mobile phone 317
 - modifying Web Browser Pro
 - preferences 340
 - preferences 398–403
 - preferences for Bluetooth 407
 - requirements 317
- Connection types
 - changing in e-mail account 284
 - modem sled, prerequisite for 180
 - PalmModem accessory, prerequisite for 180
 - synchronize-only connection 179
- Content
 - latest web page 324
 - old web page 324
- Continuous events
 - deleting from Date Book 53
 - scheduling 101
- Contrast control. *See* Brightness control
- Controlling Internet access 340
- Cookies
 - definition 338
 - enabling or disabling 338
- Copying
 - notes into other applications 131
 - photos into other applications 137
 - text 52
 - text in Web Browser Pro 326
- Country default setting 383
- Cradle
 - connecting to computer 14
 - for local HotSync operations 357, 364
 - viewing data from 385

Creating

- Address Book entries 78–79
- categories 44–45, 57
- currency symbols 123
- custom fields in Address Book 85
- Date Book events 95
- e-mail folders 228–229
- Expense items 120
- expense reports 125
- notes for records 65
- records 50
- ShortCuts 440
- signature 165
- SMS messages 160
- synchronize only e-mail account 189–196

Currency

- default 123
- defining 123
- for Expense items 122

Current date 453**Current time** 41**Custom**

- currencies and symbols 123
- fields in Address Book 85

Cutting

- text 52
- text from web pages 326

Cycling through views 78, 95, 131, 171**D****Data entry.** *See* Entering data**Databases**

- backing up 299
- downloading 322
- upgrading a MultiMail database 178

Date

- displaying in World Clock 350
- Expense item 121
- setting current 345, 381, 453
- To Do List record due 174

Date & Time preferences 381–382**Date Book**

- adding Address Book data to records 61–62
- Agenda view 106
- alarm 100
- archive files (.dba) 38

changing event time 99

changing event to untimed 99

conduit for synchronizing 354

conflicting events 107

continuous events 101–103

creating records 50, 96–99

Day view 103

deleting records 52

display options 108

end time for Day view 109

fonts 66

menus 107

Month view 105

notes for records 65

opening 95

overview 95

private records 435

purging records 54

repeating events 53, 101–103

scheduling events 95–99

selecting dates 97

start time for Day view 109

Sunday or Monday to start week 383

switching views 103

untimed events 96, 98

viewing appointment reminders 215

Week view 104, 383, 453

Day (Date Book view) 96, 109**Daylight Saving**

options 348

settings 347

DBA (Date Book archive file) 38**Decimal point** 383**Default**

categories 44, 55

currency in Expense 123

Deleted data, saving in archive files 53**Deleting**

applications 75

bookmarks 330

Desktop software 75

e-mail 251–254, 289

filters 283

Graffiti 2 characters 26

mail in the trash 254

old messages 253

passwords 426

records 52

saved web pages 333

- service templates 418
- text 52
- See also* Purging records
- Desktop software
 - displaying euro 125
 - linking to external files 39, 375
 - removing 76
 - saving deleted data in archive file 53
- Device
 - assigning name 390
 - enabling/disabling the user cache 397
 - types with which you can connect 389
- Digitizer 17, 382
 - calibrating your handheld 17
 - preferences 382
- Disabling
 - autofill 337
 - cookies 337
 - JavaScript 338
- Disconnecting
 - a modem 295
 - from the Internet 319
- Discovery
 - and connection process 391
 - defined 391
 - enabling/disabling the user cache 397
- DNS 414
- Documents To Go, converting
 - attachments 274–276
- Domain name system. *See* DNS
- Double-booked events 107
- Download message size 186, 193, 200
- Downloading
 - e-mail attachments 217
 - files, all types 322
 - messages from phone 161
 - stopping 323
- Drafts
 - creating in SMS 164
 - creating in VersaMail 228
 - saving in VersaMail 233, 236
- Dragging
 - memos into other applications 127
 - stylus to activate features 422
 - using the stylus 17

E

- Editing
 - bookmarks 330
 - records 51–52
 - saved web pages 332
- E-mail
 - adding Address Book entry from e-mail 258–259
 - adding attachments 247–249
 - addresses in Address Book 79
 - addressing 230
 - alert for new mail 213
 - attaching files 207
 - attachments 241–251
 - backing up databases 299
 - beeping for new e-mail 212
 - buzzing or blinking for new mail 214
 - color selection 223
 - composing 233
 - copying and pasting text 296
 - creating new messages 229–233
 - days to synchronize 265
 - deleting messages on handheld 251–254
 - deleting messages on server 289
 - display options 220
 - downloading large attachments 245–247
 - drafts 236
 - e-mailing URLs 328
 - emptying trash 254–255
 - filters for 279–280
 - folder on server 289
 - font selection 222
 - forwarding 237, 238
 - forwarding attachments 251
 - getting entire message 207
 - getting on desktop 261–264
 - getting subject only 207
 - header details 298
 - HTML 241
 - icons 217, 236
 - leaving mail on server 185, 193, 199, 287
 - managing mail settings 283
 - marking read and unread 256–257
 - maximum message size 186, 193, 200
 - notification options 213
 - personal signature 237, 258
 - preferences 257–258
 - reading 206

- replying to 238–240
 - Secure Sockets Layer 302
 - send retry 234
 - sending 233
 - signature, adding 188, 195, 202
 - storing in Outbox 233
 - trash 254
 - URLs in messages 241
 - viewing attachments 241–245
- E-mail account
- advanced preferences 294
 - APOP setting 288
 - auto get mail 209
 - before setting up 180
 - changing e-mail address 286
 - changing mail server settings 287
 - changing protocol type 284
 - changing username and password 284
 - checking for new messages 206, 207
 - color selection 223
 - corporate 181
 - creating a synchronize-only
 - account 189–196
 - creating new 182–186, 192–194
 - default mail service 204–205, 285
 - deleting accounts 203–204
 - display options 220
 - displaying Inbox 206
 - editing 202, 203
 - editing accounts 196–291
 - font selection 222
 - incoming and outgoing server 184, 191, 198
 - managing mail settings 283
 - notification option 212
 - outgoing mail server 289
 - password 184, 191, 197
 - problems with 206
 - synchronization options 261–264
 - synchronizing 260, 276–277
 - troubleshooting 206
 - username 184, 191, 197
- Emptying the History list 334
- Enabling
- autofill 337
 - cookies 337
 - JavaScript 338
- Encrypting data 438–439
- Entering data 23–40
- importing from other applications 37–40
 - problems with 452
 - using Note Pad 40
 - using the computer keyboard 37
 - using the onscreen keyboard 23
- Entries. *See* Address Book
- Envelope icon 217
- Error log 260
- ESMTP 181, 291
- adding to an account 293
- Eudora, configuring for e-mail 273
- Euro
- displaying on desktop computer 125
 - in Expense 122, 123
 - in Graffiti 2 writing 30
 - in onscreen keyboard 24
 - printing 125
- Events. *See* Date Book
- Exclamation marks in To Do List 175
- Expansion
- adding hardware 14
 - using cards 91–93
- Expansion Card
- applications 42
 - copying applications 46
 - described 16
 - formatting 92
 - renaming 92
- Expense
- adding Address Book data to
 - records 62–63
 - categorizing records 55
 - creating records 120
 - currency 122
 - date of item 121
 - defining new currency 123
 - menus 126
 - overview 119
 - receipt details 121
 - reports 125
 - type 121, 126
 - vendor 122
- Extended MAPI 262
- External keyboard 40
- ## F
- FAQs. *See* Frequently asked questions
- FCC Statement 467

File types that can be downloaded 322

Filed SMS messages 163

Files

converting attachments 274–276

error log 260

linking to external 39, 375

Filters

creating 279–281

deleting 283

editing 283

examples of 282

turning on and off 281–282

Finding

applications, using Graffiti 2 writing 42

information in applications 58–63

phone numbers 61–62

using the Find application 60

Folders

creating new 228

viewing other 220

Fonts

choosing fonts in applications 66

euro symbol 125

setting size in Web Browser Pro 334

Forgotten password 432

Formats preferences 382

Forwarding e-mail 237

Frequently asked questions

application problems 453

beaming and sending problems 461

HotSync problems 454

operating problems 451

password problems 465

phone connection problems 462

recharging problems 464

software installation problems 450

tapping and writing problems 452

VersaMail problems 463

Frozen handheld 452

G

Games 387

General preferences 214, 380–388

alarm LED 387

alarm sounds 387

alarm vibrate 387

Date & Time 381–382

Digitizer 382

Formats 382–383

Graffiti 2 384

opening 380

Power 384–386

Sounds & Alerts 386–388

system sounds 387

Writing Area 388

Getting e-mail, checking for new messages 207

Glossary. *See* Graffiti 2 ShortCuts

GPRS network

connecting to 403–413

GPRS defined 400

loss of network connection 413

sending an INIT string 412–413

service limitations 413

Graffiti 2

accented characters 30

alphabet 24, 27

basic concepts 24

capital letters 28

Command stroke 49

how to write characters 25

menu commands 49

numbers 28

online Help 52, 422

preferences 384

problems using 452

punctuation marks 28

ShortCuts for entering data 32, 440–442

symbols 30

tips 26

writing area 12, 25

Graphics pick list 336

GSM phones

accessing the Internet 411

and GPRS networks 400

connecting with 401–402

entering passkey 152, 462

requirement for SMS 159

H

Handheld

alarm 214

blinking 214

buzzing 214

increasing space on your handheld 16

vibrating 214

Hard reset 445, 451
Hardware add-ons 14
Help
 Graffiti 2 52
 online tips 19
 onscreen keyboard 319
Hiding records 433
History list
 clearing 334
 definition 333
 limit 333
Home page
 changing 335
 returning to 322
Host name 341
Host server, changing 341
HotSync
 Bluetooth operations 370–372
 buttons preferences 423
 conduits for synchronizing
 applications 354–355, 446, 447
 conduits for synchronizing applications,
 Mac 356
 customizing 355, 356
 first-time operation 357–361, 376–378
 IR operation 361–365
 linking to external files 39, 375
 local operation 352, 357, 456
 local operation on Mac 360
 modem operation 353, 365–369, 457–458
 modem settings 366
 network operation 372–375
 operations using cradle 364, 398
 operations using IR port 361–364, 399–
 400
 performing wireless HotSync
 operation 372
 problems with 454–460
 problems with IR 459
 restoring data 446–447
 selecting HotSync operations on your
 handheld 371–372
 setting options 351–353
 starting Manager 260
 synchronize active accounts 260
 synchronizing e-mail 277
 user profiles 376
 using with another PIM 76
Hyperlink. *See* Link

I

Icons
 Add/Remove Programs 76
 alarm 100
 application 18, 45
 Back 322
 beam 36
 Brightness 13
 broken envelope 215
 CD-ROM 7
 Clock 18
 Desktop Installer 7
 Find 60
 for e-mail messages 217, 236
 Forward 322
 Home Page 322
 HotSync Manager 73, 260
 lock 35
 menu 50
 note 65
 on handheld buttons 12
 online Tips 19
 Open URL 320
 paperclip 217
 Quick Connect 81
 Quick Install 69
 Refresh 324
 repeating event 102
 Stop 323
 Tips 20
 USB 5
 VersaMail e-mail 217
 Web 317
Idle timeout of ISP or server connection 414
Images
 changing download preferences in Web
 Browser Pro 336
 compression 336
 copying from web pages 326
IMAP
 adding an account 183, 190, 197
 ESMTP synchronization in 264
 root mailbox 289
 server options 185, 193, 199
 synchronize an account 264
 wireless folder synchronization 300
Importing data 37–40

Inbox
 Reminders screen and 215
 synchronizing 266
 viewing mail 206

Incoming mail server 184, 191, 197, 198
 changing 287

Indicator light 13, 387

Infrared
 connections 398, 399
 HotSync operations 361–364, 399–400
 port 13, 33, 361
 problems with IR HotSync
 operations 459
 requirements for computer 361

INIT string, sending 412–413

Initialization string 400

Installing
 applications 68–74
 conduit to install applications 354

International characters, Graffiti 2
 writing 30

Internet
 access 317, 340
 entering ISP information 411
 using non-GSM phones to access 402

Internet Protocol address. *See* IP address

IP address 341, 413, 415

IR port 13
See also Beaming and Infrared

IR. *See* Infrared

IrCOMM 33, 361, 398, 399

IrDA (Infrared Data Association) 33, 361

ISP
 changing 341
 entering ISP information 411
 login script 181
 requirements for 180
 requiring APOP 288, 291, 293
 requiring ESMTP 293

Items. *See* To Do List or Expense

J

JavaScript, enabling and disabling 338

Jumping to another web page 321

K

Keyboard
 computer 37
 onscreen 18, 23, 319, 422
 portable 40
 shortcuts in VersaMail 304

L

LED 13, 387

Letters
 font style 66
 Graffiti 2 24, 27
 onscreen keyboard 23

Link
 colors, changing 337
 definition 321
 downloading files 323
 unvisited links 337
 visited links 337
See also Connection

List, in Applications Launcher 45

Location
 adding 347–348
 deleting 349
 displaying secondary 350
 modifying 348
 setting primary 344, 346, 381
 setting secondary 347

Locking the handheld with a password 423,
 424, 429–431

Logging informational errors 260

Login scripts
 ISP 181
 network 416–418

Looking up Address Book data
 to add to other records 61–62
 scrolling in Address list 59

Lost
 handheld, contact for 79
 records 453

Lost password 432

Lotus Notes, selecting as mail client 263

Lotus Organizer, importing data from 38

M

- Mail server settings, changing 287
- Mail service, default service for e-mail
 - account 204–205, 285
- Mail settings
 - changing e-mail address 286
 - changing mail server settings 287
 - changing protocol type 284
 - changing username and password 284
 - managing 283
- Mailbox, adding new 182
- Mailto links 327
- Maintenance information 443
- Marking messages unread/read 256
- Masking private records 434
- Maximum cache size 339
- Maximum message size
 - incoming e-mail 186, 193, 200
 - POP and IMAP server 287
- Memo Pad
 - adding Address Book data to records 61–62
 - archive files (.mpa) 38
 - categorizing records 55
 - conduit for synchronizing 354
 - creating records 50
 - deleting records 52, 102
 - dragging memos into other applications 127
 - fonts 66
 - menus 89, 129
 - opening 127
 - overview 127
 - private records 435
 - reviewing memos 128
 - sorting records 63, 453
- Memory
 - amount of free 465
 - for beaming 461
 - Calculator 88
 - limitations on History list 322
 - regaining 54, 451
- Memos. *See* Memo Pad
- Menus 48–50, 169, 452
 - Address Book 83
 - Calculator 89
 - choosing 49
 - command equivalents (Graffiti 2 writing) 49
 - command toolbar 50
 - Date Book 107, 350
 - Edit menu 51–52
 - Expense 126
 - Memo Pad 89, 129, 136
 - menu bar 18, 48
 - Network preferences 419
 - Note Pad 136
 - Palm Photos 147
 - SMS 169
 - To Do List 176
 - Voice Memo 315
 - World Clock 350
- Microsoft Exchange 5.0 262
- Microsoft Outlook
 - connecting to 455
 - synchronizing with 262
- Microsoft Outlook Express
 - configuring for e-mail 273
 - selecting as mail client 262
- Mobile phone. *See* Phone
- Modem
 - auto-disconnect 295
 - HotSync operations via 365–369, 457–458
 - initialization string 400
 - initializing 296
 - preferences 294
 - sled, prerequisite for connection 180
 - timeout 295
 - wireless 296
- Monday, to start week 383
- Month (Date Book view) 105, 109
- MPA (Memo Pad archive file) 38
- MultiMediaCard 9
 - See also* Expansion Card
- Multi-part messages in SMS 160
- Multiple addressees 231

N

- Navigator 12, 20, 160
 - deleting bookmarks 330
 - editing bookmarks 330
 - in VersaMail 302

- returning to web pages you've visited 322
- visiting bookmarked web pages 330
- Netscape 262
- Network
 - connecting 179, 410
 - entering ISP information 411
 - HotSync operation 372–375
 - idle timeout 414
 - login scripts 416–418
 - password 406
 - phone settings 407
 - preferences 403–420
 - prerequisites for connecting in
 - VersaMail 180
 - primary DNS 414
 - secondary DNS 414
 - selecting connection 407
 - selecting service 404
 - user name 405
- Network preferences
 - in Web Browser Pro 340
 - main handheld preferences 403–420
- Non-GSM phones, connecting 402–403
- Note Pad
 - alarm 134
 - copying notes into other applications 131
 - entering data 40
 - menus 136
 - opening 131
 - overview 131
 - reviewing notes 133
- Notes, attaching to records 65
- Notification option, Palm.com account 213
- Numbers
 - decimal point and thousands separator 383
 - Graffiti 2 writing 28
 - onscreen keyboard 18, 23

O

- Old messages, deleting 251
- Old web page content, viewing if available 340
- Onscreen keyboard 23, 52, 319
 - pen stroke to open 422

- Opening
 - Address Book 77
 - applications 41
 - bookmarked web pages 329
 - Calculator 87
 - Date Book 95
 - Dialer 111
 - Expense 119, 137
 - HotSync Manager 351
 - Memo Pad 127
 - Note Pad 131
 - Palm Photos 137
 - Phone Link 150
 - saved web pages 331
 - SMS 159
 - To Do List 171
 - VersaMail 178
 - Voice Memo 307
 - Web Browser Pro 317
 - World Clock 343, 344
- Organizer (Lotus PIM) 38
- Outbox 163, 228
 - storing e-mail 233
 - synchronizing 266
- Outgoing server, settings 184, 191, 198, 289
- Outlook, connecting to 455
- Overlapping events 107
- Owner preferences 424–425

P

- Pages. *See* Web pages
- Palm Photos
 - albums 144–145
 - beaming photos 145
 - copying photos 143
 - copying photos into other applications 137
 - deleting photos 146
 - desktop software 146
 - List view 138
 - menus 147
 - opening 137
 - organizing photos 141–143
 - photo details 140
 - rotating photos 140
 - slide show 139
 - thumbnail view 138

- thumbnails 137
- viewing photos 137
- Palm Quick Install 69–73
- PalmModem accessory, prerequisite for connection 180
- Passkeys 152
 - entering to create a trusted pair with a phone 152, 462
- Passwords 426–428
 - changing 426
 - changing in VersaMail 284
 - creating 426
 - deleting 426
 - editing in e-mail account 196
 - entering in Web Browser Pro 325
 - for network 406
 - forgotten 465
 - VersaMail 184
- Pasting
 - notes into other applications 131
 - photos into other applications 137
 - text 52
 - text from a web page 326
- Payment, Expense item 122
- PDBs 322
- Pen stroke, full-screen 422–423
- Peripheral hardware 14
- Personal preferences 380, 420–442
 - Buttons 421–423
 - Color Theme 424
 - Owner 424
 - Security 425–428
 - Shortcuts 440
- Phone
 - connection problems 462–463
 - creating a trusted pair 402
 - downloading messages from 161
 - entering ISP information 411
 - entering passkey 152, 462
 - Lookup 61–62
 - numbers, selecting for Address list 80
 - numbers, selecting types 79
 - preferences 420
 - settings for ISP or dial-in server 407–409
- Phone Link
 - Bluetooth connection 149–158
 - creating connections with 150–156
 - entering passkey 462
 - overview 149–150
- Phone preferences
 - Dialer 111
 - main handheld preferences 420
 - SMS 159
- Photos. *See* Palm Photos
- Pick lists 19
- PIM (personal information manager), using HotSync Manager with 76
- Plug-in applications 275, 418
- POP accounts, APOP synchronization in 263
- POP3 accounts 185, 193, 199
 - adding an account 183, 190, 197
- Port number 288, 291
- Ports
 - IR on handheld 33, 361
 - serial 4, 5, 363, 364, 398
 - USB 4, 5, 363, 364, 398
- Power button 13
- Power preferences 384–386
- PPP 413
- PQAs 322
- PRC (application file extension) 322, 418
- Preferences
 - advanced e-mail account 294
 - Bluetooth 389–397
 - Buttons 111, 421–423
 - choosing 50
 - Color Theme 424
 - Communication 379
 - Connection 398–403, 404
 - cradle setting 385
 - Date & Time 381–382
 - deleting e-mail 257
 - Digitizer 382
 - Formats 382
 - General 379, 380–388
 - getting mail 257
 - Graffiti 2 384
 - mail databases 299
 - modem 294
 - Network 404–420
 - opening 380
 - Owner 424
 - Personal 380
 - Phone 420
 - Power 384–386
 - Security 425
 - ShortCuts 440
 - SMS 167–169

- Sounds & Alerts 386–388
 - Trash 255
 - Writing Area 388
 - Primary DNS 414
 - Printing expense reports 125
 - Prioritizing To Do List records 172, 175
 - Private records
 - displaying 434
 - hiding 433
 - hiding automatically 435
 - lost with forgotten password 432
 - masking 434
 - masking automatically 435
 - problems displaying 453
 - Problems
 - beaming and sending 461
 - connecting to a phone 462
 - entering data 452
 - installing software 450
 - operating handheld 451
 - performing HotSync operations 454–461
 - recharging handheld 464
 - tapping and writing 452
 - using applications 453–454
 - using Bluetooth 461, 462
 - using passwords 465
 - using VersaMail 463
 - Profile
 - e-mail 264
 - HotSync user profile 376
 - Protocol, changing type 284
 - Proxy server, changing 341
 - Punctuation marks
 - Graffiti 2 writing 28
 - onscreen keyboard 23
 - Purging records 54
 - See also* Deleting
 - Push e-mail 215
- Q**
- Query applications, downloading 322
 - Quick Connect 81–83
 - Quick Install 69–73
- R**
- Range of times in Day view 109
 - Read messages, marking 256
 - Reading e-mail 206–218
 - Receipts, recording in Expense 121
 - Receiving data. *See* Beaming information
 - Receiving messages in SMS 161
 - Recharging the battery 385
 - Records
 - beaming 33–35
 - choosing categories 55
 - creating 50
 - Date Book 96
 - defined 50
 - deleting 52, 102
 - displaying a category of 56
 - editing 51–52
 - Expense 120
 - fonts 66
 - hiding private 426, 433
 - lost 453
 - masking private 426
 - Memo Pad 127
 - notes for 65
 - number of 465
 - private 433–435
 - purging 54
 - sending 37
 - sorting 63–64
 - To Do List 172
 - unmasking individual 435
 - Refreshing a web page 324
 - Reminder lists 67
 - Reminders screen
 - types of reminders 215
 - using 215
 - viewing 215
 - Removing
 - applications 75
 - bookmarks 330
 - Desktop software 75
 - saved web pages 333
 - Renaming
 - bookmarks 330
 - categories 57
 - saved web pages 332
 - Repeating events
 - deleting from Date Book 53
 - scheduling 101
 - Replying to e-mail 238
 - Rescheduling events 99

- Resetting handheld
 - hard reset 445, 451
 - location of reset button 14, 445
 - soft reset 444
- Restoring data
 - Mac 447
 - Windows 446
- Returning
 - to a web page 322
 - to a web page in the History list 333
 - to your home page 322
- S**
- Saving
 - data 43, 51, 53
 - e-mail databases 299
 - e-mail messages 253
 - web pages 331–333
- Scheduled retrieval of e-mail. *See* Auto get mail
- Scheduling events 95–99
- Screen
 - blank 451
 - brightness 13
 - calibrating 17, 382
 - caring for 443
 - touching with your finger 12
- Scroll bar 19
- SD card 9
 - See also* Expansion Card
- SDIO expansion card 13
- Searching. *See* Finding
- Secondary DNS 414
- Secure Digital card. *See* SD card *and* Expansion Card
- Secure Sockets Layer 302
- Security preferences 425–428
- Security shortcuts 440
- Selecting
 - all text from web pages 326
 - date for event 97
 - phone numbers in Address Book 79
 - text 52
- Send retry 234
 - modifying messages during 236
 - notifications 235
- Sending
 - data from applications 166
 - data using Bluetooth communication 36
 - e-mail 233
 - messages in SMS 161
 - problems with 461
 - requirements for e-mail or SMS communication 37
- Serial
 - cradle/cable 353, 363, 364, 398
 - port 4, 5, 352, 363, 364, 365, 366, 398
 - troubleshooting 454, 455, 456, 457, 458, 459, 464
- Server
 - deleting messages on 255, 258
 - sent mail folder 289
- Service
 - changing in Web Browser Pro 341
 - selecting for network 404
 - templates 404, 418
- Settings. *See* Preferences
- ShortCuts
 - backing up 354
 - managing 440–442
 - menu commands 49
 - predefined 32
 - security 440
 - using 32
- Signature 165, 188, 195, 202
 - attaching personal 237, 258
- SMAPI (Simple MAPI) 262
- Smart Addressing
 - turning on 233
 - using 232
- SMS
 - connecting to your mobile phone 159
 - creating messages 160
 - draft messages 164
 - icons 162
 - Inbox 162
 - menus 169
 - overview 159
 - preferences 167–169
 - sending and receiving messages 161
 - sending data from another application 166
 - signature 165
 - viewing messages 162–164
- SMTP settings 289
- Soft reset 445

- Sorting
 - applications 44
 - records 63–64, 453
 - Sounds & Alerts preferences 386–388
 - Sounds. *See* Alarm *and* System sounds
 - Speed of image downloading 336
 - SSL. *See* Secure Sockets Layer
 - Starting applications 42
 - Stopping a download 323
 - Stylus
 - dragging with 17
 - pen stroke to activate a feature 422
 - tapping with 17
 - Sunday, to start week 383
 - Symbols
 - for currency 122
 - in Graffiti 2 writing 30
 - Synchronize-only
 - account, creating 189–196
 - connection 179
 - Synchronizing
 - an existing username 178
 - IMAP folders 300
 - Synchronizing e-mail 276–277
 - account information screens 271
 - active accounts 277
 - e-mail applications for 262
 - HotSync operation 261
 - logging errors 260
 - setting how many days 265
 - shortcuts 272
 - SSL and 278
 - synchronizing multiple accounts 278
 - turn off synchronization 277
 - System
 - conduit 354
 - sounds 387
- T**
- Tab delimited files, importing data from 38
 - Tapping 17
 - TCP/IP 404, 419
 - TDA (To Do List archive file) 38
 - Technical Support 449, 465
 - Text
 - copying 52
 - copying and pasting in e-mail 296
 - cutting 52
 - entry. *See* Entering data
 - files, importing data from 38, 39
 - fonts for 66
 - selecting all 52
 - size setting in Web Browser Pro 334
 - Thousands separator 383
 - Time
 - alarm setting 100
 - Daylight Saving settings and options 347–348
 - format 383
 - setting current 345, 382
 - setting event 96
 - start and end for Date Book Day view 109
 - Time Zone 347
 - Tips, online 19
 - To Do List
 - adding Address Book data to records 61–62
 - archive files (.tda) 38
 - categorizing records 55, 175
 - checking off items 173
 - completed items 175
 - completion date 175
 - conduit for synchronizing 354
 - creating records 50
 - deleting records 52, 102
 - due date 174, 175
 - fonts 66
 - menus 176
 - notes for records 65
 - opening 171
 - overview 171
 - prioritizing records 172, 175
 - private records 435
 - purging records 54, 175
 - sorting records 63
 - viewing task reminders 215
 - To field 231
 - Today. *See* Current date
 - Transmitting data. *See* Beaming, information *and* Sending, data using Bluetooth communication
 - Trash 164
 - automatically emptying 255
 - creating other folders 228
 - emptying deleted e-mail 254–255
 - setting frequency in preferences 255

Troubleshooting 459
Trusted devices, adding trusted devices 394–395
Trusted pairs, creating 402
Turning off handheld
 automatically 385
 pen stroke for 423
 problems with 451
Turning on handheld
 displaying owner's name 424
 power button 13
 problems with 451

U

Undoing actions 52
Uniform Resource Locator. *See* URL
Uninstalling Desktop software 75
Universal connector 14, 398
Unmasking records 435
Unread mail 185, 193, 199, 287
Unread messages, marking 256
Unresponsive handheld 452
Untimed events 96, 98, 99, 101
Upgrading a MultiMail database 178
URL
 beaming 327
 changing home page 335
 definition 318
 e-mailing 328
 entering in Palm Web Browser Pro 320
 Entry field 318, 321
 in e-mail messages 241
 truncated 324
USB
 cradle/cable 352, 354, 363, 364, 398
 port 4, 5, 363, 364, 398
 troubleshooting 454, 455, 456, 464
User cache, enabling/disabling 397
User name
 for ISP 405
 identifying handheld 424
User profiles, HotSync 376–378
Username 184, 191, 197
 changing 284
 editing in account 196
 entering 284
 synchronizing existing 178

V

vCal 38, 39
vCard 38, 39
Vendor for Expense item 122
VersaMail
 icons 217, 236
 launching from Palm Web Browser Pro 327
 problems with 463
 setting preferences for 257
Vibrate alarm 214, 387
Video files 69, 72
Visiting
 bookmarked web pages 329
 web pages 320
Voice Memo
 alarms 313–314
 creating voice memos 308–311
 listening to voice memos 312–313
 menus 315
 opening 307
 overview 307
 reviewing voice memos 312

W

Web address. *See* URL
Web Browser Pro preferences 334–341
Web page
 displaying old content 324, 340
 list of visited 333
 refreshing 324
 returning to 322
 saving 331
 viewing information about 324
Week (Date Book view) 104–105, 383, 453
Wireless
 LAN access point locations 410
 modem 296
World Clock
 adding locations 347–348
 alarm 349
 alarm preferences 350
 Daylight Saving settings and options 347–348
 display options 350
 menus 350
 opening 343, 344
 Time Zone 347

Writing area
 on handheld 12
 preferences 388
Writing. *See* Entering data

