

# ALINCO

VHF/UHF TWIN BAND FM TRANSCEIVER

# DR-610T

# DR-610E

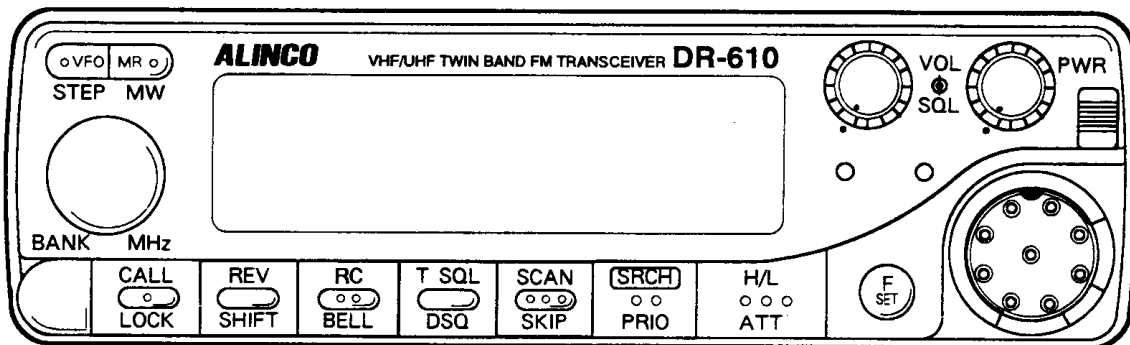

## Instruction Manual

Thank you for buying this **ALINCO** transceiver. This instruction manual contains important safety and operating instructions. Please read it carefully before using the transceiver.

## N O T I C E

This equipment has been tested and found to comply with the limits pursuant to Part 15 of the FCC Rules. These limits are designed to provide reasonable protection against harmful interference in a residential installation. This equipment generates, uses, and can radiate radio frequency energy, and if not installed and used in accordance with the instructions, may cause harmful interference to radio communications. However, there is no guarantee that interference will not occur in a particular installation. If this equipment does cause harmful interference to radio or television reception, which can be determined by turning the equipment off and on, the user is encouraged to try to correct the interference by one or more of the following measures.

- *Reorient or relocate the receiving antenna.*
- *Increase the separation between the equipment and receiver.*
- *Connect the equipment into an outlet on a circuit different from that which the receiver is connected.*
- *Consult the dealer or an experienced radio/TV technician for help.*

# Manual overview

This manual uses the DR-610T (U.S. Version) for examples, however, operation of the DR-610E (European Version) is similar.

## 1. Before Operating the Transceiver

Before making any connections or using the transceiver, please read all precautions thoroughly.

1

## 2. Panel Description

This chapter explains the controls on the front panel, and function display indicators, as well as general cautions and operation of each control

2

## 3. Basic Operation

This chapter explains basic receive and transmit operations. Beginners to twin-band mobile operation should pay particular attention to this chapter.

3

## 4. Functions

This chapter contains explanations of all transceiver operations. Study these explanations in order to master operation of the transceiver.

4

## 5. Selective Calling

This chapter explains selective calling operations such as tone squelch (CTCSS) and DTMF squelch (DSQ).

5

## 6. Remote Control Operation

This chapter explains operation using a DTMF microphone (optional for the DR-610E), as well as remote control of the transceiver using another DTMF equipped transceiver.

6

## 7. Packet Operation

This chapter explains 1200 bps and 9600 bps packet operation.

7

## 8. Maintenance.

8

# Table of Contents

## 1

### Before Operating the Transceiver

Connecting the power.....	6
Connecting the microphone .....	6
Connecting an antenna.....	6
Connections for base station use .....	7
Connections for mobile use.....	7
Specifications .....	8

## 2

### Panel Description

1. Front panel.....	9
2. Display .....	12
3. Rear panel .....	14
4. Microphone .....	14

## 3

### Basic Operation

1. Receiving.....	15
2. Transmitting.....	17
3. Operating modes .....	18

## 4

### Advanced Functions

1. Memory Channels .....	19
Calling up a memory channel .....	20
Programming a memory channel .....	21
Clearing a memory channel.....	22
Transferring a memory to VFO .....	22
2. Call Channel .....	23
Calling up a call channel .....	23
Changing the call channel's frequency .....	23
3. Channel Scope.....	24
VFO channel scope .....	25
Memory channel scope .....	26
Channel scope with a DTMF equipped microphone .....	27

Simultaneous channel scope on VHF and UHF .....	27
Operating during the channels scope .....	28
4. Scans .....	29
Setting scan resume conditions .....	29
Band scan .....	29
Programmed scan .....	30
Memory scan .....	30
5. Priority Watch .....	31
Priority watch.....	31
6. Other Functions.....	32
Simultaneous receive on the same band.....	32
Separating the transmit and operating bands.....	33
Single band receive .....	34
Duplex operation (Shift, split settings) .....	35
Changing tuning steps .....	36
Reverse .....	37
Setting the tone (CTCSS) encoder .....	37
Key lock.....	38
Bell function ON/OFF .....	38
Attenuator ON/OFF .....	39
Muting the sub band audio .....	39
Auto power off function.....	40
Transmitting a tone burst .....	40
7. Set Mode .....	41
Set mode construction .....	41
Beep tone volume.....	41
Bell audio ON/OFF .....	42
Speaker ON/OFF.....	42
Display backlighting .....	42
Time-out timer .....	42
Channel scope receive interval.....	43
Channel scope size (5 signals/11 signals).....	43
DTMF first digit delay .....	44

DTMF burst/pause interval .....	44
LITZ signal reception ON/OFF .....	44
Monitor function ON/OFF .....	45
S-meter squelch ON/OFF .....	45
8. Functions for the DR-610T only .....	46
Cross band repeater ON/OFF .....	46
AM receive .....	46
9. Reset .....	47
All reset .....	47

## 5 Selective Calling

General .....	48
1. Tone squelch .....	49
2. DSQ .....	50
Programming DSQ codes .....	50
Programming DSQ codes with a DTMF equipped microphone .....	52
Setting DSQ mode .....	53
Setting DSQ mode with a DTMF equipped microphone .....	53
Communicating in code squelch mode .....	54
Communicating in group pager mode .....	55
Communicating in private pager mode .....	56
Manual DTMF transmission .....	57
Communicating with DSQ codes through a repeater .....	57
3. Auto-dialing .....	58
Programming transmit codes into memory .....	58
Correcting a code you have entered .....	59
Confirming received codes .....	60
Auto-dial ON/OFF .....	60
Transmitting codes using auto-dialing .....	60

## 6 Remote Control Operation

1. Microphone remote control .....	61
Operating procedure for microphone remote control .....	61
Entering a frequency directly .....	63
2. External remote control .....	64
Receiving remote control commands from another transceiver .....	65

## 7 Packet Operation

General .....	66
1. 1200 bps packet operation .....	67
2. 9600 bps packet operation .....	68

## 8 Maintenance

Troubleshooting .....	69
Installing options .....	71
Tone squelch (CTCSS) unit .....	71
Memory unit .....	71
Panel separation kit .....	72
Junction box .....	74
DTMF equipped microphone .....	75

# 1

## Before Operating the Transceiver

### ● ACCESSORIES ●

Carefully unpack your transceiver and you will find the Standard Accessories included:

#### ■ Standard Accessories

1. Mobile Mounting Bracket.
2. Installation Hardware. ( 4 Black screws 4 Screws 1 Spanner )  
( 4 Sets Bolt/Nut 2 Fuse )
3. DC Power Cord.

Optional accessories are available, as listed below, at your Authorized ALINCO Dealer. We strongly recommend that you purchase the appropriate accessories to get full features and performance from you radio.

#### ■ Optional Accessories

For the details see pages 71 ~ 75

1. EJ-24U Tone Squelch Decoder Unit
2. EJ-23U Additional Memory Unit (120ch)
3. EDS-2 Front Panel Remote Cable (3m/10ft)
4. EDS-3 Front Panel Remote Cable (5m/16<sup>1</sup>/<sub>2</sub>ft)
5. EBC-8 Front Panel Bracket
6. EDS-1 Junction Box
7. EMS-12 DTMF Microphone (option for DR-610E)

### ● Connecting the Power ●

#### Connecting the microphone

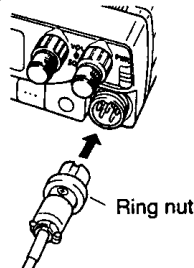

Connect the supplied microphone

- (1) Connect the microphone jack to the microphone connector. Be sure to attach the microphone securely.
- (2) Fasten the jack securely using the ring nut.

#### Connecting an antenna

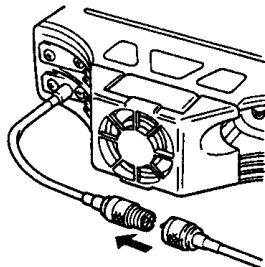

- (1) Connect the antenna to the antenna connector on the bottom left of the rear panel, making sure the coaxial cable of the antenna is aligned properly.
- (2) Secure the antenna into place with the outer ring.

#### About the antenna

The antenna is critical to good communications. Make sure that your antenna is set up properly in a suitable location.

- Use a dual band antenna (145/440 MHz)
- The transceiver's antenna impedance is 50 ohms. If the impedance of the coaxial cable and the transceiver do not match, transceiver performance will be adversely affected.
- Performance can be affected at low output power and by other electronic equipment such as televisions.
- Use a coaxial cable that is as thick and as short as possible. For long distance communications use low loss coaxial cable.

# ● Connecting the power ●

## Connections for base station use

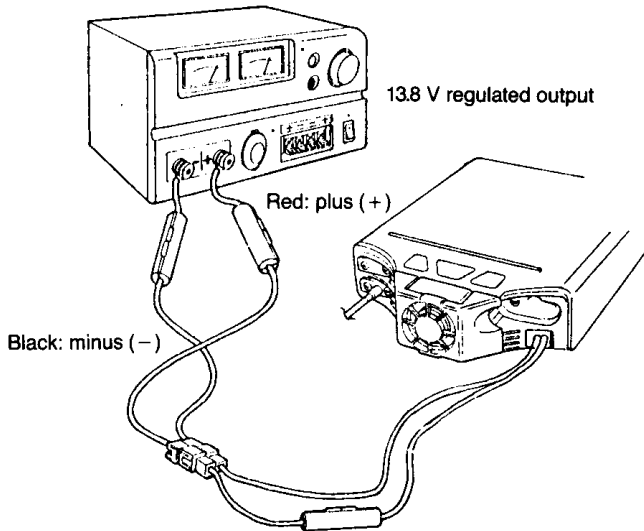

When setting up the transceiver for base station use, use a 13.8 V DC power source. Connect the power source to the red (+) terminal and the black (-) terminal of the transceiver.

### Caution

- Use the supplied DC cord only.

Regulated power supply with current capacity of continuously 12 A or more (recommended)

1

## Connections for mobile use

### 1. Location

The transceiver may be installed in any position\* in your car, where the controls and microphone are easily accessible and safe operation of the vehicle or the performance of the set will not be interfered with.

(\*Local regulation may apply)

Refer to the diagrams for installation of the Mounting Bracket:

### 2. Power Requirements

The transceiver can be operated from any regulated 12 or 13.8 V negative ground source.

For mobile use, power connections should be made directly to the battery to minimize the possible ignition noise pickup.

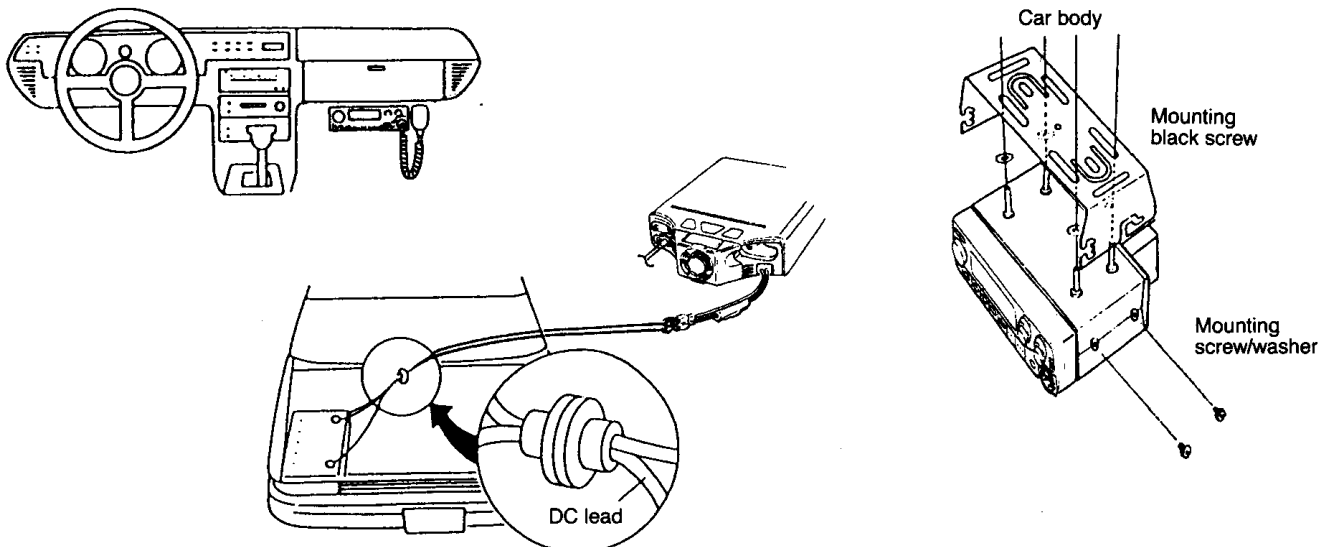

# ● SPECIFICATIONS

1

Model		DR-610T	DR-610E
<b>Spec.</b>			
<b>General</b>			
Freq. range	VHF	Tx: 144.000 ~ 147.995 MHz / Rx: 108.000 ~ 173.995 MHz	144.000 ~ 145.995 MHz
	UHF	Tx: 438.000 ~ 449.995 MHz / Rx: 420.000 ~ 470.000 MHz	430.000 ~ 439.995 MHz
Modulation		F2E (F2), F3E (FM), (Rx only: A3E (AM))	F2, F3 (FM)
Ant. impedance		50Ω	
Supply voltage		13.8 VDC	
Ground		Negative	
Current consumption	VHF Tx	50W: 11.5A max.	
	UHF Tx	35W: 10.0A max.	
	Rx	1.2A max.	
Freq. stability		± 10 ppm max.	
Dimensions		140 (W) × 40 (H) × 162 (D) mm	
Weight		1.1 kg	
<b>Transmitter</b>			
Output	VHF	H: 50W, M: 10W, L: approx. 5W	
	UHF	H: 35W, M: 10W, L: approx. 5W	
Modulator		Reactance mod.	
Spurious		- 60dB max.	
Max. deviation		± 5 kHz	
Mod. distortion (@60% mod.)		3% max (300 ~ 3000 Hz)	
Mic. impedance		2 kΩ	
<b>Receiver</b>			
Rx system		Double superhet.	
I.F.		VHF ... 45.1 MHz / 455 kHz UHF ... 58.3 MHz / 455 kHz	
Sens. (12dB SINAD)		Mainband - 16dB $\mu$ (0.16 $\mu$ V) or less / Subband - 13dB $\mu$ (0.22 $\mu$ V) or less	
Selectivity		- 6dB: 12 kHz min., - 60dB: 28 kHz max.	
Squelch sens.		- 20dB $\mu$ (0.1 $\mu$ V) or less	
AF output (@5% distortion)		2W or more (8Ω load)	
AF output impedance		8Ω	

\*Specifications are subject to change without notice or obligation.  
\*Specifications guaranteed in the amateur band only.



# 2

# Panel Description

## 1. Front panel

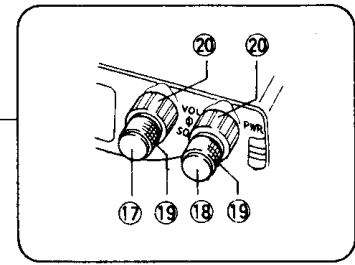
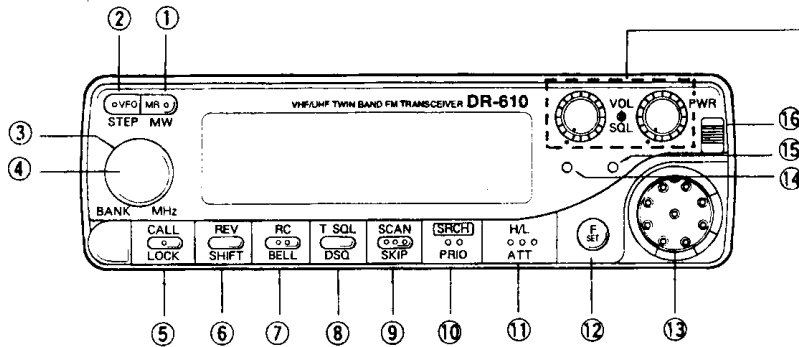

 The CT indicator shows the operating band.

2

### • Primary functions

No.	Name	Function	Page
1	<b>MR / MW</b>	Push to select memory mode. In memory mode, toggles the memory bank.	18
2	<b>VFO / STEP</b>	Push to select VFO mode. In VFO mode, toggles between VFO A and VFO B.	18
3	<b>Dial</b>	Rotate this knob to change frequency, memory channel and other settings.	16
4	<b>MHz / BANK</b>	Press this knob to change the frequency in 1 MHz steps.	16
5	<b>CALL / LOCK</b>	Calls up the call channel. When pushed again, returns to the previous indication.	18
6	<b>REV / SHIFT</b>	During duplex operation, exchanges the transmit and receive frequencies.	37
7	<b>RC / BELL</b>	Allows you to use external remote control.	61
8	<b>T SQL / DSQ</b>	Tone setting and tone frequency setting.	37-49
9	<b>SCAN / SKIP</b>	Starts scanning in VFO and memory modes. Also pauses scanning.	29
10	<b>SRCH / PRIO</b>	Starts channel scope operation in VFO and memory modes. During scope operation push to restart.	24
11	<b>H/L / ATT</b>	Each push changes the output power in the order H, M, L.	17
12	<b>F (SET)</b>	Allows you to access the secondary functions of switches. When pushed for longer than 3 sec., enters set mode.	—
13	<b>Microphone connector</b>	Connects the supplied microphone.	6
14	<b>VHF TX LED</b>	Lights while transmitting ( <b>PTT</b> appears) on the VHF band. Green: receiving. Red: transmitting.	16
15	<b>UHF TX LED</b>	Lights while transmitting ( <b>PTT</b> appears) on the UHF band.	16
16	<b>PWR</b>	Turns power ON/OFF.	15

No.	Name	Function	Page
17	VHF	When operating on the UHF band, push this switch to select the VHF band for transmit and operation. The <b>PTT</b> and CT indicators on the VHF side appear. When operating on the VHF band, push this switch to toggle VFO bands.	16 • 32
18	UHF	When operating on the VHF band, push this switch to select the UHF band for transmit and operation. The <b>PTT</b> and CT indicators on the UHF side appear. When operating on the UHF band, push this switch to toggle VFO bands.	16 • 32
19	VOL	These knobs adjust the volume for each band.	15
20	SQL	These knobs adjust the squelch for each band.	15

### • Secondary functions (while **F** appears after pushing **F**)

No.	Name	Function	Page
1	MR / MW	Used for writing, clearing memory channels, etc.	19
2	VFO / STEP	Toggles the channel step setting.	36
3	Dial	Changes the memory channel number (frequency indication does not change).	21
4	MHZ / BANK	Toggles the memory bank	21
5	CALL / LOCK	Toggles the key lock function ON/OFF.	38
6	REV / SHIFT	Sets the shift (offset frequency) for duplex operation.	35
7	RC / BELL	Toggles the bell function ON/OFF.	41
8	TSQ / DSQ	Sets DSQ mode ( <b>G P DSQ</b> ).	53
9	SCAN / SKIP	In memory mode, toggle skip channels ON/OFF.	30
10	SRCH / PRIO	Starts priority watch. During channel scope operation, pauses channel scope.	31
11	H/L / ATT	Toggles the attenuator ON/OFF.	39
12	<b>F</b>	While <b>F</b> appears push <b>F</b> to return to primary switch action.	—
17	VHF	During operation on the UHF band, push this key to switch operation only (CT) to the VHF band.	33
18	UHF	During operation on the VHF band, push this key to switch operation only (CT) to the UHF band.	33

#### Note

- When **F** is pushed for more than 3 sec. the transceiver enters set mode (page 41).
- During tuning step (No.2), shift (No.6) or DSQ mode (No.8) setting, **F** flashes. While **F** appears, other than for set-mode, if no switch is pushed or no operation is performed for 5 sec., **F** disappears and any operation being performed is cancelled.

#### Order of operation

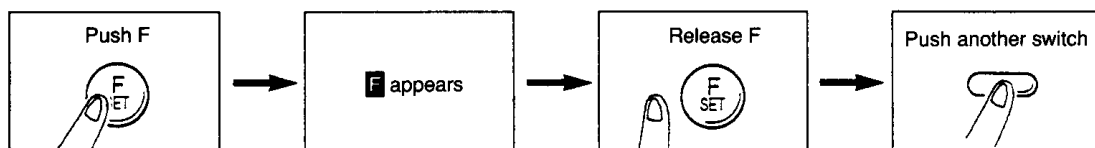

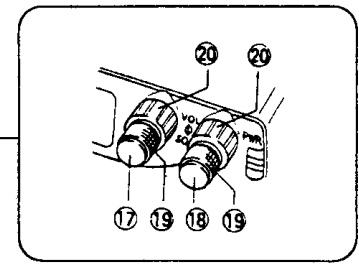
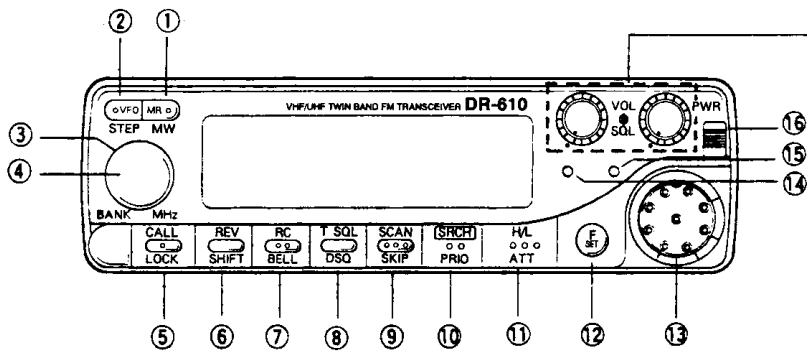

During operation, the CT indicator shows the band selected for operation.

● Secondary functions (while pushing **F**)

No.	Name	Function	Page
1	MR / MW	In memory mode, transfers memory data to VFO mode. (Memory shift)	22
2	VFO / STEP	Toggles AM/FM operation (DR-610T only).	46
7	RC / BELL	Used for setting 9600 bps packet operation.	68
8	TSQL / DSQ	Sets DSQ codes.	50
9	SCAN / SKIP	Toggles the scan type (busy/timer scan).	29
11	H/L / ATT	Push to mute ( <b>PTT</b> does not appear) the sub band's audio (sub mute).	39
17	VHF	Turns the cross band repeater function ON (DR-610T only).	46
18	UHF	Turns the cross band repeater function OFF (DR-610T only).	46

**Note** ● During DSQ code (No.8) setting **F** flashes.  
If no switches are pushed or no operation is performed within 5 sec., **F** disappears and the setting is cancelled.

Order of operation

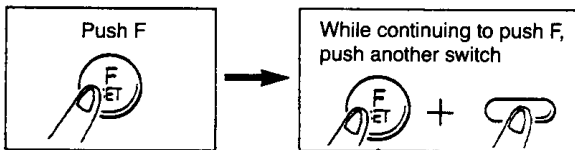

● While pressing the following key, turn power ON

No.	Name	Function	Page
4	MHz / BANK	Toggles auto power off (APO) ON and OFF.	40
12	F	Resets all transceiver data.	47
17	VHF	All UHF indications disappear and VHF only operation is selected.	34
18	UHF	All VHF indications disappear and UHF only operation is selected.	34

## 2. Display

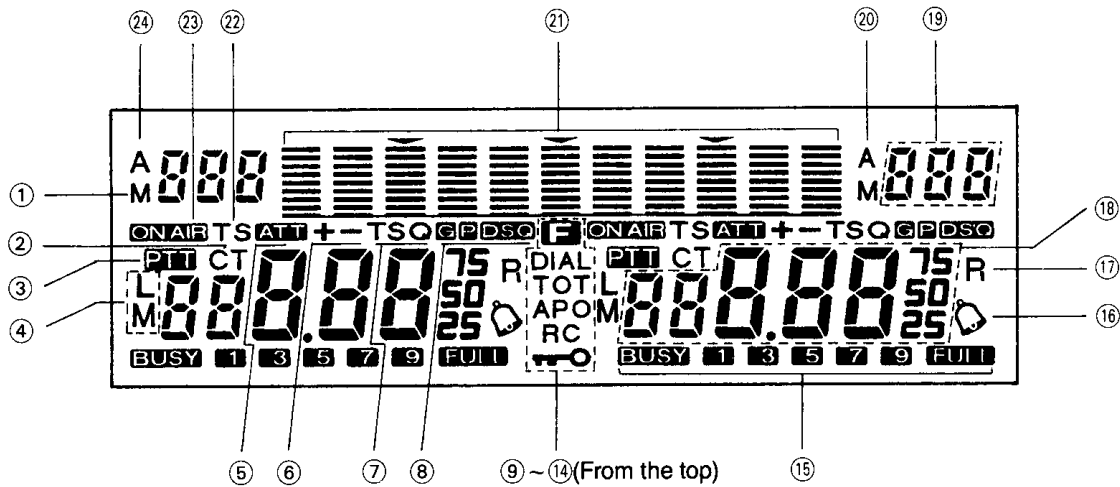

- |  |   |
|--|---|
| <p>① <b>M</b>      Appears during memory mode. (page 18)</p> <p>② <b>CT</b>      Indicates the operating band, VHF or UHF. Pushing the PTT affects the selected band only. (page 16 ~ 17)</p> <p>③ <b>PTT</b>      Appears for the band selected as the transmit band. When pushing PTT, transmit occurs for the selected band only. (page 16 ~ 17)</p> <p>④ <b>L</b>      Output power indicator<br/> <b>M</b>      L low power<br/>                   M mid power<br/>                   no indicator appears for high power (page 17)</p> <p>⑤ <b>ATT</b>      Appears when the attenuator is ON. (page 39)</p> <p>⑥ <b>+ -</b>      Appear when plus or minus shift offsets have been set. During split frequency operation both indicators appear. (page 35)</p> <p>⑦ <b>TSQ</b>      Appears when tone encoder, tone squelch operation is set. (page 37, 49)</p> <p>⑧ <b>GPDSQ</b>    Appears when DSQ (code squelch, pager) operation is set. (page 53)</p> | <p>⑨ <b>F</b>      Appears for 5 sec. after the <b>F</b> key is pushed. After releasing <b>F</b>, push another key to activate a function. When a function is completed or when no key or operation is performed for 5 sec., F disappears. Flashes during set mode and setting operations.</p> <p>⑩ <b>DIAL</b>      Appears when the auto dial function is ON. (page 58) For DR-610E this function is available when an optional DTMF microphone is connected.</p> <p>⑪ <b>TOT</b>      Appears when the transmit time-out timer is set. (page 42) When this indicator appears, transmit is inhibited after a specified time of continuous transmitting.</p> <p>⑫ <b>APO</b>      Appears when the auto power OFF function is set. (page 40)</p> <p>⑬ <b>RC</b>      Flashes when entering microphone commands. (page 61) Appears but does not flash to indicate external remote control is possible.</p> <p>⑭ <b>Key Lock</b>    Appears when the key lock function is set. (page 38)</p> |
|--|---|

⑮ **BUSY** **1** **3** **5** **7** **9** **FULL**

Indicates the transmit and receive signal strength levels.

Receive (page 15)

Transmit (page 17)

Also, when the S-meter squelch is set, indicates the level needed to unmute the squelch. (page 45)

During sub band audio mute **FULL** only flashes. (page 39)

⑯ 

Appears when the bell function is ON. Flashes when a signal is received. (page 38/42)

⑰ **R**

P ... appears during priority watch operation. (page 31)

R ... appears while receiving in reverse mode. (page 37)

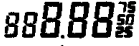
⑱ 

Indicates receive frequency, transmit frequency, shift (offset) frequency, tone frequency, set mode conditions.

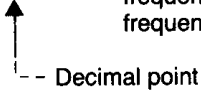

- Transmit/receive, shift (offset) frequency 1 MHz
- Tuning step 1 kHz
- Tone frequency 1 Hz
- Flashes during scanning. (page 34)
- Disappears for a skip memory. (page 30)

⑲ **BBB**

Indicates memory channel in memory mode; indicates VFO A or B in VFO mode. (page 18)

⑳ **A**

Flashes during 9600 bps packet operation (doesn't appear during 1200 bps packet operation). (page 68)

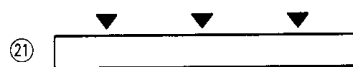

Channel scope (page 24)  
During operation indicates the receive signal level of each signal.

㉑ **TS**

Appears during timer scan. Disappears during busy scan. (page 29)

㉒ **ON AIR** Appears during transmit. (page 17)

㉓ **A** Appears during AM receive mode (DR-610T).

### 3. Rear panel

2

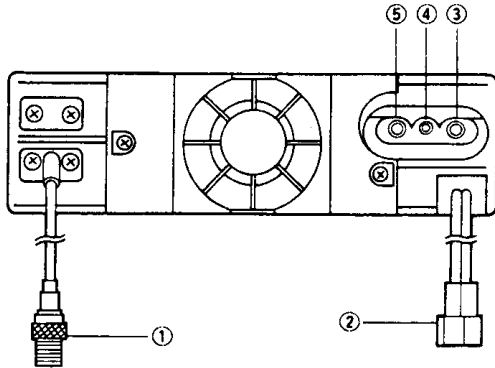

- ① Antenna connector  
Connects a 50 ohm antenna.
- ② Power connector  
Connect the supplied power cord here. Red indicates positive (+) and black indicates negative (-). Make sure the cord is connected properly. Use 13.8 V DC power only.
- ③ PTT input terminal for 9600 bps packet operation  
This terminal is used for PTT input when using packet communication at 9600 bps mode. (page 68)
- ④ DATA (EXT) terminal  
Use 3 and 5 when operating packet. (page 68)
- ⑤ External speaker terminal  
Connect an external speaker here.

### 4. Remote control microphone

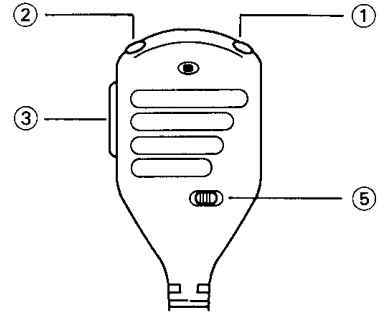

EMS-5A

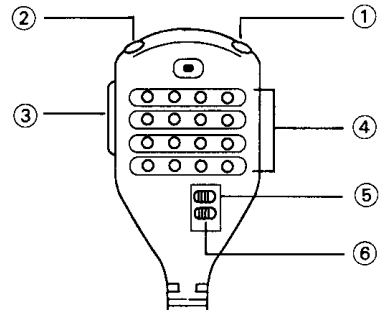

EMS-12

- ① ② UP/DOWN key  
Increments/decrements frequency, memory channel and other items. Push and hold to change an item continuously. When pushed for longer than 0.5 sec. and released before 3 sec. scan starts.
- ③ PTT switch  
While pushing this switch, transmits on the band indicated with **PTT**. Push this switch to exit any setting in progress.
- ④ DTMF key  
Used for remote control commands and to enter frequencies. Also allows you to manually send DTMF codes.
- ⑤ UP/DOWN lock switch  
When this switch is ON, the microphone UP/DOWN keys do not function.
- ⑥ DTMF/REMOTE switch  
Set to DTMF when you don't want to operate remote control functions. So that DTMF keys do not function except during transmit to send DTMF codes manually.

Microphone pin assignments

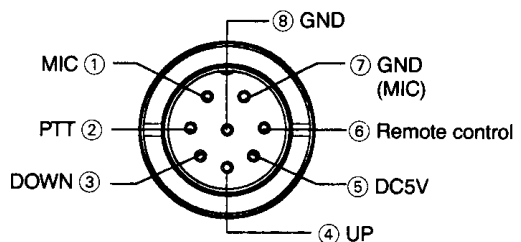

# 3

# Basic operation

## 1. Receiving

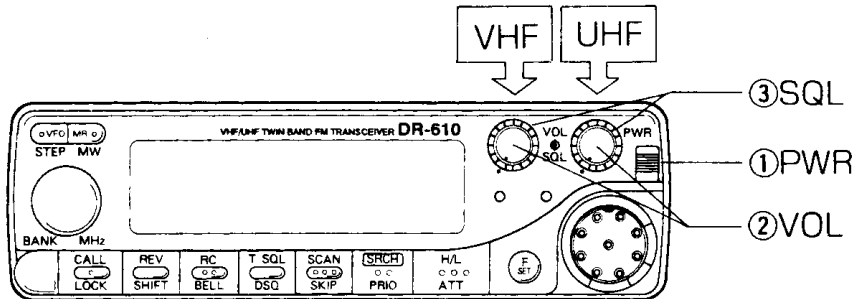

■ Push PWR again to turn power OFF.

■ VHF and UHF have independent VOL and SQL controls  
 VHF-left side  
 UHF-right side

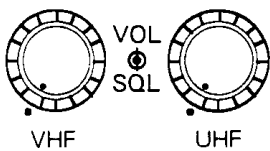

**1. Turning power ON**

Push **PWR**.

**2. Adjust the volume**

Rotate **VOL**.

Clockwise rotation increases volume.  
 Counterclockwise rotation decreases volume.

**3. Adjusting the squelch**

Rotate **SQL**.

Rotate SQL counterclockwise until noise is emitted. Then, slowly rotate SQL clockwise to the point where the noise is just muted. When SQL is rotated too far clockwise weak signals will not be heard.

■ An S-meter squelch function is also available. (page 45)

! When receiving a signal, the relative signal strength is indicated by the receiving bands S-meter.

**BUSY** 1 3 5 7 9 **FULL** (Maximum)

This transceiver has a transmit band and an operating band.

**Transmit band**

When pushing PTT transmit occurs on this band. The **PTT** indicator appears and the TX LED lights green.

**Operating band**

This band is for operation of all functions except for transmit. The CT indicator appears for this band.

The transmit and operating bands can be set separately. (page 33)

■ The microphone UP/DOWN keys operate continuously when pushed and held. When pushed for longer than 0.5 sec. and released in less than 3 sec. scan starts. (page 29)

■ Receive frequency range (MHz)

Model	VHF	UHF
T	108.000 ~ 137.995 138.000 ~ 173.995	420.000 ~ 470.000
E	144.000 ~ 145.995	430.000 ~ 439.995

Refer to page 46 for DR-610T receive on 118 MHz.

■ During setting, when no operation is performed for 5 sec., the setting is cancelled and the previous indication reappears.

**4. Band selection**

Push **VHF** or **UHF** to select a band.

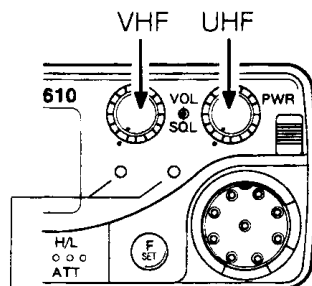

The LED lights green on the **PTT** side.

**PTT** and CT appear for the selected band.

**PTT** and CT are selected to the VHF band.

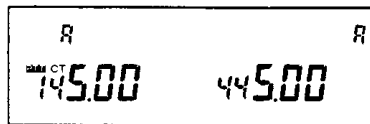

UHF key ↓      ↑ VHF key

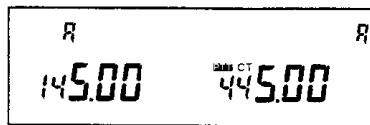

**PTT** and CT are selected to the UHF band.

**5. Setting a frequency**

Rotate **DIAL** or push the microphone **UP/DOWN** keys.

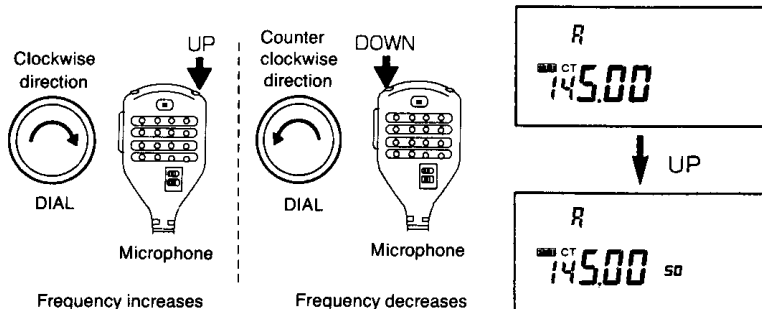

The frequency changes according to the tuning step for the CT band. (5 kHz for the DR-610T and 12.5 kHz for the DR-610E)

**Changing the frequency in 1 MHz steps**

Push **MHz** to select MHz mode.

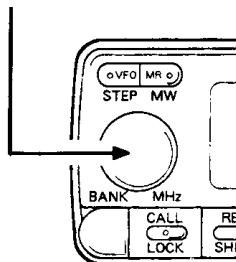

In MHz mode indicators below 100 kHz disappear and DIAL and the UP/DOWN keys change the frequency in 1 MHz steps.

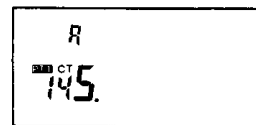

**Exit** Push **MHz**, **PTT** or **F** key. Indicators below 100 kHz reappear.



## 2. Transmitting

■ When receiving and transmitting on the same frequency and same band, skip 1 and 2.

■ Transmit frequency range (MHz)

Model	VHF	UHF
T	144.000 ~ 147.995	438.000 ~ 449.995
E	144.000 ~ 145.995	430.000 ~ 439.995

■ Default setting from the factory is High power (no indicator appears).

### 1. Select a band

Push **VHF** or **UHF** to select a band as for receiving. (page 15)

### 2. Setting a transmit frequency

Set a frequency in the same manner as for receive. (page 15)

### 3. Select an output power

Push **H/L**.

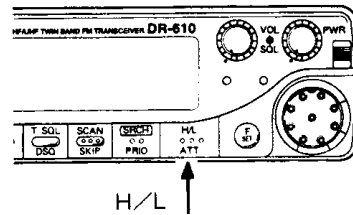

Each push of the key changes the selected output power.

High → Mid → Low  
(No indication) (M appears) (L appears)

Indications to the left of the frequency change.

M 145.00

#### Note

- When transmitting do not interfere with other stations.
- When attempting to transmit outside the allowed range, OFF appears and transmit is inhibited.

■ During transmit the transmit power is indicated as below.

H : 1 3 5 7 9 FULL

M : 1 3 5 7

L : 1 3

### 4. Transmitting

Push **PTT** on the microphone.

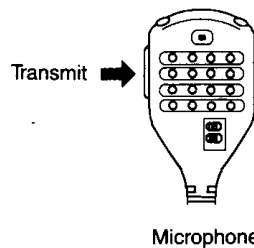

Microphone

When **ON AIR** appears and the TX LED lights red, speak into the microphone.

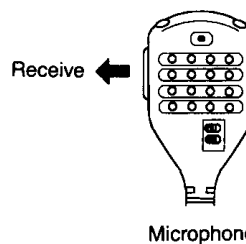

Microphone

Release **PTT** to return to receive. **ON AIR** disappears and the LED lights green.

# 3. Operating modes

## (1) VFO mode

The default mode when shipped from the factory is VFO mode. In VFO mode, rotating the DIAL or pushing the UP/DOWN keys on the microphone changes the frequency in set steps.

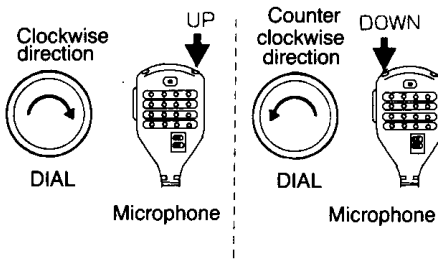

3

### 1. Selecting VFO mode from another mode

Push VFO.

VFO mode has VFO-A and VFO-B. While in VFO mode, push VFO to toggle between the A and B.

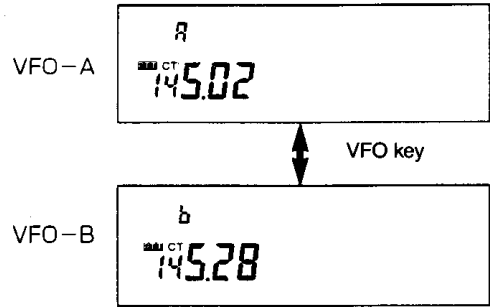
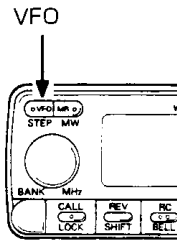

## (2) Memory mode

Memory mode is used to call up programmed frequencies. In memory mode, rotating the DIAL or pushing the UP/DOWN keys on the microphone change the memory number.

Refer to page 19 for details concerning memory mode.

### 2. Selecting memory mode from another mode

Push MR.

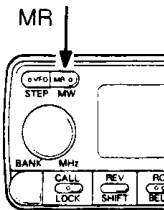

M and the memory channel number appear.

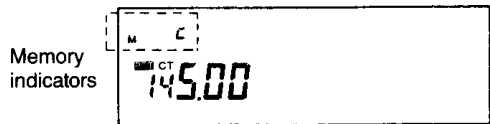

## (3) CALL mode

Use CALL mode to standby on the call channel or call up the call channel.

Refer to page 23 for details concerning CALL mode.

### 3. Selecting CALL mode from another mode

Push CALL.

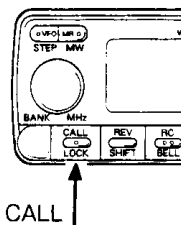

C appears (M disappears)

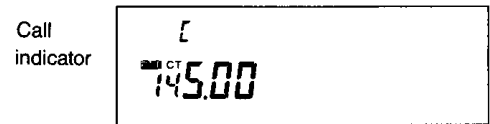

The diagram at right shows the relationship between VFO, memory and CALL mode.

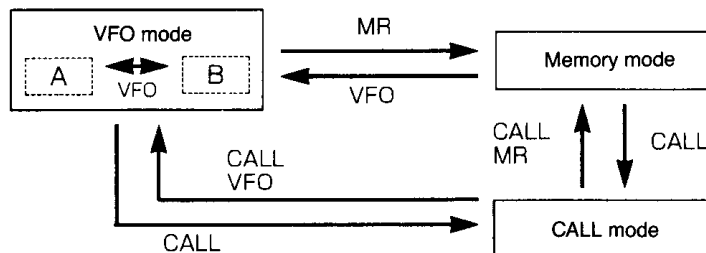

# 4

# Advanced Functions

## 1. Memory channels

This transceiver has a total of 120 memory channels plus split channels, call channels and programmed scan edge memory channels. This large number of memory channels provides tremendous operating versatility. For operating convenience they are divided into 5 separate banks.

Memory bank arrangement

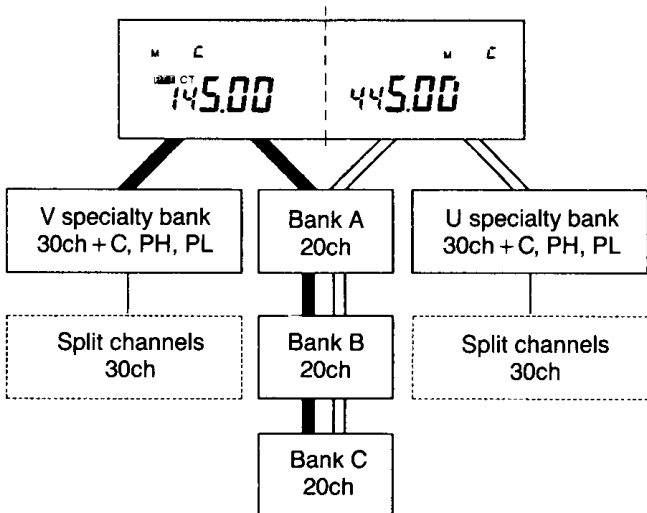

**V specialty bank** memory channels can be programmed with VHF side information only. Each channel can hold split information. However, split channels cannot be called up while receiving.

**U specialty bank** memory channels can be programmed with UHF side information only. Like V bank channels, these channels also can hold split information.

**Bank A, B and C** memory channels can be used for both VHF or UHF side. The same memory channel can be recalled for both VHF and UHF.

Memory unit (EJ-23U)

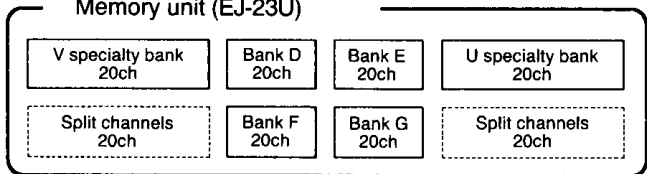

When installing the optional memory unit (EJ-23U), memory capacity increases as in the table at left.

Factory default memory contents

	Channel	Contents	Initial setting	Channel No.
V specialty	0~29	Normal memory channels	None (NULL)	C
	C	Call channel	145.00MHz	
	PH	Programmed scan upper limit	145.00MHz	
	PL	Programmed scan lower limit	145.00MHz	
U specialty	0~29	Normal memory channels	None (NULL)	C
	C	Call channel	DR-610T: 445.00MHz DR-610E: 433.00MHz	
	PH	Programmed scan upper limit	DR-610T: 445.00MHz DR-610E: 433.00MHz	
	PL	Programmed scan lower limit	DR-610T: 445.00MHz DR-610E: 433.00MHz	
A·B·C	0~19	Normal memory channels	None (NULL) (Indications are VFO values)	1 (M flashes)

The following information can be programmed into memory channels

- ① Receive and transmit frequencies
- ② Tuning step
- ③ Shift and split settings
- ④ Tone settings and tone frequency
- ⑤ DSQ settings

# Calling up a memory channel

You must be in memory mode to call up a memory channel.

- The default memory mode setting from the factory is made up of the VHF and UHF specialty bank C channels.

## 1. Selecting memory mode

Push **MR**.

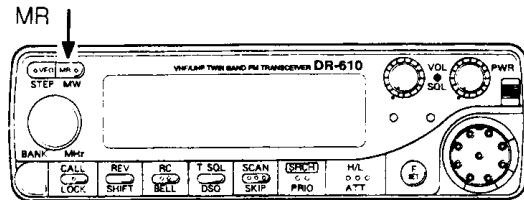

M and the memory number appears.

(Ex.) The display for the factory default V specialty bank.

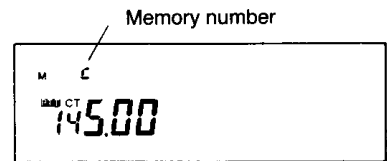

4

- The factory default settings for Banks A, B and C are empty and when selected the display below appears.

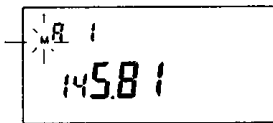

M flashes  
VFO data is indicated

In this case, memory numbers cannot be selected. When at least 1 channel is programmed with information, its memory indication appears and M stops flashing.

## 2. Selecting a bank

In memory mode, push **MR**.

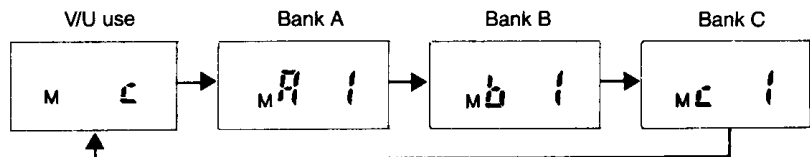

Each bank displays the most recently selected memory.

## 3. Selecting a memory channel

Rotate **DIAL** or push the **UP/DOWN** keys on the microphone.

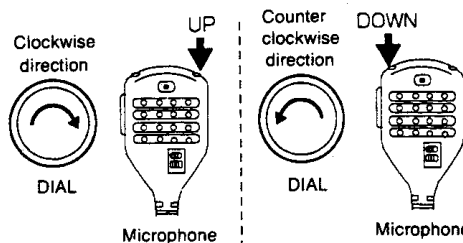

Memory channel increases

Memory channel decreases

V/U specialty bank

Bank A/B/C

Within in each bank, memory channels are indicated in sequence.

# Programming a memory channel

Before a memory channel can be used, it must be programmed with information. The factory default settings from the factory leave all channels blank except for specialty bank channels C, PH and PL.

■ When no operation is performed for 5 sec. **F** disappears and the selected memory cannot be used.

When you want to program split information into a memory you must use one of the V or U specialty bank channels.

Program scan edge frequencies into specialty bank channels PH and PL.

- PH and PL must have the same band frequencies and PH must be higher than PL.

### Caution

- When programming information into memory channel in which M continuously appears, the previous data is cleared.
- When a memory channel in bank A to C is chosen for the non-operating band, programming from the operating band cannot be done.

## 1. Setting a frequency

Select a frequency and other information, if required, in VFO mode.

## 2. Select a memory to program

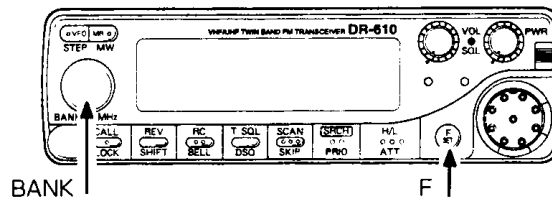

- 1 Push **F**.  
**F** appears.

M and the memory number appear. The frequency remains the same as that set in VFO mode.

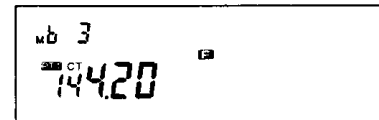

- 2 Push **BANK** to select the desired bank. Banks are selected in the same order as illustrated on page 20.
- 3 Rotate **DIAL** or push the **UP/DOWN** keys on the microphone to select the memory channel to be programmed. All channels in the bank, including those not yet programmed, can be selected.

**M** appears  
Previously programmed channel

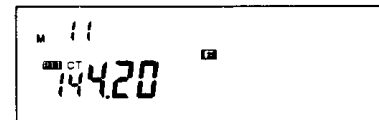

**M** flashes  
Empty channel

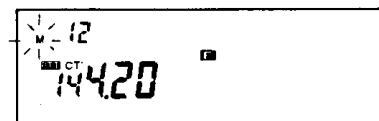

## 3. Program the memory

While **F** appears, push **MW**.

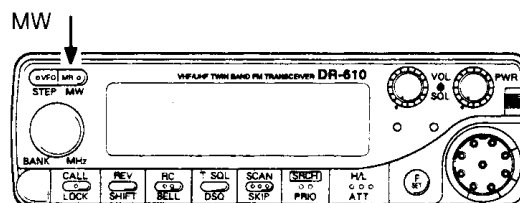

A completion beep sounds and the memory is programmed.

## Clearing a memory channel

### Note

- V/U specialty bank memories C, PH and PL cannot be erased.
- When a memory channel in banks A to C in the non-operating band is chosen, it cannot be cleared from the operating band side.
- After erasing a memory, when changing channels or changing modes, the erased channel is no longer indicated.

### 1. Select a memory channel

Choose a memory to erase while in memory mode. (page 20)

### 2. Erasing the information

- ① Push **F**.  
**F** appears.
- ② Push **MW**.

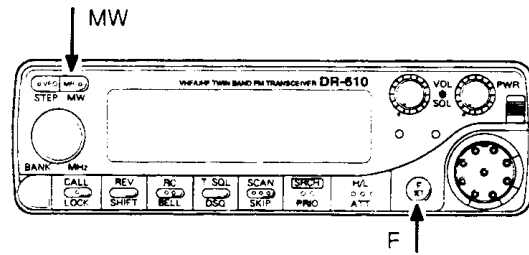

A completion beep sounds and the memory is erased. Frequency indication remains the same and M flashes. Repeating the above operation restores the information and M stops flashing.

## 4

## Transferring a memory to VFO (memory shift)

### Note

- When the frequency in the selected memory is in a different band from the present VFO, memory shift cannot be performed.

In memory mode, while pushing **F** push **MR**.

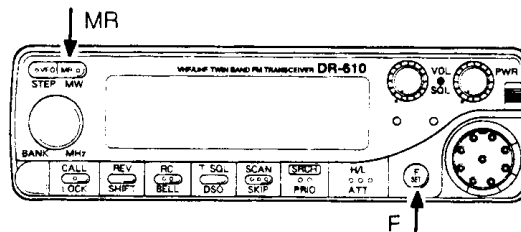

The memory information is copied to VFO and VFO mode is selected.

## 2. Call channel

The call channel is used to store a most-often-used frequency for quick and easy recall in CALL mode. VHF and UHF bands each have 1 call channel which is stored in memory C in their respective V/U specialty banks. The same data can be programmed into call channels as regular memory channels.

### Calling up a call channel

■ Factory default settings for the call channels.

Model	VHF	UHF
DR-610T	145.000	445.000
DR-610E	145.000	433.000

Push **CALL**.

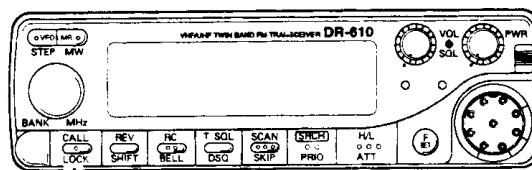

CALL

C appears and CALL mode is selected.

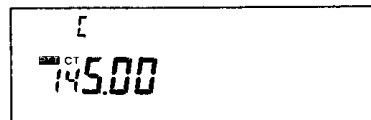

Push **CALL** again to return to the previously selected mode (VFO or memory).

4

### Changing the call channel's frequency

The frequency cannot be changed while in CALL mode. When you want to change the call channel frequency, overwrite channel C.

#### 1. Set a frequency

Set a new frequency for the call channel in VFO mode. Set other information, if desired.

#### 2. Program channel C (page 21)

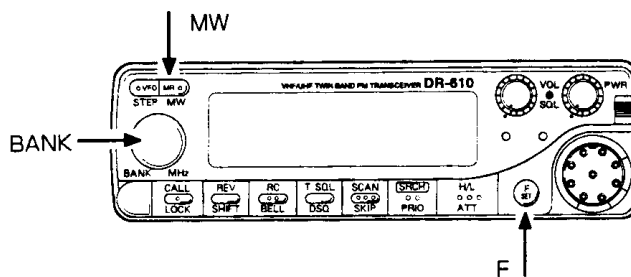

- ① Push **F** to bring up the **F** indicator.
- ② Push **BANK** to select the V or U specialty bank.
- ③ Rotate **DIAL** or push the **UP/DOWN** keys on the microphone to select channel C.
- ④ While **F** appears, push **MW**.
- ⑤ Push **CALL** to indicate the new call channel frequency.

# 3. Channel Scope

The Channel Scope function allows you to monitor adjacent channel conditions and displays their signal strength in 5 levels (0~4). During the Channel Scope operation you can check channel usage on several channels at a glance.

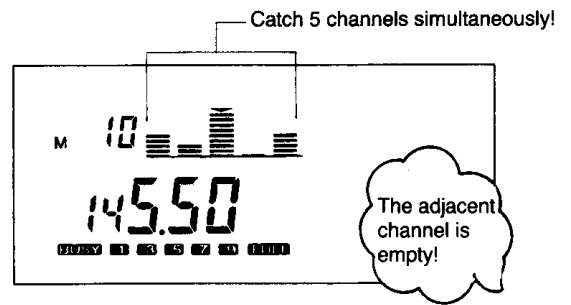

## • Channel Scope types

**VFO Channel Scope** From the center receive frequency, in tuning step increments, signal levels are measured and indicated.

**Memory Channel Scope** Signal levels are measured and indicated for programmed memory channels on either side of the indicated memory channel.

## • Channel Scope overview

4

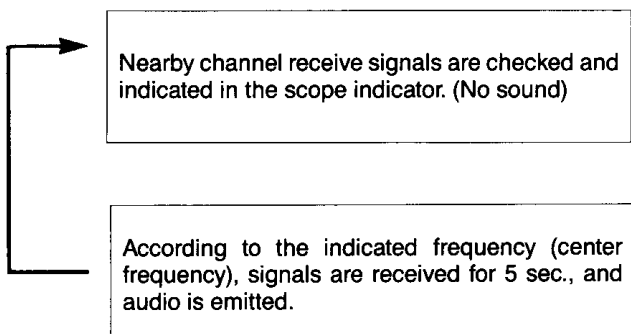

- When no signal is present on the center frequency, each signal in the scope indication is measured again and displayed.
- In order to check adjacent signals, the center frequency audio is cut once every 5 sec.
- When you don't want audio to be cut... choose single band operation in VFO mode (page 34). During channel scope operation, the center channel's receive audio is not cut in this case. (Not applicable for 118 MHz band channel scope.)

## • Center channel receive interval

The factory default setting for the center channel receive interval is 5 sec., however, this can be changed in set mode. (page 43)

5 sec. mode/3 sec. mode/0 sec. mode/single start mode

## • Size (Scope Range)

The factory default setting for the number of channels checked by the channel scope function is 5, however, this can be increased to 11 signals in set mode. (page 43)

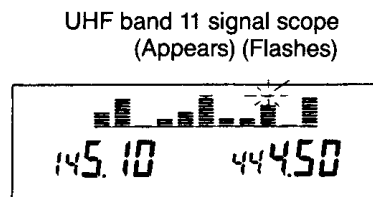
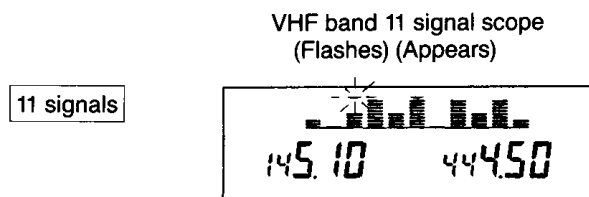
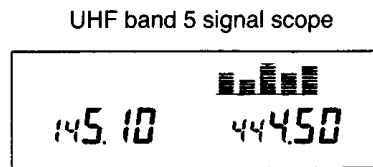
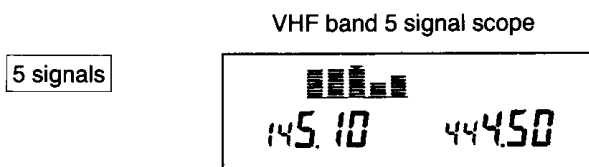



# VFO Channel Scope

■ The default setting from the factory for channel scope operation is 5 signals with a 5 second interval. Also, the interval and size can be set separately for both VHF and UHF.

■ When turning power OFF during the Channel Scope operation, channel scope receive is resumed the next time power is turned ON.

**Preparation** Set the desired center channel receive interval and the Channel Scope size in set mode. (page 43)

**Start** Push **SRCH** in VFO mode.

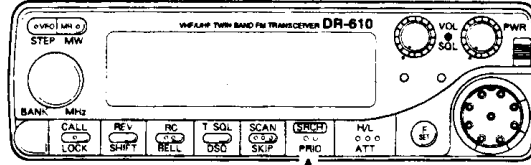

SRCH

During channel scope operation, the two signals levels (as determined by the set tuning step) above and below the center channel are indicated every 5 sec. (5 signal/5 sec. operation)

**Stop** Push **F**, then push **SRCH**. Or, push the band key in which the Channel Scope is operating (**VHF** or **UHF** key).

## Scope level indicators

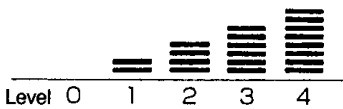

■ Scope indicators do not appear for frequencies which exceed the band limits.

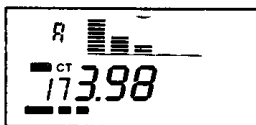

■ Push VFO to toggle between VFO A and VFO B operation.

## Understanding the Scope level indicators

(Ex.) Tuning step set to 20 kHz

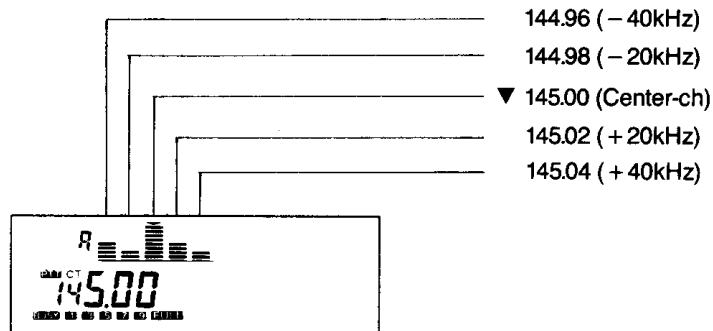

## Move the center frequency UP/DOWN

Rotate **DIAL** or push **UP/DOWN**

The center frequency is shifted one tuning step UP/DOWN and the scope indications shift one to the left or right.

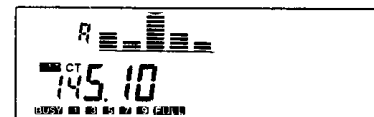

UP

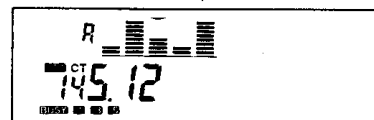

# Memory Channel Scope

Scope indicators appear for programmed memories within a bank.

- Memories not indicated during scope operation
  - Unprogrammed memories
  - Skip memories (page 30)
  - V/U specialty bank memories C, PH and PL

When selecting any of these memories, pushing SRCH will not activate channel scope.

**Preparation** Select the center channel receive interval and channel size in set mode. (page 50)

**Start** In memory mode, push **SRCH**.

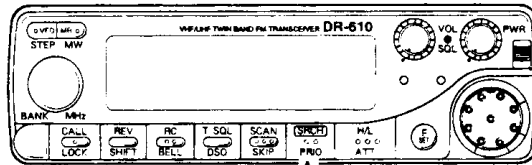

SRCH ↑

During channel scope operation, every 5 sec. the 2 signals above and below the center frequency are checked and indicated. (5 signal/5 sec. mode operation)

**Stop** Push **(F)**, then push **SRCH**. Or, push the band key in which channel scope is operating (**VHF** or **UHF** key).

4

- Scope indicators appear for the lowest to the highest memory numbers within a bank.

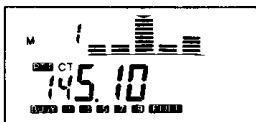

From the left M29, 0, 1, 2, 3

- When the number of memories in a bank is less than the scope size (5/11), the farthest indicators on either side of the center channel may appear blank.

- During scope operation, push **MR** to change banks. However, if the selected channel in a bank is one of the memories not operatable by the Channel Scope, the closest available bank for channel scope operation is selected.

## Understanding the scope level indicators

(Ex.) V specialty bank M7 to M10 are blank

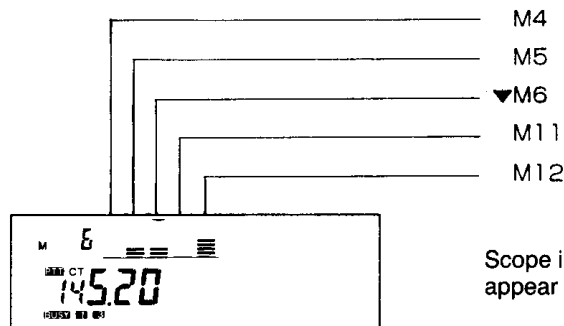

Scope indicators do not appear for M7 to M10.

## Moving the center channel UP/DOWN

Rotate **DIAL** or push the **UP/DOWN** keys on the microphone.

When the center channel is moved UP/DOWN, scope indicators are shifted to the left or right accordingly.

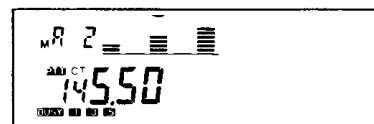

↓ UP

The center channel within the bank changes.

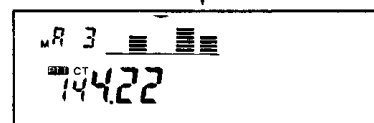

## Channel Scope with a DTMF equipped microphone

This microphone is optional for the DR-610E.

- Push **Ⓢ** **①** during scope operation to restart scope operation.

- The receive interval can be changed when scope operation is not selected.

### Note

- Rotating **DIAL** will not select other set mode items.
- This is not cancelled even if no operation is performed for 5 sec.

### 1. Starting/stopping scope

**Start** Push **Ⓢ** **①** on the **DTMF** keypad.

**Stop** Push **Ⓢ** **⑦** on the **DTMF** keypad.

### 2. Changing the center channel receive interval

① Push **Ⓢ** **⑥** on the **DTMF** keypad.  
The Channel Scope receive interval setting menu in set mode is selected. (page 43)

② Push **UP/DOWN** on the microphone to select a receive interval.

**Finish** Push **Ⓢ** or **PTT**.  
Operation proceeds according to the newly set receive interval.

## Simultaneous scope operation on VHF and UHF

Simultaneous scope operation can be selected when both bands are set for 5 signal channel scope operation.

- UHF channel scope can be started first if desired.

- Either **VFO** or memory mode can be selected in combination.

- To change the operating band while keeping the same transmit band, push **Ⓢ** followed by **UHF**.

### Note

- During simultaneous scope operation level indicators may appear with a slight delay.

### VHF band start

- ① Set the VHF band as the operating band. (Push **VHF**)
- ② Set the scope size to 5 signals in set mode. (page 43)
- ③ Push **SRCH**.  
VHF band scope starts.

### UHF start

- ① Set the UHF band as the operating band. (Push **UHF**)
- ② Set the scope size to 5 signals in set mode. (page 43)
- ③ Push **SRCH**.  
UHF band scope starts.

**Stop** Push **Ⓢ**, then push **SRCH**.  
Scope stops on the operating band side.

## Operating during the Channel Scope

- Push **PTT** to transmit.



During transmit only the ▼ appears.  
Scope resumes when transmit stops.

**Note** When operating the Channel Scope for the same band both on VHF and UHF side, scope indicators for both sides disappear.

- Push **SRCH** to start scope from the beginning.

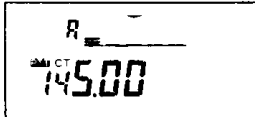

After the present scope indicators disappear, updated scope indication reappears with the left indicator.

- Push **VFO** or **MR** to change modes. Scope operation continues.

**Note** If the selected channel in memory mode is one of the memory channels that scope does not operate on (page 26), you cannot change from VFO to memory mode.

- During VFO scope operation, push (F) then push **STEP** to change the tuning steps for scope operation.
- Pushing (F) for more than 3 sec. does not select set mode.
- When power is turned OFF, scope operation resumes when power is turned back ON again.

### Notes for channel scope operation

- When operating channel scope during DSQ operation (page 50), squelch may not unmute even if a matching DTMF signal is received on the center channel.
- If 11 signal scope operation is selected for either VHF or UHF, simultaneous scope operation is not possible. In this case, SRCH does not function.
- VFO scope levels during the single band operation may differ slightly from that of dual band operation. (This is because the scope levels are measured by the sub-band VFO in this mode.)

## 4. Scans

Scanning searches for signals over a range of frequencies or programmed channels. This transceiver has 3 types of scans.

Type	
Band scan	Searches for signals over the entire band in VFO mode
Programmed scan	Searches for signals between 2 programmed edges, PH and PL, in VFO mode.
Memory scan	Searches for signals on programmed memories within a bank.

### Scan notes:

- Scan starts up or down depending on the last dial direction or key used (UP/DOWN). During scanning you can change the direction using DIAL or the UP/DOWN keys on the microphone.
- When a signal is received, scan resumes according to the set condition.
- While scanning during tone squelch operation (page 49), scan stops for received signals; when the tone matches audio can be heard.
- While scanning during DSQ operation (page 50), DSQ is temporarily cancelled; signals are received and audio is emitted even when the code does not match.

## Setting scan resume conditions

When receiving a signal, scan stops and then resumes operation depending on the set resume condition. There are 2 types of scan resume conditions.

(The factory default setting is timer scan.)

### Timer scan

Scan resumes after pausing for 5 sec. or 2 sec. after a signal disappears.

### Busy scan

Scan pauses for busy signals and resumes 2 sec. after the signal disappears.

While pushing **F**, push **SCAN**.

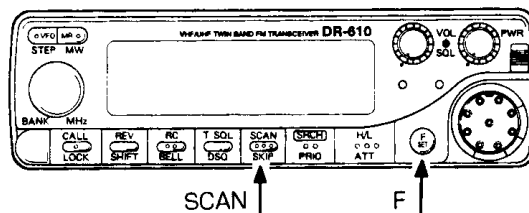

Each push toggles between timer and busy scan.

TS appears during timer scan and does not appear during busy scan.

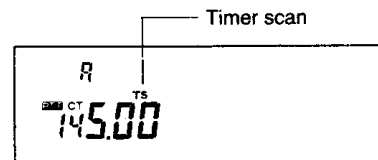

## Band scan

Scan searches for signals over the entire band range.

- When the upper limit of the band is reached (lower limit for down scan) scan returns to the lower (upper) limit.

- To stop scanning of operating band, you can also use VHF or UHF band key.

**Start** In VFO mode, push **UP/DOWN** on the microphone for 0.5 to 3 sec.

After releasing the key scan proceeds in the direction of the key pushed (UP or DOWN).

Scan proceeds according to the set tuning steps and the decimal point flashes.

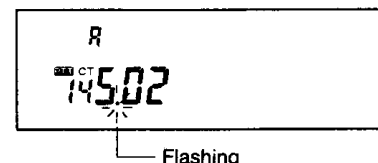

**Stop** Push **SCAN**, **PTT** or **F**.

## Programmed scan

Scan proceeds between the 2 programmed scan edges PH and PL.

### Note

- In order for programmed scan to operate, PH and PL must be in the same band and PH must be higher than PL.
- When scanning on the operating band push that band's key (VHF or UHF) to stop scanning.

**Preparation** Program the upper and lower limits for programmed scan into PH and PL of the specialty bank. (page 21)

**Start** With PH and PL set on the same band and VFO mode selected, push **SCAN**.

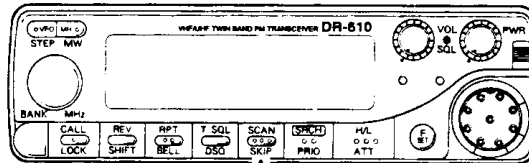

SCAN ↑

The decimal point flashes and scan proceeds in the last-selected direction.

**Stop** Push **SCAN**, **PTT** or **(F)**.

## Memory scan

Scan searches programmed memories in the selected bank.

- While scanning on the operating band, push that band's key (VHF or UHF) to stop the scan.

**Start** In memory mode, push **SCAN**.  
Or, push the **UP/DOWN** key on the microphone for 0.5 to 3 sec.

Scan searches all memories in a bank and the decimal point flashes.

**Stop** Push **SCAN**, **PTT** or **(F)**.

- Skip memories are not included in channel scope operation. When a skip memory is indicated, scanning or channel scope will not operate.

- V/U specialty bank channels C, PH and PL are not scanned even without skip settings. When memories C, PH or PL are indicated, scan will not start.

- Scan proceeds from the lowest (highest in the case of down scan) to the highest (lowest) channel number and then starts over.

## Setting non-scan channels

Push **(F)**, then push **SKIP**.

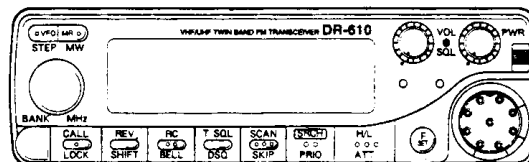

SKIP ↑

The decimal point disappears for skip channels and they are not scanned.

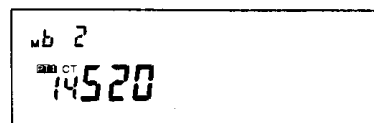

**Exit** Repeat the above operation to exit the skip setting. (Decimal point appears.)

## 5. Priority watch

Priority watch stands by on an indicated channel for 5 sec. and then monitors a specified channel for 0.5 sec. When a signal appears on the priority channel, priority watch pauses for 2 sec. There are 3 types of priority watch depending on what mode priority watch is started in (VFO, Memory or CALL).

Type	Mode before priority watch is activated	5 sec. (Indicated frequency)	0.5 sec. (Priority channel)
VFO priority	VFO mode	VFO	Memory
Memory priority	Memory mode	Memory	VFO
Call priority	CALL mode	Call	VFO

### Priority watch

- Preparation**
- ① Select a priority channel.
  - ② Select the type for 5 sec. standby.

**Start** Push **F**, then push **PRIO**.

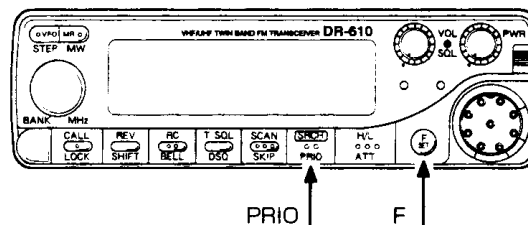

P appears and priority watch starts. Every 5 sec. the priority channel is checked for 0.5 sec. When a signal is detected on the priority channel an alarm sounds and watch pauses for 2 sec. on the priority channel.

(Ex.) VFO priority

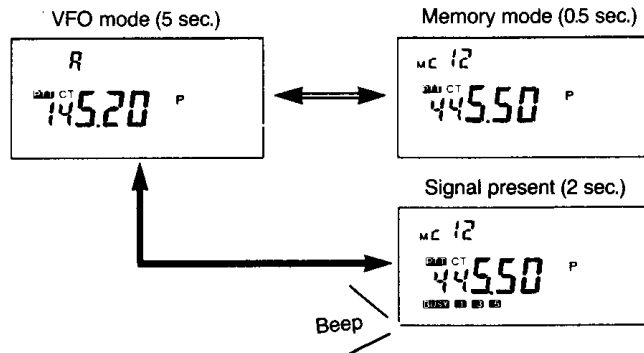

**Stop** While receiving on the indicated frequency (5 sec. side), push **F**. Or, on the priority channel (0.5 sec. side) push **PTT**.

- For memory and call priority watch, operation is identical.
- The temporarily changed contents of memory mode or call mode are restored to original once priority watch starts.
- When tone squelch or DSQ operation is selected, receive signals on the 0.5 sec. side act in the same way as for scanning. (page 34)
- When priority watch is activated on the operating band, push that band's key (VHF or UHF) to stop priority watch.



Operating on the 5 sec. side (indicated frequency) during priority watch

- Push **PTT** to transmit.
- Push **H/L** to toggle the output power.
- Push the operating band's band key (**VHF** or **UHF**) to stop the priority watch.
- Pushing the band key for the non-operating band moves **PTT** and **CT**.
- Rotate **DIAL** or push the **UP/DOWN** keys on the microphone to change the frequency or memory number.
- Other functions are not accessible.

# 6. Other Functions

## Simultaneous receive on the same band

The default setting from the factory is 145 MHz operation for the left side and 440 MHz operation for the right side with simultaneous reception of 2 signals possible. However, simultaneous receive of 2 signals on the same band is also possible. Also, transmit is possible on either side during simultaneous receive of 2 signals on the same band.

**Note**

- During 145 MHz + 145 MHz or 440 MHz + 440 MHz (bands) operation, transmit is possible on the left or right side, however, during transmit receive on the opposite side is prohibited.
- When the left side band is set for 440 MHz and the right side band is set for 145 MHz, during transmit on one side, receive is prohibited on the opposite side.

### 1. VFO mode

In VFO mode, push the band key for the operating band (VHF or UHF).

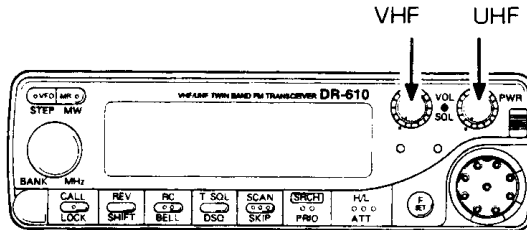

Switches between VHF band and UHF band.

Push a key to change the VFO band. VHF and UHF can both be received on the same band.

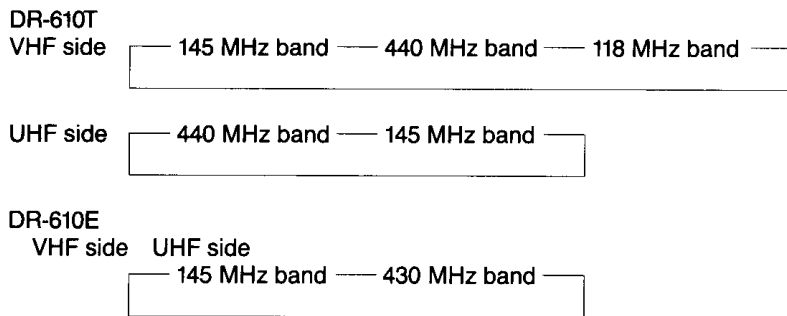

### 2. Memory mode

Call up a memory containing the same band frequency from shared banks A to C.

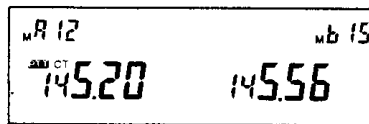

### 3. Receiving in both VFO and memory modes

Receive bands 145 MHz + 145 MHz or 440 MHz + 440 MHz, one side in VFO mode, the other side in memory mode.

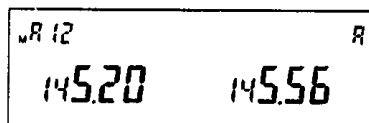

Programmed memories from banks A to C can be called up to the left or right side.



# Separating the transmit and operating bands (Sub band operation)

This transceiver has an operating band and a transmit band. When pushing the band keys (VHF or UHF) both operating and transmit bands change together. However, the operating band and transmit bands can be separated if desired.

■ During transmit, when the opposite band's beep level is set to 1, it automatically changes to 2.

■ When 145 MHz + 145 MHz or 440 + 440 MHz sub band operation is selected, if reverse operation is set, transmit is not possible.

### Note

● Normally, during any operation pushing PTT exits the setting operation. However, during sub band operation, pushing PTT transmits on the PTT side. Push (F) to exit a setting operation in this case.

## 1. Transmit VHF/Operation UHF

When the VHF side is set for transmit and operation, push (F) then push UHF.

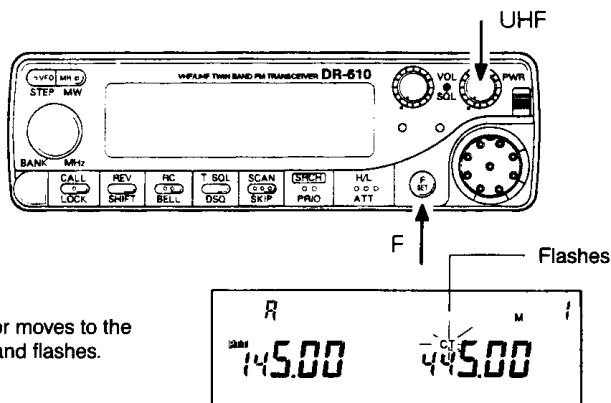

CT indicator moves to the UHF side and flashes.

During transmit on the VHF side, push UHF to move the CT indicator to the UHF side.

**Cancel-1** Push VHF.  
CT indicator returns to the VHF side and both operating and transmit take place on the VHF side.

**Cancel-2** Push (F), then push UHF.  
PTT indicator moves to the UHF side and both operating and transmit take place on the UHF side.

## 2. Transmit-UHF/Operation-VHF

When UHF is set for both transmit and operation, push (F) then push VHF.

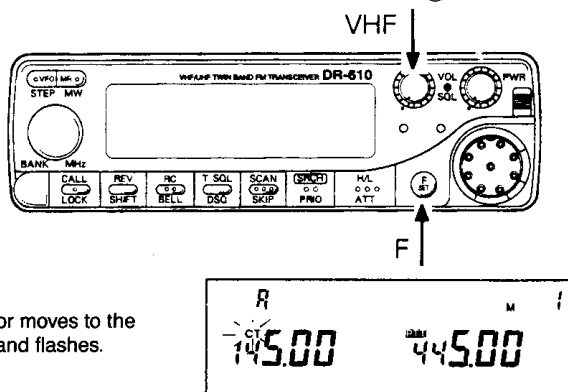

CT indicator moves to the VHF side and flashes.

During transmit on the UHF side, push VHF to move the CT indicator to the VHF side.

**Cancel-1** Push UHF.  
CT indicator returns to the UHF side and both operating and transmit take place on the UHF side.

**Cancel-2** Push (F), then push VHF.  
PTT indicator moves to the VHF side and both operating and transmit take place on the VHF side.

# Single band receive

This transceiver can receive 2 signals simultaneously. However, for simple operation one of the bands can be turned off.

- When power is turned OFF during single band operation, single band operation is still selected when power is turned back ON.
- In the single band operation, the center channel receive audio during the Channel Scope operation will not be cut. (except when in memory mode or on 118 MHz band)
- Scope levels may differ slightly when in single-band operation.

## 1. VHF single band operation

While pushing **VHF**, turn power ON.

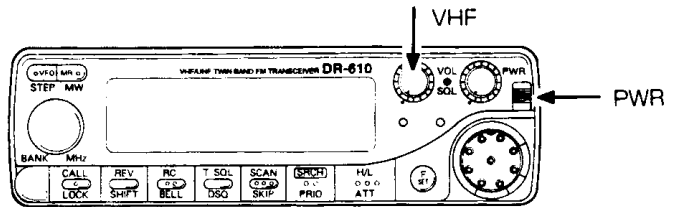

All indications on the UHF side disappear and transmit/receive are not possible.

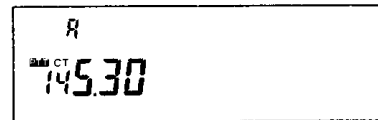

- Cancel-1** Push **UHF**.  
All UHF indications reappear and dual band operation is returned. Both transmit and operating indicators (**PTT** CT) move to the UHF side.
- Cancel-2** Push **(F)**, then push **UHF**.  
All UHF indications reappear and dual band operation is returned. Only the operating indicator (CT) moves to the UHF side.

## 2. UHF single band operation

While pushing **UHF**, turn power ON.

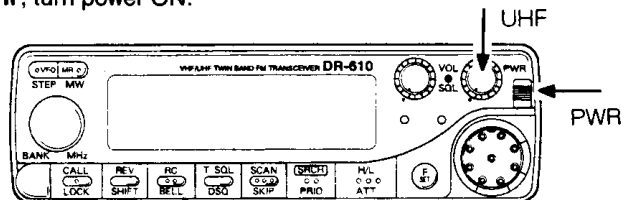

All indications on the VHF side disappear and transmit and receive are not possible.

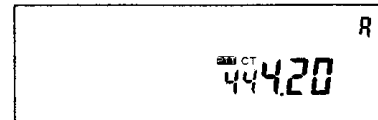

- Cancel-1** Push **VHF**.  
All VHF indications reappear and dual band operation is returned. Both transmit and operating indicators (**PTT** CT) move to the VHF side.
- Cancel-2** Push **(F)**, then push **VHF**.  
All VHF indications reappear and dual band operation is returned. Only the operating indicator (CT) moves to the VHF side.

# Duplex operation (shift, split settings)

This transceiver can receive signals on both bands simultaneously. Also, while transmitting on the VHF (UHF) side, receive continues on the UHF (VHF) side. Crossband operation allows you telephone-like communications. What's more you can set different transmit and receive frequencies for the same band using 3 different modes, - shift, + shift and split mode.

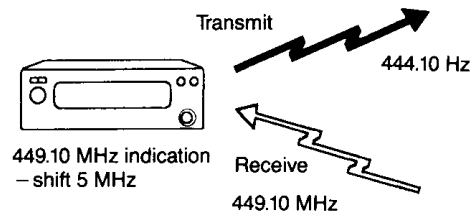

① Push **F**, then push **SHIFT**.

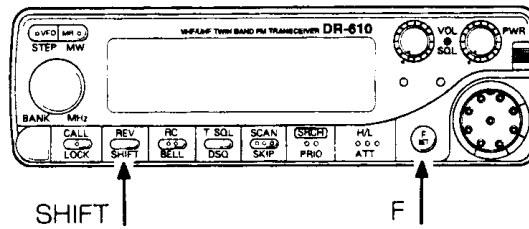

**F** appears and then flashes. Each push of **SHIFT** toggles between shift and split settings.

**- shift**

Transmit frequency is shifted below the receive frequency by an amount determined by the shift offset.

**+ shift**

Transmit frequency is shifted above the receive frequency by an amount determined by the shift offset.

**Split**

In VFO mode transmit occurs exchanging VFO A and VFO B. In memory mode, transmit occurs on programmed split memories in the specialty bank. Split settings can be programmed into VU specialty bank memories 0 to 29 only.

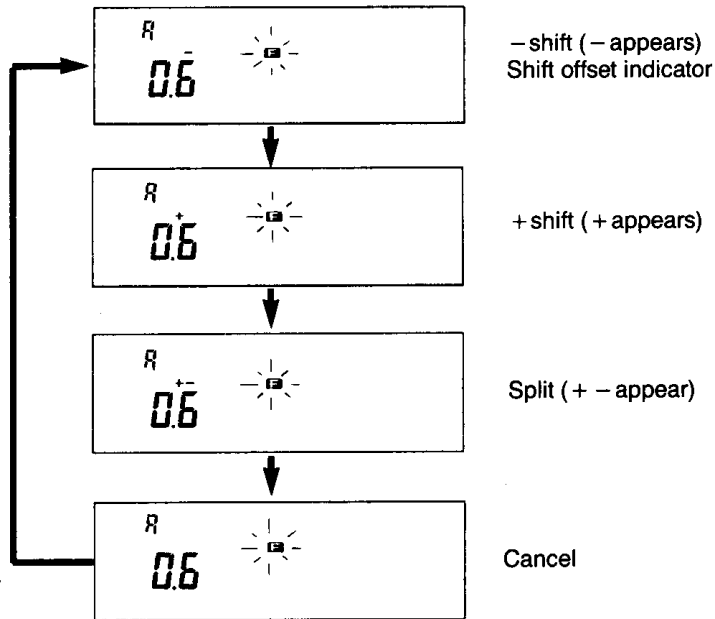

■ Factory default shift offsets (MHz)

Model	VHF	UHF
T	0.6	5
E	0.6	7.6

■ Push the MHz key to change the shift offset in units of 1 MHz (page 16)

■ During setting, if no operation is performed for 5 sec., the operation is cancelled.

② Changing the shift offset  
 Rotate **DIAL** or push the **UP/DOWN** keys on the microphone.

- Shift offset changes in units of 25 kHz.
- Shift offset range is 0 to 15.975 MHz.

**Finish** Push **F** or **PTT** to complete the setting.

## Transmitting with shift/split

**- shift** When - appears the transmit frequency is shifted below the receive frequency by an amount determined by the shift offset.

**+ shift** When + appears the transmit frequency is shifted above the receive frequency by an amount determined by the shift offset.

**Split** VFO mode  
When + - appears and you are receiving on VFO A (VFO B), transmit takes place on VFO B (VFO A).

### Memory mode

When + - appears for V/U specialty banks each memory holds split memory receive frequencies for transmit. When a memory with split is chosen the transmit frequency is not indicated during receive.

### Note

- When the transmit frequency is outside of the band range transmit is inhibited and OFF appears.

OFF

## Changing tuning steps

Tuning steps are the units of frequency used when increasing or decreasing the frequency, scanning or during the Channel Scope operation.

- The factory default settings for tuning steps are:

DR-610T 5 kHz  
DR-610E 12.5 kHz

- Tuning steps can be set separately for the VHF and UHF bands and for VFO A and B.

- During setting, if no operation is performed for 5 sec. or if power is turned OFF, any changes being made to the tuning steps will not be programmed.

① In VFO mode, push **F** then push **STEP**.

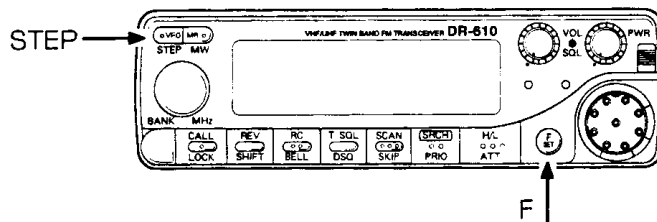

**F** appears and then flashes and the current tuning step appears. (Unit: kHz)

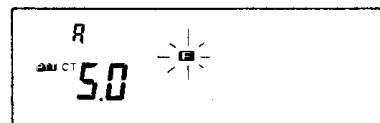

② Rotate **DIAL** or push the **UP/DOWN** keys to change the tuning step.

(Unit: kHz)

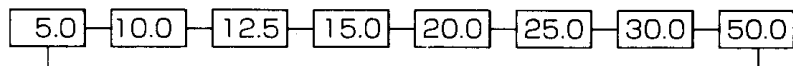

**Finish** Push any key to complete the setting.

- When tuning step is changed from 5K, 10K, 20K, or 30K to 12.5K, 25K, or 50K, or vice versa, the displayed frequency may be automatically compensated.

## Reverse (transmit and receive frequencies are exchanged)

When communicating through a repeater, this function allows you to see whether or not you can communicate directly with the other station by allowing you to temporarily receive on the transmit frequency.

Since repeaters are used by many people it is good operating practice to use reverse mode and check whether communication is possible without a repeater.

### Note

- Shift and split settings must be set for reverse to operate. Also, if reverse operation results in an out-of-band frequency, OFF appears. In this case push any key to return to normal frequency indication.

Push **REV**.

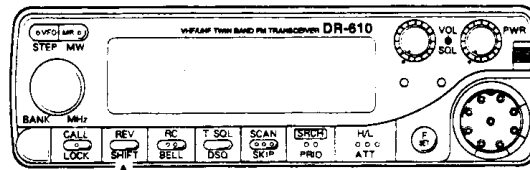

REV ↑

R appears and the transmit frequency is received.

(Ex.) Receive frequency 449.92 MHz  
Result of reverse function  
with a - shift of 5 MHz

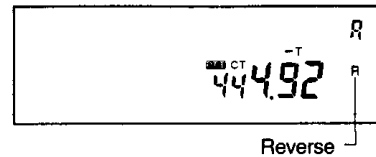

**Cancel** Perform any operation to cancel reverse. (R disappears)

## Setting the tone (CTCSS) encoder

Tone encoder and tone frequencies can be set. When T appears, a subaudible tone frequency is superimposed over your transmit signal.

For details on installing the optional tone squelch (CTCSS) unit (EJ-24U) see pages 49 and 71.

- When T and the frequency are indicated, push **TSQL** to indicate the tone frequency.
- While the tone frequency is indicated, if no operation is performed for 5 sec. or power is turned OFF, the setting is cancelled.

① Push **TSQL**.

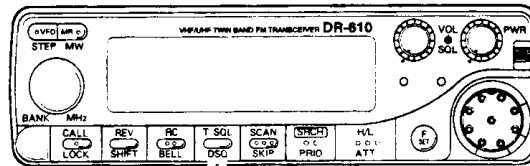

TSQL ↑

Tone indicator

T and the tone frequency appear.  
(initial setting is 88.5 Hz)

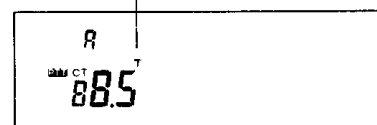

② Choose a tone frequency with the **DIAL** or **UP/DOWN** keys.

Tone frequency table (Unit: Hz)

67.0	69.3	71.9	74.4	77.0	79.7	82.5	85.4	88.5
91.5	94.8	97.4	100.0	103.5	107.2	110.9	114.8	118.8
123.0	127.3	131.8	136.5	141.3	146.2	151.4	156.7	159.8
162.2	165.5	167.9	171.3	173.8	177.3	179.9	183.5	186.2
189.9	192.8	196.6	199.5	203.5	206.5	210.7	218.1	225.7
229.1	233.6	241.8	250.3	254.1				

**Finish** Push **(F)** or **PTT** to complete the operation.

**Cancel** While the tone frequency is indicated push **TSQL**. T disappears and the display returns to frequency indication.

## Key lock

Use the key lock function to prevent accidental frequency changes and function access.

■ While the key lock function is activated, the following keys are still operable:

- PTT key
- UP/DOWN keys on the microphone
- Cancelling the key lock function

Push **F** then push **LOCK**.

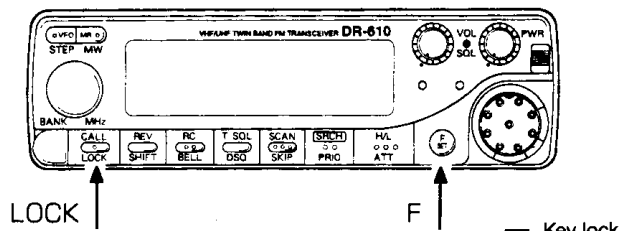

While **→** appears, the key lock function is activated.

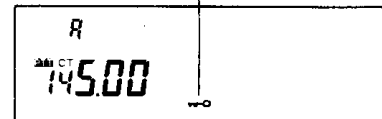

**PTT** and the **UP/DOWN** keys on the microphone can still be used.

**Cancel** Repeat the above operation. (**→** disappears)

## Bell function ON/OFF

When the bell function is activated, a beep alerts you to received signals and **▷** appears in the display. This function is convenient because you can tell when you have received a call even when you leave the transceiver temporarily unattended.

- This function is especially convenient when TSQ or DSQ is used together and standing by.
- This function can be set separately for VHF and UHF.
- When beep tones are turned off in set mode, **▷** indication still flashes when receiving a call. (page 42)
- When **▷** flashes, turn power OFF and then ON again to stop the flashing.

### Note

- While **▷** appears, scan and priority watch cannot be started.

Push **F** then push **BELL**.

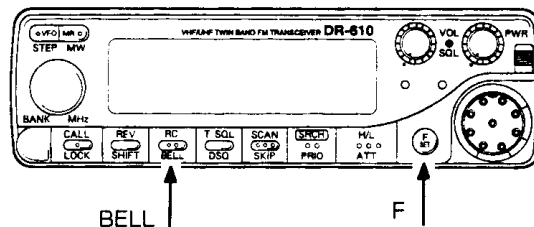

**▷** appears and the bell function is activated.

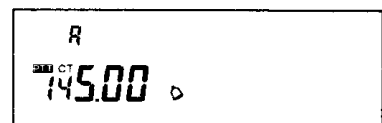

When **▷** appears and a signal is received, **▷** flashes and the frequency indication changes to **BELL**.

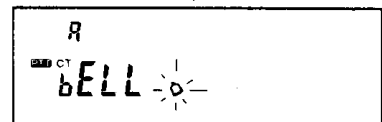

**Cancel** Perform the same operation as above or push PTT to cancel the function. (**▷** disappears.)  
While **▷** flashes push any key to cancel the function.

## Attenuator ON/OFF

### Attenuator

This function lowers the receive sensitivity. When ON the receiver sensitivity is lowered approx. 20 dB. Turn this function ON to reduce interference from strong nearby signals.

### Note

- When ATT is ON for the VHF side, it is effective for 145 MHz band signals received on both VHF and UHF sides of the transceiver. When ATT is ON for the UHF side, it is effective for 440 MHz signals on the VHF side.

Push **F** then push ATT.

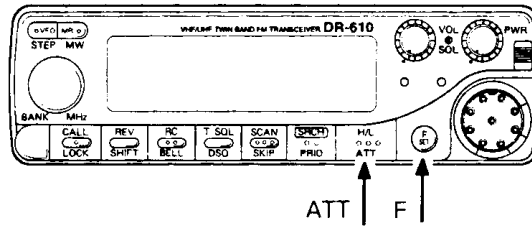

ATT appears.

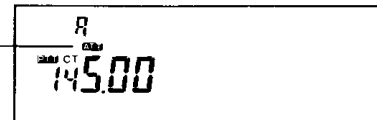

**Cancel** Perform the same operation as above. (ATT disappears)

## Muting the sub band audio

This turns off the receive audio for the band which is not for transmitting.

- Even when the mute function is on, beep tones can still be heard.
- While the mute function is on, if the transmit band is changed with the VHF or UHF keys, the mute function indicator also changes bands.

Push and hold **F** and push H/L.

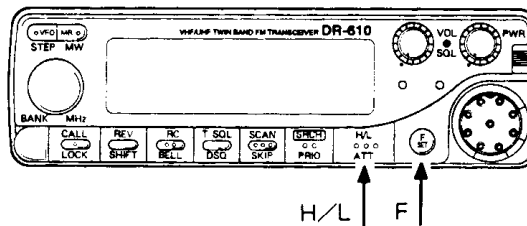

Audio is muted for the band in which **PTT** does not appear.

The S-meter's **FULL** on the muted side flashes.

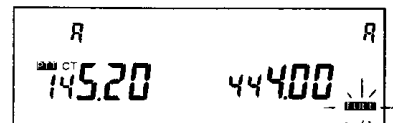

Mute indicator

**Cancel** Perform the same operation as above. (Mute indicator disappears.)

## Auto power off function

When keys or the DIAL are not used for 1 hour power is automatically turned off.

- When power is turned back ON after being turned off automatically during APO operation, APO flashes and starts counting again from 0 seconds.
- 30 seconds before power turns off, warning beeps sound.

While pushing **MHz** turn power ON.

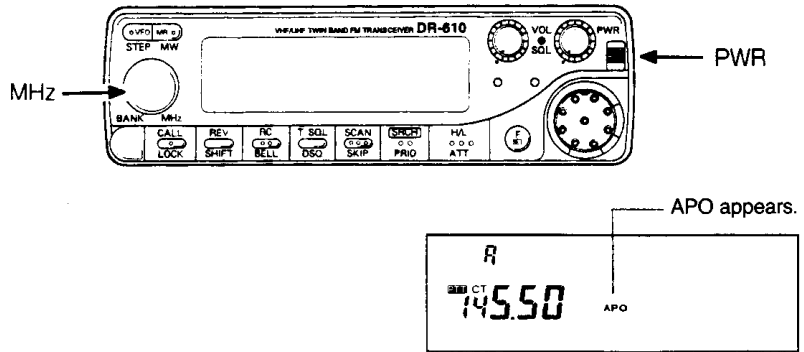

**Cancel** Perform the same operation as above. (APO disappears.)

## Transmitting a tone burst

A 1750 Hz tone signal is superimposed over top of your transmission. When the tone setting is activated, the CTCSS tone encoder frequency is also sent.

When **PTT** and CT appear on different bands, a tone burst signal cannot be transmitted.

While pushing **PTT** to transmit, push the **DOWN** key on the microphone.

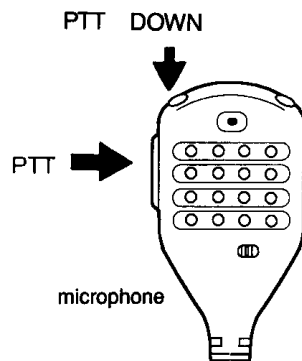

While the key is pushed a tone burst is sent.



# 7. Set Mode

Using set mode you can set conditions for a variety of functions such as the Channel Scope, DSQ, beep tones, and bell.

Entering set mode brings up the beep tone menu; rotate the DIAL to select other menus (a total of 12).

	Menu	Indication
1	Beep tone volume	bEEP 1
2	Bell audio ON/OFF	bELL on
3	Speaker ON/OFF	SP on
4	Display backlighting	LP 2
5	Time-out timer	toE OFF
6	Channel Scope receive interval	Sch-E int 5
7	Channel Scope size	Sch ch 5
8	DTMF first digit delay	d-DLY 450
9	DTMF burst/pause interval	bt-Pt 60
10	LITZ signal receive ON/OFF	LIt on
11	Monitor function ON/OFF	bUSY ---
12	S-meter squelch ON/OFF	S- OFF

## Menu selection

When power is turned OFF, change in the last indicated menu is cancelled. Operations in set mode do not have to be carried out within 5 sec.

**Note**

- Set mode cannot be selected during channel scope operation.

- Push **F** for longer than 3 sec.

**F** flashes and set mode is selected.

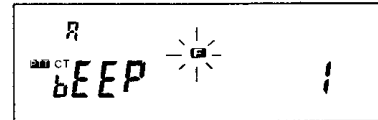

- Rotate **DIAL** to select a menu.
- Push **UP/DOWN** on the microphone to set a condition.

**Finish** Push **F** or **PTT** to exit set mode. Rotate **DIAL** to select another menu.

4

## Menu 1. Beep volume setting

The confirmation beeps which sound when pushing a key can adjusted or turned OFF.

- This setting affects both VHF and UHF operation.
- When level 1 is set and you transmit, the beep tone level for the other band becomes 2 during the transmission.

- Select the menu in set mode.
- Use the **UP/DOWN** keys on the microphone to set the condition.

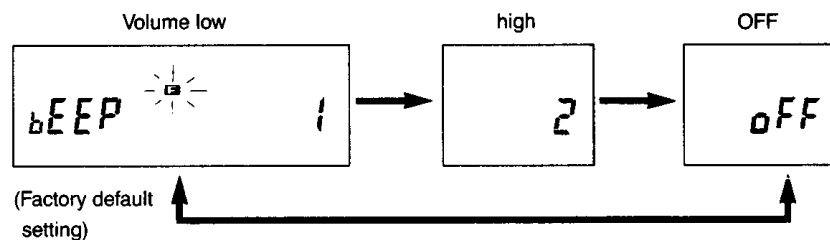

## Menu2. Bell audio ON/OFF

When the bell function audio is turned OFF, no alert sounds when receiving a signal, only  appears.

■ This setting is available independently for VHF and UHF side.

- ① Select the menu in set mode.
- ② Use the **UP/DOWN** keys on the microphone to set the condition.

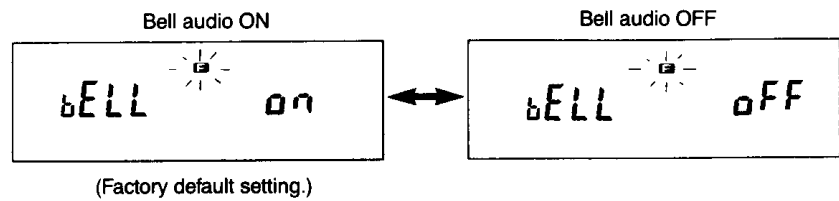

## Menu3. Speaker ON/OFF

When connecting an external speaker using the optional junction box (EDS-1), the transceiver's speaker can be turned OFF if desired.

■ This setting affects both VHF and UHF side.

- ① Select the menu in set mode.
- ② Use the **UP/DOWN** keys on the microphone to set the condition.

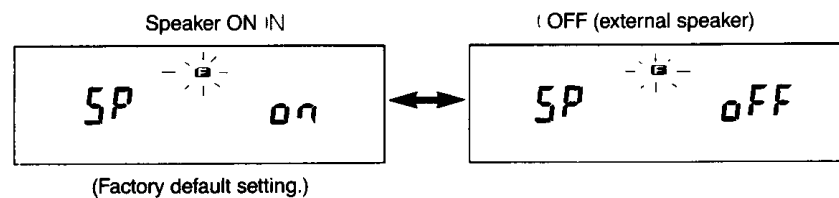

## Menu4. Display backlighting

This adjusts the brightness of the display backlighting.

- ① Select the menu in set mode.
- ② Use the **UP/DOWN** keys on the microphone to set the condition.

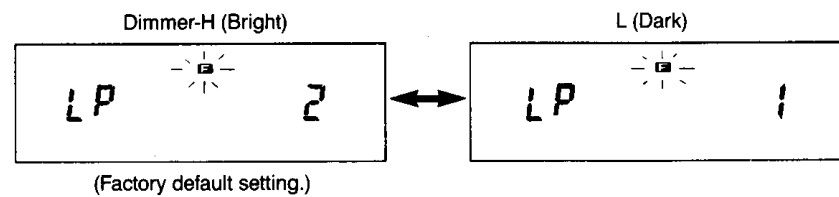

## Menu5. Time-out timer

This function automatically inhibits transmission after a specified time of continuous transmission.

■ This setting affects both VHF and UHF side.

- ① Select the menu in set mode.
- ② Use the **UP/DOWN** keys on the microphone to set the condition.

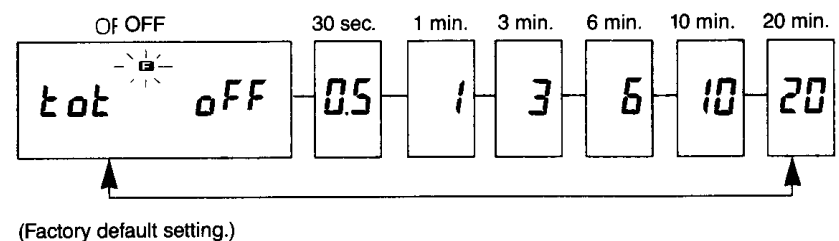

Set the time-out timer to prevent accidental prolonged transmission which could interfere with other stations as well as overheat the transceiver.

When a setting other than OFF is selected, TOT flashes and when set mode is exited, the flashing stops.

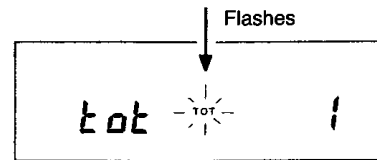

## Menu6. Channel Scope receive interval

4 different receive intervals can be set for the Channel Scope.

■ This setting is available independently for VHF and UHF side.

- ① Select the menu in set mode.
- ② Use the **UP/DOWN** keys on the microphone to set the condition.

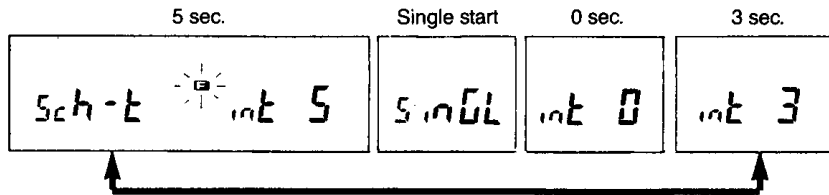

5 sec. mode Factory default setting	The center channel is received for 5 sec., then the other channel indicators are updated.
Single start mode	The scope indicators are measured once, after that the center channel receives continuously.
0 sec. mode	The center channel is not received for a period of time and the indicators are updated continuously. (No audio)
3 sec. mode	The center channel is received for 3 sec., then the other channel indicators are updated.

## Menu7. Channel Scope size (5/11 signals)

This sets the number of signal levels displayed during the Channel Scope to 5 or 11.

■ This setting affects both VHF and UHF side.

- ① Select the menu in set mode.
- ② Use the **UP/DOWN** keys on the microphone to set the condition.

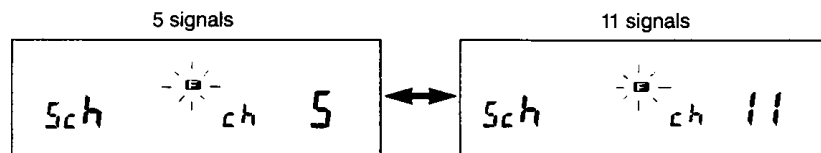

(Factory default setting.)

Indicators during operation

VHF 5 signals

VHF 11 signals

UHF 5 signals

UHF 11 signals

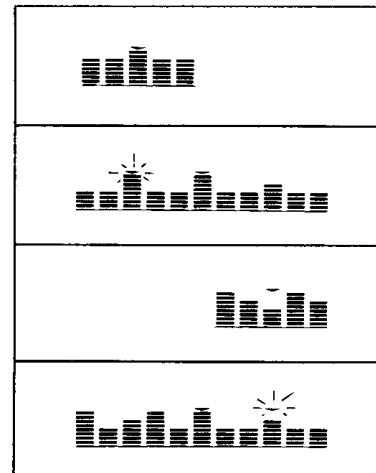

## Menu8. DTMF first digit delay

During DSQ operation or DIAL code operation, this sets the time from when the PTT is pushed until the first DTMF digit is sent.

For repeater use set this to 750 ms. This allows for the time required to open the repeater.

■ This setting affects both VHF and UHF operation.

- ① Select the menu in set mode.
- ② Use the **UP/DOWN** keys on the microphone to set the condition.

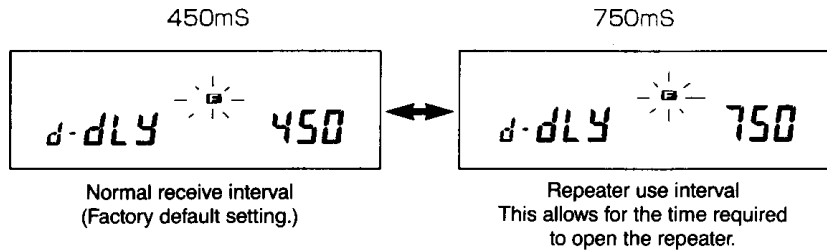

## Menu9. DTMF burst/pause interval

This adjusts the time of each DTMF digit and the interval between digits for DSQ operation and DIAL code operation.

When other stations are having trouble receiving your DTMF codes try setting this to 100 ms.

■ This setting affects both VHF and UHF operation.

- ① Select the menu in set mode.
- ② Use the **UP/DOWN** keys on the microphone to set the condition.

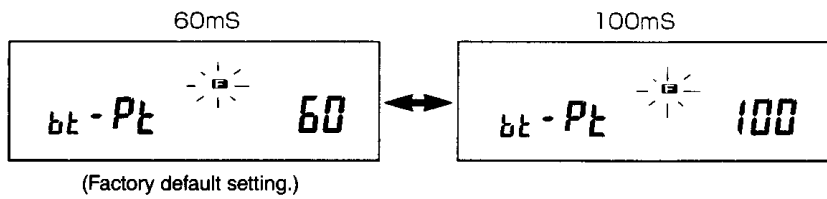

## Menu10. LITZ signal reception ON/OFF

This function sounds an alarm when receiving a LITZ signal.

A LITZ signal is a signal with DTMF "0" modulated for over 3 seconds.

■ This setting affects both VHF and UHF operation.

### Note

- During tone squelch or DSQ operation LITZ signals are susceped.
- During remote operation or cross-band repeater operation LITZ signals are not susceped.
- During scanning LITZ signals may not be received even when LITZ operation is turned ON. (During LITZ operation do not operate scans.)
- While the LITZ indicator flashes, functions other than the LITZ are ignored.

- ① Select the menu in set mode.
- ② Use the **UP/DOWN** keys on the microphone to set the condition.

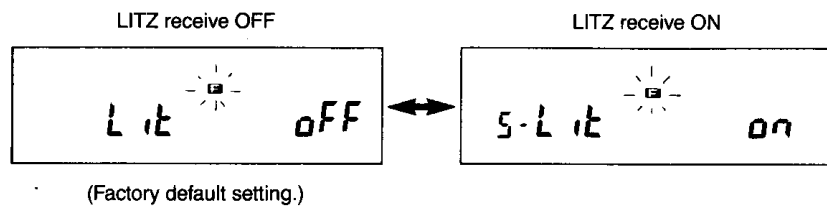

(Ex.) Receiving on the VHF side

When set to ON and LITZ signal is received, LIT flashes and an alarm sounds. Push any key to stop the alarm and flashing.

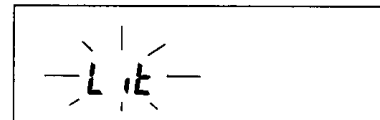

## Menu 11. Monitor function ON/OFF

This function sets the UP/DOWN keys on the microphone as monitor keys for the operating band side (CT indicated). The monitor keys unmute the squelch for reception of very weak signals.

■ Pushing the monitor key unmutes the squelch even during DSQ or TSQ operation.

### Note

- The monitor function does not function during transmit.
- The UP/DOWN keys function as UP/DOWN operation during scanning, priority watch and setting operations.

- ① Select the menu in set mode.
- ② Use the **UP/DOWN** keys on the microphone to set the condition.

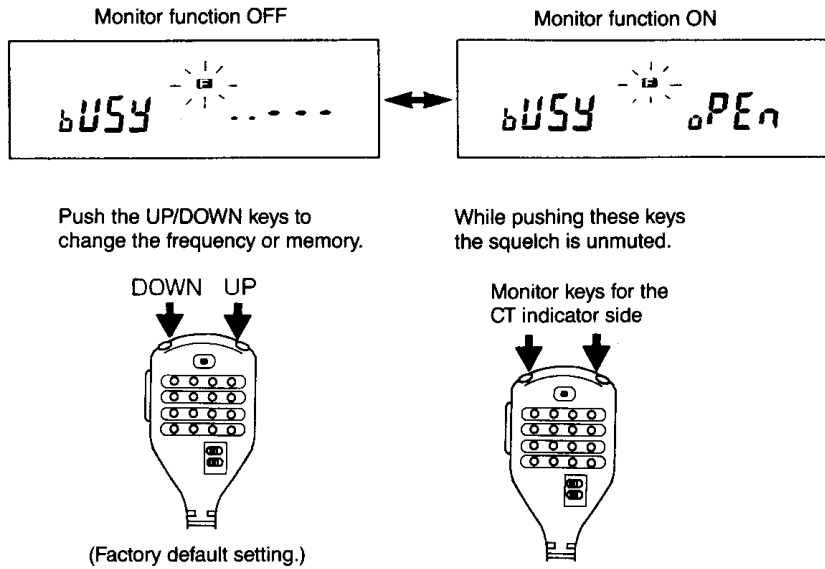

## Menu 12. S-meter squelch function ON/OFF

The S-meter squelch function unmutes the squelch only when a received signal is as strong or stronger than a specified S-meter level.

- This function is useful when there is a lot of noise.
- This function is useful when the noise level is high.

- ① Select the menu in set mode.
- ② Use the **UP/DOWN** keys on the microphone to set the condition.

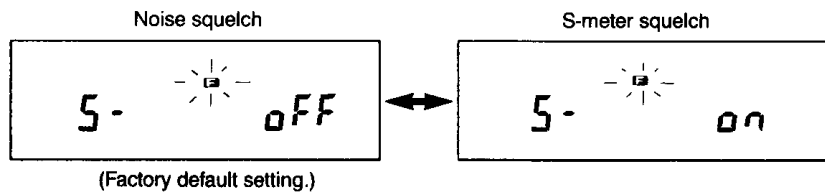

### Set the squelch level

Rotate the **SQL** knob for the band which S-meter squelch is set ON.

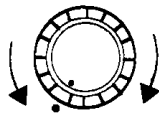

Weaker signals      Stronger signals

When the S-meter squelch is ON only one segment of the S-meter indication (1 to FULL) appears. Rotate SQL to select the desired indication. Only signals which are as strong as or stronger than the S-meter setting will unmute the squelch so that audio can be heard.

(Ex.) Setting for level 3 (only 3 appears)

A signal weaker than level 3 does not unmute the squelch and the signal cannot be heard.

## 8. Functions for the DR-610T only

The following functions are available for the DR-610T only.

### Cross band repeater ON/OFF

This function allows the DR-610T to receive on one band and relay by transmitting on the other band.

#### Note

- This operation is only possible between the 145 MHz band and 440 MHz band.
- When the cross band repeater is ON, the bell indicator and channel scope are cancelled.
- During cross band repeater operation only the PTT, RC, H/L VHF and UHF keys function.

While pushing (F), push VHF.

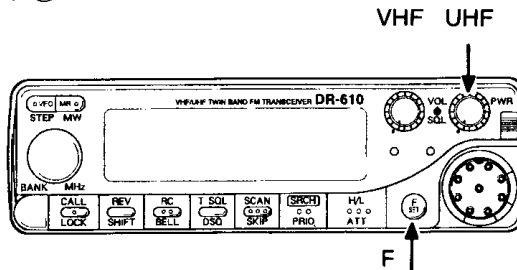

P appears and cross band repeater operation is selected.

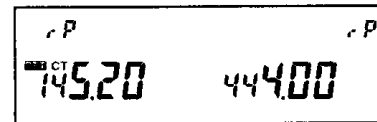

While receiving a signal on one side, transmit occurs on the opposite side. At this time the PTT indicator moves to the transmit side.

Cancel While pushing (F), push UHF.

### AM receive

#### Note

- AM cannot be received on the UHF side. In calling up an AM memory from bank A to C to UHF side, FM mode will be selected.

Default selects AM mode in the 118 MHz band and FM in other bands. This function allows you to switch between AM and FM modes.

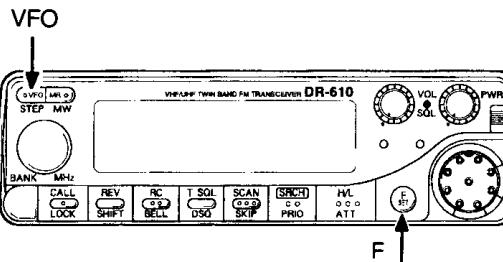

- ① Select the VHF side as the operating band. Then choose VFO mode.
- ② While pushing (F), push VFO.

A appears and AM mode is selected.

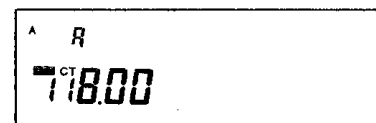

Cancel Perform the same operation as above. (A disappears.)

# 9. Reset

When resetting all memory channels and other settings return to their factory default settings.

## All reset

All VHF/UHF settings and memories are returned to their initial values.

When the transceiver is not functioning properly and after consulting the troubleshooting table on page 73, if the problem still persists, try resetting by this procedure.

While pushing **F**, turn the power ON.

While **F** still remains pushed all segments of the display appear.

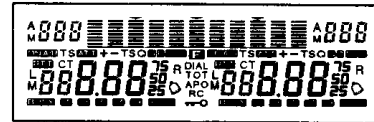

When **F** is released the VFO initial settings appear.

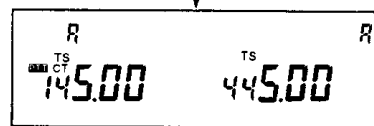

## Initial setting from the factory

		DR-610T	DR-610E
VFO frequency	VHF	145.000 MHz	145.000 MHz
CALL frequency	UHF	445.000 MHz	433.000 MHz
Memories C, PH, PL			
Shift offset	VHF	0.6 MHz	0.6 MHz
	UHF	5 MHz	7.6 MHz
Tuning step		5 kHz	12.5 kHz
Tone encoder/decoder frequency		88.5 Hz	88.5 Hz

Transmit band (PTT)	VHF
Operating band (CT)	VHF
Memory number	Specialty bank
Shift, split setting	None (Cancelled)
Tone setting	
DSQ mode setting	
Output power	high (No indicator)

Attenuator	OFF
DIAL setting	
TOT	
APO	
Key lock	
Bell indication	
External remote control	
LITZ signal receive	

Scan resume condition	Timer scan
Beep tones	Level 1 (low)
Display backlighting	Bright
Channel Scope size	5 signals
Channel Scope receive interval	5 sec.

# 5

## Selective calling

Selective calling allows you to communicate with specific stations only. This is convenient because it allows quiet stand-by while waiting for calls.

**Tone squelch (CTCSS)** (Optional tone squelch unit EJ-24U must be installed (page 71).)

When using tone squelch, only received signals which contain the same tone as yours will unmute the squelch and therefore be heard. 50 tone frequencies are available.

**DTMF squelch (DSQ)**

This function uses codes (group, individual, and individual codes for other transceivers) stored in special memories to unmute and mute the transceiver's squelch. A DSQ code is sent when transmitting and unmutes the receiving transceiver's squelch only when there is a match. Matched codes are indicated in the receiving transceiver's display. There are 3 DSQ modes as follows.

- **Code squelch**

3-digit code is sent during transmission and unmutes the receiving transceiver's squelch only when the codes match. Code squelch operates in a similar manner to tone squelch.

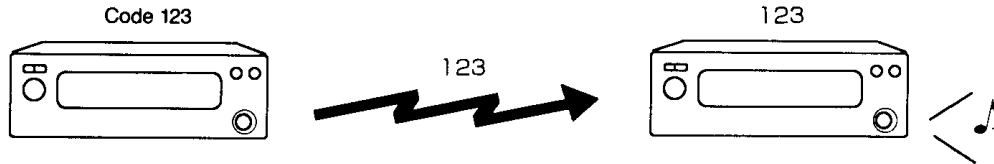

- **Group pager mode**

Using group codes, all members of the same group can communicate (8 different group codes that can be memorized. Members of each group must be programmed with the same group code). Group codes are sent along with individual code. Group code appear in the receiving transceiver's display allowing you to know which group called.

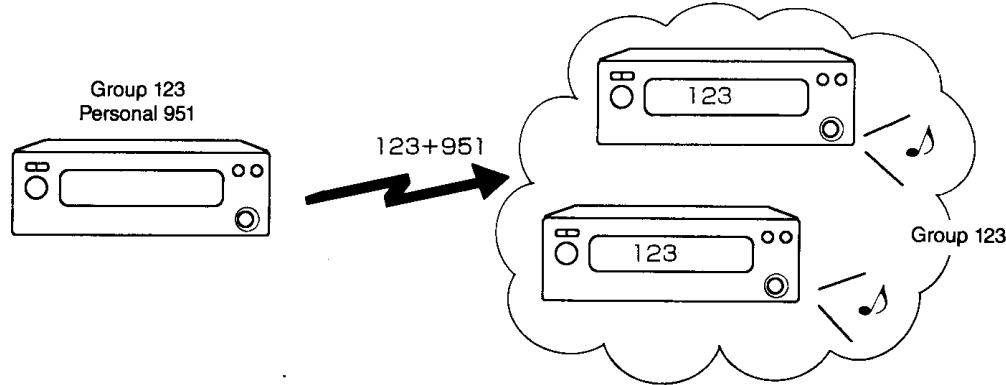

- **Private pager mode**

This function allows you to contact a specific station by sending the code belonging to an individual station.

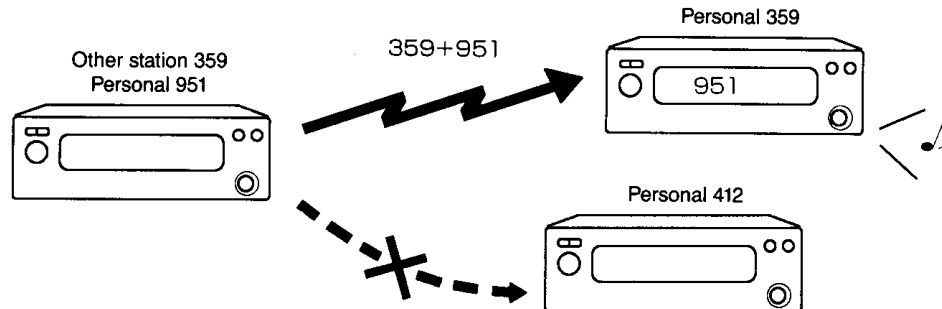

5



# 1. Tone squelch

Optional tone squelch Decoder Unit (EJ-24U) must be installed. (page 71)  
Tone squelch provides quiet standby. Only received signals which contain the same tone frequency as your transceiver unmute the squelch and can be heard.

■ Tone squelch can be set separately for VHF and UHF.

### Note

● When the encoder frequency is changed, the decoder frequency automatically changes to the same value; however, when the decoder frequency is changed, the encoder frequency remains unchanged.

■ During tone frequency indication if no operation is performed for 5 sec. or the power is turned OFF, any changes are cancelled.

■ When receiving an unmatched tone audio cannot be heard but the S-meter registers the signal strength.

## 1. Tone setting/Setting a tone squelch frequency

① Push **TSQL**.

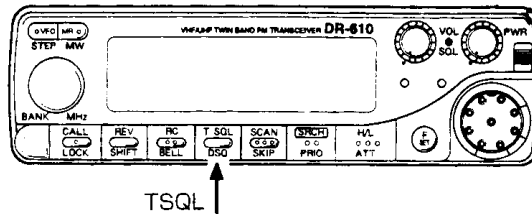

Each push of this key changes the tone setting. During tone squelch operation **TSQ** appears.

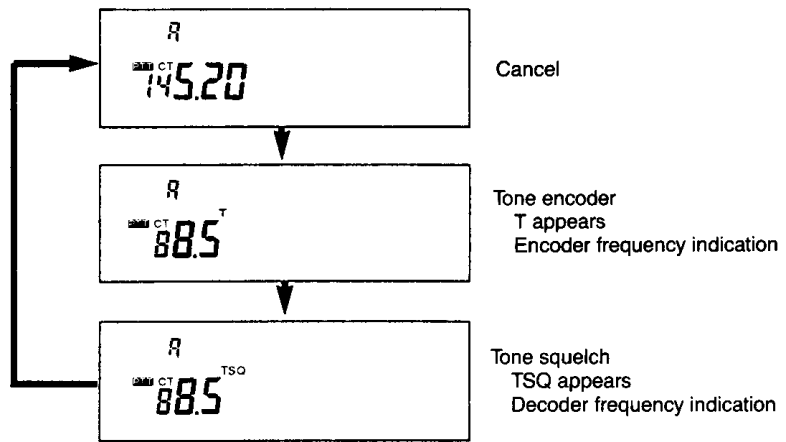

② Rotate **DIAL** or push the **UP/DOWN** keys to select an encoder/decoder frequency.

Tone frequency list (Unit: Hz)

67.0	69.3	71.9	74.4	77.0	79.7	82.5	85.4	88.5
91.5	94.8	97.4	100.0	103.5	107.2	110.9	114.8	118.8
123.0	127.3	131.8	136.5	141.3	146.2	151.4	156.7	159.8
162.2	165.5	167.9	171.3	173.8	177.3	179.9	183.5	186.2
189.9	192.8	196.6	199.5	203.5	206.5	210.7	218.1	225.7
229.1	233.6	241.8	250.3	254.1				

**Finish** Push **F** or **PTT** to complete the operation.

## 2. Transmitting

With the tone squelch set, push **PTT**.  
The selected tone encoder frequency is superimposed over the transmission.

## 3. Receiving

When a signal containing a matched frequency with that set in the decoder (when **TSQ** appears) is received the squelch unmutes and the signal can be heard.

## 2. DSQ

3 types of DSQ codes are used for communicating in DSQ mode as indicated in the table at right. Group codes and personal codes are the same for both VHF and UHF however, other station's codes are set separately.

Code type	Contents	Memory name
Group code	All members of the same group must use the same group code. There are 8 available (you can belong to 8 different groups). These codes must be used when communicating in group pager mode. Same codes are used for code squelching.	1-8 (V/U same)
Personal code	This is your transceiver's own personal code. This code must be set in order to receive calls directed to you using private page mode.	P (V/U same)
Other member's codes	These codes must be set in order to contact other transceivers in private pager mode.	y (V/U separate)

## Programming DSQ codes

DSQ codes must be programmed before communicating in DSQ mode.

- DSQ codes are made up of 3-digit numbers.
- The default setting for all codes is 000.

- ① While pushing (F) push DSQ.

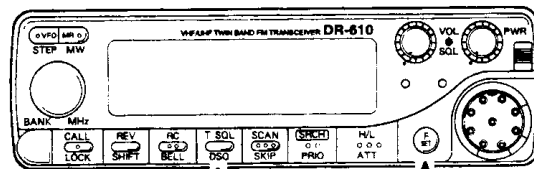

Group code monitor (page 57)

DSQ code memory number and code appear.  
The DIAL changes the code memory number.

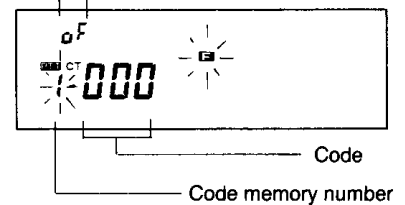

- ② Select a code number  
Rotate **DIAL** while the code memory number flashes.  
(When the **UP/DOWN** keys on the microphone are pushed the code memory number changes and the first digit of the code flashes.)

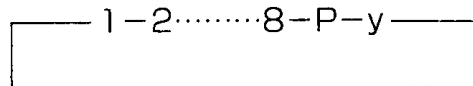

- ③ Entering the first digit  
Push **DSQ**. The first digit flashes. Rotate **DIAL** to select the desired code.

Group code monitor

The first digit can be selected from 0 to 9.

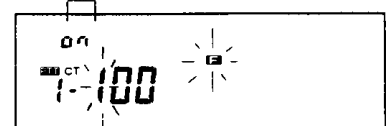

■ While entering a code if no operation is performed for 5 sec. or the power is turned OFF the last displayed code is not changed.

- ④ Enter the second digit  
Push **DSQ**. The second digit flashes. Rotate **DIAL** to select the second digit.
- ⑤ Enter the third digit  
Push **DSQ**. The third digit flashes. Rotate **DIAL** to select the third digit.
- ⑥ When you want to input another code...  
Use the **UP/DOWN** keys on the microphone to change the code memory number, then enter another code in the same manner.

**Finish** Push **F** or **PTT** to complete the operation.

### Clearing a code

Push **H/L**.

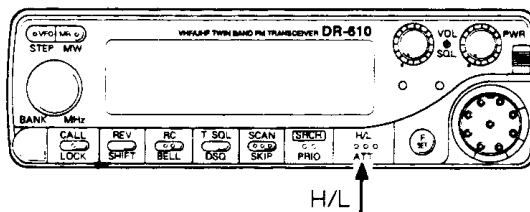

The displayed code becomes 000 and the group code monitor goes OFF.



### Setting the group code monitor ON/OFF

While group 1 to 8 is displayed push **SRCH**.

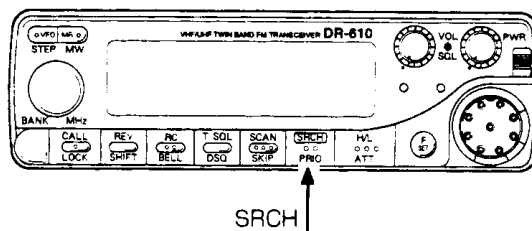

Each push turns the group code monitor ON and OFF for the CT displayed side. When ON is set, group codes can be received.

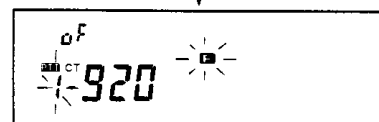
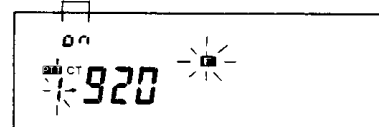

#### Group code monitor

For group codes 1 to 8 ON or OFF indication appears. ON indicates that group pager codes can be received.

■ Group code monitor ON/OFF settings can be set separately for VHF and UHF.

■ The default setting from the factory is OFF. However, when at least 1 digit is entered for a code on the CT displayed side, the setting automatically changes to ON.

■ Group code settings ON/OFF have no effect on operation in code squelch mode.

# Programming DSQ codes with a DTMF equipped microphone (EMS-12)

Optional for the DR-610E.

## Group code monitor ON/OFF

Push SRCH on the transceiver or  $\star$  on the microphone to toggle group code monitor ON and OFF. (page 51)

## Clearing a code.

Push H/L on the transceiver to set the displayed code to 000. The first digit flashes. (page 51)

■ While entering a code, if no operation is performed for 5 sec. or the power is turned OFF, no changes are made to the last displayed code.

① Set the microphone **REMOTE/DTMF** switch to REMOTE.

② Push  $\text{C}$  and  $\text{9}$  on the **DTMF** keypad.  $\text{F}$  and the first digit of the code flash.



③ Select a code memory number  
Push the **UP/DOWN** keys to select a code memory number.

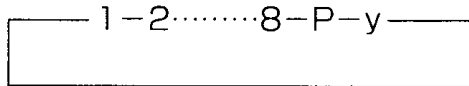

④ Enter a 3-digit code. (Numbers 0 to 9 only.)

- After entering a number the next digit flashes.
- After entering the first digit the group code monitor turns ON.



⑤ Push  $\text{A}$  to move the flashing digit position.

**Finish** Push  $\text{F}$  or **PTT** to complete the operation.

## Setting DSQ mode

Select one of the 3 DSQ mode and a DSQ code.

- ① Push **F** then push **DSQ**.

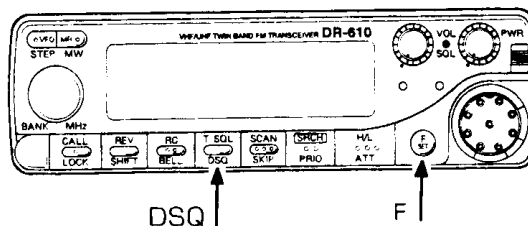

**F** flashes. Each push of **DSQ** changes the DSQ mode.

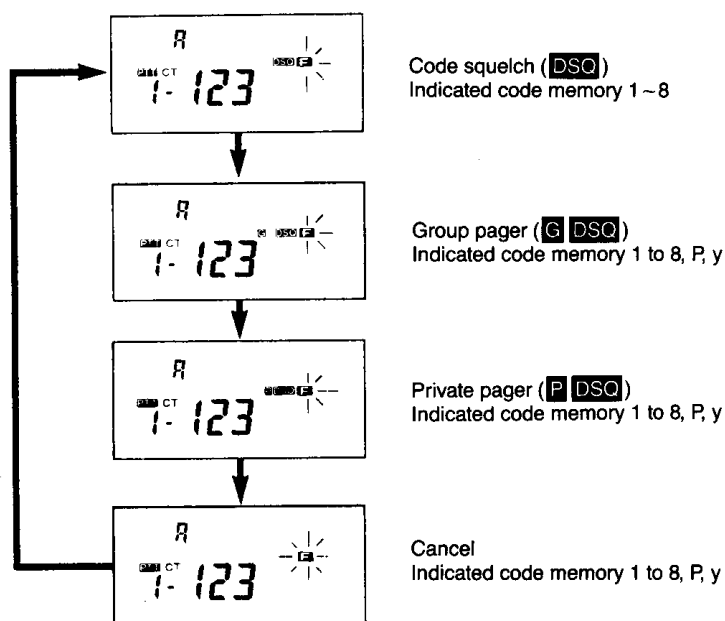

- ② Select a code memory  
Rotate **DIAL** or push the **UP/DOWN** keys on the microphone.  
Code selection is not necessary for private pager mode.

**Finish** Push **F** or **PTT** to complete the operation.

■ During mode selection if no operation is performed for 5 sec. changes being made are cancelled.

## Setting DSQ mode with a DTMF equipped microphone (EMS-12)

This is optional for the DR-610E.

- ① Set the **REMOTE/DTMF** switch to the **REMOTE** position.
- ② Enter **Ⓢ** with the **DTMF** keypad.  
While **F** flashes after pushing **DSQ** on the transceiver enter **Ⓢ** on the DTMF keypad to change the DSQ mode in the same way.
- ③ Select a code memory  
Rotate **DIAL** or push the **UP/DOWN** keys on the microphone.

**Finish** While a code is displayed push **F** or **PTT** to complete the operation.

■ Just as when setting with the transceiver, when no operation is performed for 5 sec. any changes being made are cancelled.

# Communicating in code squelch mode

Select one of the group codes 1~8 for receive and transmit. When receiving a 3-digit code that matches yours, squelch unmutes.

■ When the last indicate code is P or y, 1 is automatically selected.

■ During code squelch operation, group code monitor ON/OFF has no effect. (page 51)

## 1. Preparation

① Choose a memory of the code to use with your communicating partner in advance. (page 50)

② Push **F** then push **DSQ**. **DSQ** only appears. (page 53)

Code squelch mode

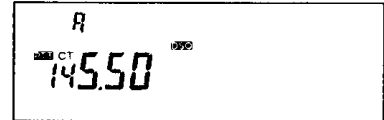

③ Rotate **DIAL** or push the **UP/DOWN** keys to select a code.

④ Push **F** or **PTT** to complete the operation.

## 2. Transmitting

Push **PTT**.  
Transmit is selected and the 3-digit code is sent.  
DTMF being emitted are heard.

## 3. Receiving

When receiving a 3-digit code that matches your selected group code the squelch unmutes and the received audio can be heard.

- **DSQ** flashes.
- An alarm sounds.

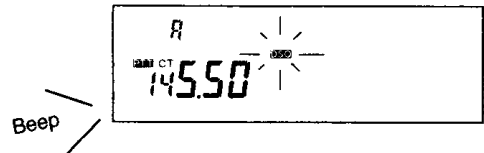

**Stopping the flashing** Push **VFO, MR, CALL VHF** or **UHF**.  
(Key primary functions do not operate.)

**Answer back** Push **PTT** to stop the flashing and transmit a 3-digit answer back code to the other station.

# Communicating in group pager mode

The transmitting station sends group code and personal code, 7 digits in total; the receiving station's squelch unmutes when receiving the same group code as that programmed into the receiving station's transceiver. This is different from code squelch operation in that you know from which group a code has been received.

■ When the last displayed code is P or y, 1 is automatically selected.

## Note

- Codes set to monitor-OFF (page 51) are ignored. Group code monitor can be set separately for VHF and UHF. However, when standing by in group pager mode make sure that the group code monitor is ON.
- When the receive code is displayed, rotate DIAL or push the UP/DOWN keys on the microphone to change the displayed code.
- The most recently received code is written into the receive side.
- After receiving a 3-digit code and , if no personal code is received the squelch unmutes but an error indicator appears.

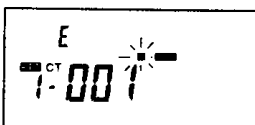

## 1. Preparation

- ① All members of a group should decide on the group code to use and their personal codes in advance. (page 50)
- ② Push  then push **DSQ** to display  **DSQ**. (page 53)

Group pager mode

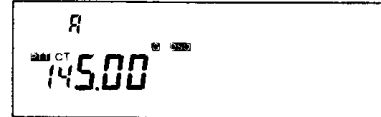

- ③ Rotate **DIAL** or push the **UP/DOWN** keys to select a group code.
- ④ Push  or **PTT** to complete the operation.

## 2. Transmitting

Push **PTT**.  
The 7 digits at right are transmitted and DTMF are heard.

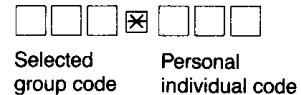

## 3. Receiving

When receiving a matching group code, 1 ~ 8, and a , the squelch unmutes and the received audio can be heard.

- flashes
- The matched group code appears.
- An alert sounds

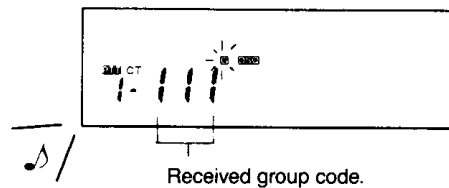

When a matching individual code is found, even if the group code is found to match, the transceiver enters private pager mode (Private pager mode takes priority.)

- flashes
- Other station's code appears
- Alarm sounds

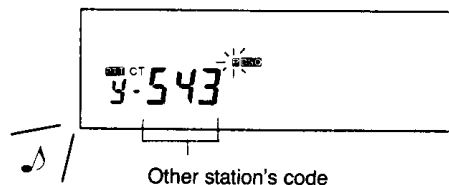

Canceling the flashing and code indication Push **VFO, MR, CALL, VHF** or **UHF**.  
(Primary key functions do not operate.)

Answer back Push **PTT**; flashing stops and displayed code disappears and an answer back code is sent.

# Communicating in private pager mode

The transmitting station sends its own individual code as well as another station's individual code; when the receiving station receives a code that matches its individual code, the squelch unmutes.

## 1. Preparation

- ① Partner(s) wishing to communicate should decide on their own individual codes and learn the individual codes for the other station in advance each other. (page 56)
- ② Push (F) then push **DSQ** to display **P DSQ**. (page 48)

Private pager mode

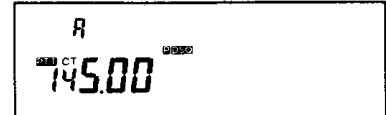

- ③ Push (F) or **PTT** to complete the setting.

## 2. Transmitting

Push **PTT**.  
The 7 digits displayed at right are transmitted and DTMF are heard.

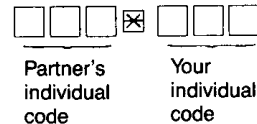

- While a receive code is displayed use the DIAL or microphone UP/DOWN keys to change the code memory number.
- The most recently received code is written into the receive side.

## 3. Receiving

When receiving a 3-digit code that matches your personal code and a , squelch unmutes and audio can be heard.

- **P** flashes.
- The transmitting stations personal code appears.
- Alarm beeps sound.

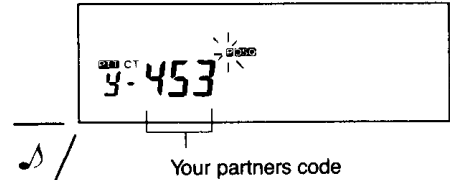

When the received code does not match your individual code but does match a group code, the transceiver automatically selects group pager mode.

- **G** flashes.
- Matched group code appears.
- Alarm beeps sound.

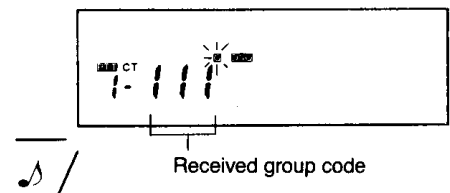

- After receiving a 3-digit code and , if no personal code is received the squelch unmutes but an error indicator appears.

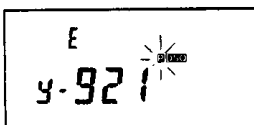

Previously received personal code

Stopping the flashing and clearing the displayed code

Push **VFO, MR, CALL, VHF** or **UHF**.  
(Primary key functions do not operate.)

Answer back

Push **PTT** to stop the flashing and clear the displayed code and to send an answer back.



## Manual DTMF transmission

This is an option for the DR-610E.

Individual DTMF codes can be sent manually regardless of whether or not DSQ mode is selected.

- ① Set the microphone **REMOTE/DTMF** switch to the DTMF position.
- ② While pushing **PTT** push the desired **DTMF** keys (0 to 9, A to D, \*, #).  
When transmitting more than 1 digit make sure the time between transmitted digits is less than 2 sec.

## Communicating with DSQ codes through a repeater

During normal DSQ operation, DSQ codes are sent 450 ms after pushing PTT.

When communicating through a repeater it is necessary to lengthen this interval because of the slight delay involved in opening the repeater.

In set mode select the single digit DTMF delay time menu and select 750 ms. (page 44)



### Notes for DSQ operation

- When DSQ operation is set for both VHF side and UHF side, if DTMF signals are being received on one side, the other side cannot suspect DTMF signals.
- When DTMF signals are simultaneously received on both the VHF and UHF sides, the VHF side takes priority.
- When receiving no signals, set the SQL so that the S-meter does not appear.
- After receiving a signal which unmutes the squelch, communication remains possible 2 sec. after the signal disappears. After 2 sec. the squelch mutes again.
- When communicating in group pager mode make sure that the group code monitor is turned ON for the standing by group number. Also, since the group code monitor can be set separately for both VHF and UHF, make sure the proper ON/OFF setting is made for both VHF and UHF.
- When OFF is set and a matching code is received, the squelch remains muted and receive is not possible.

### 3. Auto-dialing

Auto-dialing automatically sends DTMF codes which have been programmed into memory. This function is optional for the DR-610E (an optional DTMF microphone must be connected).

The transceiver has 1 DTMF receive memory for each VHF and UHF, and 5 DTMF transmit memories shared between VHF and UHF. Up to 15 digits can be programmed into each memory.

When an optional memory unit (EJ-23U) is installed, transmit memories are increased by 10 (M1 to M15).

Type	Contents
MO	Stores received DTMF signals. The most recently received DSQ code is stored. VHF and UHF each have one of these memories.
M1 ~ M5	These memories hold pre-programmed DTMF codes for transmit. 5 channels are shared between VHF and UHF. Different transmit DTMF memories can be selected for VHF side and UHF side.

#### Programming transmit codes into memory

- When shipped from the factory, DTMF memories are not programmed and they appear blank in the display. When programmed, the memorized digits are displayed.
- When an optional memory unit is installed (EJ-23U) available transmit memories increases to M0 to M15.
- MO is the receive DTMF memory. Codes cannot be programmed into this memory.
- $\frac{H}{\#}$  indication appears for the  $\frac{H}{\#}$  key H indication appears for the  $\frac{H}{*}$  key.

- ① Set the microphone **REMOTE/DTMF** switch to the **REMOTE** position.
- ② Push  $\text{C}$   $\text{4}$  on the **DTMF** keypad.

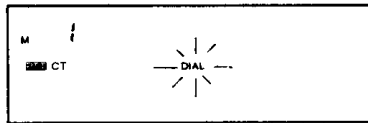

DIAL indicator flashes and the DIAL memory number appears.

- ③ Select a memory number  
Push the **UP/DOWN** keys on the microphone.

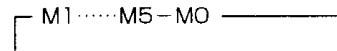

- ④ Enter the desired code using the **DTMF** keypad  
(Any of the 16 keys can be used.)

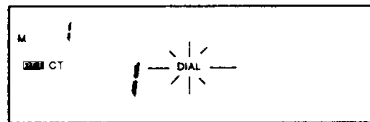

Entered digits appear on the far right and scroll to the left as other digits are entered. A maximum of 15 digits can be entered.



- While entering a code, if no operation is performed for 5 sec. or the power is turned OFF, the last displayed code is not changed.

- Finish** Push  $\text{F}$  or **PTT** to complete the operation.  
When a code has been entered into the last displayed DIAL memory, DIAL appears; if not, DIAL doesn't appear.

# Correcting a code that you have entered

- ① While entering a code, rotate the dial to place at the far right the digit one position to the left of the digit you want to correct.

(Ex.) You want to enter code 123 # 354.

Clockwise rotation.

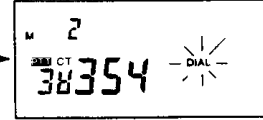
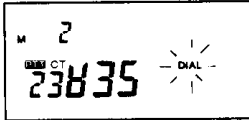

Counterclockwise rotation.

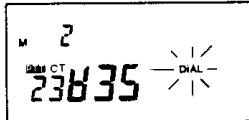

- ② Enter the correct code.

(Ex.) Changing 123 # 354 to 123 # 754.

Enter 7.

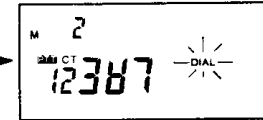
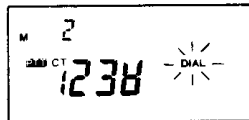

## Clearing a code

Push H/L.

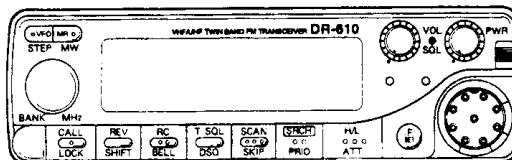

H/L ↑

Displayed code disappears.

## Entering a pause

Push SRCH.

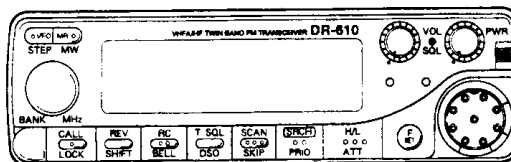

SRCH ↑

"-" appears.

A 1 sec. pause is inserted between 3 and 5.

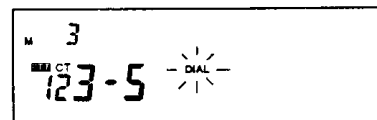

■ Entering a pause gives one second blank transmit time. A total of 15 digits including pauses can be entered.

## Confirming received codes

The most recently received code is stored into memory 0.

■ VHF and UHF memories are separate.

■ Up to 15 digits can be stored. When 16 or more digits are received, digits are erased starting from the oldest.

Also, when power is turned OFF the contents of M0 are erased.

- ① Enter **ⓐ** **④** using the microphone **DTMF** keys.
- ② Use the **UP/DOWN** keys on the microphone to select M0. The first digit to the fifth digit are displayed.
- ③ Rotate **DIAL** clockwise to scroll through the remaining digits. When rotating the **DIAL** no longer changes the displayed code, the end of the code has been reached.

## Auto-dial ON/OFF

Enter **ⓐ** **⑤** using the microphone **DTMF** keys.  
Repeat this operation to toggle the **DIAL** indicator ON and OFF.

ON (**DIAL** appears)

Codes can be transmitted using auto-dialing.

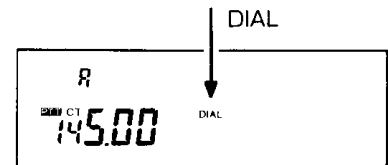

OFF (**DIAL** disappears)

Auto-dialing is not possible.

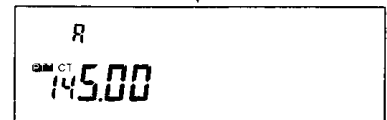

5

## Transmitting codes using auto-dialing

■ When **DIAL** does not appear or the last selected memory code has no programmed code, a code cannot be transmitted.

### Note

● When selecting the left side memory number, it can be used for a VHF frequency which may appear either on the left (VHF) or the right (UHF) side. Likewise, when selecting the right side memory number, it can be used for a UHF frequency which may appear on either side.

● When **PTT** and **CT** appear on different bands, auto-dialing is not possible. The frequency on the **CT** side is incremented instead.

- ① To transmit on a VHF band frequency, **PTT** and **CT** must be indicated on the left side; to transmit on a UHF band frequency, **PTT** and **CT** must be indicated on the right side.
- ② Select a memory number to transmit using **ⓐ** **④**.
- ③ While **DIAL** appears, push **PTT** and then **UP**.

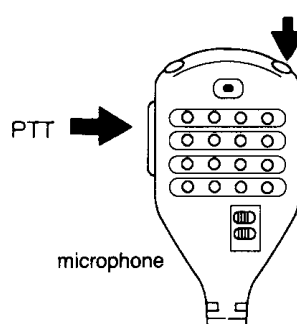

The selected memory number code is transmitted.

# 6

# Remote Control Operation

Remote control functions are commands issued using the microphone DTMF keys. Received DTMF signals can also be used to remotely control the transceiver. Microphone remote control functions are optional for the DR-610E and require the EMS-12.

## 1. Microphone remote control

Operating procedure for microphone remote control

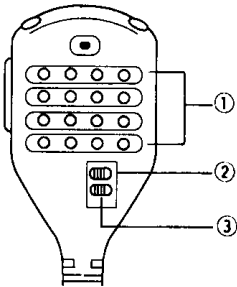

- ① Microphone commands or frequency entry.
- ② Sets lock so that microphone commands cannot be entered.
- ③ Set to the REMOTE position to enter microphone commands

- Equivalent key definitions
- F+□ Push F then push
  - F&□ While pushing F push

Code	Corresponding key	Operation	Page
C0	SRCH	Channel Scope start	27
C1	VFO	Calls up VFO mode	18
C2	MR	Calls up memory mode	18
C3	CALL	Calls up CALL mode	18
C4	—	Sets an auto-dial code	58
C5	—	Toggles auto-dial transmit ON/OFF	60
C6	Set mode	Changes the Channel Scope receive interval	27
C7	F + SRCH	Stops channel scope	27
C8	F + DSQ	DSQ mode setting	53
C9	F&DSQ	DSQ code setting	52
CA	F&H / L	Sub band audio mute	39
CB	REV	Reverse	37
CC	—	Cancels command entry	—
CD	F + PRIO	Priority watch	31
C*	VHF	Sets the main band to VHF	16
C#	UHF	Sets the main band to UHF	16

## Operating procedure for microphone remote control

- 5 sec. after entering the first digit RC disappears and the entered code is canceled.

**Note**

- While  appears remote control commands cannot be entered.

- ① Set the microphone **REMOTE/DTMF** switch to the REMOTE position.
- ② Enter © as the first digit.

RC flashes

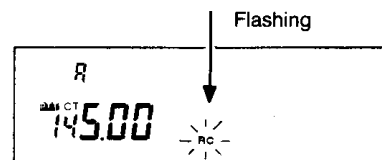

- ③ Enter the 2nd digit within 5 sec.  
The corresponding command is carried out.

■ Explanation of commands. Except for command CA these commands affect the operating band.

### (1) Channel Scope commands

- C0 When entered while in VFO or memory mode, starts the Channel Scope operation. When entered during the Channel Scope operation, restarts the Channel Scope. (page 25)
- C7 When entered during channel scope operation, stops channel scope. (page 25)
- C6 Enters center channel receive interval setting mode. Use the UP/DOWN keys on the microphone to change the receive interval. F or PTT completes the setting. (Refer to set mode operation on page 43)

#### Note

- Rotating DIAL does not select another set mode menu.
- The set mode will not be canceled even if no operation is performed within 5 sec.

### (2) Changing modes

- C1 Same function as the transceiver's VFO key. In VFO mode, toggles VFO A and B.
- C2 Same function as the transceiver's MR key. Calls up memory mode. When entered while in memory mode, changes the bank.
- C3 Same function as the transceiver's CALL key. Calls up CALL mode. When call mode is already selected, selects the previously selected mode.

### (3) Auto-dialing

- C4 Auto-dial input and transmit memory number selection. (page 58)
- C5 Toggles auto-dial transmit ON/OFF. (page 60)

### (4) DSQ

- C8 DSQ mode setting and code number selection. (page 53)
- C9 Enters DSQ codes. (page 52)  
Provides simple DSQ code input compared to input using the transceiver.

### (5) Changing transmit and operating bands

- C\* Same function as the VHF key on the transceiver. When the operating band is on the UHF side, transmit and operating bands are moved to the VHF side. (page 16) When the operating band is on the VHF side, changes the VFO band. (page 32)
- C# Same function as the UHF key on the transceiver. When the operating band is on the VHF side, transmit and operating bands are moved to the UHF side. (page 16) When the operating band is on the UHF side, changes the VFO band. (page 32)

### (6) Other functions

- CA Same function as pushing F and H/L simultaneously on the transceiver. Mutes the audio on the opposite band from that set to transmit. (page 37)
- CB Same function as pushing REV on the transceiver. Selects receive in reverse mode. (page 37)
- CD Same function as pushing F then PRIO on the transceiver. Starts/stops priority watch. (page 31)
- CC Cancels the command entered.

## Entering a frequency directly

Frequencies can be entered directly with the DTMF keys while in VFO mode.

### ■ Frequency input range (MHz)

Model	VHF	UHF
T	108.000	420.000 ~ 470.000*
	~ 137.995	
	138.000	
	~ 173.995	
E	144.000	430.000
	~ 145.995	~ 439.995

\*Any input out of this range may not function satisfactorily even if accepted.

### Note

- Frequencies can be entered within the band range of the currently displayed frequency.
- When not in VFO mode or when  is flashing, frequencies cannot be entered.

- ① Set the microphone **REMOTE/DTMF** switch to the **REMOTE** position.
- ② **DTMF** keys can be used to enter from the 100 MHz digit.  
(Ex.) When setting 144.20 MHz with the tuning step set to 20 kHz.

Enter ①④④②①①



After entering the sixth digit a slightly longer beep is emitted and the entry is complete.

## Canceling an entry before it is completed.

Push **PTT**.

Also, if more than 5 sec. elapse without a key entry, the frequency entry is canceled and the previous frequency is selected.



### Entry method depending on tuning step

Depending on the set tuning step, digit entry may be necessary to the 1 kHz digit. In some cases entry to the 10 kHz digit is sufficient. For cases in which digit entry is only necessary to the 10 kHz digit some digit keys are not accepted.

Tuning step	Final digit entry	Last digit entry method
5 kHz 10 kHz 15 kHz 20 kHz 30 kHz	1 kHz	When entering to the 1 kHz digit, push ⑤ to enter 5 kHz. Pushing any other digit key results in 0 kHz.
12.5 kHz	10 kHz	10 kHz digit entry automatically determines the 1 kHz digit. ①-00.0 ①-12.5 ②-25.0 ③-37.5 ④ invalid ⑤-50.0 ⑥-62.5 ⑦-75.0 ⑧-87.5 ⑨ invalid
25 kHz	10 kHz	10 kHz digit entry automatically determines the 1 kHz digit. ①-00.0 ②-25.0 ⑤-50.0 ⑦-75.0 Other keys are invalid.
50 kHz	10 kHz	10 kHz digit entry automatically determines the 1 kHz digit. ①-00.0 ⑤-50.0 Other keys are invalid.

## 2. External remote control

Using a DTMF equipped transceiver, remote control commands can be transmitted to this transceiver.

External remote control command table

Code	Operation
# 45	Starts accepting remote control commands
# 54	Ends accepting remote control commands
A	VFO frequency input
B	Changes the memory number
D1	Cross band repeater ON
D4	Cross band repeater OFF

### ■ Explanations of each external remote control command

The most recently received remote control command is stored in auto-dial memory 0. (page 60)

# 45 Starts accepting the external remote control operation. Additional remote control commands can be received on the same band for 5 min. only after this command is received. CT moves to opposite band of remote signal receive and command codes A, and B affect the band with CT.

#54 Ends the external remote control receive. After receiving # 45 and before 5 min. has elapsed this command ends remote control commands receive. Also, CT returns to the previous band.

A When the CT side (opposite band of remote signal receive) is in VFO mode, A allows direct frequency entry of up to 5 or 6 digits depending on tuning step (page 63). Digit entry is the same as when using the microphone DTMF keys (optional for the DR-610E). When not in VFO mode or when the frequency entered is not in the range of the current CT band, this command does not work.

B  
Specialty bank  
00 to 29  
banks A, B, C  
00 to 19  
When the CT side (opposite band of remote control signal receive) is in memory mode, the memory number can be changed. When not in memory mode or when the specified memory number is not programmed, this command does not work.

D1 Turns the cross band repeater function ON.

D4 Turns the crossband repeater OFF.



# Receiving remote control commands from another transceiver

## 1. Select external remote control receive mode

Push RC.

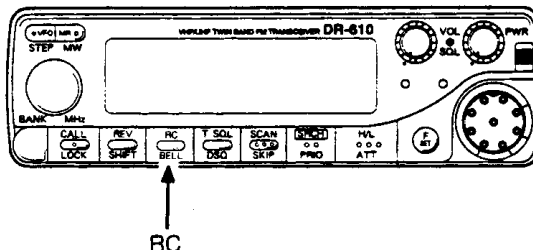

RC and the lowest Channel Scope indicators appear and external remote control receive mode is selected.

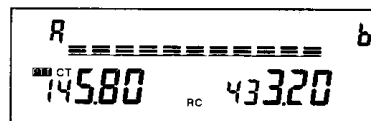

### Note

- When in external remote control receive mode the only keys that function are PTT, H/L, VHF and UHF. Crossband repeater on and off operation is possible (DR-610T).

**Cancel** Repeat the above operation.  
(RC and the Channel Scope indicators disappear.)

## 2. Receiving a remote control command

- ① Let the transceiver receive the start command.  
(Transmit DTMF # 4 5 using another transceiver.)

RC flashes and CT moves to the opposite band from which # 45 command was received.  
From this moment, external remote control commands are accepted for 5 min.

- ② While RC flashes (that is, for 5 min. after the start command is received) external remote control commands can be transmitted from another transceiver to this transceiver on the same frequency as the # 45 command frequency.

Command codes A and B are executed on the opposite band where CT is now indicated.  
Command codes D1 and D4 affect both sides, as they are crossband repeater commands.

- ③ 5 min. after the entry of # 45 command, or upon receiving # 54 command, external remote control acceptance is canceled.

RC stops flashing and CT returns to its previous band.

### Note

- Pressing a key on the radio or microphone will make the flashing RC to continuous display.

# 7

## Packet Operation

Packet operation is used for communicating data, rather than voice, using a personal computer, etc.

### ● Requirements for packet operation

- ① Antenna
- ② Regulated DC power source (for the DR-610)  
Regulated DC power source (for a TNC)
- ④ TNC (Terminal Node Controller)
- ⑤ Personal computer

### Note

- 2 power sources, one for the transceiver and one for the TNC, are required. Otherwise, noise between the transceiver, TNC and personal computer may cause interference.
- Confirm your frequency and your communicating partners frequency. You may have to try several times to make a connection.

This transceiver can communicate at 1200 bps or 9600 bps. Set-up is different depending on which speed you want to communicate at. Be sure to make the correct connections for the speed you want to communicate at.

### TXD (transmit data) input sensitivity

	Input impedance	Normal modulation input	Corresponding equipment
1200bps	2.7k $\Omega$	10mVp-p	Normal TNC or other appropriate data communications device
9600pbs	10k $\Omega$	2Vp-p	9600 bps modem/TNC

### Note

- If you exceed the optimum data input level (1200 bps, 10 mVp-p/9600 bps, 2Vp-p) the S/N ratio will worsen and distortion may result in data loss.
- When operating 9600 bps packet and your data input level exceeds approximately 3 Vp-p, the transceiver's limiter circuit may activate causing errors in transmission. In this case, turn the volume level on the TNC to its optimum level.

# 1. 1200 bps packet operation

## 1. Connecting equipment for packet operation

Connect the TNC, etc. to the microphone jack on the front of the transceiver and the speaker (SP2) jack on the rear of the transceiver.

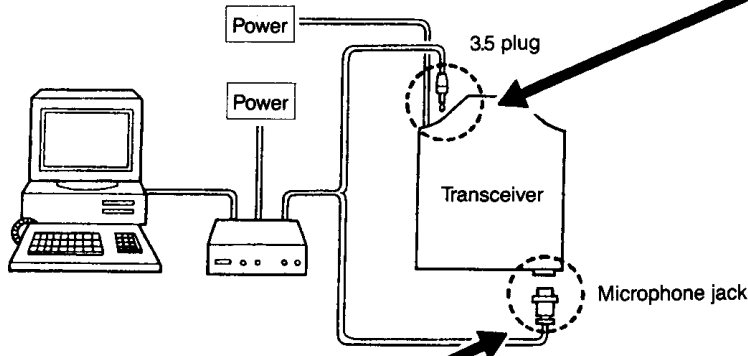

3.5φ plug

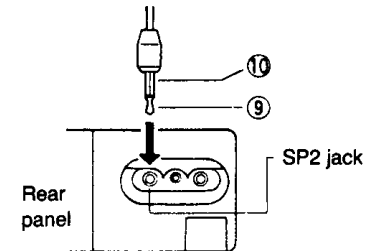

- ⑨ AFO (data output)  
After passing through the volume, receive signals are output.
- ⑩ GND (GND for AFO)

Microphone connector pin assignment

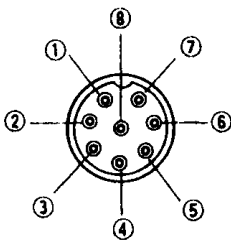

Set according to this diagram

- ① TXD (Transmit data input)  
Connects with the microphone output of the TNC
- ② PTT  
Connects with the PTT output  
Transmit occurs when pulled down to Lo.
- ③ NC
- ④ NC
- ⑤ NC
- ⑥ NC
- ⑦ DE (GND for TXD)  
GND for TNC output
- ⑧ GND (GND for PTT)

**Caution**

- Do not connect the NC pins.

## 2. Packet operation

**Caution**

- Before operation make sure that the 9600 bps mode indicator A is not flashing. (page 68)

- ① Choose the operating band with the BAND key (VHF or UHF).  
Move the PTT indicator to the operating band side.
- ② Rotate the SQL control until the squelch is just muted.
- ③ Adjust the VOL level for packet input.

## 2. 9600 bps packet operation

### 1. Connections for packet operation

#### Note

- When using G3RUH and K9NG type TNC's, depending on the manufacturer, output voltages may be low resulting in insufficient deviation. Check the output level before operation.

Connect your TNC to the data jack (center) and PTT jack (SP1) on the rear panel of the transceiver.

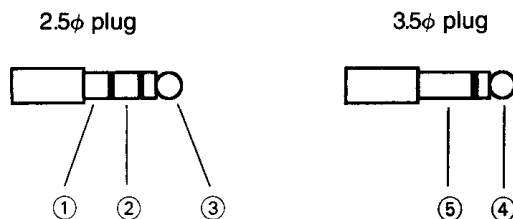
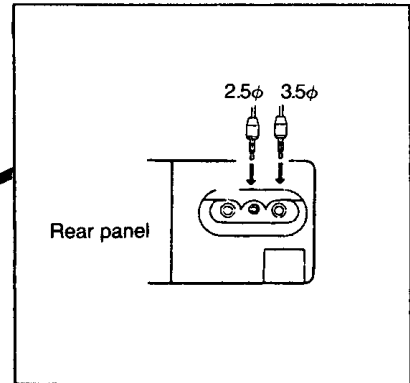
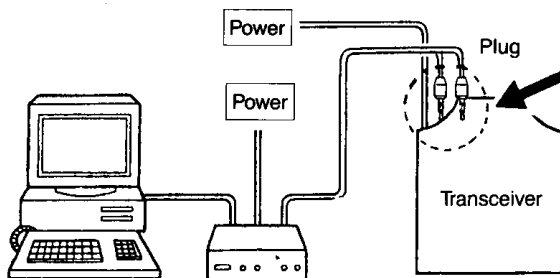

- ① DE (TX GND)  
Ground for TNC output
- ② PR9600 (9600 bps data output)  
Outputs FM signal detector (output level 300 mVp-p/47 k).
- ③ TXD (transmit data input)  
Connects with the TNC MIC output.
- ④ PTT  
Connects the PTT output ("L" transmits)
- ⑤ GND (GND for PTT)

### 2. Packet operation

#### Caution

- To stop packet operation and return to normal operation, make sure the A icon is erased first.

- ① While pushing (F) push RC.

A flashes on the UHF side.  
Repeat this operation to erase the A icon.

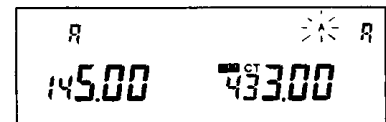

- ② Select the operating band with the BAND key (VHF or UHF).  
PTT moves to the operating band side.
- ③ The SQL and VOL controls have no effect on receive data output. Set their positions to the most desirable for monitoring operation.

#### Note

- External remote control/crossband repeater modes cannot be entered during 9600 bps packet mode. 9600 bps packet mode cannot be entered during external remote control/crossband repeater modes.
- The PTT control through the rear jack is solely for packet use only, and may not exhibit the same characteristics as the microphone PTT.
- The rear PTT control is enabled only when the radio is put into 9600 bps packet mode.

## ● Troubleshooting

When the transceiver appears to be malfunctioning, check the points listed in the table below. In many cases resetting the transceiver's CPU will solve the problem (page 47). If the problem still persists, the transceiver may be in need of servicing.

Problem	Possible cause	Solution
Power is turned ON but nothing appears in the display.	<ul style="list-style-type: none"> <li>a. Power has been connected with reverse polarity.</li> <li>b. Fuse is blown.</li> <li>c. The cable for front control panel is not connected properly.</li> </ul>	<ul style="list-style-type: none"> <li>a. Connect the supplied DC cord correctly. The plus (+) terminal is red and the negative terminal (-) is black.</li> <li>b. Check for the cause of the blown fuse and remedy it; then replace the fuse with a new rated fuse. *1</li> <li>c. Connect the cable for front control panel properly. (page 72)</li> </ul>
The display appears dark.	<ul style="list-style-type: none"> <li>a. Voltage is too low.</li> <li>b. Display backlighting is set to the dark setting.</li> </ul>	<ul style="list-style-type: none"> <li>a. The connected voltage should be 13.8 V DC.</li> <li>b. Set the display backlighting to the bright (2) setting. (page 42)</li> </ul>
No sound comes from the speaker and receiving is not possible.	<ul style="list-style-type: none"> <li>a. VOL control is turned too far counterclockwise.</li> <li>b. Squelch is muted.</li> <li>c. Tone squelch is activated.</li> <li>d. DTMF squelch (DSQ) is activated.</li> <li>e. The microphone PTT switch is pushed and the transceiver is in transmit.</li> <li>f. S-meter squelch is activated.</li> <li>g. Sub band mute is activated.</li> <li>h. The transceiver's speaker is turned OFF.</li> </ul>	<ul style="list-style-type: none"> <li>a. Set the VOL control to obtain a suitable level of audio output.</li> <li>b. Rotate the SQL control counterclockwise.</li> <li>c. Set tone squelch operation OFF. (page 49)</li> <li>d. Set DTMF squelch operation OFF. (page 53)</li> <li>e. Release the PTT switch OFF as soon as possible.</li> <li>f. When you want to receive weak signals, turn the S-meter squelch function OFF. (page 45)</li> <li>g. Cancel the mute function. (page 39)</li> <li>h. When using the transceiver's speaker use set mode to set the speaker to ON (page 42) and make sure nothing is connected to the external speaker jack. (page 14)</li> </ul>
Keys or dials cannot be operated.	The key lock function (—○ appears) is activated.	Cancel the key lock function. (page 38)
Rotating the DIAL does not change the memory channel.	<ul style="list-style-type: none"> <li>a. No memories are programmed in the bank.</li> <li>b. CALL mode is selected.</li> </ul>	<ul style="list-style-type: none"> <li>a. Program memories. (page 21)</li> <li>b. Push MR to select memory mode. (page 21)</li> </ul>
Pushing the UP/DOWN keys does not change the frequency or memory channels.	<ul style="list-style-type: none"> <li>a. Monitor function is ON.</li> <li>b. CALL mode is selected.</li> </ul>	<ul style="list-style-type: none"> <li>a. Turn the monitor function OFF in set mode. (page 45)</li> <li>b. Select VFO or memory mode. (page 18)</li> </ul>

continued to page 70

Problem	Possible cause	Solution
PTT is pushed but transmit does not occur.	a. Microphone is not connected properly. b. Antenna is not connected.	a. Make sure the microphone is connected properly. (page 14) b. Make sure the antenna is connected. (page 14)
Programmed scan does not function.	Scan edges are not programmed properly.	Make sure that V/U specialty bank memories PH and PL are programmed properly. (page 30)
Channel Scope does not function.	a. CALL mode is selected. b. A skip memory or memory C, PH or PL is selected. c. Scope size is not set to 5 signals. (for V/U simultaneous scope operation.)	a. Select VFO or memory mode. (page 18) b. Select (program) a different memory channel. (page 20) c. When operating the Channel Scope simultaneously on both bands, the size must be set to 5 signals in set mode. (page 43)
Packet operation does not function very well.	a. Set up for 1200/9600 bps has not been done properly. b. Other station's frequency is different or has drifted. c. Modulation level is not set properly. d. Multipath distortion.	a. Make sure everything is set properly according to the instructions on pages 67 - 68. b. Adjust your frequency. c. Refer to your TNC instruction manual and adjust the modulation output level. d. Adjust the direction of your antenna.
When PTT is pushed transmit takes place but there is no modulation.	a. 9600 bps mode is set.	a. Cancel 9600 bps mode. (page 68)

\*Replacement fuses      When a new fuse quickly blows again, disconnect the power and consult your local dealer or service center.

\*A fuse with the specified rating must be used. The DC power cord fuse is 15 A.

When the receive signal frequencies are related as indicated below the result may be the reception of an unmodulated signal. This is purely a result of the radio's frequency composition and does not mean there is a problem with the radio.

$$\left( \text{VHF band side} \begin{array}{l} \text{receive frequency} \\ - 45.1 \end{array} \right) \text{ multiple} - \left( \text{UHF band side} \begin{array}{l} \text{receive signal} \\ - 58.3 \end{array} \right) \text{ multiple} \cong 45.1 \text{ or } 58.3 \text{ MHz}$$

Avoid receiving frequencies which are 3rd multiples of the transmit frequency, as you might hear your own transmission.

Ex. Transmit frequency is 145.000 MHz Receive frequency is 435.000 MHz

# ● Installing options

In order to enjoy all of the functions of this transceiver, optional accessories are made available. Be sure to read the following instructions when installing options to avoid possible damage to the transceiver. When installing options make sure the power is disconnected.

## Tone squelch (CTCSS) unit (EJ-24U)

1. Turn the power switch (PWR) OFF and disconnect the power cord. (In the case of fixed station use, turn the regulated source of DC power OFF.)
2. Remove the 4 screws on the top of the transceiver case, then remove the top of the case.

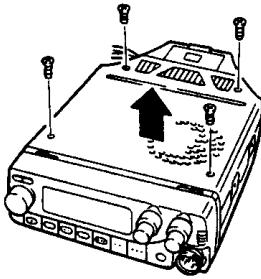

3. Locate the ENC unit connected to the left and remove it. panel and remove it.

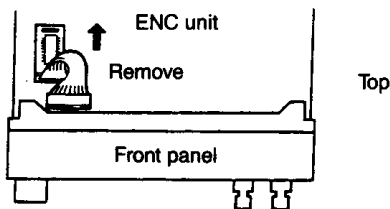

4. Connect the EJ-24U to where the ENC unit was connected. (Connect so that the red wire is on the right side when looking from the front panel.)

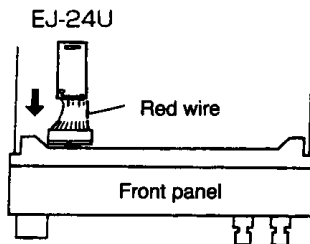

5. Reattach the top case and 4 screws.

## Memory unit (EJ-23U)

2. Turn the transceiver upside down and remove the 4 screws and the bottom case.

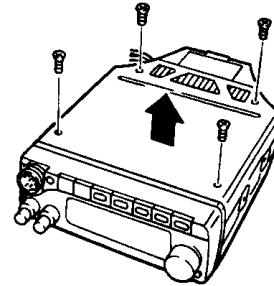

3. Locate the connector on the right side.

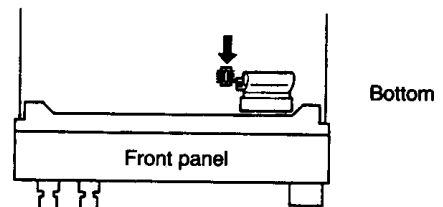

4. Connect the EJ-23U to the connector.

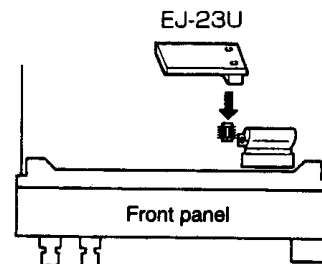

5. Reattach the bottom case and the 4 screws.

## Panel separation kit (EDS-1/2/3)

### Connections

#### EDS-2/3 connection

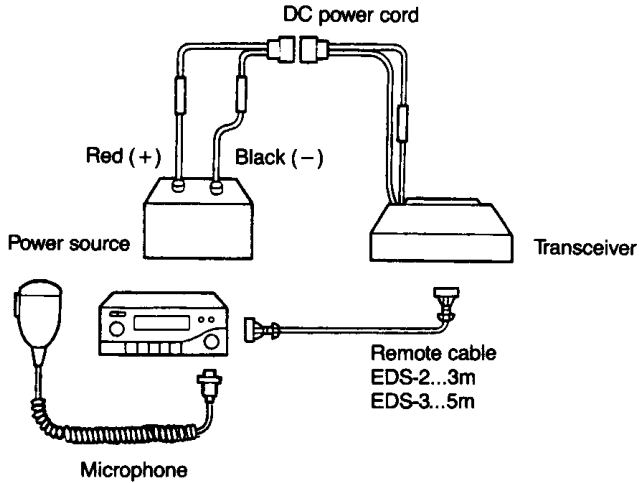

#### EDS-1/2/3 connection

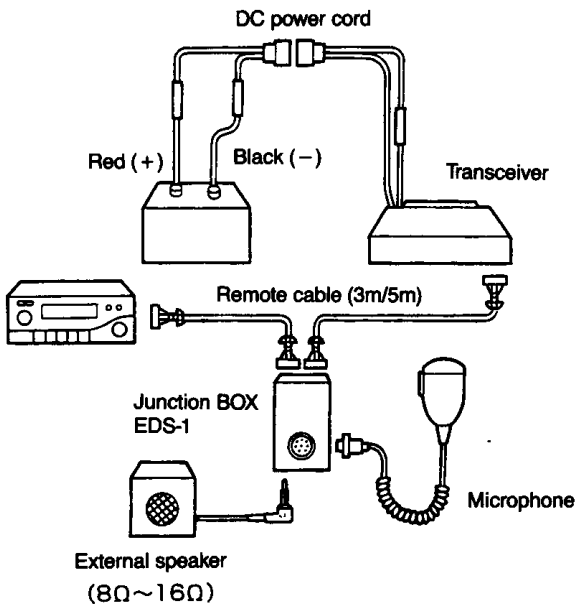

#### Connection notes

- When connecting the junction BOX (EDS-1) to the remote cable make sure that the transceiver side and panel side are not mixed up.
- The microphone can be connected directly to the front panel. (Do not connect both to the junction BOX and to the front panel.)

### Removing the front panel

1. Turn the power switch (PWR) OFF and remove the power cable.  
(In the case of fixed station operation turn OFF the regulated DC power source.)
2. While carefully holding the front panel, slide the panel release latches (OPEN) on the top of the panel to their outside positions.

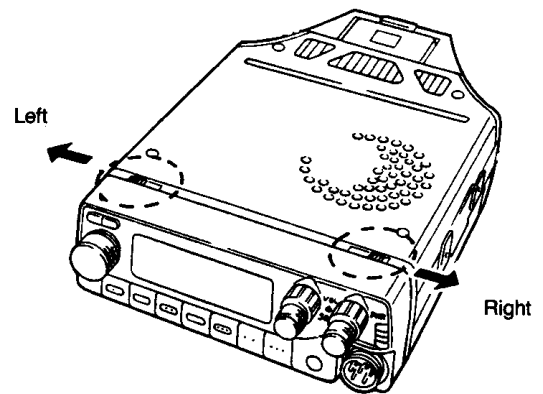

\*Make sure that the front panel is well supported when sliding the latches so that it doesn't fall.

3. While keeping the latches outwards slowly pull the front panel towards you to separate it.

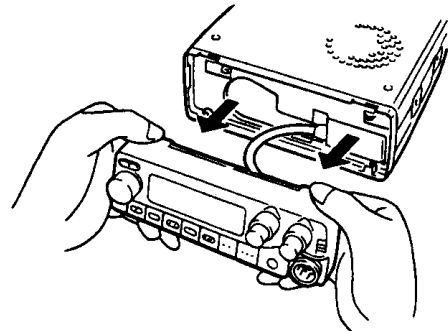

When reattaching the front panel to the transceiver, refit the bottom side first, then, make sure the release latches click into place so the front panel is securely attached to the transceiver.



## Attaching the front panel bracket (EBC-8)

Rear of the front panel

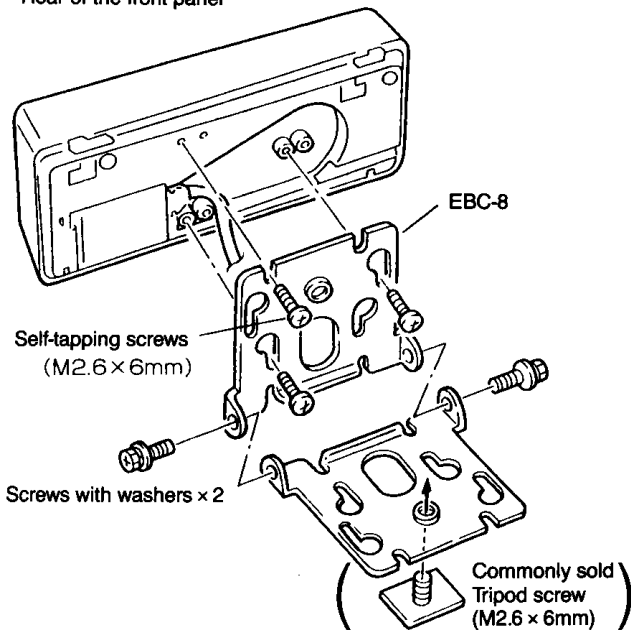

1. Fix the separation cable to the front panel.  
Fix the 3 self-tapping screws to the panel.

### Notes

- When using screws other than those specified, damage to the front panel may result. Be careful of the length of screws used.
2. Fix the front panel to your vehicle.  
Decide on a location for the front panel. Take into account all cable lengths and the position of the transceiver.
  3. Use the supplied double-sided tape, and first attach to the front panel and then to the desired location in your vehicle. (Choose a stable, level location.) Before attaching, make sure the location is clean and free of oil.
  4. The separation plate can be alternatively connected to a flexible tripod commonly sold in market.
  5. Using the supplied screws attach to your vehicle.

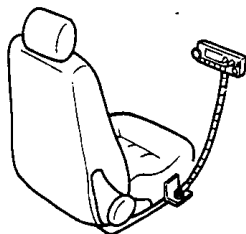

## Attaching a separation cable

### ▼ Transceiver side

- ① Open the lid from the OPEN side.
- ② Tug the base of the cable connector to remove it.
- ③ Attach the separation cable connector.
- ④ Close the lid being sure not to pinch the ends of the cable.

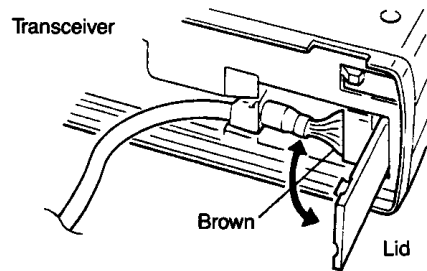

Connect so that the brown lead is attached to the bottom side of the transceiver.

### ▼ Front panel side

- ① Open the lid from the OPEN side.
- ② Tug the base of the cable connector to remove it.
- ③ Attach the separation cable connector.
- ④ Close the lid being sure not to pinch the ends of the cable.

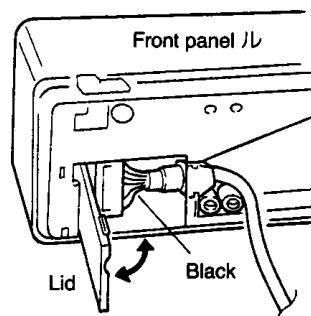

Attach the connector so that the black lead is on the bottom side.

### Caution

- Do not lift the front panel by holding the cable only.

## JUNCTION BOX (EDS-1)

### Connection

1. Remove the 2 screws as illustrated.

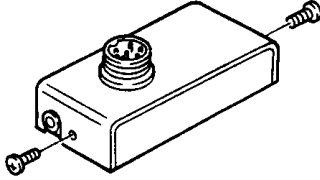

2. Remove the cover.

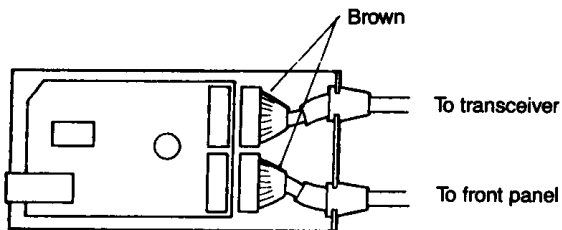

3. Attach the separation cable.

- ① Attach the separation cable to the connector.

Attach the connectors coming from the front panel and transceiver as illustrated in the diagram, making sure that the brown leads are oriented as in the diagram.

- ② Secure the cable bushings by snapping them into the slots on the junction box.

4. Replace the cover with the 2 screws.

5. Connect the speaker into place, if desired.

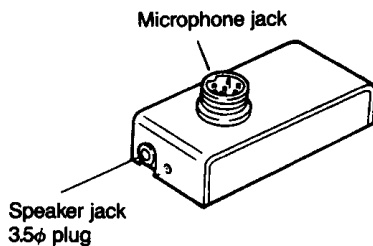

### Attachment method-1

- ① Detach the 4 metal attachment screws.

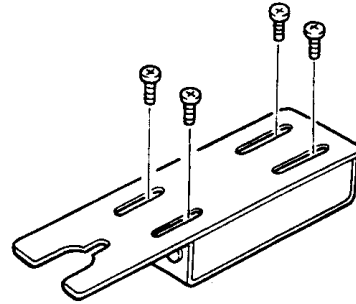

- ② Using the supplied double-sided tape attach the relay box to the desired flat location, making sure the location is free of dirt and oil.

### Attachment method-2

(Ex. attaching to a bucket seat bolt)

- ① Loosen the 4 metal attachment screws.
- ② Loosen the bucket seat bolt and sandwich the bracket into the desired position.

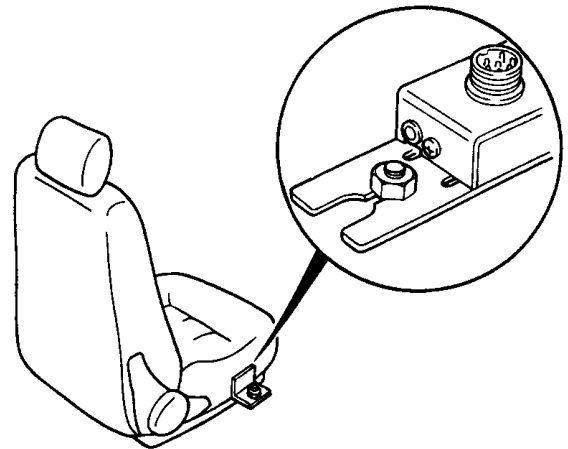

- ③ Tighten the bracket screws and once again tighten the bucket seat bolt sandwiching the tab of the EDS-1 firmly into place.

## DTMF equipped microphone (EMS-12)

This is standard for the DR-610T.

Attach the microphone connector to the transceiver or to JUNCTION BOX EDS-1 (optional).

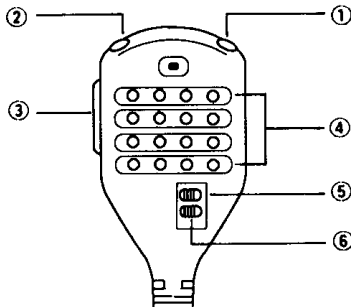

- ① ② UP/DOWN keys  
Functions in the same way as the supplied microphone UP/DOWN keys. Allows you to change the frequency and memory channels.
- ③ PTT  
Functions in the same way as the supplied microphone PTT. While pushing PTT, transmit occurs on the band in which PTT appears.
- ④ DTMF keys  
Provide remote control functions and allow frequency input. Can also be used to transmit DTMF codes directly.
- ⑤ Lock switch  
When in the lock position, the microphone UP/DOWN keys and DTMF keys do not function.
- ⑥ REMOTE/DTMF switch  
When not wanting to access the microphone remote control functions, set to the DTMF position. When in the DTMF position, DTMF keys only function to send DTMF signals by pressing the keyboard directly while transmitting.

## ALINCO, INC.

Head office: "TWIN 21" MID Tower Building 23F  
1-61, 2-Chome, Shiromi, Chuo-ku, Osaka 540 Japan  
Phone: 06-946-8150 Fax: 06-946-8175 Telex: 63086  
E-mail: 101243.1446@compuserve.com  
U.S.A.: 438 Amapola Ave., Suite 130, Torrance, CA 90501-6201, U.S.A.  
Phone: 310-618-8616 Fax: 310-618-8758  
<http://www.alinco.com/>  
Germany: Eschborner Landstrasse 55, 60489 Frankfurt am Main, Germany  
Phone: 069-786018 Fax: 069-789-60766