

RADIO FACSIMILE TERMINAL

MODEL WX-1000

INSTRUCTION MANUAL



AOR, LTD.

2-6-4 Misuji Taito-Ku, Tokyo 111 Japan
Tel 81/3-865-1681 Fax 81/3-865-1697

TABLE OF CONTENTS

1. SCOPE	1
2. GENERAL	1
3. PRELIMINARY INSPECTION	1
4. CONTROLS, INDICATORS AND CONNECTORS	2
5. INSTALLATION AND PREPARATION	6
5.1 LOCATION	6
5.2 THERMAL PAPER INSTALLATION AND HANDLING PRECAUTION	6
5.3 RECEIVER CONNECTION	7
5.4 POWER CONNECTION	8
6. BASIC OPERATION	8
6.1 WEATHER FACSIMILE OVERVIEW	8
6.2 SHORT-WAVE WEATHER FACSIMILE RECEPTION	10
6.3 SATELLITE FACSIMILE RECEPTION	11
6.4 OPERATING HINT	15
7. POWER SUPPLY DETAILS	17
8. SHORT-WAVE WEATHER FACSIMILE FREQUENCY LIST	19
9. SPECIFICATIONS	23

WARNING: This equipment generates, uses, and can radiate radio frequency energy and if not installed and used in accordance with the instructions manual, may cause interference to radio communications. It has been tested and found to comply with the limits for a Class A computing device pursuant to Subpart J of Part 15 of FCC Rules, which are designed to provide reasonable protection against such interference when operated in a commercial environment. Operation of this equipment in a residential area is likely to cause interference in which case the user at his own expense will be required to take whatever measures may be required to correct the interference.

(C) 1989 AOR, LTD. Tokyo Japan
(C) 1989 ACE Communications, Inc. El Toro, CA USA.

All rights reserved.

1. SCOPE

This manual provides general information on installation and operation of the WX-1000 radio facsimile terminal. Technical information on the theory of operation, hardware description, trouble-shooting are available in the optional WX-1000 TECHNICAL MANUAL.

2. GENERAL

The WX-1000 is a stand alone radio facsimile terminal designed to produce image from various radio facsimile services.

It produces weather chart, news and even photo taken by weather satellite.

The WX-1000 requires audio signal from short-wave receiver or S-band receiver with SSB or WFM mode.

A built-in high resolution 24-pin thermal printer produce sharp and clear image. It is also capable of producing simulated gray color to receive press photo or satellite photo.

The WX-1000 provides full controls such as Automatic start and stop, Fine adjustment for both position and speed, Tuning LED, Monitor circuit, etc. for operating convenience.

3. PRELIMINARY INSPECTIONS

Upon receipt of the WX-1000, inspect equipment for possible damage during shipment. Check accessories supplied with the unit.

* * * * SUPPLIED ACCESSORIES * * * *

QTY.	ITEM	DESCRIPTION
1	AC POWER CORD	Furnished with AC plug and matching connector.
1	DC POWER CORD	Black/Red twin cord with matching DC plug.
1	SPARE FUSE	2.0A Fuse for DC , 1.0A Fuse for AC operation.
4	BRACKET	Mount WX-1000 on a wall.
4	SCREW	Attach bracket to WX-1000.
1	AF PLUG	Matching plug to furnish input cable.
1	THERMAL PAPER	Thermal paper roll.
1	INSTRUCTION BOOK	

4. CONTROLS, INDICATORS AND CONNECTORS

FRONT PANEL

Location of the control, indicator and connector are showing in Figure 1.

<u>NAME</u>	<u>DRAWING #</u>	<u>FUNCTION</u>
POWER	(21)	Main power switch. Push this switch to turn on the WX-1000. Push this switch again to turn it off.
START/STOP	(19)	Start/Stop switch. Push this switch to start/stop the WX-1000 during the middle of transmission. If the WX-1000 does not start/stop automatically, use this switch to start/stop the reception. This happens when the receiving signal is weak or it does not contain start/stop signal.
MANUAL START	(20)	Manual start switch. If the MANUAL/AUTO switch (12) is set to MANUAL position, use this switch to stop reception.
PAPER FEED	(22)	Paper feed knob. This knob feed and advance the thermal paper roll in the unit.
PAPER RELEASE	(23)	Paper release lever. This lever adjust the pressure of the friction roller against paper guide rollers. Move this lever back to release the paper and forward to set it.
POSI/NEGA	(14)	Positive/Negative polarity switch. This switch selects the polarity (where the picture should be printed as a negative or positive).

- BLACK/WHITE** (13) **Black/White synchronization switch.**
 This switch selects synchronization type. (whether the WX-1000 should be synchronized to a Black signal or a White signal).
- MANUAL/AUTO** (12) **Manual / Auto reception select switch.**
 This switch selects Manual or Automatic reception.
- 2/16** (11) **Intensity level select switch.**
 This switch selects intensity level of the printing. For a hand drawn weather facsimile chart, set this switch to 2 to produce high contrast image.
 16 is for a reception of press photo and satellite photo where shading is required on print.
 If the received signal is strong enough, set this switch to 16 so that the WX-1000 can produce fine image.
- FM/AM** (10) **Mode select switch.**
 This switch selects the reception modulation type.
 Use FM for short-wave weather facsimile, and use AM for direct image service by weather satellite.
- 576/288** (9) **IOC value select switch.**
 These values are a height-to-width ratio and it varies depending on facsimile service type.
- RPM ADJ.** (8) (18) **Rotation speed adjustment.**
 These switches compensates for any reasonable clock errors on transmission station. If the image is slanted, use one of these buttons for adjustment.
- [- -]** (17) **Position adjustment.**
 When the WX-1000 is started manually, it is not likely to be lined up properly on the paper. If this happens, use these buttons. Push once to move the image to left or right at 0.5mm increment.

- R.P.M. (7) Facsimile speed select switch.
This button selects the receiving speed. Typical short-wave weather facsimile uses 120 RPM.
- TUNING (16) Tuning LEDs.
These LEDs lights up when the signal is properly tuned.
- 60.90.120.240 (3) (4) Facsimile speed LED.
(5) (6) These LEDs shows the receiving speed. Use R.P.M.(7) button to select speed.
- RUN (1) System RUN indicator.
If this LED is on, unit is ready to synchronize to a facsimile signal. At the end of transmission, it goes off.
In manual control mode, it goes on when the MANUAL START switch (20) is depressed.
It goes off when the START/STOP switch (19) is depressed.

BACK PANEL

- MONI (2) Monitor level adjustment.
This volume controls monitor sound from the WX-1000. Clockwise rotation increase the level, and counter clockwise rotation decrease the level.
This control does not affect to anything for reproduced image from the unit. Set this volume to a comfortable audio level.
- POWER (3) Power jack.
Use only power code supplied with the unit.
- FUSE (1) Fuse holder.
Before connecting the WX-1000 to a power source, check the fuse in the fuse holder. Use 1A fuse for an AC (AC120V) operation. Use 2A fuse for a DC (DC13.8V) operation.

AF IN

(4) Audio input jack.

Use matching plug supplied with WX-1000 to furnish audio input cable.

Figure 1. WX-1000 Operating control location.

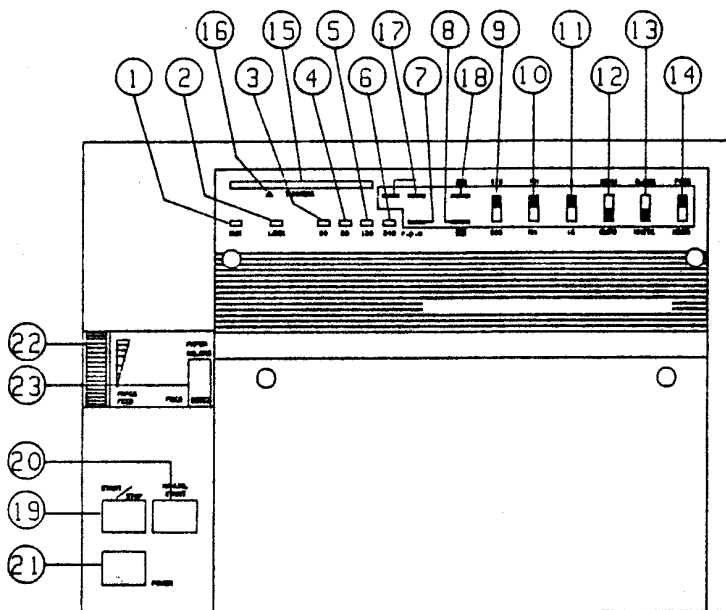

WX-1000 Back panel

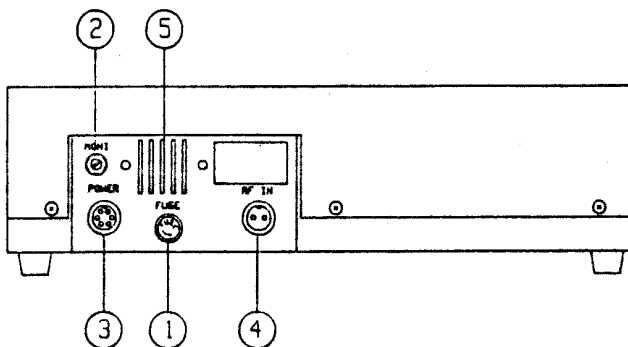

5. INSTALLATION AND PREPARATION

5.1 LOCATION

Regular home and office environments are enough for the unit. Avoid placing the unit near the window to prevent direct sunlight. For a wall mount, attach four wall mounting brackets to the bottom the unit by small screws provided.

5.2 THERMAL PAPER INSTALLATION AND THERMAL PAPER HANDLING PRECAUTION

The thermal paper is a heat-sensitive paper which changes color by thermochemical reaction. The paper is sensitive to heat, moisture and light. Store it in a cool, dry place before and after printing. To prevent the paper discoloring or turning brown, see the following precautions.

- a. Do not rub the paper with a hard object.
- b. To glue the paper, use a water solvent glue. Starch or composite glue is suitable.
- c. Do not let the paper remain contact with vinylchloride film.
- d. Do not let organic solvents touch the paper.

LOADING PAPER ROLL (Refer to Figure 2 for loading a paper roll.)

- a. Open the front cover of the WX-1000.
- b. Carefully lift the paper roll with the attached paper holders out of the unit.
- c. Cut protective cover and adhesive tabs loose from the paper roll. Cut off the first few inches of paper to get an even leading edge and to prevent adhesive from getting into the unit.
- d. Insert two paper holders as shown in the Figure 2, and re-insert the paper to the unit.
- e. Feed the paper against you (under the paper rollers) while turning the paper advance knob on the left side of the WX-1000 until the paper appears from the unit.
- f. If the paper does not come out straight, release the paper by paper release lever, and straighten it.
- g. Make sure that the paper release lever is on feed position.
- h. Close front cover.

Figure 2. Loading paper roll.

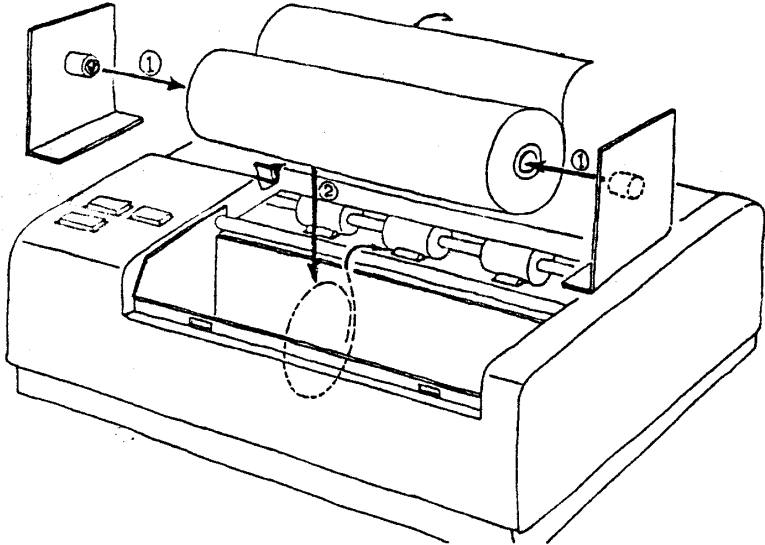

5.3 RECEIVER CONNECTION

Use 2-pin connector supplied with the unit to make receiver cable.
Use shield cable between receiver and WX-1000.

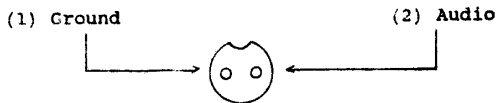

WX-1000 must be connected to the receiver's external speaker output (not the recorder output) as the WX-1000 requires level adjustments.

If the receiver provides either headphone or earphone output, use one of the output for WX-1000.

To operate this unit properly, set the receiver's volume control to a medium audio level (9 to 10 o'clock position) which is approximately 150mV R.M.S. into 600-ohm. The ham radio receiver or upper class short-wave receiver is necessary to produce quality image.

5.4 POWER CONNECTIONS

Before applying power source to the WX-1000, make sure that the proper fuse has been installed. 1A fuse is for AC operation and 2A fuse is for DC operation. Use well regulated DC 12 to 16V power source which is capable of supplying at least 2A.

Use DC power cord (Black/Red twin cord) supplied with the unit. If accidentally invert the power cable, the fuse will open to protect the unit from reverse-voltage damage. If this occurs, replace the fuse with an identical 2A unit.

6. BASIC OPERATION

6.1 WEATHER FACSIMILE SERVICE OVERVIEW

Following chapter describes outline of weather facsimile service available for public. These radio signals are reasonably strong and easy to receive for the beginners.

If the following services are unable to receive, try some other stations listed in chapter 8.

Details of the operation are described in the chapter 6.2 (following section).

Facsimile transmission schedule, operating frequencies are changed occasionally so you must check updated frequency and schedules. These informations are available from various publications, or write to the local weather bureau. Schedule of transmissions are 24 hours format in GMT (Greenwich Meantime), so you must convert GMT to your local time.

NOAA

NOAA (National Oceanic and Atmospheric Administration / Dept. of Commerce) Weather Service sends weather information via US. Coast Guard transmitter site. The broadcasting schedule contains numerous weather satellite pictures taken by GOES (Geostationary Environmental Satellite). Schedule of broadcasting may be obtained from each weather service center.

Call sign : NMC
Station : National Weather Service - San Francisco, CA
Address : 666 Price Avenue, Redwood City, CA 94063

Operating Frequencies:		WX-1000 Setting
4346	kHz Night Time Only	Speed : 120 RPM.
8682	kHz 0145 to 2345 Z	IOC : 576
12730	kHz 0145 to 2345 Z	Mode : FM
17151.2	kHz Day Time Only	

Call sign : NOJ
Station : National Weather Service - Anchorage, AK
Address : Box 37 USCG Base, Kodiak, AK 99619

Operating Frequencies:		WX-1000 Setting
4298	kHz 0400 to 2200 Z	Speed : 120 RPM.
8459	kHz 0400 to 2200 Z	IOC : 576
		Mode : FM

NFAX

The U.S. Naval Oceanography Center, transmits weather information by radio facsimile for the use of United States naval vessels and stations, and the ships of the Military Sealift Command. Although designed for Navy use, many of the transmitted charts are used by private and commercial marine interests.

Call sign : NAM
Station : Naval Eastern Oceanography Center, Norfolk, Virginia

Operating Frequencies:		WX-1000 Setting
4346	kHz Night Time Only	Speed : 120 RPM.
8682	kHz 0145 to 2345 Z	IOC : 576
12730	kHz 0145 to 2345 Z	Mode : FM
17151.2	kHz Day Time Only	

Call sign : NPM
 Station : Naval Western Oceanography Center, Pearl Harbor, Hawaii
 Address : Box 133, Pearl Harbor, HI 96860-5050

Operating Frequencies:			WX-1000 Setting
2122	kHz	0600 to 1600 Z	Speed : 120 RPM.
4855	kHz	Continuous	IOC : 576
9396	kHz	Continuous	Mode : FM
14826	kHz	Continuous	
21837	kHz	1700 to 0630 Z	

Call sign : NPN
 Station : Naval Oceanography center, Guam
 Address : Naval Oceanography Command Center,
 Box 12 FPO San Francisco, CA 96630

Operating Frequencies:			WX-1000 Setting
4975	kHz	Continuous	Speed : 120 RPM.
7894	kHz	Continuous	IOC : 576
10255	kHz	Continuous	Mode : FM
19860	kHz	Continuous	
23064	kHz	Continuous	

It is important that unannounced changes may occur in GFAK scheduling when it become necessary to meet requirements of the U.S. Navy fleet in the pacific.

6.2 SHORT-WAVE WEATHER FACSIMILE RECEPTION

AUTOMATIC START / STOP

- a. Tune receiver frequency to the facsimile service. Set receiver to a USB (Upper Side Band) mode.
- b. Set the WX-1000 controls as follows.

CONTROL	SETTING	DRAWING #
-----	-----	-----
RPM	120	(7) (5)
POSI/NEGA	POSI	(14)
BLACK/WHITE	WHITE	(13)
AUTO/MANUAL	AUTO	(12)
2/16	2	(11)
576/288	576	(9)
AM/FM	FM	(10)

If the receiving station is other than one listed in the previous chapter, change the settings accordingly to the list in this manual (Chapter 8).

- c. At the carrier signal of the station (in between the unit of facsimile transmission), lower the receiving frequency by receiver's dial until tuning LED light-up as follows.

Left Right



3rd & 4th LED must be lighted up while receiving station carrier. (no modulation)

- d. Wait until the station sends the start signal. Start signal is a modulated 300 Hz tone and it is transmitted for 5 seconds.

If the WX-1000 receives this start signal, RUN will be lighted.

If you try several times and still unable to start the WX-1000, increase the receiver's audio level slightly and try it again.

- e. If the WX-1000 detects the start signal, it waits for phasing signal.

Phasing signal consists of black signal interrupted by one second white phasing pulse per revolution of the drum and it will be transmitted at least thirty seconds prior to the transmission of each weather chart.

If the WX-1000 detects the phasing signal, LOCK will be lighted.

- f. If both RUN and LOCK LEDs are lighted up, the WX-1000 will start printing the chart.

- g. At the end of transmission, WX-1000 will automatically stop printing by detecting stop signal. The stop signal consists of carrier modulated by 450 Hz for 5 seconds

- h. If the WX-1000 does not stop printing, or if you wish to stop printing during the middle of transmission, push START/STOP (19) switch.

- i. As long as you are on Automatic Mode, and the receiving signal is strong, the WX-1000 will continue to operate automatically.

RECEIVING SATELLITE PHOTO OR FINE IMAGE PRINTS

The WX-1000 is capable of producing simulated gray scale. This feature is useful to produce satellite photo or when fine image print is required on weather chart.

- a. Change 2/16 switch (11) to 16 position.
- b. At the carrier signal of the station (in between the unit of facsimile transmission), lower the receiving frequency by receiver's dial until tuning LED light-up as follows.

Left  Right

^
|

1st LED must be lighted up while receiving station carrier. (no modulation)

- c. Follow the instruction described under AUTOMATIC START/STOP.

MANUAL START / STOP

- a. If you wish to start the WX-1000 during middle of transmission, set MANUAL/AUTO switch (12) to MANUAL position.
- b. Set BLACK/WHITE switch (13) to BLACK position.
- c. Push MANUAL START switch (20) to start printing.
- d. When the WX-1000 is started manually, it is not likely to be lined up properly on the paper. If this happens, use [- -] buttons (17) to move the image to left or right.
- e. If you operate [- -] buttons during reception, image moves only 0.5mm at a time. If large amount of movement is needed, push START/STOP switch (19), then push [- -] buttons. Image moves 5mm at a time if the WX-1000 is stopped. Push MANUAL START switch (20) again to continue the reception.

NOTE: Some weather facsimile broadcasts does not contain synchronization signal (Black signal) during chart transmission. If this is the case, WX-1000 cannot synchronize the signal. Use above (d) and (e) to correct images.

6.3 SATELLITE FACSIMILE RECEPTION

6.3.1 GENERAL

Although early Weather facsimile experiments involving image relay via geostationary satellites began in the early 70s using VHF transmissions, all current Weather facsimile service is now conducted on 1691 MHz. (plus 1694.5 MHz for the European METEOSAT spacecraft)

This requires the addition of some of the S-band microwave hardware to the station.

This manual does not cover the details of the receiver and the other microwave equipment for satellite image reception.

Consult your local dealer or write to us for further details for equipment selection.

6.3.2 GOES AND METEOSAT

GOES are series of geostationary environmental satellite currently in service. These satellite carries wide variety of image products, including weather charts, mosaics (Polar and Mercator) of polar orbit imagery, and samples of GOES imagery which are available for viewing. Over 100 images are contained in the GOES central daily schedule.

All images are transmitted on a fixed daily schedule, making it easy to plan the reception of a particular picture for interest.

The most interesting pictures for most experimenters are the images derived directly from the GOES spacecraft themselves.

METEOSAT is an European equivalent of US. GOES spacecraft.

There are numerous prints available for experimental satellite users, but the following prints describes both hard-ware and software for experimental satellite users.

WSH (Weather Satellite Handbook) - Third edition
Dr. Ralph E. Taggart
602 S. Jefferson,
Mason, MI 48854

6.3.3 WEATHER SATELLITE IMAGE RECEPTION

Receiver requirement : AOR model AR-3000 communication receiver.
 Frequency : 1691 MHz
 Mode : Wide band FM

Low noise amplifier

Parabolic or high gain loop yagi array.

WX-1000 Setting :

CONTROL	SETTING	DRAWING #
RPM	240	(7) (5)
POSI/NEGA	POSI	(14)
BLACK/WHITE	WHITE	(13)
AUTO/MANUAL	AUTO	(12)
2/16	16	(11)
576/288	288	(9)
AM/FM	AM	(10)

- a. It is important that the image quality from the WX-1000 depends on the audio level from the receiver. Adjust the receiver's volume control as follows.

At carrier only. (No picture transmission.)



6th and 7th LED must be lighted up while receiving station carrier.

At picture transmission.

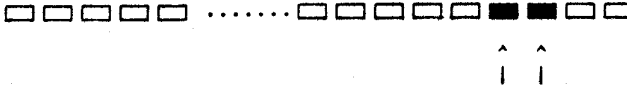

11th and 12th LED must be lighted up while receiving modulated signal.

6.4 OPERATING HINT

There are several factors you should consider to improve the image from the WX-1000. This chapter shows typical symptoms resulting from the receiver and control setting of the WX-1000.

SYNCHRONIZATION ERROR

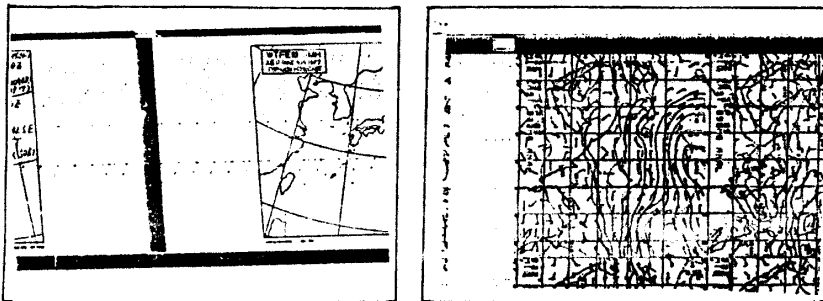

Synchronization error happens occasionally due to the following reason.

- a. BLACK/WHITE (Switch 13) must be on WHITE when you start reception by automatic mode. Otherwise the WX-1000 cannot detect white sync. in the phasing signal.
- b. Signal strength of the station is weak or signal is fading.
- c. Receiver tuning error.
- d. Audio level from the receiver is low.
- e. In manual mode, BLACK/WHITE (Switch 13) must be on BLACK position.
- f. Some weather chart transmissions does not contain black sync. Therefore, WX-1000 cannot synchronize during the middle of transmission.

POOR IMAGE QUALITY

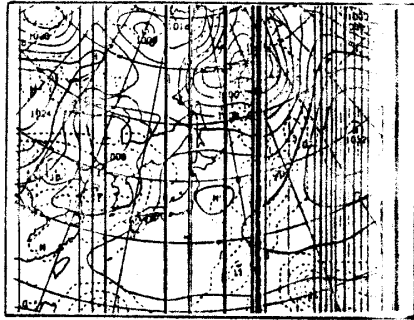

Picture quality from the WX-1000 totally depends on the signal quality delivered from the receiver. It is always suggested that you use an external antenna, or choose a stable frequency, particularly at night time.

- a. Facsimile reception requires better S/N on the circuit. Check your antenna system.
- b. Sometimes, home appliance, personal computer, TV game, machinery equipment can generate RF signal and can cause noisy print.
- c. Natural noise such as thunder, lightning from far distant area, natural discharge from the cloud can cause unacceptable noise source for the reception.

SPEED AND IOC ERROR

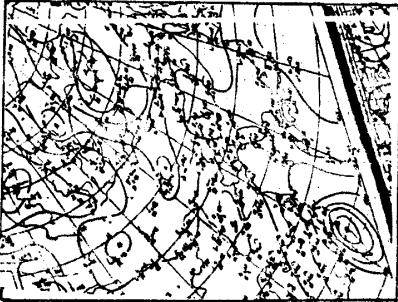

- a. If the receiving speed is different, or if the IOC value is different, the WX-1000 will produce overlapped print.
- b. If this happens, change the RPM (Switch 7) or the 576/288 (Switch 9) to correct the print.
- c. Check the IOC and speed for the station you wish to receive.

REVERSE PRINT

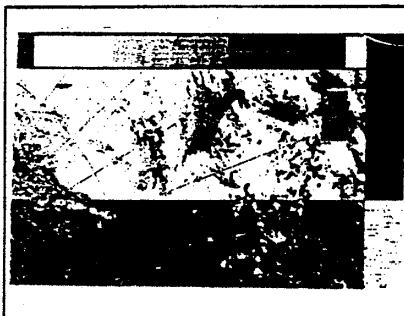
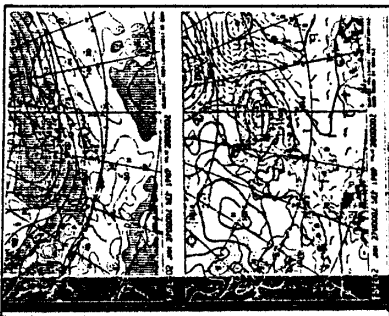

- a. The reversed print is caused by wrong setting of the POSI/NEGA (Switch 14).
- b. If the signal is tuned in by the Lower Side Band (LSB) instead of Upper Side Band (USB), WX-1000 produce reverse print.

7. POWER SUPPLY DETAIL

AC POWER SUPPLY

The WX-1000 is capable of operating other than standard 120 VAC power source. If power changes are needed follow the steps below.

- a. Disconnect AC plug from wall outlet. (Absolutely necessary.)
- b. Remove paper compartment cover and thermal paper roll.
- c. Remove screws from the front, back, left and right side of plastic case.
- d. Open top cover carefully.

- e. Power voltage change can be accomplished by changing connector which is wired to the transformer.
- f. Disconnect the 2P plug from the connector and reconnect it to the specific voltage required by you.
- g. Close the cover and tighten the screw.

POWER SUPPLY CONNECTOR

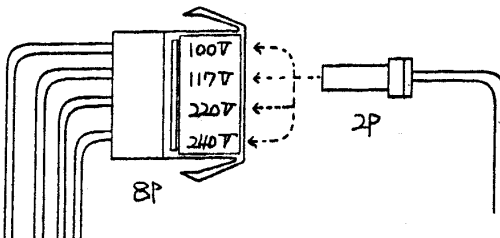

INPUT POWER CONNECTOR

The WX-1000 uses one connector for both AC and DC power source. Pin layout for the input power connector is as follows.

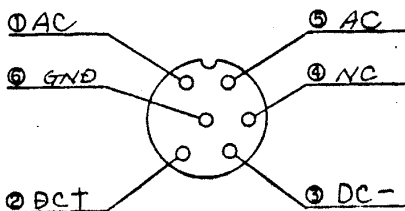

8. SHORT-WAVE WEATHER FACSIMILE FREQUENCY LIST

The following list summarizes major short-wave weather facsimile broadcasts available from meteorological agencies (weather bureau) in each country. Operating frequency will change occasionally, therefore, check the current frequency from time to time.

SHORT-WAVE WEATHER FACSIMILE FREQUENCY LIST

<u>Country</u>	<u>City</u>	<u>Call</u>	<u>Freq. (kHz)</u>	<u>RPM</u>	<u>IOC</u>
ARGENTINA	BUENOS AIRES	LR069	5,185.00	120	576
		LR072	10,720.00	120	576
		LR084	18,093.00	120	576
AUSTRALIA	CAMBERRA	AXM32	5,100.00	120	576
		AXM34	11,030.00	120	576
		AXM35	13,920.00	120	576
		AXM37	19,690.00	120	576
	DARWIN	AXI32	5,755.00	120	576
		AXI33	7,535.00	120	576
		AXI34	10,555.00	120	576
		AXI35	15,615.00	120	576
		AXI36	18,060.00	120	576
BRAZIL	BRASILIA	PPN9	10,225.00	120	576
		PPN9	18,080.00	120	576
	RIO DE JANEIRO	PWZ	12,025.00	120	576
		PWZ	17,140.00	120	576
BULGARIA	SOFIA	LZJ2	5,093.00	120	576
CANADA	ESGUIMALT	CKN	4,268.00	120	576
		CKN	6,946.00	120	576
	FROBISHER BAY	VFF	3,235.00	120	576
		VFF	7,710.00	120	576
	HALIFAX	CFH	4,271.00	120	576
		CFH	6,330.00	120	576
		CFH	10,536.00	120	576
		CFH	13,510.00	120	576
	RESOLUTE	VFR	3,253.00	120	576
		VFR	7,710.00	120	576
CHILE	BELLOTO	CCV6	4,766.00	120	576
		CCV6	6,418.00	120	576
		CCV6	8,594.00	120	576
		CCV6	13,525.00	120	576
		CCV6	22,071.00	120	576
	SANTIAGO	CCS	2,716.00	120	576
		CCS	2,886.00	120	576
		CCS	4,063.00	120	576
		CCS	6,418.00	120	576
		CCS	8,692.00	120	576

Country	City	Call	Freq. (kHz)	RPM	IOC
CHILE	SANTIAGO	CCS	8,776.00	120	576
		CCS	12,600.00	120	576
		CCS	13,525.00	120	576
		CCS	22,070.00	120	576
CHINA	BEIJING	BAF6	5,525.00	120	576
		BAF36	8,120.00	120	576
		BAF4	10,115.00	120	576
		BAF8	14,365.00	120	576
		BAF33	18,235.00	120	576
DENMARK	COPENHAGEN	OXT	5,850.00	120	576
		OXT	9,360.00	120	576
		OXT	13,855.00	120	576
		OXT	17,510.00	120	576
EGYPT	CAIRO	SUU36	4,526.00	120	576
		SUU2	10,123.00	120	576
ENGLAND	BRACKNELL	GFA24	11,086.50	120	576
		GFA25	14,582.50	120	576
		GFE25	2,618.50	120	288
		GFE21	4,782.00	120	576
		GFE22	9,203.00	120	576
		GFE23	14,436.00	120	576
		GFE24	18,261.00	120	576
		GFA21	3,289.50	120	288
		GFA22	4,610.00	120	288
		GFA23	8,040.00	120	576
	NORTHWOOD	GYA1	2,813.85	120	576
		GYA6	3,436.85	120	576
		GZZ2	4,247.85	120	576
		GZZ3	6,436.85	120	576
GZZ40	8,494.85	120	576		
FINLAND	HELSINKI	OFB28	8,018.00	120	576
FRANCE	PARIS	FTE4	4,047.50	120	576
		FT18/B	8,185.00	120	288
		FTM30	12,305.00	120	288
GERMANY	PINNEBERG	DDK3	7,880.00	120	576
		DDK6	13,882.50	120	576
	QUICKBORN	DDH3	3,855.00	120	288
GREECE	ATHENS	MGR	5,206.00	120	576
		MCR	8,100.00	120	576
		MGR	12,903.00	120	576
INDIA	NEW DELHI	ATP38	18,227.00	120	576
		ATP38	18,233.00	120	576
		ATA55	4,993.50	120	576

RADIO FACSIMILE TERMINAL WX 1000

STAND ALONE RADIO FACSIMILE TERMINAL FOR REMOTE IMAGE SENSING

ADR (UK) LTD.
WORKSHOP FILE COPY.

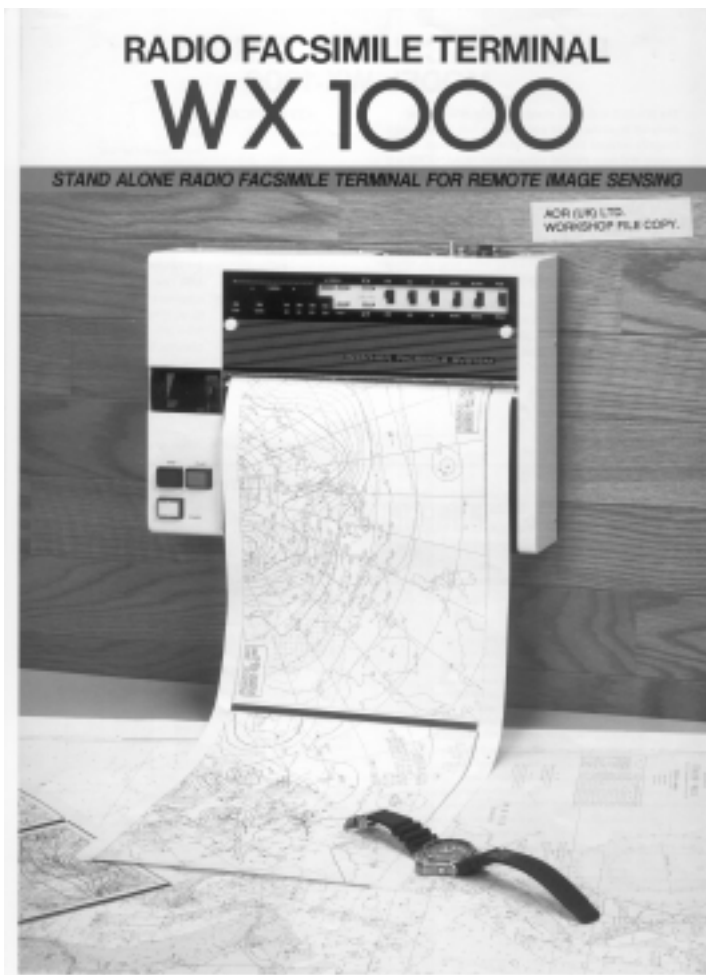

Paper requirement:

(TF50KS-E45)

TOSHIBA
WX 1000 + WR
感熱記録紙
Thermal Sensitive Paper

SIZE : 216mm×30m

CODE : 01456410

RADIO FACSIMILE TERMINAL MODEL WX-1000

The WX-1000 is a stand alone radio facsimile terminal designed to produce hard copy images from various radio facsimile services including Weather charts, Maps, news medias and even satellite pictures from NOAA, GOES and METEOR etc. The WX-1000 requires only audio signal from short-wave receiver or satellite receiver capable of receiving facsimile signals.

The built-in high resolution 24-pin thermal printer produces crisp images with high resolution. It is also capable of producing simulated gray color which is ideal for APT (Automatic Picture Transmission) by weather satellite.

In addition to the basic functions, the WX-1000 provides full operational controls such as Auto Start, Sync. Adjustment, Position Alignment, Tuning LED and etc. to produce highest quality images.

■ APPLICATIONS

- Short-wave weather broadcast
- APT images from Satellite
- News Media

■ SPECIFICATIONS

Model	WX-1000
Type	Radio Facsimile terminal
Printing method	Thermal Image
Printing density	6 dots per mm
Printing scale	2(B/W) or 16, selectable
Paper width	25.4 mm (10 inch)
Paper roll size	30m (100 foot)
Audio input	FM 1900 ± 400Hz /150mV AM 2400Hz /300mV
Auto start	APSS Type
Synchronization	Independent type
Reception speed	60, 90, 120 and 240 rpm, selectable
Collaboration factor	576 or 288
Position alignment	0.5mm increment
Rotation adjustment	1 rpm, increment
Power requirement	100/120/240 VAC or DC 13.8V
Power consumption	15VA
Dimension	350(W)×80(H)×250(D)mm

Specifications subject to change without notice.

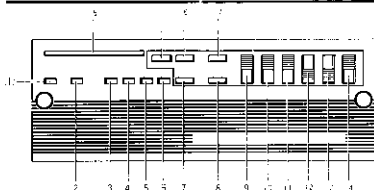

1. RUN	Reception start
2. LOCK	Lock Indicator
3. 60	Reception speed/60 rpm.
4. 90	Reception speed/90 rpm.
5. 120	Reception speed/120 rpm.
6. 240	Reception speed/240 rpm.
7. RPM	Reception speed select
8. RPM ADJ.	Reception speed adjustment
9. 228/676	Collaboration factor select
10. AM/FM	Receiving mode select
11. 2/16	Printing scale select
12. AUTO/MANU	Automatic/Manual receive select
13. BLACK/WHITE	Black/White synchronize select
14. POSI/NEGA	Positive/Negative picture select
15. TUNE	Synchronization Tuning LED
16. POSITION	Position alignment
17. RPM ADJ.	Reception speed adjustment

■ TYPICAL SYSTEM LAYOUT

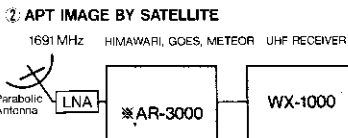
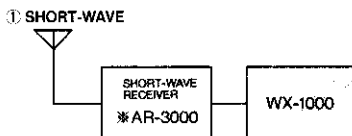

* AR-3000 General Coverage Wide Band Receiver