

CIRCUIT DESCRIPTION

Refer to the Schematic (fold-out from Page 43) and Block Diagram while reading the Circuit Description.

SCHEMATIC DIAGRAM

The letter-number designations on the Schematic Diagram are used to identify resistors, capacitors, and diodes. Each designation is related by the first number to the transistor stage in which it is used. For example, the resistors in transistor stage Q1 are designated R10, R11, etc. In transistor stage Q7 they are designated R70, R71, etc.

Letter-number designations using numbers 1 through 9 are not directly related to any transistor stage. This system of circuit component designations is used throughout the Schematic.

Circled letter designations on the Schematic Diagram indicate wire connecting locations on the circuit board.

POWER SUPPLY

With slide switch S3 in the Operate or Hold position, the AC line voltage is applied across the primary winding of power transformer T1. Resistor R8 drops the line voltage that is applied to the neon pilot lamp, which indicates

when the Keyer is on. The fuse provides protection in case of a short circuit.

The output of power transformer T1 is rectified by silicon diode D2 and filtered by capacitor C2 to produce a positive (+) 19 volts DC. Silicon diode D3 and a filter network consisting of capacitors C3 and C4 and resistor R9 provides a negative (-) 16 volts DC. These voltages are the operating and bias voltages for the transistor stages.

KEY SWITCHING

The key lever is moved in one direction or the other to actuate switch S1 or S2. Switch S1 turns on the dot generator multivibrator circuit to produce dots. Switch S2 turns on the flip-flop and the dot generator multivibrators to produce dashes. The operation of these circuits will be explained later.

DOTS

Dot Clamp Circuit

When the key lever is in the center (neutral) position, a positive voltage is present at the base of dot clamp transistor Q3. This voltage which is applied from the power supply through resistors R1, R5, and R6, biases Q3 in an on

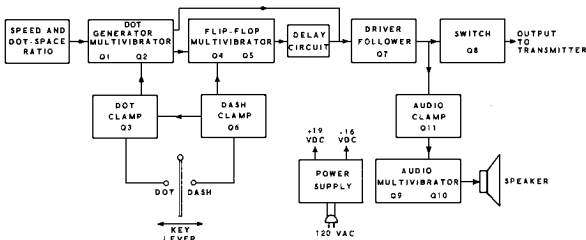

BLOCK DIAGRAM

condition (conducting). When Q3 is on, a positive voltage is applied to the base of Q2, one of the dot generator multivibrator transistors, keeping it turned off (not conducting).

When the key lever is moved to the dot position, switch S1 closes. This removes the positive supply voltage present at the base of Q3 by directing it to ground through resistor R6. A negative supply voltage from the voltage divider consisting of resistors R1, R2, and R5, is applied to the base of transistor Q3. The negative voltage at the base turns Q3 off. This removes the positive bias voltage at the base of transistor Q2. Diode D30 isolates Q3 from Q2.

DOT GENERATOR MULTIVIBRATOR

Transistors Q1 and Q2 and their associated circuitry make up the basic timing dot generator which is a free running multivibrator. Capacitors C10 and C20 with Speed control R11 and R21 control the switching speed of the multivibrator. Control R21 (screwdriver adjust) is adjusted so that the spaces are the same length in duration as the dots. Since the dot and space ratio must be maintained for all settings of the Speed control, the two sections of the control are clutched. Turning the Speed knob turns both sections of the control a like amount without changing the space and dot duration ratio.

The positive bias voltage from Q3 that is present at the base of Q2, keeps the dot generator multivibrator turned off. In the off condition, Q2 will not conduct or allow current to flow through it. This allows the full negative supply voltage to be present at its collector by way of resistor R20. However, transistor Q1 has a negative voltage (with respect to the emitter) present at its base through resistors R12, R21, and R22. This causes Q1 to conduct to a saturated condition. Therefore, its collector voltage is practically zero or very near ground potential.

As the positive bias voltage is removed from the base of Q2, it immediately starts to conduct. Its collector voltage instantly becomes less negative (more positive) as shown at point T0 in Figure 10. (T0 is at the start of the first dot; T1 is at the start of the following space.)

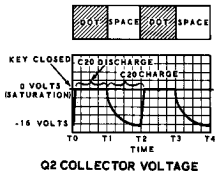

Q2 COLLECTOR VOLTAGE

Figure 10

This positive rise is coupled through capacitor C20 to the base of Q1. This drives the base of Q1 to collector cutoff. With the collector current of Q1 cutoff, the collector voltage increases to its maximum (most negative) potential. Instantaneously the Q2 collector current reaches its maximum (saturation). The result is to turn transistor Q2 fully on and Q1 off.

Although this on and off (switching) action is fast, it is not repeated instantly, since the voltage across C10 requires time to change. When the collector voltage of Q1 goes more negative, capacitor C10 must charge to this higher collector voltage. The charge path is through the base of conducting transistor Q2 and through collector load resistor R10. The collector voltage of Q1 will rise with a slight rounding off. This is shown between points T0 and T1 on the leading curved line in Figure 11.

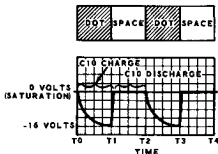

Q1 COLLECTOR VOLTAGE

Figure 11

Although Q1 is now off and Q2 is on, the circuit cannot remain in this inactive (quiescent) condition indefinitely because of the action of capacitor C20. This capacitor has previously been charged to the Q2 collector voltage. Since the Q2 collector voltage has very rapidly become less negative C20 must now discharge. This is shown by the flat top line in Figure 10. The discharge path is through control R21. The time constant of the discharge curve is determined by capacitor C20 and control R21. The charging time of C20 is very short with respect to the discharge time. This is due to the high resistance value of control R21 as compared with resistor R20. As C20 discharges, the voltage at the base of Q1 becomes less positive (more negative).

When the conducting level of Q1 is reached and the transistor starts to conduct as shown at T1, the complete cycle is now reversed, with Q1 conducting to saturation and turning off Q2. The circuit then reaches its second inactive (quiescent) condition, Capacitor C1 having previously been charged, now discharges at a time constant determined by the value of C10 and control R11. As long as the key lever is held in the dot position, the dot generator multivibrator continues to run free. Each stage is then alternately on and off for relatively long periods (determined by the values of C10 and R11, and C20 and R21), followed by a very rapid switchover to the opposite stage.

The collector output signals of Q1 and Q2 are fed to other sections of the circuit. The output from the collector of Q1 is fed through R30 to the base of Q3, and through R79 to the base of Q7. The output is fed to Q3 to make the multivibrator action self-completing. Once the multivibrator is started, any movement of the key lever will not have any effect until the dot and following space have been completed. The operation of Q7 will be explained in the following section.

Driver Follower And Switch

The base of switch transistor Q8 draws more current than can be supplied by the dot generator transistors. Therefore driver transistor Q7 is used as an emitter follower to supply the necessary drive for Q8. Resistors R73, R74, R75, R76, and R78 divide the power supply voltages to set the proper bias voltages to fully control Q7 and Q8.

Transistors Q7 and Q8 have a positive base bias voltage which keeps them cut off (no current flow). Each time the collector voltage of Q1 is at -16 volts, transistor Q7 is biased to conduction. This action then biases Q8 to a point where it will also conduct. The output from Q7 is fed through resistor R111 to the base of audio clamp Q11. The operation of Q11 will be explained later. The collector output of Q8 is used to key the transmitter. This waveform is shown in Figure 12.

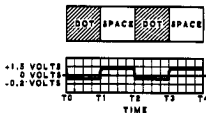

SIGNAL AT BASE OF Q8

Figure 12

Manual keying may be accomplished by connecting a hand key between the Hand Key and Gnd terminals. This operates Q7 and Q8 independently of the Keyer operation by shifting the bias voltage on Q7. The Hand Key terminal is also grounded when the slide switch is placed in the Hold position. This allows continuous transmitter operation for tuning or adjustment purposes.

DASHES

Dash Clamp

Dash clamp Q6 operates the same as did the dot clamp. Transistor Q6 keeps the flip-flop multivibrator circuit turned off by applying a positive bias voltage to the base of Q4. This bias voltage will cause Q4 to be cut off.

Flip-Flop Multivibrator

The flip-flop multivibrator consisting of transistors Q4 and Q5 and their associated circuit are similar in construction and appearance to the dot generator multivibrator. However, instead of having cross-coupling (collector of one to the base of the other) capacitors, it uses resistors. Therefore, it cannot oscillate as did the dot generator multivibrator. This circuit will stay in either of two states, where one transistor is cut off (fully off) and the other is saturated (fully on).

When the base of Q4 is positive with respect to the emitter, it cannot conduct. The collector voltage of Q4 is then maximum negative and is coupled through resistor R41 to the base of Q5. This negative voltage on the base causes Q5 to conduct, thus keeping it at saturation. In this condition, the multivibrator cannot switch, it will stay in this condition until a positive-going pulse is fed to the base of the transistor that is in the saturated condition. In this case it is Q5. A positive pulse on the base of Q5 will turn it off, causing its collector current to decrease and its collector voltage to become more negative. This increase in negative voltage at the collector of Q5 is coupled through resistor R51 to the base of Q4 to turn it on. The negative voltage will continue until Q4 is driven to maximum collector current (fully conducting), while the collector current of Q5 is cut off (nonconducting). Nothing further can happen until Q4 gets a positive pulse at its base to turn it off, causing the cycle to repeat itself in the opposite direction. This switching action takes place very rapidly.

As mentioned before, the flip-flop multivibrator cannot switch as long as the bias voltage from clamp Q6 is present at the base of Q4. Moving the key lever to the dash position removes the bias voltage from Q6, letting Q4 operate. Simultaneously, diode D1 turns off dot clamp Q3,

allowing the dot generator multivibrator to run free. In its starting condition it will be remembered that Q2 was off (maximum negative voltage at the collector). As soon as the dot multivibrator started to operate, the Q2 collector voltage decreased rapidly from maximum to near zero. This produces a positive (less negative) going pulse from the collector of Q2 to the junction at the bottom of capacitors C41 and C51. This waveform is shown at points T0 and T2 in Figure 13.

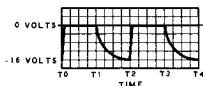

Q2 COLLECTOR VOLTAGE

Figure 13

These positive going pulses trigger the flip-flop multivibrator. They are coupled through capacitor C41 and diode D40 to the base of Q4. These pulses are also coupled through capacitor C51 and diode D50 to the base of Q5. These pulses affect only the transistor that is in the saturated condition. In this instance, it is Q5. The waveform of the pulse at the junction of C51 and the diode D50 is shown in Figure 14.

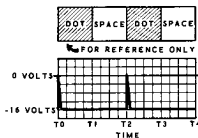

TRIGGER PULSE AT JUNCTION OF C51 AND D50 WITH KEY LEVER IN DOT POSITION.

Figure 14

As Q5 turns off, a negative going pulse is produced. This is because Q5 stops drawing current, permitting the collector voltage to become more negative. Capacitor C50 is used to pass this pulse to the base of Q4 to speed up the switching action. Capacitor C40 performs the same task in the opposite cycle.

The collector output of Q5, as shown in Figure 15, is coupled to the junction of resistors R33 and R61. Resistor R33, diode D31, capacitor C3, resistors R61 and R62, and capacitor C60 form filters. These filters direct voltage from Q5 to clamp Q3 and Q6 to make the dashes self-completing. They also keep the control voltage from interacting between dots and dashes.

The output from the collector of Q5 is also coupled through a delay line consisting of resistors R70, R71, R72, and capacitors C70 and C71 to the base of Q7. This delay is necessary to insure that the output switching caused by the flip-flop multivibrator slightly overlaps that of the dot generator, while making dashes. Failure to overlap may leave holes in the dashes similar to that caused by the bouncing contacts of relays.

When the collector output of Q5 remains at its maximum negative voltage level, it produces a negative voltage to turn on transistors Q7 which drives Q8. Before Q5 can switch to on, the flip-flop must be triggered again by a positive going pulse from the collector of Q2. The pulse that just triggered Q5 was a positive going pulse from Q2. The output from the dot generator multivibrator is now a negative voltage from the collector of Q1. This is fed to the base of Q7, which is already on because of the negative voltage at Q5. Therefore, the output from Q1 has no additional effect. The next pulse from Q2 will be a negative going pulse, as Q2 turns off. This negative pulse from Q2 has no effect on the flip-flop multivibrator, as only positive going pulses can reset it. After the dot generator multivibrator goes through another half cycle, a positive going pulse from Q2 will result. This positive pulse is coupled to the base of Q4 (saturated transistor), resetting the flip-flop multivibrator.

Note in Figure 14 that the flat portion of the waveform is equal to the length of a dot and a space. This is because Q2 produces a positive going pulse every time it switches on. Since the positive pulses switch the flip-flop transistors alternately, they operate at half the rate of the dot generator multivibrator. The output from the dot generator and flip-flop multivibrators add

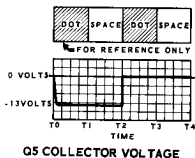

Q5 COLLECTOR VOLTAGE

Figure 15

to the base of Q7. This produces the first third of a dash signal from the collectors of Q1 and Q5, as shown in Figure 15. The middle third of the dash is produced by the collector output of Q5 alone.

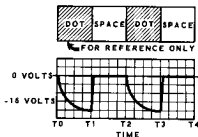

Q1 COLLECTOR VOLTAGE

Figure 16

The last third of the dash is filled in by the next dot signal from Q1 alone as shown in Figure 16. The result of these two signals at the base of Q8 is the waveform shown in Figure 17.

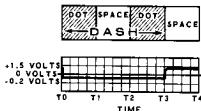

SIGNAL AT BASE OF Q8

Figure 17

At this instant both Q1 and Q5 are on and a space results. This completes a dash and a space at the collector of Q8 to key the transmitter. This waveform is shown in Figure 18.

As the key lever is moved to the center or dot position, clamp Q2 is turned on and applies a positive bias voltage to Q4. This voltage turns Q4 off and Q5 on to set the flip-flop multivibrator. Thus, it is ready to start a dash the next time the key lever is moved to the dash position.

MONITOR CIRCUIT

Audio Clamp

Each time Q7 is turned on by a dot or dash signal, a negative bias voltage is applied through R111 to the base of audio clamp Q11. This in turn starts the free running audio multivibrator. The audio multivibrator consists of transistors Q9, Q10, and their associated circuitry. It is identical to the dot generator multivibrator, except for component values. Both of these multivibrator circuits work in the same way. The only difference being the audio multivibrator oscillates at an audio rate. This rate is determined by the time constant of resistors R90 and R100, with capacitors C90 and C100.

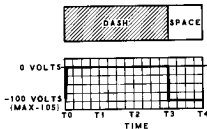

Q8 COLLECTOR OUTPUT TO TRANSMITTER
Figure 18

The output signals from the collectors of Q9 and Q10 are fed to the primary winding of audio output transformer T2. Capacitor C101 prevents any DC voltage from reaching the transformer. The signal from the secondary winding of T2 is connected across volume control R102. The wiper of the volume control is connected to the speaker. The control may be adjusted for the desired listening level.

If desired, the receiver output may be connected between GND and the Receiver Audio terminals. This allows the audio to be heard in headphones connected to the Phone jack of the Electronic Keyer. The speaker of the Electronic Keyer cannot be used when a receiver is connected, as it is of too high an impedance and cannot handle the output level of the receiver. If speaker operation is desired, the individual speakers of the Electronic Keyer and the receiver must be used.

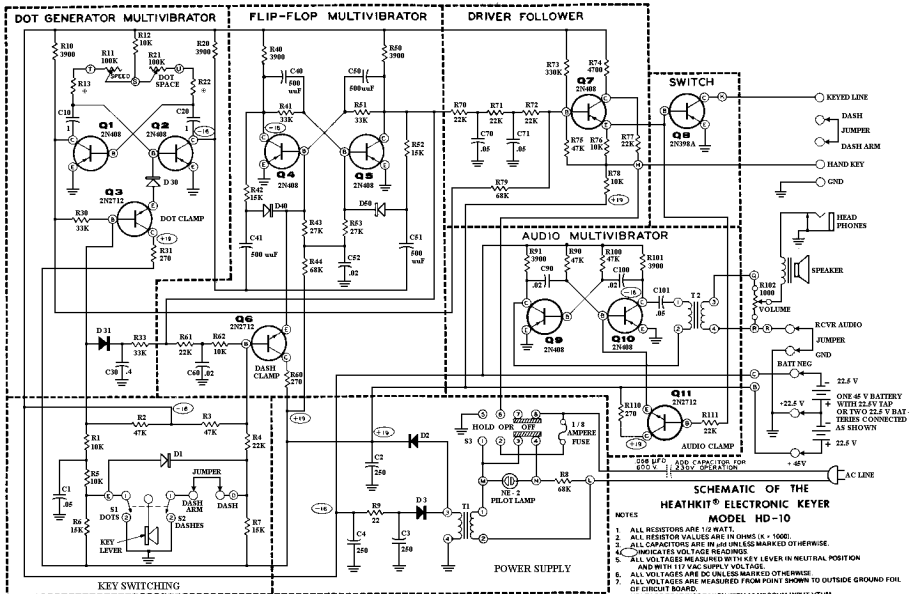

**SCHEMATIC OF THE
HEATHKIT® ELECTRONIC KEYS
MODEL HD-10**

- NOTES
1. ALL RESISTORS ARE 1/2 WATT.
 2. ALL RESISTOR VALUES ARE IN OHMS (K = 1000).
 3. ALL CAPACITORS ARE IN μ F UNLESS MARKED OTHERWISE.
 4. ∞ INDICATES VOLTAGE READINGS.
 5. ALL VOLTAGES MEASURED WITH KEY LEVER IN NEUTRAL POSITION AND WITH 117 VAC SUPPLY VOLTAGE.
 6. ALL VOLTAGES ARE DC UNLESS MARKED OTHERWISE.
 7. ALL VOLTAGES ARE MEASURED FROM POINT SHOWN TO OUTSIDE GROUND FOUL OF CIRCUIT BOARD.
 8. VOLTAGE READINGS TAKEN WITH 11 MEGOHM INPUT VTVM.
 9. DOTTED TERMINALS DUPLICATE SOLID TERMINALS AS SHOWN.
 10. *10 K Ω FOR 15 TO 60 WORDS PER MINUTE SPEED.
68 K Ω FOR 18 TO 20 WORDS PER MINUTE SPEED.