



INSTRUCTION MANUAL

COMMUNICATIONS RECEIVER IC-R20

This device complies with Part 15 of the FCC rules. Operation is subject to the following two conditions: (1) This device may not cause harmful interference, and (2) this device must accept any interference received, including interference that may cause undesired operation.

WARNING: MODIFICATION OF THIS DEVICE TO RECEIVE CELLULAR RADIO TELEPHONE SERVICE SIGNALS IS PROHIBITED UNDER FCC RULES AND FEDERAL LAW.

Icom Inc.



FOREWORD

Thank you for purchasing this Icom product. The IC-R20 COMMUNICATIONS RECEIVER is designed and built with Icom's superior technology and craftsmanship. With proper care, this product should provide you with years of trouble-free operation.

We want to take a couple of moments of your time to thank you for making your IC-R20 your radio of choice, and hope you agree with Icom's philosophy of "technology first." Many hours of research and development went into the design of your IC-R20.

◇ FEATURES

- *Covers 0.150–3304.999 MHz* wide frequency range*

*Some frequency bands are inhibited according to version

- *External power supply operation*
- *1250 memory channels* with 26 banks available*

*200 auto write and 50 scan edge channels are included.

- *Built-in bar-antenna*
- *Dualwatch operation*

IMPORTANT

READ ALL INSTRUCTIONS carefully and completely before using the receiver.

SAVE THIS INSTRUCTION MANUAL— This instruction manual contains important operating instructions for the IC-R20.

EXPLICIT DEFINITIONS

WORD	DEFINITION
⚠ WARNING!	Personal injury, fire hazard or electric shock may occur.
CAUTION	Equipment damage may occur.
NOTE	Recommended for optimum use. No risk of personal injury, fire or electric shock.

CE Versions of the IC-R20 which display the "CE" symbol on the serial number seal, comply with the essential requirements of the European Radio and Telecommunication Terminal Directive 1999/5/EC, and that any applicable Essential Test Suite measurements have been performed.

Icom, Icom Inc. and the ICOM logo are registered trademarks of Icom Incorporated (Japan) in the United States, the United Kingdom, Germany, France, Spain, Russia and/or other countries.

PRECAUTION

⚠ WARNING! NEVER operate the receiver with an earphone, headphones or other audio accessories at high volume levels. Hearing experts advise against continuous high volume operation. If you experience a ringing in your ears, reduce the volume level or discontinue use.

⚠ WARNING! NEVER connect the receiver directly to an AC outlet. This may pose a fire hazard or result in an electric shock.

⚠ WARNING! NEVER operate the receiver while driving a vehicle. Safety driving requires your full attention—anything less may result in an accident.

⚠ WARNING! NEVER throw a battery cell or battery pack into a fire since as internal battery gas can cause an explosion.

⚠ WARNING! NEVER disassemble the battery pack. If the battery cell's internal material (electrolyte liquid) gets into your eyes, wash your eyes with water and obtain treatment from an eye doctor immediately.

NEVER connect the receiver directly to a power source of more than 6 V DC. This will damage the receiver.

NEVER connect the receiver to a power source using reverse polarity. This will damage the receiver.

NEVER expose the receiver to rain, snow or any liquids. The receiver may be damaged.

NEVER operate or touch the receiver with wet hands. This may result in an electric shock or damage the receiver.

NEVER solder the battery cell. This may damage the battery.

AVOID using or placing the receiver in direct sunlight or in areas with temperatures below -10°C ($+14^{\circ}\text{F}$) or above $+60^{\circ}\text{C}$ ($+140^{\circ}\text{F}$).

AVOID the use of chemical agents such as benzine or alcohol in cleaning, as they can damage the receiver's surfaces.

Even when the receiver power is OFF, a slight current still flows in the circuits. Remove the battery pack or batteries from the receiver while not using it for a long time. Otherwise, the installed battery pack or batteries will become exhausted, and will need to be recharged.

RESPECT other people's privacy. Information overheard but not intended for you cannot lawfully be used in any way.

For U.S.A. only

CAUTION: Changes or modifications to this device, not expressly approved by Icom Inc., could void your authority to operate this device under FCC regulations.

SUPPLIED ACCESSORIES

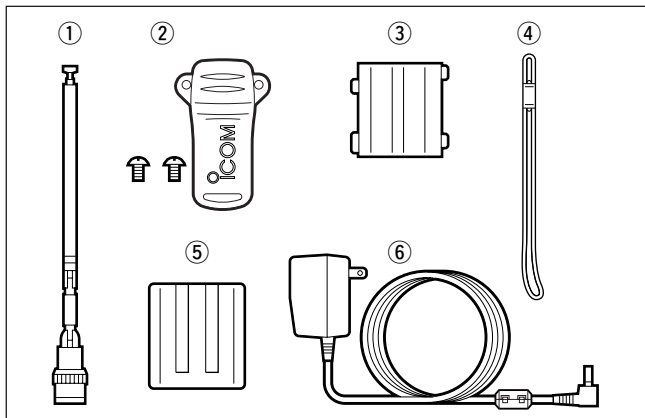

- ① Antenna 1
- ② Belt clip (MB-98) 1 set
- ③ Battery spacer 1
- ④ Hand strap 1
- ⑤ Battery pack* (BP-206) 1
- ⑥ AC adaptor* (BC-149A/D) 1

(The shape of the BC-149A and BC-149D are different.)

*Not supplied with some versions.

OPERATING THEORY

Electromagnetic radiation which has frequencies of 20,000 Hz (20 kHz*) and above is called radio frequency (RF) energy because it is useful in radio transmissions. The IC-R20 receives RF energy from 0.150 MHz* to 3304.999 MHz and converts it into audio frequency (AF) energy which in turn actuates a loudspeaker to create sound waves. AF energy is in the range of 20 to 20,000 Hz.

*kHz is an abbreviation of kilohertz or 1000 hertz, MHz is abbreviation of megahertz or 1,000,000 hertz, where hertz is a unit of frequency.

OPERATING NOTES

The IC-R20 may receive its own oscillated frequency, resulting in no reception or only noise reception, on some frequencies.

The IC-R20 may receive interference from extremely strong signals on different frequencies or when using an external high-gain antenna.

TABLE OF CONTENTS

FOREWORD	i	■ RF gain	19	■ Tone squelch frequency/DTCS code setting	46
IMPORTANT	i	■ Duplex operation	20	■ DTCS polarity setting	47
EXPLICIT DEFINITIONS	i	■ AFC function	21	■ Tone scan	48
PRECAUTION	ii	■ NB/ANL functions	21	10 SET MODE	49–59
SUPPLIED ACCESSORIES	iii	■ Band scope	22	■ General	49
OPERATING THEORY	iii	■ [DIAL] function assignment	23	■ Set mode items	50
OPERATING NOTES	iii	5 DUALWATCH OPERATION	24–25	11 OTHER FUNCTIONS	60–67
TABLE OF CONTENTS	iv	■ Main band selection	24	■ Antenna selection	60
QUICK REFERENCE GUIDE	I–VIII	■ Band exchange	24	■ Weather channel operation	61
■ Preparations	I	■ Setting audio volume	25	■ Data cloning	62
■ Your first scanning experience	IV	■ Squelch level setting	25	■ Auto power-off function	63
■ Memory programming	VI	6 MEMORY CHANNELS	26–33	■ IC recorder	64
■ Programmed scan operation	VII	■ General description	26	■ Partial reset	67
1 PANEL DESCRIPTION	1–7	■ Memory channel programming	26	■ All reset	68
■ Front, top and side panels	1	■ Memory bank setting	27	12 CONTROL COMMAND	68–69
■ Function display	6	■ Memory bank selection	28	■ General	68
2 BATTERY INSTALLATION/CHARGING ...	8–10	■ Programming memory/bank name	29	■ Data format	68
■ Battery installation	8	■ Selecting memory/bank name indication	30	■ Command table	68
■ Caution	9	■ Copying memory contents	31	13 FREQUENCY TABLE	70–77
■ Battery charging	9	■ Memory clearing	32	■ TV channels	70
3 FREQUENCY AND CHANNEL SETTING	11–16	■ Erasing/transferring bank contents	33	■ VHF marine channels	73
■ Mode selection	11	7 SCAN OPERATION	34–41	■ Weather channels	73
■ Operating band selection	12	■ Scan types	34	■ Other communications in the USA	74
■ Setting a tuning step	14	■ Full/band/programmed scan	35	■ Other communications—other countries	76
■ Setting a frequency	14	■ Scan edges programming	36	14 MAINTENANCE	78
■ Receive mode selection	16	■ Memory/bank/all bank scan	37	■ Troubleshooting	78
■ Lock function	16	■ Auto-memory write scan	38	15 SPECIFICATIONS	79
4 BASIC OPERATION	17–23	■ Skip channel/frequency setting	39	16 OPTIONS	80
■ Receiving	17	■ Scan resume condition	40	17 DRIVER INSTALLATION	81
■ Setting audio volume	17	8 PRIORITY WATCH	42–44	18 POCKET GUIDE	92
■ Squelch level setting	18	■ Priority watch types	42	19 CE	94
■ Monitor function	18	■ Priority watch operation	43		
■ Attenuator function	19	9 COMFORTABLE RECEIVING	45–48		
		■ Tone/DTCS squelch operation	45		

1
2
3
4
5
6
7
8
9
10
11
12
13
14
15
16
17
18
19

QUICK REFERENCE GUIDE

■ Preparations

◇ Batteries installation

① Remove the battery cover from the receiver.

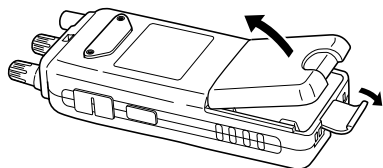

② For alkaline battery use, attach the supplied battery spacer.

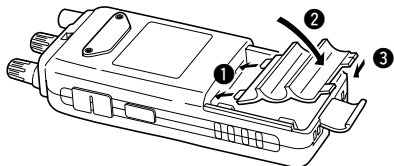

③ Install 3 R6 (AA) size alkaline batteries.

- Be sure to observe the correct polarity.

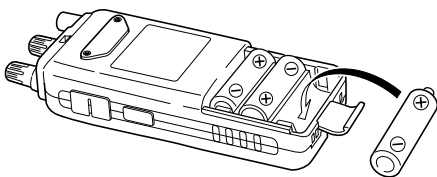

/// Keep the battery contacts clean to avoid rust or poor contact.
/// It's a good idea to clean the battery terminals once a week.

◇ Battery pack installation

① Remove the battery cover from the receiver.

② Remove the supplied battery spacer for R6 (AA) size battery use.

③ Install the Li-Ion battery pack (BP-206).

- Be sure to observe the correct direction.
- Charge Li-Ion battery pack (BP-206) before use. (Refer to p. IV for charging instructions.)

•Battery pack installation

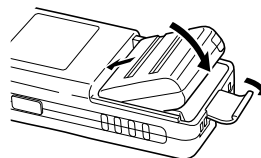

•Battery pack removal

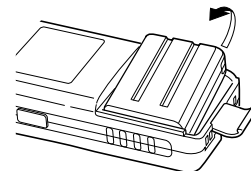

◇ Handstrap

Slide the handstrap through the loop on the top of the rear panel as illustrated at below. Facilitates carrying.

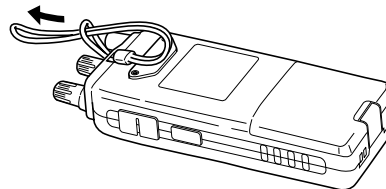

◆ **Belt clip**

Conveniently attaches to your belt.
Attach the belt clip with the supplied screws using a phillips screwdriver.

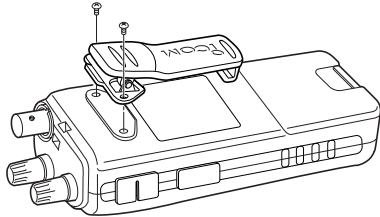

◆ **Swivel belt clip (Option)**

The optional swivel belt clip (MB-86) is useful for easy attaching/detaching the receiver to/from the belt.

① Attach the stopper with the supplied screws using a phillips screwdriver.

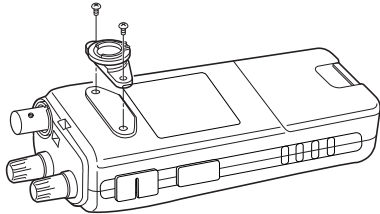

② Clip the belt clip to your belt.

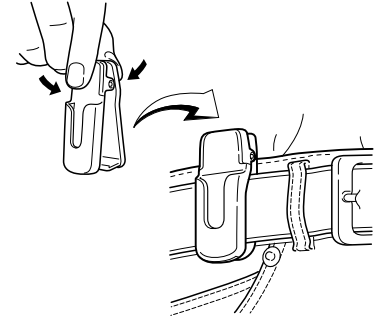

③ Insert the receiver into the end of the clip as shown at right.

- Once the receiver is locked in place, it will swivel 360 degrees.

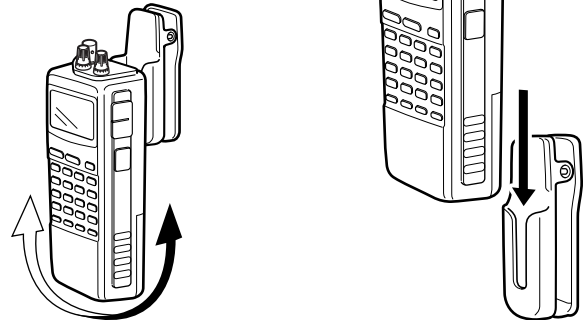

QUICK REFERENCE GUIDE

To remove:

- ④ Turn the receiver upside down, and then lift to release the receiver from the belt clip as shown at upper right.

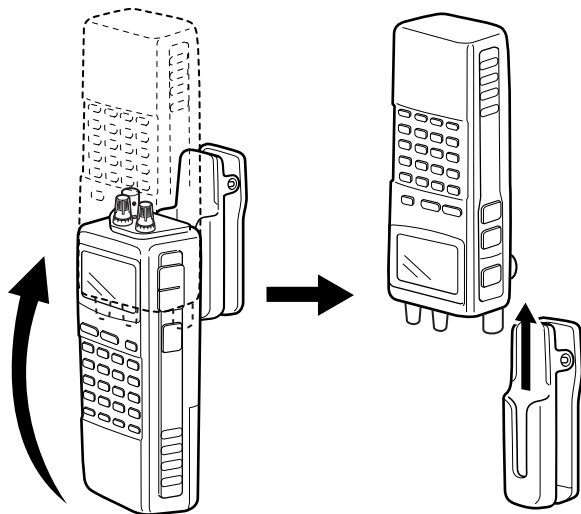

◆ **Antenna**

Insert the supplied antenna into the antenna connector and screw down the antenna as shown at right.

NEVER hold the antenna when carrying the receiver.

✓ **For your information**
Third-party antennas may increase receiver performance.

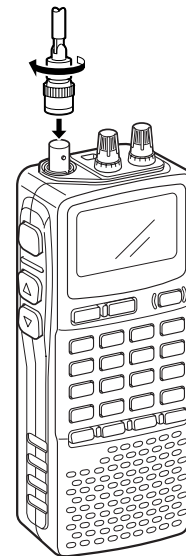

◇ Charging the battery

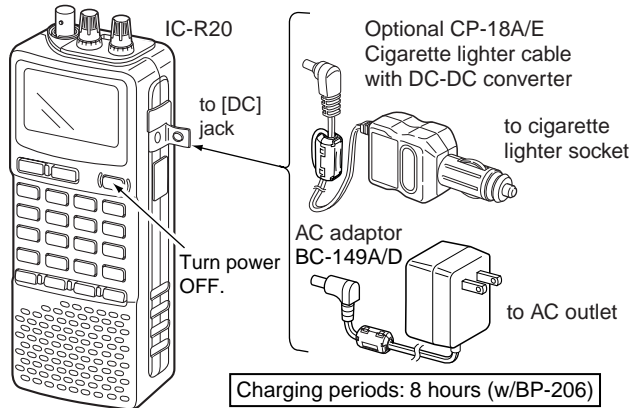

- ① Install the battery pack (BP-206).
- ② Plug the AC adaptor into an AC outlet.
- ③ Turn OFF the receiver, then insert the adaptor plug into the [DC] jack of the receiver.

⚠ WARNING!
NEVER attempt to charge any other batteries. Because the IC-R20 can charge the BP-206 only.

Keep the jack cover attached when jack is not in use to protect the connectors from dust and moisture.

■ Your first scanning experience

Now that you have your IC-R20 ready, you are probably excited to start listening. We would like to take you through a few basic operation steps to make your first “Scanning Experience” enjoyable.

◇ About default setting

The frequency control ([R-DIAL]) function can be traded with volume control ([L-DIAL] and [▲]/[▼] keys) function by pushing for 1 sec. [1 DIAL.SEL]. However, in this QUICK REFERENCE GUIDE, the factory default setting ([R-DIAL] sets operating frequency) is used for simple instruction.

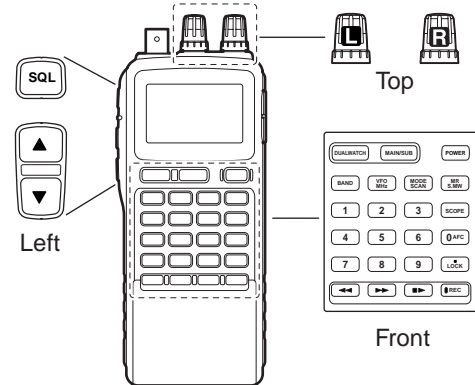

QUICK REFERENCE GUIDE

◇ Basic operation

1. Turning ON the receiver

- ➔ Push **[POWER]** for 1 sec. to turn the power ON.

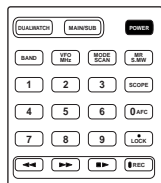

POWER

Front

2. Adjusting audio level

- ➔ Rotate **[L-DIAL]** (or push **[▲]**/**[▼]**) to set the desired audio level.



Left



Top

3. Adjusting squelch level

- ➔ While pushing **[SQL]**, rotate **[R-DIAL]** to set the squelch level.



Left



Top

4. Tune the desired frequency

The tuning dial will allow you to dial in the frequency you want to operate. Pages 9 and 15 will instruct you on how to set the tuning speed.

[Using the tuning dial]

- ① Push **[BAND]** several times to select the desired frequency band.
 - While pushing **[BAND]**, rotate **[R-DIAL]** also select frequency band.



Top

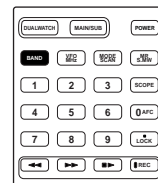

BAND

Front

- ② Rotate **[R-DIAL]** to set the desired receive frequency.
 - Push **[VFO MHz]** for 1 sec. then rotate **[R-DIAL]** to change the frequency in 1 MHz steps, or push for 1 sec. again then rotate **[R-DIAL]** to change the frequency in 10 MHz steps. (Each push for 1 sec. toggles 1 MHz or 10 MHz tuning steps.)



Top

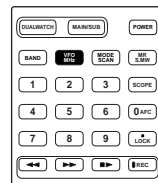

VFO MHz

Front

[Using the keypad]

- ➔ Enter the desired frequency via the keypad.
 - Direct input can be set until 1 kHz digit, rotate **[R-DIAL]** to set below 1 kHz frequency after set tuning steps, if necessary. (See p. 14 for setting the tuning step.)
 - Pushing **[VFO MHz]** omits the entry of 100 kHz and below, when you want to edit to these digits “0.”
 - Push **[DUALWATCH]** to cancel the entry.

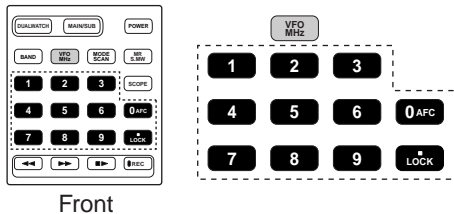

Front

5. Receive mode selection

- ➔ Push **[MODE SCAN]** several times to select the desired receive mode.
 - FM, WFM, AM, LSB, USB and CW are available.

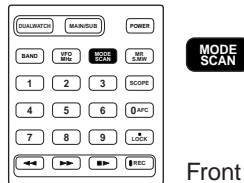

Front

Memory programming

The IC-R20 has a total of 1250 memory channels (including 200 auto write channels and 50 scan edges) for storing often used receive frequency, mode, etc.

1. Setting frequency

- In VFO mode, set the desired receive frequency mode.
 - When “**MR**” indicator is displayed, push **[VFO MHz]** to select the VFO mode.

2. Selecting a memory channel

- Push **[MR S.MW]** for 1 sec., then rotate **[R-DIAL]** to select the desired memory channel.
 - “**MR**” indicator blinks.

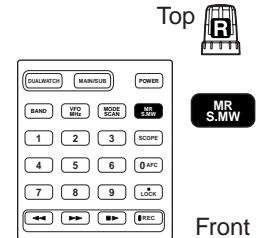
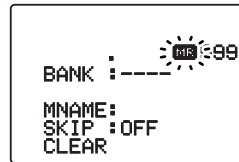

Front

3. Writing a memory channel

- Push **[MR S.MW]** for 1 sec. until 3 beeps sound.
 - Memory channel number automatically increases when continuing to push **[MR S.MW]** after programming.

QUICK REFERENCE GUIDE

■ Programmed scan operation

25 pairs, 50 channels of memories are used for programmed scan operation, that specify a scanning range. The programmed scan scans between “xxA” and “xxB” (xx=00 to 24) frequencies. Therefore, before operating the programmed scan, different frequencies must be programmed into “A” and “B” channels.

◆ Programming scan edges

A start frequency must be programmed into a “xxA,” and end frequency must be programmed into a “xxB” memory channel.

1. Setting frequency

In VFO mode, set the desired receive frequency mode.

- When “**MR**” indicator is displayed, push [**VFO MHz**] to select the VFO mode.

2. Selecting a scan edge channel “A”

Push [**MR S.MW**] for 1 sec., then rotate [**R-DIAL**] to select one of the desired scan edge channel “A.”

- “**MR**” indicator blinks.

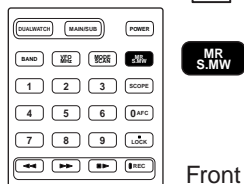

Front

3. Writing a memory channel

Push [**MR S.MW**] for 1 sec. until 3 beeps sound.

- Scan edge channel “B” is automatically selected when continuing to push [**MR S.MW**] after programming.
- After programming is completed, return to VFO indication.

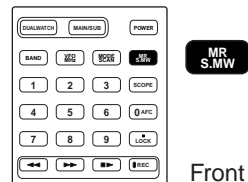

Front

4. Selecting a scan edge channel “B”

Push [**MR S.MW**] for 1 sec., then rotate [**R-DIAL**] to select one of the desired scan edge channel “B.”

- “**MR**” indicator blinks.
- When the scan edge channel “B” is already selected at step 3. (continuing to push [**MR S.MW**] after programming), skip this step.

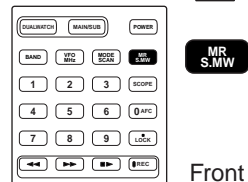

Front

5. Writing a memory channel

Push [**MR S.MW**] for 1 sec. until 3 beeps sound.

- The next scan edge channel “A” is automatically selected when continuing to push [**MR S.MW**] after programming.
- After programming is completed, return to VFO indication.

◆ Starting scan

1. Select VFO mode.

Push [VFO MHz] to select the VFO mode for full, band and programmed scan operation.

- Select memory mode by pushing [MR S.MW] for memory or bank scan.

2. Selecting a scanning type

While pushing and holding [MODE SCAN], rotate [R-DIAL] to select one of the desired scanning type.

- Available scan types when VFO mode is selected; “ALL” for full scan; “BAND” for the selected band; one of “PROGxx” (xx=0 to 24) for programmed scan.
- Available scan types when memory bank is selected; “ALL” for all memory scan, “BANK-LINK” for bank-link scan; “BANK” for the selected bank scan.

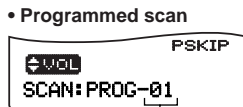
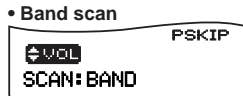
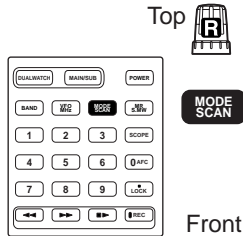

Selectable between “00” to “24” if programmed

3. Starting scan

Release [MODE SCAN] to start the scan.

- Rotate [R-DIAL] to change the scanning direction.

• During full/band scan



• During programmed scan

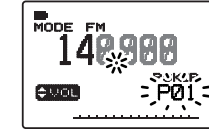

• During memory/all/bank scan

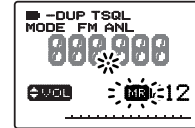

• During bank scan

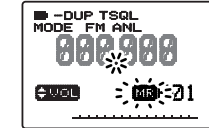

4. Cancelling scan

Push [DUALWATCH] to stop the scan.

✓ For your information

The memory channel number you program the scan edges into correlate “PROGxx” as follows:

- 00A/00B: Scans between frequencies programmed in 00A and 00B channels, and select “PROG-00”
- 01A/01B: Scans between frequencies programmed in 01A and 01B channels, and select “PROG-01”
- ⋮
- 24A/24B: Scans between frequencies programmed in 24A and 24B channels, and select “PROG-24”

■ Front, top and side panels

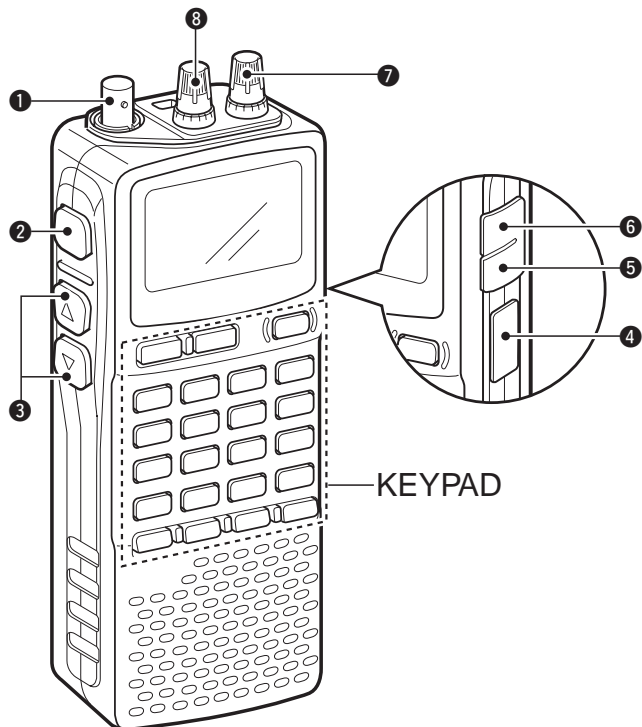

- ① ANTENNA CONNECTOR** (p. 11)
 BNC connector: Connects the supplied antenna.
- ② SQUELCH KEY [SQL]** (p. 18)
 ➔ Push and hold to temporarily open the squelch and monitor the operating frequency.
 ➔ While pushing this key, rotate the tuning dial* to adjust the squelch level.
- ③ UP/DOWN KEYS [▲]/[▼]**
 Adjust audio volume level.* (p. 17)
- ④ USB JACK [USB]**
 Connects to a PC using an optional OPC-1382 CLONING CABLE for cloning. Cloning allows you to quickly and easily transfer the programmed contents between the IC-R20 and the connected PC.
- ⑤ EXTERNAL DC-IN CONNECTOR [DC]** (p. 9)
 Connects an AC adaptor or an optional cigarette lighter cable for both charging the installed re-chargeable battery pack and operating.
- ⑥ EXTERNAL SPEAKER CONNECTOR [SP/CI-V]**
 ➔ Connect an optional earphone or headphone.
 The internal speaker will not function when any external equipment is connected. (See p. 80 for a list of available options.)
 ➔ Connect an optional CT-17 for remote control operation. (p. 68)

7 LEFT DIAL [L-DIAL]

- ➔ During single band operation, rotate to adjust audio volume level.* (p. 17)
- ➔ During dualwatch operation, activates as the tuning dial for upper side on the display.*

8 RIGHT DIAL [R-DIAL]

- ➔ Rotate to select the operating frequency.* (p. 12)
- ➔ While scanning, changes the scanning direction.* (p. 26)
- ➔ While pushing [**SQL**], sets the squelch level.* (p. 18)
- ➔ While pushing [**VFO MHz**], sets the operating frequency in 1 MHz or 10 MHz in VFO mode.* (p. 14)
- ➔ While pushing [**BAND**], selects the operating band in VFO mode.* (p. 14)
- ➔ While dualwatch operation, activates as the tuning dial for lower side on the display.* (p. 14)

KEYPAD



1 DUALWATCH/CLEAR KEY [DUALWATCH]



- ➔ Push for 1 sec. to toggle between single band and dualwatch operation. (p. 24)
- ➔ Clears numeric key input. (p. 15)
- ➔ Returns to previous operating condition while setting frequency or memory channel, or while in set mode.
- ➔ Cancels the band scope or scan function, etc. (pgs. 22, 35)

2 MAIN/SUB KEY [MAIN/SUB] (p. 24)



- ➔ During dualwatch operation, push to select the MAIN band or SUB band.
- ➔ During dualwatch operation, push for 1 sec. to exchange the upper frequency and lower frequency.

3 POWER KEY [POWER]



- ➔ Push for 1 sec. to turn the receiver power ON and OFF.

4 BAND KEY [BAND]



- ➔ Push to select the operating frequency band. (p. 12)

*The function of tuning control and volume control can be traded. See page 23 for details.

1 PANEL DESCRIPTION

5 VFO/MHz KEY [VFO MHz]



- Push to select VFO mode. (p. 11)
- Push for 1 sec. to toggle between the 1 MHz or 10 MHz tuning steps (p. 14)

6 MODE/SCAN KEY [MODE SCAN]



- Push to select the operating mode (FM, WFM, AM, USB, LSB, CW). (p. 16)
- Push for 1 sec. to start a scan. (p. 35)

7 MEMORY KEY [MR S.MW]



- Push to select between memory mode, TV channel and PreSet channel. (p. 11)
- Push for 1 sec. to enter memory write condition. (p. 26)
- Push for 2 sec. to write the operating frequency into the selected memory channel in VFO mode.
Push **[MR S.MW]** for 2 sec. to transfer the displayed frequency into the VFO in memory mode. (p. 31)

8 VOLUME/DIAL KEY [1 DIAL.SEL]



- Inputs digit '1' for frequency input, memory channel selection, etc.
- Push for 1 sec. to trade the volume control (**[L-DIAL]**, **[▲]/[▼]**) and tuning control (**[R-DIAL]**) functions. (p. 23)
 - "**WOL**" appears when the normal operation.
 - "**DIAL**" appears when the functions of the tuning control and volume control are traded.

9 SWEEP KEY [2 SWEEP] (p. 22)



- Inputs digit '2' for frequency input, memory channel selection, etc.
- Push for 1 sec. to select the tuning step for band scope function. Once this key is pushed, the band scope function sweeps once via the new tuning step.

10 CENTER KEY [3 CENTER] (p. 22)



- Inputs digit '3' for frequency input, memory channel selection, etc.
- Push for 1 sec. to return the display frequency of the band frequency.

11 SCOPE KEY [SCOPE] (p. 22)



- Push to activate the band scope function during normal operating condition. Or push to stop continuous sweeping.
- Push for 1 sec. to start continuous sweeping.

12 TONE SCAN KEY [4 T-SCAN]



- Inputs digit '4' for frequency input, memory channel selection, etc.
- Push for 1 sec. to start a tone scan. (p. 48)

13 FREQUENCY SKIP KEY [5 SKIP]



- Inputs digit '5' for frequency input, memory channel selection, etc.
- Push for 1 sec. to turn the frequency skip function ON and OFF in VFO mode. (p. 39)
 - "PSKIP" appears when the frequency skip function is in use.
- Push for 1 sec. to set the memory channel as the following skip channel in memory mode in order. (p. 39)
 - Skip channel — "SKIP" appears.
 - Frequency skip channel — "PSKIP" appears.
 - Non-skip channel — no skip indicator appears.
- Push for 1 sec. to program a paused frequency as a skip frequency while scanning. (p. 39)

14 MEMORY NAME KEY [6 M.N.]



- Inputs digit '6' for frequency input, memory channel selection, etc.
- Push for 1 sec. to turn the memory name indication ON and OFF. (p. 30)

15 AFC KEY [0 AFC]



- Inputs digit '0' for frequency input, memory channel selection, etc.
- Push for 1 sec. to turn the AFC (Automatic Frequency Control) function ON and OFF. (p. 21)

16 TONE SQUELCH KEY [7 TONE]



- Inputs digit '7' for frequency input, memory channel selection, etc.
- Push for 1 sec. to activate the following tone squelch functions in order.
 - Tone squelch — "TSQL" appears. (p. 45)
 - Pocket beep — "TSQL ((•))" appears. (p. 45)
 - DTCS squelch — "DTCS" appears. (p. 45)
 - DTCS beep — "DTCS ((•))" appears. (p. 45)
 - VSC function — "VSC" appears. (p. 45)
 - No tone operation — no tone indicator appears.

17 SET MODE KEY [8 SET]



- Inputs digit '8' for frequency input, memory channel selection, etc.
- Push for 1 sec. to enter the set mode.

1 PANEL DESCRIPTION

18 TUNING STEP KEY [9 TS]



- Inputs digit '9' for frequency input, memory channel selection, etc.
- Push for 1 sec. to select the tuning step. (p. 14)

19 LOCK KEY [• LOCK]



- Inputs MHz digit for frequency input. (p. 15)
- Push for 1 sec. to toggle the lock function ON and OFF. (p. 16)
 - "•" appears while the key lock function is in use.

20 REWIND/ATTENUATOR KEY [◀◀ ATT]



- Push to select the track for recorded audio. (p. 64)
- Push and hold to rewind during playing the recorded audio. (p. 64)
- Push for 1 sec. to turn the attenuator function ON and OFF during normal operation. (p. 19)

21 FAST FORWARD/RF GAIN KEY [▶▶ RF GAIN]



- Push to select the track for recorded audio. (p. 64)
- Push and hold to fast forward through the recorded contents. (p. 64)
- Push for 1 sec. to enter the RF GAIN set mode. Push to select the level after selecting with [R-DIAL]. (p. 19)

22 STOP/PLAY [■▶]



- Push to start the recorded audio. (p. 64)
- Push to stop the recording or playing audio. (p. 64)
- Push for 1 sec. to enter the play speed set mode. Push to select the item after selecting with [R-DIAL]. (p. 65)

23 RECORD KEY [● REC]



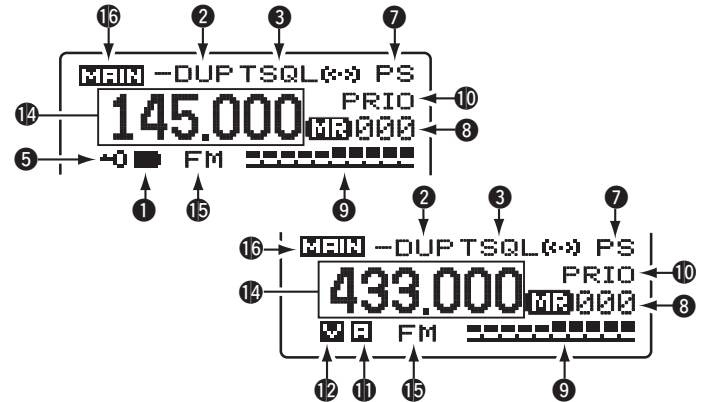
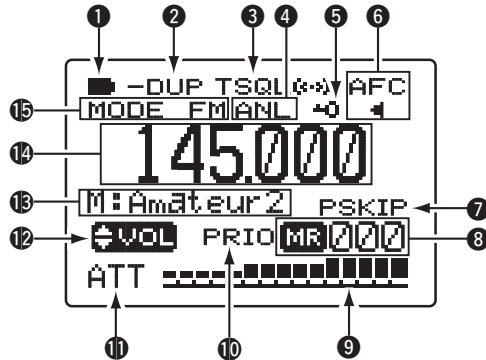

- Push to start recording audio. (p. 64)
- Push to pause recording audio. (p. 64)
- Push for 1 sec. to enter the record set mode. Push to select the item after selecting with [R-DIAL]. (p. 65)

■ Function display



① BATTERY INDICATOR

- ➔ “” appears when the installed batteries have ample capacity.
 - They do not appear when operating with an external power source.
- ➔ “” appears when the batteries are nearing exhaustion.
 - IC-R20 installed the BP-206 must be charged presently, but when it installed alkaline batteries can be operate for a while.
- ➔ Scrolls while charging the installed BP-206. (p. 8)



- ➔ Battery indicator blinks when completely charged.

② DUPLEX INDICATORS (p. 20)

“+DUP” appears when plus semi-duplex, “-DUP” appears when minus semi-duplex (repeater) operation is selected.

③ SIGNAL SQUELCH INDICATORS

- ➔ “TSQL” appears while the tone squelch function is in use. (p. 45)
- ➔ “DTCS” appears while the DTCS squelch function is in use. (p. 45)
- ➔ “(••)” appears with the “TSQL” or “DTCS” indicator while the pocket beep function (with CTCSS or DTCS) is in use. (p. 45)
- ➔ “VSC” appears while the VSC (Voice Squelch Control) function is in use. (p. 45)

1 PANEL DESCRIPTION

4 ANL/NB INDICATOR (pgs. 21, 52)

- “ANL” appears when the ANL (Automatic Noise Limiter) function is in use. The ANL function is available only for AM mode.
- “NB” appears when the noise blanker function is in use. The noise blanker function is available while in LSB/USB/CW modes.

5 LOCK INDICATOR (p. 16)

Appears when the lock function is activated.

6 AFC INDICATOR (p. 21)

Appears when the AFC function is activated.

- The AFC function is available for single band operation only.

7 SKIP INDICATORS (p. 39)

- “SKIP” appears when the selected memory channel is specified as a skip channel.
- “PSKIP” appears when the displayed frequency is specified as a skip frequency.

8 CHANNEL SELECTION INDICATOR (p. 11)

- “MR” and three digits channel number appear when memory channel is selected.
- “FM” and three digits channel number appear when auto-memory write channel is selected.
- “TV” appears when TV channel is selected.
- “0-3” channel number appears when PreSet channel is selected.
- “WX”* appears when weather channel is selected.

/// *Available for the USA version only. “FM,” “0-3” and “TV” indications appear for single band operation only.

9 SIGNAL STRENGTH INDICATOR

Shows the receiving signals relative to signal strength.

10 PRIORITY WATCH INDICATOR (p. 42)

Appears when priority watch is in use.

11 ATTENUATOR INDICATOR (p. 19)

Appears when the RF attenuator is in use.

12 VOLUME/DIAL EXCHANGE INDICATOR (p. 23)

- “VOL” appears when the normal operation.
- “DIAL” appears when the functions of the tuning control and volume control are traded.

13 MEMORY/BANK NAME INDICATOR

Shows the memory name or bank name.

- This indication is available when memory name or bank name is programmed.

14 FREQUENCY READOUT

Shows an operating frequency.

- The smaller readout appears at right when tuning step is selected 0.1 kHz or 0.01 kHz steps.
- The decimal point blinks during scan.

15 RECEIVE MODE INDICATOR (p. 16)

Shows the selected receive mode.

- FM, WFM AM, LSB, USB and CW are available.

16 MAIN BAND INDICATOR (p. 24)

Shows the main band on upper display or lower display.

- This indication appears only when dualwatch operation.

■ Battery installation

Make sure receiver power is turned OFF before installing or replacing the batteries.

- ① Remove the battery cover from the receiver.

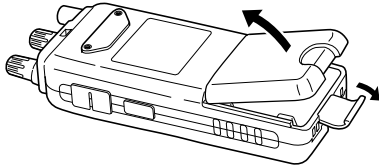

- ② For alkaline battery use, attach the supplied battery spacer.

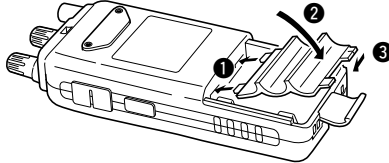

- ③ Install 3 R6 (AA) size alkaline batteries.
• Be sure to observe the correct polarity.

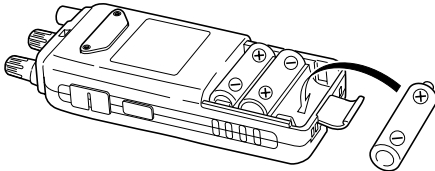

/// Keep the battery contacts clean to avoid rust or poor contact.
/// It's a good idea to clean the battery terminals once a week.

◇ Battery pack installation

- ① Remove the battery cover from the receiver.
② Remove the supplied battery spacer for R6 (AA) size battery use.
③ Install the Li-Ion battery pack (BP-206).
• Be sure to observe the correct direction.
• Charge the Li-Ion battery pack before use.

•Battery pack installation

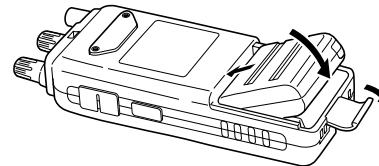

•Battery pack removal

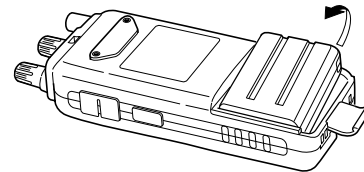

2 BATTERY INSTALLATION/CHARGING

■ Caution

◇ Battery caution

CAUTION! NEVER short the battery terminals. Current will flow into metal objects, so be careful when placing battery pack in handbags, etc.

NEVER incinerate used battery packs or battery cells. Internal battery gas may cause explosion.

NEVER mix old and new batteries. **Make sure** all battery cells are the same brand, type and capacity.

Either of the above may cause a fire hazard or damage the receiver if ignored.

◇ Charging caution

Recommended temperature for charging:
 $\pm 0^{\circ}\text{C}$ to $+35^{\circ}\text{C}$ (; $+32^{\circ}\text{F}$ to $+95^{\circ}\text{F}$)

Connect the supplied (or optional for some versions) AC adaptor or optional cigarette lighter cable only when charging the battery pack (BP-206). **NEVER** use other manufacture's chargers.

AVOID leaving the battery pack in a fully charged, or completely discharged condition for long time. It causes shorter battery life. In case of leaving the battery pack unused for a long time, it must be kept safely after discharge, or use the battery for 2 or 3 hours, then remove it from the receiver.

If your battery pack seems to have no capacity even after being charged, fully charge the battery pack again. If the battery pack still does not retain a charge (or very little), a new battery pack must be purchased.

CAUTION: BE SURE to disconnect the CP-18A/E from the cigarette lighter socket when charging is finished, because, a slight current still follows in the CP-18A/E and the vehicle's battery will become exhausted.

■ Battery charging

◇ Regular charging

- ① Insert the battery pack (BP-206) into the receiver. (p. 8)
- ② Plug the AC adaptor (BC-149A/D*) into an AC outlet; or the optional CP-18A/E into a cigarette lighter socket.
* Not supplied with some versions.
- ③ Turn OFF the receiver, then insert the adaptor plug into [DC] of the receiver.

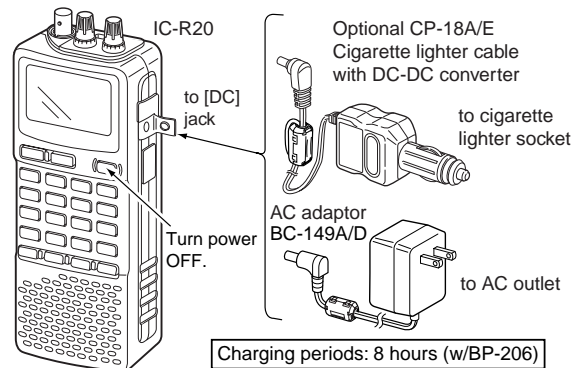

WARNING! NEVER attempt to charge any other batteries. Because the IC-R20 can charge the BP-206 only.

◆ **CP-18A/E fuse replacement**

If the fuse blows or the receiver stops functioning while operating with the optional CP-18A/E, find the source of the problem if possible, and replace the damaged fuse with a new rated one (FGB 5 A) as shown below.

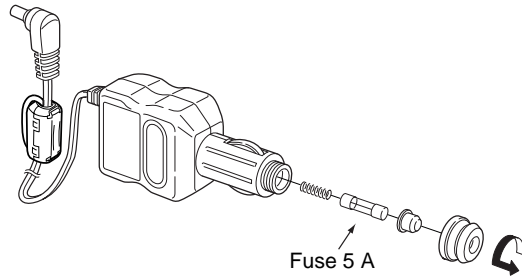

Recommendation:

Charge the supplied battery pack for a maximum of 8 hours. Li-Ion batteries are different from Ni-Cd batteries in that it is not necessary to completely charge and discharge them to prolong the battery life. Therefore, charging the battery in intervals, and not for extended periods is recommended.

◆ **Rapid charging with the BC-156**

The optional BC-156 provides rapid charging of battery pack (BP-206).

- **Charging periods:** 2.5 hours (w/BP-206)

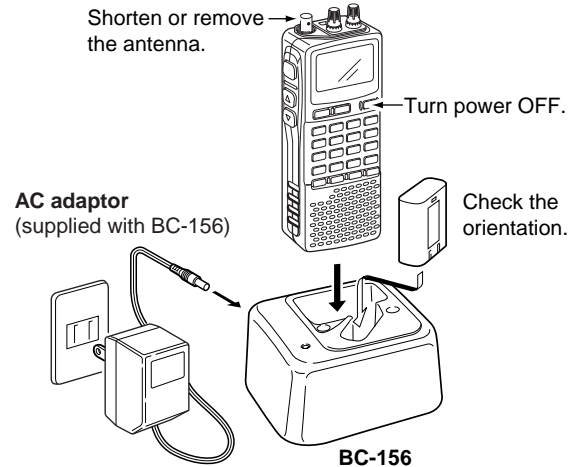

/// **CAUTION:** Shorten or remove the telescoping antenna before charging to prevent the receiver from overturning.

/// If the charge indicator flashes orange, there may be a problem with the battery pack (or charger). Reinsert the battery pack or contact your dealer.

3

FREQUENCY AND CHANNEL SETTING

Mode selection

◇ VFO mode

VFO mode is used for the desired frequency setting within the frequency coverage.

➔ Push [VFO MHz] to select VFO mode.

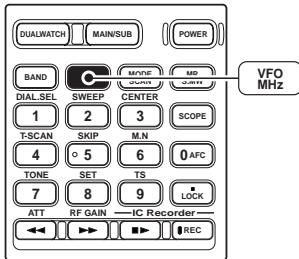

• VFO mode indication



What is VFO?

VFO is an abbreviation of Variable Frequency Oscillator. Frequencies for receiving are generated and controlled by the VFO.

◇ Memory mode/PreSet*/TV*/Weather† channels

Memory mode is used for operation of memory channels which have programmed frequencies. PreSet channels are used for most-often used frequencies for quick recall.

/// *Appears only when PreSet channels/TV channels are programmed via the optional CS-R20.

/// †Available for the USA version only.

- ① Push [MR S.MW] several times to select the channel type.
 - Memory/PreSet/TV /Weather channels can be selected in sequence
- ② Rotate [R-DIAL] to select the desired channel.
 - Only programmed memory channels can be selected.
 - Entering keypad directly can be selected the desired memory channel.
 - See p. 26 for memory programming details.

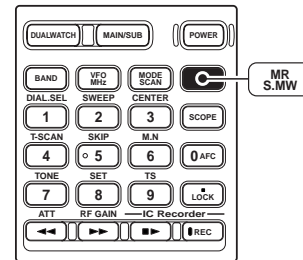

• Memory mode indication

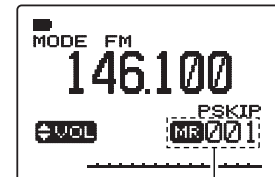

"MR" and memory channel number appear.

• Memory mode indication

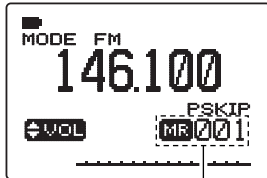

"MR" and memory channel number appear.

• TV channel indication



"TV" indication appears.

• PreSet channel indication

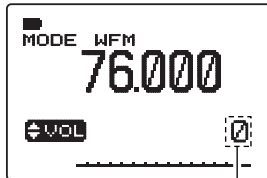

PreSet channel number appears.

• Weather channel indication (USA version only)



"WX" indication appears.

■ Operating band selection

The receiver can receive the AM broadcast, HF bands, 50 MHz, FM broadcast, VHF air, 144 MHz, 300 MHz, 400 MHz, 800 MHz,* 1200 MHz or 2400 MHz.

- In VFO mode, push **[BAND]** several times to select the desired frequency band.
 - If the other than VFO mode is selected, such as a memory/Pre-Set/TV/Weather channel, push **[VFO MHz]** to select VFO mode first, then push **[BAND]** to select the desired band.
- While pushing and holding **[BAND]**, rotating **[R-DIAL]** also selects frequency band.

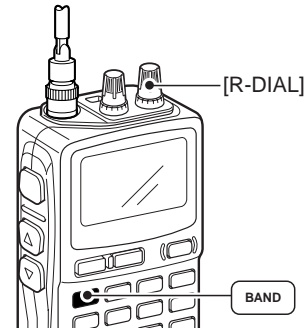

Available frequency bands are different depending on version. See the specification for details.

*Some frequency ranges are prohibited for the USA version due to local regulation.

3 FREQUENCY AND CHANNEL SETTING

• Available frequency bands

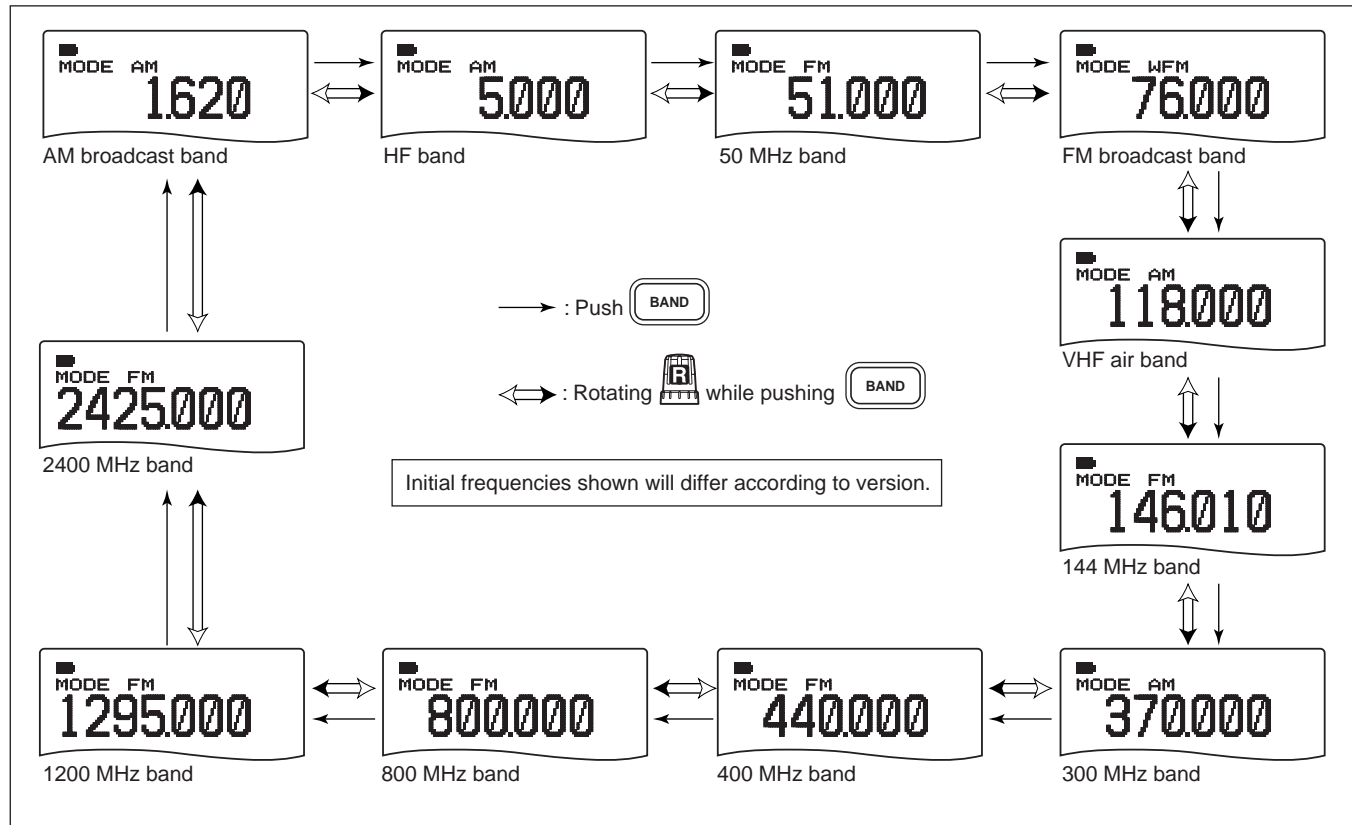

■ Setting a tuning step

The tuning step can be selected for each frequency band independently, however, the tuning steps, 8.33 kHz and 9 kHz, only appear when setting the tuning step for the VHF air band and AM broadcast band, respectively. The following tuning steps are available for the IC-R20.

- 0.01 kHz • 0.1 kHz • 1.0 kHz • 5.0 kHz • 6.25 kHz
 - 8.33 kHz* • 9.0 kHz* • 10.0 kHz • 12.5 kHz • 15.0 kHz
 - 20.0 kHz • 25.0 kHz • 30.0 kHz • 50.0 kHz • 100.0 kHz
- * Available for some frequency band only.

◆ Tuning step selection

- ① Push **[VFO MHz]** to select VFO mode, if necessary.
- ② Push **[BAND]** to select the desired frequency band.
 - Or, while pushing and holding **[BAND]**, rotate **[R-DIAL]** to select the desired frequency band.
- ③ Push **[9 TS]** for 1 sec. to enter tuning step selecting condition.
- ④ Rotate **[R-DIAL]** to select the desired tuning step.
- ⑤ Push **[9 TS]** to return to VFO mode.

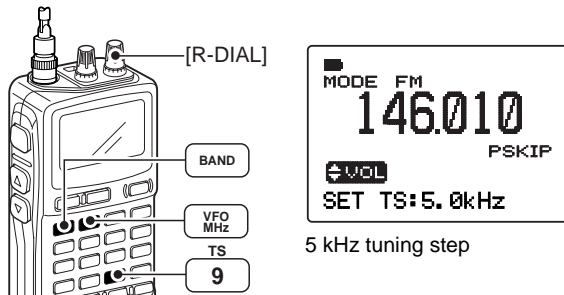

5 kHz tuning step

■ Setting a frequency

◆ Using the dial

- ① Push **[VFO MHz]** to select VFO mode, if necessary.
- ② Select the desired frequency band with **[BAND]**.
 - Or, while pushing and holding **[BAND]**, rotate **[R-DIAL]** to select the desired frequency band.
- ③ Rotate **[R-DIAL]** to select the desired frequency.
 - The frequency changes according to the preset tuning steps. See the left section for setting the tuning step.
 - Push **[VFO MHz]** for 1 sec. then rotate **[R-DIAL]** to change the frequency in 1 MHz steps, or push for 1 sec. again then rotate **[R-DIAL]** to change the frequency in 10 MHz steps. (Each push for 1 sec. toggles 1 MHz or 10 MHz tuning steps.)

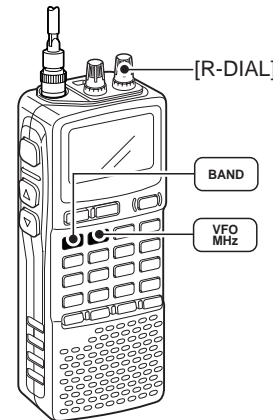

[R-DIAL] changes the frequency according to the selected tuning step.



While pushing [VFO MHz], [R-DIAL] changes the frequency in 1 MHz steps (default).

3 FREQUENCY AND CHANNEL SETTING

◆ Using the keypad

The frequency can be directly set via numeral keys.

- When editing a frequency outside of the frequency range, the previously displayed frequency is automatically recalled after editing last digit.

① Push **[VFO MHz]** to select VFO mode, if necessary.

② Enter the desired frequency via the keypad.

- Direct input can be set until 1 kHz digit, rotate **[R-DIAL]** to set below 1 kHz frequency after set tuning steps, if necessary. (See the previous page for setting the tuning step.)

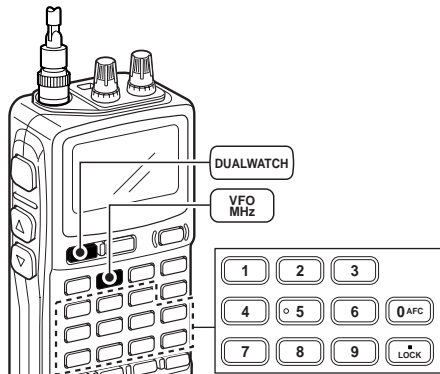

Pushing **[VFO MHz]** omits the entry of 100 kHz and below, when you want to edit to these digits "0." Push **[DUALWATCH]** to cancel the entry.

• Editing to 0.820 MHz • Editing to 1260 MHz • Changing 100 kHz and below.

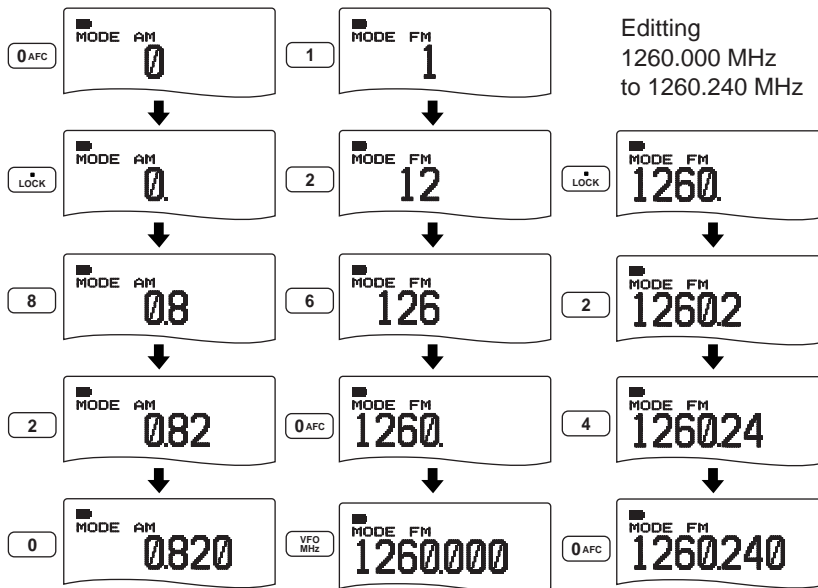

Receive mode selection

Receive modes are determined by the physical properties of the radio signals. The receiver has 6 receive modes: FM, WFM, AM, LSB, USB and CW modes. The mode selection is stored independently in each band and memory channels.

Typically, AM mode is used for the AM broadcast stations (0.495–1.620 MHz) and VHF air band (118–135.995 MHz), and WFM is used for FM broadcast stations (76–107.9 MHz).

➔ Push **[MODE SCAN]** momentarily several times to select the desired receive mode.

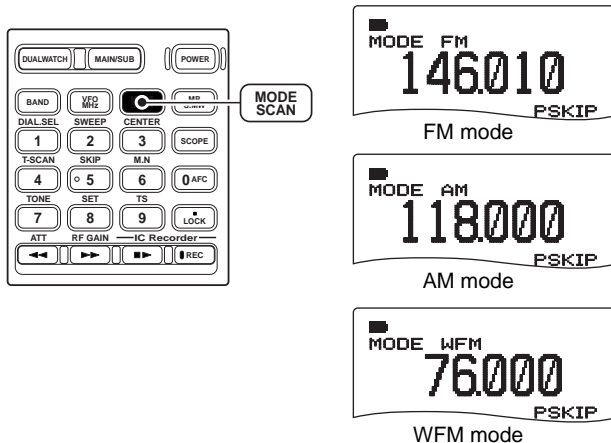

Lock function

To prevent accidental frequency changes and unnecessary function access, use the lock function.

- ➔ Push **[• LOCK]** for 1 sec. to turn the lock function ON and OFF.
 - “**+**” appears while the lock function is activated.
 - The squelch control and volume control can be used while the lock function is in use with default setting. Either or both the squelch control and volume control can also be locked in set mode. (p. 49)

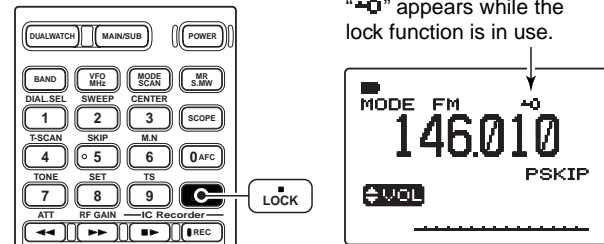

■ Receiving

Make sure charged battery pack (BP-206) or brand new alkaline batteries are installed (p. 8).

- ① Push **[POWER]** for 1 sec. to turn power ON.
- ② Rotate **[L-DIAL]** (or push **[▲]** or **[▼]**) to set the desired audio level.
 - The frequency display shows the volume level while setting. See the section at right for details.
- ③ Set the receiving frequency. (p. 14)
- ④ Set the squelch level. (p. 18)
 - While pushing **[SQL]**, rotate **[R-DIAL]**.
 - The first click of **[R-DIAL]** indicates the current squelch level.
 - "LEVEL 1" is loose squelch and "LEVEL 9" is tight squelch.
 - "AUTO" indicates automatic level adjustment with a noise pulse count system.
 - Push and hold **[SQL]** to open the squelch manually.
- ⑤ When a signal is received:
 - Squelch opens and audio is emitted.
 - The S-meter shows the relative signal strength level.

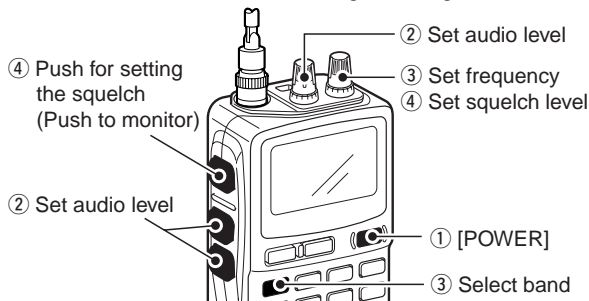

■ Setting audio volume

The audio level can be adjusted through 39 levels.

- ➔ Push and hold **[SQL]**, rotate **[L-DIAL]** (or push **[▲]** or **[▼]**) to adjust the audio level.
 - While using **[▲]**/**[▼]**, pushing and holding either key change the audio level continuously.
 - The display shows the volume level while setting.

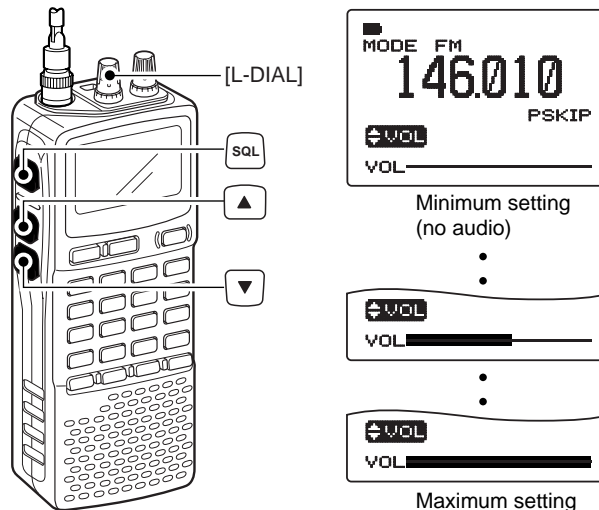

■ Squelch level setting

The squelch circuit mutes the received audio signal depending on the signal strength. The receiver has 9 squelch levels, a continuously open setting and an automatic squelch setting.

- ➔ While pushing and holding [SQL], rotate [R-DIAL] to select the squelch level.
 - “LEVEL 1” is loose squelch and “LEVEL 9” is tight squelch.
 - “AUTO” indicates automatic level adjustment with a noise pulse count system.
 - “OPEN” indicates continuously open setting.

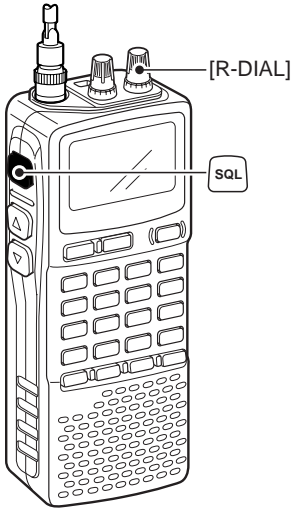

Automatic squelch



Maximum level

■ Monitor function

This function is used to listen to weak signals without disturbing the squelch setting or to open the squelch manually even when mute functions such as the tone squelch are in use.

- ➔ Push and hold [SQL] to monitor the operating frequency.
 - The 1st segment of the S-meter blinks.

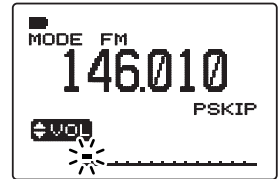
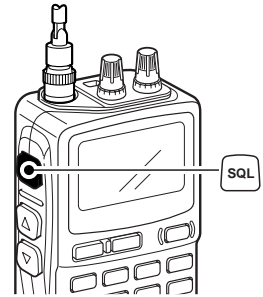

The 1st segment blinks

/// The [SQL] key can be set to 'sticky' operation in expanded set mode. See page 54 for details.

4 BASIC OPERATION

■ Attenuator function

The attenuator prevents a desired signal from distorting when very strong signals are near the desired frequency or when very strong electric fields, such as from a broadcasting station, are near your location. The attenuator gain is about 30 dB.

- Push [**ATT**] for 1 sec. to toggle the attenuator function ON and OFF.
 - “ATT” appears when the attenuator function is in use.

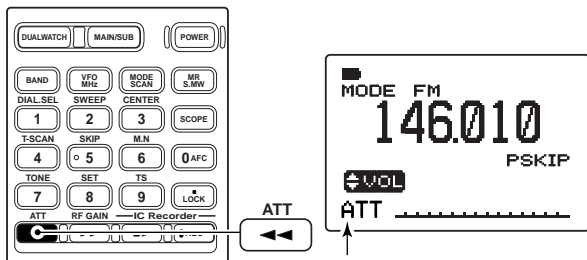

“ATT” appears while the attenuator functions is in use.

■ RF gain

The receiver gain can be reduced with the RF gain setting. This may help to remove undesired weak signals while monitoring strong signals. The RF gain may be useful for setting a minimum level at which to hear signals for SSB/CW modes .

- Push [**RF GAIN**] for 1 sec. to enter the RF gain setting condition, then rotate [**R-DIAL**] to select the desired RF gain level.
 - Normally this setting is used with maximum level.
 - Push [**DUALWATCH**] to exit the RF gain setting condition.

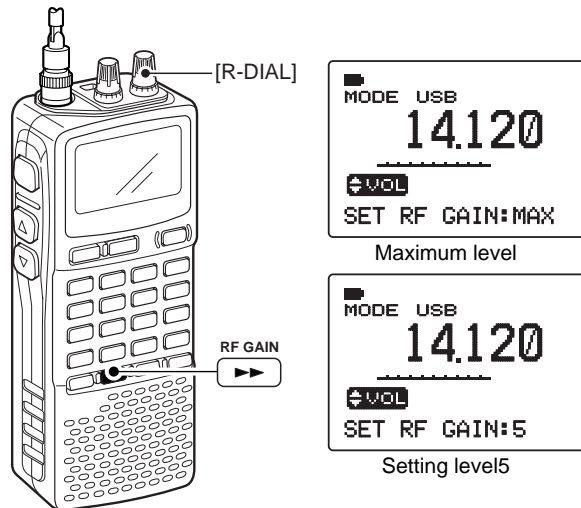

■ Duplex operation

Duplex communication uses 2 different frequencies for transmitting and receiving. Generally, duplex is used in communication through a repeater, some utility communications, etc.

During duplex operation, the transmit station frequency is shifted from the receive station frequency by the offset frequency. Repeater information (offset frequency and shift direction) can be programmed into memory channels. (p. 26)

◆ Setting

- ① Set the receive station frequency (repeater output frequency).
- ② Push **[8 SET]** for 1 sec. to enter set mode.
- ③ Rotate **[R-DIAL]** to select “SET EXPAND,” then push **[8 SET]**.

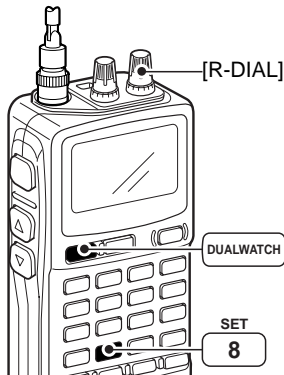

```

*** SET MODE ***
NOISE BLANKER
ANL
AF FILTER
AM ANTENNA
FM ANTENNA
>SET EXPAND
    
```

IN EXPANDED SET MODE

- ④ Rotate **[R-DIAL]** to select “ON,” then push **[8 SET]**.
- ⑤ Rotate **[R-DIAL]** to select “OFFSET FREQ,” then push **[8 SET]**.

```

OFFSET FREQ
0.000.00
    
```

- ⑥ Rotate **[R-DIAL]** to set the desired offset frequency within 0.00000–159.99999 MHz range, then push **[8 SET]**.
 - The tuning step, selected in VFO mode, is used for setting.
 - Push **[VFO MHz]** for 1 sec. then rotate **[R-DIAL]** to change the frequency in 1 MHz steps, or push for 1 sec. again then rotate **[R-DIAL]** to change the frequency in 10 MHz steps. (Each push for 1 sec. toggles 1 MHz or 10 MHz tuning steps.)
- ⑦ Rotate **[R-DIAL]** to select “DUPLEX.”

```

DUPLEX
>OFF
-DUP
+DUP
    
```

- ⑧ Rotate **[R-DIAL]** to select “–DUP” or “+DUP.”
- ⑨ Push **[DUALWATCH]** to exit set mode.
- ⑩ Push and hold **[SQL]** to monitor the transmit station frequency (repeater input frequency) directly.

4 BASIC OPERATION

■ AFC function

The AFC (Automatic Frequency Control) function tunes the displayed frequency automatically when an off-center frequency is received. It activates in FM/WFM modes only with single band operation.

- ➔ Push **[0 AFC]** to toggle the AFC function ON and OFF.
 - “AFC” appears when the AFC function is in use.

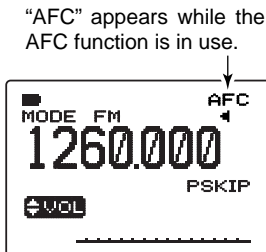
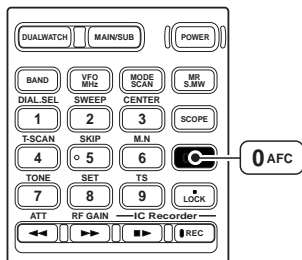

“◀” or “▶” appears when an off-frequency is received.

/// **NOTE:** The AFC function is not available during dualwatch operation.

■ NB/ANL function

The NB (noise blanker) function removes pulse-type noise when USB, LSB or CW mode is selected. The ANL (Automatic Noise Limiter) function reduces noise components when AM mode is selected.

“NB” appears while the NB function is in use.

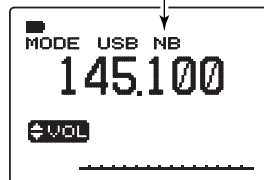

“ANL” appears while the ANL function is in use.



See page 22 for setting details.

/// **NOTE:** No display indication appears during dualwatch operation, but both functions are active while in specific modes.

■ Band scope

The band scope function allows you to visually check a specified frequency range. Sweep range can be selected from ± 14 kHz through ± 1400 kHz.

- ① Set the desired frequency as band scope center frequency.
- ② While pushing and holding [2 SWEEP], rotate [R-DIAL] to select the sweep steps, if desired.
 - Available steps are 1, 5, 6.25, 8.33, 9, 10, 12.5, 15, 20, 25, 30, 50 and 100 kHz.
 - Pushing [2 SWEEP] changes the sweep step and starts single sweeping at each times.

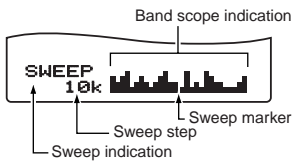
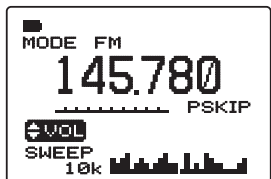
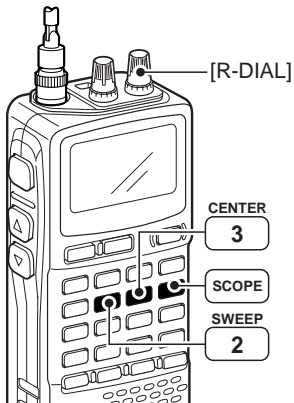

- ③ Push [SCOPE] momentarily to start single sweeping or push for 1 sec. to start continuous sweeping.
 - Signal conditions (strengths) appear starting from the center of the range.
- ④ Rotate [R-DIAL] to set the highlighted cursor to the desired waveform and set the frequency of the signal.
 - Push [3 CENTER] for 1 sec. to return to original sweep center frequency.
- ⑤ Push [DUALWATCH] to cancel sweeping and return to normal condition.

✓ CONVENIENT!

The scope function can also be started with the following operation for easy setting.

- ① Set the desired frequency as band scope center frequency.
- ② Push [2 SWEEP] for 1 sec. to start single sweeping.
 - Pushing [2 SWEEP] changes the sweep step and starts single sweeping at each times.

4 BASIC OPERATION

■ [DIAL] function assignment

The frequency control dial can be traded with an audio volume control dial or [▲]/[▼] keys to suit your preference.

➔ Push [1 DIAL.SEL] for 1 sec. to toggle the dial function from tuning dial and audio volume.

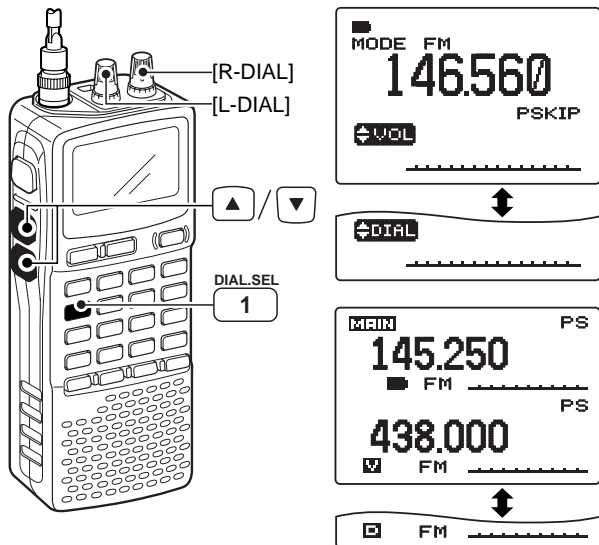

• Single band operation

	"VOL" indication	"DIAL" indication
[R-DIAL]	Frequency, Memory channel, Squelch level, Scanning direction, Set mode item and condition set	Audio volume set
[L-DIAL] [▲]/[▼]	Audio volume set	Frequency, Memory channel, Squelch level, Scanning direction, Set mode item and condition set

• Dualwatch operation

	"FM" indication	"DIAL" indication
[L-DIAL]	<ul style="list-style-type: none"> Frequency, Memory channel, Squelch level, Scanning direction for upper band Set mode item and condition set for MAIN band 	Audio volume set for upper band
[R-DIAL]	<ul style="list-style-type: none"> Frequency, Memory channel, Squelch level, Scanning direction for lower band Set mode item and condition set for MAIN band 	Audio volume set for lower band
[▲]/[▼]	Audio volume set for MAIN band	Frequency, Memory channel, Squelch level, Scanning direction, Set mode item and condition set for MAIN band

■ Main band selection

➔ Push [MAIN/SUB] momentarily to select the upper band or lower band as main band (operating band) alternately.

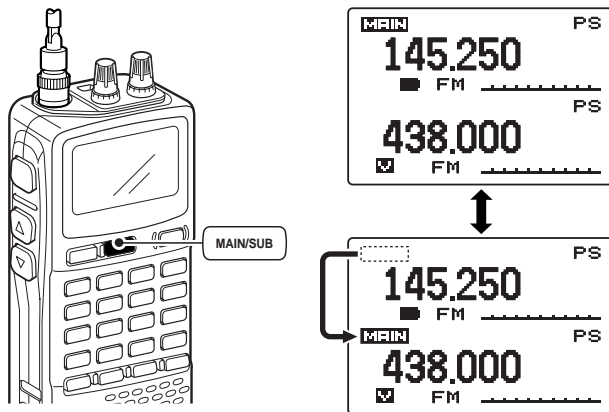

■ Band exchange

➔ Push [MAIN/SUB] for 1 sec to exchange the upper band's frequency and lower band's frequency.

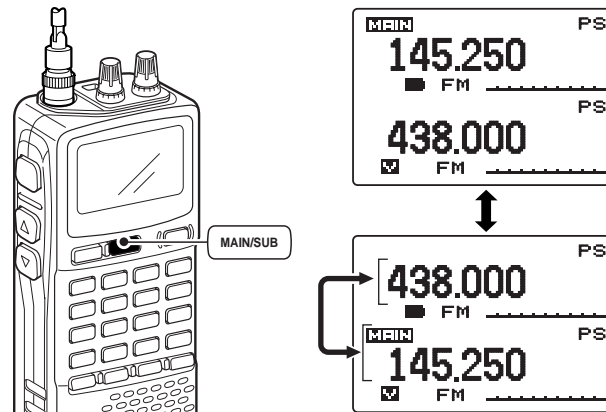

4

5

• Operating bands table for dualwatch operation

Band	A-side	B-side	Band	A-side	B-side
1 M	✓	—	300 MHz	✓	✓
AM (BC)	✓	—	400 MHz	✓	✓
HF bands	✓	—	800 MHz*	—	✓
FM (BC)	✓	—	1.2 GHz	—	✓
VHF air	✓	✓	2.4 GHz	—	—
144 MHz	✓	✓			

- The A-side is upper side on the display, and B-side is lower side, if the band exchange function (see above) is not performed (default).
- Available frequency bands are different depending on version. See the specification for details.
- *Some frequency ranges are prohibited for the USA version due to local regulation.

■ Setting audio volume

- ① Push **[DUALWATCH]** for 1 sec. to enter the dualwatch operation, if necessary
- ② Push and hold **[SQL]**, push **[▲]** or **[▼]** to adjust the audio level for the main band.
 - Pushing and holding either key changes the audio level continuously.
 - The display shows the volume level while setting.

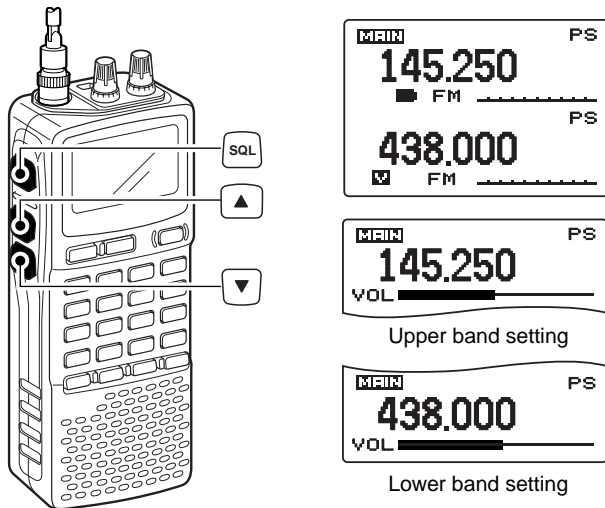

While pushing either **[▲]** or **[▼]**, rotate **[L-DIAL]** for upper band's volume adjustment, or **[R-DIAL]** for lower band's volume adjustment.

■ Squelch level setting

- ① Push **[DUALWATCH]** for 1 sec. to enter the dualwatch operation, if necessary
- ② While pushing and holding **[SQL]**, rotate **[L-DIAL]** for upper band's squelch adjustment, or rotate **[R-DIAL]** for lower band's squelch adjustment.
 - "LEVEL 1" is loose squelch and "LEVEL 9" is tight squelch.
 - "AUTO" indicates automatic level adjustment with a noise pulse count system.
 - "OPEN" indicates continuously open setting.

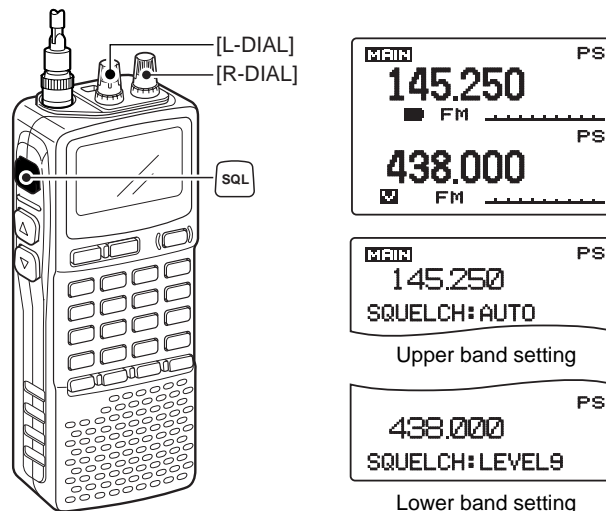

■ General description

The receiver has 1050 memory channels including 50 scan edge memory channels (25 pairs) for storage of often-used frequencies. And a total of 26 memory banks, A to Z are available for usage by group, etc. Up to 100 channels can be assigned into a bank.

◇ Memory channel contents

The following information can be programmed into memory channels:

- Operating frequency (p. 14)
- Receive mode (p. 16)
- Duplex direction (+DUP or -DUP) with an offset frequency (p. 20)
- Tone squelch or DTCS squelch ON/OFF (p. 45)
- Tone squelch frequency or DTCS code with polarity (p. 46)
- Scan skip information* (p. 39)

■ Memory channel programming

- ① Push **[VFO MHz]** to select VFO mode.
- ② Set the desired frequency:
 - Select the desired band with **[BAND]**.
 - Set the desired frequency with **[R-DIAL]**.
 - Or set the desired frequency with **[KEYPAD]**.
 - Set other data (e.g. offset frequency, duplex direction, tone squelch, etc.), if desired.
- ③ Push **[MR S.MW]** for 1 sec. to select the select memory write condition.
 - 1 short and 1 long beep sound.
 - "MR" indicator blinks.
- ④ Rotate **[R-DIAL]** to select the desired channel.
 - Scan edge channel, 00A/B to 24A/B can also be selected.
- ⑤ Push **[MR S.MW]** for 1 sec.
 - 3 beeps sound
 - Memory channel number automatically increases when continuing to push **[MR S.MW]** after programming.

[EXAMPLE]: Programming 145.870 MHz into memory channel 20 (blank channel).

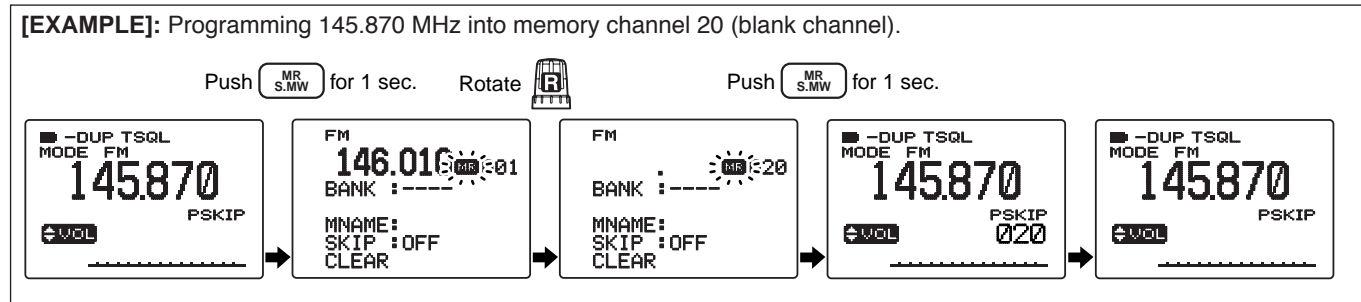

6 MEMORY CHANNELS

Memory bank setting

The IC-R20 has a total of 26 banks (A to Z). Regular memory channels, 000 to 999, are assigned into the desired bank for easy memory management.

- ① Push **[MR S.MW]** for 1 sec. to select the select memory write condition.
 - 1 short and 1 long beep sound.
 - “**MR**” indicator blinks.
- ② Rotate **[R-DIAL]** to select the desired memory channel.
- ③ While pushing **[8 SET]**, rotate **[R-DIAL]** to select “BANK.”
 - “BANK” item can also be selected by pushing **[8 SET]** several times.
 - Bank group and channel number is displayed if the selected memory channel has already been previously assigned into a bank.

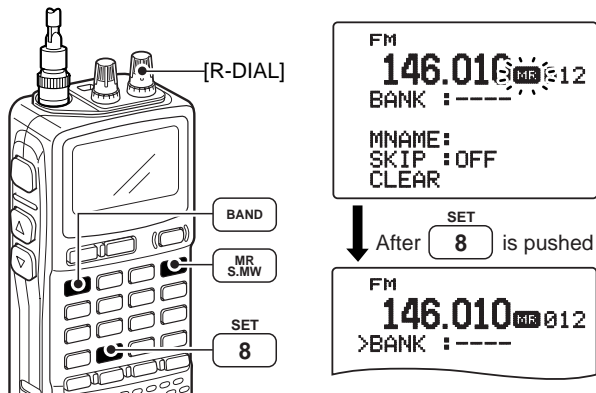

- ④ While pushing **[BAND]**, rotate **[R-DIAL]** to select the desired bank group from “A” to “Z.”
 - The bank group can also be selected by pushing **[BAND]** several times.

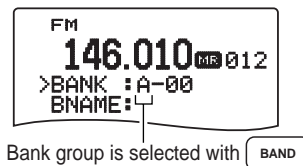

- ⑤ After releasing **[BAND]**, rotate **[R-DIAL]** to select the bank channel number from “00” to “99.”
 - Vacant bank channel numbers will only be displayed.

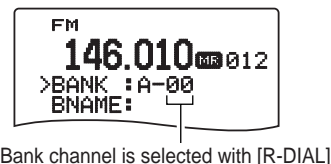

- ⑥ Push **[MR S.MW]** for 1 sec. to set the channel into the bank.
 - Return to the previous indication.

■ Memory bank selection

- ① Push **[MR S.MW]** to select memory mode.
- ② While pushing **[BAND]**, rotate **[R-DIAL]** to select the desired bank (A to Z).
 - The bank can also be selected by pushing **[BAND]** several times.
 - Only programmed banks are displayed.

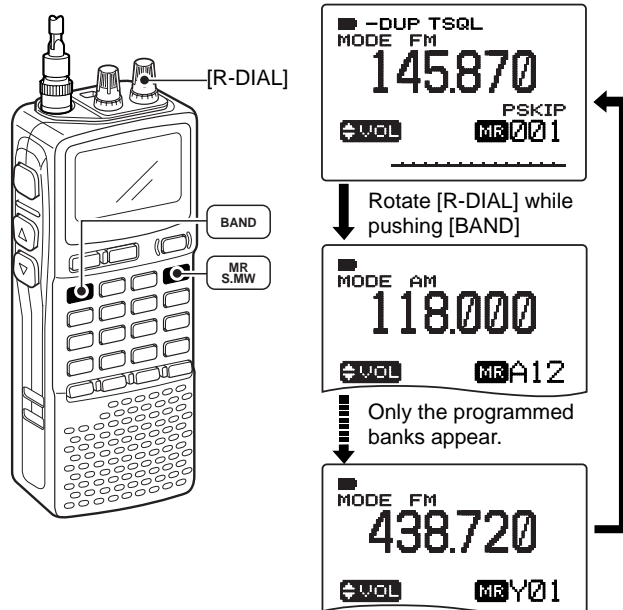

- ③ Rotate **[R-DIAL]** to select the bank channel.
 - Only programmed channels are displayed.

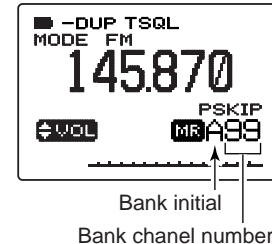

- ④ To return to regular memory condition, rotate **[R-DIAL]** while pushing **[BAND]**, or push **[BAND]** several times.

6 MEMORY CHANNELS

■ Programming memory/bank name

Each memory channel can be programmed with an alphanumeric channel name for easy recognition and can be indicated independently by channel. Names can be a maximum of 8 characters.

- ① Push **[MR S.MW]** to select memory mode.
- ② Rotate **[R-DIAL]** to select the desired memory channel.
- ③ Push **[MR S.MW]** for 1 sec. to select the select memory write condition.
 - 1 short and 1 long beep sound.
 - “MR” indicator blinks.



- ④ While pushing **[8 SET]**, rotate **[R-DIAL]** to select “BNAME” or “MNAME” when programming the memory name or the bank name, respectively.
 - The item can also be selected by pushing **[8 SET]** several times.
 - After selecting the memory or bank name programming condition, a cursor blinks for the first digit.

Bank name selection



Memory name selection

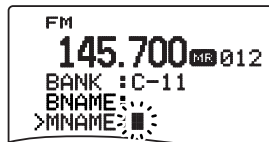

- ⑤ Rotate **[R-DIAL]** to select the desired character.
 - The selected character blinks.
 - While pushing **[6 M.N]**, rotate **[R-DIAL]** to select the character group.
- ⑥ While pushing **[BAND]**, rotate **[R-DIAL]** to move the cursor to left or right.
 - Push **[BAND]** to move the cursor to right.

Bank name



Memory name

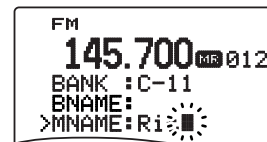

- ⑦ Repeat steps ⑤ and ⑥ until the desired 8-character channel names are displayed.
- ⑧ Push **[MR S.MW]** for 1 sec. to program the name and exit the channel name programming condition.
 - 3 beeps sound.

NOTE: Only one bank name can be programmed into each bank. Therefore, the previously programmed bank name will be displayed when bank name indication is selected. Also, the programmed bank name is assigned for the other bank channels automatically.

◆ Available characters

A B C D E F G H I J K L M N O P
Q R S T U V W X Y Z
ā b c d e f g h i j k l m n o p
q r s t u v w x y z
0 1 2 3 4 5 6 7 8 9
+ ← ↑ ↓ ! " # \$ % & ' () * + ,
- . / : ; < = > ? @ [\] ^ _ {
} ~
← → ↶ ↷ ↸ ↹
(space)

■ Selecting memory/bank name indication

During memory mode operation, one of the programmed memory name or bank name can be displayed below the frequency indication.

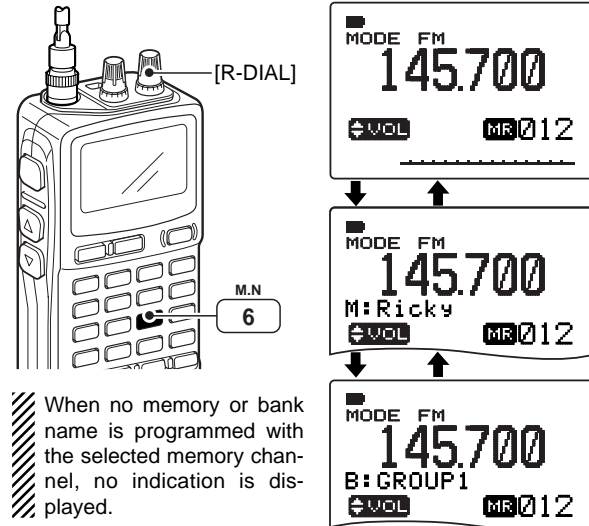

- ① Push **[MR S.MW]** to select memory mode.
 - Push **[BAND]** several times to select the desired bank group.
- ② While pushing **[6 M.N.]**, rotate **[R-DIAL]** to select display indication type from bank name or memory name.

■ Copying memory contents

This function transfers a memory channel's contents to VFO (or another memory channel). This is useful when searching for signals around a memory channel frequency and for recalling the offset frequency, subaudible tone frequency etc.

◇ Memory ↔ VFO

- ① Select the memory channel to be copied.
 - ➔ Push **[MR S.MW]** to select memory mode, then rotate **[R-DIAL]** to select the desired memory channel.
 - Select the bank channel with **[BAND]** and **[R-DIAL]**, if desired.
- ② Push **[MR S.MW]** for 1 sec. to select the select memory write condition.
 - 1 short and 1 long beep sound.
 - “**MR**” indicator blinks.
- ③ Push **[VFO MHz]** to select “VFO.”
 - Rotate **[R-DIAL]** can also select “VFO.”
- ④ Push **[MR S.MW]** for 1 sec. to write the selected channel contents to VFO mode.
 - Returns to VFO mode automatically.

/// Pushing **[MR S.MW]** for 2 sec. at the step ②, will also copy the memory contents to VFO. In this case, the steps ③ and ④ are not necessary.

◇ Memory ↔ memory

- ① Select the memory channel to be copied.
 - ➔ Push **[MR S.MW]** to select memory mode, then rotate **[R-DIAL]** to select the desired memory channel.
- ② Push **[MR S.MW]** for 1 sec. to select the select memory write condition.
 - 1 short and 1 long beep sound.
 - “**MR**” indicator blinks.
 - Do not hold **[MR S.MW]** for more than 1 sec. otherwise the memory contents will be copied to VFO.
- ③ Rotate **[R-DIAL]** to select the target memory channel.
- ④ Push **[MR S.MW]** for 1 sec. again to copy.

[EXAMPLE]: Copying channel 20 to 51.

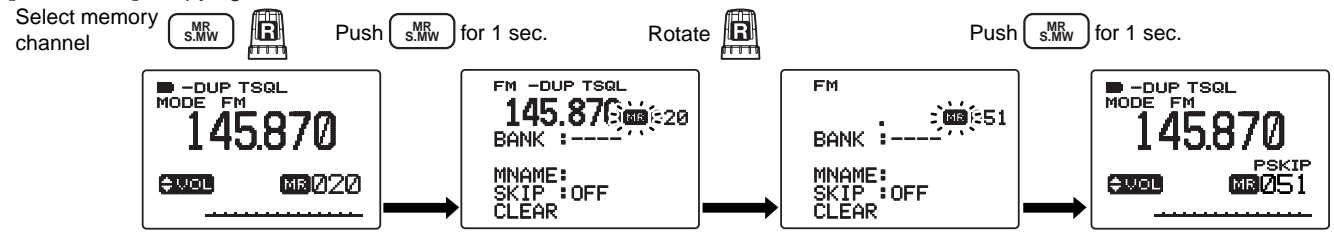

Memory clearing

Contents of programmed memories can be cleared (blanked), if desired.

- ① Push **[MR S.MW]** for 1 sec. to select the select memory write condition.
 - 1 short and 1 long beeps sound.
 - “**MR**” indicator blinks.
 - Do not hold **[MR S.MW]** for more than 2 sec. otherwise the memory contents will be copied to VFO.
- ② Rotate **[R-DIAL]** to select the desired memory channel to be cleared.
- ③ While pushing **[8 SET]**, rotate **[R-DIAL]** to select “CLEAR.”
 - “CLEAR” item can also be selected by pushing **[8 SET]** several times.

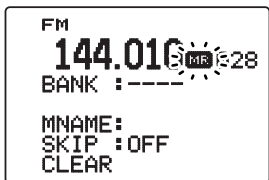
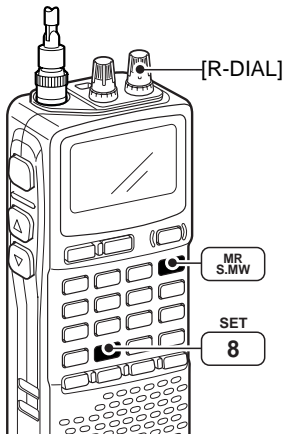

After **SET 8** is pushed several times.

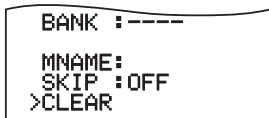

- ④ Push **[MR S.MW]** for 1 sec. to clear the contents.
 - 3 beeps sound.
 - The cleared channel changes to blank channel
 - Return to the select memory write condition. — “**MR**” indicator blinks. Push **[DUALWATCH]** to exit the select memory write condition, then push **[VFO MHz]** to return to VFO mode.

Push **MR S.MW** for 1 sec.

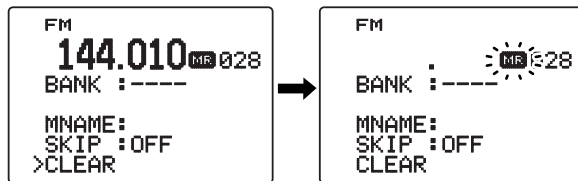

NOTE: Be careful!— the contents of cleared memories **CANNOT** be recalled even in bank channel operation.

Erasing/transferring bank contents

The bank contents of programmed memory channels can be cleared or reassigned to another memory bank.

INFORMATION: Even if the memory bank contents are cleared, the memory channel contents still remain programmed.

- ① Select the desired bank contents to be transferred or erased from the bank.
 - ➔ Push **[MR S.MW]** to select memory mode.
 - ➔ While pushing **[BAND]**, rotate **[R-DIAL]** to select the desired memory bank group.
 - ➔ Rotate **[R-DIAL]** to select the bank channel.
- ② Push **[MR S.MW]** for 1 sec. to enter the select memory write condition.
 - 1 short and 1 long beeps sound.
 - Displays the original memory channel number automatically and “**MR**” indicator blinks.
 - Do not hold **[MR S.MW]** for more than 2 sec., otherwise the memory contents will be copied to VFO.

Push **[MR S.MW]** for 1 sec.

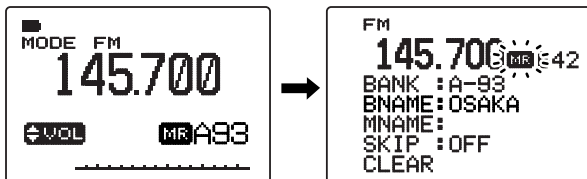

- ③ Push **[8 SET]** once to select “BANK.”
 - While pushing **[8 SET]** then rotate **[R-DIAL]** also selectable “BANK.”
- ④ While pushing **[BAND]**, rotate **[R-DIAL]** to select the desired bank group to be transfer.
 - Select “----” indication when erasing the contents from the bank.

When transferring



When erasing

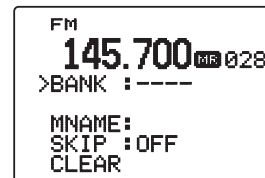

- ⑤ Rotate **[R-DIAL]** to select the desired bank channel.
- ⑥ Push **[MR S.MW]** for 1 sec.

■ Scan types

Scanning searches for signals automatically and makes it easier to locate new stations for contact or listening purposes.

There are 7 scan types and 4 resume conditions to suit your operating needs. The scan speed is at 100 ch/sec. (approx.) for VFO scan, 20 ch/sec. (approx) for memory scan.

FULL SCAN (p. 35)

Repeatedly scans all frequencies over the entire band.

Some frequency ranges are not scanned according to the frequency coverage of the receiver's version.

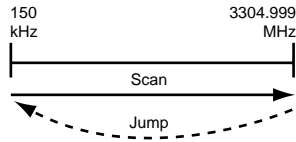

SELECTED BAND SCAN (p. 35)

Repeatedly scans all frequencies over the entire selected band.

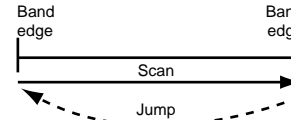

PROGRAMMED SCAN (p. 37)

Repeatedly scans between two user-programmed frequencies. Used for checking for frequencies within a specified range such as repeater output frequencies, etc.

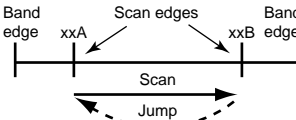

MEMORY (SKIP) SCAN (p. 37)

Repeatedly scans memory channels except those set as skip channel. Skip channels can be turned ON and OFF by pushing and holding [5 SKIP] in memory mode.

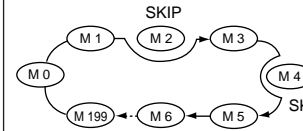

ALL/SELECTED BANK SCAN (p. 37)

Repeatedly scans all bank channels or selected bank channels. The skip scan is also available.

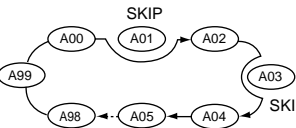

FREQUENCY/MEMORY SKIP FUNCTION (p. 39)

Skips unwanted frequencies or channels that inconveniently stop scanning. This function can be turned ON and OFF by pushing and holding [5 SKIP] in either VFO or memory mode.

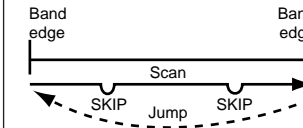

■ Full/band/programmed scan

- ① Select VFO mode with [VFO MHz].
 - Select the desired frequency band with [BAND], if desired.
- ② Set the squelch level.
- ③ While pushing and holding [MODE SCAN], rotate [R-DIAL] to select the desired scanning type.
 - “ALL” for full scan; “BAND” for band scan, “PROG-xx” for programmed scan (xx= 0 to 24; programmed scan edges numbers only displayed)

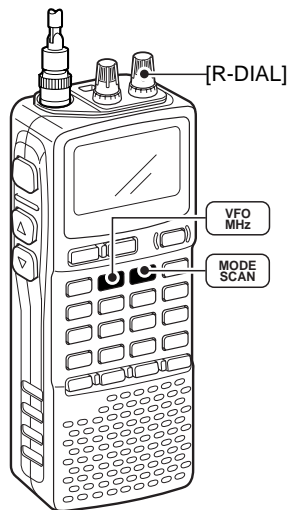

• Full scan selection



• Band scan selection



• Programmed scan selection

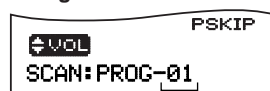

Selectable between “00” to “24” if programmed

- ④ To start the scan, release [MODE SCAN].
 - Scan pauses when a signal is received.
 - Rotate [R-DIAL] to change the scanning direction, or resumes manually.
 - Push [DUALWATCH] again to stop the scan.

• During full/band scan

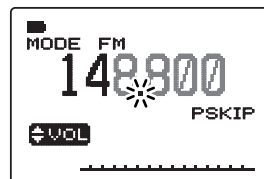

• During programmed scan

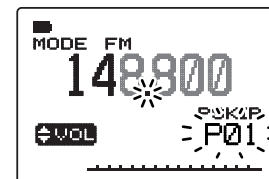

/// **About the scanning steps:** The selected tuning step in each frequency band (in VFO mode) is used during scan.

■ Scan edges programming

Scan edges can be programmed in the same manner as memory channels. Scan edges are programmed into scan edges, 00A/00B to 24A/24B, in memory channels.

- ① Push **[VFO MHz]** to select VFO mode.
- ② Set the desired frequency:
 - ➔ Select the desired band with **[BAND]**.
 - ➔ Set the desired frequency with **[R-DIAL]**.
 - ➔ Set other data (e.g. offset frequency, duplex direction, tone squelch, etc.), if desired.
- ③ Push **[MR S.MW]** for 1 sec. to select select memory write condition.
 - 1 short and 1 long beeps sound.
 - “**MR**” indicator blinks.
- ④ Rotate **[R-DIAL]** to select the desired programmed scan edge channel from 00A to 24A.

- ⑤ Push **[MR S.MW]** for 1 sec.
 - 3 beeps sound
 - The other scan edge channel “B,” 00B to 24B, automatically selected when continuing to push **[MR S.MW]** after programming.
- ⑥ To program a frequency for the other pair of scan edges, 00B to 24B, repeat steps ② and ④.
 - If the same frequency is programmed into a pair of scan edges, programmed scan will not function.

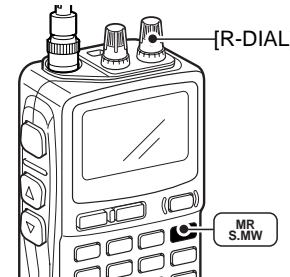

[EXAMPLE]: Programming 145.300 MHz into scan edges 03A.

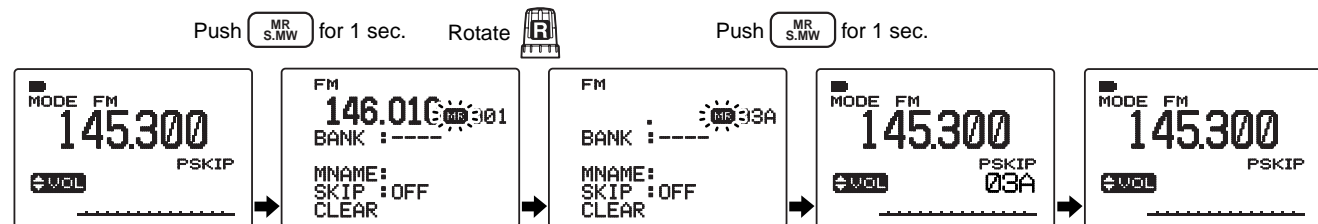

Memory/bank/all bank scan

- ① Select memory mode with **[MR S.MW]**.
 - Select the desired bank with **[BAND]** for bank scan.
- ② Set the squelch level.
- ③ While pushing and holding **[MODE SCAN]**, rotate **[R-DIAL]** to select the desired scanning type.
 - “ALL” for all bank scan; “BANK-LINK” for bank link scan or “BANK-x” for bank scan. (x= A to Z; programmed bank groups only displayed.)

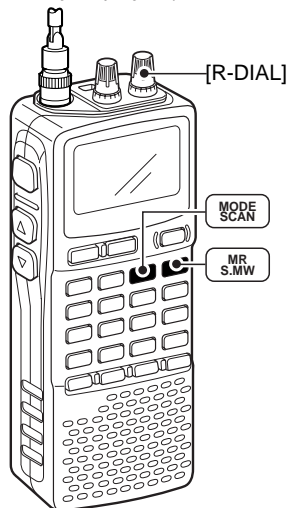

• Full memory scan selection

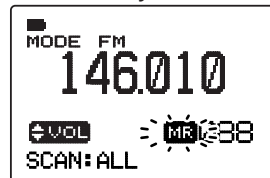

• Band link scan selection



• Bank scan selection



Selectable between “A” to “Z” if programmed

- ④ Release **[MODE SCAN]** to start the selected scan.
 - Scan pauses when a signal is received.
 - Rotate **[R-DIAL]** to change the scanning direction, or resumes manually.
- ⑤ To stop the scan, push **[DUALWATCH]**.

• During memory/all/bank scan • During bank scan

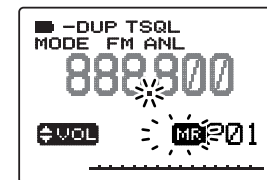
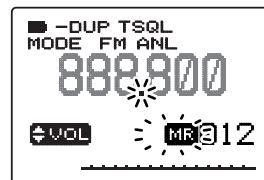

IMPORTANT! To perform memory or bank scan, 2 or more memory/bank channels **MUST** be programmed, otherwise the scan will not start.

The bank-link setting can be changed in expanded set mode. See page 58 for details.

■ Auto-memory write scan

This scan is useful for searching a specified frequency range and automatically storing busy frequencies into memory channels. The auto-memory write scan is performed with any VFO scan types (ALL, BAND, PROG).

- ① Select VFO mode with [VFO MHz].
- ② Push and hold [MODE SCAN] to enter scanning type selection condition.
- ③ Rotate [R-DIAL] to select the desired scanning type.
 - “ALL” for full scan; “BAND” for band scan, “PROG-xx” for programmed scan (xx= 0 to 24; programmed scan edges numbers only displayed)
- ④ Release [MODE SCAN] to start the scan.
- ⑤ Push [MR S.MW] to turn the automatic memory write function ON and OFF.
 - “MR” indicator blinks.

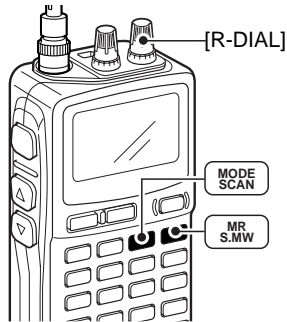

• During auto memory write scan

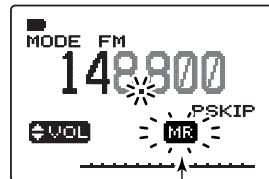

“MR” indicator blinks during auto memory write scan.

- ⑥ Push [DUALWATCH] to stop the scan.

◇ During auto-memory write scanning:

- When a signal is received, scan pauses and the frequency is stored into auto-memory write channel group (AW 000 – AW 199).
 - 2 short beeps sound when stored.
- Scan resumes after frequency storing.
- When all channels are stored, the scan is cancelled automatically and 1 long beep sounds.

◇ Recalling the stored frequencies:

- ① Push [MR S.MW] several times to select the auto-memory write channel group.

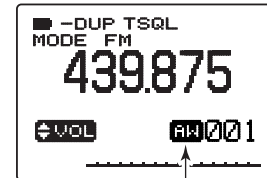

“AW” appears when auto memory write channel group is selected.

- ② Rotate [R-DIAL] to select the desired channel.

◇ Clearing the stored frequencies:

- ① Select the auto-memory write channel group.
- ② Push [5 SKIP] for 1 sec. to clear the all channels contents.
 - 1 short and 1 long beeps sound.

/// **NOTE:** The auto-memory write channel contents CANNOT be cleared by an independent channel. Thus it is a good idea to copy the contents into regular memory channel.

■ Skip channel/frequency setting

Memory channels can be set to be skipped for memory skip scan. In addition, memory channels can be set to be skipped for both memory skip scan and frequency skip scan. These are useful to speed up the scan interval.

- ① Select a memory channel:
 - ➔ Push **[MR S.MW]** to select memory mode.
 - ➔ Rotate **[R-DIAL]** to select the desired channel to be a skip channel/frequency.
- ② Push **[MR S.MW]** for 1 sec. to enter the select memory write condition.
- ③ Push **[8 SET]** several times to select "SKIP."
 - While pushing **[8 SET]**, rotating **[R-DIAL]** can also select "SKIP."

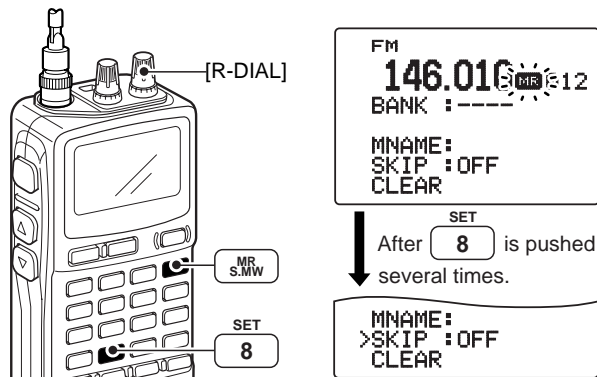

- ④ Rotate **[R-DIAL]** to select the skip condition from "SKIP," "PSKIP" or "OFF" for the selected channel.
 - PSKIP : The channel is skipped during memory/bank scan and the programmed frequency is skipped during VFO scan, such as programmed scan.
 - SKIP : The channel is skipped during memory or bank scan.
 - OFF : The channel or programmed frequency is scanned during any scan.
- ⑤ Push **[MR S.MW]** for 1 sec. to store the skip condition into the memory.
 - "SKIP" or "PSKIP" indicator appears, according to the skip selection in the step ④.

• Skip channel setting

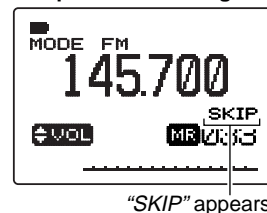

• Program skip setting

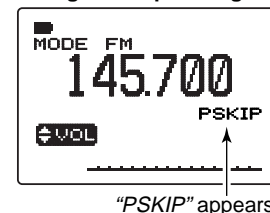

✓ CONVENIENT!

Also the skip setting can be set with the following operation for easy setting.

- ① Select the desired memory channel to be set as a skip channel/frequency.
- ② While pushing **[5 SKIP]**, rotate **[R-DIAL]** to select the skip condition from "PSKIP," "SKIP" and "OFF (no indication)."

■ Scan resume condition

◆ Scan pause timer

The scan pauses when receiving signals according to the scan pause time. It can be set from 2 to 20 sec. or unlimited.

- ① Push **[8 SET]** for 1 sec. to enter set mode.
- ② Rotate **[R-DIAL]** to select "SET EXPAND," then push **[8 SET]**.
- ③ Rotate **[R-DIAL]** to turn the expand set mode selection ON, then push **[8 SET]**.
- ④ Rotate **[R-DIAL]** to select "SCAN PAUSE," then push **[8 SET]**.
- ⑤ Rotate **[R-DIAL]** to set the desired scan time to pause from 2–20 sec. (2 sec. steps) and "HOLD," then push **[8 SET]**.
 - "2SEC"–"20SEC": Scan pauses for 2–20 sec. while receiving a signal.
 - "HOLD" : Scan pauses on a received a signal until it disappears.
- ⑥ Push **[DUALWATCH]** to exit set mode.

IN EXPANDED SET MODE

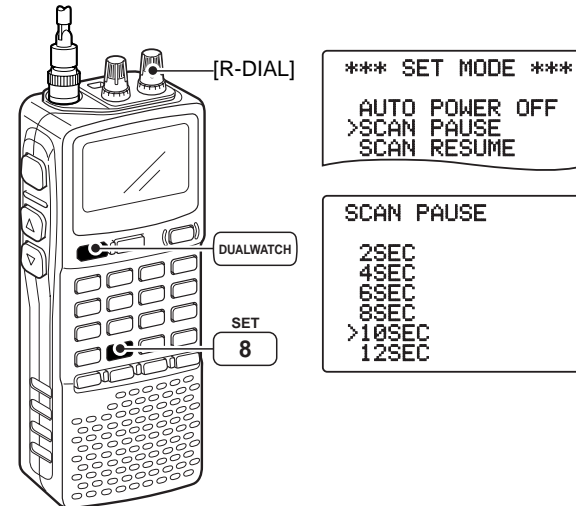

7 SCAN OPERATION

◆ Scan resume timer

The scan restarts after the signal disappears according to the resume time. It can be set from 0–5 sec. or unlimited.

- ① Push [**8 SET**] for 1 sec. to enter set mode.
- ② Rotate [**R-DIAL**] to select “SET EXPAND,” then push [**8 SET**].
- ③ Rotate [**R-DIAL**] to turn the expand set mode selection ON, then push [**8 SET**].
- ④ Rotate [**R-DIAL**] to select “SCAN RESUME,” then push [**8 SET**].
- ⑤ Rotate [**R-DIAL**] to set the desired scan resume timer from 0–5 sec. (1 sec. steps) and “HOLD.”
 - “0SEC” : Scan restarts immediately after the signal disappears.
 - “1SEC”–“5SEC” : Scan restarts 1–5 sec. after the signal disappears.
 - “HOLD” : Scan restarts by rotating [**R-DIAL**] only.
- ⑥ Push [**DUALWATCH**] to exit set mode.

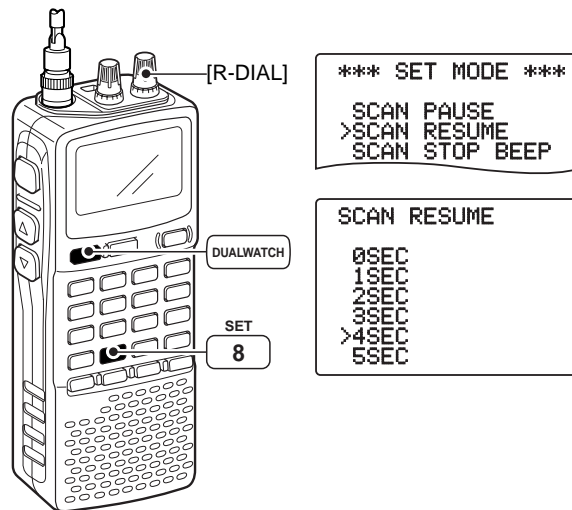

■ Priority watch types

Priority watch checks for signals on the frequency every 5 sec. while operating on a VFO frequency or scanning. The receiver has 3 priority watch types to suit your needs.

The watch resumes according to the selected scan resume condition. See the left page for details.

/// **NOTE:** If the pocket beep function is activated, the receiver automatically selects the tone squelch function when priority watch starts.

◇ About priority beep function

When receiving a signal on the priority frequency, you can be alerted with beeps and a blink “((•)).” This function can be activated when setting the priority watch function ON.

MEMORY CHANNEL WATCH

While operating on a VFO frequency, priority watch checks for a signal on the selected memory channel every 5 sec.

- A memory channel with skip information can be watched.

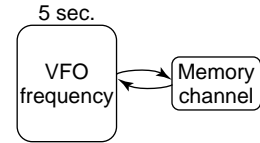

MEMORY SCAN WATCH

While operating on a VFO frequency, priority watch checks for signals on each memory channel in sequence.

- The memory skip function and/or memory bank scan is useful to speed up the scan.

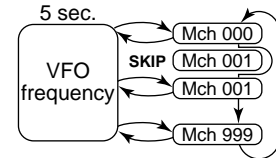

VFO SCAN WATCH

While scanning on VFO mode, priority watch checks for signals on the selected memory channel every 5 sec.



Priority watch operation

Memory channel watch and memory scan watch

- ① Select VFO mode; then, set an operating frequency.
- ② Set the watching channel(s).

For memory channel watch:

Select the desired memory channel.

For memory scan watch:

Select memory mode, or the desired bank group; then, push [MODE SCAN] for 1 sec. to start memory/bank scan.

- ③ Push [8 SET] for 1 sec. to enter set mode.
- ④ Rotate [R-DIAL] to select "PRIORITY WATCH," then push [8 SET].
- ⑤ Rotate [R-DIAL] to turn the priority watch ON, then push [8 SET].
 - Select "BELL" if the priority beep function is necessary.

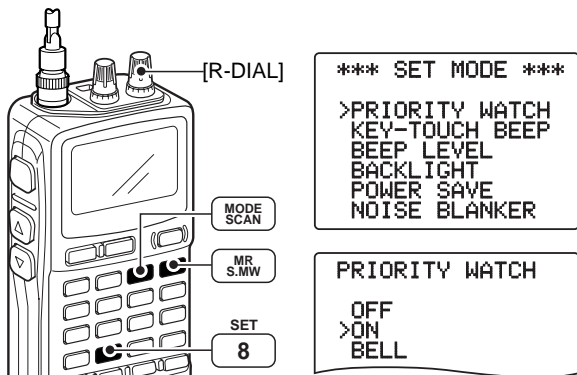

- ⑥ Push [DUALWATCH] to exit set mode and start the watch.
 - "PRIO" indicator appears.
 - The receiver checks the memory/bank channel(s) every 5 sec.
 - The watch resumes according to the selected scan resume condition. (p. 41)

During priority watch



Monitors VFO frequency for 5 sec.

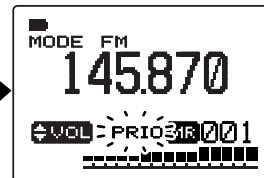

Pauses on a memory (bank) channel when a signal is received.

During priority watch with priority beep



Emits beep and blinks "(••)" indicator when a signal is received on a memory (bank) channel.



- ⑦ Push [DUALWATCH] to cancel the watch.

◆ VFO scan watch

- ① Select memory mode.
 - Select a memory bank, if desired.
- ② Push **[MODE SCAN]** for 1 sec. to start memory/bank scan, if desired.

▨ While scanning memory/bank channels:

▨ Starts memory/bank scan first. Memory/bank scan cannot be started after VFO scan is started.

- ③ Push **[8 SET]** for 1 sec. to enter set mode.
- ④ Rotate **[R-DIAL]** to select “PRIO,” then push **[8 SET]**.
- ⑤ Rotate to turn the priority watch ON, then push **[8 SET]**.
 - Select “BELL” if the priority beep function is necessary.
- ⑥ Push **[DUALWATCH]** to exit set mode and start the watch.
 - “PRIO” indicator appears.
- ⑦ Push and hold **[MODE SCAN]** to enter scan type selection condition.
- ⑧ Rotate **[R-DIAL]** to select the desired scan type from “ALL,” “BAND” and “PROG-xx (xx= 0–24).”
- ⑨ Release **[MODE SCAN]** to start the VFO scan watch.
 - The receiver checks the memory channel(s) every 5 sec.
 - The watch resumes according to the selected scan resume condition. (p. 41)
- ⑩ Push **[DUALWATCH]** to cancel the watch and scan.

• During priority watch

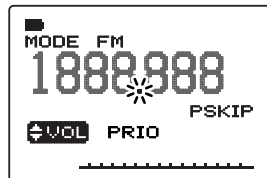

Monitors VFO frequency for 5 sec.



Pauses on a memory (bank) channel when a signal is received.

• During priority watch with priority beep

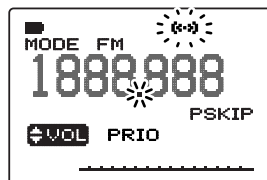

Emits beep and blinks “(••)” indicator when a signal is received on a memory (bank) channel.

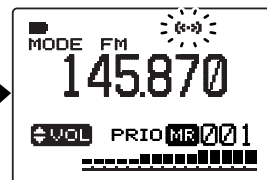

■ Tone/DTCS squelch operation

The tone or DTCS squelch opens only when receiving a signal with the same pre-programmed subaudible tone or DTCS code, respectively. You can silently wait for the specified signal using the same tone.

- ① Set the desired frequency in FM mode.
- ② While pushing **[7 TONE]**, rotate **[R-DIAL]** to select the desired squelch condition from "TSQL," "TSQL ((•))," "DTCS," "DTCS ((•))," "VSC" and "OFF."
 - One of "TSQL," "TSQL ((•))," "DTCS," "DTCS ((•))" and "VSC" appears according to the squelch selection.

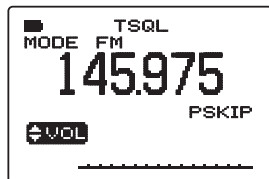
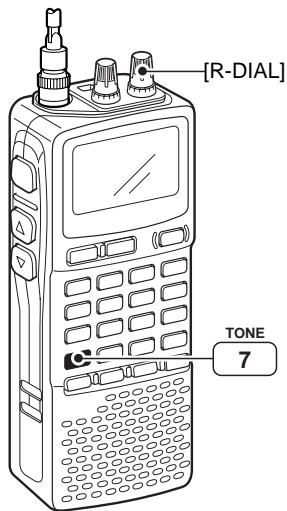

TSQL appears

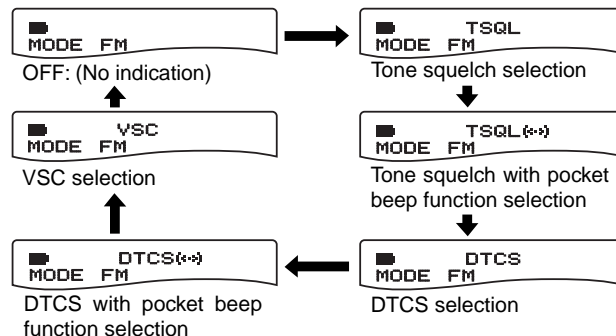

- ③ When a signal with the matched tone is received, the squelch opens and the receiver emits audio. When pocket beep function is activated, the receiver also emits beep tones and blinks "((•))".
 - Beep tones sound and "((•))" blinks for 30 sec.
- ④ Push **[DUALWATCH]** to stop the beeps and blinking manually.
 - "((•))" disappears and the pocket beep function is deactivated.
- ⑤ To cancel the tone squelch or DTCS, rotate **[R-DIAL]** while pushing **[7 TONE]** to tone indication disappears.

NOTE: The VSC (Voice Squelch Control) function opens the squelch only when receiving a modulated signal. This function is very useful while scanning, the VSC pauses only when modulated signals are received. Scanning continues when unmodulated or beat signals are received.

■ Tone squelch frequency/DTCS code setting

88.5 Hz and 023 is set as the default for the tone squelch frequency and the DTCS code, respectively. The frequency and code can be selected as desired.

- ① Push **[8 SET]** for 1 sec. to enter set mode.
- ② Rotate **[R-DIAL]** to select "SET EXPAND," then push **[8 SET]**.
- ③ Rotate **[R-DIAL]** to turn the expanded set mode ON, then push **[8 SET]**.
- ④ Rotate **[R-DIAL]** to select "TONE FREQ" when selecting the tone squelch frequency; select "DTCS CODE" when selecting the DTCS code, then push **[8 SET]**.

Tone squelch frequency selection

```

*** SET MODE ***

OFFSET FREQ
DUPLEX
>TONE FREQ
DTCS CODE
DTCS POLARITY
BANK LINK
  
```

Push **SET**
8

```

TONE FREQ
88.5
  
```

DTCS code selection

```

*** SET MODE ***

OFFSET FREQ
DUPLEX
>TONE FREQ
DTCS CODE
DTCS POLARITY
BANK LINK
  
```

Push **SET**
8

```

DTCS CODE
023
  
```

- ⑤ Rotate **[R-DIAL]** to select the desired tone squelch frequency or DTCS code, then push **[8 SET]**.

• See the tables at below.

- ⑥ Push **[DUALWATCH]** to exit set mode.

• Available tone frequency list

67.0	79.7	94.8	110.9	131.8	156.7	171.3	186.2	203.5	229.1
69.3	82.5	97.4	114.8	136.5	159.8	173.8	189.9	206.5	233.6
71.9	85.4	100.0	118.8	141.3	162.2	177.3	192.8	210.7	241.8
74.4	88.5	103.5	123.0	146.2	165.5	179.9	196.6	218.1	250.3
77.0	91.5	107.2	127.3	151.4	167.9	183.5	199.5	225.7	254.1

NOTE: The receiver has 50 tone frequencies and consequently their spacing is narrow compared to units having 38 tones. Therefore, some tone frequencies may receive interference from adjacent tone frequencies.

• Available DTCS code list

023	054	125	165	245	274	356	445	506	627	732
025	065	131	172	246	306	364	446	516	631	734
026	071	132	174	251	311	365	452	523	632	743
031	072	134	205	252	315	371	454	526	654	754
032	073	143	212	255	325	411	455	532	662	
036	074	145	223	261	331	412	462	546	664	
043	114	152	225	263	332	413	464	565	703	
047	115	155	226	265	343	423	465	606	712	
051	116	156	243	266	346	431	466	612	723	
053	122	162	244	271	351	432	503	624	731	

■ DTCS polarity setting

As well as the code setting, the polarity setting is also available for the DTCS operation. When a different polarity is set, the DTCS never releases audio mute even when a signal with matched code number is received.

- ① Push **[8 SET]** for 1 sec. to enter set mode.
- ② Rotate **[R-DIAL]** to select “SET EXPAND,” then push **[8 SET]**.
- ③ Rotate **[R-DIAL]** to turn the expanded set mode ON, then push **[8 SET]**.
- ④ Rotate **[R-DIAL]** to select “DTCS POLARITY,” then push **[8 SET]**.

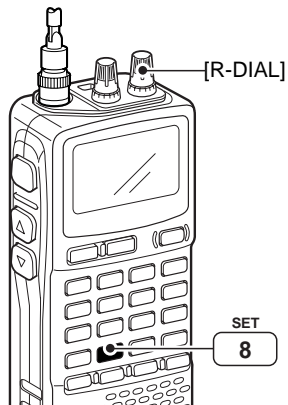

```
*** SET MODE ***  
OFFSET FREQ  
DUPLEX  
TONE FREQ  
DTCS CODE  
>DTCS POLARITY  
BANK LINK
```

- ⑤ Rotate **[R-DIAL]** to select the polarity from “NORMAL” and “REVERSE,” then push **[8 SET]**.

```
DTCS POLARITY  
>NORMAL  
REVERSE
```

Normal polarity

```
DTCS POLARITY  
NORMAL  
>REVERSE
```

Reverse polarity

- ⑥ Push **[DUALWATCH]** to exit set mode.

■ Tone scan

By monitoring a signal that is being operated with pocket beep, tone or DTCS squelch function, you can determine the tone frequency or DTCS code necessary to open a squelch.

- ① Set the frequency to be checked for a tone frequency or code.
- ② Turn the desired tone type, tone squelch or DTCS, ON by holding [7 TONE] with turning [R-DIAL].
 - One of “TSQL” or “DTCS” appears.
 - Even when the pocket beep function is activated, the function is cancelled when starts the tone scan.
- ③ Push [4 T-SCAN] for 1 sec. to start the tone scan.
 - To change the scanning direction, rotate [R-DIAL].

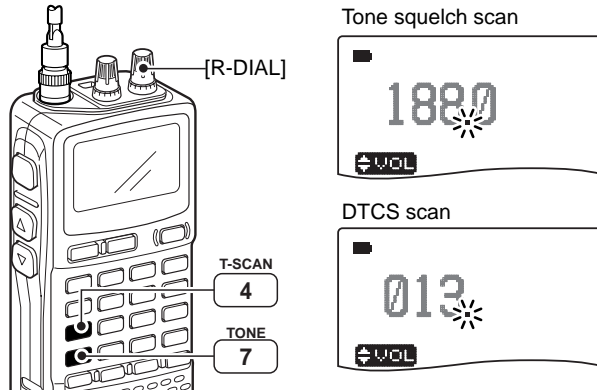

- ④ When the CTCSS tone frequency or 3-digit DTCS code is matched, the squelch opens and the tone frequency or code is temporarily programmed into the selected condition, such as memory channel.
 - The tone scan pauses when a CTCSS tone frequency or 3-digit DTCS code is detected.

NOTE: The decoded tone frequency or code is programmed temporarily when a memory channel is selected. However, this will be cleared when the memory channel is re-selected.

✓ For your convenient!

Even if no tone type is selected, either tone squelch or DTCS, pushing [4 T-SCAN] for 1 sec. will also start tone scan. In this case, the tone scan searching for tone squelch frequency only.

10 SET MODE

■ General

Set mode is used for programming infrequently changed values or conditions of functions.

In addition, the IC-R20 has an expanded set mode which is used for programming even more infrequently changed values or conditions of functions. When turning the expanded set mode OFF, only about one third of the set mode items are displayed for simple operation.

◆ Set mode entering and operation

- ① Push **[8 SET]** for 1 sec. to enter set mode.
- ② Rotate **[R-DIAL]** to select the desired item, then push **[8 SET]**.
- ③ Rotate **[R-DIAL]** to select the desired value or condition, then push **[8 SET]** to return the setting item selection mode.
- ④ Push **[DUALWATCH]** to exit set mode, or rotate **[R-DIAL]** to select another set mode item.

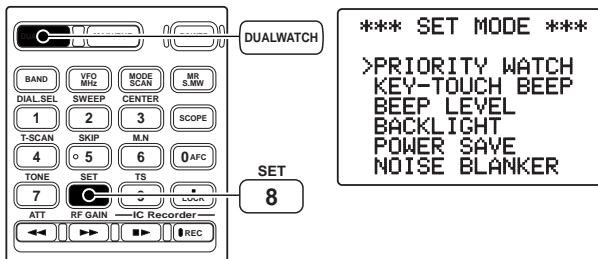

◆ Expanded set mode ON/OFF

- ① Push **[8 SET]** for 1 sec. to enter set mode.
- ② Rotate **[R-DIAL]** to select "SET EXPAND."

```
*** SET MODE ***  
  
NOISE BLANKER  
ANL  
AF FILTER  
AM ANTENNA  
FM ANTENNA  
>SET EXPAND
```

- ③ Push **[8 SET]** to enter "SET EXPAND," rotate **[R-DIAL]** to select the expanded set mode ON and OFF, then push **[8 SET]**.

```
SET EXPAND  
  
>OFF  
ON
```

Expanded set mode OFF

```
SET EXPAND  
  
OFF  
>ON
```

Expanded set mode ON

- ④ Rotate **[R-DIAL]** to select the desired item.
- ⑤ Push **[8 SET]** to enter the item, rotate **[R-DIAL]** to select the desired value or condition, then push **[8 SET]**.
- ⑥ Push **[DUALWATCH]** to exit set mode, or rotate **[R-DIAL]** to select another item.

■ Set mode items

The following items are available in the set mode and expanded set mode.

◇ General set mode items

```
*** SET MODE ***
```

```
>PRIORITY WATCH
KEY-TOUCH BEEP
BEEP LEVEL
BACKLIGHT
POWER SAVE
NOISE BLANKER
```

```
*** SET MODE ***
```

```
NOISE BLANKER
ANL
AF FILTER
AM ANTENNA
FM ANTENNA
>SET EXPAND
```

- Priority watch (p. 51)
- Key-touch beep (p. 51)
- Beep output level (p. 51)
- Display backlighting (p. 51)
- Power save (p. 52)
- Noise blanker (p. 52)
- ANL function (p. 52)
- AF filter (p. 52)
- AM antenna selection (p. 53)
- FM antenna selection (p. 53)
- Expanded set mode (p. 49)

◇ Expanded set mode items

```
*** SET MODE ***
```

```
LOCK
DIAL SPEED-UP
MONITOR
AUTO POWER OFF
>SCAN PAUSE
SCAN RESUME
```

```
*** SET MODE ***
```

```
SCAN STOP BEEP
SCOPE AF OUTPUT
OFFSET FREQ
DUPLEX
>TONE FREQ
DTCS CODE
```

```
*** SET MODE ***
```

```
DTCS POLARITY
BANK LINK
LCD CONTRAST
WX ALERT
>CI-V ADDRESS
CI-V BAUD RATE
```

```
*** SET MODE ***
```

```
BANK LINK
LCD CONTRAST
WX ALERT
CI-V ADDRESS
CI-V BAUD RATE
>CI-V TRANSCEIVE
```

- Key lock effect (p. 53)
- Dial speed acceleration (p. 54)
- Monitor switch action (p. 54)
- Auto power OFF (p. 54)
- Scan pause timer (p. 55)
- Scan resume timer (p. 55)
- Scan stop beep (p. 55)
- Scope audio output (p. 56)
- Offset frequency (p. 56)
- Duplex direction (p. 56)
- Tone frequency (p. 57)
- DTCS code (p. 57)
- DTCS polarity (p. 57)
- Memory bank link (p. 58)
- LCD contrast (p. 58)
- Weather alert[†] (p. 58)
- CI-V address (p. 59)
- CI-V baud rate (p. 59)
- CI-V transceive (p. 59)

[†]Available for the USA version only.

10 SET MODE

◇ Priority watch

Turn the priority watch or priority beep (priority watch with beep emission capability) ON. (default: OFF)

- ON : Start priority watch after exiting set mode.
- BELL : Emits beeps and blinking “(••)” indicator when a signal is received on the priority frequency.

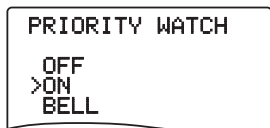

Priority watch ON

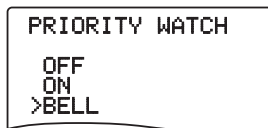

Priority beep ON

◇ Key-touch beep

The key-touch beep can be turned OFF for silent operation. (default: ON)



Key-touch beep OFF



Key-touch beep ON

◇ Beep output level

Adjust the key-touch beep tone level to the desired level within 39 levels.

▨ The key-touch beep (previous item) must be set to ON to have a beep tone.

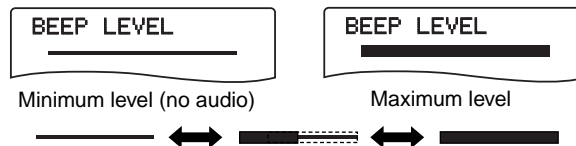

◇ Display backlighting

The receiver has display backlighting and function key illumination with a 5 sec. timer for night time operation. The backlighting can be turned ON continuously or turned OFF, if desired.

- AUTO : Lights when some operation is performed, goes out after 5 sec. (default)
- ON : Lights continuously during receiver power is ON.
- OFF : Never lights.



Continuously ON setting



Auto setting

◆ Power save

The power save function reduces the current drain to conserve battery power. This power save function can be turned OFF, if desired.

In the default setting ("AUTO" selection), the power save function is activated in 1:4 (125 msec.: 500 msec.) ratio when no signal is received for 5 sec. The ratio becomes 1:8 (125 msec.: 1 sec.) when no signal is received for another 60 sec.

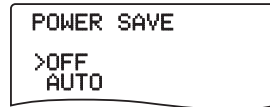

Power save OFF

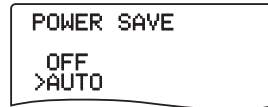

Power save ON

◆ Noise blanker

The noise blanker reduces pulse-type noise such as that generated by automobile ignition systems. This function is only effective for SSB/CW modes and not effective for non pulse-type noise.

- OFF : The noise blanker function is turned OFF. (default)
- ON : The noise blanker function is turned ON.



Noise blanker is OFF



Noise blanker is ON

◆ ANL function

The ANL (Automatic Noise Limiter) function reduces noise components when AM is selected.

- OFF : The ANL function is turned OFF. (default)
- ON : The ANL function is turned ON.



ANL function is OFF



ANL function is ON

◆ AF filter

The AF filter suppresses high-pitch tone when this setting is ON. This function is not effective for FM mode.

- OFF : The AF filter is deactivate. (default)
- ON : The AF filter is activate.



AF filter is OFF



AF filter is ON

10 SET MODE

◆ AM antenna selection

▨ This setting is activated only for the AM broadcast band, 0.495–1.620 MHz (differ according to version) reception.

- EXT : Use the antenna connected to the antenna connector. (default)
- BAR : Use the internal bar antenna for AM broadcast band reception.



External antenna



Internal bar antenna

◆ FM antenna selection

▨ This setting is activated only for the FM broadcast band, 76.000–107.995 MHz (differ according to version), reception.

- EXT : Use the antenna connected to the antenna connector. (default)
- EARPHONE: Use the connected earphone's cable as the antenna for FM broadcast band reception.



External antenna



Connected earphone cable

◆ Key lock effect

While the key lock function is ON, [VOLUME] and [SQL] can still be accessed. Accessible keys can be set to one of 4 groups.

[POWER] and [•LOCK] are also accessible during the lock, however, these keys are not effected by this setting.

- NORMAL : [VOLUME] and [SQL] are accessible. (default)
- NO SQL : [SQL] is accessible.
- NO VOL : [VOLUME] is accessible.
- ALL : No accessible key is available, except [POWER] and [•LOCK].

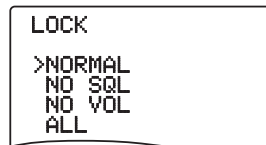

Normal lock condition

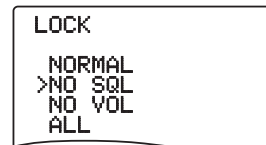

Squelch level can be adjusted

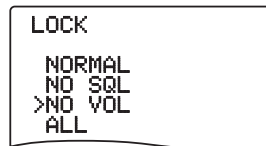

Audio output can be adjusted

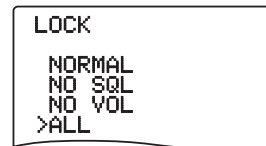

Receiver power and lock function only switchable

◇ Dial speed acceleration

The dial speed acceleration automatically speeds up the tuning dial speed when rotating **[R-DIAL]** rapidly.

- OFF : The dial speed acceleration is turned OFF.
- ON : The dial speed acceleration is tuned ON.
(default)

```
DIAL SPEED-UP
>OFF
ON
```

The acceleration OFF

```
DIAL SPEED-UP
OFF
>ON
```

The acceleration ON

◇ Monitor key action

The monitor key, **[SQL]**, can be set as a 'sticky' key. When set to the sticky condition, each push of **[SQL]** toggles the monitor function ON and OFF.

- PUSH : Pushing and holding **[SQL]** to monitor the frequency. (default)
- HOLD : Push **[SQL]** to monitor the frequency and push again to cancel it.

```
MONITOR
>PUSH
HOLD
```

Push to monitor

```
MONITOR
PUSH
>HOLD
```

Push and hold **[SQL]** to monitor

◇ Auto power OFF

The receiver can be set to automatically turn OFF after a specified period has past.

30 min., 1 hour, 1.5 hours, 2 hours, BUSY and OFF (default) can be specified. The specified period is retained even when the receiver is turned OFF by the auto power OFF function. To cancel the function, select "OFF" in this set mode.

- 30–120: The receiver automatically turns OFF (with a beep) after a specified period from last key operation.
- BUSY : The receiver automatically turns OFF (with a beep) after 3 minutes from last key operation or signal reception.

```
AUTO POWER OFF
OFF
>30MIN
60MIN
90MIN
120MIN
BUSY
```

30 min. timer

```
AUTO POWER OFF
OFF
30MIN
60MIN
90MIN
>120MIN
BUSY
```

2 hrs. timer

10 SET MODE

◇ Scan pause timer

Selects the scan pause time. When receiving signals, the scan pauses according to the scan pause time.

- 2–20 : Scan pauses for 2–20 sec. on a received signal, and selected in 2 sec. steps. (default: 10 sec.)
- HOLD : Scan pauses on a received signal until it disappears. Rotate [R-DIAL] to resume manually.

```
SCAN PAUSE
 2SEC
 4SEC
 6SEC
 8SEC
>10SEC
12SEC
```

Scan pauses for 10 sec.

```
SCAN PAUSE
12SEC
14SEC
16SEC
18SEC
20SEC
>HOLD
```

Scan pauses until signal disappears

◇ Scan resume timer

Selects scan resume time. Scan resumes after the specified period when the received signal disappears.

- 0 : Scan resumes immediately when the received signal disappears.
- 1–5 : Scan pause 1–5 sec. after the received signal disappears. (default: 2 sec.)
- HOLD : Scan pauses on the received signal even if it disappears. Rotate [R-DIAL] to resume manually.

```
SCAN RESUME
 0SEC
 1SEC
>2SEC
 3SEC
 4SEC
 5SEC
```

Scan resumes after 2 sec.

```
SCAN RESUME
 1SEC
 2SEC
 3SEC
 4SEC
 5SEC
>HOLD
```

Scan resumes manually

◇ Scan stop beep

Turns the scan stop beep function ON and OFF.

When the function is activated (“ON” is selected), a long beep will sound each time when signal is received during scan.

```
SCAN STOP BEEP
>OFF
ON
```

No beep is sound when receiving a signal

```
SCAN STOP BEEP
OFF
>ON
```

A long beep is sound when receiving a signal

◇ Scope audio output

Sets the audio output function while scope operation.

```
SCOPE AF OUTPUT
>OFF
ON
```

No audio output while
sweep operation

```
SCOPE AF OUTPUT
OFF
>ON
```

AF output while
sweep operation

/// The scope audio output is used for finding out the signals while scope function are modulated, unmodulated or beat signal etc.

◇ Offset frequency

Sets the duplex offset frequency for each frequency band independently within 0 to 159.99999 MHz range. During duplex operation (-DUP or +DUP), the monitoring frequency (while [SQL] is pushed) shifts the set frequency.

```
OFFSET FREQ
0.000.00
```

```
OFFSET FREQ
159.999.99
```

The default value may differ according to the selected frequency band (before accessing set mode) and receiver version.

/// The selected tuning step in VFO mode is used for the offset frequency setting.

◇ Duplex direction

Sets the duplex direction. The displaying frequency shifts the programmed offset frequency (at left below) when monitor function is in use (while pushing [SQL]).

- OFF : Simplex operation. (default)
- -DUP : The displaying frequency shifts down during monitor.
- +DUP : The displaying frequency shifts up during monitor.

```
DUPLEX
```

```
>OFF
-DUP
+DUP
```

Simplex operation

```
DUPLEX
```

```
OFF
-DUP
>+DUP
```

Positive duplex operation

10 SET MODE

◇ Tone frequency

Sets subaudible tone frequency for tone squelch operation. Total of 50 tone frequencies (67.0–254.1 Hz) are available. (default: 88.5 Hz)

TONE FREQ
88.5

88.5 Hz setting

TONE FREQ
254.1

254.1 Hz setting

• Available subaudible tone frequencies

67.0	79.7	94.8	110.9	131.8	156.7	171.3	186.2	203.5	229.1
69.3	82.5	97.4	114.8	136.5	159.8	173.8	189.9	206.5	233.6
71.9	85.4	100.0	118.8	141.3	162.2	177.3	192.8	210.7	241.8
74.4	88.5	103.5	123.0	146.2	165.5	179.9	196.6	218.1	250.3
77.0	91.5	107.2	127.3	151.4	167.9	183.5	199.5	225.7	254.1

◇ DTCS code

Sets DTCS code for DTCS squelch operation. Total of 104 codes (023–754) are available. (default: 023)

DTCS CODE
023

Code 023 setting

DTCS CODE
754

Code 754 setting

• Available DTCS code

023	054	125	165	245	274	356	445	506	627	732
025	065	131	172	246	306	364	446	516	631	734
026	071	132	174	251	311	365	452	523	632	743
031	072	134	205	252	315	371	454	526	654	754
032	073	143	212	255	325	411	455	532	662	
036	074	145	223	261	331	412	462	546	664	
043	114	152	225	263	332	413	464	565	703	
047	115	155	226	265	343	423	465	606	712	
051	116	156	243	266	346	431	466	612	723	
053	122	162	244	271	351	432	503	624	731	

∥ The polarity can also be set in “DTCS polarity” as follow.

◇ DTCS polarity

Sets DTCS polarity from normal and reverse.

(default: NORMAL)

DTCS POLARITY
>NORMAL
REVERSE

Normal setting

DTCS POLARITY
NORMAL
>REVERSE

Reverse setting

◇ Memory bank link

Sets the linked bank for the bank-link scan.
(default: All banks are ON)

- ① Rotate **[R-DIAL]** to select the bank that you want to change setting.

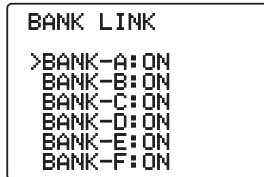

- ② Push **[8 SET]** for 1 sec. to enter the bank link setting condition.

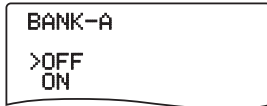

When OFF is selected

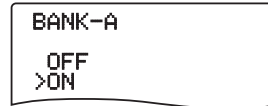

When ON is selected

- ③ Rotate **[R-DIAL]** to select the setting, then push **[8 SET]**.
- ④ Rotate **[R-DIAL]** to select next bank and repeat ① to ③, or push **[DUALWATCH]** to exit set mode.

◇ LCD contrast

The LCD contrast can be adjusted through 15 levels.

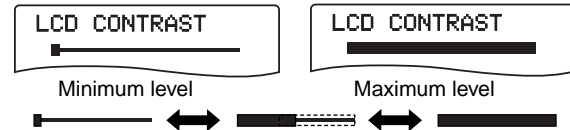

◇ Weather alert function

U.S.A. version only

Turns weather alert function ON and OFF.



Weather alert OFF



Weather alert ON

10 SET MODE

◆ CI-V address

To distinguish equipment, each CI-V transceiver/receiver has its own Icom standard address in hexadecimal code. The IC-R20's address is "6C."

When 2 or more IC-R20s are connected to an optional CT-17 CI-V LEVEL CONVERTOR, set a different address for each IC-R20 in the range "01" to "7F." (default: 6C)

```
CI-V ADDRESS
 6C
```

CI-V address set to 6C

```
CI-V ADDRESS
01
```

CI-V address set to 01

◆ CI-V baud rate

Sets the data transfer rate. When "AUTO" is selected, baud rate is automatically set according to the connected controller or other Icom CI-V radio. (default: AUTO)

```
CI-V BAUD RATE
300bps
1200bps
4800bps
9600bps
19200bps
>AUTO
```

"AUTO" baud rate setting

```
CI-V BAUD RATE
300bps
1200bps
4800bps
>9600bps
19200bps
AUTO
```

9600 bps setting

◆ CI-V transceive

CI-V transceive operation is possible with the IC-R20 connected to an Icom CI-V radio. When "ON" is selected, changing the frequency, operating mode, etc. on the IC-R20 automatically changes those of connected radios and vice versa. (default: ON)

```
CI-V TRANSCEIVE
>OFF
ON
```

CI-V transceive OFF

```
CI-V TRANSCEIVE
OFF
>ON
```

CI-V transceive ON

■ Antenna selection

The IC-R20 has an internal bar antenna installed for receiving AM broadcast band (0.495–1.620 MHz; differ according to version) signals. In addition, the connected earphone's cable can be used as an antenna for receiving FM broadcast band (76.000–107.995 MHz; differ according to version) signals.

◆ Selecting antenna

- ① Push [8 SET] for 1 sec. to enter set mode.
- ② Rotate [R-DIAL] to select "AM ANTENNA" or "FM ANTENNA" for AM broadcast band or FM broadcast band, respectively.

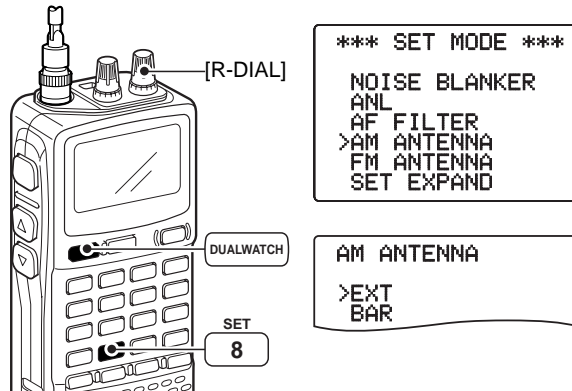

- ③ After pushing [8 SET], rotate [R-DIAL] to select "BAR" when "AM ANTENNA" is selected for the AM broadcast band; select "EARPHONE" when "FM ANTENNA" is selected for the FM broadcast band.

AM ANTENNA

EXT
>BAR

Bar antenna selection for
0.495–1.620 MHz band

FM ANTENNA

EXT
>EARPHONE

Earphone cable selection for
76.000–107.995 MHz band

- ④ Push [DUALWATCH] to exit set mode.

NOTES:

- Some noise or spurious may be received when the internal bar or earphone cable is used for antenna.
- The supplied or third party's antenna **MUST BE** connected to the antenna connector to receive signals other than AM or FM broadcast bands.
- When receiving an AM broadcast signal with internal bar antenna, aim the receiver to better audio direction.
- When the internal bar or earphone cable is used for an antenna, the attenuator function cannot be used.

Weather channel operation

U.S.A. version only

Weather channel selection

- ① Push **[MR S.MW]** several times to select the weather channel group.
- ② Rotate **[R-DIAL]** to select the desired weather channel.

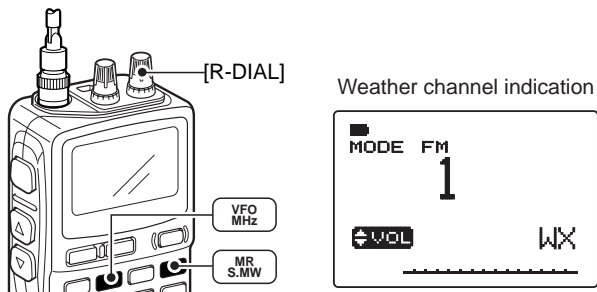

- ③ Push **[VFO MHz]** to return to VFO mode, or push **[MR S.MW]** to select other mode to exit the weather channel.

Weather alert function

NOAA broadcast stations transmit weather alert tones before important weather announcements. When the weather alert function is turned ON, the selected weather channel is monitored each 5 sec. for the announcement. When the alert signal is detected, the "ALT" and the "WX" indications are displayed alternately and sounds a beep tone until the receiver is operated. The previously selected (used) weather channel is checked periodically during standby or while scanning.

- ① Select the desired weather channel.
- ② Turn the weather alert function ON in set mode.
 - ➔ Push **[8 SET]** for 1 sec. to enter set mode.
 - ➔ Rotate **[R-DIAL]** to select "WX ALERT," then push **[8 SET]**. Rotate **[R-DIAL]** to select "ON."
 - ➔ Push **[DUALWATCH]** to exit set mode.
- ③ Set the desired stand-by condition.
 - Select VFO or memory channel.
 - Scan or priority watch operation can also be selected.
- ④ When the alert is detected, a beep sounds and the following indication will be displayed.

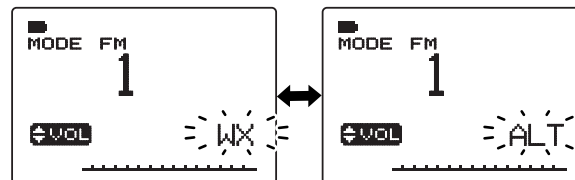

"WX" and "ALT" alternate.

- ⑤ Turn the weather alert function OFF in set mode.

■ Data cloning

Cloning allows you to quickly and easily transfer the programmed contents from a personal computer to a receiver using the optional CS-R20 CLONING SOFTWARE.

◇ Cloning using a personal computer

Data can be cloned to and from a personal computer (Microsoft® Windows® 98/Me/2000/XP) using the optional CS-R20 CLONING SOFTWARE and the optional OPC-1382 CLONING CABLE. Consult the CS-R20 CLONING SOFTWARE HELP file for details.

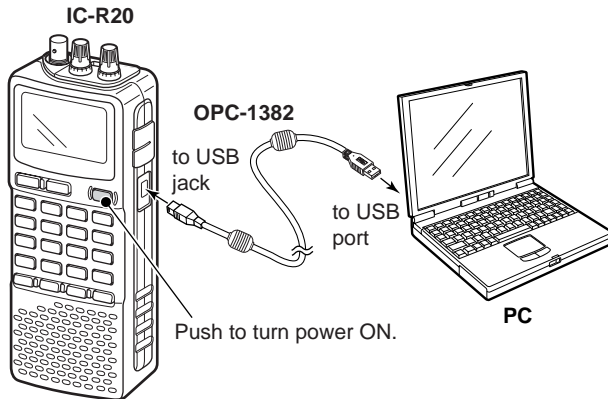

- The receiver shows following indications.

Write to receiver

CLONE IN

During cloning

CLONE

After cloning

Read from receiver

CLONE OUT

During cloning



After cloning

The USB driver that is included in the CS-R20 CD must be installed before using the optional CS-R20 (see p. 81 DRIVER INSTALLATION for details). Also cloning operation is required initial setup for your receiver's version.

Microsoft and Windows are registered trademarks of Microsoft Corporation in the U.S.A. and other countries.

11 OTHER FUNCTIONS

◇ Cloning error

NOTE: DO NOT push any key on the receiver during cloning. This will cause a cloning error.

When the display appears as below, a cloning error has occurred.

In such a case, the receiver automatically performs ALL RESET while turning power OFF and ON.

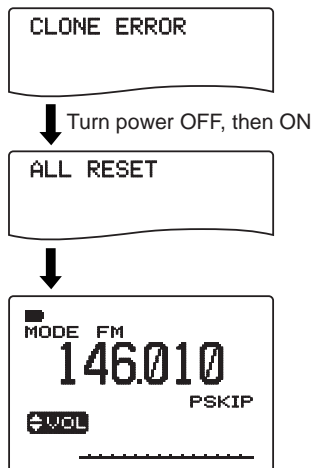

■ Auto power-off function

IN EXPANDED SET MODE

The IC-R20 can be set to automatically turn OFF after a specified period in which no operation is performed.

BUSY, 120 min., 90 min., 60 min., 30 min. and OFF can be specified. The specified period is retained even when the receiver is turned OFF by the auto power-off function. To cancel the function, select "OFF" in step ③ below.

- ① Push **[8 SET]** for 1 sec. to enter set mode.
- ② Rotate **[R-DIAL]** to select "AUTO POWER OFF," then push **[8 SET]**.
 - Turn the expanded set mode ON for selection. (p. 49)

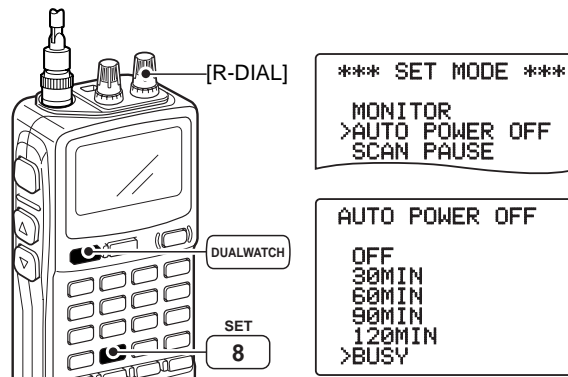

- ③ Rotate **[R-DIAL]** to select the desired time or to turn the function OFF, then push **[8 SET]**.
- ④ Push **[DUALWATCH]** to exit set mode.

■ IC recorder



The IC-R20 has an IC recorder of up to 32 tracks. The maximum recording length is about 260 minutes.

◇ Recording a received audio

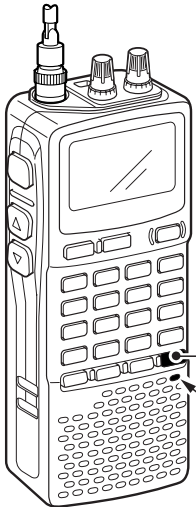
- ① Push [● REC] momentarily to start recording.
 - Red LED below the [● REC] lights ON.
- ② Push [● REC] to pause to record or push [■▶] to stop recording.
 - While pausing the red LED blinks.

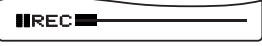

- While recording
 

Rest of recording time bar appears
- While Pausing
 
- When stop to record
 

◇ Playing back recorded content

- ① Push [◀◀ ATT]/[▶▶ RF GAIN] to select the desired track.
 - The track number appears.

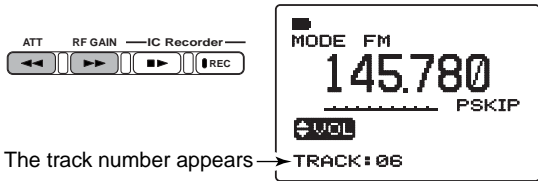

- ② Push [■▶] momentarily to start playing the content back.

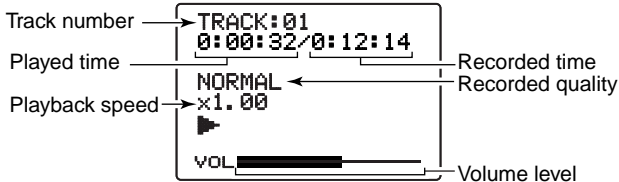

- ③ Push [◀◀ ATT] when you want to rewind; or [▶▶ RF GAIN] when you want to fast forward while playing back.

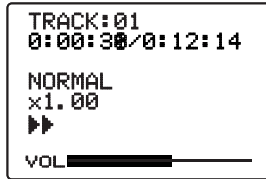
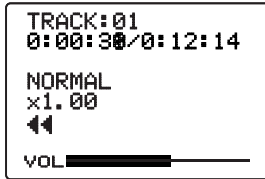

- ④ Push [■▶] to stop playing back.
 - Even you don't push [■▶], the receiver stops automatically and returns to normal condition at the end of the track.

11 OTHER FUNCTIONS

• Playback speed setting

The playback speed can be selected from 5 speeds.

- ① Push **[▶]** for 1 sec. to enter the playback speed set mode.
- ② Rotate **[R-DIAL]** to select the desired playback speed, then push **[▶]**.
 - **x0.50** : Playback the recorded content at half speed.
 - **x0.75** : Playback the recorded content at three quarters speed.
 - **x1.00** : Playback the recorded content at normal speed. (default)
 - **x1.25** : Playback the recorded content at 1.25 times speed.
 - **x1.50** : Playback the recorded content at 1.5 times speed.

```
PLAYBACK SPEED
x0.50
x0.75
>x1.00
x1.25
x1.50
```

◇ Recording set mode

• Quality setting

- ① Push **[REC]** for 1 sec. to enter the recording set mode.
- ② Rotate **[R-DIAL]** to select "QUALITY," then push **[REC]**.

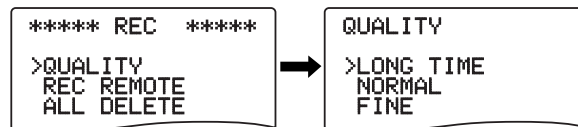

- ③ Rotate **[R-DIAL]** to select the recording quality, then push **[REC]**.
- ④ Push **[DUALWATCH]** to exit the recording set mode.

Selection	Recording Quality	Recording Time (Approx.)
LONG TIME	Low	260 min.
NORMAL	Normal	130 min.
FINE	High	65 min.

NOTE: The IC recorder can store 32 tracks at the maximum. When the 32nd track is recorded, the recording function is not available even if recording time is left. At this time delete all recorded contents (see the next page) or transfer the recorded contents to PC using optional CS-R20 CLONING SOFTWARE.

• Automatic recording

The IC-R20 has an automatic recording function. When this function is activated, the receiver will record automatically when a receiving signal appears and pause when the signal disappears. This function is very useful when you want to store an uncontinuous signal.

- ① Push [**0** REC] for 1 sec. to enter the recording set mode.
- ② Rotate [**R-DIAL**] to select “REC REMOTE,” then push [**0** REC].

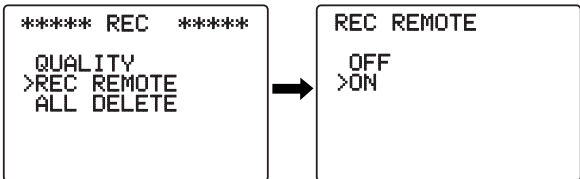

- ③ Rotate [**R-DIAL**] to select the setting, then push [**0** REC].
- ④ Push [**DUALWATCH**] to exit the recording set mode.
- ⑤ Push [**0** REC] to activate.

/// **NOTE:** Before using this function, verify the squelch setting as close level when no signal is received. Otherwise this function will not pause even when signal disappears.

• Erasing recorded audio

/// **NOTE:** The IC recorder can erase all the tracks at the same time, but cannot erase each track independently. Only using the optional CS-R20 CLONING SOFTWARE can store the recorded audio into a PC or erase independently.

- ① Push [**0** REC] for 1 sec. to enter the recording set mode.
- ② Rotate [**R-DIAL**] to select “ALL DELETE,” then push [**0** REC].

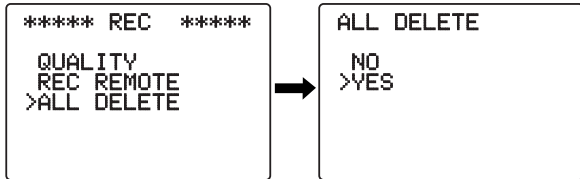

- ③ Rotate [**R-DIAL**] to select “YES” if you want to delete all tracks, then push [**0** REC].
 - After deleting, the receiver returns to normal operating mode.

/// **NOTE:** The optional CS-R20 can perform the storing the recorded contents into PC, erasing them independently or editing their information. The CS-R20 cannot playback the stored contents on the PC. The recorded contents can be playback on the IC-R20 only.

11 OTHER FUNCTIONS

■ Partial reset

AT POWER ON

If you want to initialize the operating conditions (VFO frequency, VFO settings, set mode contents) without clearing the memory contents, a partial resetting function is available for the receiver.

➔ While pushing [VFO MHz], turn the power ON to partially reset the receiver.

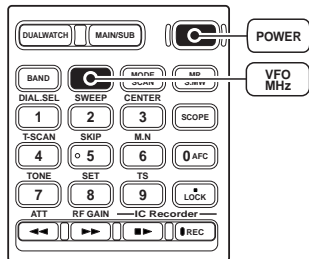

*The appearing frequency is different according to receiver version.

■ All reset

AT POWER ON

The function display may occasionally display erroneous information (e.g. when first applying power). This may be caused externally by static electricity or by other factors.

If this problem occurs, turn power OFF. After waiting for a few seconds, turn power ON again. If the problem persists, perform the following procedure.

• Partial resetting is also available. See left for details.

/// IMPORTANT!:

Resetting the receiver (All reset) CLEARS all memory information and initializes all values in the receiver, including TV channel skip setting.

➔ While pushing [VFO MHz] and [MR S.MW], turn the power ON to reset the CPU.

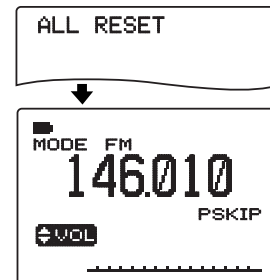
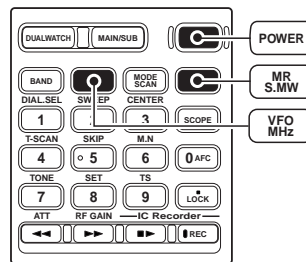

*The appearing frequency is different according to the receiver version.

■ General

The IC-R20 can be connected to a PC via the PC's RS-232C port using an optional CT-17 CI-V LEVEL CONVERTOR. This allows you to control the receiver from the PC and/or transfer data from the receiver to the PC.

Control is provided via Icom's CI-V Communication Interface.

/// An appropriate application for CI-V command is not supplied from Icom.

■ Data format

The CI-V system can be operated using the following data formats. Data formats differ according to command numbers. A data area is added for some commands.

Controller → IC-R20

FE	FE	6C	E0	Cn	Sc	Data area	FD
①	②	③	④	⑤	⑥	⑦	

IC-R20 → Controller

FE	FE	E0	6C	Cn	Sc	Data area	FD
①	③	②	④	⑤	⑥	⑦	

- ① Preamble code (fixed)
- ② Receiver's default address
- ③ Controller's default address
- ④ Command number (see table below)
- ⑤ Sub command number (see table below)
- ⑥ BCD code data for frequency entry
- ⑦ End of message code (fixed)

■ Command table

Description	Cn	Sc
Transfers frequency data (transceive)	00	—
Transfers mode data (transceive)	01	—
Reads display frequency	03	—
Reads display mode	04	—
Sets frequency data	05	—
Sets LSB mode	06	00
Sets USB mode		01
Sets AM mode		02
Sets CW mode		03
Sets FM mode		05
Sets WFM mode		06
Reads squelch condition (open or closed)	15	01
Reads S-meter level		02

12 CONTROL COMMAND

CI-V connections example

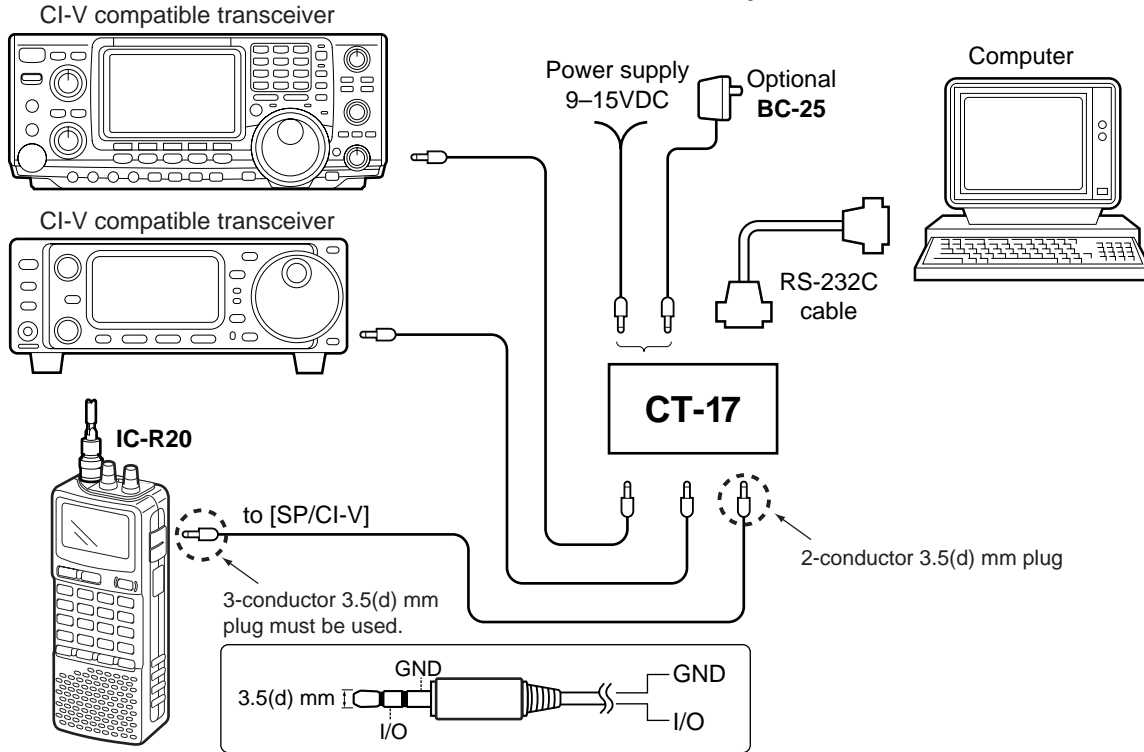

FREQUENCY TABLE 13

■ TV channels

Following tables show the channels versus video and audio frequencies depending on each version.

◆ U.S.A. channels

(unit: MHz)

CH	Freq.	CH	Freq.	CH	Freq.
2	59.75	27	553.75	52	703.75
3	65.75	28	559.75	53	709.75
4	71.75	29	565.75	54	715.75
5	81.75	30	571.75	55	721.75
6	87.75	31	577.75	56	727.75
7	179.75	32	583.75	57	733.75
8	185.75	33	589.75	58	739.75
9	191.75	34	595.75	59	745.75
10	197.75	35	601.75	60	751.75
11	203.75	36	607.75	61	757.75
12	209.75	37	613.75	62	763.75
13	215.75	38	619.75	63	769.75
14	475.75	39	625.75	64	775.75
15	481.75	40	631.75	65	781.75
16	487.75	41	637.75	66	787.75
17	493.75	42	643.75	67	793.75
18	499.75	43	649.75	68	799.75
19	505.75	44	655.75	69	805.75
20	511.75	45	661.75		
21	517.75	46	667.75		
22	523.75	47	673.75		
23	529.75	48	679.75		
24	535.75	49	685.75		
25	541.75	50	691.75		
26	547.75	51	697.75		

◆ CCIR channels (unit: MHz)

CH	Freq.	CH	Freq.
1	46.75	40	628.75
2	53.75	41	636.75
3	60.75	42	644.75
4	67.75	43	652.75
5	180.75	44	660.75
6	187.75	45	668.75
7	194.75	46	676.75
8	201.75	47	684.75
9	208.75	48	692.75
10	215.75	49	700.75
11	222.75	50	708.75
12	229.75	51	716.75
21	476.75	52	724.75
22	484.75	53	732.75
23	492.75	54	740.75
24	500.75	55	748.75
25	508.75	56	756.75
26	516.75	57	764.75
27	524.75	58	772.75
28	532.75	59	780.75
29	540.75	60	788.75
30	548.75	61	796.75
31	556.75	62	804.75
32	564.75	63	812.75
33	572.75	64	820.75
34	580.75	65	828.75
35	588.75	66	836.75
36	596.75	67	844.75
37	604.75	68	852.75
38	612.75	69	860.75
39	620.75		

◆ Australia channels

(unit: MHz)

CH	Freq.	CH	Freq.
0	51.75	43	637.75
1	62.75	44	644.75
2	69.75	45	651.75
3	91.75	46	658.75
4	100.75	47	665.75
5	107.75	48	672.75
5A	143.75	49	679.75
6	180.75	50	686.75
7	187.75	51	693.75
8	194.75	52	700.75
9	201.75	53	707.75
10	214.75	54	714.75
11	221.75	55	721.75
28	532.75	56	728.75
29	539.75	57	735.75
30	546.75	58	742.75
31	553.75	59	749.75
32	560.75	60	756.75
33	567.75	61	763.75
34	574.75	62	770.75
35	581.75	63	777.75
36	588.75	64	784.75
37	595.75	65	791.75
38	602.75	66	798.75
39	609.75	67	805.75
40	616.75	68	812.75
41	623.75	69	819.75
42	630.75		

13 FREQUENCY TABLE

◇ China channels

CH	Freq.	CH	Freq.
1	56.25	32	669.75
2	64.25	33	677.75
3	72.25	34	685.75
4	83.75	35	693.75
5	91.75	36	701.75
6	174.75	37	709.75
7	182.75	38	717.75
8	190.75	39	725.75
9	198.75	40	733.75
10	206.75	41	741.75
11	214.75	42	749.75
12	222.75	43	757.75
13	477.75	44	765.75
14	485.75	45	773.75
15	493.75	46	781.75
16	501.75	47	789.75
17	509.75	48	797.75
18	517.75	49	805.75
19	525.75	50	813.75
20	533.75	51	821.75
21	541.75	52	829.75
22	549.75	53	837.75
23	557.75	54	845.75
24	565.75	55	853.75
25	613.75	56	861.75
26	621.75	57	869.75
27	629.75	58	877.75
28	637.75	59	885.75
29	645.75	60	893.75
30	653.75	61	901.75
31	661.75	62	909.75

(unit: MHz)

CH	Freq.
63	917.75
64	925.75
65	933.75
66	941.75
67	949.75
68	957.75

◇ New Zealand channels

(unit: MHz)

CH	Freq.
1	50.75
2	60.75
3	67.75
4	180.75
5	187.75
6	194.75
7	201.75
8	208.75
9	215.75
10	222.75
11	229.75

◇ UK channels

(unit: MHz)

CH	Freq.
21	477.25
22	485.25
23	493.25
24	501.25
25	509.25
26	517.25
27	525.25
28	533.25
29	541.25
30	549.25
31	557.25
32	565.25
33	573.25
34	581.25
35	589.25
36	597.25
37	605.25
38	613.25
39	621.25
40	629.25
41	637.25
42	645.25
43	653.25
44	661.25
45	669.25
46	677.25
47	685.25
48	693.25
49	701.25
50	709.25
51	717.25

◇ France channels (unit: MHz)

CH	Freq.	CH	Freq.
2	49.25	43	653.75
3	54.00	44	661.75
4	57.25	45	669.75
5	182.50	46	677.75
6	190.50	47	685.75
7	198.50	48	693.75
8	206.50	49	701.75
9	214.50	50	709.75
10	222.50	51	717.75
21	477.75	52	725.75
22	485.75	53	733.75
23	493.75	54	741.75
24	501.75	55	749.75
25	509.75	56	757.75
26	517.75	57	765.75
27	525.75	58	773.75
28	533.75	59	781.75
29	541.75	60	789.75
30	549.75	61	797.75
31	557.75	62	805.75
32	565.75	63	813.75
33	573.75	64	821.75
34	581.75	65	829.75
35	589.75	66	837.75
36	597.75	67	845.75
37	605.75	68	853.75
38	613.75	69	861.75
39	621.75		
40	629.75		
41	637.75		
42	645.75		

◆ Indonesian channels

(unit: MHz)

CH	Freq.	CH	Freq.
1A	53.75	40	628.75
2	60.75	41	636.75
3	67.75	42	644.75
4	180.75	43	652.75
5	187.75	44	660.75
6	194.75	45	668.75
7	201.75	46	676.75
8	208.75	47	684.75
9	215.75	48	692.75
10	222.75	49	700.75
11	229.75	50	708.75
21	476.75	51	716.75
22	484.75	52	724.75
23	492.75	53	732.75
24	500.75	54	740.75
25	508.75	55	748.75
26	516.75	56	756.75
27	524.75	57	764.75
28	532.75	58	772.75
29	540.75	59	780.75
30	548.75	60	788.75
31	556.75	61	796.75
32	564.75	62	804.75
33	572.75	63	812.75
34	580.75	64	820.75
35	588.75	65	828.75
36	596.75	66	836.75
37	604.75	67	844.75
38	612.75	68	852.75
39	620.75	69	860.75

◆ Italian channels (unit: MHz)

CH	Freq.	CH	Freq.
A	59.25	42	644.75
B	67.75	43	652.75
C	87.75	44	660.75
D	180.75	45	668.75
E	188.75	46	676.75
F	197.75	47	684.75
G	206.75	48	692.75
H	215.75	49	700.75
H1	222.75	50	708.75
H2	229.75	51	716.75
21	476.75	52	724.75
22	484.75	53	732.75
23	492.75	54	740.75
24	500.75	55	748.75
25	508.75	56	756.75
26	516.75	57	764.75
27	524.75	58	772.75
28	532.75	59	780.75
29	540.75	60	788.75
30	548.75	61	796.75
31	556.75	62	804.75
32	564.75	63	812.75
33	572.75	64	820.75
34	580.75	65	828.75
35	588.75	66	836.75
36	596.75	67	844.75
37	604.75	68	852.75
38	612.75	69	860.75
39	620.75		
40	628.75		
41	636.75		

◆ Taiwan channels

(unit: MHz)

CH	Freq.
7	179.75
8	185.75
9	191.75
10	197.75
11	203.75
12	209.75

◆ FOT channels

(unit: MHz)

CH	Freq.
4	181.75
5	189.75
6	197.75
7	205.75
8	213.75
9	221.75

13 FREQUENCY TABLE

■ VHF marine channels

(unit: MHz)

CH No.	Ship Transmit	Ship Receive
01	156.050	160.650
01A	156.050	156.050
02	156.100	160.700
03	156.150	160.750
03A	156.150	156.150
04	156.200	160.800
04A	156.200	156.200
05	156.250	160.850
05A	156.250	156.250
06	156.300	156.300
07	156.350	160.950
07A	156.350	156.350
08	156.400	156.400
09	156.450	156.450
10	156.500	156.500
11	156.550	156.550
12	156.600	156.600
13	156.650	156.650
14	156.700	156.700
15	156.750	156.750
16	156.800	156.800
17	156.850	156.850
18	156.900	161.500
18A	156.900	156.900
19	156.950	161.550
19A	156.950	156.950
20	157.000	161.600
20A	157.000	157.000
21	157.050	161.650

CH No.	Ship Transmit	Ship Receive
21A	157.050	157.050
21b	161.650	161.650
22	157.100	161.700
22A	157.100	157.100
23	157.150	161.750
23A	157.150	157.150
24	157.200	161.800
25	157.250	161.850
25b	161.850	161.850
26	157.300	161.900
27	157.350	161.950
28	157.400	162.000
28b	162.000	162.000
60	156.025	160.625
61	156.075	160.675
61A	156.075	156.075
62	156.125	160.725
62A	156.125	156.125
63	156.175	160.775
63A	156.175	156.175
64	156.225	160.825
64A	156.225	156.225
65	156.275	160.875
65A	156.275	156.275
66	156.325	160.925
66A	156.325	156.325
67	156.375	156.375
68	156.425	156.425
69	156.475	156.475

CH No.	Ship Transmit	Ship Receive
70	156.525	156.525
71	156.575	156.575
72	156.625	156.625
73	156.675	156.675
74	156.725	156.725
77	156.875	156.875
78	156.925	161.525
78A	156.925	156.925
79	156.975	161.575
79A	156.975	156.975
80	157.025	161.625
80A	157.025	157.025
81	157.075	161.675
81A	157.075	157.075
82	157.125	161.725
82A	157.125	157.125
83	157.175	161.775
83A	157.175	157.175
83b	161.775	161.775
84	157.225	161.825
84A	157.225	157.225
85	157.275	161.875
85A	157.275	157.275
86	157.325	161.925
86A	157.325	157.325
87	157.375	161.975
87A	157.375	157.375
88	157.425	162.025
88A	157.425	157.425

■ Weather channels (unit: MHz)

WX CH	Frequency
01	162.550
02	162.400
03	162.475
04	162.425
05	162.450
06	162.500
07	162.525
08	161.650
09	161.775
10	163.275

■ Other communications in the USA

◆ HF CB (Citizens Band) channels

CH	Frequency	CH	Frequency
1	26.965 MHz	21	27.215 MHz
2	26.975 MHz	22	27.225 MHz
3	26.985 MHz	23	27.255 MHz
4	27.005 MHz	24	27.235 MHz
5	27.015 MHz	25	27.245 MHz
6	27.025 MHz	26	27.265 MHz
7	27.035 MHz	27	27.275 MHz
8	27.055 MHz	28	27.285 MHz
9	27.065 MHz	29	27.295 MHz
10	27.075 MHz	30	27.305 MHz
11	27.085 MHz	31	27.315 MHz
12	27.105 MHz	32	27.325 MHz
13	27.115 MHz	33	27.335 MHz
14	27.125 MHz	34	27.345 MHz
15	27.135 MHz	35	27.355 MHz
16	27.155 MHz	36	27.365 MHz
17	27.165 MHz	37	27.375 MHz
18	27.175 MHz	38	27.385 MHz
19	27.185 MHz	39	27.395 MHz
20	27.205 MHz	40	27.405 MHz

◆ MURS channels

CH	Frequency
1	151.820 MHz
2	151.880 MHz
3	151.940 MHz
4	154.570 MHz
5	154.600 MHz

◆ GMRS (General Mobile Radio Service) channels

Transceiver Receive	Transceiver transmit
462.5500 MHz	467.5500 MHz
462.5625 MHz	
462.5750 MHz	467.5750 MHz
462.5875 MHz	
462.6000 MHz	467.6000 MHz
462.6125 MHz	
462.6250 MHz	467.6250 MHz
462.6375 MHz	
462.6500 MHz	467.6500 MHz
462.6625 MHz	
462.6750 MHz	467.6750 MHz
462.6875 MHz	
462.7000 MHz	467.7000 MHz
462.7125 MHz	
462.7250 MHz	467.7250 MHz

◆ FR5 (Family Radio Service) channels

CH	Frequency	CH	Frequency
1	462.5625 MHz	8	467.5625 MHz
2	462.5875 MHz	9	467.5875 MHz
3	462.6125 MHz	10	467.6125 MHz
4	462.6375 MHz	11	467.6375 MHz
5	462.6625 MHz	12	467.6625 MHz
6	462.6875 MHz	13	467.6875 MHz
7	462.7125 MHz	14	467.7125 MHz

◆ BRS (Business Radio Service) channels

Dot color	Frequency
Red	151.625 MHz
Purple	151.955 MHz
Blue	154.570 MHz
Green	154.600 MHz
White	462.575 MHz
Black	462.625 MHz
Orange	462.675 MHz
Brown	464.500 MHz
Yellow	464.550 MHz
"J" Dot	467.763 MHz
"K" Dot	467.813 MHz
Silver Star	467.850 MHz
Gold Star	467.875 MHz
Red Star	467.900 MHz
Blue Star	467.925 MHz

13 FREQUENCY TABLE

◆ General aviation frequencies

Frequency	Description
121.500	Emergencies
122.000	Flight Advisory Service
122.200	Flight Service Stations
122.700	Unicom— Uncontrolled airports
122.725	Unicom— Private airports
122.750	Unicom— Air-to-air communications
122.800	Unicom— Uncontrolled airports
122.900	Search & rescue training, & uncontrolled airports
122.950	Unicom— Controlled airports
123.000	Unicom— Uncontrolled airports
123.025	Helicopters— Air-to-air communications
123.050	Unicom— Heliports
123.075	Unicom— Heliports
123.100	Search & Rescue
123.300	Flight Schools
123.450	Air-to-air communications (unofficial)
123.500	Flight Schools
123.600	Flight Service Stations— Uncontrolled airports
148.125	Civil Air Patrol Repeaters— Secondary
148.150	Civil Air Patrol Repeaters— Primary
156.300	Aircraft-to-ship— safety
156.400	Aircraft-to-ship— commercial
156.425	Aircraft-to-ship— non-commercial
156.450	Aircraft-to-ship— commercial
156.625	Aircraft-to-ship— non-commercial
156.900	Aircraft-to-ship— commercial
243.000	Military Emergency “Guard”
255.400	Flight Advisory Service
257.800	Civilian Towers
311.000	SAC Primary
321.000	SAC Secondary
381.800	USCG— Primary

◆ Cable TV (IRC)

(unit: MHz)

CH	Frequency range	Remarks
2– 13	54–216	(same as broadcast VHF)
14– 22	120–174	Mid band Ch. A–I
23– 36	216–300	Super band J–W
37– 53	300–402	Hyper band AA–QQ
54– 64	402–468	
65– 94	468–648	(Ultra band)
95– 99	90–120	Low band A5–A1
100–125	648–804	(Ultra band)

◆ Wireless Microphones

- 169.445 MHz
- 169.505 MHz
- 170.245 MHz
- 170.305 MHz
- 171.045 MHz
- 171.105 MHz
- 171.845 MHz
- 171.905 MHz

*Power limited to 1/20 watt. These frequencies are also used at drive-in windows at some fast-food restaurants.

■ Other communications— other countries

◆ LPD (Low Power Device) channels

(unit: MHz)

◆ PMR446 channels (unit: MHz)

CH	Frequency
1	433.075
2	433.100
3	433.125
4	433.150
5	433.175
6	433.200
7	433.225
8	433.250
9	433.275
10	433.300
11	433.325
12	433.350
13	433.375
14	433.400
15	433.425
16	433.450
17	433.475
18	433.500
19	433.525
20	433.550
21	433.575
22	433.600
23	433.625
24	433.650
25	433.675
26	433.700
27	433.725
28	433.750
29	433.775

CH	Frequency
30	433.800
31	433.825
32	433.850
33	433.875
34	433.900
35	433.925
36	433.950
37	433.975
38	434.000
39	434.025
40	434.050
41	434.075
42	434.100
43	434.125
44	434.150
45	434.175
46	434.200
47	434.225
48	434.250
49	434.275
50	434.300
51	434.325
52	434.350
53	434.375
54	434.400
55	434.425
56	434.450
57	434.475
58	434.500

CH	Frequency
59	434.525
60	434.550
61	434.575
62	434.600
63	434.625
64	434.650
65	434.675
66	434.700
67	434.725
68	434.750
69	434.775

CH	Frequency
1	446.00625
2	446.01875
3	446.03125
4	446.04375
5	446.05625
6	446.06875
7	446.08125
8	446.09375

13 FREQUENCY TABLE

◇ UHF C.R.S (Citizen Radio Service) channels

CH	Frequency	CH	Frequency
1	476.425 MHz	21	476.925 MHz
2	476.450 MHz	22	476.950 MHz
3	476.475 MHz	23	476.975 MHz
4	476.500 MHz	24	477.000 MHz
5	476.525 MHz	25	477.025 MHz
6	476.550 MHz	26	477.050 MHz
7	476.575 MHz	27	477.075 MHz
8	476.600 MHz	28	477.100 MHz
9	476.625 MHz	29	477.125 MHz
10	476.650 MHz	30	477.150 MHz
11	476.675 MHz	31	477.175 MHz
12	476.700 MHz	32	477.200 MHz
13	476.725 MHz	33	477.225 MHz
14	476.750 MHz	34	477.250 MHz
15	476.775 MHz	35	477.275 MHz
16	476.800 MHz	36	477.300 MHz
17	476.825 MHz	37	477.325 MHz
18	476.850 MHz	38	477.350 MHz
19	476.875 MHz	39	477.375 MHz
20	476.900 MHz	40	477.400 MHz

■ Troubleshooting

If your receiver seems to be malfunctioning, please check the following points before sending it to a service center.

PROBLEM	POSSIBLE CAUSE	SOLUTION	REF.
No power comes on.	<ul style="list-style-type: none"> The batteries are exhausted. The battery polarity is reversed. 	<ul style="list-style-type: none"> Replace the batteries or charge the battery pack. Check the battery polarity. 	pgs. 8–10 p. 8
No sound comes from the speaker.	<ul style="list-style-type: none"> Volume level is too low. Squelch level is set too tight. Different tone is selected with tone squelch. 	<ul style="list-style-type: none"> Rotate [R-DIAL] or push [▲] to obtain a suitable level. While pushing [SQL], rotate [R-DIAL] to set the squelch level. Turn the appropriate function OFF. 	p. 17 p. 18 p. 45
Sensitivity is low and only strong signals are audible.	<ul style="list-style-type: none"> Attenuator function is activated. RF gain setting is too low for SSB/CW modes. 	<ul style="list-style-type: none"> Push [ATT] for 1 sec. to turn the attenuator function OFF. Push [RF GAIN] for 1 sec., then rotate [R-DIAL] to select “MAX” level. 	p. 19 p. 19
Frequency cannot be set.	<ul style="list-style-type: none"> The lock function is activated. 	<ul style="list-style-type: none"> Push [* LOCK] for 1 sec. to turn the function OFF. 	p. 16
No beep sound.	<ul style="list-style-type: none"> Beep tones are turned OFF or the beep tone level is too low. 	<ul style="list-style-type: none"> Turn beep tone ON or set the beep tone level to appropriate level in set mode. 	p. 51
Receive audio is distorted.	<ul style="list-style-type: none"> The operating mode is not selected correctly. 	<ul style="list-style-type: none"> Push [MODE SCAN] several times to select a suitable operating mode. 	p. 16
Desired set mode item cannot be selected.	<ul style="list-style-type: none"> “EXPAND” item is set to OFF. 	<ul style="list-style-type: none"> Turn “EXPAND” item ON. 	p. 49
Programmed scan does not start.	<ul style="list-style-type: none"> Program scan edges are not programmed. 	<ul style="list-style-type: none"> Program a pair of scan edge channels. 	p. 36
Memory or bank scan does not start.	<ul style="list-style-type: none"> None or only one memory or bank channel is programmed. 	<ul style="list-style-type: none"> Program at least 2 memory or bank channels 	pgs. 26, 27

15 SPECIFICATIONS

◆ GENERAL

- Frequency coverage : (Unit: MHz)
 - USA 0.150–821.999, 851.000–866.999, 896.000–1304.999, 1305.000–3304.999
 - France 0.150–29.999, 50.200–51.200, 87.500–108.000, 144.000–146.000, 430.000–440.000, 1240.000–1300.000
 - Other than above 0.150–1304.999, 1305.000–3304.999
- Number of memory channels : 1250 (incl. 50 scan edges and 200 auto write channels)
- Receive modes : FM, AM, WFM, USB, LSB, CW
- Frequency resolution : 0.01, 0.1, 1, 5, 6.25, *8.33, *9, 10, 12.5, 15, 20, 25, 30, 50, 100 kHz
 - *selectable depending on the operating frequency band.
- Operating temperature range : –10°C to +60°C; +14°F to +140°F
- Reference frequency stability : ±6 ppm (–10°C to +60°C; +14°F to +140°F)
- Power supply requirement : 3 AA (R6) alkaline cells, (Negative ground)
 - BP-206 Li-ion battery pack or 6.0 V DC ±5% (with AC adaptor, BC-149A/D or CP-18A/E)
- Current drain (Single band operation with BP-206 (3.7 V DC) without operating IC recorder):
 - max. audio 150 mA typical
 - receive standby 100 mA typical
 - power saved 35 mA typical
- Antenna connector : BNC (50 Ω)
- Dimensions (proj. not included) : 60(W) × 142(H) × 34.8(D) mm
 - 2 $\frac{3}{8}$ (W) × 5 $\frac{1}{2}$ (H) × 1 $\frac{3}{8}$ (D) in
- Weight (approx.) : 320 g; 11.3 oz (with the ant. and BP-206)
- AF output power (at 3.7 V DC) : 100 mW typical at 10% distortion with an 8 Ω load
- Ext. speaker connector : 3-conductor 3.5 (d) mm (1/8")/8 Ω

◆ RECEIVER

- Receive system : Triple-conversion superheterodyne and down converter
- Intermediate frequencies : 1st: 266.7 MHz and 429.1 MHz, 2nd: 19.65 MHz, 3rd: 450 kHz
- Sensitivity (Receiving on single band operation, except spurious points) :
 - FM (1 kHz/3.5 kHz Dev.; 12 dB SINAD)
 - 1.620–4.999 MHz Less than 0.56 μV
 - 5.000–221.999 MHz Less than 0.4 μV
 - 330.000–832.999 MHz Less than 0.56 μV
 - 833.000–1304.999 MHz Less than 0.71 μV
 - 1330.000–2304.999 MHz Less than 5.6 μV
 - 2330.000–2999.999 MHz Less than 18 μV
 - WFM (1 kHz/52.5 kHz Dev.; 12 dB SINAD)
 - 76.000–108.000 MHz Less than 1.8 μV
 - 175.000–221.999 MHz Less than 1.8 μV
 - 470.000–769.999 MHz Less than 2.5 μV
 - AM (1 kHz/30% MOD.; 10 dB S/N)
 - 0.495–4.999 MHz Less than 2.2 μV
 - 5.000–29.999 MHz Less than 1.4 μV
 - 118.000–135.999 MHz Less than 1.4 μV
 - SSB/CW (10 dB S/N)
 - 0.495–4.999 MHz Less than 0.4 μV
 - 5.000–29.999 MHz Less than 0.25 μV
 - 50.000–53.999 MHz Less than 0.25 μV
 - 118.000–146.999 MHz Less than 0.25 μV
 - 330.000–469.999 MHz Less than 0.32 μV
- Selectivity :
 - AM/FM : More than 12 kHz/–6 dB
Less than 30 kHz/–60 dB
 - WFM : More than 150 kHz/–6 dB
 - SSB/CW : More than 1.8 kHz/–6 dB

All stated specifications are subject to change without notice or obligation.

Options

BC-149 A/D AC ADAPTOR



Regularly charges the installed battery pack (BP-206). 6 V DC/1 A output. Same as supplied one. (Not supplied with some versions.)

CP-18A/E CIGARETTE LIGHTER CABLE WITH DC-DC CONVERTER



Allows you to operate the receiver through a 12 V cigarette lighter socket, and also charges the installed battery pack (BP-206) regularly. A built-in DC-DC converter outputs 6 V DC.

SP-13 EARPHONE



Provides clear receive audio in noisy environments.

BC-156 DESKTOP CHARGER



Used for rapid charging of Li-Ion battery pack. Charging time: 2.5 hours. An AC adaptor is supplied with the charger.

LC-158 CARRYING CASE

Helps protect the receiver from scratches, etc.

CT-17 CI-V LEVEL CONVERTOR

For receiver remote control using a PC.

CS-R20 CLONING SOFTWARE + **OPC-1382** CLONING CABLE

(USB type)
Allows you to transfer data, such as memories, and quickly and easily edit and store data via a PC (for Microsoft® Windows® 98/Me/2000/XP). Also available to transfer recorded audio and store into PC.

MB-86 SWIVEL BELT CLIP

Swivel belt clip is useful for easy attaching/detaching the receiver to/from the belt.

MB-98 BELT CLIP

Same as supplied one.

BP-206 Li-Ion BATTERY PACK

3.7 V/1650 mAh Lithium Ion battery pack. Same as supplied one. (Not supplied with some versions.)

17 DRIVER INSTALLATION

Before installing the optional CS-R20 CLONING SOFTWARE, the USB driver must be installed.

Install the USB driver as follows.

■ For Microsoft® Windows® XP

- ① Connect the IC-R20 to the desired USB port using with the USB cable, OPC-1382.
 - “Found New Hardware” appears as below.



- ② The “Found New Hardware Wizard” will come up as below.
 - Insert the supplied CD into the CD drive, select “Install from a list or specific location (Advanced),” then click [Next>].



- ③ Click “Search for the best device in these locations,” click “Include the location in the search,” click [Browse] to select the CD drive.

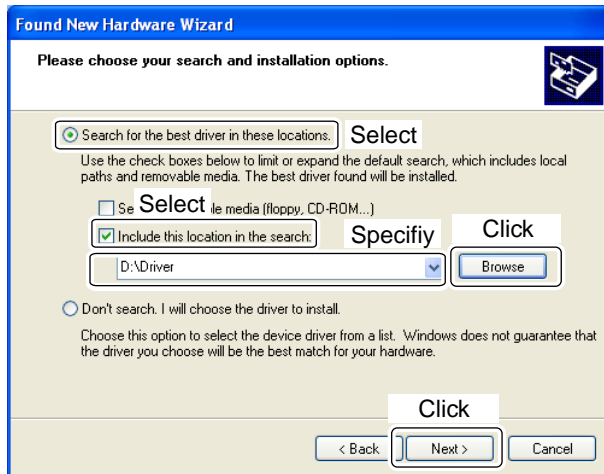

- ④ The wizard starts searching for the driver and shows the dialog below during search.



17 DRIVER INSTALLATION

⑤ After the driver is found the “Hardware Installation” dialog box appears as below.

- Click [Continue Anyway] to start the installation.



⑥ Windows starts installing the USB driver.

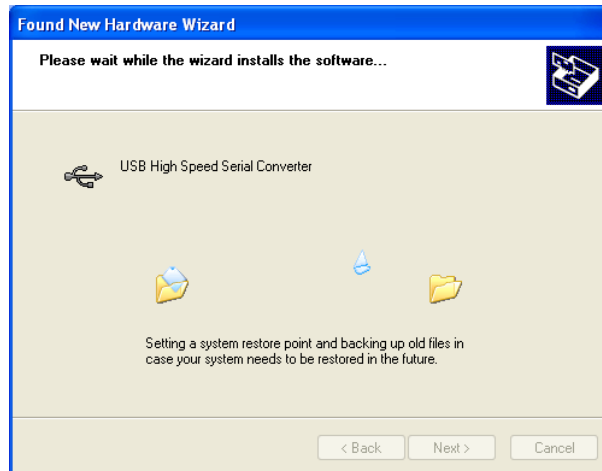

- ⑦ After the installation is completed, click [Finish].



- ⑧ The “Found New Hardware Wizard,” will come up again to install the USB serial port driver.



- ⑨ “Hardware Update Wizard” appears as below. Select “Install from a list or specific location (Advanced)” then click [Next>].



- ⑩ Repeat step ③ to ⑥.

17 DRIVER INSTALLATION

- ⑪ The following screen appears when the installation is completed. Click [Finish] to close the screen.

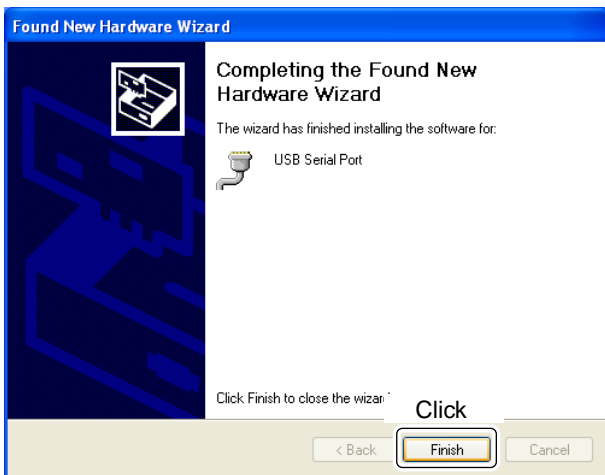

- ⑫ After clicking [Finish], the dialog appears as below.

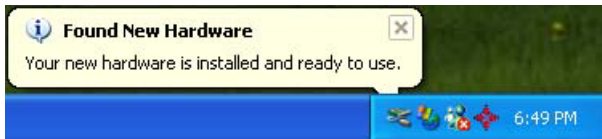

- Rebooting the PC is recommended.

■ For Microsoft® Windows® 2000

- ① Connect the IC-R20 to the desired USB port using with the USB cable, OPC-1382.
• “Found New Hardware” appears as below.

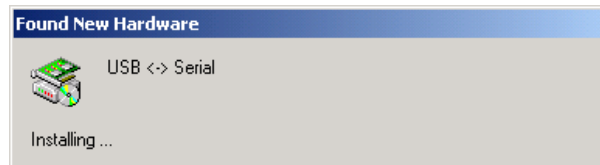

- ② The “Found New Hardware Wizard” will come up as below. Click [Next>].



- ③ Select “Search for a suitable driver for my device (recommended),” then click [Next>].

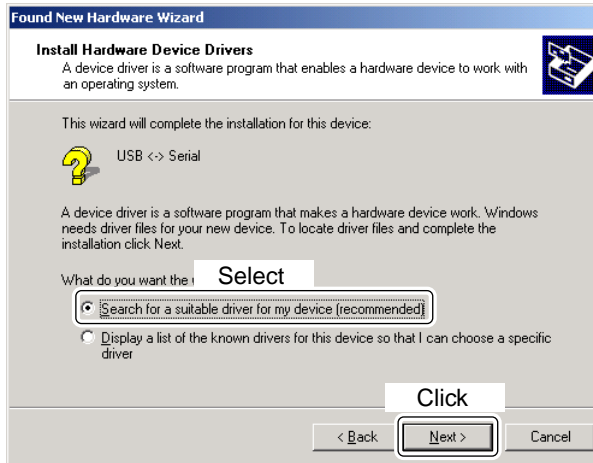

- ④ Select “CD-ROM drives,” and insert the supplied CD into the CD drive, then click [Next>].

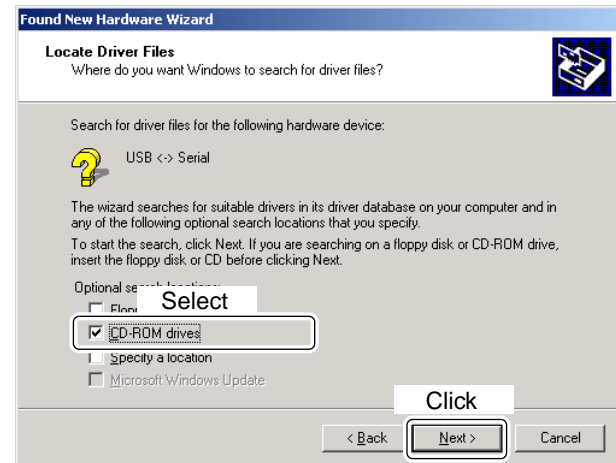

17 DRIVER INSTALLATION

- ⑤ When the driver is found, the following dialog is displayed. Click [Next>] to start the installation.

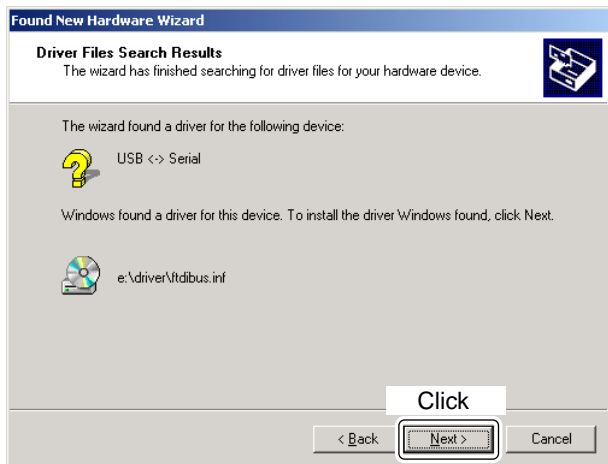

- ⑥ After the installation is completed, click [Finish].



⑦ The “Found New Hardware Wizard,” will come up again to install the USB serial port driver.

- “Found New Hardware” appears as below.

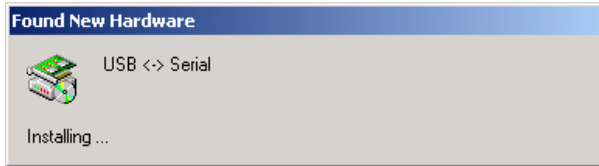

⑧ Repeat step ② to ⑤.

⑨ The following screen appears when the installation is completed. Click [Finish] to close the screen.



- Rebooting the PC is recommended.

■ For Microsoft® Windows® 98/98SE/Me

- ① Connect the IC-R20 to the desired USB port using with the USB cable, OPC-1382.
- ② The “Add New Hardware Wizard” will come up as below. Click [Next>].



17 DRIVER INSTALLATION

③ Select “Search for the best driver for your device. (Recommended),” then click [Next>].



④ Select “Specify a location,” and insert the supplied CD into the CD drive, click [Browse] to select the CD drive, then click [Next>].



- ⑤ When the driver is found, the following dialog is displayed. Click [Next>] to start the installation.



- ⑥ After the installation is completed, click [Finish].



- Rebooting the PC is recommended.

■ COM port confirmation

After the driver installation, confirm the driver availability and the port number are recommended.

In this section, screen shots of Windows XP are used for instruction example. However, the instructions are similar to another operating systems, Windows 98, Me and 2000.

- ① Boot up the Windows.
- ② Select the “Control Panel” in the Start menu.
 - Control panel appears as shown in the next step below.
- ③ Click the “Performance and Maintenance.”
 - Performance and Maintenance menu appears.

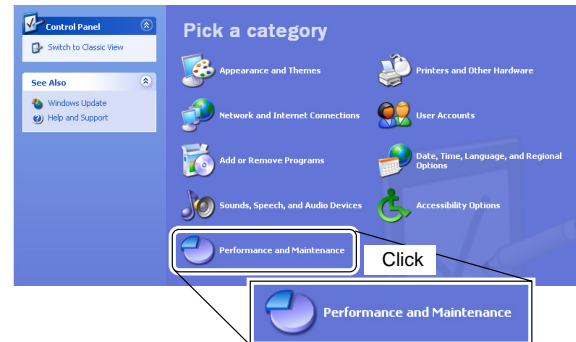

- ④ Click the “System,” then click the “Hardware” tab in the displayed System Properties screen.

17 DRIVER INSTALLATION

⑤ Click the [Device Manager].

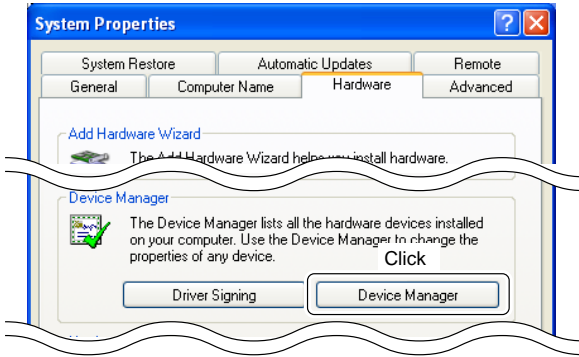

• Device Manager screen appears as below.

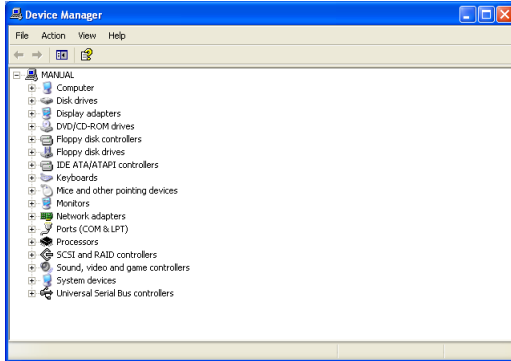

⑥ Click “+” of the “Ports (COM & LPT)” to display the usable COM port and the port number.

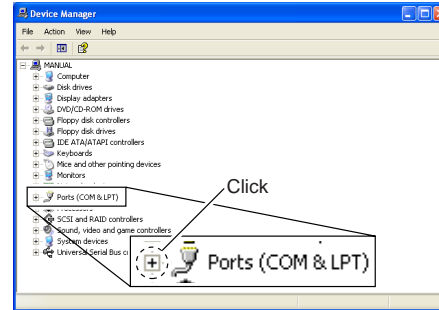

⑦ Confirm the USB serial port availability and the COM port number.



Confirm the USB serial port availability and the COM port number.
(In this example, the USB serial port number is “3.”)

⑧ Close the Device Manager, System Properties screen and then Control panel.

Important operating instructions are summed up in this and the following page for your simple reference.
By cutting along the line and folding on the dotted line, it will become a card sized operating guide which can easily be carried in a card case or wallet, etc.

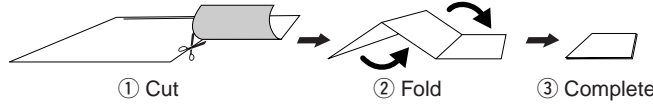

ICOM POCKET GUIDE IC-R20

- **VFO mode selection**
➔ Push **[VFO MHz]** momentarily to select VFO mode.
- **Memory mode selection**
➔ Push **[MR S.MW]** momentarily to select memory mode.
- **Receive mode selection**
➔ Push **[MODE SCAN]** several times to select the desired mode.
- **Audio level setting**
➔ Rotate **[L-DIAL]** (or push **[▲/▼]**) to set the audio level.
- **Squelch level setting**
➔ While pushing **[SQL]**, rotate **[R-DIAL]** to set the squelch level.

←SOUTH HERE→

- **Frequency band selection**
➔ Push **[BAND]** several times, or while pushing **[BAND]**, rotate **[R-DIAL]** to select the desired frequency band.

- **Tuning step selection**
➔ Push **[9 TS]**, then rotate **[R-DIAL]** to select the desired tuning step.
 - Push **[9 TS]** again to return to the previous condition.

- **Single band and dualwatch selection**
➔ Push **[DUALWATCH]** for 1 sec. to toggle between single band and dualwatch operation.

- **Key lock function**
➔ Push **[* LOCK]** for 1 sec. to toggle the key lock function ON and OFF.
 - “**→0**” appears when the lock function is in use.

- **Attenuator function**
➔ Push **[◀◀ ATT]** to toggle the attenuator ON and OFF.
 - “ATT” appears when the attenuator is in use.

- **Frequency setting**
① Push **[VFO MHz]** to select VFO mode.

- ② Rotate **[R-DIAL]** to set the desired operating frequency.
 - Entering keypad directly can be selected the desired frequency.

- **Memory channel selection**
① Push **[MR S.MW]** to select memory mode.

- ② Rotate **[R-DIAL]** to set the desired memory channel.
 - Entering keypad directly can be selected the desired channel.

- **Memory bank channel selection**
① Push **[MR S.MW]** to select memory mode.

- ② Push **[BAND]** several times, or while pushing **[BAND]**, rotate **[R-DIAL]** to select the desired bank.
- ③ Rotate **[R-DIAL]** to select the desired bank channel.

■ Memory channel programming

- 1 Set the desired frequency and other functions in VFO mode.
- 2 Push **[MR S.MW]** for 1 sec. to enter the select memory write condition.
 - 1 short and 1 long beeps sound.
- 3 Rotate **[R-DIAL]** to select the desired memory channel number.
- 4 Push **[MR S.MW]** for 1 sec. again to program the contents into the selected channel.
 - 3 beeps sound.

■ Scan skip setting

- 1 Push **[MR S.MW]** to select memory mode.
- 2 Rotate **[R-DIAL]** to select the desired memory channel.
- 3 While pushing **[S SKIP]**, rotate **[R-DIAL]** to set the skip setting (skip channel or skip frequency) ON and OFF.

■ VFO scans

- 1 Push **[VFO MHz]** to select VFO mode.
- 2 While pushing **[MODE SCAN]**, rotate **[R-DIAL]** to select the desired scan type.
 - Selectable from "ALL," "BAND" or "PROG xx" (xx= 0-24).

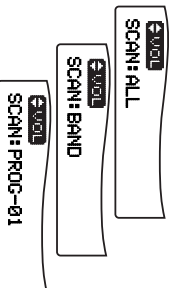

- 3 Release **[MODE SCAN]** to start scan.
- 4 Rotate **[R-DIAL]** to change the scanning direction.
 - During scan, push **[MR S.MW]** to start auto memory write scan.
- 4 Push **[DUALWATCH]** to stop scan.

■ Memory scans

- 1 Push **[MR S.MW]** to select memory mode.
 - Push **[BANK]** to select a bank, if desired.
- 2 While pushing **[MODE SCAN]**, rotate **[R-DIAL]** to select the desired scan type.
 - Selectable from "ALL," "BANK-LINK" or "BANK."

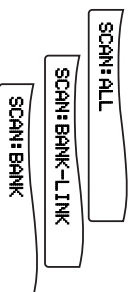

- 3 Release **[MODE SCAN]** to start memory/bank scan.
- 4 Rotate **[R-DIAL]** to change the scanning direction.
- 4 Push **[DUALWATCH]** to stop scan.



We Icom Inc. Japan
1-1-32, Kamiminami, Hirano-ku
Osaka 547-0003, Japan

Declare on our sole responsibility that this equipment complies with the essential requirements of the Radio and Telecommunications Terminal Equipment Directive, 1999/5/EC, and that any applicable Essential Test Suite measurements have been performed.

Kind of equipment: COMMUNICATIONS RECEIVER

Type-designation: IC-R20

Version (where applicable):

This compliance is based on conformity with the following harmonised standards, specifications or documents:

- i) Article 3.1a EN 60950 (1992-08)+A11:1997
- ii) Article 3.1b EN 301489-1 and EN 301489-15
- iii) Article 3.2 EN 301 783-2
- iv) _____
- v) _____

DECLARATION OF CONFORMITY



Düsseldorf 23rd Mar. 2004
Place and date of issue

Icom (Europe) GmbH
Himmelgeister straÙe 100
D-40225 Düsseldorf

Authorized representative name
T. Maebayashi
General Manager

Signature

Icom Inc.

Count on us!

#02 Europe

#03 U.K.

<Intended Country of Use>			
<input checked="" type="checkbox"/> GER	<input type="checkbox"/> FRA	<input checked="" type="checkbox"/> ESP	<input checked="" type="checkbox"/> SWE
<input checked="" type="checkbox"/> AUT	<input checked="" type="checkbox"/> NED	<input checked="" type="checkbox"/> POR	<input checked="" type="checkbox"/> DEN
<input checked="" type="checkbox"/> GBR	<input checked="" type="checkbox"/> BEL	<input checked="" type="checkbox"/> ITA	<input checked="" type="checkbox"/> FIN
<input checked="" type="checkbox"/> IRL	<input checked="" type="checkbox"/> LUX	<input checked="" type="checkbox"/> GRE	<input type="checkbox"/> SUI
<input type="checkbox"/> NOR			

#07 France

<Intended Country of Use>			
<input type="checkbox"/> GER	<input checked="" type="checkbox"/> FRA	<input type="checkbox"/> ESP	<input type="checkbox"/> SWE
<input type="checkbox"/> AUT	<input type="checkbox"/> NED	<input type="checkbox"/> POR	<input type="checkbox"/> DEN
<input type="checkbox"/> GBR	<input type="checkbox"/> BEL	<input type="checkbox"/> ITA	<input type="checkbox"/> FIN
<input type="checkbox"/> IRL	<input type="checkbox"/> LUX	<input type="checkbox"/> GRE	<input type="checkbox"/> SUI
<input type="checkbox"/> NOR			