

KENWOOD

HF TRANSCEIVER

TS-870S

Intelligent Digital Enhanced Communications System

INSTRUCTION MANUAL

KENWOOD CORPORATION

Downloaded by

Amateur Radio Directory

APPLICABLE MODEL

This manual applies to the following model:

TS-870S: HF Transceiver

Intelligent Digital Enhanced Communications System

WRITING CONVENTIONS FOLLOWED

The writing conventions described below have been followed to simplify instructions and avoid unnecessary repetition. This format is less confusing for the reader. Reviewing the following information now will reduce your learning period. That means less time will be spent reading this manual; more time will be available for operating.

Furthermore, a system of advisories is used as follows:

CAUTION: Possibility of equipment damage

Note: Important information or operating tip

Instruction	What to do
Press [KEY].	Press and release KEY.
Press [KEY1]+[KEY2].	Press and hold KEY1 down, then press KEY2. If there are more than two keys, press and hold down each key in turn until the final key has been pressed.
Press [KEY1], [KEY2].	Press KEY1 momentarily, release KEY1, then press KEY2.
Press [KEY]+ POWER ON.	With the transceiver power OFF, press and hold KEY, then switch ON the transceiver power by pressing the POWER switch.

Note: Basic procedures are numbered sequentially to guide you step-by-step. Additional information pertaining to a step, but not essential to complete the procedure, is provided in bulleted form following many steps for further guidance.

NOTICE TO THE USER

One or more of the following statements may be applicable to this equipment.

FCC WARNING

This equipment generates or uses radio frequency energy. Changes or modifications to this equipment may cause harmful interference unless the modifications are expressly approved in the instruction manual. The user could lose the authority to operate this equipment if an unauthorized change or modification is made.

INFORMATION TO THE DIGITAL DEVICE USER REQUIRED BY THE FCC

This equipment has been tested and found to comply with the limits for a Class B digital device, pursuant to Part 15 of the FCC Rules. These limits are designed to provide reasonable protection against harmful interference in a residential installation.

This equipment generates, uses and can generate radio frequency energy and, if not installed and used in accordance with the instructions, may cause harmful interference to radio communications. However, there is no guarantee that the interference will not occur in a particular installation. If this equipment does cause harmful interference to radio or television reception, which can be determined by turning the equipment off and on, the user is encouraged to try to correct the interference by one or more of the following measures:

- Reorient or relocate the receiving antenna.
- Increase the separation between the equipment and receiver.
- Connect the equipment to an outlet on a circuit different from that to which the receiver is connected.
- Consult the dealer for technical assistance.

PRECAUTIONS

Please read all safety and operating instructions before using this transceiver. For best results, be aware of all warnings on the transceiver and follow the provided operating instructions. Retain these safety and operating instructions for future reference.

1 Power Sources

Connect this transceiver only to the power source described in the operating instructions or as marked on the transceiver itself.

2 Power Cable Protection

Route all power cables safely. Ensure the power cables can neither be walked upon nor pinched by items placed near or against the cables. Pay particular attention to locations near AC receptacles, AC extension bars and points of entry to the transceiver.

3 Electrical Shocks

Take care not to drop objects or spill liquids into the transceiver through enclosure openings. Metal objects, such as hairpins or needles, inserted into the transceiver may contact voltages resulting in serious electrical shocks. Never permit children to insert any objects into this transceiver.

4 Grounding and Polarization

Do not attempt to defeat methods used for grounding and electrical polarization in the transceiver, particularly involving the input power cable.

5 Outdoor Antenna Grounding

Adequately ground all outdoor antennas used with this transceiver using approved methods. Grounding helps protect against voltage surges caused by lightning. It also reduces the chance of a build-up of static charges.

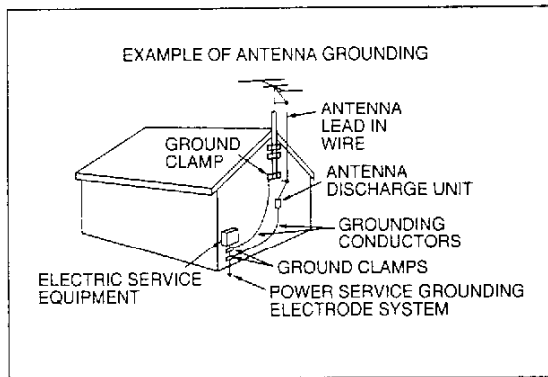

6 Power Lines

Minimum recommended distance for an outdoor antenna from power lines is one and one-half times the vertical height of the associated antenna support structure. This distance allows adequate clearance from the power lines if the support structure should fail for any reason.

7 Ventilation

Locate the transceiver so as not to interfere with its ventilation. Do not place books or other equipment on the transceiver that may impede the free movement of air. Allow a minimum of 4 inches (10 cm) between the rear of the transceiver and the wall or operating desk shelf.

8 Water and Moisture

Do not use the transceiver near water or sources of moisture. For example, avoid use near bathtubs, sinks, swimming pools, and in damp basements and attics.

9 Abnormal Odors

The presence of an unusual odor or smoke is often a sign of trouble. Immediately turn the power OFF and remove the power cable. Contact a dealer or the nearest Service Center for advice.

10 Heat

Locate the transceiver away from heat sources such as radiators, stoves, amplifiers or other devices that produce substantial amounts of heat.

11 Cleaning

Do not use volatile solvents such as alcohol, paint thinner, gasoline or benzene to clean the cabinet. Use a clean cloth with warm water or a mild detergent.

12 Periods of Inactivity

Disconnect the input power cable from the power source when the transceiver is not used for long periods of time.

13 Servicing

Remove the transceiver's enclosure only to do accessory installations described by this manual or accessory manuals. Follow provided instructions carefully to avoid electrical shocks. If unfamiliar with this type of work, seek assistance from an experienced individual, or have a professional technician do the task.

14 Damage Requiring Service

Enlist the services of qualified personnel in the following cases:

- The power supply or plug is damaged.
- Objects have fallen or liquid has spilled into the transceiver.
- The transceiver has been exposed to rain.
- The transceiver is operating abnormally or performance has degraded seriously.
- The transceiver has been dropped or the enclosure damaged.

CONTENTS

APPLICABLE MODEL	Inside Front Cover	DUAL DIGITAL VFOs	19
WRITING CONVENTIONS FOLLOWED	Inside Front Cover	SELECTING VFOs ([RX A], [RX B])	19
NOTICE TO THE USER	Inside Front Cover	EQUALIZING VFO FREQUENCIES ([A=B])	20
PRECAUTIONS	i	SELECTING MODE	20
CONTENTS	ii	SELECTING FREQUENCY	20
CHAPTER 1 INTRODUCTION	1	CHANGING BANDS	20
THANK YOU!	1	USING 1 MHz STEPS	20
DSP — MAXIMUM SIGNAL/ MINIMUM NOISE	1	QUICK CHANGES	21
FEATURES	1	Changing Step Sizes	21
SUPPLIED ACCESSORIES	1	FINE TUNING	21
CHAPTER 2 INSTALLATION	2	DIRECT FREQUENCY ENTRY	22
ANTENNA CONNECTION	2	FRONT PANEL METER	22
GROUND CONNECTION	3	TRANSMITTING	23
LIGHTNING PROTECTION	3	SELECTING TRANSMIT POWER	23
DC POWER SUPPLY CONNECTION	3	TRANSMIT CARRIER LEVEL	23
REPLACING FUSES	3	MICROPHONE GAIN	23
ACCESSORY CONNECTIONS	4	CHAPTER 5 MENU SETUP	24
FRONT PANEL	4	WHAT IS A MENU?	24
Headphones (PHONES)	4	MENU ACCESS	24
Microphone (MIC)	4	MENU A/ MENU B	24
REAR PANEL	4	QUICK MENU FUNCTION	24
External Speaker (EXT SP)	4	Programming the Quick Menu	24
Keys and Keyboards for CW Operation (PADDLE and KEY)	4	Using the Quick Menu	24
Computer Interface (COM)	5	TEMPORARY MENU RESETTING	24
RTTY Equipment (RTTY and ACC 2)	5	MENU CONFIGURATION	25
Linear Amplifier (REMOTE)	5	CROSS REFERENCE FOR MENU FUNCTIONS	28
Antenna Tuner (AT)	6	CHAPTER 6 COMMUNICATING	29
SM-230 Station Monitor (IF OUT 1)	6	SSB TRANSMISSION	29
Accessory Equipment (ACC 2)	6	SLOW SCAN TV/ FACSIMILE	29
CHAPTER 3 GETTING ACQUAINTED	8	CW TRANSMISSION	30
YOUR FIRST QSO	8	TX SIDETONE/ RX PITCH FREQUENCY	30
RECEIVING	8	ZERO-BEATING	30
TRANSMITTING	9	SWITCHING TX/RX MANUALLY	30
FRONT PANEL	10	SEMI BREAK-IN	31
MICROPHONE	14	Setting Delay Time	31
REAR PANEL	15	FULL BREAK-IN	31
DISPLAY	16	CW REVERSE (RECEIVE)	31
CHAPTER 4 OPERATING BASICS	19	RISE/DECAY TIMES	31
SWITCHING POWER ON/OFF	19	ELECTRONIC KEYS	32
ADJUSTING VOLUME	19	Learning Outline	32
AUDIO FREQUENCY (AF) GAIN	19	Multiple-Button Functions	33
RADIO FREQUENCY (RF) GAIN	19	Emulation Options	33
ADJUSTING SQUELCH	19	Storing CW Messages	34
		CW Message Playback	34
		Erasing CW Messages	35
		Inquiry Functions	35
		Function Commands	36
		Embedded Functions	37
		Serial Number Options	37

FM TRANSMISSION	38
FM REPEATER OPERATION	38
Selecting Subtone Frequency	39
Continuous or Burst Subtones?	39
AM TRANSMISSION	40
DIGITAL OPERATION	40
RTTY (FREQUENCY SHIFT KEYING)	40
ERROR-CHECKING MODES (AMTOR/ PACKET/ PACTOR/ G-TOR/ CLOVER)	41
SPLIT-FREQUENCY OPERATION	42
TF-SET (TRANSMIT FREQUENCY SET)	43
SATELLITE OPERATION	43

CHAPTER 7 OPERATING AIDS 44

RECEIVING	44
RIT (RECEIVE INCREMENTAL TUNING)	44
AGC (AUTOMATIC GAIN CONTROL)	44
Changing AGC	44
Changing AF AGC	44
TRANSMITTING	45
VOX (VOICE-OPERATED TRANSMIT)	45
Microphone Input Level Adjustment	45
Delay Time Adjustment	45
TRANSMIT INHIBIT	45
XIT (TRANSMIT INCREMENTAL TUNING)	45
SPEECH PROCESSOR (SSB/AM)	46
CHANGING FREQUENCY WHILE TRANSMITTING	46
TRANSMIT MONITOR	46
CUSTOMIZING TRANSMIT SIGNAL CHARACTERISTICS (SSB/AM)	47
Changing Transmit Bandwidth	47
Transmit Bandshift	47
Equalizing Transmit Audio	47
Microphone AGC	47
AUTOMATIC MODE	48
AUTOMATIC MODE BOUNDARIES	48
USING AUTOMATIC MODE	48
AUTOMATIC ANTENNA TUNER	49
PRESETTING (INTERNAL TUNER ONLY)	49
INTERNAL TUNER	49
AT-300 EXTERNAL TUNER (OPTIONAL)	50
COMPUTER ↔ TRANSCIVER INTERFACE ...	50
COMMUNICATION PARAMETERS	50

CHAPTER 8 REJECTING INTERFERENCE 51

DSP TOOLS	51
SLOPE TUNING (SSB/AM)	51
IF SHIFT (CW)	51
CHANGING RECEIVE BANDWIDTH (CW/FSK/FM)	52
ADAPTIVE FILTERS	52
AUTO NOTCH (SSB)	52
BEAT CANCEL (SSB/AM)	52
NOISE REDUCTION (SSB/CW/FSK/AM)	53
SETTING SPAC TIME	53
NOISE BLANKER	53
AIP (ADVANCED INTERCEPT POINT)	53
ATTENUATOR	53

CHAPTER 9 MEMORY FEATURES 54

MICROPROCESSOR MEMORY BACKUP	54
CONVENTIONAL OR QUICK MEMORY?	54
CONVENTIONAL MEMORY	54
MEMORY CHANNEL DATA	54
MEMORY CHANNEL STORAGE	54
Simplex Channels	54
Split-Frequency Channels	55
MEMORY CHANNEL RECALL	55
Quick Channel Search	55
Temporary Frequency Changes	56
MEMORY CHANNEL SCROLL	56
MEMORY TRANSFER	56
Memory → VFO Transfers	56
Channel to Channel Transfers	57
ERASING MEMORY CHANNELS	57
Full Reset	57
STORING SCAN LIMITS IN CH 99	58
Confirming Start/End Frequencies	58
Programmable VFO Function	58
QUICK MEMORY	59
STORING INTO QUICK MEMORY	59
RECALLING FROM QUICK MEMORY	59
TEMPORARY FREQUENCY CHANGES	59
QUICK MEMORY → VFO	59

CHAPTER 10 SCAN 60

PROGRAM SCAN	60
SCAN HOLD	60
CONFIRMING START/END LIMITS	60
MEMORY SCAN	61
BUSY FREQUENCY STOP	61
Scan Resume Methods	61
ALL-CHANNEL SCAN	61
GROUP SCAN	62
MEMORY CHANNEL LOCKOUT	62
SETTING SCAN SPEED	62



CHAPTER 11 OPERATOR CONVENIENCES 63

MICROPROCESSOR RESET	63
INITIAL SETTINGS	63
PARTIAL RESET	63
FULL RESET	63
SWITCHING ANT 1/ ANT 2	63
PROGRAMMABLE FUNCTION BUTTONS	63
ASSIGNING FUNCTIONS	64
USING THE PROGRAMMED BUTTONS	64
LOCK FUNCTION	64
BEEP FUNCTION	64
BUTTON CONFIRMATION	65
ALARM NOTIFICATION	65
DISPLAY DIMMER	65
QUICK DATA TRANSFER	65
SETTING UP	65
Equipment Needed	65
Connections	66
USING QUICK TRANSFER	66
Transferring Data	66
Receiving Data	66
DRU-3 DIGITAL RECORDING SYSTEM (OPTIONAL)	67
RECORDING MESSAGES	67
MESSAGE PLAYBACK	67
Checking Messages	67
Transmitting Messages (VOX)	67
Transmitting Messages (Manual TX/RX)	68
CONTINUOUS MULTI-CHANNEL PLAYBACK	68
ALTERING INTER-MESSAGE INTERVAL	68
VS-2 VOICE SYNTHESIZER (OPTIONAL)	68

CHAPTER 12 MAINTENANCE 69

GENERAL INFORMATION	69
SERVICE	69
SERVICE NOTE	69
CLEANING	69
INTERNAL ADJUSTMENTS	70
REFERENCE FREQUENCY CALIBRATION	70
DRU-3 DIGITAL RECORDING UNIT (OPTIONAL)	70
AT-300 EXTERNAL TUNER (OPTIONAL)	70
TROUBLESHOOTING	71

CHAPTER 13 OPTIONAL ACCESSORIES 74**CHAPTER 14 INSTALLING OPTIONS 75**

REMOVING THE CASE	75
TOP CASE	75
BOTTOM CASE	75
DRU-3 DIGITAL RECORDING UNIT	75

VS-2 VOICE SYNTHESIZER UNIT	75
SO-2 TEMPERATURE-COMPENSATED CRYSTAL OSCILLATOR (TCXO)	76

SPECIFICATIONS 77**APPENDICES 79**

APPENDIX A: LEARNING ABOUT DSP	79
APPENDIX B: PROPAGATION INFORMATION ...	80
STANDARD TIME AND INFORMATION STATIONS	80
NCDXF/IARU BEACON NETWORK	80
HF BEACONS	80
APPENDIX C: GENERAL COVERAGE RECEIVER FOR SWLING	82
APPENDIX D: COM CONNECTOR PROTOCOL	83
HARDWARE DESCRIPTION	83
CONTROL OPERATION	83
COMMANDS	83
COMMAND DESCRIPTION	83
PARAMETER DESCRIPTION	84
TERMINATOR	85
TYPES OF COMMANDS	85
COMPUTER CONTROL COMMANDS	85
ERROR MESSAGES	86
COMMAND USE PRECAUTIONS	86
MENU SELECTION TABLE FOR "EX" COMMAND, PARAMETER 36	87
READING COMMAND TABLES	89
COMMAND TABLES	89

INDEX 96

INTRODUCTION

THANK YOU!

The TS-870S **Intelligent Digital Enhanced Communications System** was developed by a team of engineers determined to continue the tradition of excellence and innovation in **KENWOOD** HF transceivers.

Taking maximum advantage of Digital Signal Processing technology, the TS-870S introduces operating tools like Auto Notch, Beat Cancel, and Noise Reducer. When coupled with its IF Shift, Noise Blanker, and Advanced Intercept Point functions, you will enjoy a critical edge as you fight QRM and QRN in the new solar cycle. In addition, the convenience of a built-in RS-232C connector can transport your shack into the world of remote transceiver control via computer.

But first, tame your ego and enthusiasm temporarily — read every page of this book. Consider this manual to be a personal tutorial from the designers; allow it to guide you through the learning process now, then act as a reference in the coming years. Though user friendly, the TS-870S is technically sophisticated and some features may be new to you. Your reward for your diligence will be mastery of the TS-870S in the shortest time possible with maximum fun.

As you continue exploring Amateur radio, thank you for allowing the **KENWOOD** family to join you in this chapter of your adventure.

DSP —

MAXIMUM SIGNAL/ MINIMUM NOISE

The TS-870S design includes a 2-channel Sigma-delta A/D converter, two 2-channel Sigma-delta D/A converters, and a 2-channel advanced single-bit D/A converter. Operating at a clock rate of 40 MHz, DSP works for you whether you use SSB, CW, FM, or any other mode. The adaptive filter functions include Auto Notch, Line Enhance, and Beat Cancel.

DSP is the most effective way of using current technology to separate what you want from what you don't want. While receiving, you hear the most signal and the least noise. While transmitting, you emit only the desired audio components of the modulation without adding distortion. The transmit equalizer combines high boost, bass boost, and comb filter functions to further improve your signal.

With DSP, you will hear clear receive signals that are covered by noise on conventional equipment. The enhancement of the receive signal is due to the reduction of atmospheric and white noise, and to rejection of adjacent frequency interference including heterodynes. This capability of DSP to "clean up" the environment surrounding the desired signal has a significant effect. The signal you are trying to receive will seem stronger and clearer even though the S-meter reads the same. Those tired of listening to interference of all kinds while operating may think a little magic is being used.

FEATURES

1

- Employs Digital Signal Processing (DSP) techniques to significantly improve the quality of received and transmitted signals.
- Includes extensive user-adjustable digital and analog filtering functions for combating all forms of received interference.
- Allows total customization of transmitted audio through use of functions such as Transmit Equalizer.
- Introduces a built-in RS-232C port for directly interfacing to a computer. Supports computer control of functions at a user-selectable transfer rate between 1200 and 57600 bps inclusive.
- Streamlines function setup by presenting an intuitive Menu System for function configuration and control.
- Conveniently allows ANTENNA1/ANTENNA2 selection from the Front Panel.
- Directly addresses CW operators' interests by including a full-function K-1 Logikey complete with test mode, semi-automatic mode, and popular keyer emulations. The Rear Panel is equipped with a PADDLE jack and a KEY jack for connecting a paddle, an external keyer, or a keyboard.
- Provides an antenna tuner that can easily be inserted into or removed from the transmit and receive paths.

SUPPLIED ACCESSORIES

Accessory	Part Number	Quantity
Microphone	T91-0352-XX	1
DC power cable	E30-3157-XX	1
7-pin DIN plug	E07-0751-XX	1
13-pin DIN plug	E07-1351- 05	1
Fuse (25 A)	F05-2531-XX	1
Fuse (4 A)	F06-4029-XX	1
Instruction manual	B62-0542-XX	1
Warranty card (U.S.A., Canada, and Europe only)	—	1

INSTALLATION

2

Install and connect an antenna system {page 2}.

Install a ground system that satisfies DC and RF grounding requirements {page 3}.

Install lightning protection to protect the antenna system, your personal safety, and your property {page 3}.

Install and connect a DC power supply {page 3}.

Connect all accessories to the transceiver {page 4}. Accessories include the following:

- Microphone
- Antenna Tuner
- CW Key
- Computer
- TNC/ Multimode Communications Processor
- Headphones
- External Speaker
- RTTY Equipment
- Linear Amplifier

ANTENNA CONNECTION

The type of the antenna system, consisting of the antenna, ground, and feed line, will greatly affect the successful performance of the transceiver. Use a properly adjusted 50 Ω antenna of good quality to let your transceiver perform at its best. Use a good-quality 50 Ω coaxial cable and a first-quality connector for the connection. Match the impedance of the coaxial cable and antenna so that the SWR is 1.5:1 or less. All connections must be clean and tight.

While the transceiver's protection circuit will activate if the SWR is greater than 2.5:1, do not rely on protection to compensate for a poorly functioning antenna system. High SWR will cause the transmit output to drop, and may lead to radio frequency interference to consumer products such as stereo receivers and televisions. You may even interfere with your own transceiver. Reports that your signal is garbled or distorted, especially at peak modulation, may indicate that your antenna system is not efficiently radiating the transceiver's power. If you feel a tingle from the transceiver's cabinet or the microphone's metal fittings when you modulate, you can be certain that, at the least, your coax connector is loose at the rear of the radio and, at the worst, your antenna system is not efficiently radiating power.

Connect your antenna feed line to **ANT 1**. If you are using two antennas, connect the second antenna to **ANT 2**. The **EXT RX ANT** jack can be used to connect a separate receiver. Note that this jack must be enabled by Menu configuration {pages 24, 27} before it can be used.

CAUTION:

- ♦ Transmitting without first connecting an antenna or other matched load may damage the transceiver. Always connect the antenna to the transceiver before transmitting.
- ♦ Use a lightning arrestor to prevent fire, electric shock, or damage to the transceiver.

APPROX. LOSS (dB) PER 30 METERS (100 FEET) OF CORRECTLY MATCHED 50 Ω LINE

- Use only as a general guide. Specifications may vary between cable manufacturers.

Transmission Line	3.5 MHz	14 MHz	30 MHz
RG-174, -174A	2.3	4.3	6.4
RG-58A, -58C	0.75	1.6	2.6
3D-2V	0.80	1.5	2.3
RG-58, -58B	0.65	1.5	2.3
RG-58 Foam	0.70	1.4	2.1
RG-8X	0.50	1.0	2.0
5D-2V	0.45	0.93	1.4
RG-8, -8A, -9, -9A, 9B, -213, 214, 215	0.38	0.80	1.2
5D-FB	N/A	0.80	1.0
RG-8 Foam	0.29	0.60	0.90
8D-2V	0.29	0.60	0.90
10D-2V	0.24	0.50	0.72
9913	0.24	0.48	0.70
8D-FB	N/A	0.48	0.68
10D-FB	N/A	0.37	0.54
12D-FB	N/A	0.33	0.45
RG-17, -17A	0.13	0.29	0.48
1/2" Hardline	0.12	0.26	0.40
20D-2V	< 0.10	0.25	0.39
3/4" Hardline	< 0.10	0.21	0.32
7/8" Hardline	< 0.10	0.16	0.26

N/A: Not available

GROUND CONNECTION

At the minimum, a good DC ground is required to prevent such dangers as electric shock. For superior communications results, a good RF ground is required, against which the antenna system can operate. Both of these conditions can be met by providing a good earth ground for your station. Bury one or more ground rods, or a large copper plate under the ground, and connect this to the transceiver GND terminal. Use heavy gauge wire or a copper strap, cut as short as possible, for this connection. Just as for antenna work, all connections must be clean and tight.

LIGHTNING PROTECTION

Consider carefully how to protect your equipment and your home from lightning. Even in areas where lightning storms are less common, there is usually a limited number of storms each year. Take the time to study the best way to protect your installation from the effects of lightning by consulting reference material on the subject.

The installation of a lightning arrestor is a start, but there is more that you can do. For example, terminate your antenna system transmission lines at an entry panel that you install outside your home. Ground this entry panel to a good outside ground, and then connect appropriate feed lines between the entry panel and your transceiver. When a lightning storm occurs, you can ensure added protection by disconnecting the feed lines from your transceiver.

CAUTION: DO NOT attempt to use a gas pipe (which is clearly dangerous), an electrical conduit (which has the whole house wiring attached and may act like an antenna), or a plastic water pipe for a ground.

DC POWER SUPPLY CONNECTION

In order to use this transceiver, you will need a separate 13.8 V DC power supply that must be purchased separately. DO NOT directly connect the transceiver to an AC outlet! Use the supplied DC power cable to connect the transceiver to a regulated power supply. Do not substitute a cable with smaller gauge wires. The current capacity of your power supply must be 20.5 A or more.

CAUTION:

- ◆ Before connecting the DC power supply to the transceiver, be sure to switch the transceiver and the DC power supply OFF.
- ◆ Do not plug the DC power supply into an AC outlet until you make all connections.
- ◆ This transceiver has not been tested for use in mobile applications.

First connect the DC power cable to the regulated DC power supply and check that polarities are correct (Red: positive, Black: negative). Then connect the connectorized end of the DC power cable to the **DC 13.8 V** power connector on the transceiver Rear Panel. Press the DC power cable connector firmly into the connector on the transceiver until the locking tab clicks.

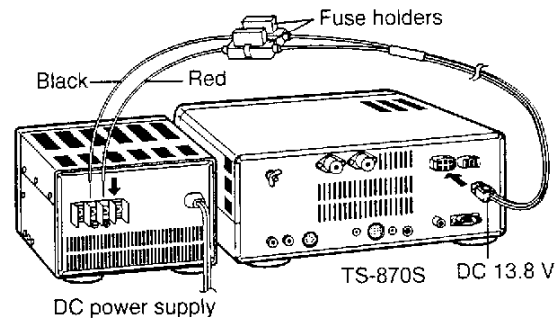

REPLACING FUSES

If the fuse blows, determine the cause then correct the problem. After the problem is resolved, only then replace the fuse. If newly installed fuses continue to blow, disconnect the power plug and contact your dealer or nearest Service Center for assistance.

Fuse Location	Fuse Current Rating
TS-870S	4 A (for AT-300 Tuner)
Supplied Accessory Cable	25 A

CAUTION: Replace blown fuses only after investigating and correcting the cause of the failed fuse. Always replace a blown fuse by a new fuse with the specified ratings.

Downloaded by

Amateur Radio Directory

2 INSTALLATION

ACCESSORY CONNECTIONS

FRONT PANEL

2

■ Headphones (PHONES)

Use headphones having 4 to 32 Ω impedance. You can also use stereo headphones. When headphones are used, no sound is heard from the internal (or optional external) speaker. Use a 6.0 mm (1/4") diameter, 2-conductor (mono) or 3-conductor (stereo) plug.

■ Microphone (MIC)

To communicate in the voice modes, connect to the MIC connector a microphone having an impedance between 250 Ω and 600 Ω . Insert the connector from your microphone fully, then screw the retaining ring clockwise until snug. Compatible microphones include the MC-43S, MC-60A, MC-80, MC-85, and MC-90. Do not use the MC-44, MC-44DM, MC-45, MC-45E, MC-45DM, or MC-45DME microphone.

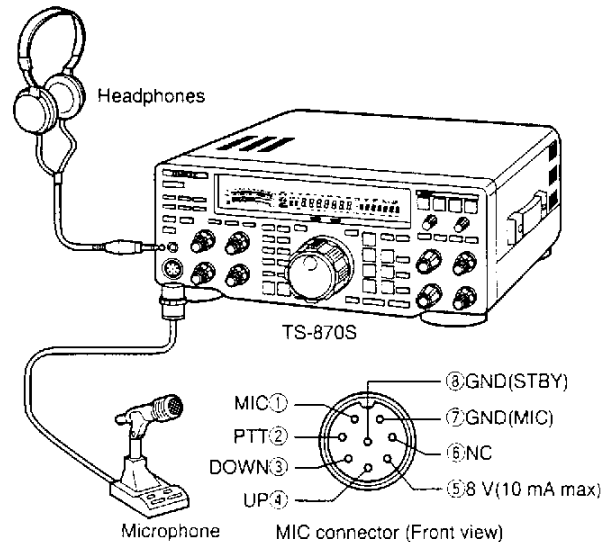

REAR PANEL

■ External Speaker (EXT SP)

Ensure any external speaker used has an impedance of 8 Ω . Use a 3.5 mm (1/8") diameter, 2-conductor (mono) plug. When an external speaker is used, no sound is heard from the internal speaker.

WARNING! Do not connect headphones to this jack. The high audio output at this jack could damage your hearing.

■ Keys and Keyboards for CW Operation (PADDLE and KEY)

For CW operation using the internal electronic keyer, connect a keyer paddle to the PADDLE jack. For CW operation without using the internal electronic keyer, connect a straight key, semi-automatic key (bug), electronic keyer, or the CW keyed output from a Multimode Communications Processor (MCP) to the KEY jack. The jacks mate with a 6.0 mm (1/4") 3-conductor plug and a 3.5 mm (1/8") 2-conductor plug respectively. External electronic keyers or MCPs must use positive keying to be compatible with this transceiver. Use a shielded cable between the key and the transceiver.

Note: Due to the full-featured functionality of the internal electronic keyer, you may decide it's unnecessary to connect both a paddle and another type of key unless you specifically want to use a keyboard for CW. It's recommended that you become familiar with the internal keyer by reading "ELECTRONIC KEYER" (page 32) before making your decision.

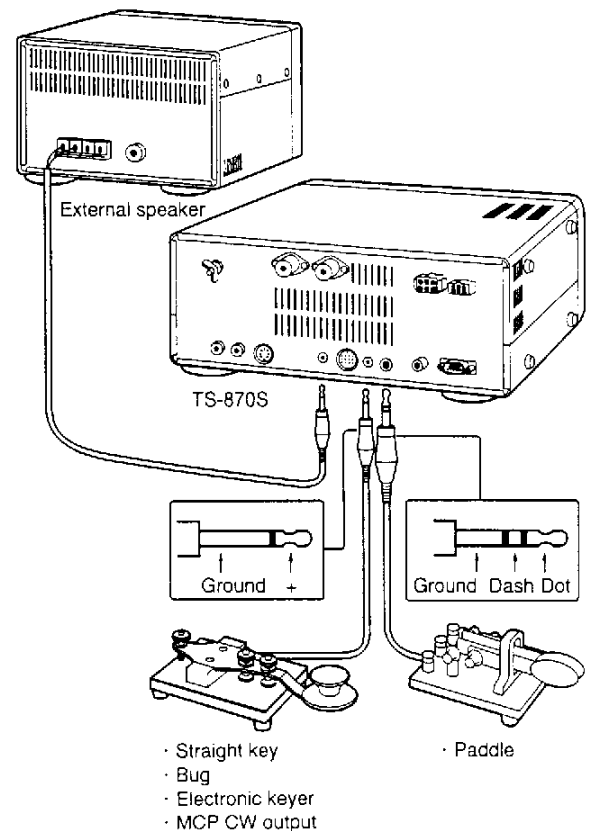

■ **Computer Interface (COM)**

This connector allows you to directly connect a computer or dumb terminal by using an RS-232C cable terminated with a female 9-pin connector. No external hardware interface is required between your computer and the transceiver if your computer has an unused RS-232C serial communications port. See Appendix D on page 83 for information relating to this connector.

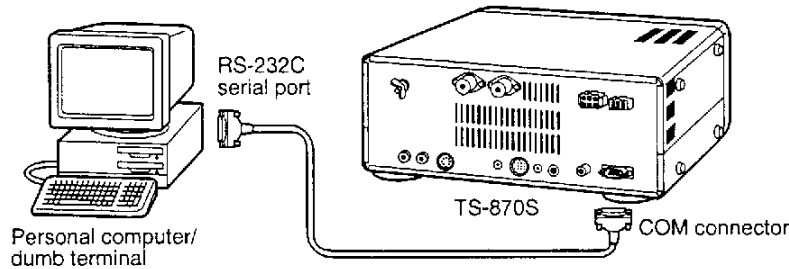

■ **RTTY Equipment (RTTY and ACC 2)**

To operate Frequency Shift Keyed RTTY, connect your RTTY equipment as shown below. Connect the RTTY key output from your RTTY equipment to **RTTY**, and connect the demodulation input of your RTTY equipment to **ACC 2, Pin 3**. By default, a short condition generates a space; an open generates a mark. However, this can be reversed via Menu settings.

Do not share a single power supply between the transceiver and the RTTY equipment. Keep as wide a separation as possible between the transceiver and the RTTY equipment as practical to reduce noise-pickup by the transceiver.

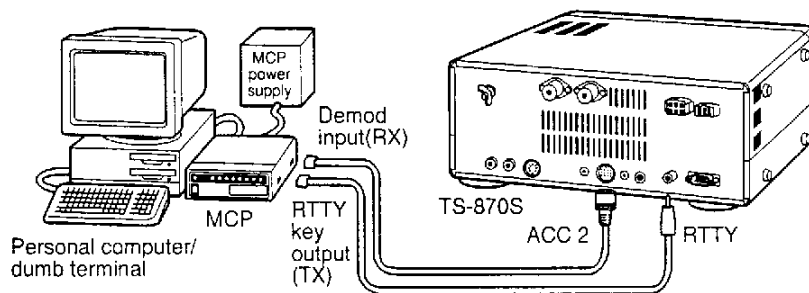

■ **Linear Amplifier (REMOTE)**

The **REMOTE** connector allows connection of an external transmit power amplifier. If using an amplifier, confirm that Menu No. 51 (LINEAR) is set to "1" (Fast) or "2" (Slow) (pages 24, 27). This Menu item controls the linear amplifier TX/RX relay response time. Use the Fast setting unless you experience switching problems when using your amplifier for semi break-in operation.

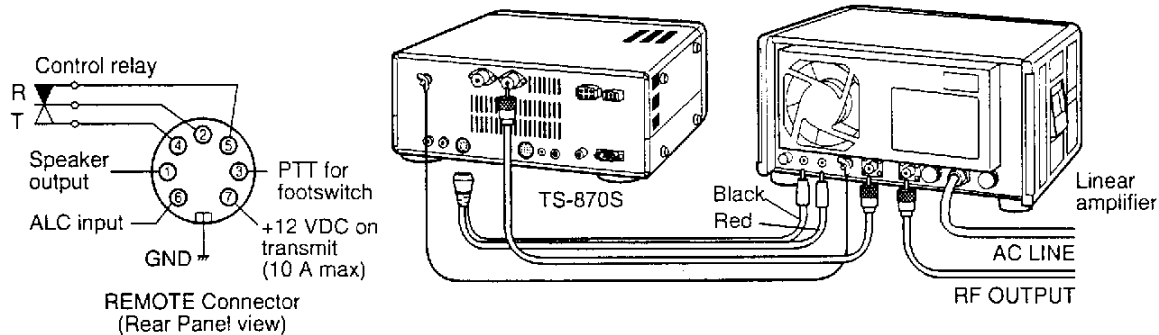

2 INSTALLATION

■ Antenna Tuner (AT)

If using an external AT-300 antenna tuner, connect it here using the cable supplied with the antenna tuner. The AT-300 must be connected to **ANT 1**; it will not function if connected to **ANT 2**.

2

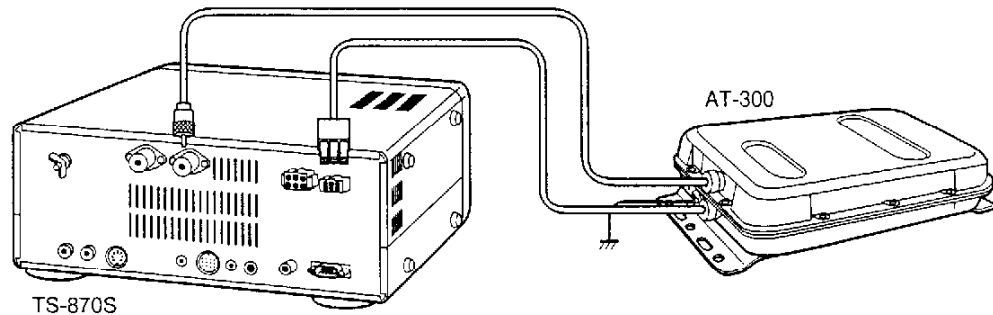

■ SM-230 Station Monitor (IF OUT 1)

Connect a cable from the **IF OUT 1** jack to the IF IN jack on the SM-230 Station Monitor. This cable couples the 8.83 MHz IF from your TS-870S for pan display on the Station Monitor.

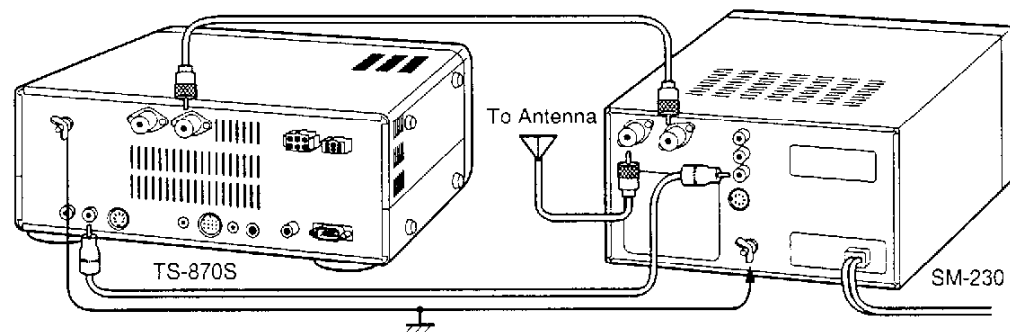

■ Accessory Equipment (ACC 2)

If you intend to use this transceiver for any of the digital modes, connect the input/output connections from a Terminal Node Controller (TNC) for Packet operation, a Multimode Communications Processor (MCP) for operation on Packet, PacTOR, AMTOR, G-TOR, or FAX, or a Clover interface to this connector.

SSTV and phone patch equipment can also be connected to **ACC 2**. SSTV operation is possible by connecting the input/output from a computer sound card to **ACC 2**, then running an SSTV application on the computer.

To operate on the digital modes, you will need the following equipment:

- Personal computer with communications software (alternatively, a "dumb" terminal capable of sending ASCII commands)
- TNC (Terminal Node Controller) or MCP (Multimode Communications Processor)
- TNC or MCP power supply
- RS-232C cable
- 13-pin DIN plug and cable

Connect your TNC or MCP to the **ACC 2** connector on the transceiver Rear Panel using a cable equipped with a 13-pin DIN plug.

Do not share a single power supply between the transceiver and the TNC or MCP. Keep as wide a separation between the transceiver and computer as practical to reduce noise-pickup by the transceiver. Refer to the accompanying table for connection information.

Pin No.	Pin Name	Function
1	NC	Not connected
2	NC	Not connected
3	ANO	Audio output from receiver <ul style="list-style-type: none"> • Connect to TNC or MCP receive data pin for digital operation. • Audio level is independent of AF gain control setting. • Audio level can be changed via Menu No. 21 (PKT.OUT) {page 25}. • Output impedance: 4.7 kΩ
4	GND	Shield for Pin 3
5	PSQ	Squelch control <ul style="list-style-type: none"> • Connect to TNC or MCP squelch control pin for digital operation. • Prevents the TNC from transmitting while the receiver squelch is open. • Squelch open: Low impedance • Squelch closed: High impedance
6	SMET	S-meter output
7	NC	Not connected
8	GND	Chassis ground
9	PKS	Transceiver PTT line control <ul style="list-style-type: none"> • Connect to TNC or MCP transmit/receive switching pin for digital operation. • Microphone audio input is muted when the transceiver is switched to transmit.
10	NC	Not connected
11	PKD	Microphone audio input <ul style="list-style-type: none"> • Connect to TNC or MCP transmit data pin for digital operation.
12	GND	Shield for Pin 11
13	SS	PTT control (in parallel with MIC jack) for connecting a footswitch or other external controller

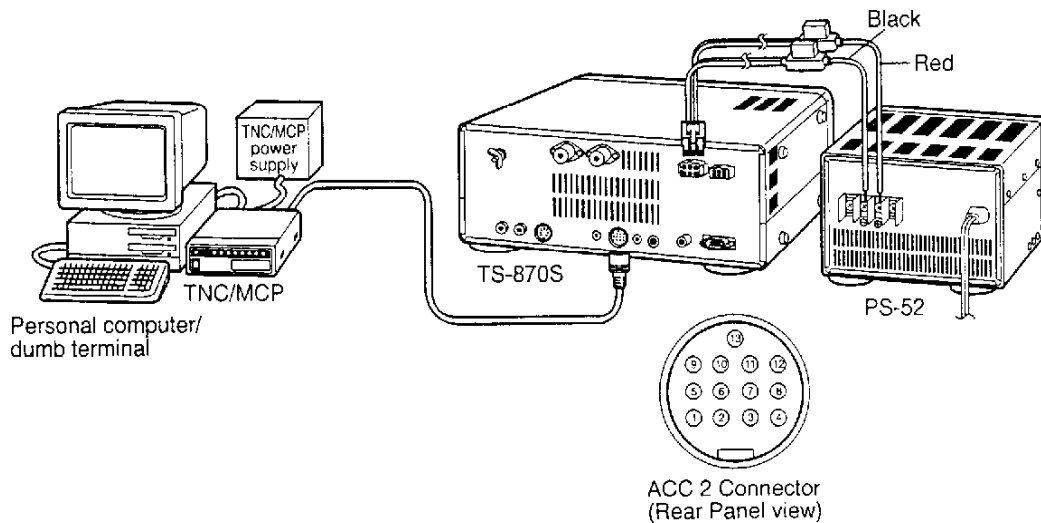

3 GETTING ACQUAINTED

YOUR FIRST QSO

Since you've now installed the TS-870S, why not try it? The instructions below are abbreviated. They are intended only to act as a quick introduction. If you encounter problems or there's something you don't understand, you can read about the subject in more detail later.

RECEIVING

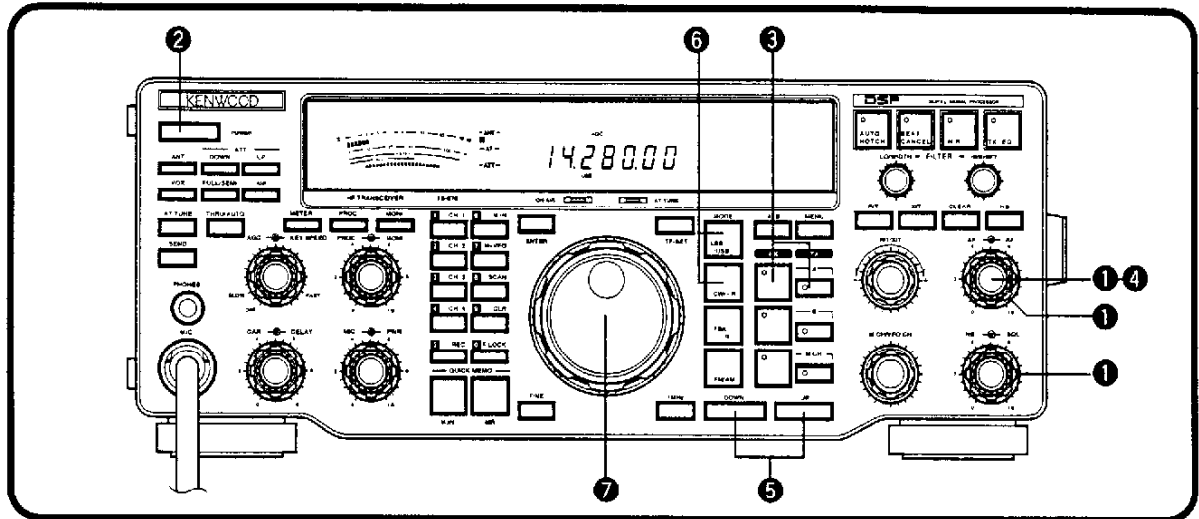

Note: Only those buttons and controls required to briefly try the transceiver are explained in this section.

1 Set the following as specified:

- **AF gain control:** Fully counterclockwise
- **RF gain control:** Fully clockwise
- **SQL control:** Fully counterclockwise

2 Switch ON the DC power supply, then press and hold the **[POWER]** switch briefly.

- The transceiver switches ON. Indicators and frequency digits should light on the Display.

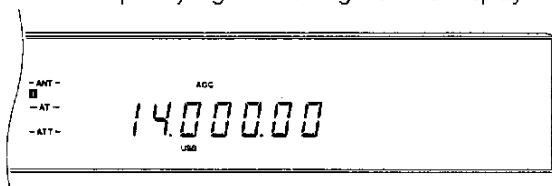

3 VFO A should already be selected for receive and transmit as shown by the lit indicators in the **[RX A]** button and the **[TX A]** button. If not, press the **[RX A]** button.

4 Increase the **AF gain control** slowly clockwise until you hear a suitable level of background noise.

5 Select an Amateur band by pressing the **[UP]** or **[DOWN]** button.

- First pressing the **[1MHz]** button before pressing the **[UP]** or **[DOWN]** button lets you step up or down in 1 MHz increments instead of stepping between Amateur bands.

6 Select an operating mode by pressing the **[LSB/USB]** or **[CW/-R]** button.

- Press the same button again to toggle to the second function on the button. For example, repeatedly pressing the **[LSB/USB]** button switches between LSB and USB modes.

7 Turn the **Tuning** control to tune in a station. If no stations are heard but you have an antenna connected, possibly the wrong antenna connector is selected. Pressing the **[ANT]** button toggles between the Antenna 1 and the Antenna 2 connectors.

TRANSMITTING

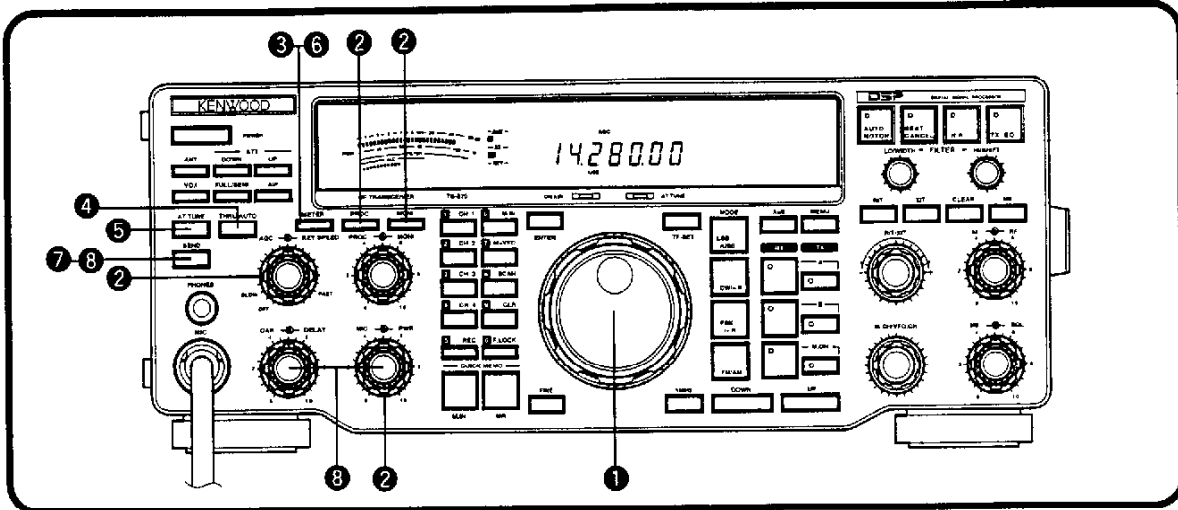

After tuning in a few stations as explained in the previous section "RECEIVING", try making a contact.

- 1 Assuming you are already on the correct band with the correct mode selected (Steps 1~7 above), use the **Tuning** control to tune in a station or to select an unused frequency.
- 2 Set the following as specified:
 - **[PROC]** button: OFF
 - **[MONI]** button: OFF
 - **PWR** control: Fully clockwise
 - **KEY SPEED** control: Comfortable keyer speed
- 3 Press the **[METER]** button to select the "SWR" meter.
- 4 Press the **[THRU/AUTO]** button.
 - "TX" lights.

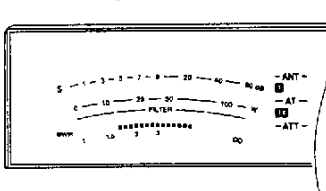

- 5 Press the **[AT TUNE]** button to allow the built-in antenna tuner to function.
 - "ON AIR" and "AT TUNE" light.



- The tuner should stop in less than approximately 20 seconds, and "ON AIR" and "AT TUNE" should go out.
 - If the tuner continues to search for a match and cannot match the transceiver with your antenna system correctly, stop and check your antenna system before continuing.
- 6 Press the **[METER]** button to select the "ALC" meter.
 - 7 Press the **[SEND]** button.
 - "ON AIR" lights.

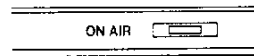

- 8 Begin speaking into the microphone or sending CW with your key. Adjust the **MIC** gain control for SSB or the **CAR** control for CW to keep the ALC meter moving in the ALC zone (but no higher) while transmitting. Press the **[SEND]** button again when you want to return to the receive mode.

This completes your introduction to the TS-870S, but there is a great deal more to know. Continue reading the remainder of this chapter to become totally acquainted with the TS-870S. The chapters following "GETTING ACQUAINTED" explain all functions of the transceiver beginning with the most basic, commonly-used functions.

3 GETTING ACQUAINTED

FRONT PANEL

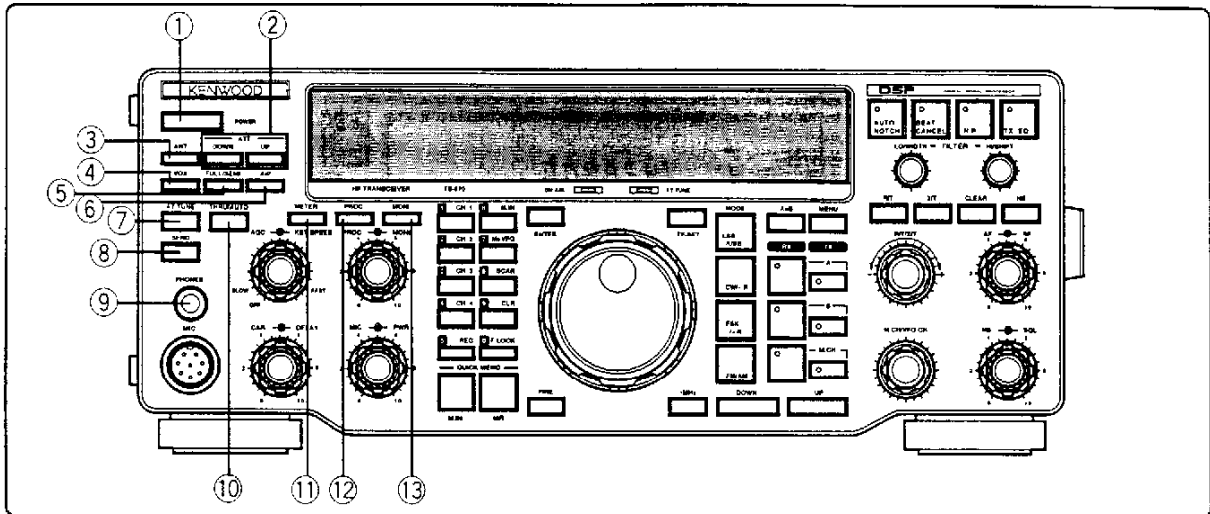

① POWER switch

Press and hold down briefly to switch the transceiver power ON. Press again to switch OFF the power {page 19}.

② ATT DOWN/UP buttons

Press either button to step up or down through the available receive signal attenuator selections. The attenuator is OFF when all three selections of 6, 12, and 18 dB are not lit {page 53}.

③ ANT button

Press to select Antenna 1 or Antenna 2 that are connected to their respective antenna connectors on the Rear Panel {pages 2, 63}.

④ VOX button

In the voice modes, press to switch the Voice-Operated Transmit function ON or OFF {page 45}. In CW mode, switches the Break-in function ON or OFF {page 31}.

⑤ FULL/SEMI button

In CW mode, press to select Full or Semi Break-in operation which affects the transmit/receive recovery time after sending stops {page 31}.

⑥ AIP button

Press to switch the Advanced Intercept Point function ON or OFF. When activated, the AIP function reduces interference caused by the presence of very strong signals. The function lowers the receive sensitivity by about 10 dB, and the default is ON when frequencies below 7490 kHz are selected {page 53}.

⑦ AT TUNE button

After enabling the internal antenna tuner via the **THRU/AUTO** button, press to activate the tuner. The tuner will attempt to match the transceiver with the antenna system {page 49}.

⑧ SEND button

Press to switch the transceiver between receive and transmit {page 23}.

⑨ PHONES jack

Connect headphones to this jack. Inserting a plug into this jack automatically mutes the audio from the speaker {page 4}.

⑩ THRU/AUTO button

Press to enable the internal antenna tuner. This button does not start the tuning action (see ⑦). The tuner can be configured so that it is only in-line while transmitting, or it can be in-line while both transmitting and receiving {page 49}.

⑪ METER button

Press to switch between the available functions on the Front Panel meter {page 22}.

⑫ PROC button

In SSB or AM mode, press to switch the Speech Processor ON or OFF {pages 23, 46}.

⑬ MONI button

Press to switch the Transmit Monitor function ON or OFF so you can monitor your transmitted signal {page 46}.

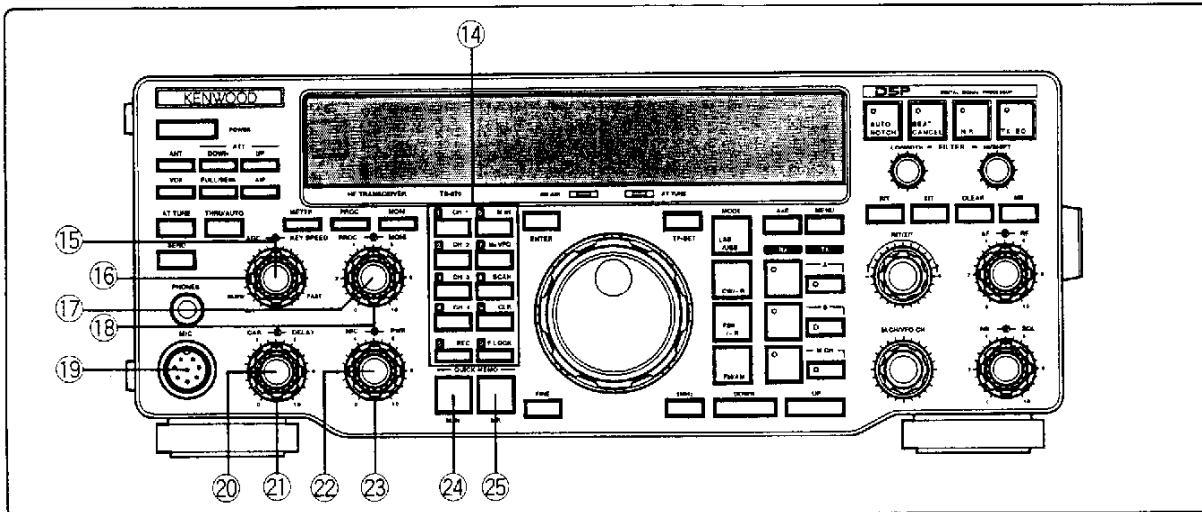

14 Multi-purpose keypad

Consists of 10 buttons that are used for inputting numeric data. Also used for other functions:

- **[M.IN]:** Writes data into memory channels {page 54}, selects Memory Scroll mode {page 56}, and adds items to the Quick Menu {page 24}.
- **[M>VFO]:** Transfers data from a memory channel to a VFO {page 56}.
- **[SCAN]:** Starts and stops Scan functions {page 60}.
- **[CH 1], [CH 2], [CH 3], [CH 4]:** Selects functions associated with the internal electronic keyer {page 32} and the DRU-3 Digital Recording Unit {page 67}.
- **[REC]:** Selects the record mode for the DRU-3 Digital Recording Unit {page 67}.
- **[F.LOCK]:** Controls the Frequency Lock function {page 64}.
- **[CLR]:** Used to exit from, abort, or reset various functions. Also used for erasing memory channels {page 57} or locking out {page 62} memory channels from the scan list.

15 AGC control

Turn to adjust the AGC time constant after selecting the manual AGC mode {page 44}.

16 KEY SPEED control

In CW mode, turn clockwise to increase the internal electronic keyer speed and counterclockwise to decrease the speed {page 32}.

17 PROC control

When using the Speech Processor in SSB or AM mode, adjusts the compression level. Turning the control clockwise increases compression {pages 23, 46}.

18 MONI control

When using the Transmit Monitor function, adjusts the volume level of the monitored transmit audio. Also adjusts the volume of the CW sidetone. Turning the control clockwise increases the volume {pages 30, 46}.

19 MIC connector

Connect a compatible microphone, then snugly screw down the connector locking ring {page 4}.

20 CAR control

In CW, FSK, or AM mode, adjusts the carrier level {pages 23, 30, 40, 41}. When using the Speech Processor in SSB mode, adjusts the processor output {page 46}. Turning the control clockwise increases the carrier level or the processor output.

21 DELAY control

When using the VOX function or the CW Break-in function, adjusts the time period that the transceiver waits before changing from the transmit mode back to the receive mode. Turning the control clockwise increases the delay {pages 31, 45}.

22 MIC gain control

In SSB or AM mode, adjusts the level of microphone gain. Turning the control clockwise increases the gain {pages 23, 29, 40}.

23 PWR control

Adjusts the transmit output power in all modes. Turning the control clockwise increases the output power {page 23}.

24 QUICK MEMO M.IN button

Press to write data into Quick memory {page 59}.

25 QUICK MEMO MR button

Press to recall data from Quick memory {page 59}.

3 GETTING ACQUAINTED

3

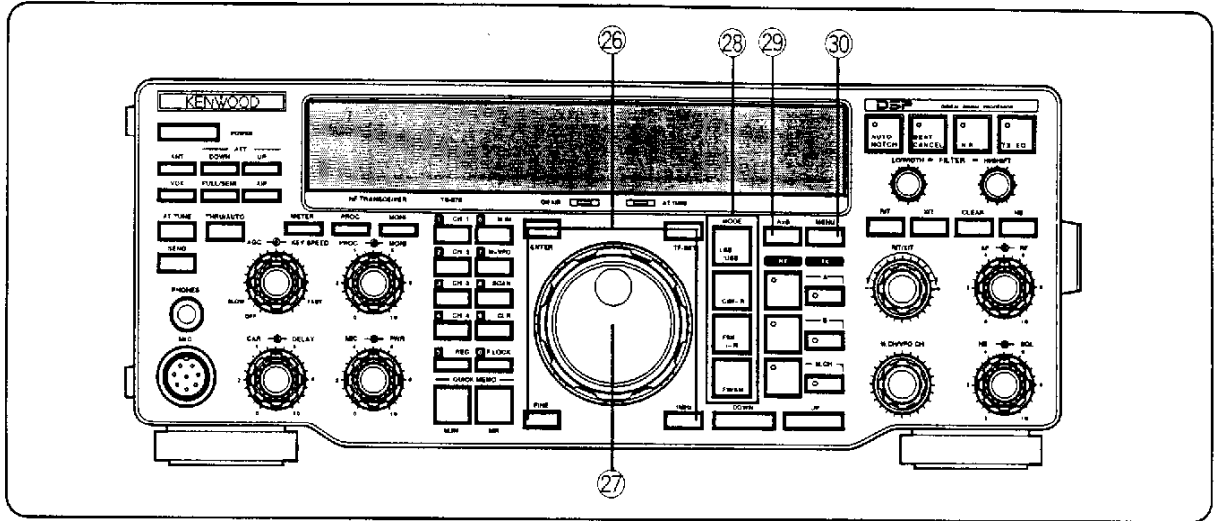

26 Programmable Function buttons

The functions of these four buttons are selected and assigned by you so you can customize the transceiver as you like {page 63}. The factory default assignments are as follows:

ENTER button

Used when entering frequencies via the keypad {page 22}.

TF-SET (Transmit Frequency Set) button

While operating split frequency, press to monitor the transmit frequency. Also, while holding this button down in split-frequency mode, the transmit frequency can be changed without altering the receive frequency {page 43}.

FINE button

Press to reduce the Tuning control step size by one-tenth to allow more precise tuning {page 21}.

1MHz button

Press to switch between the 1MHz mode and the Amateur band mode {page 20}. This button also activates the Programmed channel and Vacant channel search modes {page 55}.

27 Tuning control

Turn to select the desired frequency. Use the convenient finger-tip cavity for continuous tuning {page 21}.

28 Mode buttons

Press these buttons to select your operating mode {page 20}.

LSB/USB button

Selects Lower Sideband or Upper Sideband mode for voice {page 29} or digital operation {page 41}.

CW/-R button

Selects CW {page 30} or CW Reverse mode {page 31}.

FSK/-R button

Selects Frequency Shift Keying {page 40} or Frequency Shift Keying Reverse mode for RTTY operation {page 41}.

FM/AM button

Selects FM {page 38} or AM mode {page 40}.

29 A=B button

Press to equalize the data in both VFOs. The data in the currently selected VFO is copied to the other VFO; the current VFO's data is unaffected {page 20}. This button is also used for the Full Reset function {pages 57, 63}.

30 MENU button

Press to select or cancel the Menu mode that is used for activating and configuring functions {page 24}. This button is also used for changing the Automatic mode boundaries {page 48}.

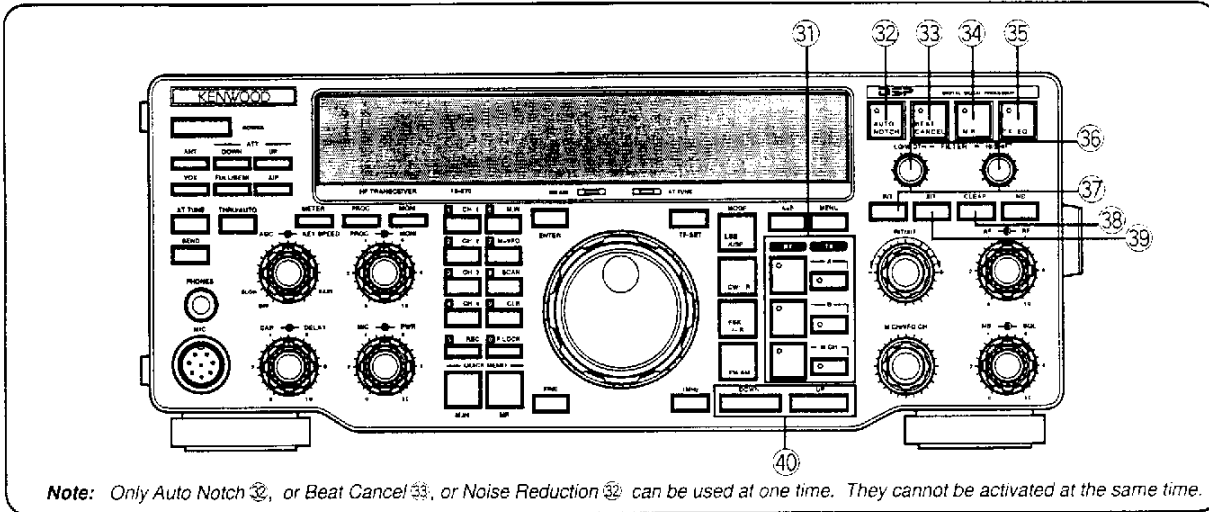

Note: Only Auto Notch 32, or Beat Cancel 33, or Noise Reduction 34 can be used at one time. They cannot be activated at the same time.

31 VFO/ Memory channel buttons

Press to select VFO A, VFO B, or a memory channel for receive or transmit. If a receive button is pressed, the same VFO or memory channel is selected for transmit and receive. However, pressing a transmit button selects only that VFO or memory channel for transmit {page 42}.

RX A button

Selects VFO A for receive and transmit {page 19}.

TX A button

Selects VFO A for transmit {page 42}.

RX B button

Selects VFO B for receive and transmit {page 19}.

TX B button

Selects VFO B for transmit {page 42}.

RX M.CH button

Selects memory channel mode for receive and transmit {page 55}.

TX M.CH button

Selects memory channel mode for transmit {page 42}.

32 AUTO NOTCH button

In SSB mode, press to switch the Auto Notch function ON or OFF. Auto Notch can automatically locate and remove interfering signals from the receive IF pass band {page 52}.

33 BEAT CANCEL button

In SSB or AM mode, press to switch the Beat Cancel function ON or OFF. Beat Cancel works at AF to remove interfering signals {page 52}.

34 N.R. button

In SSB, CW, FSK, or AM mode, press to switch the Noise Reduction function ON or OFF. This function offers a choice of digital filtering methods for reception {page 53}.

35 TX EQ. button

In SSB or AM mode, press to switch the Transmit Equalizer function ON or OFF. This equalizer function includes high boost, low boost, and comb filter functions {page 47}.

36 FILTER LO/WIDTH and HI/SHIFT controls

These controls allow total flexibility in all modes for digitally changing the receive pass band characteristics for optimum reception {pages 51, 52}.

37 RIT button

Press to switch the Receive Incremental Tuning function ON or OFF. The RIT function allows you to change your receive frequency without affecting your transmit frequency {page 44}.

38 CLEAR button

Press to reset the RIT/XIT frequency offset to zero {pages 44, 45}. Also erases entered digits at any time the keypad is being used to enter data {page 22, 48}.

39 XIT button

Press to switch the Transmit Incremental Tuning function ON or OFF. The XIT function allows you to change your transmit frequency without affecting your receive frequency {page 45}.

40 UP/DOWN buttons

Press to step through all Amateur bands consecutively {page 20}. If the 1MHz Step function is ON, then pressing these buttons steps the transceiver in 1 MHz increments {page 20}. These buttons are also used to make selections from the Menu {page 24}, and to check Start and End frequencies for the Scan function {page 60}.

3 GETTING ACQUAINTED

3

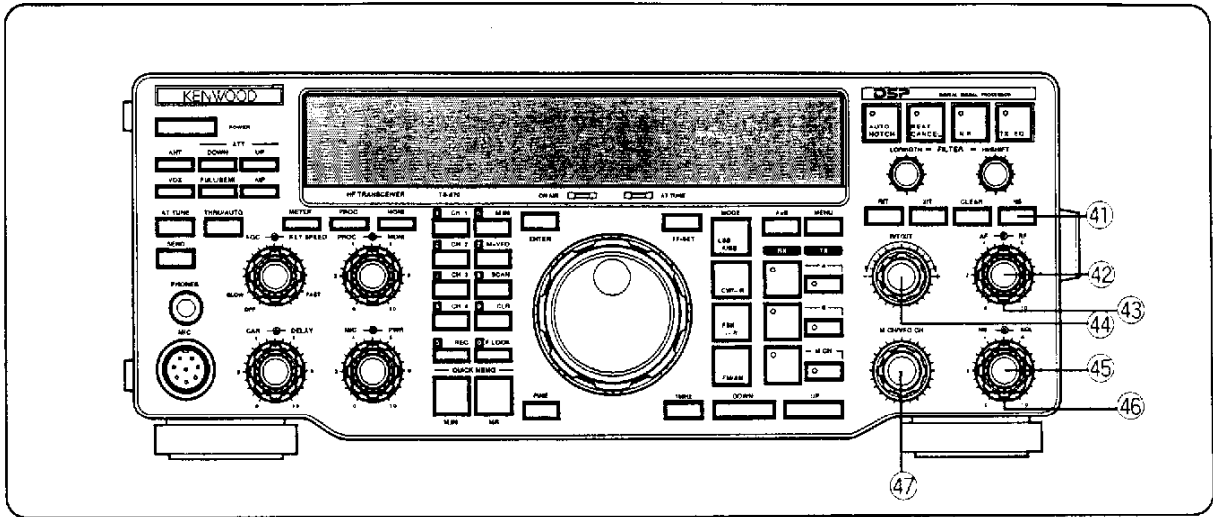

④① **NB** button

Press to switch the analog Noise Blanker function ON or OFF. This function works best against short duration pulse noise {page 53}.

④② **AF** gain control

Adjusts the audio frequency gain. Turn the control clockwise to increase the gain; counterclockwise to decrease the gain {page 19}.

④③ **RF** gain control

Adjusts the radio frequency gain. Turn the control clockwise to increase the gain; counterclockwise to decrease the gain {page 19}.

④④ **RIT/XIT** control

After switching ON the RIT or XIT function, turn to select the desired frequency offset with respect to the current frequency {pages 44, 45}.

④⑤ **NB** control

When using the Noise Blanker function, turn to adjust the noise blanking level {page 53}. To prevent distorting your receive signal, use the minimum blanking level necessary.

④⑥ **SQL** control

The Squelch control can be used for muting the receiver during no signal periods. The more clockwise that the control is turned, the higher the noise threshold level. Therefore, the stronger the received signal must be to open the squelch. Leave fully counterclockwise for weak signal reception {page 19}.

④⑦ **M.CH/VFO.CH** control

In VFO mode, turn to step the frequency up or down {page 21}. In memory channel mode, turn to select the desired memory channel {page 55}. The control is also used for selecting boundaries for the Automatic Mode function {page 48} and for selecting Menu numbers when accessing the Menu {page 24}.

MICROPHONE

① **UP/DWN** buttons

Use these buttons to step the VFO frequency or memory channels up or down. The selected frequency or channel will change continuously in the direction of the button label if a button is pressed and held down.

② **PTT** (Push-to-Talk) switch

The transceiver is placed in transmit mode when this non-locking switch is held down. Releasing the switch returns the transceiver to receive mode.

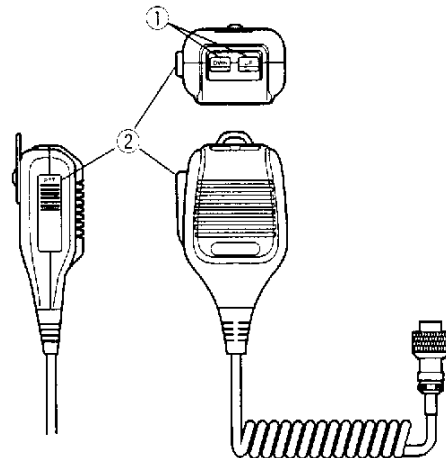

REAR PANEL

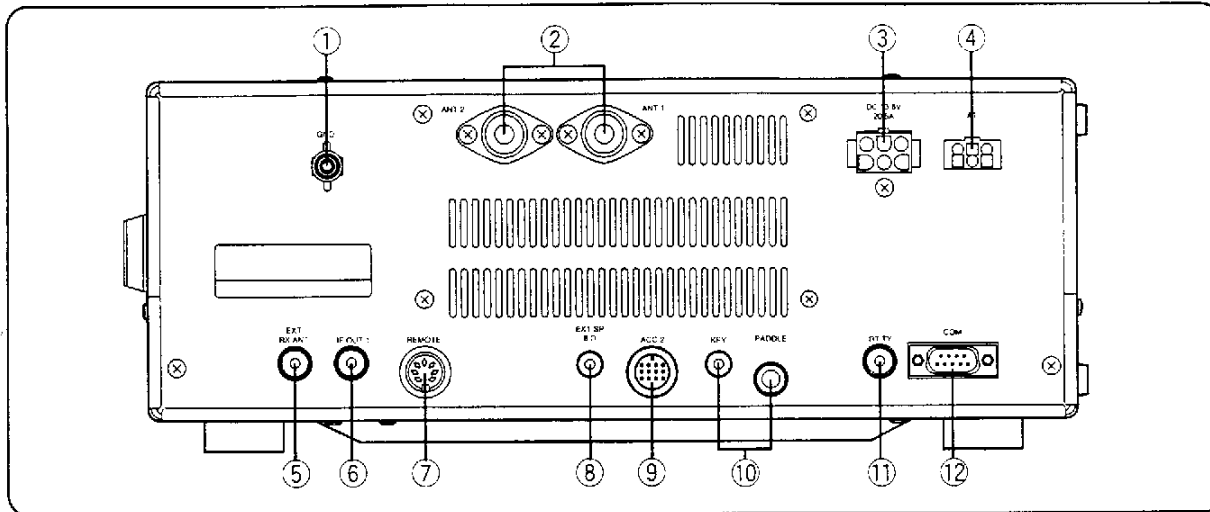

3

① GND post with wing nut

Connect a heavy gauge wire or copper strap between the ground post and the nearest earth ground {page 3}. Do not connect the ground wire to either your house electrical wiring, or gas or water pipes. A well-grounded transceiver will reduce the risk of interference to television, broadcast radio receivers, and other electronic devices. A good ground can also reduce receiver noise caused by static discharges.

② ANT 1 and ANT 2 connectors

Connect the feed lines from your antennas to these connectors. Refer to pages 2 and 63 for details.

③ Power Input DC 13.8 V connector

Connect a 13.8 V DC power source {page 3}. Use the supplied cable with a regulated DC power supply. The TS-870S draws less than 20.5 A at maximum transmit output.

④ AT connector

Mates with the connector on the cable supplied with the AT-300 antenna tuner. Refer to the instruction manual supplied with this tuner for more information.

⑤ EXT RX ANT jack

Mates with an RCA pin plug for connecting a separate receiver. Menu No. 53 enables this jack. Never transmit into this jack. Signals received by the TS-870S are distributed via a power divider to the TS-870S receive stage and the external receiver. Therefore, connecting an external receiver reduces the signal level.

⑥ IF OUT 1 jack

Mates with an RCA pin plug for connecting the 8.83 MHz IF for pan display of an SM-230 Station Monitor {page 6}.

⑦ REMOTE connector

Mates with a 7-pin male DIN connector for connecting a linear amplifier {page 5}.

⑧ EXT SP jack

Mates with a 3.5 mm (1/8") diameter, 2-conductor (mono) plug for connecting an external speaker {page 4}. Connecting an external speaker cuts off the audio automatically to the internal speaker.

⑨ ACC 2 connector

Mates with a 13-pin male DIN connector for connecting various accessory equipment {page 6}.

⑩ PADDLE and KEY jacks

Mates with a 6.0 mm (1/4") 3-conductor plug and a 3.5 mm (1/8") 2-conductor plug for connecting a key paddle for the internal electronic keyer and another key for CW operation respectively. Read "Keys and Keyboards for CW Operation" {page 4} before connecting to these jacks.

⑪ RTTY jack

Mates with an RCA pin plug for connecting the RTTY key output from RTTY equipment to operate true frequency shift keying (direct keying) {page 5}.

⑫ COM connector

Mates with a 9-pin female RS-232C connector for connecting a computer via one of its serial communication ports {page 83}. Functions on the transceiver can be controlled remotely by using a communications program on the computer {pages 5, 83}. Also used with the Quick Data Transfer function {page 65}.

3 GETTING ACQUAINTED

DISPLAY

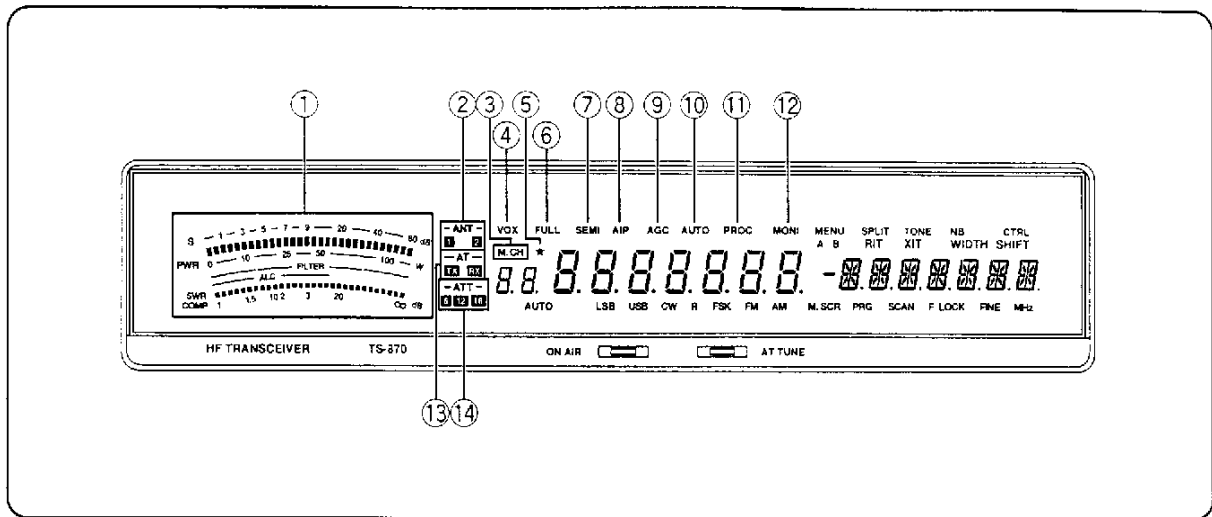

3

① METER

While receiving, serves as an S-meter to measure and display the received signal strength. Also while receiving, a 30-segment display represents the width and relative shift of the currently selected receive pass band. While transmitting, serves as a calibrated power meter plus an ALC meter, an SWR meter, or a Speech Processor compression meter. A Peak Hold function can be activated that holds each reading for about 2.5 seconds {page 22}.

② -ANT- 1 2

Either **1** or **2** lights while Antenna 1 or Antenna 2 is selected respectively. Only one antenna can be selected at a time {pages 2, 63}.

③ M.CH

Lights while the memory channel mode is selected. Also lights while using the Memory Scroll function {page 56}.

④ VOX

Lights while the Voice-Operated Transmit function {page 45} is ON. For CW operation, lights while the Break-in function {page 31} is ON.

⑤ ★

Lights when a Menu item is added to the Quick Menu {page 24}.

⑥ FULL

Lights while CW Full Break-in is selected {page 31}.

⑦ SEMI

Lights while CW Semi Break-in is selected {page 31}.

⑧ AIP

Lights while the Advanced Intercept Point function is ON {page 53}.

⑨ AGC

Lights while the Automatic Gain Control function is ON {page 44}.

⑩ AUTO

Lights while Automatic is selected for the Automatic Gain Control function - {page 44}.

⑪ PROC

Lights while the Speech Processor is ON {pages 23, 46}.

⑫ MONI

Lights while the Transmit Monitor function is ON {page 46}.

-AT- ⑬ TX RX

TX lights while the internal antenna tuner is configured for use while transmitting only. **TX RX** light while the tuner is configured for use while transmitting and receiving. If neither are lit, the antenna tuner is switched OFF {page 49}. If using Full Break-in CW, the internal tuner can be either bypassed completely or can be in-line for both transmitting and receiving.

-ATT- ⑭ 6 12 18

6, **12**, or **18** lights while the attenuator is switched ON. The numbers indicate the amount in dB of receive attenuation that is selected. If no numbers are lit, the attenuator is switched OFF {page 53}.

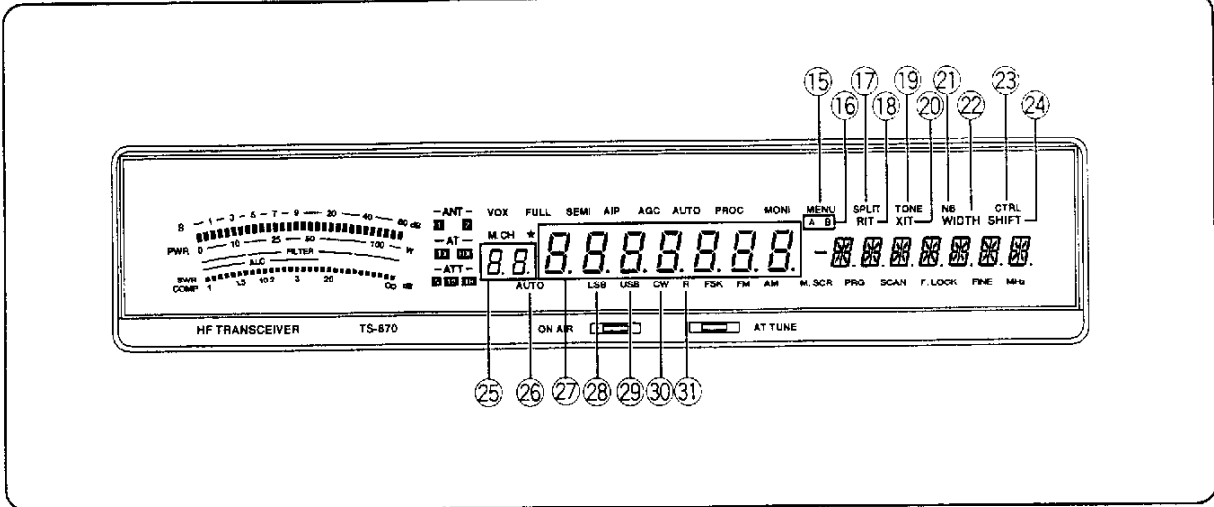

15 MENU

Lights while Menu mode is being accessed. Flashes when the Menu has been temporarily reset {page 24}.

16 A/B

"A" lights while Menu A is being accessed. "B" lights while Menu B is being accessed {page 24}.

17 SPLIT

Lights while a different transmit and receive frequency are selected for split frequency {page 42}.

18 RIT

Lights while the Receive Incremental Tuning function is ON {page 44}.

19 TONE

In FM mode, lights while the subaudible Tone function is ON while operating split frequency {page 39}.

20 XIT

Lights while the Transmit Incremental Tuning function is ON {page 45}.

21 NB

Lights while the Noise Blanker is ON {page 53}.

22 WIDTH

In all modes except SSB and AM, lights after the **LO/WIDTH** control is adjusted. Indicates that the number reported below it on the Display is the receive bandwidth {page 52}.

23 CTRL

Lights while data is being exchanged between a computer and the transceiver during computer control {page 50} or between two transceivers during Quick Data Transfer {page 65}.

24 SHIFT

In CW, lights after the **H/SHIFT** control is adjusted. Indicates that the number reported below it on the Display is the shift of the receive pass band {page 51}.

25 8.8

Shows the selected memory channel {page 55}, Menu No. {page 24}, and Automatic Mode boundary numbers {page 48}. The dot lights while a memory channel is locked out. This indicates that the channel will be skipped during Memory Scan {page 62}.

26 AUTO

Lights while Automatic Mode is ON {page 48}. Automatic Mode automatically controls the operating mode according to instructions that you provide.

27 8.8.8.8.8.8.8.8

Shows the operating frequency to a resolution of 10 Hz {page 20}. Also shows the Menu selections while in Menu mode {page 24}.

28 LSB

Lights while in the Lower Sideband operating mode {page 20}.

29 USB

Lights while in the Upper Sideband operating mode {page 20}.

30 CW

Lights while in the CW operating mode {page 20}.

31 R

Lights while the Reverse function is used with FSK or CW. The Reverse function reverses the mark and space frequency relationship for FSK {page 20}, and uses the opposite sideband for CW {page 20}.

3 GETTING ACQUAINTED

3

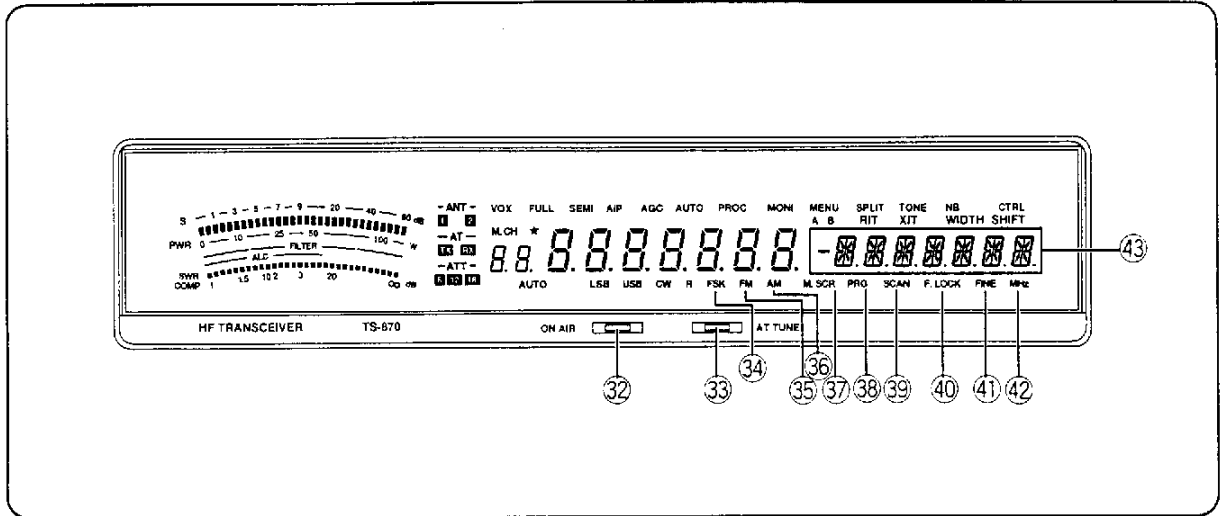

32 ON AIR

Lights while the transceiver is in the transmit mode {page 23}.

33 AT TUNE

Lights while the internal antenna tuner is actually tuning for a correct match between the antenna system and the transceiver. Also lights while the transceiver is presetting the antenna tuner capacitors according to previously stored data {page 49}.

34 FSK

Lights while in Frequency Shift Keying (RTTY) mode {page 20}.

35 FM

Lights while in the FM operating mode {page 20}.

36 AM

Lights while in the AM operating mode {page 20}.

37 M.SCR

Lights while in Memory Scroll mode {page 56}.

38 PRG

Lights while Program Scan is activated {page 60} or memory channel 99 is selected {page 58}.

39 SCAN

Lights while a Scan function is activated {page 60}.

40 F.LOCK

Lights while the Lock function is ON {page 64}.

41 FINE

Lights while the Fine function is ON {page 21}.

42 MHZ

Lights while the 1MHz Step {page 20} or Quick Menu {page 24} function is ON. Also lights while the Search function for programmed or vacant memory channels is ON {page 55}.

43 - 88888888

Shows the Menu Items while accessing Menu mode {page 24}. Also shows frequency information (transmit, receive, or difference) while operating split frequency {page 42} and the RIT/XIT frequency offset if these functions are activated {pages 44, 45}.

OPERATING BASICS

SWITCHING POWER ON/OFF

Switch ON the DC power supply, then press and hold down **[POWER]** until "HELLO" appears on the Display. Release **[POWER]** when you see "HELLO".

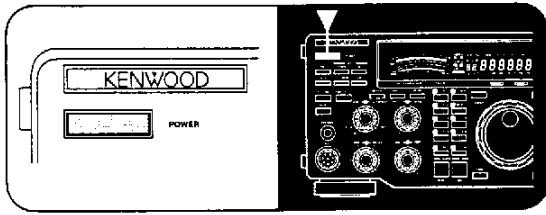

- After the "HELLO" message, the frequency and other indicators light. Pressing **[POWER]** too long, switches the power OFF. If the TS-870S has not been used for an extended period, "HELLO" may not appear immediately.

To switch OFF the transceiver, press **[POWER]**.

- After the transceiver has been switched ON, it can then be switched OFF or ON by using only the power switch on the DC power supply.

ADJUSTING VOLUME

AUDIO FREQUENCY (AF) GAIN

Turn the **AF** gain control clockwise to increase the audio level and counterclockwise to decrease the level.

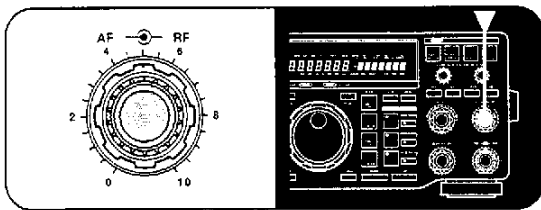

Note: The position of the **AF** gain control does not affect the volume of "beeps" caused by pressing buttons nor the CW transmit sidetone. Also, the audio level for Packet operation is independent of the **AF** gain control setting.

RADIO FREQUENCY (RF) GAIN

Usually, set the **RF** gain control maximum clockwise. If you are having trouble hearing the desired signal due to excessive atmospheric noise or interference from other stations, it may help to reduce the **RF** gain.

To do this, take note of the peak S-meter reading of the desired signal, then turn the **RF** gain control counterclockwise to match this peak reading with the illuminated S-meter segments. Signals that are weaker than the level set with the **RF** gain control will be attenuated. Reception of the station is easier.

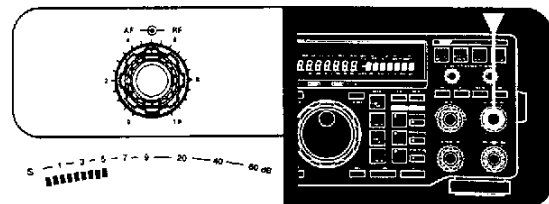

Furthermore, using a faster AGC setting {page 44} will help eliminate the blocking affect of the large AGC voltage that is developed due to a strong adjacent station.

Depending on the type and gain of your antenna, and the condition of the band, you may prefer leaving the **RF** gain control turned counterclockwise by some amount instead of turning it fully clockwise.

ADJUSTING SQUELCH

The purpose of squelch is to silence audio output from the speaker when no signals are present. Setting the squelch threshold too high causes the squelch to remain closed while a weak signal is present. Setting the threshold too low allows noise to be heard between transmissions from other stations. Many operators prefer leaving the squelch control fully counterclockwise unless operating full-carrier modes such as FM or AM.

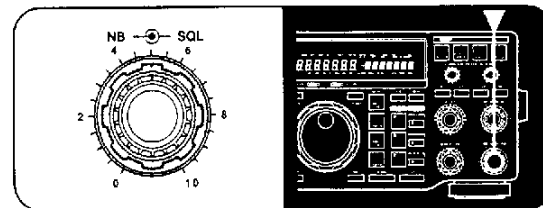

Turn the **SQL** control to just eliminate the background noise when no signal is present, or set and forget at full counterclockwise rotation.

DUAL DIGITAL VFOs

The A and B VFOs function independently so that different or the same frequencies can be selected by each VFO. The following sections explain how to select a VFO and how to copy frequency data from one VFO to the other.

SELECTING VFOs ([RX A], [RX B])

Press **[RX A]** to select VFO A. Press **[RX B]** to select VFO B.

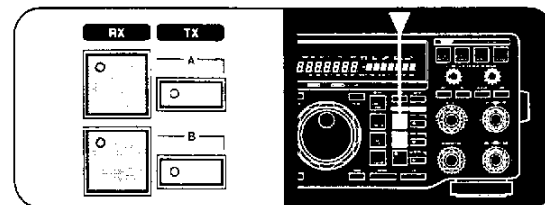

- 1 Assume that you are presently using VFO A.
- 2 Press **[RX B]**.
 - VFO B is selected and the frequency currently selected by VFO B is displayed.
- 3 Press **[RX A]** to select VFO A again.

4 OPERATING BASICS

EQUALIZING VFO FREQUENCIES ([A=B])

Press **[A=B]** to transfer the frequency and modulation mode of the active VFO to the inactive VFO.

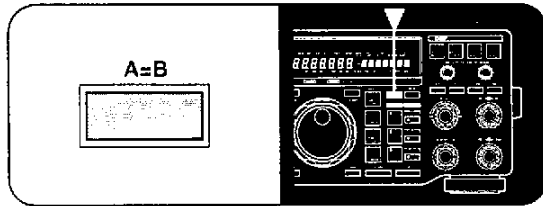

4

- 1 Assume that you are presently using VFO A.
- 2 Press **[RX B]**.
 - VFO B is selected and the frequency currently selected by VFO B is displayed.
- 3 Press **[A=B]**.
- 4 Press **[RX A]**.
 - This selects VFO A again. Note that the VFO B frequency and the modulation mode have been copied to VFO A due to Step 3.

SELECTING MODE

To change the operating mode, simply press the MODE button for the mode that you want to use. The second function on each MODE button is accessed by pressing the same button again.

Example: To switch to LSB, press **[LSB/USB]** one time. To then switch to USB, press **[LSB/USB]** again.

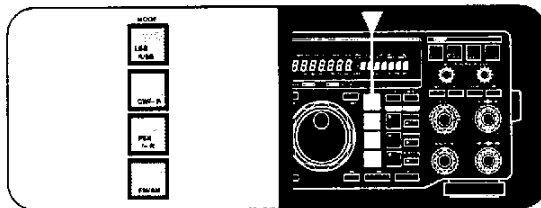

The CW mode defaults to the upper sideband. The “-R” label on **[CW/-R]** indicates that CW may be sent and received using the lower (reverse) sideband if you want. The “-R” label on **[FSK/-R]** indicates that the mark and space signals for RTTY may be reversed by selecting this mode.

In SSB mode, the transceiver automatically selects LSB for frequencies lower than 9.5 MHz, and selects USB for 9.5 MHz or higher frequencies if the **Tuning** control or Mic **[UP]/[DWN]** is used to cross the frequency of 9.5 MHz. This is also true if using the Front Panel **[UP]** or **[DOWN]** button.

SELECTING FREQUENCY

There are two methods to select a frequency that are explained in the following sections:

A Manual Tuning

Change to the correct band or use the 1MHz Step function to get close to the desired frequency. Then use the **M.CH/VFO.CH** control for coarse tuning and the **Tuning** control (or the Mic **[UP]** and **[DWN]** buttons) for selecting the exact frequency.

B Direct Frequency Entry (Keypad)

Enter the desired frequency directly using the numeric keypad.

CHANGING BANDS

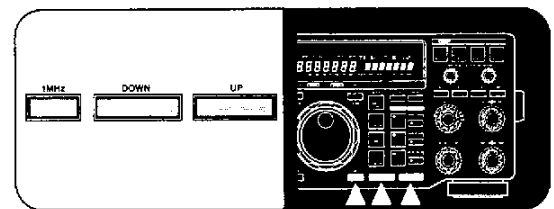

- 1 If “MHz” is illuminated on the Display, first press **[1MHz]** to exit from the 1MHz Step mode.
 - “MHz” goes out.
- 2 Press **[UP]** or **[DOWN]**.
 - Holding down either button consecutively steps the transceiver to each band.

USING 1 MHz STEPS

The default step size for the 1MHz Step function is 1 MHz; however, you can also select 500 or 100 kHz steps via Menu No. 52 (1M/500k). Menu selections are explained in more detail beginning on page 24.

- 1 Press **[1MHz]** to enter the 1MHz mode.
 - “MHz” lights.

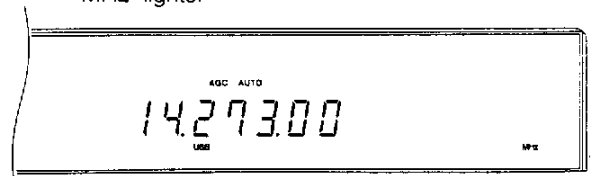

- 2 Press **[UP]** or **[DOWN]**.
 - The frequency changes up or down in 1 MHz steps (or 500 or 100 kHz steps) each time **[UP]** or **[DOWN]** is pressed. Holding down either button causes the function to repeat.

QUICK CHANGES

To move up or down in frequency quickly, use the **M.CH/VFO.CH** control.

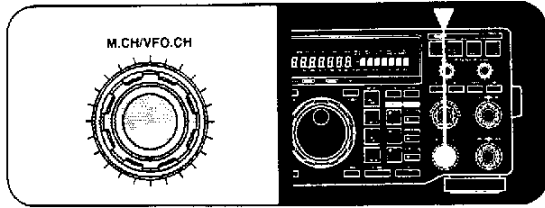

- Turn the **M.CH/VFO.CH** control clockwise to increase the frequency; counterclockwise to decrease the frequency.

Due to the large step sizes available, you can quickly move across the band. When the minimum or maximum receive frequency for the transceiver is reached, turning the **M.CH/VFO.CH** control will not decrease or increase respectively the frequency.

Menu No. 44 (STEP.ADJ) affects how the **M.CH/VFO.CH** control tunes. When Menu No. 44 is ON (default), rounding occurs on the first step ("click") of the **M.CH/VFO.CH** control as shown below:

Step Adjust (Menu No. 44)	Channel Step (Menu No. 43)	Rounding Effect
ON	10 kHz	1 kHz, 100 Hz, and 10 Hz digits change to 0.
ON	5 kHz	1 kHz digit changes to 0 or 5, and 100 Hz and 10 Hz digits change to 0.
ON	1 kHz	100 Hz and 10 Hz digits change to 0.

Example 1: Menu No. 44 (STEP.ADJ) is ON

- Menu No. 43 (CH. STEP): 10 kHz step size
- Selected frequency: 14.261.73 MHz

Turning the **M.CH/VFO.CH** control clockwise one step changes the frequency to 14.270.00 MHz, and one more step changes the frequency to 14.280.00 MHz. The rounding occurred on the first step.

Similarly, with 14.261.73 MHz selected, turning this control counterclockwise one step changes the frequency to 14.260.00 MHz, and one more step changes the frequency to 14.250.00 MHz. Again, the rounding took place on the first step.

Example 2: Menu No. 44 (STEP.ADJ) is OFF

- Menu No. 43 (CH. STEP): 10 kHz step size
- Selected frequency: 14.261.73 MHz

Turning the **M.CH/VFO.CH** control clockwise one step changes the frequency to 14.271.73 MHz, and one more step changes the frequency to 14.281.73 MHz. No rounding occurs.

With 14.261.73 MHz selected, turning this control counterclockwise one step changes the frequency to 14.251.73 MHz, and one more step changes the frequency to 14.241.73 MHz. Again, no rounding occurs.

Changing Step Sizes

Select the step size that you prefer for the **M.CH/VFO.CH** control via Menu No. 43 (CH. STEP). Available step sizes are 1 kHz, 5 kHz and 10 kHz. The default is 10 kHz.

Within the AM broadcast band, the step size automatically defaults to 9 kHz (U.S.A./ Canada versions: 10 kHz) for the AM mode. This step size can be switched between 9 (ON) and 10 kHz (OFF) via Menu No. 42 (BC. STEP). Selecting OFF in Menu No. 42 allows you to use the step size specified via Menu No. 43 (1, 5, or 10 kHz). While in the AM broadcast band, changing the step size via Menu No. 42 will change the selected frequency to the nearest broadcast channel on the next use of the **M.CH/VFO.CH** control.



If you enjoy listening to international shortwave broadcasters, the **M.CH/VFO.CH** control is also the best way to manually scan these bands. Select the 5 kHz step size via Menu No. 43 (CH. STEP) since most shortwave broadcasters are spaced 5 kHz apart. Set Menu No. 44 to ON. To listen to a broadcaster on a channel that is not a 5 kHz multiple, use the **Tuning** control to zero-in to the exact frequency.

FINE TUNING

For SSB, CW, and FSK modes, the **Tuning** control normally tunes through 10 kHz per revolution of the control. For FM and AM modes, one revolution of the **Tuning** control changes the frequency by 100 kHz. These tuning rates can be halved via Menu No. 41 (F.STEP).

In addition, the Fine Tuning function reduces the step size of the **Tuning** control further which allows you to tune more slowly and precisely.

Fine Tuning (Menu No. 41: 10 kHz)	SSB/ CW/ FSK Tuning Steps	AM/ FM Tuning Steps
OFF	10 Hz	100 Hz
ON	1 Hz	10 Hz

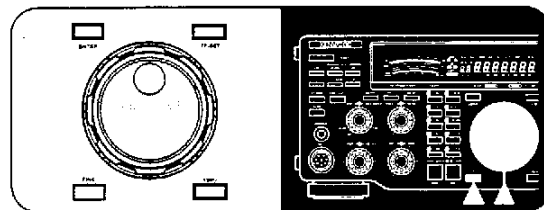

Press **[FINE]**.

- "FINE" lights.

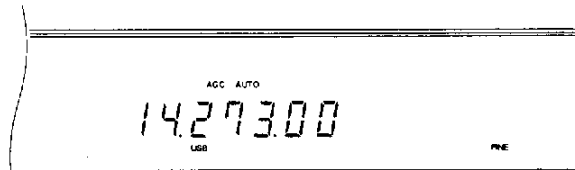

- The Fine Tuning function toggles ON and OFF each time **[FINE]** is pressed.

4 OPERATING BASICS

Note: After recalling memory channel 99 that has Start and End frequencies stored (page 58), the receive frequency can be changed (like a VFO) by using the **Tuning** control.

DIRECT FREQUENCY ENTRY

Entering a frequency directly from the numeric keypad can be the fastest method to change to a specific frequency that is far removed from your current frequency.

The following points will help you enter a frequency correctly:

4

- Only the digits 0, 1, 2, or 3 can be entered for the 10 MHz digit (first digit). Pressing any digit 4 ~ 9 will cause the digit to be entered in the 1 MHz position. Therefore, to select a frequency of 3 MHz or lower, enter 0 for the 10 MHz digit.
- When the 10 Hz digit (last digit) is entered, the digit 0 is entered automatically for the 1 Hz digit, and frequency entry is completed. The 1 Hz digit is not displayed.
- If [ENTER] is pressed after beginning to enter digits, 0 is entered automatically for the remaining un-entered digits, and frequency entry is completed.
- Attempting to enter a frequency that is outside the TS-870S frequency range causes an alarm to be generated. The entered frequency is rejected.
- If an incorrect digit is pressed, restore the previous frequency by pressing [CLEAR], or [SEND], or Mic [PTT].
- When an entered frequency is accepted, RIT {page 44} and XIT {page 45} are switched OFF, but the RIT or XIT frequency is not changed.

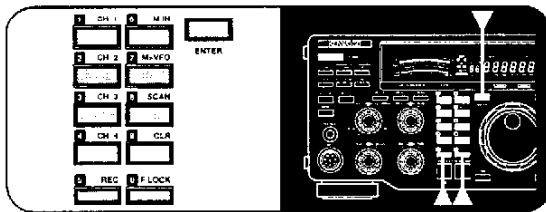

1 Press [ENTER].

- “- - - - -” appears.

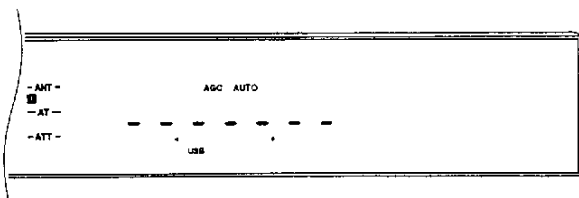

2 Press the numeric buttons [0] ~ [9] to enter the frequency you desire.

- The transceiver changes to the entered frequency after the 10 Hz digit is pressed.

Note: After recalling memory channel 99 that has Start and End frequencies stored (page 58), the receive frequency can be changed by using Direct Frequency Entry. When using the keypad to directly enter a frequency, you can never enter a frequency outside the frequency range programmed in memory channel 99.

FRONT PANEL METER

The multifunction meter measures the parameters in the following table. Peak readings for the S-meter, ALC, SWR, COMP, and PWR functions are held for approximately 2.5 seconds if Menu No. 09 (P HOLD) is ON.

Scale	Displays	Functional Condition
S	Received signal strength	Receive
RX FILTER	Width and shift of the receive pass band	Receive; or Transmit plus [METER] ON
PWR	Transmit output power	Transmit
ALC	Automatic level control status	Transmit plus [METER] ON
SWR	Antenna system standing wave ratio	Transmit plus [METER] ON
COMP	Speech compression when using the Speech Processor	Transmit plus SSB/AM plus [PROC] ON plus [METER] ON

Pressing the [METER] button cycles through the functions as shown below:

Receive Mode:

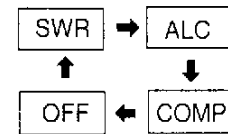

Note: While receiving, the scales for the S-meter and the receive pass band function are always visible.

Transmit Mode:

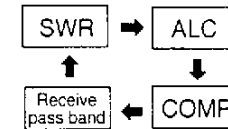

Note:

- ◆ While transmitting, the transmit power meter is always visible.
- ◆ The COMP meter functions only when the Speech Processor is ON in SSB or AM mode.

TRANSMITTING

Methods for transmitting include the following:

- Press **[SEND]**.
- Press and hold down Microphone **[PTT]**.
- Connect a key or keyer paddle, select the CW mode, press **[VOX]** to switch ON the Break-in function, and close the key or keyer paddle.

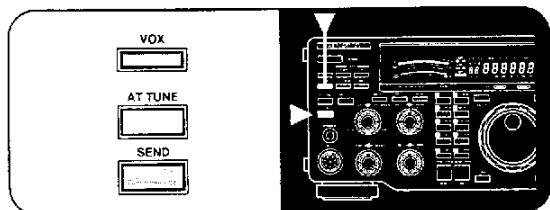

Refer to sections in "COMMUNICATING" beginning on page 29 for detailed explanations for transmitting.

Note: You cannot transmit while the internal antenna tuner is presetting (page 49).

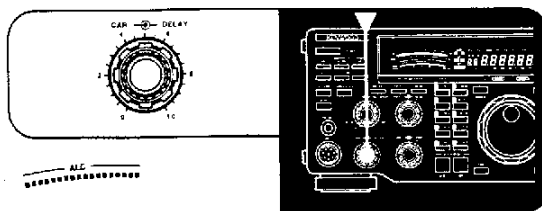

For more specific procedures, refer to instructions for each mode in "COMMUNICATING" beginning on page 29.

Mode		Adjust CAR Control?
CW, AM, FSK		Yes
FM		No (Carrier level is fixed)
USB/ LSB	Speech Processor ON	Yes
	Speech Processor OFF	No



SELECTING TRANSMIT POWER

It's wise, and required by law, to select the lowest transmit power that allows reliable communication. Reducing power lowers the risk of interfering with others on the band. On the TS-870S, it is possible to change output power while transmitting.

To change your output power, turn the **PWR** control counterclockwise to reduce power and clockwise to increase power. The PWR scale on the Front Panel meter provides an indication of your output power in watts while you are transmitting.

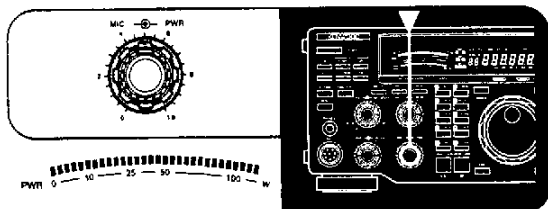

TRANSMIT CARRIER LEVEL

The **CAR** control must be used for adjusting the carrier level for CW, AM, and FSK modes. The control also adjusts the Speech Processor output level when this function is used in the SSB mode. In general, set the **CAR** control so that the ALC meter reads within the limits of the ALC zone. If the carrier level is set via the computer interface, the position of the **CAR** control on the Front Panel is ignored. After turning the **CAR** control, the control becomes active again.

MICROPHONE GAIN

The **MIC** gain control must be adjusted any time the SSB (LSB or USB) or AM mode is used without speech processing. Set the **MIC** gain control so that the ALC meter reads within the limits of the ALC zone at all times. When Speech Processing is used, the microphone gain is fixed as shown in the table below regardless of the **MIC** gain control setting.

Mode (Speech Processor ON)		Microphone Gain Fixed
USB/ LSB	Transmit Equalizer ON	-28 dB
	Transmit Equalizer OFF	-34 dB
AM		-34 dB

The **MIC** gain control has no affect in FM mode. Menu No. 61 (FM MIC) switches the microphone gain between low (L) and high (H) in this mode.

Refer to specific procedures in "COMMUNICATING" beginning on page 29.

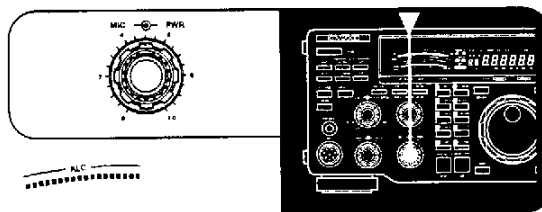

MENU SETUP

WHAT IS A MENU?

Many functions on this transceiver are selected or configured via a software-controlled Menu instead of physical controls on the transceiver. Once familiar with the Menu system, you will appreciate the versatility it offers. No longer is the number and complexity of features restricted by the physical controls and switches on the Front Panel.

MENU ACCESS

The following procedure explains how to check or change any of the Menu items.

- 1 Press **[MENU]**.
- 2 Turn the **M.CH/VFO.CH** control to select the desired Menu No.
- 3 Press **[UP]**, or **[DOWN]**, or Mic **[UP]**, or Mic **[DWN]** to change the current selection for this Menu item.
- 4 Press **[MENU]** or **[CLR]** to exit Menu mode.
 - If the power is switched OFF before this step is completed, the selection just made will be canceled.

MENU A/ MENU B

The TS-870S has two menus. These menus are called Menu A and Menu B. The menus contain identical functions; however, each menu can be configured independently.

For example, you may enjoy two different kinds of operating activities but you like to configure the transceiver differently for each activity. Menu A could be configured with one set of transmit signal characteristics, DSP settings, programmable buttons, frequency steps, etc. Menu B could be configured completely differently. By switching from Menu A to Menu B, you could instantly change Menu configuration and button assignment to suit your current operating style. Or, two operators may share a single transceiver. By dedicating one Menu per operator, each would always enjoy the best configuration.

With a little thought, you can determine the best setups for each Menu for your personal situation. Once you've decided your strategy, select via Menu No. 00 (MENU.A/B) the Menu that you want to set up first. Then use the information in this chapter and on the referenced pages to configure your ultimate operating environments.

QUICK MENU FUNCTION

The Quick Menu function complements the Menu A/B selection capability by allowing you to create your own customized but abbreviated Menu. Copying Menu items to the Quick Menu has no effect on the Menu. You should add only those Menu items to the Quick Menu that you use frequently.

■ Programming the Quick Menu

- 1 Press **[MENU]**.
- 2 Turn the **M.CH/VFO.CH** control to select the desired Menu No.
- 3 To add the selected Menu item to the Quick Menu, press **[M.IN]**.
 - The star lights indicating that the item has been added to the Quick Menu.

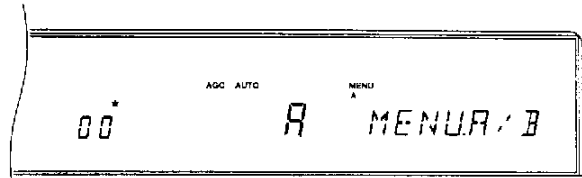

- Each press of **[M.IN]** toggles the item into or out of the Quick Menu.
- 4 Press **[MENU]** or **[CLR]** to exit Menu mode.

■ Using the Quick Menu

- 1 Press **[MENU]**.
- 2 Press **[1MHz]**.
 - "MHz" lights.

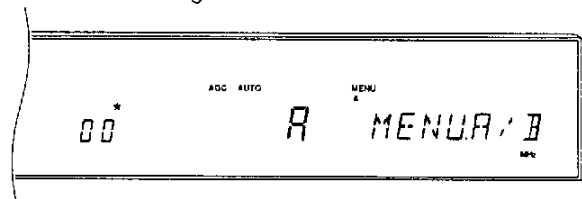

- 3 Turn the **M.CH/VFO.CH** control to select the desired Quick Menu No.
 - If the Quick Menu has not been programmed yet (see previous section), then turning the **M.CH/VFO.CH** control causes an alarm to be emitted (either "CHECK" in Morse code or a triple beep).
- 4 Press **[UP]**, or **[DOWN]**, or Mic **[UP]**, or Mic **[DWN]** to change the current selection for this Quick Menu item.
- 5 Press **[MENU]** or **[CLR]** to exit Quick Menu mode.

TEMPORARY MENU RESETTING

This convenient function allows you to temporarily reset all Menu items to their factory default selections. This can be useful to verify whether a Menu setting is causing undesirable operation.

- 1 Press **[CLR]+ POWER ON** to temporarily reset all Menu items to factory default values.
 - The "MENU" indicator flashes.
- 2 To change all Menu items back to your own programmed values, switch OFF the transceiver, then switch it back ON.

MENU CONFIGURATION

Menu No.	Menu Item	Function	Selections	Default	Page Ref.
00	MENU.A/B	Menu A or B selection	A/B	A	24
01	AUT/MAN	AGC mode: Manual (OFF), Automatic (ON)	OFF/ON	OFF	44
02	AGC SSB	Automatic AGC release time for SSB mode • 1 (Slow) → 20 (Fast)	OFF, 1 ~ 20	7	44
03	AGC CW	Automatic AGC release time for CW mode • 1 (Slow) → 20 (Fast)	OFF, 1 ~ 20	12	44
04	AGC FSK	Automatic AGC release time for FSK mode • 1 (Slow) → 20 (Fast)	OFF, 1 ~ 20	14	44
05	AGC AM	Automatic AGC release time for AM mode • 1 (Slow) → 20 (Fast)	OFF, 1 ~ 20	5	44
06	AF.AGC	AF AGC release time for FM and AM modes • 0: Slow, 1: Med, 2: Fast	0/ 1/ 2	1	44
07	AF.AGC.LV	AF AGC level for FM and AM modes • 0: OFF, 1: Min, 2: Med, 3: High, 4: Max	0/ 1/ 2/ 3/ 4	1	44
08	RX AT	Auto Tuner active while receiving	OFF/ON	OFF	49
09	P HOLD	Peak Hold for multifunction meter	OFF/ON	ON	22
10	Δ FREQ	TX/RX frequency difference for split operation	OFF/ON	OFF	43
11	AIP.GAIN	S-meter correction for AIP (excluding FM/AM)	OFF/ON	OFF	10, 53
12	FM.S-MET	S-meter correction for FM mode	OFF/ON	ON	38
13	LINE.ENH	Line Enhance function	OFF/ON	ON	53
14	LINE.ENH	Line Enhance response time • 0 (Fast) → 4 (Slow)	0/ 1/ 2/ 3/ 4	4	52
15	SPAC	SPAC time	2/ 5/ 10/ 17 ms	17 ms	53
16	SP.BEAT	Beat Cancel response time • 0 (Fast) → 4 (Slow)	0/ 1/ 2/ 3/ 4	2	52
17	SP.NOTCH	Auto Notch response time • 0 (Fast) → 4 (Slow)	0/ 1/ 2/ 3/ 4	2	52
18	TRACK	Adaptive filtering	OFF/ON	ON	52
19	PKT.FIL <i>Note: While operating in SSB mode, the following is displayed in each case: 1200: P.FIL.WID 300: P.FIL.NAR P: P.FIL.PSK</i>	Filter bandwidth for digital operation • OFF: Bandwidth selectable via LO/WIDTH and HI/SHIFT controls • 1200: For wide shift "P.FIL.WID" displayed while operating. • 300: For narrow shift (2310 or 2110 Hz, 200 bps) • P: For PSK modems	OFF/ 1200/ 300/ P <i>Note: For SSB and AM modes, LO/WIDTH and HI/SHIFT controls are enabled, and the filter bandwidth is displayed, only when "OFF" is selected.</i>	OFF	41
20	PKT.IN	AF input level for Digital operation (MCP/TNC TX) • 0: 100 mV, 1: 30 mV, 2: 10 mV	0/ 1/ 2	2	41
21	PKT.OUT	AF output level for Digital operation (MCP/TNC RX) • 0 (minimum level) → 9 (maximum level)	0 ~ 9	4	41
22	MIC AGC	Microphone AGC release time • 0: Slow, 1: Med, 2: Fast	0/ 1/ 2	1	47
23	CW RISE	CW rise and decay times	2/ 4/ 6/ 8 ms	4 ms	31
24	PITCH	CW RX pitch/ TX sidetone frequency	400/ 450/ 500/ 550/ 600/ 650/ 700/ 750/ 800/ 850/ 900/ 950/ 1000 Hz	800 Hz	30
25	PROC.LOW	Speech Processor low-frequency response	-6, -3, 0, +3, +6 dB	-3 dB	23, 46
26	PROC.HI	Speech Processor high-frequency response	-6, -3, 0, +3, +6 dB	+3 dB	23, 46
27	TX INH	TX Inhibit	OFF/ON	OFF	45

5 MENU SETUP

Menu No.	Menu Item	Function	Selections	Default	Page Ref.
28	VOX.GAIN	VOX gain • 0 (minimum gain) → 7 (maximum gain)	0 ~ 7	4	45
29	TX.WIDTH	TX bandwidth for SSB and AM modes	1800/ 2000/ 2300/ 2600/ 3000 Hz	2300 Hz	47
30	TX.SHIFT	TX bandshift for SSB and AM modes	0/ 100/ 200/ 300/ 400/ 500 Hz	300 Hz	47
31	TX.EQ.	TX equalizer for SSB mode • H: High boost • C: Comb filter • B: Bass boost	H/ C/ B	H	47
32	AUTO.RET	Transceiver status after tuning with the antenna tuner • OFF: Transmit status maintained • ON: Receive status restored <i>Note: If OFF is selected, the transmit status can be aborted by pressing [AT TUNE]. OFF may be selected if using a linear amplifier.</i>	OFF/ON	ON	-
33	TUN.WIDE	Allowable SWR range for Antenna Tuner • Tuning stops if: OFF: SWR ≤ 1.2:1 (approx.) ON: SWR ≤ 1.6:1 (approx.)	OFF/ON	OFF	49
34	AUT.MODE	Automatic Mode	OFF/ON	OFF	48
35	BEEP	Button confirmation/ Alarm tone enable • OFF: No Confirmation or Alarm tones • ON: Confirmation and Alarm tones audible	OFF/ON	ON	64
36	BP.MODE	Morse code enable for the operating mode • OFF: Single beep • ON: Morse code	OFF/ON	ON	65
37	WARN. BP	Error message enable for alarm notification • OFF: Triple beep • ON: Morse error message	OFF/ON	ON	65
38	BP.LV	Beep output level • 0 (minimum level) → 9 (maximum level)	0 ~ 9	4	64
39	REPEAT	Playback repeat	OFF/ON	OFF	67
40	REP.TIME	Interval between repeated playbacks	1/ 2/ 3/ 4/ 5/ 10/ 15/ 20/ 25/ 30/ 35/ 40/ 45/ 50/ 55/ 60 sec	5 sec	68
41	F.STEP	Frequency change for one revolution of the Tuning control in SSB, CW, FSK (FINE : OFF)	5/ 10 kHz	10 kHz	21
42	BC.STEP	9 kHz step enable for the M.CH/VFO.CH control in the AM Broadcast band for AM mode • OFF: 10 kHz steps • ON: 9 kHz steps	OFF/ON	See page reference	21
43	CH.STEP	Frequency step size outside the AM broadcast band for the M.CH/VFO.CH control	1/ 5/ 10 kHz	10 kHz	21
44	STEP.ADJ	Alters the function of the M.CH/VFO.CH control if you are operating in VFO mode. • OFF: M.CH/VFO.CH steps the VFO frequency from the current frequency without rounding. • ON: M.CH/VFO.CH steps the VFO frequency but first rounds off the current frequency.	OFF/ON	ON	21
45	PF.KEY.UL	Programmable Function button (upper left)	OFF, 00 ~ 73	69 (ENTER)	63
46	PF.KEY.UR	Programmable Function button (upper right)	OFF, 00 ~ 73	70 (TF-SET)	63
47	PF.KEY.LR	Programmable Function button (lower right)	OFF, 00 ~ 73	71 (1MHz)	63

5 MENU SETUP

Menu No.	Menu Item	Function	Selections	Default	Page Ref.
48	PF.KEY.LL	Programmable Function button (lower left)	OFF, 00 ~ 73	72 (FINE)	63
49	CH.SHIFT	Fixed (OFF) or tunable (ON) memory channel frequencies	OFF/ON	OFF	56
50	DIMMER	Display brightness (controls LCD and LED brightness) • L: Low • H: High	L/H	H	65
51	LINEAR	Linear amplifier relay response time • 1: Fast, 2: Slow	OFF/ 1/ 2	1	5
52	1M/500k	1 MHz button frequency step	100/ 500/ 1000 kHz	1000 kHz	20
53	EXT RX	External RX jack (EXT RX ANT) enable for external receiver	OFF/ON	OFF	2
54	TRANSFER	Data transfer function enable	OFF/ON	OFF	66
55	DIRECT	Method of receiving transferred data • OFF: Transfer to Quick memory • ON: Transfer directly to VFO	OFF/ON	OFF	66
56	COM.RATE	Communication parameters for COM connector Setting Baud Rate (bps) Stop Bits 12 1 1200 1 24 1 2400 1 48 1 4800 1 48 2 4800 2 96 1 9600 1 192 1 19200 1 384 1 38400 1 576 1 57600 1	12 1/ 24 1/ 48 1/ 48 2/ 96 1/ 192 1/ 384 1/ 576 1 <i>Note: To reliably use the 38400 or 57600 bps transfer rates, the serial port of your computer must support these high-speed communications parameters.</i>	96 1	50
57	SUB.TONE	Subaudible Tone frequency for FM mode	See page reference	88.5 Hz	39
58	SUB.TONE	Type of subtone • B: Burst • C: Continuous	B/ C	C	39
59	FM.BOOST	Low-frequency boost for FM receive mode	OFF/ON	OFF	–
60	FM WIDE	Wide band FM deviation enable • OFF: Narrow (2.5 kHz) • ON: Wide (5 kHz)	OFF/ON	ON	–
61	FM MIC	Microphone gain for FM mode • L: Low • H: High <i>Note: Front Panel MIC gain control has no effect when using the FM mode.</i>	L/ H	L	38
62	FSK.SHFT	FSK shift	170/ 200/ 425/ 850 Hz	170 Hz	40
63	MARK.POL	Key-down polarity for FSK • OFF: Space • ON: Mark	OFF/ON	OFF	40
64	FSK.TONE	FSK tone	1275/ 2125 Hz	2125 Hz	40
65	PG.S.HOLD	Scan hold	OFF/ON	OFF	60
66	GRP.SCAN	Group Scan enable for memory channels • OFF: All-channel Scan • ON: Group Scan	OFF/ON	OFF	61
67	BSY.STOP	Busy Stop for Memory Scan	OFF/ON	ON	61
68	CAR.SCAN	Carrier-operated Scan Resume enable for Memory Scan • OFF: Time-operated • ON: Carrier-operated	OFF/ON	OFF	61

5

5 MENU SETUP

CROSS REFERENCE FOR MENU FUNCTIONS

Use this table arranged by subject to help you locate the function that you are interested in checking or changing. Consult "MENU CONFIGURATION" (page 25) for more detail for each function.

Function	Menu No.
AMPLIFIER	
Linear amplifier relay	51
ANTENNA TUNER (AT)	
RX enable/disable	08
SWR range	33
TX/RX status after tuning	32
AUTOMATIC GAIN CONTROL (AGC)	
AF	06
AF Level	07
AM	05
Manual/Automatic	01
CW	03
FSK	04
Microphone	22
SSB	02
BEEP FUNCTIONS	
Alarm type (message/beep)	37
Beep level	38
Confirmation tones (OFF/ON)	35
Confirmation tone type (Morse/beep)	36
CW	
Rise and decay times	23
RX pitch	24
TX sidetone	24
DATA TRANSFER	
Method of transfer	55
Transfer enable (OFF/ON)	54
DISPLAY	
Dimmer	50
Peak Hold meter	09
Δf for TX/RX split operation	10
DRU-3 DIGITAL RECORDING SYSTEM (DRS)	
Playback repeat	39
Playback repeat interval	40
DIGITAL SIGNAL PROCESSING	
Adaptive filtering	18
Auto Notch response time	17
Beat Cancel and response time	16
Line Enhance function	13
Line Enhance response time	14
SPAC time	15

Function	Menu No.
FM	
Deviation	60
Low-frequency receive boost ("loudness")	59
Microphone gain	61
Subtone selection	57
Subtone type	58
FREQUENCY STEPS	
M.CH/VFO.CH control	43
M.CH/VFO.CH control (AM broadcast only)	42
M.CH/VFO.CH control (step rounding)	44
Tuning control (one revolution)	41
[1MHz] button	52
FSK	
Polarity (space/mark)	63
Shift	62
Tone	64
MEMORY CHANNELS	
Fixed/tunable frequency	49
MENU	
A/B selection	00
MODE	
Automatic SSB, CW, FSK, FM, AM (OFF/ON)	34
PACKET/ DIGITAL OPERATION	
AF input (MCP/TNC TX)	20
AF output (MCP/TNC RX)	21
Filter bandwidth	19
PROGRAMMABLE BUTTONS	
[ENTER] button (upper left)	45
[FINE] button (lower left)	48
[TF-SET] button (upper right)	46
[1MHz] button (lower right)	47
REAR PANEL	
COM communication parameters	56
EXT RX ANT enable for external receiver	53
S-METER	
AIP function correction	11
FM mode correction	12
SCAN	
All/Group Scan (Memory Scan)	66
Busy Stop (Memory Scan)	67
Hold (Program Scan)	65
Resume (Time or Carrier for Memory Scan)	68
SPEECH PROCESSOR	
Low-frequency response	25
High-frequency response	26
TX	
Bandshift (SSB and AM)	30
Bandwidth (SSB and AM)	29
Equalizer (SSB)	31
Inhibit	27
VOX	
Gain	28

SSB TRANSMISSION

SSB is now the most commonly-used mode on the HF Amateur bands. This popularity is not surprising due to its narrow bandwidth requirements and its good long distance communications capability that demands minimum transmit power when compared with other voice modes. These reasons, combined with the fact that modern Amateur transceivers deliver reasonably good audio quality, make SSB the mode that most prefer on HF. Due to this popularity, you will want to use the technology available on the TS-870S as explained in this and later sections to make your transmitted signal the best possible.

Refer, if necessary, to "OPERATING BASICS" beginning on page 19 for complete receiving details for any mode.

- 1 Select the operating frequency.
- 2 Press **[LSB/USB]** to select either upper or lower sideband mode.

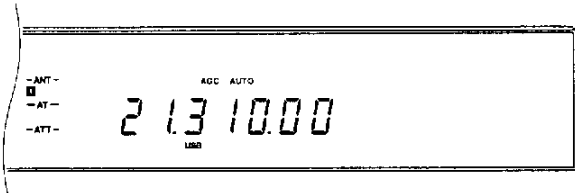

- 3 Select the ALC meter function by pressing **[METER]**.

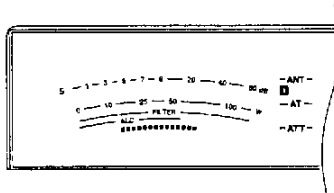

- 4 Press and hold down the Microphone **[PTT]** switch, or press **[SEND]**.
 - The "ON AIR" indicator lights.
 - Refer to "VOX" (page 45) for information on automatic TX/RX switching.
- 5 Speak into the microphone and adjust the **MIC** gain control so that the meter reads in the ALC zone but doesn't exceed the upper ALC zone limit.
 - Speak in a normal tone and level of voice. Speaking too close to the microphone, or too loudly, may increase distortion and reduce intelligibility.
 - The ALC level is more restricted than previous **KENWOOD** transceivers due to the added benefit of the DSP-controlled Microphone AGC function (page 47).
 - With the Speech Processor switched OFF, the **CAR** control has no function in this mode.
- 6 If you want to use speech processing, press **[PROC]** to switch on the Speech Processor and adjust as described on page 46.
- 7 Release the Microphone **[PTT]** switch, or press **[SEND]** again, to return to the receive mode.
 - The "ON AIR" indicator goes out.

SLOW SCAN TV/ FACSIMILE

SSTV complements SSB operating since a voice contact is established first before pictures are exchanged. Though once a specialty mode involving a very small percentage of Amateurs, slow scan television is now increasing in popularity as a result of the capability of computers.

No longer is it necessary to squint at an old CRT to view a continuously fading image. It isn't necessary to invest in a large amount of additional equipment anymore either. SSTV can be a convenient method of adding interest to otherwise routine voice contacts. Instead of trying to describe your station, just show it. Many Amateurs are only lacking a little application software that uses your computer sound card for transmitting and receiving monochrome or full-color SSTV images.

SSTV FREQUENCIES

IARU Region 1 (Europe/Africa) Frequency (kHz)	U.S.A./Canada Frequency (kHz)
3730~3740	3845
7035~7045	7171
14225~14235	14230
21335~21345	21340
28675~28685	28680

6

The high resolution that is possible using facsimile (FAX) can allow you to exchange more detailed graphics than SSTV allows. Due to the longer transmission times required for FAX, it's best to use this mode when band conditions are stable with strong signals.

Popular FAX frequencies include the following:

- 7245, 14245, 21345 (Intern. Net), 28945 kHz

Operation on SSTV or FAX mainly involves learning the functionality of your computer application or accessory hardware that supports these modes. Consult the documentation that comes with your software or accessory equipment.

Note: When operating either SSTV or FAX, use a fast AGC setting and switch OFF your Speech Processor for best results.

This completes the "SSB TRANSMISSION" section. Refer to "OPERATING AIDS" beginning on page 44 for information about additional useful functions for operating.

6 COMMUNICATING

CW TRANSMISSION

CW operators know that this mode is a reliable method of communicating under the worst conditions. Although it's true that newer digital modes rival CW as being equally as useful in poor conditions, these modes do not have the long history of service yet nor the simplicity that CW can have. Therefore, functions required by CW operators were given serious consideration from the start of the TS-870S design.

Refer, if necessary, to "OPERATING BASICS" beginning on page 19 for complete receiving details for any mode.

- 1 Select the operating frequency.
- 2 Press **[CW/-R]** to select CW mode.

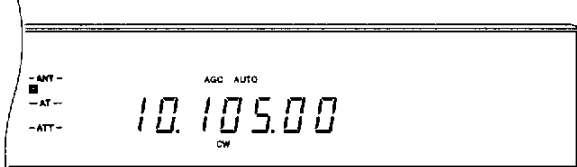

- 3 Select the ALC meter function by pressing **[METER]**.

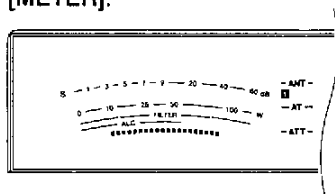

- 4 Press **[SEND]**.
 - The "ON AIR" indicator lights.
 - Refer to "SEMI BREAK-IN" {page 31} or "FULL BREAK-IN" {page 31} for information on automatic TX/RX switching.
- 5 With a key down condition, adjust the **CAR** control so that the meter reads in the ALC zone but doesn't exceed the upper ALC zone limit.
- 6 After completing your transmission, press **[SEND]** again to return to the receive mode.
 - The "ON AIR" indicator goes out.

TX SIDETONE/ RX PITCH FREQUENCY

The transmit sidetone is the monitor tone you hear from your transceiver as you send CW. It is necessary so you can hear what you are transmitting. It is also useful for checking that your key contacts are closing, the keyer is functioning, or for sending practice without putting a signal on the air. The volume of the sidetone is adjusted by the **MONI** control.

Receive pitch refers to the frequency of the CW note that you hear after tuning your receiver for maximum receive signal strength. On the TS-870S, the frequency of the sidetone and receive pitch are equal and selectable. You can select the frequency that is most comfortable for you via Menu No. 24 (PITCH). The default is 800 Hz.

The following selections are available:

- 400 ~ 1000 Hz inclusive in 50 Hz steps

Note: Changing the RX pitch frequency does not shift the center frequency of the receive filter pass band. If a CW signal becomes inaudible, shift the pass band by adjusting the **HI/SHIFT** control. Refer to "IF SHIFT" {page 51}.

ZERO-BEATING

Zero-beating means matching your transmit frequency with the station that you are receiving. This is important if you expect other stations to hear you without them retuning their receivers. Zero-beating also saves space on the band since only a single frequency is used by you and the other station for your contact. If you are part of a "roundtable" where more than two stations are participating but each is on a different frequency, it's frustrating to keep retuning to a different frequency each time one of the roundtable stations begins sending. Learn to zero-beat accurately and quickly.

- 1 Press **[VOX]** and press **[RIT]** to switch OFF the VOX and RIT functions respectively.
 - "VOX" and "RIT" go out.
- 2 With CW mode selected, turn the **Tuning** control to tune in a CW station for maximum signal strength.
- 3 Close your key to activate the sidetone.
 - You will hear a steady tone.
- 4 Turn the **Tuning** control until the note from the received CW signal matches the sidetone note, then release the key.
 - To double check that you are zero beat, press **[CW/-R]** to switch to the opposite sideband. You should hear no difference in tone of the received CW signal.

SWITCHING TX/RX MANUALLY

- 1 Select CW mode by pressing **[CW/-R]**.
 - "CW" lights.

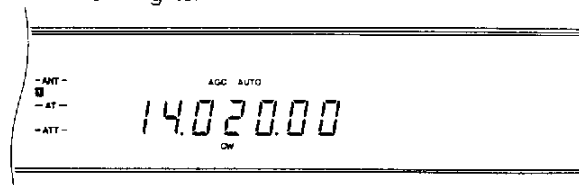

- 2 Press **[SEND]**.
 - The receive audio is muted.
 - Holding down Microphone **[PTT]** also switches between receive and transmit.
- 3 Send CW.
- 4 When finished sending, release **[SEND]** or **[PTT]**.

SEMI BREAK-IN

Semi Break-in allows you to transmit without manually switching between transmit and receive modes. When the key contacts open, the transceiver automatically waits for the time period to pass that you have selected via the **DELAY** control. The transceiver then returns to the receive mode.

1 Select CW mode by pressing [CW/-R].

- "CW" lights.

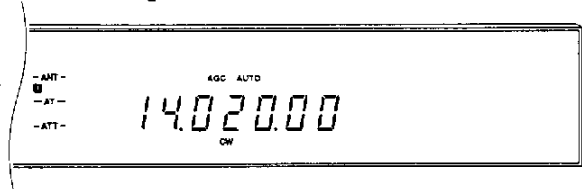

2 Press [VOX] to switch ON the Break-in function.

- "VOX" and either "SEMI" or "FULL" lights depending on whether Semi or Full Break-in was last selected.

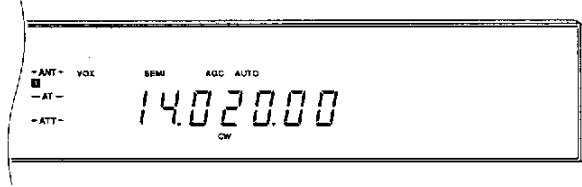

3 If "FULL" lights, press [FULL/SEMI] to toggle to the SEMI status.

- "SEMI" lights.

4 Send CW.

- The transceiver switches automatically to transmit and mutes the receiver each time the key closes. After the key opens, the transceiver returns to receive mode after a delay.

■ Setting Delay Time

The delay time is the length of time that the transceiver remains in transmit mode after the key is opened. This time should be set based on your keying speed and your personal preference.

While sending using Semi Break-in, adjust the **DELAY** control for the delay you prefer. The control has a range from 50 ms ~ 800 ms in steps of 50 ms.

Note:

- ◆ The range and step size of the **DELAY** control differ depending on the operating mode selected.
- ◆ Setting the delay time by computer overrides any setting of the **DELAY** control. The control then has no effect. To restore functionality to the **DELAY** control, turn the control. The newly selected setting becomes effective.

FULL BREAK-IN

Full Break-in returns the transceiver to the receive mode as soon as the key contacts open. It's possible to hear if another station wants to interrupt, and it also allows you to hear interference that may begin after you start sending.

1 Select CW mode by pressing [CW/-R].

- "CW" lights.

2 Press [VOX] to switch ON the Break-in function.

- "VOX" and either "SEMI" or "FULL" lights depending on whether Semi or Full Break-in was last selected.

3 If "SEMI" lights, press [FULL/SEMI] to toggle to the FULL status.

- "FULL" lights.

4 Send CW.

- The transceiver switches automatically to transmit each time the key closes; however, it returns to receive mode immediately when the key opens.

Note:

- ◆ Full Break-in cannot be used with the TL-922/922A amplifier.
- ◆ During split-frequency Full Break-in operation, you may hear clicks depending on the transmit and receive frequency relationship.
- ◆ The position of the **DELAY** control is ignored while using Full Break-in.
- ◆ If using Full Break-in CW, the internal antenna tuner can be bypassed completely or can be in-line for both transmitting and receiving. To protect the antenna tuner relay, the tuner cannot be used only for transmitting.

6

CW REVERSE (RECEIVE)

This function switches receive from the default upper sideband to the lower sideband, therefore, interference that is heard may be eliminated. When your receive frequency is identical to the transmit frequency of the other station, the CW Reverse function has no effect on receive tone or your transmit frequency.

Press [CW/-R] to select CW Reverse.

- "CW" and "R" light.

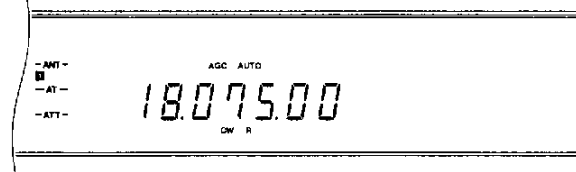

RISE/DECAY TIMES

The rise time of a CW signal is the time for the RF output to rise to its maximum power after the key is closed. This time excludes the make delay that occurs after closing the key but before the RF output actually begins to increase. You can adjust the CW rise time for the TS-870S via Menu No. 23 (CW RISE). The default is 4 ms. This adjustment also affects the decay time. The decay time excludes the short break delay from the moment when the key opens to when the RF output begins to fall.

The default setting is fine for low to moderate keying speeds and normal weighting (dot/dash ratios). The 2 ms setting is good for higher CW speeds or when operating with unusual dot/dash ratios. The available rise time selections include 2, 4, 6, and 8 ms.

6 COMMUNICATING

ELECTRONIC KEYS

The keyer supplied with the TS-870S is a full-featured K-1 Logikey keyer that will delight anybody that respects a good keyer. A great deal of information on using this keyer is provided in this manual, not because it is difficult to use, but because it has an incredible number of features. Some of the features of your keyer include:

- Iambic operation with dot and dash memories
- Programmable via commands sent from your key
- Emulation modes for other keyer types — you won't have to re-train yourself if you're used to a keyer with different timing
- Soft-sectored messages that can "call" each other and can contain embedded functions
- Automatic contest serial number generation
- Digital and linear speed control (6 ~ 60 wpm)
- Adjustable weight for code elements (25% ~ 75%)
- Tune function for continuous key down
- Selectable automatic character spacing
- Message loop capability for continuous replay

It is probably best to learn the keyer's basic functions first, then use it on-the-air. Over time, you will build up your knowledge of its operation bit by bit. Don't try to memorize everything at one time!

Points to know before beginning:

- Although the sidetone can be heard while using any mode, CW mode must be selected to set functions on the keyer.
- When pressing two or more keys on the keypad to select a keyer function, press the correct keys as instructed, then release them. You know you've held them down too long if you hear a continuous tone before releasing the keys. In this case, a rapid multi-dit error alarm sounds when you release the keys to confirm the error.

Function	Default
Speed	20 wpm
Weight	50%
Auto-space	OFF
Load mode	Character
Input queue	ON
Serial number	001
Number option	0
Emulation	K-1 Logikey
Function speed	Equals paddle speed

Learning Outline

To help you learn the keyer, the table below offers suggestions for how to proceed. Consult the indicated tables and procedures for specific information.

Activity	Consult
Set the keyer speed range to suit your keying ability. Also, set the keyer speed.	Range: Reset function in Multiple-Button Functions table {page 33} Speed: KEY SPEED control {page 11}
Confirm that correct right- or left-handed orientation is selected.	Reverse function in Multiple-Button Function table {page 33}
Select the emulation that suits you best. If unsure, use the default.	Emulation Options procedure and table {page 33}
Learn how to load messages into memory.	Storing CW Messages procedures {page 34}
Learn how to play back memory messages.	CW Message Playback procedure {page 34}
Learn how to erase memory messages.	Erasing CW Messages procedure {page 35}
Learn how to initiate Hand-key and Tune modes.	Multiple-Button Functions table {page 33}
Explore the Inquiry mode.	Multiple-Button Functions {page 33} and Inquiry Functions procedure and table {page 35}
Explore the Function mode.	Multiple-Button Functions {page 33} and Function Commands procedure and table {page 36}
Explore Embedded Functions.	Embedded Functions procedure and table {page 37}
Study the different method of sending serial numbers in contests.	Serial Number Options table {page 37}

■ Multiple-Button Functions

Function Name	Buttons	Description
Decrement	[CH 2]+ [CH 3]	The keyer acknowledges with "D", then decrements the serial number.
Function	[CH 1]+ [CH 2]	The keyer acknowledges with "F", then waits for paddle entry of the desired command.
Hand-key	[CH 1]+ [CH 3]	The keyer acknowledges with "H", then enters hand-key mode until another button closure occurs.
Inquiry	[CH 3]+ [CH 4]	The keyer acknowledges with "?", then waits for paddle entry of the desired option.
Kill Playback (in progress)	Any two buttons	The keyer immediately halts and stops transmitting the message. No "dit" is transmitted.
Reset <i>Note:</i> <i>Press all keys simultaneously. A transceiver Full Reset (page 63) also resets the keyer speed to 20 wpm.</i>	[CH 1]+ [CH 2]+ [CH 3]+ [CH 4]	The keyer speed is reset to 20 wpm at the current knob position, the function-entry speed is defaulted to follow the KEY SPEED control setting, then the keyer acknowledges with "OK".
Reverse	[CH 1]+ [CH 4]	The keyer acknowledges with "RV", then reverses the paddles.
Tune	[CH 2]+ [CH 4]	The keyer acknowledges with "X", then keys the output continuously until a paddle closure occurs.

■ Emulation Options

This parameter allows the keyer timing to mimic that of other keyers, making the "feel" more comfortable for operators used to different timing parameters. The default is V0.

To check or change the emulation, you must briefly use the Inquiry or Function mode. You will learn more about these modes beginning on page 35.

To check Emulation option:

- 1 Press [CH 3]+[CH 4].
 - The keyer will send "?".
- 2 Send a "V".
 - The keyer will send the current emulation (e.g. V0).

To change Emulation option:

- 1 Press [CH 1]+[CH 2].
 - The keyer will send "F".
- 2 Send a "Vd" where d represents the emulation number (see table) that you desire.

6

Option	Description
V0	Normal with dot and dash memory
V1	Normal with dot memory only
V2	Normal with dash memory only
V3	Accukeyer timing with dot and dash memory
V4	Accukeyer timing with dot memory only
V5	Accukeyer timing with dash memory only
V6	Curtis "A" timing with dot and dash memory
V7	Curtis "A" timing with dot memory only
V8	Curtis "A" timing with dash memory only
V9	Iambic timing with no dot or dash memory

6 COMMUNICATING

■ Storing CW Messages

The two modes available for storing messages are Character mode and Real Time mode. Each message may be as long as you want provided that the total of all four messages including spaces does not exceed about 220 characters. You must use the internal keyer to use the message storage function. If you happen to turn OFF the power while storing a message, the last letters input may be deleted. You cannot store messages if you are operating split mode (transmit mode different than receive mode).

Using Character mode (default):

This mode uses message memory most efficiently. Each Morse character uses one byte of memory. When you play back your recorded messages, they will be sent with precise intercharacter and interword spacing.

- 1 Press [CH 1] or [CH 2] or [CH 3] or [CH 4] for approximately two seconds until you hear a tone.
 - The keyer will send the letter "C". This stands for Character mode.
 - If the keyer sends "R" (for Real Time), you must switch to Character mode by using the Function mode {page 36}.
- 2 Send the first word of your message then pause.
 - The keyer will send the letter "I" indicating it has accepted your word.
- 3 Repeat Step 2 pausing to hear the "I" before sending the next word until all words of your message are entered.
 - If you make a sending mistake, send seven or more dits to signal an error, then wait for the keyer to respond with the last correct word. You can then send the next word that you want in the message. Each time that you send the 7-dit error signal, you erase one more word.
- 4 Press the same button as pressed in Step 1.

Using Real Time mode:

Real Time mode captures exactly what you send without altering your spacing. This mode cannot use Embedded Functions {page 37}. Also, you cannot correct words by using the 7-dit error signal as in Character mode.

Before beginning, switch to Real Time mode by using the Function mode {page 36}.

- 1 Press [CH 1] or [CH 2] or [CH 3] or [CH 4] for approximately two seconds until you hear a tone.
 - The keyer will send the letter "R". This stands for Real Time mode.

- 2 Send your entire message.
- 3 Press the same button as pressed in Step 1.
 - Message recording begins at the moment the first character is sent, and continues until this step is completed. Any pause between the last character and this step is recorded as part of the message.

■ CW Message Playback

Messages may be transmitted using the VOX function or manual TX/RX switching. The procedure below uses the VOX function. Simply tap the paddle at any time to stop a message while it is playing back, or press any two of [CH 1], [CH 2], [CH 3], or [CH 4] to stop the message without transmitting an extra character. Resuming playback after such an interruption replays the message from the beginning.

Switching OFF the power while playing back a message could delete the message. You cannot play back messages if you are operating split mode (transmit mode different than receive mode).

To check a message without transmitting:

- 1 Press [VOX] to switch OFF the VOX function.
- 2 Press the memory channel button ([CH 1] or [CH 2] or [CH 3] or [CH 4]) that contains the message that you want to check.
 - The message plays.
 - To play back up to 8 messages, press the corresponding memory channel buttons in sequence during playback.

To transmit a message:

- 1 Press [VOX] to switch ON the VOX function.
- 2 Press the memory channel button ([CH 1] or [CH 2] or [CH 3] or [CH 4]) that contains the message that you want to transmit.
 - The message is transmitted.
 - To transmit up to 8 messages, press the corresponding memory channel buttons in sequence during playback.

The "Q" Function command {page 36} allows you to queue several messages to form a longer message.

Example:

- "Q" Function status: ON
- Channel 1 contents: "CQ"
- Channel 2 contents: "de DFØTK"

In this example, pressing the button sequence [CH 1], [CH 1], [CH 1], [CH 2] would send "CQ CQ CQ de DFØTK".

■ Erasing CW Messages

- 1 To erase a memory channel's message, press its associated button ([CH 1] or [CH 2] or [CH 3] or [CH 4]) until you hear a tone.
 - The keyer will send the letter "C" or "R" depending whether you are in Character or Real Time mode.
- 2 Press the same memory channel button again.
 - The message in that memory is now erased.

■ Inquiry Functions

Inquiry functions report the current state of the keyer. Information is played to the operator in Morse code with the monitor automatically enabled and keying output disabled.

To check an inquiry function:

- 1 Press [CH 3]+[CH 4].
 - The keyer will send "?".
- 2 Send an Inquiry command from the table.

Inquiry Command	Command Name	Description
A	Inquire Auto-space	The keyer responds by sending "ON" or "OFF" as appropriate.
C	Inquire Capacity	The keyer sends the amount of free memory available for message storage.
F	Inquire Function Speed	The keyer sends the current function speed setting in wpm.
K	Inquire Keying Compensation	The keyer sends the current compensation in milliseconds.
L	Inquire Load Mode	The keyer responds by sending "C" if in Character mode or "R" if in Real Time mode.
N	Inquire Number	The keyer plays the current contest serial number (but does not increment it).
Q	Inquire Queue	The keyer responds with "ON" or "OFF" as appropriate.
S	Inquire Speed	The keyer sends the current operating speed in wpm.
V	Inquire Emulation Setting	The keyer sends the current emulation. See "Emulation Options" {page 33}.
W	Inquire Weight	The current weight percentage is sent by the keyer as 2 digits.
Z	Inquire Zeros and Nines	The keyer responds with the option number (0 ~ 9) currently in effect.
1, 2, 3, or 4	Inquire Message #1, #2, #3, or #4	Message #1, #2, #3, or #4 is played.

6 COMMUNICATING

■ Function Commands

Commands to the keyer are entered in Morse code using your paddle. The keyer disables output keying. When the function is complete, output keying is enabled, and the previous operating speed is restored.

1 Press [CH 1]+[CH 2].

- The keyer will send "F".

2 Send a Function command from the table.

- If an incorrect command is input, a multi-dit error tone will be sent.

Function Command	Command Name	Description
A	Auto-space	Toggles the automatic character spacing feature ON or OFF. The keyer confirms the new state by sending "ON" or "OFF". Auto-spacing helps form properly spaced characters within a word. Character crowding is prevented by forcing at least 3 space elements whenever more than one space is detected. This effect is especially noticeable at low speeds. Without auto-spacing, character spaces are determined by the operator.
D	Decrement	Decrements the serial number by 1, effectively canceling the automatic increment applied when last played from a message. The decrement function accommodates re-sending the last serial number, as might be needed when a repeat of a contest exchange is requested.
F dd	Function speed	Sets the speed used for function entry to dd wpm, where dd are two digits in the range 06 ~ 30. This speed is used to enter commands and load messages. It is independent of operating speed and is unaffected by the analog speed control. Alternatively, "dd=00" makes the function speed track the operating speed.
H	Hand-key	Causes the keyer to enter the Hand-key mode. Keying output will follow closures of the dot and dash paddle levers, allowing hand-sent code. Normal iambic keyer operation is regained by any button closures.
K dd	Keying Compensation	Increases keying on-time and decreases keying off-time by dd milliseconds, where dd are two digits in the range 00 ~ 25. Although similar to increasing weight, this adjustment is independent of speed. This setting is used primarily to correct keying distortion introduced by the transceiver using Break-in operation.
L	Load mode	Toggles the load mode between Character and Real Time. The keyer confirms the new mode by sending "C" or "R" as appropriate.
N dddd	Number	Initializes the contest serial number to dddd, where dddd are four digits in the range 0000 ~ 9999. Four digits must be entered (with leading zeros if needed).
Q	Queue	Toggles the input queue ON or OFF. The keyer confirms the new mode by sending "ON" or "OFF" as appropriate. When OFF, message button activations are acted upon immediately, canceling any message in progress. When ON, up to eight button presses are remembered in order and acted upon in succession as each message completes.
RV	Reverse	Reverses the dot and dash paddles as may be desired for left-handed operators.
S dd	Speed	Sets the current operating speed to dd wpm, where dd are two digits in the range 06 ~ 60. The speed function establishes the current knob position at the entered speed. The knob can then be employed to vary the speed faster or slower over a total range of 3:1. Control via the knob is linear and increases speed clockwise.
SU d	Speed Up	Increases the operating speed by d wpm. d is a single digit in the range 0 ~ 9.
SD d	Slow Down	Decreases the operating speed by d wpm. d is a single digit in the range 0 ~ 9.
V d	Emulation	Allows an operator to select emulation of the timing characteristics of other keyers.
W dd	Weight	Sets code weight to dd percent, where dd are two digits in the range 25 ~ 75. Weight is the duty cycle of a continuous string of dots, which is 50% for perfect code. A higher weight produces a heavier sound, and a lower weight causes characters to sound lighter. Once set, weight remains constant and independent of speed.
X	Xmit (tune)	Continuously keys the output for purposes of transmitter and amplifier adjustment. Tuning is stopped by simply tapping either the dot or dash paddle.
Z d	Zeros and Nines	Controls the way that zeros and nines are sent in the serial number. See "Serial Number Options".

■ Embedded Functions

Certain functions can be embedded within character messages. The command strings are prefixed by a "/", and are entered as a separate word. The letters following a "/" that are contained within a word are not interpreted as an embedded function. For example, the keyer understands that "WD6DJY/VE7" does not include an embedded command since "/VE7" is not sent as a separate word. These commands must be stored in **CH 1 ~ CH 4**; they cannot be manually sent.

Command	Command Name	Description
/B	Break	Message play pauses for manual text insertion. One or more words may be inserted via the paddle. Once paddle input has begun, the break is canceled when inactivity exceeding a word space is detected, and the interrupted message resumes. A break may also be aborted by pressing any button, causing the corresponding message to play immediately.
/D	Decrement	Decrements contest serial number by 1.
/Gd	Gap	The normal 7-element interword space is modified to 3+d, where d is a digit in the range 0 ~ 9. It is used to exaggerate inter-character or interword spacing. For example, a call like WØEJ can be entered with slight lengthening of the space between the "E" and the "J" for emphasis, making it easier to copy. Note that /G0 yields a normal character space, while /G4 yields a normal word space.
/N	Number	The current value of a contest serial number is played. Its value is then automatically increased by 1. See "Serial Number Options".
/Pdd	Pause	A speed-independent pause of d.d seconds is inserted, where dd are two digits in the range 00 ~ 99. For example, /P35 will result in a delay of 3.5 seconds. Pauses longer than 9.9 seconds are obtained by using consecutive commands that total the value desired.
/R	Resume	Stops playback to allow hand-sent entry. When manual keying is completed, press the button for the message being played and the message will resume transmitting. Multiple "/R" commands are permitted.

Command	Command Name	Description
/Sdd	Speed	The operating speed is set to dd wpm, where dd are two digits in the range 6 ~ 60.
/SUd	Speed Up	Increases the operating speed by d wpm, where d is a single digit in the range 0 ~ 9.
/SDd	Slow Down	Decreases the operating speed by d wpm, where d is a single digit in the range 0 ~ 9.
/Udd	Ultra-speed	Sets the ultra-speed mode for a message. Range is 70 ~ 990 words per minute, where dd are two digits representing the first two numbers of the speed setting desired. For example, "07" is 70 wpm, "77" is 770 wpm. This command is used primarily for meteor scatter work. Note that Weighting (W) and Compensation (K) settings are disabled during Ultraspeed message transmission.
/1, /2, /3, or /4	Message #1, #2, #3, or #4	Message #1 is played followed by resumption of the current message. If the current message is #1, a continuous loop is created. The same is true for the other messages.

Note: You can play back a message to listen to the Embedded function by simply pressing [CH 1], or [CH 2], or [CH 3], or [CH 4] for the channel that contains the Embedded function.

■ Serial Number Options

The "Zd" command selects 1 of 10 options for sending zeros and nines in a contest serial number. Zeros may be replaced by "O" or "T", nines replaced by "N", and leading zeros suppressed.

Option (d)	Leading Zeros	Other Zeros	Nines
0	Ø	Ø	9
1	-	Ø	9
2	O	Ø	9
3	O	O	9
4	-	O	9
5	T	Ø	9
6	T	T	9
7	-	T	9
8	T	T	N
9	-	T	N

Note: For numbers less than 1000, the first zero is always suppressed.

This completes the "CW TRANSMISSION" section. Refer to "OPERATING AIDS" beginning on page 44 for information about additional useful functions for operating.

6 COMMUNICATING

FM TRANSMISSION

FM operation on HF frequencies solves the problem of how to have long distance voice communication with the finest audio quality. When combined with the full-quieting aspect of FM signals that suppress background noise on the frequency, FM can be the best method for maintaining regular schedules with friends. And when conditions are unusually good allowing simplex FM contacts over intercontinental paths, you may feel as though you are using your local VHF repeater to talk across town instead of using the HF spectrum for multi-hop communication.

Refer, if necessary, to "OPERATING BASICS" beginning on page 19 for complete receiving details for any mode.

Note: Switch ON Menu No. 12 (FM,S-MET) if you prefer. This function applies a correction for the S-meter when operating on FM. This correction will adjust S-meter readings to be equal with other KENWOOD HF transceivers.

6

- 1 Select the operating frequency.
- 2 Press **[FM/AM]** to select FM mode.

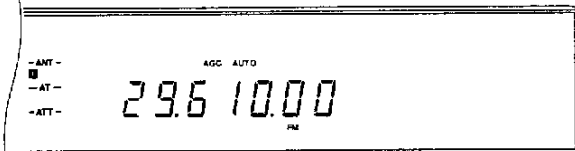

- 3 Press **[MONI]** to switch the Monitor function ON.

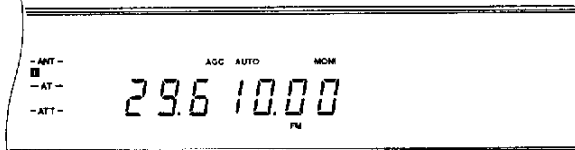

- 4 Press and hold down the Microphone **[PTT]** switch, or press **[SEND]**.
 - The "ON AIR" indicator lights.
 - Refer to "VOX" (page 45) for information on automatic TX/RX switching.
- 5 Speak into the microphone.
 - FM microphone gain can be switched between low (L) or high (H) via Menu No. 61 (FM MIC). The default is low (L). Low is usually appropriate; however, select high if the monitored audio or reports from other stations indicate that your audio is weak. The Front Panel **MIC** gain control has no affect in the FM mode.
 - Speak in a normal tone and level of voice. Speaking too close to the microphone, or too loudly, may increase distortion and reduce intelligibility.
 - The **CAR** control does not need to be adjusted since the carrier level is fixed at the best setting for the FM mode.
- 6 Release the Microphone **[PTT]** switch, or press **[SEND]** again, to return to the receive mode.
 - The "ON AIR" indicator goes out.

FM REPEATER OPERATION

Compared to the usual simplex method of FM communications on HF, which is radio to radio with antennas at or slightly above average terrain, you can often transmit much farther through repeaters.

Repeaters are typically located on a mountain top or other elevated location. Most often they operate at a higher ERP (Effective Radiated Power) than the average mobile or fixed amateur station. This combination of elevation and high ERP allows communications over wider and longer distances than can be achieved by the average station.

HF repeaters operate only in the 29 MHz FM sub-band. This special service combines the advantages of FM operation, good fidelity with noise and interference immunity, with the excitement of HF DX (long distance) communications. Even on a quiet day, 10 meter FM provides reliable around-town communications with the potential for sudden DX from across the country or around the world.

Note: Switch ON Menu No. 12 (FM,S-MET) if you prefer. This function applies a correction for the S-meter when operating on FM. This correction will adjust S-meter readings to be equal with other KENWOOD HF transceivers.

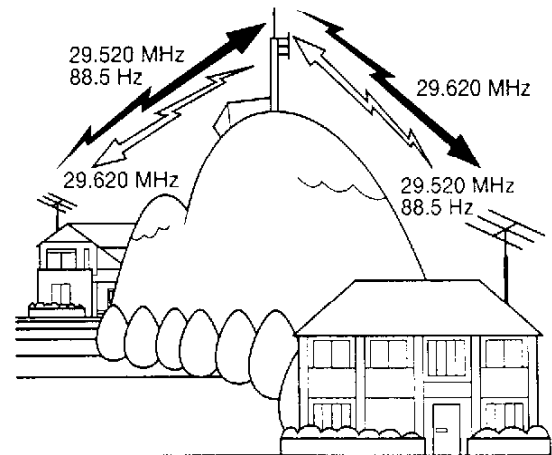

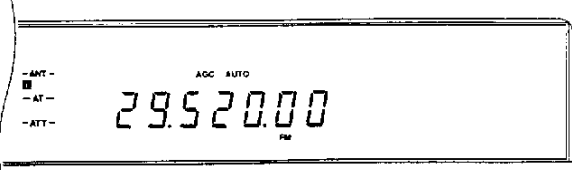
- 1 Press **[RX B]** (or **[RX A]**).
 - The VFO selected in this step will be used for the transmit frequency.
 - 2 Select the transmit frequency.
 - 3 Press **[FM/AM]** to select FM mode.
- 
- 4 Press **[A=B]**.
 - 5 Press **[RX A]** (or **[RX B]**).
 - This must be the VFO that was not selected in Step 1.

6 Select the receive frequency.

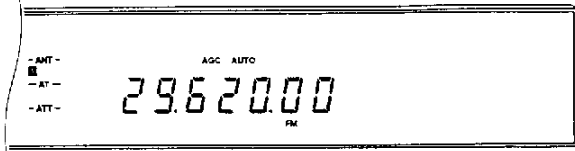

7 Press [TX B] (or [TX A]) to select split operation.

- This must be the same VFO as selected in Step 1.
- The Tone function automatically switches ON.

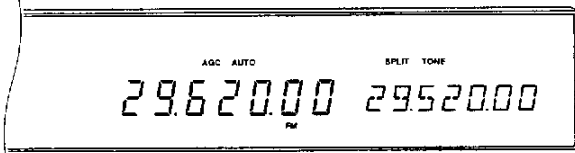

8 Select the Subtone frequency via Menu No 57 (SUB.TONE) and Menu No. 58 (SUB.TONE).

- See "Selecting Subtone Frequency" and "Continuous or Burst Subtones?" for more details on the Subtone.

To store data selected in Steps 1 ~ 8 in a memory channel:

- 9 Press [M.IN].
- 10 Turn the **M.CH/VFO.CH** control to select a channel (excluding channel 99).
- 11 Press [M.IN].

To send a Subtone that is stored in memory:

- 12 Press [RX M.CH].
- 13 Turn the **M.CH/VFO.CH** control to select the channel.
- 14 Press [PTT] or [SEND].

Note:

- ◆ When operating through a repeater, over deviation caused by speaking too loudly into the microphone can cause your signal to "talk-off" (break up) through the repeater.
- ◆ When Subtones can be transmitted, "TONE" lights on the Display.
- ◆ Memory Transfer does not copy the stored Subtone frequency data to the VFO.
- ◆ The Subtone transmitted is the tone associated with the memory channel or the VFO frequency that is used for the transmit function. When you transmit using a VFO frequency or the channel 99 frequency, the Subtone selected via Menu No. 57 (SUB.TONE) and Menu No. 58 (SUB.TONE) will be used; however, when transmitting using a memory channel, the Subtone stored in that channel will be transmitted.

■ **Selecting Subtone Frequency**

Some 10-meter FM repeaters use CTCSS (Continuous Tone Coded Squelch System) to prevent other repeaters on the same frequency from keying thus locking each other up. This repeater access system is also referred to as Tone or PL ("Private Line"). If CTCSS is used by a repeater in your area, set the Subtone frequency. The default is 88.5 Hz.

European Operation: In Europe, a 1750 Hz tone is generally used to access repeaters.

Select the Subtone frequency you require via Menu No. 57 (SUB.TONE). The available choices are shown in the table.

No.	Freq. (Hz)	No.	Freq. (Hz)	No.	Freq. (Hz)	No.	Freq. (Hz)
01	67.0	11	97.4	21	136.5	31	192.8
02	71.9	12	100.0	22	141.3	32	203.5
03	74.4	13	103.5	23	146.2	33	210.7
04	77.0	14	107.2	24	151.4	34	218.1
05	79.7	15	110.9	25	156.7	35	225.7
06	82.5	16	114.8	26	162.2	36	233.6
07	85.4	17	118.8	27	167.9	37	241.8
08	88.5	18	123.0	28	173.8	38	250.3
09	91.5	19	127.3	29	179.9	39	1750
10	94.8	20	131.8	30	186.2		

■ **Continuous or Burst Subtones?**

In addition to selecting the frequency of the Subtone, you must choose the correct Subtone duration. The Continuous selection sends the Subtone continuously as long as the transceiver is transmitting. The Burst selection sends a 500 ms Subtone burst each time the transceiver begins transmitting.

Select either Continuous or Burst via Menu No. 58 (SUB.TONE). The default is Continuous. This selection cannot be stored in a memory channel.

ARRL 10-METER BAND PLAN

Frequency Range (kHz)	Mode/Activity
28000~28070	CW
28070~28150	RTTY
28120~28189	Packet
28190~28300	Beacons
28300~29300 (29000~29200)	Phone (AM)
29300~29510	Satellite downlinks
29510~29590	Repeater inputs ¹
29600	FM simplex calling
29610~29700	Repeater outputs ¹

¹ Repeater frequency pairs (input/output):
29520/29620, 29540/29640, 29560/29660,
29580/29680

This completes the "FM TRANSMISSION" section. Refer to "OPERATING AIDS" beginning on page 44 for information about additional useful functions for operating.



6 COMMUNICATING

AM TRANSMISSION

Each mode used on the HF Amateur bands has its own advantages. Although long distance DX contacts may be less common while using AM, the superior audio quality characteristic of AM operation is one reason why some prefer this mode.

When looking for others using AM, check the following frequencies first:

- 3885, 7290, 14286, 21390, and 29000–29200 kHz

Refer, if necessary, to "OPERATING BASICS" beginning on page 19 for complete receiving details for any mode.

- 1 Select the operating frequency.
- 2 Press **[FM/AM]** to select AM mode.

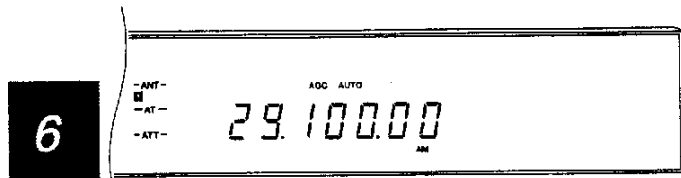

- 3 Select the ALC meter function by pressing **[METER]**.
- 4 Press and hold down the Microphone **[PTT]** switch, or press **[SEND]**.
 - The "ON AIR" indicator lights.
 - Refer to "VOX" {page 45} for information on automatic TX/RX switching.
- 5 Without speaking, adjust the **CAR** control so that the ALC meter just begins to indicate.
- 6 Speak into the microphone and adjust the **MIC** gain control so that only a few segments on the ALC meter light.
 - Speak in a normal tone and level of voice. Speaking too close to the microphone, or too loudly, may increase distortion and reduce intelligibility.
- 7 If you want to use speech processing, press **[PROC]** to switch on the Speech Processor and adjust as described on page 46.
- 8 Release the Microphone **[PTT]** switch, or press **[SEND]** again, to return to the receive mode.
 - The "ON AIR" indicator goes out.

This completes the "AM TRANSMISSION" section. Refer to "OPERATING AIDS" beginning on page 44 for information about additional useful functions for operating.

DIGITAL OPERATION

Since Multimode Communications Processors (MCP) have become popular, many Amateurs enjoy operating using a number of digital modes. The power and variety of Amateur radio increased greatly with the development of MCP that can use your TS-870S transceiver as the communications link.

For example, it's possible to take advantage of the camaraderie found on RTTY, then move to Packet to access an RBBS (Radio Bulletin Board System) to download a recent shareware program you've heard about, and then move again to AMTOR or PacTOR to deposit mail in a regional mailbox for forwarding. After that, you may switch to G-TOR™ or Clover for a lightning fast file transfer with a friend.

Consult ACCESSORY CONNECTIONS {pages 5~7} before proceeding if you need installation information. It is assumed here that you have all hardware, and software if necessary, already correctly installed.

RTTY (FREQUENCY SHIFT KEYING)

Important Menu items to be aware of before beginning to operate RTTY include the following:

- Menu No. 62 (FSK.SHFT): Selects 170, 200, 425, or 850 Hz shift. The 170 Hz shift default is used on the Amateur bands.
- Menu No. 63 (MARK.POL): Allows reversal of the key-down polarity between mark and space. The default is space (OFF).
- Menu No. 64 (FSK.TONE): Switches between a high tone (2125 Hz) and a low tone (1275 Hz). The default is 2125 Hz. The high tone is commonly used nowadays.

- 1 Select the operating frequency.
- 2 Press **[FSK/-R]** to select FSK mode.

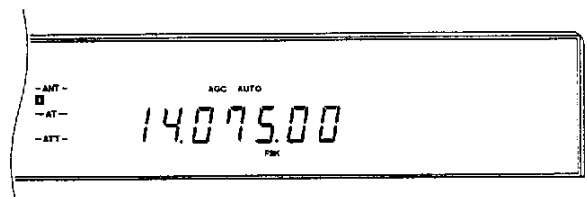

- 3 Select the ALC meter function by pressing **[METER]**.

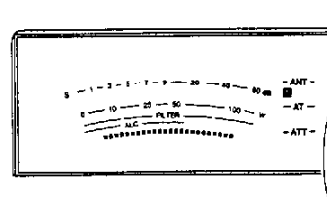

- 4 Following the instructions provided with your MCP or RTTY equipment, enter the key sequence at your RTTY keyboard to select the transmit mode.
 - The "ON AIR" indicator lights.
 - You may instead press **[SEND]** to manually select transmit.
- 5 Adjust the **CAR** control so that the meter reads in the ALC zone but doesn't exceed the upper ALC zone limit.
- 6 Begin sending data from the keyboard.
- 7 When finished transmitting, enter the key sequence from the RTTY keyboard to return to receive mode.
 - The "ON AIR" indicator goes out.
 - If you are manually switching between transmit and receive, press **[SEND]** to return to receive.
 - Use Menu No. 21 (PKT.OUT) to select the appropriate AF output level. The **AF** gain control cannot be used for this adjustment.

Traditionally, the lower sideband is used for FSK operation. Pressing **[FSK/-R]** reverses the transceiver to the upper sideband.

RTTY FREQUENCIES

IARU Region 1 (Europe/Africa) Frequency (kHz)	U. S. A./Canada Frequency (kHz)
1838~1842	1800~1840
3580~3620	3605~3645 (DX: 3590)
7035~7045	7080~7100 (DX: 7040)
10140~10150	10140~10150
14080~14099.5	14070~14099.5
18101~18109	18100~18110
21080~21120	21070~21100
24920~24929	24920~24930
28050~28150	28070~28150

ERROR-CHECKING MODES (AMTOR/ PACKET/ PACTOR/ G-TOR/ CLOVER

Due to their error-handling capability and speed of transmission, these modes are more efficient than earlier forms of digital communication by machine. In the case of G-TOR™, it was developed specifically to handle the adverse conditions of communicating across the solar system with spacecraft during their missions.

Mode	Meaning
AMTOR	AMateur Teleprinting Over Radio
Packet	Packetized data used per AX.25 protocol
PacTOR	Packet Teleprinting Over Radio
G-TOR™	Golay-coded Teleprinting Over Radio
Clover	Characteristic shape of an accurately tuned signal as viewed on a monitor.

On most HF bands, audio frequency shift keying (AFSK) is used. This method of modulation uses audio tones therefore either the LSB or USB mode should be selected. Traditionally, LSB is used similar to RTTY with the exception of AMTOR which is normally operated using USB.

In some countries, the licensing authorities permit F2 operation on some frequencies in the 10 meter band. For this type of operation, select the FM mode.

Note: When using the SSB mode for digital operation, use a fast AGC setting and switch OFF your Speech Processor. Also, take advantage of the different filter bandwidths available via Menu No. 19 (PKT.FIL). Remember to set Menu No. 19 to OFF for voice operation since the filters available are too narrow for voice.

- 1 Select the operating frequency.
- 2 Press **[LSB/USB]** to select upper or lower sideband mode.
 - For F2 operation, select the FM mode by pressing **[FM/AM]**. Switching Menu No. 59 (FM.BOOST) to ON may lower error rates for FM operation. The Menu No. 19 (PKT.FIL) filters for digital operation cannot be used when the FM mode is selected.
- 3 Select the ALC meter function by pressing **[METER]**.
- 4 Following the instructions provided with your TNC or MCP, enter the calibrate mode so you can generate a mark condition.
 - The "ON AIR" indicator lights.
- 5 Select the correct setting for Menu No. 20 (PKT.IN) so that the meter reads in the ALC zone but doesn't exceed the upper ALC zone limit.
- 6 Exit the calibrate mode.
 - The "ON AIR" indicator goes out.
- 7 Send commands and data.
 - The transceiver will briefly transmit each time it sends your commands and data, or when it acknowledges transmissions from other stations.
 - Use Menu No. 21 (PKT.OUT) to select the appropriate AF output level. The **AF** gain control cannot be used for this adjustment.

6 COMMUNICATING

Shown below are the data rates and types of modulation used for HF Packet operation:

Mode	Data Rate	Modulation Type
USB & LSB	300 bps (AFSK)	F1
USB & LSB	1200 bps (PSK)	F1
FM	1200 bps (AFSK)	F2

Note: In some countries, F2 modulation at 1200 bps may be used on the 10-meter band. Consult your national Amateur radio organization to obtain band plans that specify where in each band various modes are used.

PACKET FREQUENCIES

IARU Region 1 (Europe/Africa) Frequency (kHz)	U. S. A./Canada Frequency (kHz)
—	1800~1830
3590~3600	3620~3635
Digital band	7080~7100
Digital band	10140~10150
14089~14099, 14101~14112	14095~14099.5
Digital band	18105~18110
21100~21120	21090~21100
Digital band	—
28120~28150, 29200~29300	28120~28189

AMTOR activity can be found on or near 14075 and 3637.5 kHz. These would also be good starting places when searching for PacTOR, G-TOR™, or Clover stations.

This completes the "DIGITAL OPERATION" section. Refer to "OPERATING AIDS" beginning on page 44 for information about additional useful functions for operating.

SPLIT-FREQUENCY OPERATION

Split-frequency operation uses one VFO for the receive frequency and the other VFO for the transmit frequency. While operating "split", the VFOs switch automatically when you switch from receive to transmit and vice versa. This allows you to move either VFO frequency independently without affecting the other.

When a rare or desirable station is heard, he or she may immediately get many responses, all at the same time. It quickly becomes difficult to separate and identify both the original calling station (usually a DX station), and the many responding stations. This "DX pileup" is exciting, but it is also very inefficient and frustrating. Often the DX station is lost under the noise and confusion of many calling stations.

If things grow out of hand, it is the DX station's responsibility to take control by announcing that he will be "listening up 5 (kHz, from his present transmit frequency)", or "listening down between 5 and 10 (kHz)". This usually means the DX station will not change his transmit frequency, but will begin split operation in order to tune among the calling stations, pick out a call sign or two, and begin working those stations. Since, for the moment, the DX station is holding his transmit frequency, you should not change your receive frequency.

If you find that you are suddenly being called as that rare or desirable station, your ability to control the situation and complete contacts is much improved by "going to split". The following procedure explains how to operate split frequency on the TS-870S.

1 Press [RX A] or [RX B] or [RX M.CH].

- Your receive frequency will be the current frequency selected by VFO A, by VFO B, or by the current memory channel respectively.
- If you press [RX M.CH], then that memory channel must contain a split channel unless you select a VFO for the transmit frequency in the next step. See "MEMORY CHANNEL STORAGE, Split-frequency Channels" (page 55).

2 Press [TX A] or [TX B] or [TX M.CH].

- Your transmit frequency will be the current frequency selected by VFO A, by VFO B, or by the current memory channel respectively.

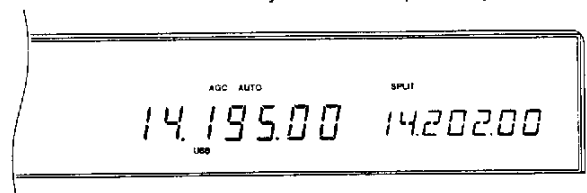

- If you pressed either [RX A] or [RX B] in Step 1, then you must select the other VFO in this step, or press [TX M.CH].
- When you recall a split memory channel to select a transmit frequency, the transmit frequency stored in that channel will be used.

TF-SET (TRANSMIT FREQUENCY SET)

[TF-SET] allows you to quickly check or adjust your transmit frequency without changing your receive frequency.

- 1 Press and hold [TF-SET].
 - Without changing your receive frequency, you are now receiving on your transmit frequency.
- 2 To select the transmit frequency that you want, turn the **Tuning** control, the **M.CH/VFO.CH** control, or press Mic [UP] or [DWN].
- 3 Release [TF-SET].
 - You are now receiving again on your original receive frequency.

Note: Switching ON Menu No. 10 (Δ FREQ) allows you to see the frequency difference between your transmit and receive frequencies when [TF-SET] is pressed.

Successfully contacting a DX station in a pileup often depends on making a well-timed call on a clear frequency. The best way to know if your intended transmit frequency is clear is to use [TF-SET]. Press [TF-SET] and listen. Had you transmitted at that moment, would you have transmitted simultaneously with other stations or the station that you are calling? After using [TF-SET] a couple of times in this manner, you will learn the rhythm of the DX station and the pileup. Use the information to select a relatively clear transmit frequency and to transmit at the exact instant when the DX station is listening but the majority of the group aren't transmitting. The more proficient you become at using this function, the more DX you will contact.

Note:

- ◆ If you press [FLOCK] before using [TF-SET], you will eliminate the risk of changing your receive frequency accidentally.
- ◆ [TF-SET] is disabled while transmitting.
- ◆ If you recalled a memory channel (excluding CH 99) for the transmit frequency, you must set Menu No. 49 (CH.SHIFT) to ON to use [TF-SET] to change the frequency of the memory channel. Furthermore, you can turn the **M.CH/VFO.CH** control, or press Mic [UP] or [DWN], to switch to a different memory channel.
- ◆ An RIT frequency shift is not added; however, an XIT frequency shift is added to the transmit frequency.
- ◆ [TF-SET] is also enabled while operating with the same TX/RX frequency (non-split).

SATELLITE OPERATION

Though not as common as VHF/UHF satellite operation, HF satellite operation is possible depending on which satellites are currently in orbit around the Earth. When HF propagation is poor, satellite operation can provide an incentive to get back on the air. Since this communications mode is so reliable, you may discover you actually prefer satellite operation over the hunt-and-miss method of communicating via the ionosphere.

An example of a Mode K satellite that has uplink and downlink frequencies that are both on HF is the Radio Sputnik 12 (RS-12). Launched in the early 1990s, this satellite is in a low Earth orbit and provides brief windows of opportunity for use as it passes quickly over your location. This satellite accepts SSB or CW signals on the 15 meter band and outputs them on 10 meters.

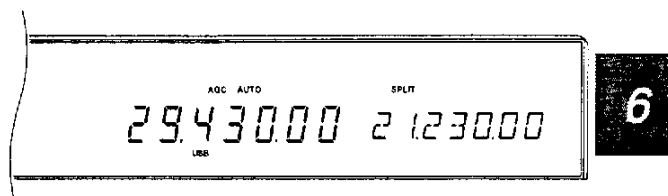

Contacts are possible on bands that might otherwise be vacant during low periods of the solar cycle. Your TS-870S can also be used with Mode A satellites, those that use a VHF uplink and an HF downlink, if you also have an SSB/CW VHF transceiver.

If you're interested in pursuing Mode K operation, contact AMSAT (Radio Amateur Satellite Corporation). This group of satellite operators, located all over the world, support the construction and operation of satellites. AMSAT can provide you with the latest information regarding Mode K and Mode A satellites that are currently in orbit.

OPERATING AIDS

RECEIVING

RIT (RECEIVE INCREMENTAL TUNING)

RIT provides the ability to change your receive frequency by ± 9.99 kHz in steps of 10 Hz without changing your transmit frequency. If the Fine Tuning (**[FINE]**) function is ON, the step size is 1 Hz. RIT works equally well with all modulation modes and while using VFO mode or Memory Recall mode.

It's a good habit to switch OFF the RIT function after a contact is finished. This returns the receive frequency to the transmit frequency. It ensures that you don't listen by mistake on a different frequency from your transmit frequency on the next contact. When using Memory Recall mode, RIT only functions with a memory channel containing stored data. Since an empty channel contains no receive frequency, RIT cannot function.

- 1 Press **[RIT]**.
 - "RIT" and the RIT frequency display appear.

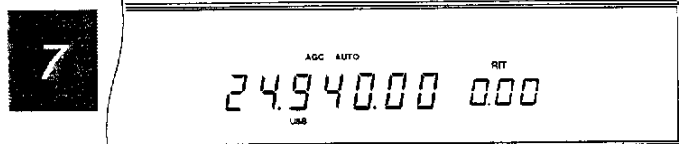

- 2 Press **[CLEAR]** to reset, if required, the RIT offset to 0.
- 3 Turn the **RIT/XIT** control to change your receive frequency.

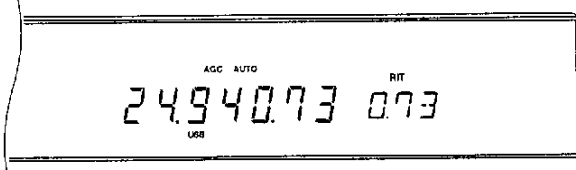

- 4 To cancel the RIT function, press **[RIT]**.

Note: The frequency shift set by the **RIT/XIT** control is also used by the **XIT** function.

AGC (AUTOMATIC GAIN CONTROL)

The AGC function selects the time constant for the automatic gain control circuit. Selecting a slow time constant will cause the receiver gain and S-meter readings to react slowly to large input changes. A fast time constant causes the receiver gain and the S-meter to react quickly to changes in the input signal. A fast AGC setting is particularly useful in the following situations:

- Tuning rapidly
- Receiving weak signals
- Receiving high-speed CW

The TS-870S will take charge of setting the AGC, using independent release times that you specify for each mode. Or, you can have total control by manually adjusting the AGC yourself from the Front Panel. When receiving strong signals in AM mode with the AGC OFF, the clipping action will make reception difficult or impossible.

To select whether you want Automatic or Manual control, use Menu No. 01 (AUT/MAN). Select OFF for Manual control and ON for Automatic control. The default is Manual (OFF).

■ Changing AGC

Automatic (Menu No. 01 (AUT/MAN) is ON):

The following Menu items are available to change the AGC release time in Automatic mode:

Mode	Menu No.	Selections	Default
SSB	02	OFF, 1 ~ 20	7
CW	03	OFF, 1 ~ 20	12
FSK	04	OFF, 1 ~ 20	14
AM	05	OFF, 1 ~ 20	5

Manual (Menu No. 01 (AUT/MAN) is OFF):

With Menu No. 01 (AUT/MAN) set to OFF, adjust the **AGC** control to set the AGC release time as you prefer.

- Turning the control clockwise selects a faster release time and counterclockwise selects a slower release time.
- To switch OFF the AGC completely, turn the **AGC** control fully counterclockwise.

■ Changing AF AGC

The TS-870S offers further control of your receiver AGC for the FM and AM modes. For these two modes, you may adjust the AGC release time and level in the AF stage.

Function	Menu No.	Selections	Default
AF AGC Release Time	06	0: Slow 1: Med 2: Fast	1: Med
AF AGC Level	07	0: OFF 1: Min 2: Med 3: High 4: Max	1: Min

TRANSMITTING

VOX (VOICE-OPERATED TRANSMIT)

VOX eliminates the necessity of manually switching to the transmit mode each time that you want to transmit. The transceiver automatically switches to transmit when the VOX circuitry senses that you have begun speaking into the microphone.

When using VOX, get into the habit of pausing between thoughts to let the transceiver drop back to receive briefly. You will then hear if anybody wants to interrupt, plus you will have a short period to gather your thoughts before speaking again. Your listener will appreciate your consideration as well as respect your more articulate conversation.

Press **[VOX]** to toggle the VOX function ON or OFF.

- "VOX" lights when the function is ON.

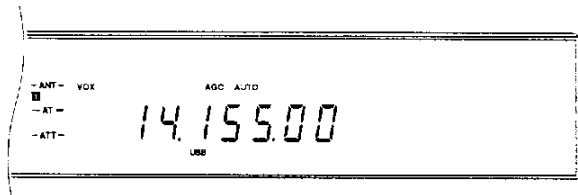

Microphone Input Level Adjustment

To enjoy the VOX mode, take time to set the gain of the VOX circuit to the correct level.

- 1 Select a voice mode, switch ON the VOX function, and begin speaking into your microphone using your normal level of voice.
- 2 Access Menu No. 28 (VOX.GAIN), then select different settings (default is 4) until the transceiver reliably switches to transmit each time you speak.
 - The best setting will allow the transceiver to switch between receive and transmit; however, background noises near your operating position should not falsely switch the transceiver.
 - This Menu item is configurable even if the VOX function is OFF or while you are transmitting.

Note: This transceiver does not have an ANTI-VOX control. DSP is able to automatically lower the input sensitivity for received audio that is output from the speaker.

Delay Time Adjustment

- 1 Select a voice mode, switch ON the VOX function, and begin speaking into your microphone using your normal level of voice.
- 2 Adjust the **DELAY** control so that the transceiver changes back to receive a brief time after you stop talking.
 - The **DELAY** control has a range from 150 ~ 2700 ms. Each step equals 10.6 ms.

Note: Setting the delay time by computer overrides any setting of the **DELAY** control. The control then has no effect. To restore functionality to the **DELAY** control, turn the control. The newly selected setting becomes effective.

TRANSMIT INHIBIT

Transmit Inhibit prevents the transceiver from being placed in the transmit mode. No signals can be transmitted if this function is ON. When the transceiver is inhibited from transmitting, the graduations on the PWR meter go out as a visual reminder.

- TX Inhibit OFF: Transmissions are possible.
- TX Inhibit ON: Transmissions are not possible.

Switch the function ON or OFF via Menu No. 27 (TX INH). The default is OFF.

7

XIT (TRANSMIT INCREMENTAL TUNING)

Similar to RIT, XIT provides the ability to change your transmit frequency by ± 9.99 kHz in steps of 10 Hz without changing your receive frequency. If the Fine Tuning (**[FINE]**) function is ON, the step size is 1 Hz.

- 1 Press **[XIT]**.
 - "XIT" and the XiT frequency display appear.

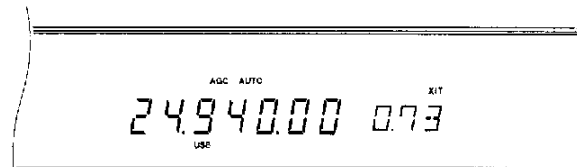

- 2 Press **[CLEAR]** to reset, if required, the XIT offset to 0.
- 3 Turn the **RIT/XIT** control to change your transmit frequency.

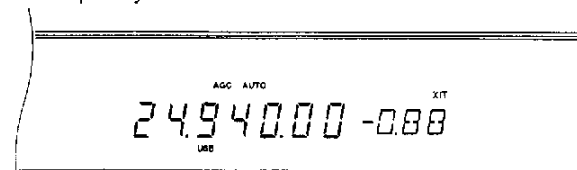

- 4 To cancel the XIT function, press **[XIT]**.

Note: The frequency shift set by the **RIT/XIT** control is also used by the **RIT** function. Therefore, changing or clearing the XIT frequency also affects the **RIT** frequency.

7 OPERATING AIDS

SPEECH PROCESSOR (SSB/AM)

The speech processor functions by leveling the large fluctuations in your voice when you speak. This leveling action effectively raises the average transmit output power resulting in a more understandable signal when operating using SSB or AM. You will notice that using the speech processor makes it easier to be heard by distant stations.

- 1 Select SSB or AM mode.
- 2 Select the preferred processor characteristics via Menu No. 25 (PROC.LOW) and Menu No. 26 (PROC.HI).
 - You can customize the low and high ranges of the speech envelope from -6 to +6 dB.

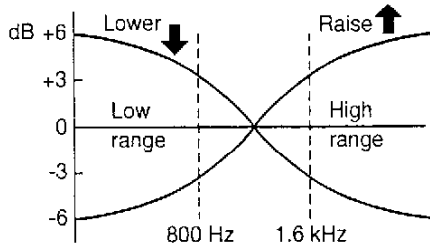

7

- 3 Press **[PROC]** to switch ON the processor.
 - "PROC" lights.

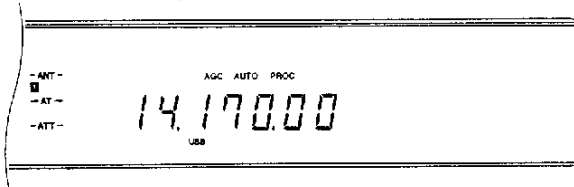

- 4 Press **[METER]** to select the COMP function.
- 5 While speaking at your normal voice level, adjust the **PROC** control for a level of 10 dB or less.
 - Using higher compression will not improve your signal clarity or apparent signal strength. Excessively compressed signals are more difficult to understand due to distortion and are less pleasant to hear than signals with less compression.

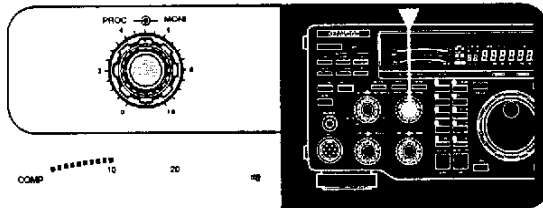

- 6 Press **[METER]** to select the ALC function.
- 7 The compression level affects the ALC setting for SSB; therefore, while continuing to speak into the microphone, adjust the **CAR** control for a reading within the ALC zone.
 - Keep the meter inside the ALC zone for the cleanest transmit signal and to avoid interfering with other stations on adjacent frequencies.

- 8 Press **[METER]** to select the COMP function to allow you to monitor the compression while transmitting.
- 9 To switch OFF the processor, press **[PROC]** again.
 - "PROC" goes out.

Note: Input audio that is controlled by the AGC will be clipped. Therefore, when mixing audio with the operator's voice, lower the **MIC** gain control as necessary.

CHANGING FREQUENCY WHILE TRANSMITTING

Moving your frequency while transmitting is usually an unwise practice due to the risk of interference to other stations. While transmitting, if you select a frequency outside the transmit frequency range, the transceiver is automatically forced to receive mode. If transmit was selected using the **[SEND]** key, transmission will not be resumed until you select a frequency inside the transmit frequency range, and you transmit again.

TRANSMIT MONITOR

The Transmit Monitor function allows you to hear your own transmitted signal.

Mode	Transmit Sampling Point
SSB	Unmixed AF
CW	Keyed output from DSP with sidetone OFF
FSK	AF corresponding to the shift and mark/space
AM	Unmixed AF
FM	Unmixed AF

Press **[MONI]** to toggle the Monitor function ON or OFF.

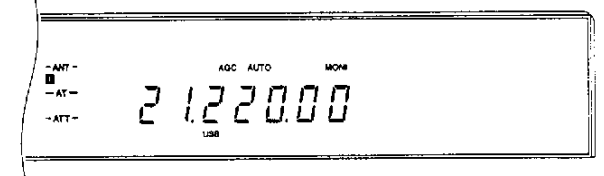

- To change the volume of the monitored audio, adjust the **MONI** control.

CUSTOMIZING TRANSMIT SIGNAL CHARACTERISTICS (SSB/AM)

The quality of your transmitted signal is important regardless which on-the-air activity you pursue. However, it's easy to be casual and overlook this fact since you don't listen to your own signal. The following sub-sections provide information that will help you tailor your transmitted signal.

■ Changing Transmit Bandwidth

Transmit bandwidth is modified via Menu No. 29 (TX.WIDTH). The available selections include:

- 1800, 2000, 2300, 2600, and 3000 Hz

The default is 2300 Hz. Consult the Bandwidth/ Bandshift Table for additional data. When the Speech Processor is switched ON, the bandwidth changes as shown in this table; however, displayed values do not change.

■ Transmit Bandshift

Transmit bandshift is modified via Menu No. 30 (TX.SHIFT). The available selections include:

- 0, 100, 200, 300, 400, and 500 Hz

The default is 300 Hz. Consult the Bandwidth/ Bandshift Table for additional data. When the Speech Processor is switched ON, the bandwidth changes as shown in this table; however, displayed values do not change.

■ Equalizing Transmit Audio

Press [TX EQ.] to toggle the transmit equalizer ON or OFF. To change transmit frequency characteristics, access Menu No. 31 (TX EQ.). The available selections include:

- High boost (H)
- Comb filter (C)
- Bass boost (B)

The default is High Boost.

■ Microphone AGC

While transmitting, Microphone AGC helps to prevent distortion due to overly high audio input. It is disabled while using CW or FSK.

Function	Menu No.	Selections	Default
Microphone AGC Release Time	22	0: Slow 1: Med 2: Fast	1: Med

BANDWIDTH/ BANDSHIFT TABLE

Speech Processor OFF			Speech Processor ON	
TX Bandshift Setting (Hz) (Menu No. 30)	TX Bandwidth Setting (kHz) (Menu No. 29)	Resulting Upper Cutoff Freq. (kHz)	New Lower Cutoff Freq. (Hz)	New Bandwidth (kHz)
0	1.8	1.8	200	1.6
	2.0	2.0		1.8
	2.3	2.3		2.1
	2.6	2.6		2.4
	3.0	3.0		2.6
100	1.8	1.9		1.7
	2.0	2.1		1.9
	2.3	2.4		2.2
	2.6	2.7		2.6
	3.0	3.1		2.6
200	1.8	2.0		1.8
	2.0	2.2		2.0
	2.3	2.5		2.3
	2.6	2.8		2.6
	3.0	3.2		2.6
300	1.8	2.1	300	1.8
	2.0	2.3		2.0
	2.3	2.6		2.3
	2.6	2.9		2.6
	3.0	3.3		2.6
400	1.8	2.2	400	1.8
	2.0	2.4		2.0
	2.3	2.7		2.3
	2.6	3.0		2.6
	3.0	3.4		2.6
500	1.8	2.3	500	1.8
	2.0	2.5		2.0
	2.3	2.8		2.3
	2.6	3.1		2.6
	3.0	3.5		2.6



7 OPERATING AIDS

AUTOMATIC MODE

Automatic Mode automatically selects the operating mode according to a set of frequency and mode data that you input. The purpose of Automatic Mode is for the transceiver to select the correct mode for you as you tune within a band. For Automatic Mode to work, you must first program the frequency/mode relationships that you want.

AUTOMATIC MODE BOUNDARIES

- The defaults for all boundaries are 30 MHz USB.
- Boundaries may only be changed (not deleted).
- The mode assigned to a boundary will be selected while operating on all frequencies below that boundary down to and including the next lower boundary.
- Each boundary is numbered. As the boundary numbers get larger, so must the boundary frequencies.

Example: If Boundary No. 09 is 14.100 MHz, then Boundary No. 10 must be a frequency larger by at least 10 kHz than 14.100 MHz. The lowest frequency that could be stored in Boundary No. 10 is 14.110 MHz. A lower frequency will not be accepted.

- Frequencies larger than the maximum receive frequency cannot be stored.
- There is a maximum of 19 boundary frequencies.
- Automatic Mode is always "OFF" in the range from the highest boundary to the maximum transceiver frequency.

Example: If 18 MHz CW is stored in Boundary No. 14, tuning to 18 MHz or higher selects USB since the boundary default of 30 MHz USB is stored in Boundary No. 15. Whereas, if 18 MHz CW is stored in Boundary No. 18 (highest boundary), tuning to a frequency lower than 18 MHz selects CW but tuning to 18 MHz or higher will not change the mode (still CW).

Use the following procedure to change a boundary.

1 Press [MENU]+ POWER ON.

- Boundary No. 00 appears.

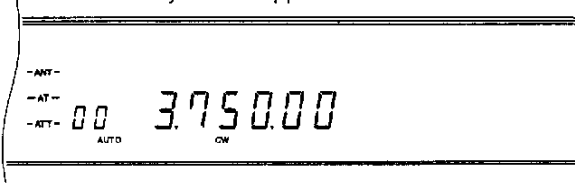

2 Turn the M.CH/VFO.CH control to select the boundary that you want to change.

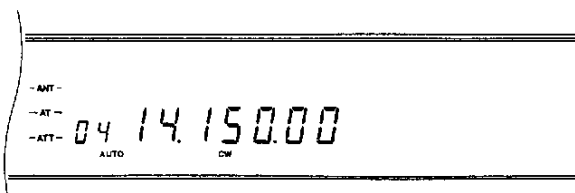

3 Press [ENTER], then enter the frequency via the keypad. Alternatively, you can enter the frequencies by using the **Tuning** control or Mic [UP]/[DOWN]. Pressing [UP] or [DOWN] on the Front Panel changes the frequency in 1 MHz steps.

- "--.-- 0.00" appears if [ENTER] is pressed.

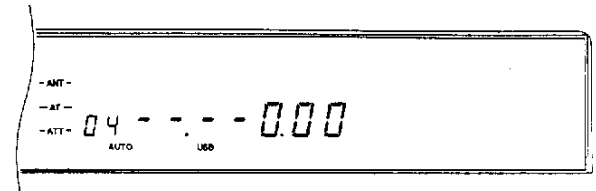

- The 10 kHz digit is the least significant that can be entered therefore boundaries must be multiples of 10 kHz.
- Four digits must be entered. However, if [ENTER] is pressed after beginning to enter digits, 0 is entered automatically for the remaining un-entered digits, and frequency entry is completed.
- If you enter a wrong digit, press [CLEAR], [ENTER] then re-enter the entire frequency.

4 Press [LSB/USB] or [CW/-R] or [FSK/-R] or [FM/AM] to select the mode for this boundary.

5 Repeat Steps 2 ~ 4 for each boundary that you want to change.

6 Press [CLR] to exit from this mode.

- Switching the power OFF before pressing [CLR] results in loss of the entered data.

USING AUTOMATIC MODE

Toggle Automatic Mode ON or OFF via Menu No. 34 (AUT.MODE). The default is OFF. When Automatic Mode is ON, you can always change the mode manually by pressing a Front Panel MODE button. An Automatic Mode boundary must be crossed for the mode to automatically change.

Automatic Mode does not work if you change bands by pressing [UP] or [DOWN]. Instead, the mode last used on the newly selected band will be recalled from the band memory. Switching ON the 1MHz Step function will allow Automatic Mode to work when using [UP] or [DOWN].

In SSB mode when Automatic Mode is OFF, the transceiver automatically selects LSB for frequencies lower than 9.5 MHz, and selects USB for 9.5 MHz or higher frequencies if the **Tuning** control or Mic [UP]/[DOWN] is used to cross the frequency of 9.5 MHz. This is also true if using the Front Panel [UP] or [DOWN] button. In all modes, the RIT or XIT frequency shift is not taken into account by Automatic Mode. Also, Automatic Mode will not function if a frequency is entered via the keypad on the Front Panel.

AUTOMATIC ANTENNA TUNER

You have the choice of using the internal tuner, an external AT-300 tuner, or both.

Note:

- ◆ The antenna tuners will not tune outside the authorized transmit limits of Amateur bands.
- ◆ If an external AT-300 tuner is connected, the internal tuner is bypassed when the ANT 1 connector is selected. The AT-300 cannot be used with the ANT 2 connector.
- ◆ When tuning in CW mode, the SWR meter may deflect upscale momentarily. This is not a fault.
- ◆ If using Full Break-in CW, the internal antenna tuner can be bypassed completely or can be in-line for both transmitting and receiving. Even when OFF is selected via Menu No. 08 (RX AT), received signals pass through the antenna tuner. To protect the antenna tuner relay, the tuner cannot be used only for transmitting.

PRESETTING (INTERNAL TUNER ONLY)

After each successful tuning session, the Preset function stores the data for the position of the tuning capacitors on each band. Then, if the frequency is changed while the internal tuner is switched ON, this function automatically positions the capacitors without need for retuning. After changing bands, the Preset function activates for the newly selected band.

A different set of data is stored for each of the 18 antenna tuner bands (see table) and for each antenna connector (ANT 1 and ANT 2). Therefore, enabling the other antenna connector by pressing the [ANT] button may also cause the Preset function to activate. If no Preset data exists for a particular band/antenna combination, then the default data for 50 Ω is stored.

Presetting does not activate while transmitting. For split-band operation, even if Menu No. 08 (RX AT) is ON, the antenna tuner is bypassed while receiving. Also, at all times, presetting is only done for transmit frequencies.

PRESET BANDS FOR INTERNAL TUNER

Band No.	Range (MHz)	Band No.	Range (MHz)
1	0.030 ~ 1.85	10	7.49 ~ 10.49
2	1.85 ~ 2.01	11	10.49 ~ 14.1
3	2.01 ~ 3.525	12	14.1 ~ 14.49
4	3.525 ~ 3.575	13	14.49 ~ 20.99
5	3.575 ~ 3.725	14	20.99 ~ 21.15
6	3.725 ~ 4.49	15	21.15 ~ 21.99
7	4.49 ~ 7.03	16	21.99 ~ 25.49
8	7.03 ~ 7.1	17	25.49 ~ 29
9	7.1 ~ 7.49	18	29 ~ 30

Note: The lower limit is inside the band in each case; the higher limit is inside the next higher band. For example, 14.1 MHz is in Band 12 whereas 14.49 MHz is in Band 13 (exception: 30 MHz is in Band 18).

INTERNAL TUNER

Note: Setting Menu No. 33 (TUN.WIDE) to OFF to select an SWR ≤ 1.2:1 reduces internal tuner losses. This setting is best.

1 Press [THRU/AUTO].

- “- AT - TX” lights. If Menu No. 08 (RX AT) is ON, then “- AT - TX RX” lights indicating that the tuner is in-line while transmitting and receiving. In this case, prior to tuning in Step 2, received signals are attenuated and the receiver sensitivity is lowered.

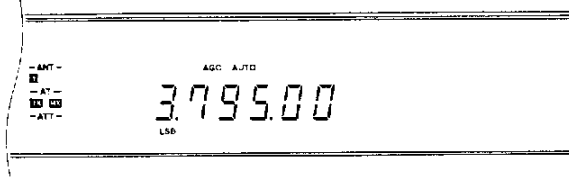

- If the tuner has not adjusted itself yet for the selected frequency, then AT TUNE lights, and Preset tuning begins. Signals pass through the antenna tuner during this time. If Menu No. 08 (RX AT) is OFF, the antenna tuner is bypassed. The AT TUNE light goes out when presetting is completed. You cannot transmit while presetting is in progress.

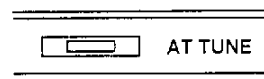

- If Preset data exists, the next step cannot be done until the transceiver completes the Preset tuning.

2 Press [AT TUNE].

- To cancel tuning for any reason, press [THRU/AUTO] or [AT TUNE].
- If the Preset tuning is aborted by pressing [AT TUNE], the new temporary data will be used, but this new data does not update the stored Preset data. Also, the new temporary data will be lost if the operating band is changed. Return to the stored Preset data by pressing [THRU/AUTO] OFF and then ON again.
- AT TUNE lights and stays lit while the tuner tunes. When the light goes out, the tuner has successfully matched the transceiver to the antenna system with an SWR less than the value set in Menu No. 33 (TUN.WIDE). You can begin operating.
- If tuning doesn't finish within about 20 sec, an alarm sounds. You may stop the alarm and the tuning by pressing [AT TUNE]. The alarm can be either a triple beep or the Morse code “CHECK” depending on the Menu No. 37 (WARN. BP) setting.
- After each successful tuning, the Preset data is updated.

Note:

- ◆ While receiving with Menu No. 08 (RX AT) ON on frequencies outside the Amateur bands, sensitivity is lowered.
- ◆ It's a good practice to press [AT TUNE] after changing bands to ensure the tuner has tuned for minimum SWR.



7 OPERATING AIDS

AT-300 EXTERNAL TUNER (OPTIONAL)

Note:

- ◆ The AT-300 must be connected while the transceiver power is switched OFF.
- ◆ There is a 4 A fuse inside the TS-870S for the AT-300 Antenna Tuner.

- 1 Press **[ANT]** to select Antenna 1.
- 2 Press **[THRU/AUTO]**.
 - This places the tuner in the bypass state until tuning begins in the next step. If tuning fails, the tuner returns to the bypass state.
 - **[AT TUNE]** is disabled if **[THRU/AUTO]** is not pressed.
- 3 Press **[AT TUNE]**.
 - When tuning completes successfully, the AT TUNE light goes out, and “- AT - TX RX” lights.

7

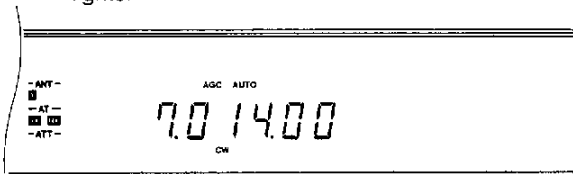

- If tuning doesn't finish within about 20 sec, an alarm sounds. You may stop the alarm and the tuning by pressing **[AT TUNE]**. The alarm can be either a triple beep or the Morse code “CHECK” depending on the Menu No. 37 (WARN. BP) setting.
- “RX” lights on the Display even if Menu No. 08 (RX AT) is OFF.
- Each time after changing frequency or after removing then restoring the power, you must press **[AT TUNE]** since there is no Preset data stored when using the external tuner.

COMPUTER ↔ TRANSCEIVER INTERFACE

The TS-870S interfaces easily with a computer. Computer interfaces on transceivers have encouraged the development of software applications by many companies.

Now available are electronic logbook applications that are partially self-completing. Information transferred between the transceiver and the computer is written into the logbook. These applications can automatically track awards and look up callbook information too.

Imagine using a mouse click to change your TS-870S to the correct DX frequency and mode of a DX station after the arrival of a report from your local DX packetcluster. Efficient operating technique is the key to winning in pileups and is essential when operating contests.

Other applications can change your computer into an electronic console from which you can remotely control functions on the TS-870S without physically touching its Front Panel. This capability makes possible remote operation of your transceiver from across the room,

from another room, or, when coupled with other commercially available products and where lawful, from another city via a telephone connection.

The list of applications is large and expanding, and is limited only by the imagination of software programmers. In short, the COM connector adds a new level of flexibility and opportunity to enjoy Amateur radio when a transceiver control application that supports the TS-870S and a computer are used.

Before using a computer for transceiver control, you should be aware of a few points. After you manually switch OFF the transceiver power, you can then switch ON the transceiver power using commands from the computer. Similarly, after switching OFF the power from the computer, it is then possible to switch ON the power from the Front Panel.

You can use the Front Panel controls while using computer control. Settings done from the Front Panel are effective immediately. After power is switched OFF from the computer, all values and settings per the Front Panel controls are restored.

COMMUNICATION PARAMETERS

In order to control the transceiver with your computer, you must first choose the communication parameters that you require. Configure your transceiver control application for 8 data bits and no parity. The communication speed and number of stop bits must match the settings in the TS-870S. The transceiver is configured via Menu No. 56 (COM.RATE). After changing Menu No. 56, the TS-870S must be switched OFF and then ON again for the new parameters to become effective. The defaults in the TS-870S are 9600 bps and 1 stop bit.

Menu No. 56 Setting	Baud Rate (bps)	Stop Bits
12 1	1200	1
24 1	2400	1
48 1	4800	1
48 2	4800	2
96 1	9600	1
192 1	19200	1
384 1	38400	1
576 1	57600	1

Note:

- ◆ Before connecting the TS-870S to a computer, switch OFF the power to the TS-870S and the computer.
- ◆ To reliably use the 38400 or 57600 bps transfer rates, the serial port of your computer must support these high-speed communications parameters.
- ◆ More information on controlling the TS-870S by a computer is included in Appendix D “COM CONNECTOR PROTOCOL” (page 83).

REJECTING INTERFERENCE

DSP TOOLS

SLOPE TUNING (SSB/AM)

Changing the positions of the **LO/WIDTH** and **HI/SHIFT** controls while in SSB or AM mode changes the cut-off frequencies for the receive pass band. Controlling the pass band in this way allows you to eliminate adjacent frequency interference.

Turn the **LO/WIDTH** control clockwise to raise the high-pass filter cut-off frequency; turn it counterclockwise to lower the cut-off frequency. This is effective in removing interference from frequencies lower than your current operating frequency.

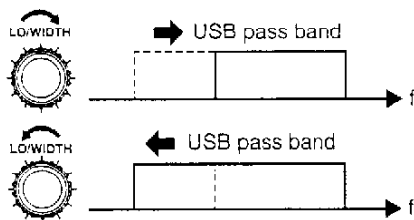

Turn the **HI/SHIFT** control clockwise to raise the low-pass filter cut-off frequency; turn it counterclockwise to lower the cut-off frequency. This is effective in removing interference from frequencies higher than your current operating frequency.

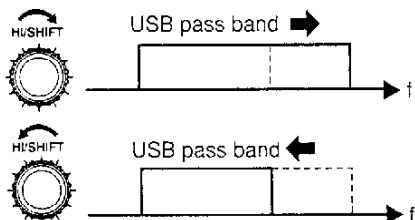

Using only these controls, you can eliminate a great deal of interference on the phone bands. By using both controls together carefully, you will increase your ability to pick out weak signals from the interference.

Adjust	Mode	Frequency Selections	Default Freq.
LO/WIDTH Control (high-pass filter cutoff)	SSB	0, 50, 100, 200, 300, 400, 500, 600, 800, 1000 Hz	300 Hz
	AM	0, 100, 200, 500 Hz	100 Hz
HI/SHIFT Control (low-pass filter cutoff)	SSB	1.4, 1.6, 1.8, 2.0, 2.2, 2.4, 2.6, 2.8, 3.0, 3.4, 4.6, 6.0 kHz	2.6 kHz
	AM	2.5, 3.0, 4.0, 5.0, 6.0, 7.0 kHz	6.0 kHz

IF SHIFT (CW)

For CW, the center frequency of the filter pass band can be shifted without changing the current receive frequency. This is an additional method of fighting adjacent frequency interference. Change the CW center frequency by adjusting the **HI/SHIFT** control. When the control is adjusted, "SHIFT" and the newly selected center frequency appears on the Display.

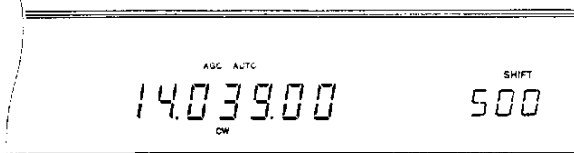

Be aware that shifting the CW center frequency does not automatically adjust the receive CW pitch. Therefore, it is possible to shift the CW pass band such that the selected CW pitch frequency falls outside the pass band. Doing this makes the CW signal inaudible.

Example:

Before adjusting IF Shift:

- CW pitch: 900 Hz
- IF Shift: 800 Hz (center frequency)
- CW Width: 600 Hz

In this example, the pass band would lie from 500 ~ 1100 Hz (from 300 Hz below the center frequency of 800 Hz to 300 Hz above the center frequency). If the CW pitch was set for 900 Hz, the signal would be audible.

After adjusting IF Shift:

- CW pitch: 900 Hz
- IF Shift: 500 Hz (center frequency)
- CW Width: 600 Hz

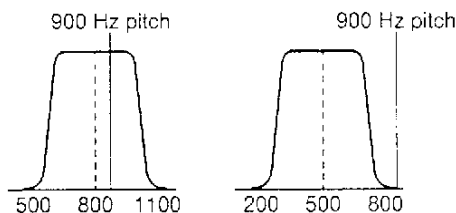

Now, the pass band would lie from 200 ~ 800 Hz. With the CW pitch set for 900 Hz, the signal would not be audible since the pitch frequency is 100 Hz above the upper edge of the pass band. In this case, to make the signal audible, lower the CW pitch frequency by at least 100 Hz.

Mode	Freq./ Filter Relationship	Frequency Selections (Hz)	Default Freq. (Hz)
CW	Center frequency	400, 450, 500, 550, 600, 650, 700, 750, 800, 850, 900, 950, 1000	800

8 REJECTING INTERFERENCE

CHANGING RECEIVE BANDWIDTH (CW/FSK/FM)

The width of the receive pass band can be changed without altering the current receive frequency. Change the bandwidth by adjusting the **LO/WIDTH** control. When the control is adjusted, "WIDTH" and the newly selected bandwidth appear on the Display.

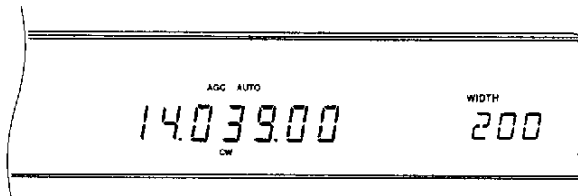

CW Bandwidth (Hz)	FSK Bandwidth (Hz)	FM Bandwidth (kHz)
50	250	5
100	500	6
200	1000	8
400	2000	10
600	3000	12

8

Default values

ADAPTIVE FILTERS

The Auto Notch, Beat Cancel, and Noise Reduction functions accomplish their design purposes by modifying the characteristics of adaptive filters. Adaptive filters adapt or change their characteristics according to the nature of the signal being received at a given moment. Menu No. 18 (TRACK) determines whether the adaptive filters are allowed to change in this manner or not.

It is also possible to specify how long the received signals will be monitored before determining filter characteristics. This monitor period is inversely proportional to the response time. The longer the monitor time, the slower the response time and vice versa. Use Menu No. 14 (LINE.ENH) to select a different Line Enhance response time, Menu No. 16 (SP.BEAT) for the Beat Cancel response time, and Menu No. 17 (SP.NOTCH) for the Auto Notch response time.

The adaptive filters may not function correctly with signals that have a poor signal-to-noise (S/N) ratio. Under poor conditions, you may find that optimum results are obtained by switching OFF the adaptive filters via Menu No. 18 (TRACK).

Note: Only Auto Notch, or Beat Cancel, or Noise Reduction can be used at one time. They cannot be activated at the same time. Also, Menu No. 18 changes to its default setting when the TS-870S power is switched OFF and then ON again.

AUTO NOTCH (SSB)

Auto Notch automatically locates and attenuates interfering tones within the receive pass band. This function operates digitally at the IF level, hence it can affect your S-meter reading, and may affect (slightly attenuate) your desired signal. If interfering tones are weak, you may find that Beat Cancel eliminates them more effectively. Also, Auto Notch may not notch out signals inside the pass band if signals just outside the pass band limits are stronger.

After switching ON the function, selecting a mode other than SSB will switch OFF the Auto Notch function (LED goes out). Changing back to SSB re-activates the function automatically (LED lights). If strong, steady interference is present, switching Menu No. 18 (TRACK) to OFF may improve the notching capability. To block CW interference, switch TRACK to ON, then switch TRACK to OFF to lock the adaptive filter.

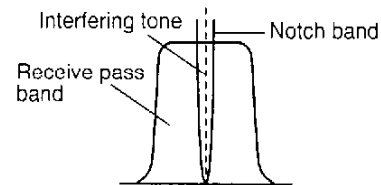

Press **[AUTO NOTCH]** to toggle the Auto Notch function ON or OFF.

- The LED indicator in the button lights when the function is ON.

Note: The effect of Auto Notch may differ under different receiving conditions even when using the same response time.

BEAT CANCEL (SSB/AM)

Beat Cancel also attenuates unwanted tones within the pass band, but it is more capable than Auto Notch at removing low-level tones. Also, this function works at the AF level, therefore you will notice there is no S-meter signal loss, although the S/N ratio may be lowered in the AM mode.

After switching ON the function, selecting a mode other than SSB or AM will switch OFF the Beat Cancel function (LED goes out). Changing back to SSB or AM re-activates the function automatically (LED lights).

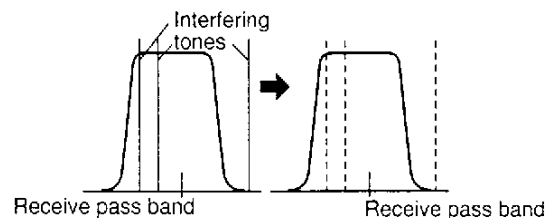

Press **[BEAT CANCEL]** to toggle the Beat Cancel function ON or OFF.

- The LED indicator in the button lights when the function is ON.

Note: The effect of Beat Cancel may differ under different receiving conditions even when using the same response time.

NOISE REDUCTION (SSB/CW/FSK/AM)

Menu No. 13 (LINE.ENH) determines whether the Line Enhance function (an adaptive filter) or the SPAC filter is used. When using the Line Enhance function, switch Menu No. 18 (TRACK) to ON. The SPAC filter works better for reducing noise and is effective for eliminating various types of noise. However, audio quality will deteriorate since only the audio portion is selected. This filter may induce pulse noises. One difference between the digital Line Enhance function and the conventional analog-based Noise Blanker is that the digital function works at audio frequencies whereas the blanker acts at IF.

Press **[N.R.]** to toggle the Noise Reduction function ON or OFF.

- The LED indicator in the button lights when the function is ON.
- When the S/N ratio is reasonably good in SSB, using Line Enhance will improve the S/N further. When receiving a CW signal with a poor S/N ratio, using SPAC will improve the S/N. For AM signals, received audio may become intermittent.

SETTING SPAC TIME

SPAC is a DSP term that literally means Speech Processing using Automatic Correlation. This is one method of digitally filtering out noise. Using Menu No. 15 (SPAC), select the correlation time that provides the highest quality reception for SSB. When receiving CW, choose the longest time that allows reliable reception. The longer the correlation time, the better the S/N.

NOISE BLANKER

The Noise Blanker was designed to reduce pulse noise such as that generated by automobile ignitions.

Press **[NB]** to toggle the Noise Blanker ON or OFF. To change the level of blanking, adjust the **NB** control. Always use the minimum necessary blanking. This reduces the chances of blanking your desired signal.

- “NB” lights when the function is ON.

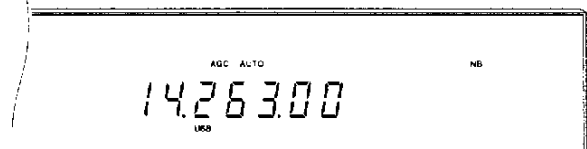

- When receiving a strong signal while the Noise Blanker is ON, receive audio may sound distorted. Eliminate the distortion by reducing the Noise Blanker level, or by switching OFF the function.

AIP (ADVANCED INTERCEPT POINT)

AIP helps eliminate interference and reduce audio distortion that is sometimes caused by the presence of strong signals. AIP is especially useful during

contest-type conditions, on an extremely crowded band, or when propagation is at a peak and all signals are local quality.

- Press **[AIP]** to toggle the AIP function ON or OFF.
- “AIP” lights when the function is ON.

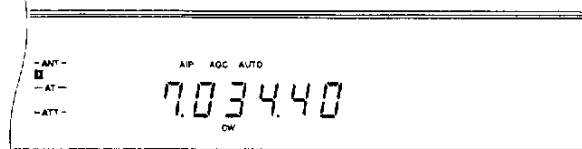

- By default, AIP switches ON for all frequencies below 7490 kHz. However, the status of AIP is stored independently for each AIP band. When a different AIP band is selected, the last setting (OFF/ON) used on that band is recalled.

Note: If you are concerned about precise S-meter readings, switch ON Menu No. 11 (AIP.GAIN) when using this function. AIP.GAIN does not change the S-meter sensitivity but, due to the increased gain, the noise level increases even while receiving no signals. AIP.GAIN does not work in FM or AM.

ATTENUATOR

The Attenuator prevents distortion by reducing the level of the receive signal. The function is also useful to reduce interference from adjacent frequencies.

Press **ATT [DOWN]** or **ATT [UP]** to select the desired attenuation.

- The selected attenuation (units of dB) lights (“- ATT - 6”, “- ATT - 12”, or “- ATT - 18”).

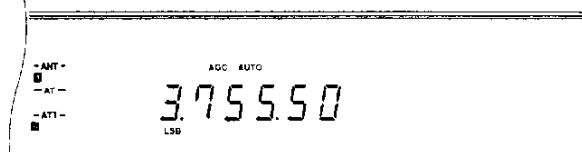

- The status of ATT is stored independently for each ATT band. When the ATT band is changed, the last setting used on the band is recalled.

Band No.	Frequency Range (MHz)	Default AIP Setting	Default ATT Setting
1	Lowest freq. ~ 2.49	ON	OFF
2	2.49 ~ 4.49	ON	OFF
3	4.49 ~ 7.49	ON	OFF
4	7.49 ~ 10.49	OFF	OFF
5	10.49 ~ 14.49	OFF	OFF
6	14.49 ~ 20.99	OFF	OFF
7	20.99 ~ 21.99	OFF	OFF
8	21.99 ~ 25.49	OFF	OFF
9	25.49 ~ 30	OFF	OFF

Note: The lower limit is inside the band in each case; the higher limit is inside the next higher band. For example, 4.49 MHz is in Band 3 whereas 7.49 MHz is in Band 4 (exception: 30 MHz is in Band 9).



MEMORY FEATURES

MICROPROCESSOR MEMORY BACKUP

This transceiver uses a lithium battery to retain the user-specified memory items. Switching OFF the power will not erase the Menu Setups or memory channels. Lithium battery life is approximately 5 years.

If you find the transceiver powers-up with default settings, and VFO and memory channel data is erased, have the lithium battery replaced. Contact an authorized **KENWOOD** Service Facility or dealer.

CONVENTIONAL OR QUICK MEMORY?

Memory channels allow you to save various operating parameters (receive frequency, operating mode, etc.) for recall at a later time. You can store this data in Conventional or Quick memory. Conventional memory is used for storing data that you may want to recall many times in the future during different operating sessions. For example, Conventional memory is useful to store the frequency where you regularly meet your club members.

However, Quick memory is meant for quickly saving data without needing to specify a particular memory channel. It's likely that you won't need this data during future operating sessions. For example, as you tune across the band looking for DX, it is convenient to store stations that you want to contact into Quick memory. You can quickly jump between several different Quick memory channels as you monitor them.

9

CONVENTIONAL MEMORY

MEMORY CHANNEL DATA

There are a total of 100 Conventional memory channels. The channels are numbered 00 ~ 99. Channels 00 ~ 98 have identical characteristics whereas channel 99 is reserved for programming VFO tuning ranges and scan ranges.

Channels 00 ~ 98 can store the following:

- Receive frequency and mode
- Transmit frequency and mode
- Subtone frequency
- Memory Lock Out (OFF/ON)

Note: The Subtone selected via Menu No. 57 (SUB.TONE) is automatically stored, but the stored Subtone can only be used if the TX and RX modes are FM.

Channel 99 can store the following:

- Frequency and mode (simplex only)
- Start frequency and mode
- End frequency
- Memory Lock Out (OFF/ON)

MEMORY CHANNEL STORAGE

Memory channels can be either simplex or split-frequency. Simplex channels use the stored frequency for receiving and transmitting. Split-frequency channels use a different frequency for transmitting and receiving. Also, even if RIT or XIT is ON with a frequency offset selected, this offset will not be added to the frequency when it is stored.

■ Simplex Channels

- 1 Press **[RX A]** or **[RX B]** to select simplex mode.
 - The indicators in the **[RX A]** and **[TX A]** buttons, or the indicators in the **[RX B]** and **[TX B]** buttons must be ON.
- 2 Select the frequency, mode, etc. to be stored.
- 3 Press **[M.IN]** to select Memory Scroll mode.

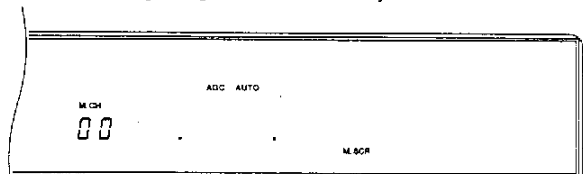

- To exit from Memory Scroll mode and abort the storage process, press **[CLR]**.

- 4 Turn the **M.CH/VFO.CH** control to select a memory channel.

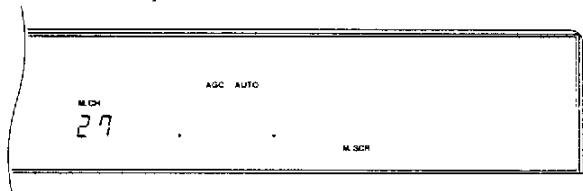

- 5 Press **[M.IN]** to store the frequency and associated data in the selected memory channel.
 - Pressing **[M.IN]** overwrites your new data on any previous data in that channel.

Split-Frequency Channels

- Using VFO A, select a receive frequency and mode.
- Using VFO B, select a transmit frequency and mode.
- Press **[RX A]**, **[TX B]** to select split-frequency mode.
 - The indicators in the **[RX A]** and **[TX B]** buttons must be ON.

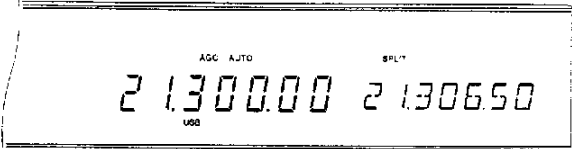

- Press **[M.IN]** to select Memory Scroll mode.

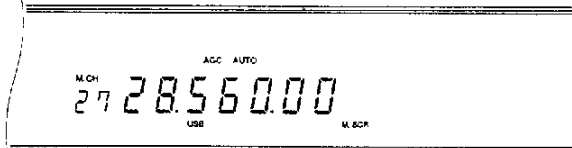

- To exit from Memory Scroll mode and abort the storage process, press **[CLR]**.
- Turn the **M.CH/VFO.CH** control to select a memory channel.

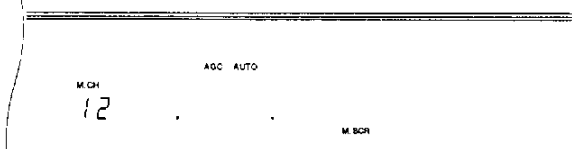

- Press **[M.IN]** to store the frequencies and associated data in the selected memory channel.
 - Pressing **[M.IN]** writes your new data on any previous data in that channel.

Note: If you prefer, you can store the transmit data in VFO A and the receive data in VFO B instead.

MEMORY CHANNEL RECALL

Once a frequency with associated data is stored in a memory channel, this procedure allows you to retrieve that frequency and data.

- Press **[RX M.CH]** to select Memory Recall mode.

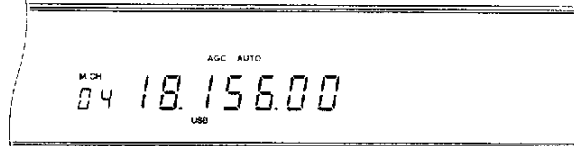

- Turn the **M.CH/VFO.CH** control, or press Mic **[UP]** or **[DWN]**, to select the memory channel that you want.
 - After ascending to the maximum memory channel number, continuing to step in the same direction returns you to the lowest channel in a circular manner. This is also true when descending through the channels.
 - Continuously holding down Mic **[UP]** or **[DWN]** steps the transceiver through the memory channels until the button is released.
 - You cannot change memory channels while transmitting.

Note: Memory channels can be changed while using the TF-SET function.

Quick Channel Search

When looking for a particular programmed memory channel, it is quicker to activate the search mode as explained below. This mode can also be used to search only for vacant (non-programmed) channels.



Programmed Channel Search:

While in Memory channel mode, press **[1MHz]** to toggle the search function ON or OFF.

- "MHz" lights when the function is ON. Now, only those channels that contain programmed data can be selected.
- Attempting to change channels when there are no programmed channels to select causes an alarm to sound. The current channel cannot be changed in this case.

Vacant Channel Search:

While in Memory Scroll mode (page 56), press **[1MHz]** to toggle the function ON or OFF.

- "MHz" lights when the function is ON. Only those channels that do not contain data can be selected.
- Attempting to change channels when there are no vacant channels to select causes an alarm to sound. The current channel cannot be changed in this case.

9 MEMORY FEATURES

Temporary Frequency Changes

After recalling a memory channel, it is possible to change the displayed frequency without altering the frequency that is actually stored in that memory channel. After changing the frequency, you could then store the new frequency in a memory channel if you wanted to save it for future use.

- 1 Set Menu No. 49 (CH.SHIFT) to ON.
- 2 Recall a memory channel.
- 3 Turn the **Tuning** control to select the frequency that you want.
 - You can change operating mode by pressing [LSB/USB], or [CW/-R], or [FSK/-R], or [FM/AM]. This is true whether Menu No. 49 (CH.SHIFT) is ON or OFF.

Note: Memory channels can be tuned in this manner while using the TF-SET function.

MEMORY CHANNEL SCROLL

Memory Scroll allows you to check memory channels without changing your current receive frequency. Only the display changes; the receiver doesn't alter its receive frequency. This function could be useful if, while monitoring a frequency, you wanted to consult the frequencies stored in your programmed memory channels.

- 1 Press [M.IN].
 - The memory channel that was last selected appears. This is the same channel that would be selected if [RX M.CH] were pressed.
- 2 Turn the **M.CH/VFO.CH** control, or press Mic [UP] or [DWN], to step through the memory channels.
- 3 To exit Memory Scroll, press [CLR], or [SEND], or Mic [PTT].
 - The transceiver re-displays the memory channel or VFO frequency that was selected before you activated Memory Scroll. This is true even if you scrolled through some memory channels.
 - Another way to exit is to close your CW key while the VOX function is ON.

9

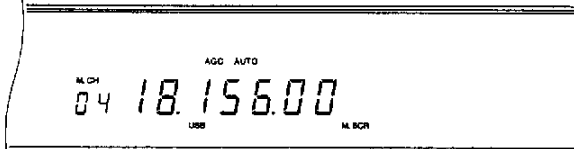

MEMORY TRANSFER

Memory → VFO Transfers

This function transfers the contents of the current memory channel to the currently selected VFO. A Tone frequency stored in a memory channel is not transferred to the VFO since the Tone is set via Menu No. 57 (SUB.TONE) when in VFO mode.

In Memory Recall mode, press [M>VFO].

Note: If a memory channel is recalled, then the recalled data is changed but not saved to the memory channel, pressing [M>VFO] transfers the new data to the VFO.

This table illustrates how memory channel data transfers to the VFOs and which VFOs are selected for receive and transmit after the transfer.

Simplex channels: Channel data

Split-frequency channels: RX data TX data

Type of Memory Channel	Before Pressing [M>VFO]		After Pressing [M>VFO]	
	RX	TX	RX	TX
Simplex channel	M.CH	M.CH	VFO A or B	VFO A or B
Simplex channel	M.CH	VFO A	VFO B	VFO A
Simplex channel	M.CH	VFO B	VFO A	VFO B
Simplex channel	VFO A	M.CH	VFO A	VFO B
Simplex channel	VFO B	M.CH	VFO B	VFO A
Split-frequency channel	M.CH		VFO A	
Split-frequency channel	M.CH	VFO A	VFO B	VFO A
Split-frequency channel	M.CH	VFO B	VFO A	VFO B
Split-frequency channel	VFO A		VFO A	
Split-frequency channel	VFO B		VFO B	

¹ Memory channel contents are transferred to the last receive VFO that was selected.

■ Channel to Channel Transfers

- 1 Press [RX M.CH] to select Memory Recall mode.

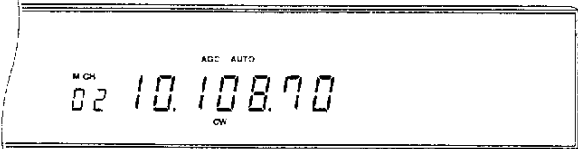

- 2 Select the memory channel that contains the data to be transferred.
- 3 Press [M.IN] to select Memory Scroll mode.

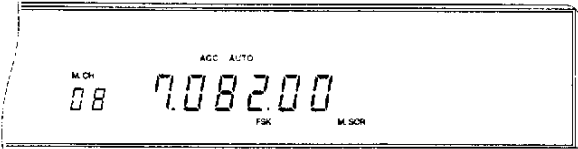

- 4 Select the destination memory channel.
- 5 Press [M.IN].

These tables illustrate how data is transferred between memory channels.

Channel 00 ~ 98	➔	Channel 00 ~ 98
RX frequency	➔	RX frequency
RX mode	➔	RX mode
TX frequency	➔	TX frequency
TX mode	➔	TX mode
Subtone frequency	➔	Subtone frequency
Channel lockout OFF/ON	➔	Channel lockout OFF

Channel 00 ~ 98	➔	Channel 99
RX frequency	➔	TX/RX frequency
		Start frequency
RX mode	➔	TX/RX mode
TX frequency	➔	End frequency
TX mode	➔	—
Subtone frequency	➔	—
Channel lockout OFF/ON	➔	Channel lockout OFF

Channel 99	➔	Channel 00 ~ 98
TX/RX frequency	➔	RX frequency
		TX frequency
TX mode	➔	RX mode
		TX mode
—	➔	Subtone frequency
Channel lockout OFF/ON	➔	Channel lockout OFF

Note:

- ◆ If a memory channel is recalled, then the recalled data is changed but not saved to the memory channel, pressing [M.IN] in Step 5 transfers the new data to the destination memory channel.
- ◆ In the FM mode, when channel 99 is copied to another memory channel (00 ~ 98), a Tone frequency of 88.5 Hz is stored automatically in the destination channel.

ERASING MEMORY CHANNELS

This procedure erases all data from the selected memory channel

- 1 Press [RX M.CH] to select Memory Recall mode.

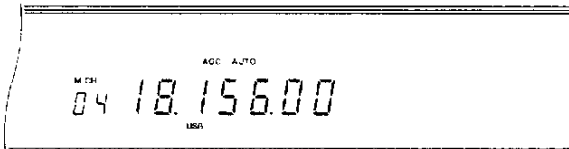

- 2 Select the memory channel that contains the data that you want to erase.
- 3 Press [CLR] for approximately two seconds.
 - A beep sounds to confirm that the channel data is erased.

■ Full Reset

Do a Full Reset if you want to erase all data in all memory channels or if a Partial Reset {page 63} does not correct a problem. Remember that a Full Reset requires that you re-enter any memory channel data again after the initialization if you want to use those channels. A Full Reset also initializes all electronic keyer settings to their default values.

Press [A=B]+ POWER ON.

9 MEMORY FEATURES

STORING SCAN LIMITS IN CH 99

Although the Scan function is discussed fully in the next chapter, here you will learn how to store the frequency limits that must be saved first before Scan can be used.

- 1 Select the Start frequency limit and mode using VFO A.

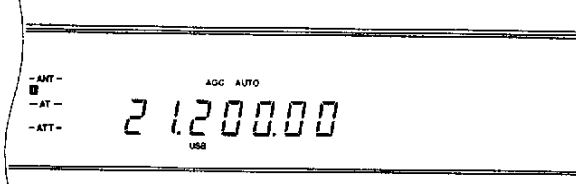

- This frequency can also be used for receiving and transmitting after completion of this procedure.

- 2 Select the End frequency limit using VFO B.

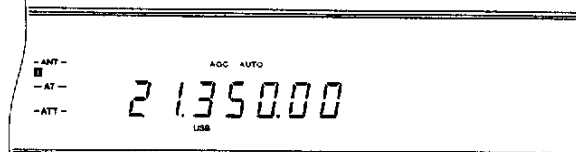

- 3 Press [RX A].
- 4 Press [M.IN] to select the Memory Scroll mode.

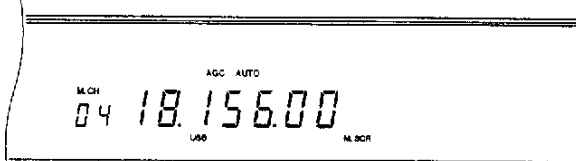

9

- To exit from Memory Scroll mode and abort the storage process, press [CLR].

- 5 Turn the M.CH/VFO.CH control to select channel 99.

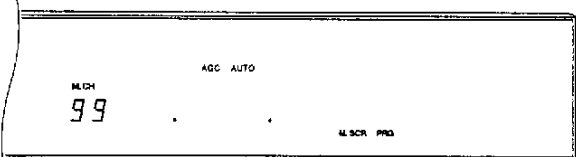

- 6 Press [M.IN] to store the frequency limits.
 - Pressing [M.IN] overwrites new data on any previous data in that channel.

Note: On some General market versions, the frequency limits must be on the same band or they cannot be stored.

■ Confirming Start/End Frequencies

The following allows you to check the programmed Start and End frequencies.

- 1 Press [RX M.CH] to select Memory Recall mode.

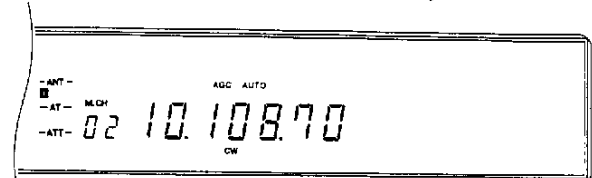

- 2 Turn the M.CH/VFO.CH control to select channel 99.

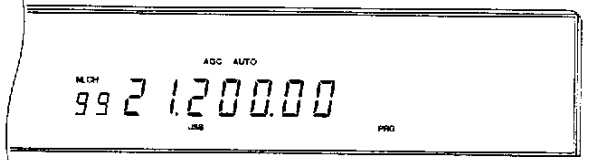

- 3 Press [DOWN] to check the Start frequency and press [UP] to check the End frequency.

■ Programmable VFO Function

This function restricts the range of the Tuning control to those frequencies included by the Start and End frequencies that were programmed above. One application of this function is to keep your operating within the authorized frequency limits of your license.

- 1 Press [RX M.CH] to select Memory Recall mode.



- 2 Turn the M.CH/VFO.CH control to select channel 99.

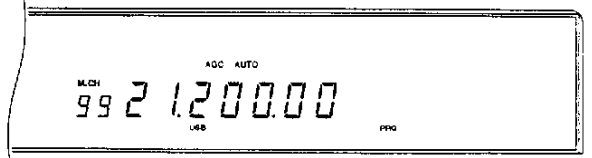

- 3 Turn the Tuning control and you will notice that you can only tune from the Start frequency to the End frequency. After reaching the End frequency, the transceiver reverts back to the Start frequency again.

QUICK MEMORY

Quick memory stores a maximum of five frequencies in a stack arrangement. As each new frequency is stored, all previously stored frequencies are bumped to their next respective Quick memory channel.

When all five channels contain frequencies, storing one more frequency then bumps all frequencies to the next channel and the frequency in Quick memory channel 5 is bumped off the stack and erased. Due to the stack configuration, it is not necessary to specify a memory channel when you save a frequency to Quick memory.

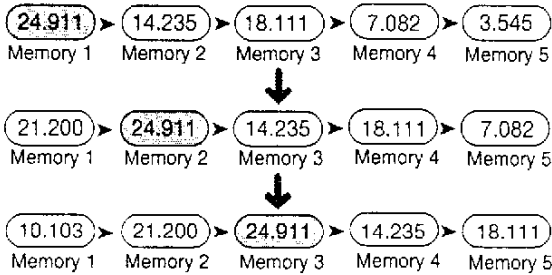

Quick memory can only be programmed or accessed if the VFOs are selected for transmitting and receiving. That is, Conventional memory channels cannot be used simultaneously with Quick memory channels.

STORING INTO QUICK MEMORY

Press QUICK MEMO [M.IN] while in VFO mode.

- Each time [M.IN] is pressed, the current VFO data is written to Quick memory.
- Quick memory channels can store the same types of data as Conventional memory channels 00 ~ 98.

RECALLING FROM QUICK MEMORY

1 Press QUICK MEMO [MR].

- The current Quick memory channel number appears.

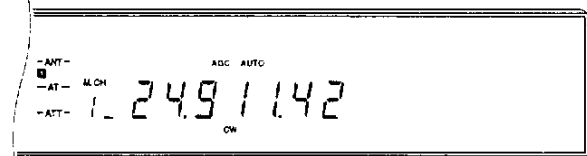

- If there is no data stored in any Quick memory channels, then this step will not access Quick memory.

2 Turn the **M.CH/VFO.CH** control to select the Quick memory channel (1 ~ 5) that you want.

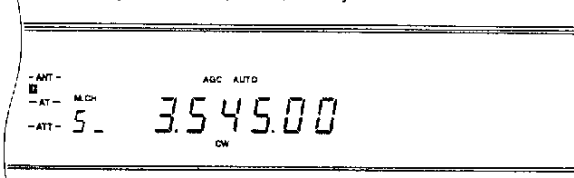

3 To exit, press QUICK MEMO [MR].

TEMPORARY FREQUENCY CHANGES

1 Press QUICK MEMO [MR].

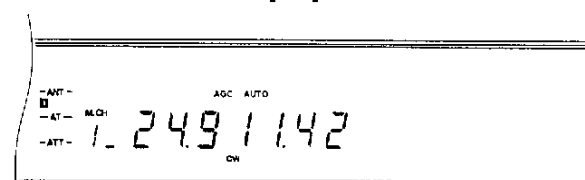

2 Turn the **M.CH/VFO.CH** control to select the Quick memory channel (1 ~ 5) that you want.

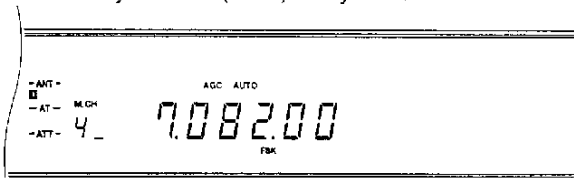

3 Turn the **Tuning** control to change the frequency.

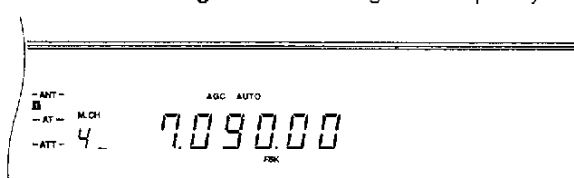

- You can change operating mode by pressing [LSB/USB], or [CW/-R], or [FSK/-R], or [FM/AM].
- It is possible to change the frequency then press QUICK MEMO [M.IN] to store the new frequency in the same Quick memory channel. This action bumps the old frequency to the next higher Quick memory channel in the stack, etc., but does not affect the Quick memory channels that are lower than the current channel.

4 To exit, press QUICK MEMO [MR].

Note: Quick memory channels can be tuned in this manner while using the TF-SET function.

QUICK MEMORY → VFO

The current Quick memory channel contents, including the frequency data plus VFO "A" and/or "B" status, are transferred to the VFO(s) by this function.

In Quick Memory Recall mode, press [M>VFO].

Note: If a Quick memory channel is recalled, then you change the recalled data, pressing [M>VFO] transfers the new data to the VFO.



Scan is a useful feature for hands-off monitoring of your favorite frequencies. After becoming comfortable with how to use all types of Scan, the monitoring flexibility gained will increase your operating efficiency.

This transceiver provides the following types of Scan:

Scan Type		Purpose
Program Scan		General update of activity on the entire band or a sub-section of the band while in VFO mode.
Memory Scan	All-channel Scan	Quick activity update of all programmed Conventional memory channels.
	Group Scan	Quick activity update of a selected group of Conventional memory channels.

PROGRAM SCAN

The Program Scan function scans the range between the Start frequency and End frequency stored in memory channel 99. If Program Scan is used before you store a Start and an End frequency, then the lower and upper frequency limits of the transceiver are automatically stored for the Start and End frequencies respectively. Some General market versions substitute the lower and upper frequencies for the current band in place of the frequency limits of the transceiver.

Program Scan direction is controlled by the Start and End frequency relationship. The following table summarizes the way that Program Scan functions:

10

Start/End Frequency Relationship	Current Frequency	Program Scan Action
Start frequency LOWER THAN End frequency	Within Scan range	Up
	Lower or higher than Scan range	Jumps to Start frequency, then scans up.
Start frequency EQUAL TO End frequency	Start/End frequency	Monitors Start/End frequency.
	Lower or higher than Start/End frequency	Jumps to Start/End frequency and monitors it.
Start frequency HIGHER THAN End frequency	Within Scan range	Down
	Lower or higher than Scan range	Jumps to Start frequency, then scans down.

For a refresher on how to store the Program Scan Limits, refer to "STORING SCAN LIMITS IN CH 99" (page 58). The following are additional important points regarding the Program Scan function:

- Starting a transmission by closing the CW key, by sending a packet, or by triggering the VOX circuit by voice or the DRU-3 Digital Recording Unit stops Program Scan; however, transmission does not begin immediately.
- When the Program Scan range is smaller than a single step of the **M.CH/VFO.CH** control, turning this control causes Scan to jump to the lower of the Start/End frequencies, then continue scanning.
- Starting the Program Scan function switches OFF the RIT and XIT functions. RIT and XIT are not switched ON again when Program Scan stops, and the RIT/XIT offset frequency is not cleared.
- Operating mode can be changed while scanning.
- If Automatic Mode is switched ON, it will function with the Program Scan function.

Use the following procedure to activate Program Scan.

- Select the VFO mode using VFO A or VFO B.
- Press **[SCAN]**.
- To stop scanning, press **[SCAN]**, or **[CLR]**, or **[SEND]**, or Mic **[PTT]**.

SCAN HOLD

While using Program Scan, if Menu No. 65 (PG.S.HOLD) is switched ON, then turning the **Tuning** or **M.CH/VFO.CH** control stops the transceiver from scanning for approximately five seconds. This is also true if Mic **[UP]** or **[DOWN]** is pressed. Program Scan resumes after the five second pause. The default is OFF.

CONFIRMING START/END LIMITS

- Recall memory channel 99.
- Press **[DOWN]** to check the Start frequency and press **[UP]** to check the End frequency.

MEMORY SCAN

Memory Scan scans all memory channels containing data (All-channel Scan) or only a group of channels specified by you (Group Scan). This type of scan always ascends up through the channel numbers; the direction of scan cannot be changed. While scanning, if you want to skip over some programmed channels, turn the **M.CH/VFO.CH** control. Pressing Mic **[UP]** or **[DWN]** will also skip over channels but only during All-channel Scan.

All-channel Scan or Group Scan can be selected via Menu No. 66 (GRP.SCAN). The default is All-channel Scan (OFF).

The following are additional important points regarding the Memory Scan function:

- Starting a transmission by closing the CW key, by sending a packet, or by triggering the VOX circuit by voice or the DRU-3 Digital Recording Unit stops Memory Scan; however, transmission does not begin immediately.
- Starting the Memory Scan function switches OFF the RIT and XIT functions. RIT and XIT are not switched ON again when Memory Scan stops, and the RIT/XIT offset frequency is not cleared.
- Attempting to use Memory Scan when no data has been programmed in any memory channels, or when all channels are locked out, causes an alarm. Scan will not start.
- To scan channel 99, cancel Memory Channel Lockout {page 62} for that channel.

Note: Remember to adjust the squelch threshold level {page 19} before using Memory Scan.

BUSY FREQUENCY STOP

The transceiver automatically stops Memory scanning when a signal is detected if Busy Frequency Stop is ON. The transceiver remains on the same channel for either a short time or until the signal drops depending on which Scan Resume method is selected (see below). The squelch must be adjusted to the noise threshold point with no signals present for Busy Frequency Stop to work.

Toggle Busy Frequency Stop OFF or ON via Menu No. 67 (BSY.STOP). The default is ON.

Note: Busy Frequency Stop cannot be used with Program Scan.

■ Scan Resume Methods

Scan Resume controls when the transceiver continues Memory scanning after stopping due to a busy channel. Neither of the following two modes function if Menu No. 67 (BSY.STOP) is switched OFF. These modes cannot be used with Program Scan.

Time-operated mode: After stopping, Scan checks the busy channel approximately three seconds later. If the channel is still busy, Scan waits another three seconds then resumes scanning. If the channel is not busy three seconds after stopping, Scan resumes immediately.

Carrier-operated mode: Scan resumes approximately two seconds after the signal drops.

Select your preferred Scan Resume method via Menu No. 68 (CAR.SCAN). The default is Time-operated (OFF).

ALL-CHANNEL SCAN

The All-channel Scan function scans all memory channels containing frequency data.

- 1 Recall a Conventional memory channel.
- 2 Switch OFF Menu No. 66 (GRP.SCAN).
- 3 Adjust the **SQL** control while no signal is present.
 - The squelch must be closed before scanning starts.
- 4 Press **[SCAN]** to start scanning.
- 5 To stop scanning, press **[SCAN]**, or **[CLR]**, or **[SEND]**, or Mic **[PTT]**.



10 SCAN

GROUP SCAN

For the purpose of Group Scan, the 100 Conventional memory channels are divided into 10 groups each containing 10 channels. The channels are grouped as follows:

- 00 ~ 09, 10 ~ 19, 20 ~ 29, 90 ~ 99

The transceiver only scans memory channels that belong to the specified group and contain frequency data.

- 1 Recall a Conventional memory channel.
- 2 Switch ON Menu No. 66 (GRP.SCAN).
- 3 Press Mic **[UP]** or **[DWN]** to select any memory channel belonging to the channel group that you want to scan.
 - Select the correct group before starting to scan; you cannot change groups while scanning.
- 4 Adjust the **SQL** control while no signal is present.
 - The squelch must be closed before scanning starts.
- 5 Press **[SCAN]** to start scanning.
- 6 To stop scanning, press **[SCAN]**, or **[CLR]**, or **[SEND]**, or Mic **[PTT]**.

MEMORY CHANNEL LOCKOUT

Memory channels that you prefer not to monitor while scanning can be locked out. Lock out any memory channel with the following procedure.

- 1 Press **[RX M.CH]** to select Memory Recall.
- 2 Select the memory channel to be locked out.
- 3 Press **[CLR]**.
 - Release **[CLR]** immediately since pressing it for more than about 2 seconds erases the contents of the memory channel.
 - A dot lights beside the right-most digit of the memory channel number to indicate the channel has been locked out.

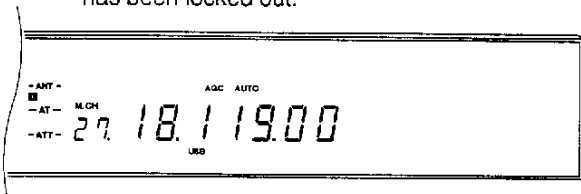

- Repeatedly pressing **[CLR]** adds and removes the channel from the scan list.

SETTING SCAN SPEED

Scan speed can be changed through 9 steps using the **RIT/XIT** control. A weight value of the form "Pn" appears on the Display during Scan. "n" is a number from 1 to 9 that acts as a speed reference number. Turning the **RIT/XIT** control clockwise decreases the scan speed, and counterclockwise increases the speed. The Program Scan and Memory Scan speeds can be independently set as explained below.

The table below shows the time required for one frequency step (Program Scan) or one memory channel step (Memory Scan). For Memory Scan, if Menu No. 67 (BSY.STOP) is ON, the weight value is locked at 1. However, if Menu No. 67 is OFF, the stop time on each channel is as shown below.

Weight Value (Pn)	Program Scan (sec/ 10 kHz)	Memory Scan ¹ (sec/ channel)
n=01	8	0.4
n=02	13	1.8
n=03	21.3	3.2
n=04	34.7	4.6
n=05	56.6	6.0
n=06	92.2	7.5
n=07	150.4	9.0
n=08	245.3	10.5
n=09	400	12.0

¹ MENU No. 67 is OFF

Program Scan:

While scanning, turn the **RIT/XIT** control to select the desired weight value.

Memory Scan:

- 1 Select OFF for Menu No. 67 (BSY.STOP).
- 2 Press **[SCAN]** to start the Memory Scan function.
- 3 Turn the **RIT/XIT** control to select the desired weight value.

OPERATOR CONVENIENCES

MICROPROCESSOR RESET

If your transceiver seems to be malfunctioning, initializing the microprocessor and its memory may resolve the problem.

INITIAL SETTINGS

These are the factory default settings for each VFO and the memory channels:

Method of Frequency Selection	Frequency (MHz)	Modulation Mode
VFO A	14.000.00	USB
VFO B	14.000.00	USB
Memory Channels (00 ~ 99)	.	—

PARTIAL RESET

Do a partial reset if a button or control does not function according to the instructions in this manual. The following are not erased by a Partial Reset:

- Memory channel data
- Menu settings
- Antenna tuner preset data
- ANT1/ANT2 data
- Automatic Mode frequency ranges
- Electronic keyer settings

Press **[RX A]+ POWER ON** to do a Partial Reset. "HELLO" appears on the Display.

FULL RESET

Do a Full Reset if you want to erase all data in all memory channels and reset all parameters to factory defaults. After a Full Reset, you must re-enter memory channel data if you want to use those channels. On the other hand, a Full Reset is a quick way to return all transceiver parameters back to their factory settings (including all electronic keyer settings).

Press **[A=B]+ POWER ON** to do a Full Reset.

- "HELLO" appears on the Display and all parameters are reset.

SWITCHING ANT 1/ ANT 2

The antenna that you use for transmission/reception with the TS-870S can be selected via the **[ANT]** button on the Front Panel. There are two choices: ANT 1 and ANT 2. ANT 1 selects the antenna connected to the ANT 1 connector on the Rear Panel; ANT 2 selects the ANT 2 connector. Selecting one of the antenna positions will automatically store that selection for that band. Each time you select the same band in the future, the same antenna will be selected.

BANDS FOR ANT 1/ ANT 2 SELECTION

Band No.	Range (MHz)	Band No.	Range (MHz)
1	0.030 ~ 1.85	10	7.49 ~ 10.49
2	1.85 ~ 2.01	11	10.49 ~ 14.1
3	2.01 ~ 3.525	12	14.1 ~ 14.49
4	3.525 ~ 3.575	13	14.49 ~ 20.99
5	3.575 ~ 3.725	14	20.99 ~ 21.15
6	3.725 ~ 4.49	15	21.15 ~ 21.99
7	4.49 ~ 7.03	16	21.99 ~ 25.49
8	7.03 ~ 7.1	17	25.49 ~ 29
9	7.1 ~ 7.49	18	29 ~ 30

Note: The lower limit is inside the band in each case; the higher limit is inside the next higher band. For example, 14.1 MHz is in Band 12 whereas 14.49 MHz is in Band 13 (exception: 30 MHz is in Band 18).

Connect an AT-300 external antenna tuner only to the ANT 1 connector. After connecting this tuner correctly, the internal tuner will always be bypassed when ANT 1 is selected.

PROGRAMMABLE FUNCTION BUTTONS

The Programmable Function provides a method for customizing the functions of four Front Panel buttons handy located around the **Tuning** control. If your operating habits or activities change, you can also easily change the functions that you assign.

This function gives you the capability to assign any of the functions from Menu Nos. 00 ~ 68 to certain buttons on the Front Panel. The programmable buttons are labeled ENTER, TF-SET, 1MHz, and FINE. Or you can assign functions (Nos. 69 ~ 73) to these buttons. If you want to keep the Front Panel as simple as possible, you can assign OFF to each button in which case the buttons will have no function.

Although the four buttons are automatically assigned with the labeled functions by default, you may prefer to re-assign these buttons, for example, with four of the DSP functions (Menu Nos. 13 ~ 18). This would allow you to experiment and learn how the different DSP settings affect received signals. Or, you could assign some of the AGC functions (Menu Nos. 01 ~ 07). Then you could make quick AGC changes, and choose the optimum settings to best match receive conditions.

There is a great deal of flexibility available with this function. Think about your operating priorities, then start assigning.



11 OPERATOR CONVENIENCES

ASSIGNING FUNCTIONS

- 1 Press [MENU].
- 2 Turn the **M.CH/VFO.CH** control to select Menu No. 45, 46, 47, or 48.
- 3 Press [UP], or [DOWN], or Mic [UP], or Mic [DWN] to change the current selection for this Menu item.

Menu/ Function No.	Function	Page Ref.
OFF	No function assigned	—
00 ~ 68	See "MENU CONFIGURATION"	25
69	ENTER	22
70	TF-SET	43
71	1MHz	20
72	FINE	21
73	VOICE	68

- 4 Press [MENU] or [CLR] to exit from Menu mode.
 - If the power is switched OFF before this step is completed, the selection just made will be canceled.

USING THE PROGRAMMED BUTTONS

Press one of the buttons labeled ENTER, TF-SET, 1MHz, or FINE.

- The assigned function activates.

Note: After a Partial or Full Reset, the settings of the PF keys are reset to default values.

LOCK FUNCTION

11

The Lock function disables some buttons to prevent you from accidentally activating a function or disturbing current settings.

Press [F.LOCK] to toggle the Lock function ON or OFF.

- "F.LOCK" lights when the Lock function is ON.

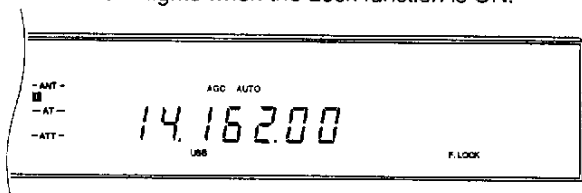

The following buttons and controls are NOT affected by activating the Lock function:

Buttons NOT Locked	Controls NOT Locked
[ANT]	AF
ATT [DOWN]	AGC
ATT [UP]	CAR
[AIP]	DELAY
[AT TUNE]	KEY SPEED
[AUTO NOTCH]	MIC
[BEAT CANCEL]	MONI
[CLEAR]	NB
[FULL/SEMI]	PROC
[METER]	PWR
[N.R.]	RF
[POWER]	RIT/XIT
[RIT]	SQL
[SEND]	
[TF-SET]	
[THRU/AUTO]	
[TX EQ.]	
[VOICE] (if assigned to a PF key)	
[VOX]	
[XIT]	

Note: Even after Lock has been activated, you can still use the Tuning control with [TF-SET] to change your transmit frequency when operating split frequency.

BEEP FUNCTION

The purpose of the Beep function is to provide an audible signal that conveys information. There are two types of signals:

- To confirm that a button has been pressed
- To report an error condition

The volume of the beep output can be selected via Menu No. 38 (BP LV). If you prefer not to hear any beeps, the function can be silenced via Menu No. 35 (BEEP). The following paragraphs explain more about each type of signal.

BUTTON CONFIRMATION

This handy function audibly alerts you each time a button is pressed. In most cases, a single beep is emitted. However, when selecting an operating mode, you have the choice of choosing via Menu No. 36 (BP. MODE) either a single beep or a Morse code abbreviation for the mode selected. If Morse code is chosen, then the abbreviation shown in the table for that mode is sent.

Mode	Morse Code Output
LSB	. _ . . (L)
USB	. . _ (U)
CW	_ . _ . (C)
CW -R	_ (CR)
FSK	. _ . (R)
FSK -R	. _ . . . (RR)
AM	. _ (A)
FM	. . _ . (F)

ALARM NOTIFICATION

An alarm will automatically alert you any time that your action requires the TS-870S to respond in a manner that is outside its set of defined parameters. The alarm may be configured for either three beeps or a Morse code message via Menu No. 37 (WARN. BP).

The messages that you will hear include:

Morse Message	Reason
CHECK	<ul style="list-style-type: none"> You attempted to start memory scanning when it wasn't possible. You attempted to use Quick Channel Search to locate either a programmed or a vacant memory channel when it wasn't possible. You accessed the Quick Menu and attempted to change to a different Menu No. when the Quick Menu was not defined (there are no items in the Quick Menu).
OVER	You attempted to directly enter a frequency that is outside the allowable range.

DISPLAY DIMMER

The Display illumination can be switched between two levels. Menu No. 50 (DIMMER) selects either High (H) or Low (L) intensity. The default is High (H).

QUICK DATA TRANSFER

The TS-870S has the capability to quickly and conveniently transfer the receive frequency, receive mode (computer command "0B"), and the transceiver ID (computer command "ID") over to another compatible transceiver. Compatible transceivers include:

- TS-870S
- TS-950SDX
- TS-850S
- TS-690S
- TS-450S

This function could be useful while contesting. A spotting station that is searching for new contest multipliers can quickly transfer a frequency over to the running (main) station. Even as a single operator, with a little practice, you could use this Transfer function for transferring frequencies from a spotting transceiver over to your running transceiver. In this way, you get part of the benefit of a multi-operator team while still operating as a single-operator entry; an easy way to give a significant boost to your score. The Transfer function is fast, efficient, and increases your chances of working multipliers that you might miss otherwise due to holding a frequency by calling CQ.

Besides contest operation, the Transfer function can also prove useful if you enjoy monitoring more than one frequency simultaneously during day-to-day operating. Even if monitoring another band, you can quickly transfer any frequency over to your main transceiver and be ready to make a call fast enough to beat the DX packetcluster crowd.

SETTING UP

■ Equipment Needed

- TS-870S transceiver
- Compatible transceiver
- Interconnecting cable
- IF-232C (only necessary if transferring data to a transceiver other than the TS-870S)

The cable ends must be terminated with a 9-pin RS-232C female connector to mate with the TS-870S **COM** connector and a 6-pin DIN male connector to mate with the ACC 1 connector on any of the other transceivers. If using two TS-870S transceivers, then both ends need a 9-pin RS-232C female connector. The cable must also have the TXD/RXD and CTS/RTS wires crossed respectively so the cable will act as a null modem when connected between the transceivers.

If two TS-870S transceivers are connected together, the same **COM** connector baud rate must be used on each transceiver. If transferring to or from other **KENWOOD** transceivers, select 4800 bps and 2 stop bits on the TS-870S.



11 OPERATOR CONVENIENCES

■ Connections

Connect each end of the interconnecting cable to the **COM** connector or the **ACC 1** connector on the transceivers.

DSP-100 Users: You may continue using your DSP-100 DSP Unit with the Transfer function. Connect the interconnecting cable to either the **CONT IN** or **CONT OUT** connector on the DSP-100, then connect the unused **CONT** connector on the DSP-100 to the **ACC 1** connector on the transceiver. The transceiver connected to the **CONT IN** becomes the Master; the transceiver connected to the **CONT OUT** connector is the Slave.

USING QUICK TRANSFER

Note: While transmitting data, other functions may work more slowly.

■ Transferring Data

The Master is the transceiver that sends data to the Slave transceiver. If the Master has the RIT function switched ON, the RIT offset frequency is added to the receive frequency to be transferred.

- 1 Switch ON the Transfer function on each transceiver.
 - On the TS-870S, activate Menu No. 54 (TRANSFER) function. For the compatible transceiver, check your Instruction Manual for the correct method.
- 2 On the Master transceiver, press **QUICK MEMO [M.IN]**.
 - If the Master is a TS-450S/690S, press **[M.IN]**, select memory channel 00, then press **[M.IN]** again.
 - The displayed receive data is stored in Quick memory channel 1 on the Master transceiver (TS-450S/690S: channel 00) and transferred to the Slave transceiver.

■ Receiving Data

There are two ways that the Slave can receive the data from the Master:

- Quick memory 1 (TS-450S/690S: channel 00), or
- VFO

This choice is made on the Slave transceiver. On the TS-870S, Menu No. 55 (DIRECT) can be set to OFF to receive data into Quick memory, or to ON to receive data in a VFO. Check your Instruction Manual for other transceivers. Set Menu No. 27 (TX INH) to ON for a Slave TS-870S.

When receiving data at the Slave transceiver in the VFO, the data is transferred to the TX side of the VFO that is currently selected. If the transferred frequency is simplex, both the RIT and XIT on the Slave are set to OFF; if a split frequency is transferred then XIT is set to OFF but RIT is not changed on the Slave. The IF filter is determined by the transferred mode. AIP status is determined by the transferred receive frequency according to the AIP band memory.

If the Slave transceiver has a Quick or Conventional memory channel recalled for transmit when the transfer is done, the data will be rejected. To receive data into a VFO, select TX and RX using VFOs.

ACC 1

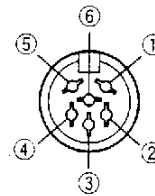

Rear Panel view on TS-450S/690S/850S/950SDX

Pin No.	Pin Name
1	GND
2	TX/RX
3	TX/RX
4	CTS
5	RTS
6	NC

11

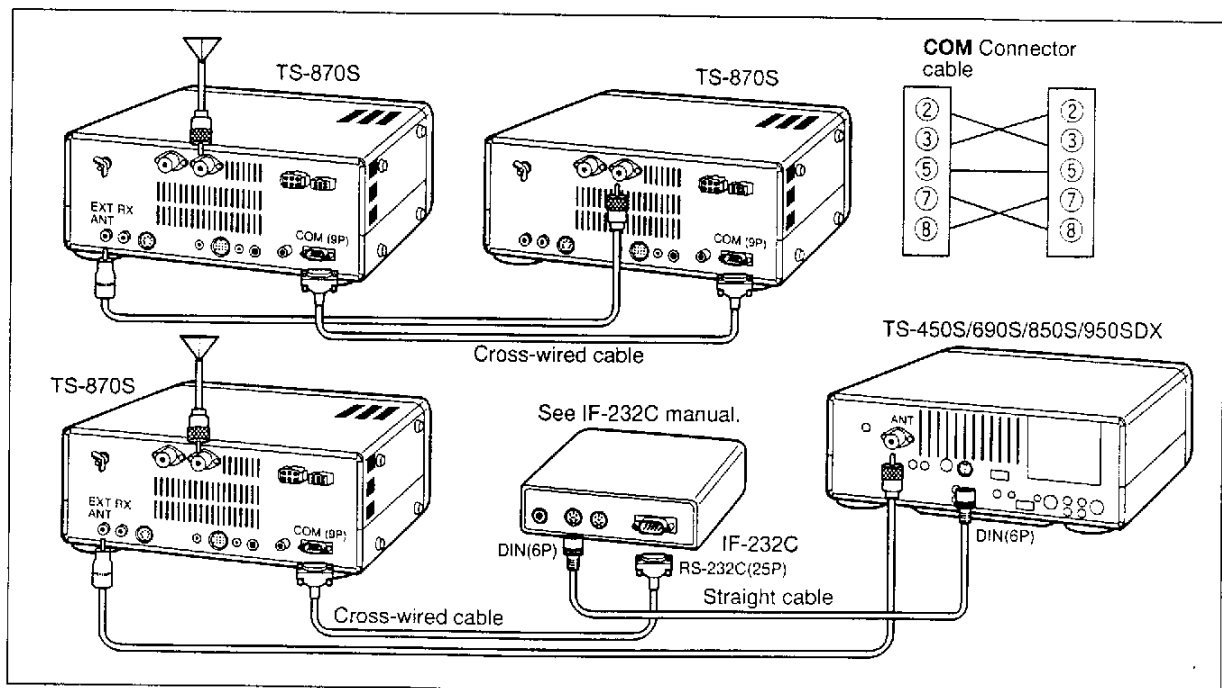

DRU-3 DIGITAL RECORDING SYSTEM (OPTIONAL)

The DRU-3 DRS unit allows you to record approximately 15 seconds of audio per channel on up to 4 channels. The audio is input via your transceiver microphone. Once recorded, the audio can then be transmitted. It is also possible to make longer messages by consecutively sending the contents of message memories. Finally, you can even send this longer linked message repeatedly by using the Repeat function accessible via Menu No. 39 (REPEAT).

The DRU-3 is useful in many situations:

- DX chasing or contest operation where repeated calls are necessary for extended periods of time
- Checking interference complaints to other equipment (lets you be in two places at one time)
- Checking or adjusting your transmit signal or your antennas if it's not convenient to be sitting in front of your microphone
- Helping a friend adjust his antenna or receiver when he needs repeated test transmissions from you

Once you begin using the unit, you'll likely discover other applications.

RECORDING MESSAGES

To record a message, you must select the same mode for transmit and receive. The selected mode must be SSB, FM, or AM.

Note:

- ♦ Pressing the [POWER] switch while recording or playing back messages may cause previously recorded messages or recordings in progress to be erased.
- ♦ Refer to "INTERNAL ADJUSTMENTS" (page 70) for information on adjusting the recording level.

- 1 Switch OFF the VOX function by pressing [VOX].
- 2 Press [REC] to activate the Record Standby mode.
 - "AP -" appears.

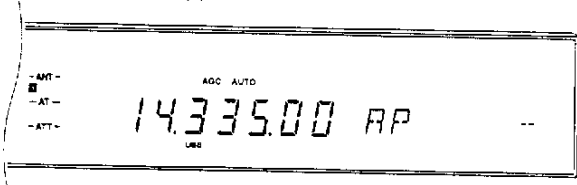

- Press [CLR] to exit from the Record Standby mode and to abort recording your message. This does not erase any previously recorded messages.
- 3 Press and hold down [CH 1], or [CH 2], or [CH 3], or [CH 4] and begin speaking into your microphone.
 - There are four memories for recording messages. Press the button that corresponds to the message memory that you want to use.

- 4 Release the button pressed in Step 3 when you have finished recording your message.
 - Recording continues until you release the key or the maximum recording time passes (about 15 seconds) whichever occurs first.

Note: To erase a message, use the above recording procedure without speaking into the microphone (or disconnect your microphone) while recording.

MESSAGE PLAYBACK

This section explains how to play back the contents of a single message memory. Whether checking or actually transmitting messages, press [CLR] any time you want to cancel playback. Also, you cannot change the transceiver frequency while playing back messages.

Note: Pressing the [POWER] switch while recording or playing back messages may cause previously recorded messages or recordings in progress to be erased.

■ Checking Messages

Use this procedure to verify the contents of a message memory.

- 1 Switch OFF the VOX function by pressing [VOX].
- 2 Select SSB, FM, or AM mode by pressing [LSB/USB] or [FM/AM].
 - The transmit and receive modes must be the same.
- 3 Press [CH 1], or [CH 2], or [CH 3], or [CH 4] to play back the message in the respective memory.
 - For example, "AP 1 - - - -" appears while Message #1 is playing back.

■ Transmitting Messages (VOX)

Use this procedure to transmit the contents of a message memory.

- 1 Switch ON the VOX function by pressing [VOX].

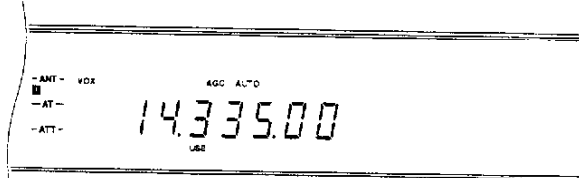

- 2 Select SSB, FM, or AM mode by pressing [LSB/USB] or [FM/AM].
 - The transmit and receive modes must be the same.
- 3 Press [CH 1], or [CH 2], or [CH 3], or [CH 4] to play back the message in the respective memory.
 - After the message is transmitted, the transceiver automatically returns to the receive mode.

11 OPERATOR CONVENIENCES

■ Transmitting Messages (Manual TX/RX)

Use this procedure to transmit the contents of a message memory.

- 1 Select SSB, FM, or AM mode by pressing [LSB/USB] or [FM/AM].
 - The transmit and receive modes must be the same.
- 2 Press [SEND] or Mic [PTT].
- 3 Press [CH 1], or [CH 2], or [CH 3], or [CH 4] to play back the message in the respective memory.
- 4 Press [SEND] again or release Mic [PTT] to return to the receive mode.

CONTINUOUS MULTI-CHANNEL PLAYBACK

You can also play back messages one after the other, in any order, to make longer messages. You could, for example, first play channel 3 followed by channel 1, then channel 4, then channel 2.

If the Repeat function is activated while playing back messages, the remainder of the selected messages are played back, then playback begins again from the beginning of the series of messages. The cycle repeats until you manually interrupt.

- 1 Press [CH 1], or [CH 2], or [CH 3], or [CH 4] to begin playing back a stored message.
- 2 While the first message is still playing, press another memory channel button ([CH 1], or [CH 2], or [CH 3], or [CH 4]) to queue the next message.
 - For example, "AP 1 2 3 -" appears while Messages #1, #2, and #3 are queued to play.
 - The same memory that was played back in Step 1 may be queued in this step.
 - To interrupt playback, press [CLR].
 - To toggle the Repeat function ON or OFF, access Menu No. 39 (REPEAT). The default is OFF.

11

ALTERING INTER-MESSAGE INTERVAL

The inter-message interval refers to the time period between each message, if only one message is played back, or between series of messages, if more than one message is played back.

Example 1:

Ch. 2 → Interval → Ch. 2 → Interval → ...

Example 2:

Ch. 3 → Ch. 2 → Ch. 1 → Ch. 4 → Interval →

Ch. 3 → Ch. 2 → Ch. 1 → Ch. 4 → Interval → ...

Select the time interval between playbacks via Menu No. 40 (REP.TIME). The default interval is 5 seconds.

VS-2 VOICE SYNTHESIZER (OPTIONAL)

When equipped with the VS-2 Voice Synthesizer unit, the TS-870S can announce displayed information. A Programmable Function (PF) button must be assigned the VOICE function to use the Voice Synthesizer. Refer to "PROGRAMMABLE FUNCTION BUTTONS" (page 64) for more information.

When the VOICE PF button is pressed while an announcement is in progress, the announcement stops immediately. Similarly, changing the parameter that is being announced, such as tuning to another frequency, automatically halts the announcement. Frequencies are announced beginning with the 10 MHz digit and continuing through to the 10 Hz digit for VFO or memory channel frequencies. If the memory channel has no data stored, then "OPEN" is announced.

In addition to frequencies, Menu numbers and their settings are also announced with a short pause (100 ms) between the Menu number and the setting. Refer to the following table for the cross-reference between the displayed and the announced information.

VOICE SYNTHESIZER ANNOUNCEMENTS

Displayed	Announcement
OFF	"Zero"
ON	"One"
Numeral	The numeral is announced.
B	"Two" ¹
C	"Three"
L	"Four"
H	"Five"
P	"Six"

¹ VS-2 announces "B" when you switch from Menu A to B via Menu No. 00 (MENU.A/B).

GENERAL INFORMATION

Your transceiver has been factory aligned and tested to specification before shipment. Under normal circumstances, the transceiver will operate in accordance with these operating instructions. All adjustable trimmers, coils and resistors in the transceiver were preset at the factory. They should only be readjusted by a qualified technician who is familiar with this transceiver and has the necessary test equipment. Attempting service or alignment without factory authorization can void the transceiver warranty.

When operated properly, the transceiver will provide years of service and enjoyment without requiring further realignment. The information in this section gives some general service procedures requiring little or no test equipment.

SERVICE

If it is ever necessary to return the equipment to your dealer or service center for repair, pack the transceiver in its original box and packing material. Include a full description of the problems experienced. Include both your telephone number and fax number (if available) along with your name and address in case the service technician needs to call for further explanation while investigating your problem. Don't return accessory items unless you feel they are directly related to the service problem.

You may return your transceiver for service to the authorized **KENWOOD** Dealer from whom you purchased it or any authorized **KENWOOD** service center. A copy of the service report will be returned with the transceiver. Please do not send subassemblies or printed circuit boards. Send the complete transceiver.

Tag all returned items with your name and call sign for identification. Please mention the model and serial number of the transceiver in any communication regarding the problem.

SERVICE NOTE

Dear YL/OM,

If you desire to correspond on a technical or operational problem, please make your note short, complete, and to the point. Help us help you by providing the following:

- 1 Model and serial number of equipment
- 2 Question or problem you are having
- 3 Other equipment in your station pertaining to the problem
- 4 Meter readings
- 5 Other related information (Menu setup, mode, frequency, button sequence to induce malfunction, etc.)

CAUTION: Do not pack the equipment in crushed newspapers for shipment! Extensive damage may result during rough handling or shipping.

Note:

- ◆ Record the date of purchase, serial number and dealer from whom the transceiver was purchased.
- ◆ For your own information, retain a written record of any maintenance performed on the transceiver.
- ◆ When claiming warranty service, please include a photocopy of the bill of sale, or other proof-of-purchase showing the date of sale.

CLEANING

The buttons, controls and case of the transceiver are likely to become soiled after extended use. Remove the controls from the transceiver and clean them with a neutral detergent and warm water. Use a neutral detergent (no strong chemicals) and a damp cloth to clean the case.



12 MAINTENANCE

INTERNAL ADJUSTMENTS

REFERENCE FREQUENCY CALIBRATION

Note: The transceiver is adjusted at the factory prior to shipping. Unless necessary, DO NOT perform this adjustment.

- 1 Remove the top case (10 screws) from the transceiver.
- 2 Set the following on the transceiver:
 - Mode: CW
 - **MONI** control: Center
 - **AF** gain control: Center
 - Menu No. 24 (CW PITCH): 800 Hz
 - **HI/SHIFT** control: 800 Hz
 - **LO/WIDTH** control: 1000 Hz
 - RIT function: OFF
 - Break-in Function (VOX): OFF
- 3 Tune in a standard frequency station such as WWV or WWVH at, for example, 10.000 or 15.000 MHz. Adjust the transceiver **Tuning** control so the Display reads the exact frequency of the station. You should hear a beat tone of approximately 800 Hz.

For 800 Hz:

$$f_{\text{af}} = (f_{\text{display}}/20.000 \times \Delta f_{\text{reference}}) + 800 \text{ Hz}$$

where $\Delta f_{\text{reference}}$ is the shift from the 20 MHz reference frequency

- 4 Close your CW key and you will hear a transmit sidetone of approximately 800 Hz. This sidetone produces a double beat tone when it combines with the received signal. Adjust the **AF** gain control and the **MONI** control so you can hear the double beat clearly.

For 800 Hz:

$$f_{\text{sidetone}} = 800 \text{ Hz} \times [(20 \times 10^6 + \Delta f_{\text{reference}})/20 \times 10^6]$$

where $\Delta f_{\text{reference}}$ is the shift from the 20 MHz reference frequency

- 5 Adjust the TC-800 trimmer to minimize the frequency difference between the received 800 Hz tone and the 800 Hz sidetone.

12

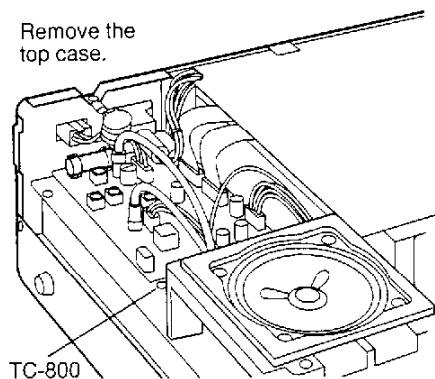

DRU-3 DIGITAL RECORDING UNIT (OPTIONAL)

RECORD LEVEL ADJUSTMENT

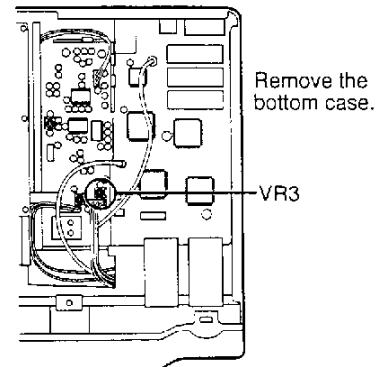

AT-300 EXTERNAL TUNER (OPTIONAL)

FUSE LOCATION

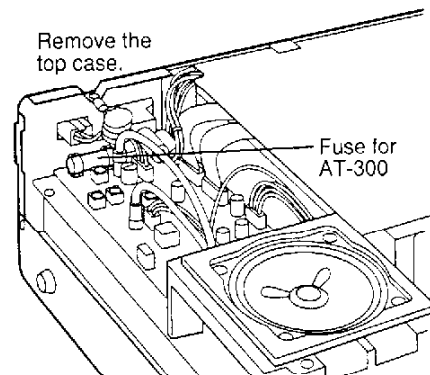

TROUBLESHOOTING

The problems described in this table are commonly encountered operational malfunctions. These types of difficulties are usually caused by improper hook-up, accidental incorrect control settings, or operator error due to incomplete programming. These problem symptoms are not caused by circuit failure. Please review this table, and the appropriate section(s) of this instruction manual, before assuming your transceiver is defective.

Note:

- ◆ Due to frequency relationships of some circuits in this transceiver, beat tones may be heard on the following frequencies: 10.000 MHz, 20.000 MHz, 30.000 MHz. This is not a fault.
- ◆ Placing a powered handy transceiver near this transceiver may cause noise in the TS-670S.

Problem Symptom	Probable Cause	Corrective Action	Page Ref.
The transceiver will not power up after connecting a 13.8 V DC power supply and pressing [POWER]. Nothing appears on the Display, and no receiver noise is heard.	1 The DC power supply is not switched ON.	1 Switch ON the DC power supply.	19
	2 The power cable is faulty.	2 Inspect the power cable. Confirm polarities are correct. Red: positive (+); Black: negative (-).	3
	3 The power cable is not connected securely.	3 Confirm the power connector is locked against the transceiver Rear Panel. Confirm the connections to the DC power supply are secure.	3
	4 A power cable fuse is open.	4 Look for the cause of the blown fuse. After inspecting and correcting any problems, install a new fuse with the same rating.	3
After switching ON the power, the transceiver does not function normally. For example, no digits or incorrect digits appear on the Display.	1 The input voltage is outside 13.8 V DC $\pm 15\%$ (11.7 to 15.8 V DC).	1 Correct the input voltage. Use a step-up transformer, if necessary, to raise the input line voltage to the DC power supply. Or, use a 12 to 16 V battery.	3
	2 The microprocessor has malfunctioned.	2 Review "MICROPROCESSOR RESET". After understanding what data will be lost, do a Partial Reset. If the problem remains, do a Full Reset.	63
After switching ON the transceiver, "14.000.00 MHz USB" is displayed when you have NOT done a Full Reset.	The backup lithium battery voltage is too low.	Obtain a new battery from your dealer or a KENWOOD Service Center.	54
The transceiver does not respond correctly after you press button or key combinations, or turn controls per instructions in this manual.	1 Procedures are not being followed precisely.	1 Review "WRITING CONVENTIONS FOLLOWED".	Inside Front Cover 64
	2 The Lock function is ON.	2 Press [F.LOCK] to turn OFF the Lock function.	
	3 The microprocessor and its memory need resetting.	3 Review "MICROPROCESSOR RESET". After understanding what data will be lost, do a Partial Reset. If the problem remains, do a Full Reset.	63
Menu Nos. cannot be selected in Menu mode.	The Quick Menu function is ON ("MHz" is lit).	Press [1MHz] to cancel the Quick Menu function.	24
The frequency cannot be changed.	The Lock function is activated.	Press [F.LOCK] to switch OFF the function.	64
Turning the RIT/XIT control has no affect on the receive frequency.	The Receive Incremental Tuning function is switched OFF.	Press [RIT] to switch ON the function.	44
SSB audio quality is very poor; the high or low audio frequencies are absent.	1 The filter for Digital operation is selected.	1 Switch Menu No. 19 (PKT.FIL) to OFF.	25 51, 52
	2 The LO/WIDTH control or HI/SHIFT control is set incorrectly.	2 Turn the LO/WIDTH control counterclockwise and the HI/SHIFT control clockwise.	



12 MAINTENANCE

No signals are received or receive sensitivity seems poor.	1 The SQL control is fully clockwise.	1 Turn the SQL control counterclockwise.	19
	2 The Attenuator function is ON.	2 Press ATT [DOWN] repeatedly until the Attenuator function is OFF.	53
	3 The transceiver is in the transmit mode since the [SEND] switch was pressed.	3 Press [SEND] to return to the receive mode.	23
	4 The Microphone PTT switch is pressed.	4 Release the Microphone PTT switch.	23
	5 The LO/WIDTH control or HI/SHIFT control is set incorrectly.	5 Review the sections "SLOPE TUNING", "IF SHIFT", and "CHANGING RECEIVE BANDWIDTH". Set the controls correctly.	51,52
	6 The wrong antenna connector is selected.	6 Press [ANT] to select the other antenna connector.	63
	7 If using a separate receiver that is connected to the EXT RX ANT connector, the connector is not enabled.	7 Switch ON Menu No. 53 (EXT RX).	2
	8 The Advanced Intercept Point function is ON.	8 Press [AIP] to switch OFF the function.	53
No signals are received or receive sensitivity seems poor; S-meter is reading full scale.	The RF gain control is set too low.	Turn the RF gain control fully clockwise.	19
Received signals are totally unintelligible.	The wrong modulation mode is selected.	Press [LSB/USB] , [CW/-R] , [FSK/-R] , or [FM/AM] to select the correct modulation mode.	20
Memory Scan won't start scanning.	1 The SQL control is not set correctly.	1 Adjust the SQL control to just eliminate background noise.	19
	2 You have fewer than two memory channels that are not locked out.	2 Unlock some memory channels.	62
	3 You have fewer than two memory channels programmed.	3 Store data in more memory channels.	54
Memory Scan will not scan one of the stored channels; the desired channel is NOT locked out.	With Group Scan selected, the channel you want to scan is in a different group.	Select All-channel Scan by switching OFF Menu No. 66 (GRP.SCAN), or change to the group that contains the memory channel that you want to scan. Group changes are done by pressing Mic [UP] or [DWN] .	61, 62
Program Scan won't start scanning.	The Start and End frequencies are identical.	Store different Start and End frequencies.	58, 60
Memory Scan never stops scanning even when a station is found.	Busy Frequency Stop is not activated.	Switch ON Busy Frequency Stop via Menu No. 67 (BSY.STOP).	61
Program Scan never stops scanning even when a station is found.	This is normal operation.	Review the Scan Hold function if you want to stop scanning when you hear a station while using Program Scan.	60
You cannot transmit even though you press [PTT] , or transmissions result in no contacts.	1 The microphone plug is not inserted completely in the Front Panel connector.	1 Turn OFF the power, ensure the microphone connector on the Front Panel has no foreign objects in it, then plug in the microphone connector. Secure the connector with the locking ring.	4
	2 The Transmit Inhibit function is ON.	2 Switch Menu No. 27 (TX INH) to OFF.	45
	3 You have selected CW or FSK instead of a voice mode.	3 Press [LSB/USB] or [FM/AM] to select a voice mode.	20
	4 The filter for Digital operation is selected.	4 Switch Menu No. 19 (PKT.FIL) to OFF.	25
	5 The wrong antenna connector (ANT 1/2) is selected.	5 Press [ANT] to select the other antenna connector.	63
Attempting to transmit results in the "HELLO" message appearing and the Receive mode being restored.	1 The antenna is not connected correctly.	1 Check the antenna connection. Correct as necessary.	2
	2 The antenna is not matched correctly with the transceiver.	2 Reduce the SWR of the antenna system.	2
	3 The input voltage is outside 13.8 V DC $\pm 15\%$ (11.7 to 15.8 V DC).	3 Correct the input voltage.	3
	4 An inappropriate DC power cable is being used.	4 Use the provided or an optional DC power cable.	3

12 MAINTENANCE

The transceiver has low transmit power.	1 The MIC gain control and/or CAR control is set too low.	1 Increase the MIC gain control and/or CAR control clockwise depending on the mode being used. Review the appropriate section of the "COMMUNICATING" chapter for the mode being used.	29, 30, 38, 40, 41
	2 Poor antenna system connections are causing high SWR.	2 Check antenna connections. Confirm that the antenna tuner is reporting a low SWR.	49
VOX does not operate.	The VOX gain is set too low.	Increase Menu No. 28 (VOX.GAIN).	45
Linear amplifier does not operate.	1 The LINEAR Menu setting is incorrect.	1 Set Menu No. 51 (LINEAR) according to instructions in "INSTALLATION".	5
	2 The REMOTE connector wiring is wrong or faulty.	2 Inspect the REMOTE connector wiring and correct.	5
Turning the RIT/XIT control has no affect on the transmit frequency.	The Transmit Incremental Tuning function is switched OFF.	Press [XIT] to switch ON the function. Using the XIT function does not change the main frequency display; XIT only changes the RIT/XIT display.	45
You cannot access and use 10 meter band repeaters.	1 The repeater requires a Tone frequency for access.	1 Review "FM REPEATER OPERATION" and select the correct frequency and type of Tone.	38
	2 You are not operating split frequency.	2 You must transmit on the repeater's input frequency and receive on the repeater's output frequency. Refer to "FM REPEATER OPERATION".	36
Digital operation results in few or no connects or contacts with other stations.	1 Physical connections between the transceiver, computer, and TNC or MCP are incorrect, or software settings in the TNC or MCP are wrong.	1 Re-check all connections using this manual, your TNC/MCP manual, and your computer hardware manual as references.	6, 7
	2 Different transmit and receive frequencies are being used.	2 Confirm that the RIT and XIT functions are switched OFF. Confirm that you are NOT operating split frequency.	44, 45
	3 The levels between the transceiver and the TNC/MCP are incorrect.	3 Adjust TX and RX levels using Menu Nos. 20 (PKT.IN) and 21 (PKT.OUT) and level controls on your TNC/MCP.	25, 41
	4 Your transmitted signal or the incoming receive signal is too weak.	4 Reorient/relocate your antenna or increase your antenna gain.	-
	5 The TX delay time parameter in your TNC/MCP is set incorrectly.	5 Set the TNC/MCP TX delay time to more than 300 ms.	-
Attempts at controlling the transceiver by a computer have failed.	1 Your RS-232C cable that connects the transceiver with the computer is wired incorrectly.	1 Correct the cable.	83
	2 Communications parameters set in your terminal program do not match the parameters in the transceiver.	2 Use the same parameters in the terminal program and the transceiver. Refer to "COMMUNICATION PARAMETERS".	50
	3 If using a third party terminal program (not supplied by KENWOOD) on your computer, it is not accurately interfacing with the transceiver COM port protocol.	3 Obtain a terminal program that fully supports the TS-870S protocol. If designing your own program, refer to information in "COMPUTER CONTROL COMMANDS".	85, 89
	4 The serial port on your computer is not functioning correctly.	4 Disconnect the computer from the transceiver, and run a utility program to test the computer serial port. Loop back the computer serial port transmit and receive pins to test the port fully.	-



OPTIONAL ACCESSORIES

PS-52
HEAVY-DUTY Power
Supply (22.5 A)

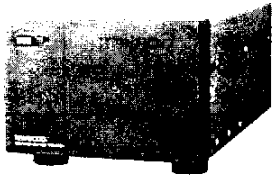

MC-43S
Hand Microphone



MC-60A
Deluxe Desktop
Microphone



MC-80
Desktop Microphone



MC-85
Multi-function Desktop
Microphone

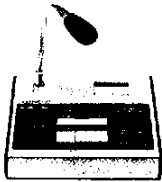

MC-90
DSP-compatible Desktop
Microphone



AT-300
Automatic Antenna Tuner

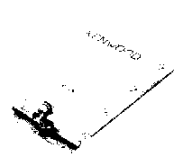

HS-5
Deluxe Headphones



HS-6
Small Headphones



SP-31
External Speaker



DRU-3
Digital Recording Unit

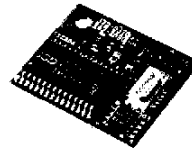

SO-2
Temperature-
compensated Crystal
Oscillator (TCXO)



VS-2
Voice Synthesizer Unit

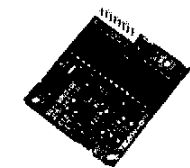

SM-230
Station Monitor

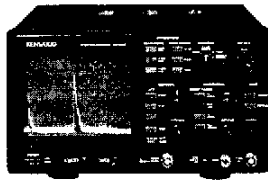

PC-1A
Phone Patch Controller



SW-2100
SWR/Power Meter



13

IF-232C
Interface Unit



LF-30A
Low-pass Filter



PG-2Z
DC Cable



INSTALLING OPTIONS

REMOVING THE CASE

TOP CASE

- 1 Remove the screws (10 screws).

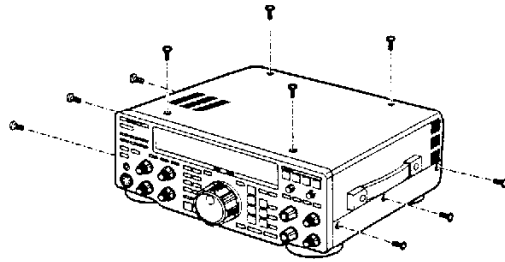

- 2 Lift off the top case.

BOTTOM CASE

- 1 Remove the screws (12 screws).

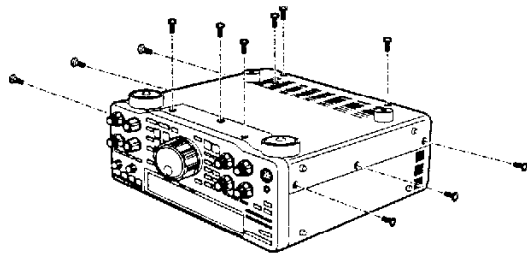

- 2 Lift off the bottom case.

DRU-3 DIGITAL RECORDING UNIT

CAUTION: Switch OFF the power and unplug the DC power cable before beginning installation.

Note: Refer to "INTERNAL ADJUSTMENTS" (page 70) for information on adjusting the recording level.

EQUIPMENT REQUIRED:

- Large Phillips screwdriver
- Small Phillips screwdriver

- 1 Remove the bottom case (12 screws).
- 2 Remove Cover A (see diagram) (6 screws).
- 3 Locate the CN5 connector in the transceiver. Remove the paper backing from one side of the supplied cushion, then install the cushion. Remove the paper backing from the other side of the installed cushion, then plug the DRU-3 connector (CN901) into CN5.

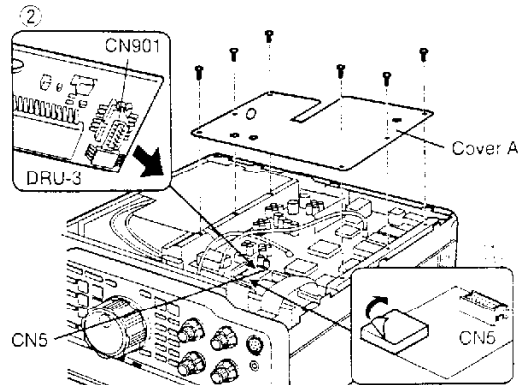

- 4 Re-install Cover A (6 screws).
- 5 Replace the bottom case and re-install its screws (12 screws).

VS-2 VOICE SYNTHESIZER UNIT

CAUTION: Switch OFF the power and unplug the DC power cable before beginning installation.

EQUIPMENT REQUIRED:

- Large Phillips screwdriver
- Small Phillips screwdriver

- 1 Confirm that the small switch on the VS-2 unit is in the "ENGLISH" position.
- 2 Remove the bottom case (12 screws).
- 3 Remove Cover A (6 screws).

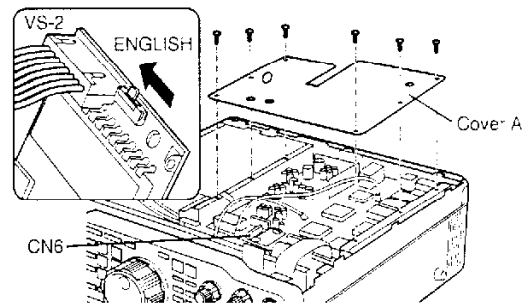

- 4 Locate the 8-pin connector CN6 in the transceiver, and plug the VS-2 connector into CN6.

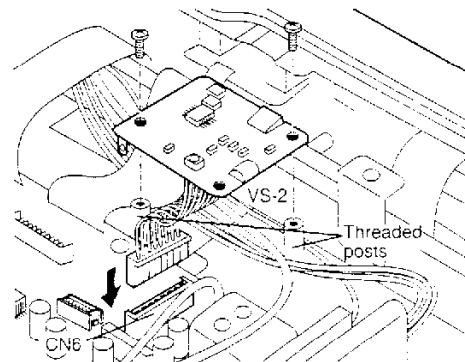

14 INSTALLING OPTIONS

- 5 Orient the VS-2 unit with the large IC (IC1) facing down, then install this unit on the two threaded posts using the 2 screws.
- 6 Re-install Cover A (6 screws).
- 7 Replace the bottom case and re-install its screws (12 screws).

Note:

- ◆ For more information, refer to the Instruction Manual provided with the VS-2 unit.
- ◆ The supplied screws and cushion are not used. Keep them for future use.

SO-2 TEMPERATURE-COMPENSATED CRYSTAL OSCILLATOR (TCXO)

CAUTION: Switch OFF the power and unplug the DC power cable before beginning installation.

EQUIPMENT REQUIRED:

- Large Phillips screwdriver
- Small Phillips screwdriver
- Pencil soldering iron (25 W)

- 1 Remove the top case (10 screws).
- 2 Unplug the speaker cable from the 2-pin connector CN404. Remove the speaker-bracket screws (4 screws), then lift out the entire speaker assembly.

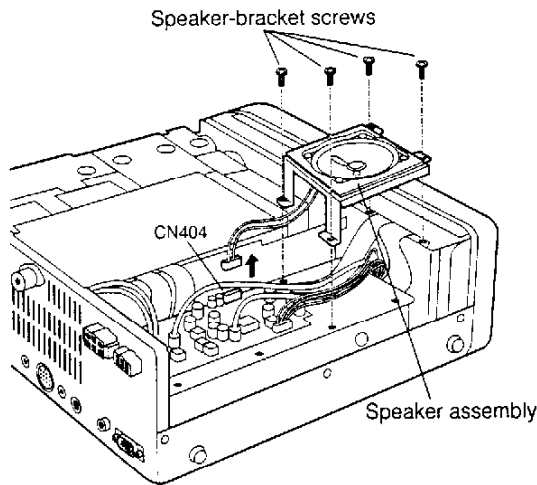

- 3 Remove the remaining screws (6 screws) from Cover B.

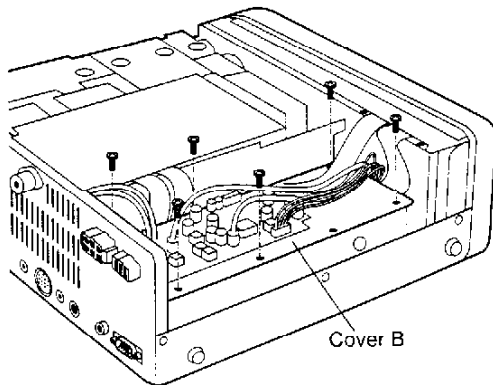

- 4 Unplug CN407 (wired to the AT connector on the Rear Panel) from the circuit board. Lift up Cover B, and remove the small SO-2 board from the compartment below.

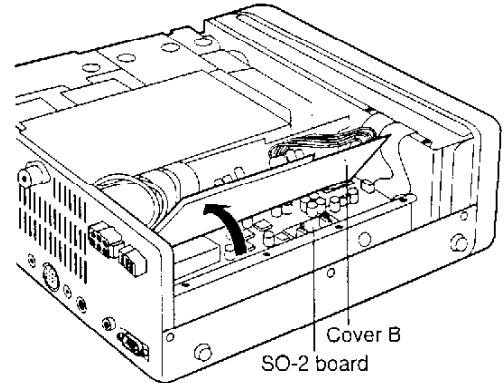

- 5 Insert the SO-2 unit into the SO-2 board. Solder the five pins on the unit to the board.

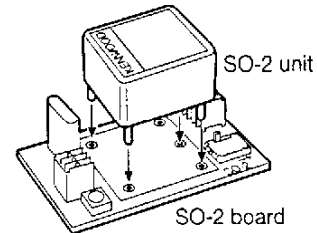

- 6 Slide the small switch on the SO-2 board in the direction of the "SO-2" arrow.

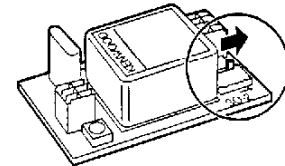

Note: This switch must be positioned correctly for the SO-2 unit to function.

- 7 Re-install the SO-2 board in the transceiver in the same location from which it was removed.

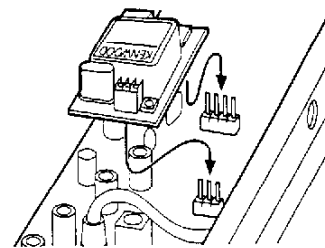

- 8 Re-position Cover B and install only 6 screws.
- 9 Re-position the speaker-bracket assembly, install its screws (4 screws), and plug the speaker cable into CN404.
- 10 Replace the top case and re-install its screws (10 screws).

Note: For more information, refer to the Instruction Manual provided with the SO-2 unit.

SPECIFICATIONS

GENERAL	Mode		J3E (LSB, USB), A1A (CW), A3E (AM), F3E (FM), F1D (FSK)
	Number of memory channels		100
	Antenna impedance		50 Ω (with Antenna Tuner 20 ~ 150 Ω)
	Supply voltage		DC 13.8 V ± 15%
	Grounding method		Negative ground
	Current	Transmit (max.)	20.5 A
		Receive (no signal)	2 A
	Usable temperature range		-10°C ~ 50°C (+14°F ~ 122°F)
	Frequency stability (-10°C ~ 50°C)		Within ±10 PPM
	Frequency accuracy (at room temperature)		Within ±10 PPM
	Dimensions [W x H x D] (Projections included)		330 x 120 x 334 mm / 13.0 x 4.72 x 13.1 in (339 x 135 x 375 mm / 13.3 x 5.31 x 14.8 in)
Weight		Approx. 11.5 kg (25 lbs)	

TRANSMITTER	Frequency range	160 m band	1.8 ¹ ~ 2.0 ² MHz	
		80 m band	3.5 ~ 4.0 ³ MHz	
		40 m band	7.0 ~ 7.3 ⁴ MHz	
		30 m band	10.1 ~ 10.15 MHz	
		20 m band	14.0 ~ 14.35 MHz	
		17 m band	18.068 ~ 18.168 MHz	
		15 m band	21.0 ~ 21.45 MHz	
		12 m band	24.89 ~ 24.99 MHz	
		10 m band	28.0 ~ 29.7 MHz	
	Output power ⁵	SSB, CW, FSK, FM	Max.	100 W
			Min.	20 W or less
		AM	Max.	25 W
			Min.	20 W or less
	Modulation	SSB	Balanced	
		FM	Reactance	
		AM	Low level	
	Spurious emissions		-60 dB or less	
	Carrier suppression		50 dB or more	
	Unwanted sideband suppression (modulation frequency 1.0 kHz)		50 dB or more	
Maximum frequency deviation (FM)	Wide	±5 kHz or less		
	Narrow	±2.5 kHz or less		
Transmit frequency characteristics (-6 dB) (TX lower cutoff: 300 Hz, TX bandwidth: 2.3 kHz)		300 ~ 2600 Hz		
XIT shift frequency range		±9.99 kHz		
Microphone impedance		600 Ω		

¹ 1.81 MHz: Europe, France, Holland; 1.83 MHz: Belgium, Spain

² 1.85 MHz: Belgium, France, Holland, Spain

³ 3.8 MHz: Europe, Belgium, France, Holland, Spain

⁴ 7.1 MHz: Europe, Belgium, France, Holland, Spain

⁵ Belgium, Spain: 10 W fixed on 160 m band



SPECIFICATIONS

RECEIVER	Circuit type		Quadruple conversion superheterodyne	
	Frequency range		100 kHz ~ 30 MHz	
	Intermediate frequency		1st: 73.05 MHz; 2nd: 8.83 MHz; 3rd: 455 kHz; 4th: 11.3 kHz	
	Sensitivity	SSB, CW, FSK (at 10 dB (S+N)/N)	100 kHz ~ 500 kHz	1 μ V or less
			500 kHz ~ 1.62 ⁶ MHz	4 μ V or less
			1.62 ⁶ MHz ~ 24.5 MHz	0.2 μ V or less
			24.5 MHz ~ 30 MHz	0.13 μ V or less
		AM (at 10 dB (S+N)/N)	100 kHz ~ 500 kHz	2 μ V or less
			500 kHz ~ 1.62 ⁶ MHz	31.6 μ V or less
			1.62 ⁶ MHz ~ 24.5 MHz	2 μ V or less
	FM (at 12 dB SINAD)	28 MHz ~ 30 MHz	0.25 μ V or less	
	Selectivity	SSB Lo: 300 Hz, Hi: 2600 Hz	-6 dB: 2.3 kHz, -60 dB: 3.3 kHz	
		CW Width: 200 Hz	-6 dB: 200 Hz, -60 dB: 450 Hz	
		FSK Width: 500 Hz	-6 dB: 500 Hz, -60 dB: 1000 Hz	
		AM Lo: 100 Hz, Hi: 4000 Hz	-6 dB: 9 kHz, -60 dB: 12 kHz	
		FM Width: 14 kHz	-6 dB: 14 kHz, -60 dB: 18 kHz	
	Image rejection (1.8 MHz ~ 30 MHz)		80 dB or more	
	1st IF rejection (1.8 MHz ~ 30 MHz)		80 dB or more	
Notch filter attenuation		40 dB or more		
RIT shift frequency range		\pm 9.99 kHz		
Squelch sensitivity	SSB, CW, FSK, AM	100 kHz ~ 500 kHz	2 μ V or less	
		500 kHz ~ 1.62 ⁶ MHz	20 μ V or less	
		1.62 ⁶ MHz ~ 30 MHz	2 μ V or less	
	FM	28 ~ 30 MHz	0.25 μ V or less	
Audio output (8 Ω , 10% distortion)		1.5 W or more		
Audio output impedance		8 Ω		

⁶1,705 MHz: Canada, U.S.A.

Specifications are subject to change without notice or obligation due to ongoing technological developments.

Downloaded by

Amateur Radio Directory

APPENDIX A: LEARNING ABOUT DSP

First-time users of a DSP transceiver may feel bewildered by the quantity of functions that they have never encountered on previous transceivers. When combined with the collection of new terminology that accompanies DSP, even an experienced operator may become frustrated. The purpose of this section is to offer a few examples that help you to begin learning about the effects and benefits of DSP. It's best to read this section after you are comfortable with using the Menu system, and after you are fully familiar with the controls and buttons on the TS-870S. This manual will not make you an expert on using the DSP functions; that knowledge will come as a result of hands-on experience with the TS-870S.

Regardless what style of operating you prefer, DSP can help you. What operator doesn't want the quiet, low-noise pass band offered by DSP operating in the IF stages? Who doesn't want to effortlessly eliminate interfering tones caused by others tuning up near their operating frequency? Why wouldn't anybody want to narrow their CW bandwidth to a razor-thin slice of spectrum if they can still listen to a pleasing CW note without analog filter "ringing"? These are only a few examples where DSP shines.

To begin with, the default Menu values chosen for the DSP functions on the TS-870S Menu have been carefully considered by the design engineers. They are good starting points. If you have already changed many Menu items as you've experimented with your new transceiver, do a Temporary Menu Reset {page 24} or a Full Reset {page 63} so that you know you are starting with the default Menu values.

Switch over to an Amateur band with lots of activity. Tune in an SSB station with reasonable signal strength. Press **[N.R.]** to activate Noise Reduction. You will hear a drop in the background noise that makes listening to the signal much more pleasant. If your station is located in an electrically noisy city, this function alone may make you a DSP believer. Assuming the default Menu values are selected (due to the reset above), you are now using the Line Enhance function (Menu No. 13 is ON). This function is "tracking" (Menu No. 18 is ON) the signal as the unwanted noise is removed.

Try changing Menu No. 14 to reduce and increase the response time of the Line Enhance function. What do you notice? Maybe little change can be heard with this signal or maybe you hear an important change. The longer you allow DSP to monitor the signal, the better the adaptive filters can determine how to fight the noise that is present. But there are tradeoffs. Monitoring a particular signal for too long will mean that the transceiver responds too slowly. Experiment and listen.

Switch OFF Menu No. 13. You are now using the SPAC filter. Listen for a change in audio quality as you switch Menu No. 13 OFF and ON. While Menu No. 13 is OFF, change the setting for Menu No. 15 to select a different correlation time for the SPAC mode. If you can't hear a significant difference for the current receiving situation, then select a longer SPAC time for better audio quality. Although you may prefer the audio produced when, for example, the Line Enhance function is ON, remember

that different signal and band conditions can produce different results. Try not to come to any conclusions about which settings are best at this early stage. Keep an open mind until you've done a lot more experimenting on various bands with different propagation conditions.

Widen the receive pass band by turning the **LO/WIDTH** control counterclockwise and the **HI/SHIFT** control clockwise. Try to find a QSO in progress between two stations who are experiencing interference from a third station that may be tuning slightly off frequency but within your pass band. Press **[BEAT CANCEL]**. You may think the tuning station stopped transmitting. Press **[BEAT CANCEL]** again to switch OFF the function. The station is still tuning and you can hear it again! Beat Cancel can be so effective at automatically finding and canceling tones that are audible in the pass band that you may not be aware of the "interfering" stations at all. With Beat Cancel ON, experiment by changing the Beat Cancel response time via Menu No. 16. The response time of the function decreases as the setting number increases (selection 0 has the fastest response time).

Press **[AUTO NOTCH]**. Since Auto Notch functions in the IF stages, it may work better or worse than Beat Cancel for a given situation. Compare the effect of Auto Notch versus Beat Cancel with the same interfering tone or tones. Change Menu No. 17 to try different response times for Auto Notch while that function is activated. Experiment and listen.

If you are a CW operator, switch to the CW section of a band and search for a crowded portion. With the CW mode selected and the **LO/WIDTH** control turned clockwise to select a 1 kHz bandwidth, tune to a frequency where two or more stations are audible. Now turn the **LO/WIDTH** control counterclockwise to reduce the bandwidth. Forget old ideas associated with analog filters for how narrow you like the bandwidth when operating CW. With the minimum bandwidth, you may need to tune a little to center the desired signal in the pass band. Press **[FINE]** to reduce the tuning step to make tuning easier. Listen to the quality of the chosen signal. Can you believe the bandwidth displayed on the Front Panel? There are other functions to help you fight CW interference (such as IF Shift) but this example is to illustrate the benefits that DSP offers when using extremely narrow bandwidths.

After reading this manual, you should be equipped with the basic knowledge to begin learning how to use DSP to your advantage. The DSP benefits that you enjoy will be related to the amount of time that you spend experimenting with DSP while operating.

APPENDIX B: PROPAGATION INFORMATION

STANDARD TIME AND INFORMATION STATIONS

Besides providing an extremely accurate time source and other information, stations WWV and WWVH, in the continental U.S.A. and Hawaii respectively, deliver propagation announcements every hour in addition to acting as powerful beacons themselves. The announcements include information on geophysical alerts, solar activity, and more that all affects how well your signals will propagate to the DX station you're trying to catch. If you can't hear WWV/WWVH, then consult references such as the World Radio TV Handbook for information on some of the other standard time stations located closer to your area.

Check 2500, 5000, 10000, 15000, and 20000 kHz at 18 minutes after each hour (WWV), and 2500, 5000, 10000, and 15000 kHz at 45 minutes after each hour (WWVH) to hear the propagation forecasts.

NCDXF/IARU BEACON NETWORK

The Northern California DX Foundation and the International Amateur Radio Union are cooperating to support this particularly useful on-the-air tool. The network is monitored by scientists, students, etc. as well as Amateur operators.

This group of stations are located in North America, the Pacific, eastern Asia, the Middle East, Europe, southern Africa and South America, and more stations continue to be added to the network. They transmit beacon signals on 14100 kHz consecutively in sequence at power levels from 100 watts down to 100 milliwatts. You can listen to each station transmit with a known power from a known direction and location.

With minimal effort, in a brief time you can compile a customized and accurate profile of HF propagation conditions at your location. This information will help you decide where to point your antenna to look for DX or to call CQ. You could even distribute the information via packetcluster to local friends for their benefit. Or, because of the very precise timing used for each transmission, possibly you could develop an automatic means of monitoring the beacon frequencies, then assemble the recorded signal levels into a meaningful database for later consultation.

Beacon Power Level (W)	CW Message Transmitted
100	Call sign
100	(long dash)
10	(long dash)
1	(long dash)
0.1	(long dash)

The following table shows some of the stations involved in this program.

Station	Location
4U1UN/B	United Nations, New York
W6WX/B	Stanford University, California
KH6O/B	Kane'ohe, Hawaii
JA2IGY	Mt. Asama, Japan
4X6TU	Tel Aviv University, Israel
OH2B	Helsinki Technical University, Finland
CT3B	Funchal, Madeira Island
ZS6DN/B	Transvaal, South Africa
LU4AA	Buenos Aires, Argentina

Note: As a courtesy to other Amateurs, avoid transmitting on the 14100 kHz beacon frequency. Also, plans are in progress to expand the beacon network to include 18110, 21150, 24930, and 28200 kHz. When operation begins on these new frequencies, avoid transmitting on them as well.

HF BEACONS

Beacon stations transmit from locations in many countries. Often they operate 24 hours per day and, if you can hear a particular beacon, you know there is some propagation to that area of the world. Consult reference books such as the ARRL Repeater Directory for detailed information on active beacons. The table below lists some beacons that you may hear.

Freq (kHz)	Call Sign	Location	Emis.	ERP
14100	See page 80	NCDXF/IARU beacon network	A1A	100
24192.05	KK6TG	St. Helena	F1A	0.03
28050	PY2GOB	Sao Paulo	—	15
28175	VE3TEN	Ottawa	—	10
28191	5B4ZL	Cyprus	—	10
28191	VE6YF	Edmonton	—	10
28195	IY4M	Bologna	A1A	20
28200	GB3SX	Crowborough	F1A	8
28200	KF4MS	St. Petersburg, FL	—	75
28200	KG5YB	Tyler, TX	A1A	3
28200	W6WX	California	—	100
28201	LU8ED	Argentina	—	—
28201.5	EA7PS	Spain	—	1
28202	KE5GY	Arlington, TX	—	5
28202.5	ZS5VHF	Natal	—	5
28204	DLØIGI	Germany	—	100
28205	DLØIGI	Mt. Predigtstuhl	F1A	100
28206	KJ4X	Pickens, SC	—	2
28207.5	KE4NL	Sarasota, FL	A1A	5
28207.5	W8FKL	Venice, FL	—	10
28208	WA1IOB	Marlboro, MA	—	75
28209	NX2O	Staten Is., NY	A1A	10

Freq (kHz)	Call Sign	Location	Emis.	ERP
28210	3B8MS	Mauritius	—	—
28210	K4KMZ	Elizabethtown, KY	—	20
28210	KC4DPC	Wilmington, NC	A1A	4
28212.5	EA6RCM	Palma de Mallorca	—	—
28212.5	ZD9GI	Gough Island	F1A	—
28215	GB3RAL	Slough	F1A	20
28215	KA9SZX	Champaign, IL	A1A	1
28215	LU4XI	Cape Horn	—	—
28216	GB3RAL	Slough Berkshire	—	20
28216.8	N6UGR	California	—	10
28217.5	VE2TEN	Chicoutimi	—	4
28217.5	WB9VMY/5	Oklahoma, OK	A1A	2
28218	W8UR	Mackinac Is., MI	A1A	0.5
28219	PT8AA	Rio Branco	—	5
28220	5B4CY	Zyyi	F1A	26
28220	KB9DJA	Mooreville, IN	A1A	10
28220	LU4XS	Tierra del Fuego	—	2
28221	PY2GOB	Sao Paulo	—	15
28222	W9UXO	Chicago, IL	—	10
28222.5	HG2BHA	Tapolca	F1A	10
28224.5	KA9UEX	West Bend, IN	—	—
28225	EA1EVE	Spain	—	1
28225	KW7Y	Everett, WA	A1A	4
28225	PY2AMI	Sao Paulo	—	5
28227	FX5TEN	Toulouse	—	8
28227.5	EA6AU	Mallorca	A1A	10
28229	EA6AU	Mallorca	—	10
28230	N2ECB	Springfield, NJ	—	25
28230	ZL2MHF	Mt. Climie	F1A	50
28231	N4LMZ	Mobile, AL	—	2
28232	W7JPI	Sonoita, AZ	—	5
28232.5	KD4EC	Jupiter, FL	—	7
28235	VP9BA	Hamilton	F1A	10
28237	NV6A	San Diego, CA	A1A	0.5
28237	YO2KHP	Timisoara	—	20
28237.5	LA5TEN	Oslo	A1A	10
28240	KB8JVH	Newark, OH	A1A	5
28240	OA4CK	Lima	A1A	10
28240.5	5Z4ERR	Kenya	—	—
28242.5	ZS1CTB	Capetown	F1A	20
28244	WA6APQ	Long Beach, CA	A1A	30
28244	WT8D	Hilton Head, SC	—	10
28244.5	KBØDJJ	Omaha, NB	—	10
28245	A92C	Bahrain	F1A	—
28246	N8KHE	Mackinaw, MI	A1A	0.05
28247.5	EA2HB	San Sebastian	—	6
28248	K1BZ	Belfast, ME	—	5
28249	PI7BQC	Haarlem	—	2
28250	KØHTF	Des Moines, IA	A1A	2.5
28250	N4MW	Memphis, TN	—	10
28250	WJ9Z	St. Francis, WI	F1A	15
28250	Z21ANB	Bulawayo	F1A	15
28250.5	4N3ZHK	Mt. Kum	—	1
28252	WB4JHS	Durham, NC	—	7
28252	WJ7X	Victoria, MN	A1A	10

Freq (kHz)	Call Sign	Location	Emis.	ERP
28255	LU1UG	Gral Pico	—	5
28255	WB4JHS	Durham, NC	—	7
28257.5	DKØTEN	Arbeitsgen	F1A	40
28259	WB9FVR	Pemb. Pines, FL	—	1
28260	KA1NSV	Hyannis, MA	A1A	80
28260	VK5WI	Adelaide	A1A	10
28262	VK2RSY	Sydney	A1A	25
28263	N6PEQ	Tustin, CA	A1A	2
28264	VK6RWA	Perth	A1A	—
28265	N9JL	East Alton, IL	A1A	1
28266	VK6RTW	Albany	—	—
28268	KB4UPI	Birmingham, AL	—	20
28268.5	W9KFO	Eaton, IN	—	0.75
28270	VK4RTL	Townsville	—	—
28270	ZS6PW	Pretoria	—	10
28272.5	9L1FTN	Freetown	—	10
28275	AL7GQ	Denver, CO	—	1.5
28275	ZS1LA	Stillbay	—	10
28277.5	DFØAAB	Kiel	A1A	10
28280	KB2BBW	Rutherford, NJ	—	5
28280	LU8EB	Argentina	—	5
28280	YV5AYV	Caracas	F1A	10
28281	VE1MUF	New Brunswick	—	—
28282	OKØEG	Hradec Kralove	—	10
28282	VE2HOT	Beaconsfield	—	5
28283	WD4LWG	Tampa, FL	F1A	2
28283.5	EA7RCC	Cordova	—	10
28285	N2JNT	Troy, NY	—	1
28285	VP8ADE	Antarctica	—	8
28286	KA1YE	Henrietta, NY	A1A	2
28286	KE2DI	Rochester, NY	—	5
28286	KK4M	Las Vegas, NV	—	5
28286	N3GPP	Lancaster, PA	—	1
28286.6	KK4M	Las Vegas, NV	—	5
28287	H44SI	Solomon Islands	—	15
28287	W8OMV	Asheville, NC	—	5
28288	W2NZH	Moorestown, NJ	A1A	3
28290	VS6TEN	Mt. Matilda	A1A	10
28290	W3SV	Elverson, PA	—	10
28292.5	LU2FFV	San Jorge	—	5
28294	WC8E	Deerpark, OH	—	10
28294.5	KEØUL	Greeley, CO	A1A	5
28295	WB8UPN	Cincinnati, OH	—	10
28296	W3VD	Laurel, MD	—	1.5
28297	WA4DJS	Ft. Lauderdale, FL	—	10
28299	N8CGY	Michigan	—	5
28299	PY2AMI	Sao Paulo	A1A	10
28300	KF4MS	St. Petersburg, FL	—	5
28300	ZS1LA	Still Bay	F1A	20
28303	PT7AAC	Fortaleza	—	5
28315	ZS6DN	Irene	—	100
28888	W6IRT	N. Hollywood, CA	A1A	5
28890	WD9GOE	Freeburg, IL	—	—
28992	DLØNF	Germany	A1A	1

APPENDIX C: GENERAL COVERAGE RECEIVER FOR SWLING

The path that led many Amateurs to their first license included hours spent scanning the international shortwave broadcast bands. Often, inferior receivers that were readily available were used in those days. With your TS-870S, you now have the opportunity to re-visit those same crowded broadcast bands, but truly enjoy the myriad of stations that can be heard. For those who have never explored the shortwave broadcast bands, try listening and discover a world quite different from the Amateur bands.

Even if you have no interest in the transmission content from international broadcasters, noting which stations are present on which bands is another way to stay in touch with current propagation. Also, listening to native speakers of foreign languages is the best way to improve your listening comprehension of that foreign language. This could all help your Amateur activities.

Erecting a new antenna specifically for the broadcast bands is probably not necessary. Just use your Amateur antennas. Having a high gain antenna is usually not important; using the correct selectivity is the key to enjoying your listening.

Amateur Band Antenna	Shortwave Broadcast Band
10 or 12 m	11 m: 25600 ~ 26100 kHz
15 m	13 m: 21450 ~ 21750 kHz
15 or 17 m	15 m: 18900 ~ 19020 kHz
17 or 20 m	16 m: 17480 ~ 17900 kHz
20 m	19 m: 15100 ~ 15800 kHz
20 m	22 m: 13500 ~ 13870 kHz
20 or 30 m	25 m: 11600 ~ 12100 kHz
30 or 40 m	31 m: 9400 ~ 9990 kHz
40 m	41 m: 7100 ~ 7350 kHz
40 m	49 m: 5900 ~ 6200 kHz
80 m	60 m: 4750 ~ 5060 kHz
80 m	75 m: 3900 ~ 4000 kHz
80 m	90 m: 3200 ~ 3400 kHz
80 or 160 m	120 m: 2300 ~ 2495 kHz

Writing for many different program schedules is probably not necessary. There are numerous sources of scheduling information. Check your local packetclusters, packet networks, telephone BBS nodes, and interactive computer networks. Local newsstands may carry copies of SWL magazines and comprehensive books such as the "World Radio TV Handbook" or "Passport to World Band Radio". Or simply listen on the broadcast bands and you may find SWL programs that announce current frequencies and languages being used by different broadcasters.

To handle the extremely crowded broadcast bands, you have many tools available on the TS-870S. For example:

- Store frequencies into consecutive memory channels for a broadcaster that is using parallel frequencies for a single transmission so you can quickly compare conditions on different bands.
- Try the LSB or USB mode and zero beat instead of using the AM mode. This will increase the intelligibility of some stations on crowded bands.
- Try different positions of the **LOWIDTH** and **HI/SHIFT** controls to maximize sound quality but minimize interference.
- Dedicate either Menu A or Menu B as an SWL profile so you can quickly switch between Amateur and SWL settings.
- Switch ON the AIP function to reduce interference.
- Set Menu No. 43 (CH. STEP) for 5 kHz steps so the **M.CH/VFO.CH** control will step conveniently between broadcast channels.
- Set Menu No. 44 (STEP.ADJ) to ON so that rounding will occur on the next use of the **M.CH/VFO.CH** control. This allows you to use the **Tuning** control to tune across a station, then later continue stepping up the band from channel to channel with the **M.CH/VFO.CH** control.
- Consider using the **COM** connector to control the TS-870S from a computer. Software databases are available that can be used to quickly select the correct station frequencies for different broadcasters. This lets the computer keep track of where broadcasters are located, you only decide which stations that you want to hear.

APPENDIX D: COM CONNECTOR PROTOCOL

HARDWARE DESCRIPTION

The TS-870S uses a full-duplex, asynchronous, serial interface for communicating through the male 9-pin RS-232C **COM** connector. Bytes are constructed with 1 start bit, 8 data bits, and 1 stop bit (4800 bps can be configured for 1 or 2 stop bits). No parity is used. The pinout and the pin functions of the **COM** connector are as shown below:

COM CONNECTOR

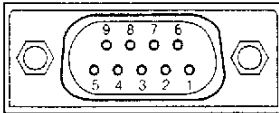

TS-870S Rear panel view

COM Pin No.	COM Pin Name (Ref.: Computer)	Function (Reference: TS-870S)	V _O
1	NC	—	—
2	RXD	Transmit data	Output
3	TXD	Receive data	Input
4	NC	—	—
5	GND	Signal ground	
6	NC	—	—
7	RTS	Receive enable	Input
8	CTS	Transmit enable	Output
9	NC	—	—

RXD: The transmit data is the serial data transferred from the transceiver to the computer. The output uses negative logic.

TXD: The receive data is the serial data transferred from the computer to the transceiver. The input uses negative logic.

GND: This is the signal ground pin.

RTS: This signal is applied to the transceiver. It is used to inhibit transmit data from the transceiver when the computer is not ready to receive the data. The input uses positive logic. Inhibit is requested when the level is low.

CTS: This signal is applied from the transceiver. It is used to inhibit transmit data from the computer when the transceiver is not ready to receive the data. The output uses positive logic. Transmit data is stopped when the level is low.

CONTROL OPERATION

Most computers handle data in the form of "bits" and "bytes". A bit is the smallest piece of information that the computer can handle. A byte is composed of eight bits. This is the most convenient form for most computer data. This data may be sent in the form of either serial or parallel data strings. The parallel method is faster but more complicated, while the serial method is slower and requires less complicated equipment. The serial form is, therefore, a less expensive alternative.

Serial data transmission uses time-division methods over a single line. Using a single line also offers the advantage of reducing the number of errors due to line noise.

Only 3 lines are required theoretically for control of the transceiver via the computer:

- Transmit data
- Receive data
- Ground

From a practical standpoint, it is also necessary to incorporate some means of controlling when this data transfer will occur. The computer and transceiver cannot be allowed to send data at the same time! The required control is achieved by using the RTS and CTS lines.

For example, the transceiver is placed into the transmit mode whenever the character string "TX;" is sent from the computer. The character string "TX;" is called a command. It tells the transceiver to do something. There are numerous commands available for control of the transceiver. These commands may be incorporated into a computer program written in any high level language. Programming methods vary from computer to computer; therefore, refer to the instruction manuals provided with the terminal program and computer.

COMMANDS

A command is composed of 2 alphabetical characters, various parameters, and the terminator to signal the end of the command.

EXAMPLE: Command to set VFO A to 7 MHz

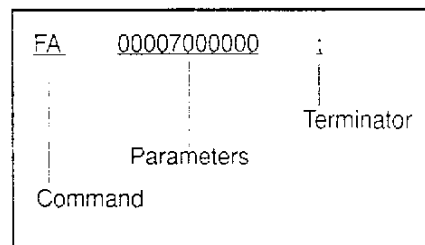

COMMAND DESCRIPTION

A command may consist of either lower or upper case alphabetical characters.

● APPENDICES

PARAMETER DESCRIPTION

Parameters are used to specify information necessary to implement the desired command. The parameters to be used for each command are predetermined. The number of digits assigned to each parameter is also predetermined. If a particular parameter is not applicable to the TS-870S, the parameter digits should be filled using any character except the ASCII control codes (00 to 1Fh) and the terminator (;).

BAD COMMAND EXAMPLES:

IS1000; Not enough parameters specified
(No direction given for the IF shift)

IS+100; Not enough digits
(Only three frequency digits given)

IS+_1000; Unnecessary characters between parameters

IS+10000; Too many digits
(Five frequency digits given)

PARAMETER TABLE

Form No.	Name	No. of Digits	Format
1	SW	1	0: OFF 1: ON
2	MODE <i>Note: Applicable to Single Beep and Morse abbreviation modes.</i>	1	0: No mode 5: AM 1: LSB 6: FSK 2: USB 7: CW-R 3: CW 8: No Mode 4: FM 9: FSK-R
3	FUNCTION	1	0: VFO A 1: VFO B 2: MEMORY
4	FREQUENCY	11	Represented in Hz. Ex.: 00014230000 is 14.230 MHz
5	RIT/XIT FREQUENCY	5	The first digit is "+" or "-", and the remaining four digits indicate the frequency in Hz. Ex.: +5320 is +5.32 kHz "-" can be used for "+".
7	MEMORY CHANNEL	2	Represented using 00~99.
9	MEMORY CHANNEL SPLIT DATA	1	0: Receive 1: Transmit
10	MEMORY LOCKOUT	1	0: Not locked out 1: Locked out
11	TX/RX	1	0: Receive 1: Transmit
14	TONE NUMBER	2	Represents the Tone number (01~39). See the Subtone Table on page 85.
16	MODEL NUMBER	3	Represents the type of transceiver. The TS-870S number is 015.

Form No.	Name	No. of Digits	Format
22	METER VALUE	4	Represented using 0000 (min.)~0030 (max.). Relative values are output.
24	METER SWITCH	1	0: No selection 1: SWR 2: COMP 3: ALC
27	PLAYBACK CHANNEL	1	0: Not playing back. A Set command cancels playback. 1: Channel 1 2: Channel 2 3: Channel 3 4: Channel 4
30	ANTENNA TUNER	1	0: Antenna tuner thru 1: Antenna tuner in-line
31	GAIN	3	Represented using 000 (min.)~255 (max.).
32	AI NUMBER	1	0: AI OFF 1: IF command outputs its Answer command periodically. 2: For parameter changes, the corresponding Answer command is output. 3: Both 1 and 2.
33	ANTENNA NUMBER	1	1: ANT 1 2: ANT 2
34	CW BREAK-IN	1	1: Semi break-in ON 2: Full break-in ON
35	MENU NUMBER	3	Represented using 000~068.
36	MENU SELECTION	4	See table on page 87.
37	RECEIVE FILTER DISPLAY	8	Represented using 00000000~FFFFFFFDh.
38	FILTER WIDTH	4	Represented in units of 10 Hz using 0000~9999.
39	AGC TIME CONSTANT	3	Represented using 000 (min.)~255 (max.). 000~005: OFF
40	IF SHIFT DIRECTION	1	"+": Upward freq. shift (or "-") "-": Not used (error occurs).
41	IF SHIFT FREQUENCY	4	Represented in Hz using 0000~9999.

Format No.	Name	No. of Digits	Format
42	KEYER SPEED	3	Represented in words per minute using 001 (min.)~100 (max.).
43	KEYER MESSAGE	24	Contains the CW message.
44	KEYER BUFFER	1	0: Buffer space available 1: Buffer space not available
45	LOAD MESSAGE	1	0: Not recording. A Set command cancels recording. 1: Channel 1 2: Channel 2 3: Channel 3 4: Channel 4
46	LEVEL	3	Represented using 000 (min.)~255 (max.).
47	POWER CONTROL	3	Represented in watts using 010 (min.)~100 (max.).
48	RF ATTENUATOR	2	00: 0 dB 01: 6 dB 02: 12 dB 03: 18 dB
49	SEMI BREAK-IN DELAY TIME	4	Represented in msec using 0050~0800.
50	SYSTEM RESET	1	1: VFO Reset ([RX A]+ POWER ON) 2: MR Reset ([A=B]+ POWER ON)
51	VOX DELAY TIME	4	Represented in msec using 0150~2700.

SUBTONE TABLE FOR FORMAT NO.14

No.	Freq. (Hz)	No.	Freq. (Hz)	No.	Freq. (Hz)	No.	Freq. (Hz)
01	67.0	11	97.4	21	136.5	31	192.8
02	71.9	12	100.0	22	141.3	32	203.5
03	74.4	13	103.5	23	146.2	33	210.7
04	77.0	14	107.2	24	151.4	34	218.1
05	79.7	15	110.9	25	156.7	35	225.7
06	82.5	16	114.8	26	162.2	36	233.6
07	85.4	17	118.8	27	167.9	37	241.8
08	88.5	18	123.0	28	173.8	38	250.3
09	91.5	19	127.3	29	179.9	39	1750
10	94.8	20	131.8	30	186.2		

TYPES OF COMMANDS

Commands can be classified as shown below:

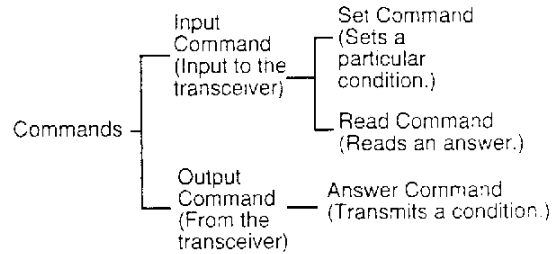

For example, note the following in the case of the FA command (Frequency of VFO A):

- To set the frequency to 7 MHz, the following command is sent from the computer to the transceiver:
"FA00007000000;" **(Set Command)**
- To read the frequency of VFO A, the following command is sent from the computer to the transceiver:
"FA;" **(Read Command)**
- When the Read Command above has been sent, the following command is returned to the computer:
"FA00007000000;" **(Answer Command)**

COMPUTER CONTROL COMMANDS

A summary of the command library for communication between a computer and the TS-870S is included in this section. This information can be used if you are developing your own transceiver control program, or you are troubleshooting an existing control application.

Command	Function
AC	Antenna Tuner THRU/IN-LINE, and tuning START/CANCEL
AG	Sets or reads AF gain.
AI	Auto information (OFF/ON)
AN	Selects antenna connector (ANT 1/ ANT 2).
BC	Sets or reads Beat Cancel.
BI	Sets or reads CW Break-in.
BY	Reads Busy signals.
CG	Sets or reads carrier gain.
DN	MIC DOWN function
EQ	Sets or reads Transmit Equalizer.
EX	Sets or reads Menu.
FA	Sets or reads VFO A frequency.

TERMINATOR

To signal the end of a command, it is necessary to use a semicolon (;). The digit where this special character must appear differs depending on commands.

● APPENDICES

Command	Function
FB	Sets or reads VFO B frequency.
FD	Reads RX filter dot display.
FR	Sets RX (VFO A/B, memory channel).
FS	Fine function (OFF/ON)
FT	Sets TX (VFO A/B, memory channel).
FW	Sets or reads filter bandwidth. For SSB and AM, sets or reads the high-pass filter cut-off frequency.
GT	Sets or reads AGC time constant.
ID	Reads model number of the transceiver.
IF	Reads status of the transceiver.
IS	Sets or reads IF shift. For SSB and AM, sets or reads the low-pass filter cut-off frequency.
KS	Sets or reads keying speed while using the KY command.
KY	Converts input characters into Morse code.
LK	Sets or reads Lock (OFF/ON).
LM	DRS recording
MC	Sets or reads memory channels.
MD	Sets or reads modes.
MG	Sets or reads MIC gain.
ML	Sets or reads transmit monitor level.
MN	Sets or reads Transmit Monitor (OFF/ON).
MR	Reads memory.
MW	Writes into memory.
MX	Sets or reads AIP (OFF/ON).
NB	Sets or reads Noise Blanker (OFF/ON).
NL	Sets or reads Noise Blanker level.
NR	Sets or reads Noise Reduction (OFF/ON).
NT	Sets or reads Notch Filter.
PB	DRS playback.
PC	Sets or reads transmit power.
PL	Sets or reads Speech Processor level.
PR	Sets or reads Speech Processor (OFF/ON).
PS	Sets or reads power (OFF/ON).
RA	Sets or reads RF ATT (attenuator).
RC	Clears RIT frequency.
RD	Lowers RIT frequency.
RG	Sets or reads RF gain.

Command	Function
RM	Selects a meter function or reads meter values.
RT	Sets or reads RIT (OFF/ON).
RU	Raises RIT frequency.
RX	Selects receive mode.
SC	Sets or reads Scan (OFF/ON).
SD	Sets or reads Semi Break-in delay time.
SM	S-meter and TX RF meter readings
SQ	Sets or reads squelch level.
SR	Resets the transceiver.
TX	Selects transmit mode.
UP	MIC UP function
VD	Sets or reads VOX delay time.
VR	Triggers the Voice Synthesizer for message output.
VX	Sets VOX (OFF/ON).
XT	Sets or reads XIT (OFF/ON).

ERROR MESSAGES

In addition to the Answer Command, the transceiver can send the following error messages:

Error Message	Reason for Error
?	<ul style="list-style-type: none"> Command syntax was incorrect. Command was not executed due to the current status of the transceiver (even though the command syntax was correct). <p><i>Note: Occasionally this message may not appear due to microprocessor transients in the transceiver.</i></p>
E;	A communication error occurred such as an overrun or framing error during a serial data transmission.
O;	Receive data was sent but processing was not completed.

COMMAND USE PRECAUTIONS

- 1 Do not use the control characters 00 to 1Fh since they are either ignored or cause a "?" answer.
- 2 Program execution may be delayed while turning the **Tuning** control rapidly.
- 3 Receive data is not processed if the frequency is entered from the keypad.

MENU SELECTION TABLE FOR "EX" COMMAND, PARAMETER 36

Menu No.	Menu Item	Parameter 36															
		0000	0001	0002	0003	0004	0005	0006	0007	0008	0009	0010	0011	0012	0013	0014	0015
00	MENU.A/B	A	B														
01	AUT/MAN	OFF	ON														
02/ 03/ 04/ 05	AGC SSB/ AGC CW/ AGC FSK/ AGC AM	OFF	1	2	3	4	5	6	7	8	9	10	11	12	13	14	15
		0016: 16	0017: 17	0018: 18	0019: 19	0020: 20											
06	AF.AGC	Slow	Med	Fast													
07	AF.AGC.LV	OFF	Min	Med	High	Max											
08	RX AT	OFF	ON														
09	P HOLD	OFF	ON														
10	Δ FREQ	OFF	ON														
11	AIP.GAIN	OFF	ON														
12	FM.S-MET	OFF	ON														
13	LINE.ENH	OFF	ON														
14	LINE.ENH	0(Fast)	1	2	3	4(Slow)											
15	SPAC (ms)	2	5	10	17												
16	SP.BEAT	0(Fast)	1	2	3	4(Slow)											
17	SP.NOTCH	0(Fast)	1	2	3	4(Slow)											
18	TRACK	OFF	ON														
19	PKT.FIL	OFF	1200	300	P												
20	PKT.IN (mV)	100	30	10													
21	PKT.OUT	0	1	2	3	4	5	6	7	8	9						
22	MIC AGC	Slow	Med	Fast													
23	CW RISE (ms)	2	4	6	8												
24	PITCH (Hz)	400	450	500	550	600	650	700	750	800	850	900	950	1000			
25	PROC.LOW	-6	-3	0	+3	+6											
26	PROC.HI	-6	-3	0	+3	+6											
27	TX INH	OFF	ON														
28	VOX.GAIN	0(Min)	1	2	3	4	5	6	7(Max)								
29	TX.WIDTH (Hz)	1800	2000	2300	2600	3000											
30	TX.SHIFT (Hz)	0	100	200	300	400	500										
31	TX EQ.	High	Comb	Bass													
32	AUTO.RET	OFF	ON														
33	TUN.WIDE	OFF	ON														
34	AUT.MODE	OFF	ON														
35	BEEP	OFF	ON														
36	BP. MODE	OFF	ON														
37	WARN. BP	OFF	ON														
38	BP LV	0	1	2	3	4	5	6	7	8	9						
39	REPEAT	OFF	ON														
40	REP.TIME (sec)	1	2	3	4	5	10	15	20	25	30	35	40	45	50	55	60
41	F.STEP (kHz)	5	10														
42	BC. STEP	OFF	ON														
43	CH. STEP (kHz)	1	5	10													
44	STEP.ADJ	OFF	ON														
45/ 46/ 47/ 48	PF.KEY.UL/ PF.KEY.UR/ PF.KEY.LR/ PF.KEY.LL	OFF: 0000 Menu Nos. 00-68: 0001-0069 Function Nos. 69-73: 0070-0074															
49	CH.SHIFT	OFF	ON														
50	DIMMER	Low	High														

● APPENDICES

Menu No.	Menu Item	0000	0001	0002	0003	0004	0005	0006	0007	0008	0009	0010	0011	0012	0013	0014	0015
51	LINEAR	OFF	Fast	Slow													
52	1M/500k (kHz)	100	500	1000													
53	EXT RX	OFF	ON														
54	TRANSFER	OFF	ON														
55	DIRECT	OFF	ON														
56	COM.RATE ¹	12 1	24 1	48 1	48 2	96 1	192 1	384 1	576 1								
57	SUB.TONE	Sub Tone Nos. 01~39: 0001~0039															
58	SUB.TONE	B	C														
59	FM.BOOST	OFF	ON														
60	FM WIDE	OFF	ON														
61	FM MIC	Low	High														
62	FSK.SHFT (Hz)	170	200	425	850												
63	MARK.POL	OFF	ON														
64	FSK.TONE (Hz)	1275	2125														
65	PG.S.HOLD	OFF	ON														
66	GRP.SCAN	OFF	ON														
67	BSY.STOP	OFF	ON														
68	CAR.SCAN	OFF	ON														

¹To reliably use the 38400 or 57600 bps transfer rates, the serial port of your computer must support these high-speed communications parameters.

● APPENDICES

BC BEAT CANCEL

Function	Parameter	Format	Parameter function
Sets or reads Beat Cancel.	P1	1	BEAT CANCEL OFF/ON
Input Set	1 2 3 4 5 6 7 8 9 10 11 12 13 14 B C P1		
Input Read	1 2 3 4 5 6 7 8 9 10 11 12 13 14 B C		
Output Answer	1 2 3 4 5 6 7 8 9 10 11 12 13 14 B C P1		

EG EQUALIZER

Function	Parameter	Format	Parameter function
Sets or reads Transmit Equalizer.	P1	1	TRANSMIT EQUALIZER
Input Set	1 2 3 4 5 6 7 8 9 10 11 12 13 14 E Q P1		
Input Read	1 2 3 4 5 6 7 8 9 10 11 12 13 14 E Q		
Output Answer	1 2 3 4 5 6 7 8 9 10 11 12 13 14 E Q P1		

BI BREAK IN

Function	Parameter	Format	Parameter function
Sets or reads CW Break-in	P1	34	BREAK-IN OFF/ON
Input Set	1 2 3 4 5 6 7 8 9 10 11 12 13 14 B I P1		
Input Read	1 2 3 4 5 6 7 8 9 10 11 12 13 14 B I		
Output Answer	1 2 3 4 5 6 7 8 9 10 11 12 13 14 B I P1		
Note: The setting for P1 is not linked with the VOX OFF/ON parameter.			

EX EXTENSION MENU

Function	Parameter	Format	Parameter function
Sets or reads Menu.	P1	35	MENU NUMBER
Input Set	1 2 3 4 5 6 7 8 9 10 11 12 13 14 E X P1 P2		
Input Read	1 2 3 4 5 6 7 8 9 10 11 12 13 14 E X		
Output Answer	1 2 3 4 5 6 7 8 9 10 11 12 13 14 E X P1 P2		
Input Set	1 2 3 4 5 6 7 8 9 10 11 12 13 14 P2		
Output Answer	1 2 3 4 5 6 7 8 9 10 11 12 13 14 MENU SELECTION		

BY BUSY

Function	Parameter	Format	Parameter function
Reads Busy signals.	P1	1	BUSY OFF/ON
Input Set	1 2 3 4 5 6 7 8 9 10 11 12 13 14 B Y		
Input Read	1 2 3 4 5 6 7 8 9 10 11 12 13 14 B Y		
Output Answer	1 2 3 4 5 6 7 8 9 10 11 12 13 14 B Y P1		

FA FB FREQUENCY VFO A/ VFO B

Function	Parameter	Format	Parameter function
Sets or reads VFO A/ VFO B frequency.	P1	4	FREQUENCY
Input commands Set command	1 2 3 4 5 6 7 8 9 10 11 12 13 14 F A/B P1		
Input commands Read command	15 16 17 18 19 20 21 22 23 24 25 26 27 28 F A/B		
Output commands Answer command	1 2 3 4 5 6 7 8 9 10 11 12 13 14 F A/B P1		
Output commands Answer command	15 16 17 18 19 20 21 22 23 24 25 26 27 28 29 30 31 32 33 34 35 36 37 38 39 40 41 42		

CG CARRIER GAIN

Function	Parameter	Format	Parameter function
Sets or reads carrier gain.	P1	31	CARRIER GAIN
Input Set	1 2 3 4 5 6 7 8 9 10 11 12 13 14 C G P1		
Input Read	1 2 3 4 5 6 7 8 9 10 11 12 13 14 C G		
Output Answer	1 2 3 4 5 6 7 8 9 10 11 12 13 14 C G P1		

FD RX FILTER DOT DISPLAY

Function	Parameter	Format	Parameter function
Reads RX filter dot display.	P1	37	RX FILTER DISPLAY
Input Set	1 2 3 4 5 6 7 8 9 10 11 12 13 14 F D		
Input Read	1 2 3 4 5 6 7 8 9 10 11 12 13 14 F D		
Output Answer	1 2 3 4 5 6 7 8 9 10 11 12 13 14 F D P1		
Note: The 8-digit hex data is converted to 32-bit binary data. Each bit corresponds to a single dot on the 30-dot display. When the bit is ON, the display dot is ON and vice versa. Bit 32(MSB) corresponds to the left-most dot, bit 3 corresponds to right-most dot. Bits 1 and 2 are always OFF (not used).			

DN UP DOWN/UP

Function	Parameter	Format	Parameter function
Microphone DOWN/UP function.			
Input Set	1 2 3 4 5 6 7 8 9 10 11 12 13 14 DN/UP		
Input Read	1 2 3 4 5 6 7 8 9 10 11 12 13 14		
Output Answer	1 2 3 4 5 6 7 8 9 10 11 12 13 14		

Downloaded by 

Amateur Radio Directory

FR FUNCTION RX, FUNCTION TX

Function	Parameter	Format	Parameter function
Sets RX/TX (VFO A/B, memory channel).	P1	3	FUNCTION
Input Set	F R T P1		
Input Read	F R T		
Output Answer	F R T P1		

FS FINE STEP

Function	Parameter	Format	Parameter function
Fine tuner OFF/ON	P1	1	FINE OFF/ON
Input Set	F S P1		
Input Read	F S		
Output Answer	F S P1		

FW FILTER WIDTH

Function	Parameter	Format	Parameter function
Sets or reads filter bandwidth. For SSB and AM, sets or reads the high-pass filter cut-off frequency.	P1	38	FILTER WIDTH
Input Set	F W P1		
Input Read	F W		
Output Answer	F W P1		

Note:
 Allowable data (units of 10 Hz):
 SSB 0.5, 10, 20, 30, 40, 50, 60, 80, 100
 CW 5, 10, 20, 40, 60, 100
 FSK 25, 50, 100, 150
 FM 500, 600, 800, 1000, 1200, 1400
 AM 0.10, 20, 50

GT AUTO GAIN CONTROL TIME CONSTANT

Function	Parameter	Format	Parameter function
Sets or reads AGC time constant.	P1	35	AGC TIME CONSTANT
Input Set	G T P1		
Input Read	G T		
Output Answer	G T P1		

IG IDENTIFICATION

Function	Parameter	Format	Parameter function
Reads Model number of the transceiver.	P1	16	MODEL NUMBER
Input Set	I G		
Input Read	I G		
Output Answer	I G P1		

IF INFORMATION

Function	Parameter	Format	Parameter function
Reads status of the transceiver.	P1	4	FREQUENCY
Input Set command	P2		
Input Read command	P3		
Output Answer command	P4		
Output Answer command	P5		
Output Answer command	P6		
Output Answer command	P7		
Output Answer command	P8		
Output Answer command	P9		
Output Answer command	P10		
Output Answer command	P11		
Output Answer command	P12		
Output Answer command	P13		
Output Answer command	P14		
Output Answer command	P15		

IF SHIFT

Function	Parameter	Format	Parameter function
Sets or reads IF shift. For SSB and AM, sets or reads the low-pass filter cut-off frequency.	P1	40	IF SHIFT (PROGRAM)
Input Set	I F P1 P2		
Input Read	I F		
Output Answer	I F P1 P2		

Note:
 P2 is positive or zero. P1 can be "-" or "
 Allowable data (in units of Hz):
 SSB 400, 1600, 1800, 2600, 2200
 2400, 2600, 2800, 3000, 3400, 4600, 6000
 AM 2500, 3000, 4000, 5000, 6300, 7300
 CW 400-1000 (50 Hz steps)

KS KEYSPEED

Function	Parameter	Format	Parameter function
Sets or reads keying speed while using the 'K' command.	P1	42	KEYSPEED
Input Set	K S P1		
Input Read	K S		
Output Answer	K S P1		

KW KEYING

Function	Parameter	Format	Parameter function
Converts input characters into Morse code.	P1	43	KEYER MESSAGE
Input Set command	P2		
Input Read command	P3		
Output Answer command	P4		
Output Answer command	P5		
Output Answer command	P6		
Output Answer command	P7		
Output Answer command	P8		
Output Answer command	P9		
Output Answer command	P10		
Output Answer command	P11		
Output Answer command	P12		
Output Answer command	P13		
Output Answer command	P14		
Output Answer command	P15		

Note:
 The Set command requires a " " ASCII code 26h, in the 1st byte position (insert " " to bypass that byte to characters to make a 28-byte (16-length) command.
 The " " bytes will not send any character.
 Supported characters include letters (numbers), " (), * + = ^
 The memory buffer allows up to 14 characters to be continuously keyed. For programs that convert to Morse code immediately after entry, more continuous keying is possible.
 Ex:
 QO QO QO DE W6D6LY W6D6LY W6D6LY K
 *KY_QO_QO_QO DE W6D6LY W6D6LY K
 !KY_Y_W6D6LY K

APPENDICES

LK LOCK

Function	Parameter	Format	Parameter function
Sets Lock OFF/ON or reads status.	P1	1	LOCK OFF/ON
Input Set	1 2 3 4 5 6 7 8 9 10 11 12 13 14 L K P1 :		
Input Read	1 2 3 4 5 6 7 8 9 10 11 12 13 14 L K :		
Output Answer	1 2 3 4 5 6 7 8 9 10 11 12 13 14 L K P1 :		

ML TRANSMIT MONITOR LEVEL

Function	Parameter	Format	Parameter function
Sets or reads transmit monitor level.	P1	46	TRANSMIT MONITOR LEVEL
Input Set	1 2 3 4 5 6 7 8 9 10 11 12 13 14 M L P1 :		
Input Read	1 2 3 4 5 6 7 8 9 10 11 12 13 14 M L :		
Output Answer	1 2 3 4 5 6 7 8 9 10 11 12 13 14 M L P1 :		

LM LOAD MESSAGE

Function	Parameter	Format	Parameter function
DRS recording	P1	45	LOAD MESSAGE
Input Set	1 2 3 4 5 6 7 8 9 10 11 12 13 14 L M P1 :		
Input Read	1 2 3 4 5 6 7 8 9 10 11 12 13 14 L M :		
Output Answer	1 2 3 4 5 6 7 8 9 10 11 12 13 14 L M P1 :		

MN TRANSMIT MONITOR

Function	Parameter	Format	Parameter function
Sets Transmit Monitor OFF/ON or reads status.	P1	1	TRANSMIT MONITOR OFF/ON
Input Set	1 2 3 4 5 6 7 8 9 10 11 12 13 14 M N P1 :		
Input Read	1 2 3 4 5 6 7 8 9 10 11 12 13 14 M N :		
Output Answer	1 2 3 4 5 6 7 8 9 10 11 12 13 14 M N P1 :		

MC MEMORY CHANNEL

Function	Parameter	Format	Parameter function
Sets or reads memory channels.	P1	-	NOT USED
	P2	7	MEMORY CHANNEL
Input Set	1 2 3 4 5 6 7 8 9 10 11 12 13 14 M C P2 :		
Input Read	1 2 3 4 5 6 7 8 9 10 11 12 13 14 M C :		
Output Answer	1 2 3 4 5 6 7 8 9 10 11 12 13 14 M C P2 :		

MR MEMORY READ

Function	Parameter	Format	Parameter function
Reads memory.	P1	9	SPLIT DATA
	P2	-	NOT USED
	P3	7	MEMORY CHANNEL
	P4	4	FREQUENCY
	P5	2	MODE
	P6	10	MEMORY LOCKOUT
	P7	1	STONE OFF/ON
	P8	14	STONE NUMBER
	P9	-	NOT USED
Input commands Set command	1 2 3 4 5 6 7 8 9 10 11 12 13 14 15 16 17 18 19 20 21 22 23 24 25 26 27 28		
Input commands Read command	1 2 3 4 5 6 7 8 9 10 11 12 13 14 M R P1 P3 :		
Output commands Answer command	1 2 3 4 5 6 7 8 9 10 11 12 13 14 15 16 17 18 19 20 21 22 23 24 25 26 27 28 29 30 31 32 33 34 35 36 37 38 39 40 41 42		
	Note: For a vacant channel, the Answer command sends "0" for all parameters except the memory channel number. P1 must be "0" to read the CH 99 Start frequency and "1" to read the End frequency.		

MD MODE

Function	Parameter	Format	Parameter function
Sets or reads modes.	P1	2	MODE
Input Set	1 2 3 4 5 6 7 8 9 10 11 12 13 14 M D P1 :		
Input Read	1 2 3 4 5 6 7 8 9 10 11 12 13 14 M D :		
Output Answer	1 2 3 4 5 6 7 8 9 10 11 12 13 14 M D P1 :		

MW MEMORY WRITE

Function	Parameter	Format	Parameter function
Writes into memory.	P1	9	SPLIT DATA
	P2	-	NOT USED
	P3	7	MEMORY CHANNEL
	P4	4	FREQUENCY
	P5	2	MODE
	P6	10	MEMORY LOCKOUT
	P7	1	STONE OFF/ON
	P8	14	STONE NUMBER
	P9	-	NOT USED
Input commands Set command	1 2 3 4 5 6 7 8 9 10 11 12 13 14 15 16 17 18 19 20 21 22 23 24 25 26 27 28		
Input commands Read command	1 2 3 4 5 6 7 8 9 10 11 12 13 14 15 16 17 18 19 20 21 22 23 24 25 26 27 28		
Output commands Answer command	1 2 3 4 5 6 7 8 9 10 11 12 13 14 15 16 17 18 19 20 21 22 23 24 25 26 27 28 29 30 31 32 33 34 35 36 37 38 39 40 41 42		
	Note: All parameters must be entered. The memory channel becomes a vacant channel if all frequency digits are "0". Other parameters are ignored. P1 must be "0" to store a Start frequency and "1" to store an End frequency.		

MG MIC GAIN

Function	Parameter	Format	Parameter function
Sets or reads MIC gain.	P1	31	MIC GAIN
Input Set	1 2 3 4 5 6 7 8 9 10 11 12 13 14 M G P1 :		
Input Read	1 2 3 4 5 6 7 8 9 10 11 12 13 14 M G :		
Output Answer	1 2 3 4 5 6 7 8 9 10 11 12 13 14 M G P1 :		

M4 MIXER		Parameter	Format	Parameter function
Function	Sets A/P OFF-ON or reads status.			
Input	Start M X P1			
Input	Read M X			
Output	Answer M X P1			

PB PLAYBACK		Parameter	Format	Parameter function
Function	DRS Playback			
Input	Start P B P1			
Input	Read P B			
Output	Answer P B P1			

NE NOISE BLANKER		Parameter	Format	Parameter function
Function	Sets Noise Blanker OFF-ON or reads status.			
Input	Start N E P1			
Input	Read N E			
Output	Answer N E P1			

PC POWER CONTROL		Parameter	Format	Parameter function
Function	Sets or reads transmit power.			
Input	Start P C P1			
Input	Read P C			
Output	Answer P C P1			

N2 NOISE BLANKER LEVEL		Parameter	Format	Parameter function
Function	Sets or reads Noise Blanker level.			
Input	Start N L P1			
Input	Read N L			
Output	Answer N L P1			

PL SPEECH PROCESSOR LEVEL		Parameter	Format	Parameter function
Function	Sets or reads Speech Processor level			
Input	Start P L P1 P2			
Input	Read P L			
Output	Answer P L P1 P2			

NP NOISE REDUCTION		Parameter	Format	Parameter function
Function	Sets Noise Reduction OFF-ON or reads status			
Input	Start N R P1			
Input	Read N R			
Output	Answer N R P1			

PF SPEECH PROCESSOR		Parameter	Format	Parameter function
Function	Sets Speech Processor OFF-ON or reads status			
Input	Start P F P1			
Input	Read P F			
Output	Answer P F P1			

N7 NOTCH		Parameter	Format	Parameter function
Function	Sets or reads Notch Filter.			
Input	Start N T P1			
Input	Read N T			
Output	Answer N T P1			

PS POWER SWITCH		Parameter	Format	Parameter function
Function	Sets Power OFF-ON or reads status.			
Input	Start P S P1			
Input	Read P S			
Output	Answer P S P1			

● APPENDICES

RA RF ATTENUATOR

Function	Parameter	Format	Parameter function
Sets or reads RF ATT(Attenuator).	P1	48	ATTENUATOR
Input Set	1 2 3 4 5 6 7 8 9 10 11 12 13 14 R A P1 :		
Input Read	1 2 3 4 5 6 7 8 9 10 11 12 13 14 R A :		
Output Answer	1 2 3 4 5 6 7 8 9 10 11 12 13 14 R A P1 :		

RT RIT

Function	Parameter	Format	Parameter function
Sets RIT OFF/ON or reads status.	P1	1	RIT OFF/ON
Input Set	1 2 3 4 5 6 7 8 9 10 11 12 13 14 R T P1 :		
Input Read	1 2 3 4 5 6 7 8 9 10 11 12 13 14 R T :		
Output Answer	1 2 3 4 5 6 7 8 9 10 11 12 13 14 R T P1 :		

RC RIT CLEAR

Function	Parameter	Format	Parameter function
Sets the RIT frequency shift to 0.			Note: This command also clears the XIT frequency (same as RIT shift). The command functions independently from the RIT/XT control.
Input Set	1 2 3 4 5 6 7 8 9 10 11 12 13 14 R C :		
Input Read	1 2 3 4 5 6 7 8 9 10 11 12 13 14 /		
Output Answer	1 2 3 4 5 6 7 8 9 10 11 12 13 14 /		

RX TX RX, TX

Function	Parameter	Format	Parameter function
Selects receive/transmit mode.			
Input Set	1 2 3 4 5 6 7 8 9 10 11 12 13 14 R X T X :		
Input Read	1 2 3 4 5 6 7 8 9 10 11 12 13 14 /		
Output Answer	1 2 3 4 5 6 7 8 9 10 11 12 13 14 R X T X :		

RD RU RIT DOWNUP

Function	Parameter	Format	Parameter function
Lowers/raises RIT frequency.			Note: This command also affects the XIT frequency (same as RIT shift). The command functions independently from the RIT/XT control.
Input Set	1 2 3 4 5 6 7 8 9 10 11 12 13 14 R D U :		
Input Read	1 2 3 4 5 6 7 8 9 10 11 12 13 14 /		
Output Answer	1 2 3 4 5 6 7 8 9 10 11 12 13 14 /		

SC SCAN

Function	Parameter	Format	Parameter function
Sets Scan OFF/ON or reads status.	P1	1	SCAN OFF/ON
Input Set	1 2 3 4 5 6 7 8 9 10 11 12 13 14 S C P1 :		
Input Read	1 2 3 4 5 6 7 8 9 10 11 12 13 14 S C :		
Output Answer	1 2 3 4 5 6 7 8 9 10 11 12 13 14 S C P1 :		

RG RF GAIN

Function	Parameter	Format	Parameter function
Sets or reads RF gain.	P1	31	RF GAIN
Input Set	1 2 3 4 5 6 7 8 9 10 11 12 13 14 R G P1 :		
Input Read	1 2 3 4 5 6 7 8 9 10 11 12 13 14 R G :		
Output Answer	1 2 3 4 5 6 7 8 9 10 11 12 13 14 R G P1 :		

SD SEMI BREAK-IN DELAY TIME

Function	Parameter	Format	Parameter function
Sets or reads Semi Break-in delay time.	P1	49	SEMI BREAK-IN DELAY TIME
Input Set	1 2 3 4 5 6 7 8 9 10 11 12 13 14 S D P1 :		
Input Read	1 2 3 4 5 6 7 8 9 10 11 12 13 14 S D :		
Output Answer	1 2 3 4 5 6 7 8 9 10 11 12 13 14 S D P1 :		

RM READ METER

Function	Parameter	Format	Parameter function
Selects a meter function or reads meter values.	P1	24	METER SWITCH
	P2	22	METER VALUE
Input Set	1 2 3 4 5 6 7 8 9 10 11 12 13 14 R M P1 :		
Input Read	1 2 3 4 5 6 7 8 9 10 11 12 13 14 R M :		
Output Answer	1 2 3 4 5 6 7 8 9 10 11 12 13 14 R M P1 P2 :		

SM S-METER

Function	Parameter	Format	Parameter function
S-meter and TX RF meter readings.	P1	22	S-METER VALUE
Input Set	1 2 3 4 5 6 7 8 9 10 11 12 13 14 /		
Input Read	1 2 3 4 5 6 7 8 9 10 11 12 13 14 S M :		
Output Answer	1 2 3 4 5 6 7 8 9 10 11 12 13 14 S M P1 :		

SO SQUELCH LEVEL

Function	Parameter	Format	Parameter function
Sets or reads squelch level.	P1	40	SQUELCH LEVEL
Input Set	1 2 3 4 5 6 7 8 9 10 11 12 13 14 S Q P1		
Input Read	1 2 3 4 5 6 7 8 9 10 11 12 13 14 S Q		
Output Answer	1 2 3 4 5 6 7 8 9 10 11 12 13 14 S Q P1		

XI XT

Function	Parameter	Format	Parameter function
Sets XT OFF/ON.	P1	1	XT OFF/ON
Input Set	1 2 3 4 5 6 7 8 9 10 11 12 13 14 X T P1		
Input Read	1 2 3 4 5 6 7 8 9 10 11 12 13 14 X T		
Output Answer	1 2 3 4 5 6 7 8 9 10 11 12 13 14 X T P1		

SF SYSTEM RESET

Function	Parameter	Format	Parameter function
Resets the transceiver.	P1	50	SYSTEM RESET
Input Set	1 2 3 4 5 6 7 8 9 10 11 12 13 14 S R P1		
Input Read	1 2 3 4 5 6 7 8 9 10 11 12 13 14		
Output Answer	1 2 3 4 5 6 7 8 9 10 11 12 13 14		

VD VOX DELAY TIME

Function	Parameter	Format	Parameter function
Sets or reads VOX delay time.	P1	5*	VOX DELAY TIME
Input Set	1 2 3 4 5 6 7 8 9 10 11 12 13 14 V D P1		
Input Read	1 2 3 4 5 6 7 8 9 10 11 12 13 14 V D		
Output Answer	1 2 3 4 5 6 7 8 9 10 11 12 13 14 V D P1		

VF VOICE RECALL

Function	Parameter	Format	Parameter function
Triggers the Voice Synthesizer for message output.			
Input Set	1 2 3 4 5 6 7 8 9 10 11 12 13 14 V R		
Input Read	1 2 3 4 5 6 7 8 9 10 11 12 13 14		
Output Answer	1 2 3 4 5 6 7 8 9 10 11 12 13 14		

VX VOX FUNCTION

Function	Parameter	Format	Parameter function
Sets VOX OFF/ON.	P1	1	VOX OFF/ON
Input Set	1 2 3 4 5 6 7 8 9 10 11 12 13 14 V X P1		
Input Read	1 2 3 4 5 6 7 8 9 10 11 12 13 14 V X		
Output Answer	1 2 3 4 5 6 7 8 9 10 11 12 13 14 V X P1		

INDEX

Accessories		Cleaning	69	Subtone, Frequency	39
Connecting	4	Clover		Subtone, Type	39
Connector (ACC 2)	7	Connection (ACC 2)	6	Transmitting	38
Optional, Available	74	Operation	41	Frequency	
Optional, Installing	75	Computer Control		Difference, Display	43
Supplied	1	Commands	85	Fine Tuning	21
Adjustments, Internal	70	Communication		Keypad Entry	22
Advanced Intercept Point	53	Parameters	50	Modulation (see FM)	
AGC	44	Connection	5	Rounding	21
AIP	53	Connector (COM)	83	Step Size	21
Alarms	65	Contents	ii	Tuning	21
AM		Conventions, Writing Inside Front Cover		Front Panel	10
Frequencies, Popular	40	Correlation, Automatic	53	FSK (see RTTY)	
Transmitting	40	CW		Full Reset	63
Amplifier, Linear		Break-in, Full	31	Fuses, Replacing	3, 70
Connection (REMOTE)	5	Break-in, Semi	31	Gain	
Amplitude Modulation (see AM)		Pitch	30	AF	19
AMTOR		Reverse	31	RF	19
Connection (ACC 2)	6	Sidetone, Frequency	30	G-TOR	
Frequencies, Popular	41	Sidetone, Volume	30	Connection (ACC 2)	6
Operation	41	Time, Decay	31	Operation	41
Antenna		Time, Rise	31	Headphones Jack (PHONES)	4
Connection	2	Transmitting	30	Hold	
External receiver		Zero Beating	30	Peak Meter	22
(EXT RX ANT)	2	Data Transfer Function		Scan	60
Feed Line Loss	2	(see Transfer Function)		Installation	
1 / 2	2, 63	Diagrams		Antenna Connection	2
Antenna Tuner		Block	Insert	DC Power Connection	3
External, Connection	6	Schematic	Insert	Ground Connection	3
External, Operation	50	Digital Recording System (optional)		Lightning Protection	3
Operation	49	Installation	75	Internal Adjustments	70
Preset Bands	49	Message Interval	68	Key	
Presetting	49	Playback, Single Time	67	Connection	4
Appendices		Playback, Multiple Times	68	Jack (PADDLE/KEY)	4
COM Connector Protocol	83	Recording	67	Keyer, Electronic	
General Coverage Receiver		Digital Signal Processing		Commands, Function	36
for SWLing	82	(see DSP)		Defaults	32
HF Beacons	80	Display	16	Features	32
Learning About DSP	79	Display Dimmer	65	Functions, Embedded	37
NCDXF/IARU Beacons	80	DRS		Functions, Inquiry	35
Standard Time Stations	80	(see Digital Recording System)		Functions, Multiple-Button	33
ATT	53	DSP		Learning Outline	32
Attenuator, RF	53	Adaptive Filters	52	Messages, Erasing	35
Automatic Gain Control	44	Auto Notch	52	Messages, Playing	34
Automatic Mode	48	Beat Cancel	52	Messages, Storing	34
Auto Notch	52	Introduction	1	Options, Emulation	33
Backup, Memory	54	Learning About DSP	79	Options, Serial Number	37
Bands, Changing	20	Line Enhance	53	Linear Amplifier	
Beacons (see Appendices)		Noise Reduction	53	Connection (REMOTE)	5
Beat Cancel	52	SPAC Filter	53	Line Enhance	53
Beep Function	64	External Speaker (EXT SP)	4	Lock Function	64
Break-in, Full/Semi (see CW)		FAX/Facsimile		Lockout, Memory Channels	62
Busy Frequency Stop	61	Connection	6	LSB (see SSB)	
Button Confirmation	65	Frequencies, Popular	29	Maintenance	69
Block Diagram	Insert	Operation	29	Memory	
Carrier Level	23	FCC Information	Inside Front Cover	Backup	54
Carrier-Operated Scan		Features	1	Channels	
Resume	61	First QSO, Your	8	(see Memory Channels)	
CHECK Alarm	65	FM		Quick (see Memory Channels)	
		Band Plan	39	Reset, Full	63
		Repeaters	38	Reset, Partial	63

Memory Channels		PacTOR		SSTV	
Channel 99	54	Connection (ACC 2)	6	Connection	6
Conventional	54	Operation	41	Frequencies, Popular	29
Erasing	57	Partial Reset	63	Operation	29
Lockout	62	Power		Standard Time Stations	80
Quick, Recalling	59	Connecting DC	3	Station Monitor, Connection	6
Quick, Storing	59	Switching ON/OFF	19	Supplied Accessories	1
Quick, Transfers to VFO	59	Transmit Output	23	SWLing	82
Quick, Tunable	59	Precautions, Safety	i	TCXO (optional), Installation	76
Recalling	55	Program Scan	60	TF-Set	43
Resetting	57	Programmable		Thank You!	1
Scanning, All-Channel	61	Buttons, Assigning	64	Time-Operated Scan Resume	61
Scanning, Group	62	Buttons, Using	64	Time Stations	80
Scrolling	56	VFO	58	Transfer Function	
Searching, Programmed	55	QSO, Your First	8	Equipment, Compatible	65
Searching, Vacant	55	Quick Memory		Equipment, Connection	66
Start/End Frequencies	58	(see Memory Channels, Quick)		Equipment, Needed	65
Storing, Scan Limits	58	Rear Panel	15	Using	66
Storing, Simplex	54	Receiving		Transmitting	
Storing, Split-Frequency	55	Bandwidth	52	AM	40
Transfer, To Memory	57	IF Shift	51	AMTOR	41
Transfer, To VFOs	56	Recording, Digital System		Audio Equalizer	47
Tunable	56	(see Digital Recording System)		Bandshift	47
Memory Scan	61	Reset		Bandwidth	47
Menu		Full	63	Bandwidth/Bandshift Table	47
Access	24	Menu	24	Clover	41
Configuration	25	Partial	63	CW	30
Cross Reference	28	RF Attenuator	53	FM	38
Description	24	RIT	44	Frequency, Changing	46
Quick, Programming	24	RTTY		FSK	40
Quick, Using	24	Connection (RTTY, ACC 2) ...	5, 7	G-TOR	41
Resetting, Temporary	24	Frequencies, Popular	41	Inhibit	45
Meter		Operation	40	Methods	23
Functions	22	Reverse	41	Monitor	46
Peak Hold	22	Safety Precautions	i	Packet	41
Microphone		Satellite Operation	43	PacTOR	41
AGC	47	Scan		RTTY	40
Compatible	4	Busy Frequency Stop	61	SSB	29
Connector (MIC)	4	Hold	60	SSTV	29
Gain	23	Memory, All-Channel	61	Troubleshooting	71
Operation	14	Memory, Group	62	Tuning, Slope	51
Mode		Lockout	62	USB (see SSB)	
Automatic, Selecting	48	Program	60	VFO	
Automatic, Overriding	48	Resume, Carrier-Operated	61	Equalizing A/B	20
Selecting	20	Resume, Time-operated	61	Programmable	58
Morse (see CW)		Speed	62	Selecting A/B	19
Morse Alarms	65	Start/End Frequencies	60	Voice-Operated Transmit	
Noise		Schematic Diagram	Insert	(see VOX)	
Blanker	53	Service Information	69	Voice Synthesizer (optional)	
Reduction	53	Single Sideband (see SSB)		Installation	75
Optional Accessories		Slope Tuning	51	Using	68
Available	74	SPAC Filter	53	Volume	
Installation	75	Speaker, External (EXT SP)	4	AF Gain	19
Orientation		Specifications	77	RF Gain	19
Display	16	Speech Processor	23, 46	VOX	
Front Panel	10	Split-Frequency Operation	42	Adjusting Delay	45
Rear Panel	15	Squelch	19	Adjusting Microphone	
OVER Alarm	65	SSB, Transmitting	29	Level	45
Packet				XIT	45
Connection (ACC 2)	6				
Frequencies, Popular	42				
Operation	41				

KENWOOD

Downloaded by

Amateur Radio Directory
