

NATIONAL RADIO COMPANY, INC. • 37 WASHINGTON ST., MELROSE, MASS. 02176

**HRO-500 SOLID STATE
COMMUNICATIONS RECEIVER**

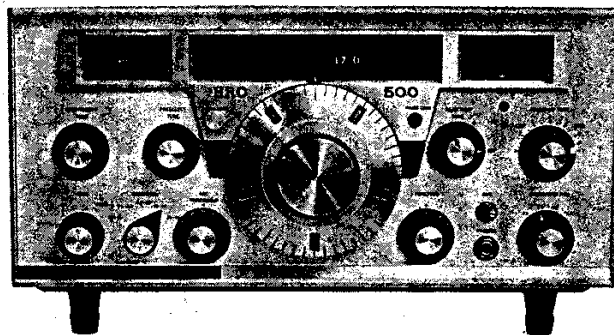

ONE YEAR GUARANTEE

You now own a product manufactured by one of the world's oldest and most highly respected manufacturers of quality communications equipment. National Radio Company, Inc. has manufactured superb communications devices for nearly half a century. Our experience is unequalled. More than 75 per cent of our highly skilled test and assembly people have been with us for more than 25 years — an astonishing record in the relatively young electronics industry. Our people know their business . . . take pride in their fine workmanship — workmanship so outstanding that many National Radio Company, Inc. receivers purchased over 30 years ago are still in daily use.

We manufacture most of the components used in our equipment . . . and, in fact, National Radio Company, Inc. has been a prime supplier of electronic components to other important electronic manufacturers and government agencies for many years. As a result, we enjoy unusual control of component part quality.

We strongly recommend that you carefully study the instruction manual before attempting to use your new equipment. We are sure you will find that maximum performance will be achieved with complete understanding of its controls and operating features.

Your new National Radio Company, Inc. equipment has undergone an intense series of rigid quality control tests. However, as with any complex electronic equipment, it is possible that a defect may appear as a result of rough handling during shipment or through circumstances beyond our immediate control. For this reason, we suggest that you inspect your new equipment for such damage as soon as it is unpacked. In all cases of in-transit damage a claim must be filed against the carrier.

The component parts of this equipment (exclusive of vacuum tubes and transistors) are guaranteed to be free from defective material and workmanship, and repair or replacement will be made on any part found to be defective upon examination, provided that the unit is delivered to your dealer, authorized service agency or to the company, pursuant to the instructions below, within one year from the date of sale to original purchaser. On units returned during the initial 90 day period, National Radio Company, Inc. will absorb the labor cost of installation; for the remainder of the guarantee period the customer will be charged for such cost. The enclosed guarantee card must be returned to National Radio Company, Inc., within ten days from date of purchase in order to validate the guarantee. Naturally, this guarantee does not extend to any product

which has been subjected to misuse, neglect, accident, improper installations, or use in violation of instructions furnished by us. Nor does it extend to units which have been repaired or altered outside of our factory or its authorized agencies, nor to units where the serial number has been removed or defaced.

Should your new National Radio Company, Inc. equipment require servicing please do one of the following, whichever is most convenient:

1. Return it to the dealer from whom you purchased it.
2. Bring it to one of our authorized service agencies.
3. Write to the Service Manager, National Radio Company, Inc., 37 Washington Street, Melrose, Mass. and describe the difficulty. State type of unit and serial number. Describe as completely as possible the apparent defect. If we feel that the unit should be returned to the factory we will give you written authorization to ship the unit to us. Notify us that you are returning the unit and ship prepaid and fully insured in the original specially designed shipping carton.

Your unit will receive prompt and careful attention. If, in our judgment the unit is indeed defective, repair or replacement will be made at no cost to you if the unit is returned within 90 days after date of original purchase. Should the unit be returned to us after 90 days from date of purchase but before 365 days have elapsed, again, if in our judgment the unit is indeed defective, National Radio Company, Inc. will provide a replacement of any such defective part (except vacuum tubes or transistors). If you wish us to install the part, you will be billed only for labor costs involved. At the end of one year, after expiration of guarantee, service will be billed to you at cost of parts and labor only.

This extended guarantee supersedes all previous warranties of National Radio Company, Inc. and is in lieu of all other warranties expressed or implied. Damages arising out of a breach of this guarantee are limited to repair or replacement of the defective part as stated above. We naturally reserve the right to change or improve our products without imposing any obligation upon ourselves to so modify products previously manufactured. Your new National Radio Company, Inc. equipment is the finest of its type. It was skillfully designed, carefully manufactured and thoroughly tested. We are confident that your choice of our equipment will result in many years of pleasure.



INDEX

	Page
SECTION 1 GENERAL DESCRIPTION	3
SECTION 2 INSTALLATION	6
2.1 General	
2.2 Table-Top or Desk Installation	
2.3 Rack-Mounted Installation	
2.4 Mobile Installation	
2.5 Power Connections	
2.6 Antenna Connections	
2.7 Audio Output and Speaker Connections	
2.8 Remote Control and Muting Circuits	
SECTION 3 OPERATION	12
3.1 General	
3.2 Frequency Adjustment and Synthesizer Operation	
3.3 Condensed Operating Instructions	
3.4 Detailed Use of HRO-500 Controls	
3.5 General Suggestions for Efficient Operation of the HRO-500 Receiver	
SECTION 4 THEORY OF OPERATION	21
4.1 The Receiver: Basic Description	
4.2 The Synthesizer: Basic Description	
4.3 The Receiver: Detailed Description	
4.4 The Synthesizer: Detailed Description	
4.5 The Power Supply: Basic Description	
SECTION 5 HRO-500 TEST AND ALIGNMENT	35
5.1 General	
5.2 Equipment Required	
5.3 Initial Control Settings	
5.4 Power Supply Voltage Test	
5.5 Alignment	
5.6 Troubleshooting	
SECTION 6 SPECIFICATIONS	55
SECTION 7 PARTS LIST	56

LIST OF ILLUSTRATIONS

Figure Number	Description	Page
1	HRO-500 Receiver, Rear Panel	7
2	117/234-volt AC Operation, Wiring Diagrams	7
3	Transmitter Interconnections Without Monitor-Normal Switch	10
4	Ground-reference Muting	10
5	+12-volt DC Muting, Internal	10
6A	+12-volt DC Muting, External	10
6B	Alternate Method of Muting With External Relay	11
7	Transmitter Interconnections With Optional Monitor-Normal Switch	11
8	Remote RF-Audio Gain Circuits	11
9	J-14 Accessory Socket	11
10	Receiver Tuning (14,253.2 kHz)	12
11	Receiver Tuning (9753.2 kHz)	12
12	Passband Tuning, 2.5 kHz USB	13
13	Passband Tuning, 2.5 kHz LSB	13
14	Passband Tuning, 0.5 kHz (1-kHz Beat Note)	13
15	HRO-500 Receiver, Basic Block Diagram	20
16	Synthesizer, Basic Block Diagram	21
17	Spectrum Generator, Frequency and Time Domain	22
18	HRO-500 Frequency Chart	23
19	HRO-500 Receiver, Detailed Block Diagram	24
20	IF Selectivity	27
21	500-kHz Synchronizing Pulse Waveform	30
22	Blocking Oscillator, Base Waveform	30
23	Blocking Oscillator, Collector Waveform	30
24	Spectrum Generator, Output Waveform	31
25	Power Supply Distribution Chart	34
26	Filter Response, Oscilloscope Trace	39
27	Filter Response, Oscilloscope Trace	39
28	Filter Response, Oscilloscope Trace	39
29	Filter Response Curves and Oscilloscope Trace Composite	39
30	Tunable IF and Preliminary VFO Alignment Chart	40
31	High-Frequency Oscillator Alignment Bias	41
32	Synthesizer and Tuned Buffer Alignment Chart	42
33	Sweep Waveform at Collector of Last IF	43
34	Sweep Waveform at Base of Unijunction Transistor	43
35	Response: Bandpass Transformer T-6	44
36	Response: Bandpass Transformer T-7	44
37	Preselector Alignment Chart	46
38	3-Terminal Transistor Socket (Bottom View)	49
39	4-Terminal Transistor Socket (Bottom View)	49
40	TO-3 Case Power Transistor Socket (Bottom View)	49
41	PNP Transistor Bias Circuit	49
42	NPN Transistor Bias Circuit	49
43	Drive Cord — Synthesizer Tune	51
44	Drive Cord — Synthesizer Bandswitch	51
45	HRO-500 Receiver Chassis, Top View	52
46	HRO-500 Receiver Chassis, With Synthesizer and Covers Removed, Top View	52
47	Synthesizer Chassis, Rear View	53
48	Synthesizer Chassis, Front View	53
49	HRO-500 Receiver Chassis, Bottom View	54
50	Schematic Diagram—Receiver	
51	Schematic Diagram—Synthesizer	

SECTION 1

GENERAL DESCRIPTION

The National Radio Company, Inc. HRO-500 solid-state communications receiver is designed for highly reliable applications, both fixed and portable, demanding extreme tuning accuracy and stability over either a limited or an extraordinary frequency range. All facilities for reception of SSB, AM, CW, FAX or FSK signals are incorporated, and necessary outputs are provided for operation of ancillary equipment for use in unusual applications. Total transistorization of the HRO-500 results in a highly reliable equipment with superior performance as compared with existing tube receivers, but with power drain so small as to allow portable or field operation under previously difficult or impossible conditions.

FREQUENCY RANGE: The HRO-500 covers the entire VLF and HF spectrums continuously—from five kilohertz to 30 megahertz in 60 500-kHz bands. Tuning rate, stability and dial calibration/accuracy (one kHz) are identical throughout its tuning range. SSB sensitivity is better than 1.0 microvolt for 10 db signal plus noise-to-noise ratio in the 500 kHz—30 MHz range, with minimum image rejection of 50 db. Internal spurious responses between 500 kHz and 30 MHz are all less than the equivalent of two microvolts at the antenna terminals, with the exception of two discrete responses at 2.75 MHz and 3.0 MHz.

The 5-kHz to 500-kHz VLF range is incorporated in the HRO-500 receiver with frequency in kilohertz read directly from the main tuning dial. An external VLF antenna input is provided to the first mixer and incoming VLF signals are first up-converted to 26 MHz and then processed through a double-conversion scheme. Basic sensitivity in the VLF band is 25-50 microvolts without the optional LF-10 preselector. The LF-10 preselector may be used to provide one microvolt sensitivity in the 5-kHz to 500-kHz range with protection against possible overload when desired for critical VLF applications.

FREQUENCY DETERMINATION AND SYNTHESIZER: Frequency determination in the HRO-500 is performed

by a phase-locked frequency synthesizer which provides all of the necessary oscillator injection signals to tune the 5 kHz to 30 MHz frequency range. The block diagram of the HRO-500 is similar to a conventional receiver with a crystal-controlled high frequency oscillator and tunable I.F., but the multiplicity of crystals usually required for the high frequency oscillator is replaced in the HRO-500 by a single highly stable 500 kHz master crystal oscillator, from which 60 crystal-stable H.F. oscillator inputs are synthesized. The synthesizer is internally phase-locked for high stability, and a **Phase-lock** warning lamp indicates when the output of the synthesizer has been tuned to the correct H.F. oscillator input frequency. Band changing is accomplished by setting the band-switch to the desired band in megahertz and then tuning the front panel synthesizer control until the 500 kHz range within that band is indicated in the digital synthesizer window over the main tuning dial, and the **Phase-Lock** warning lamp extinguishes. The desired 500 kHz range is then continuously tuned by the epicyclic PW mechanism which is calibrated directly in one-kilohertz increments. The reading of the PW kilohertz dial is added to the synthesizer reading in megahertz to determine frequency within one kilohertz over the entire tuning range of the HRO-500.

The HRO-500 operates as a triple conversion receiver (to eliminate gaps in its tuning range) between 5 kHz and 4.0 MHz. Incoming signals in this region are up-converted to 26.0 MHz plus the signal frequency. The synthesizer output is then utilized to convert these signals to the tunable IF range of 2750-3250 kHz, where they are mixed with the 2980-3480 kHz VFO to produce the last IF of 230 kHz. Signals in the 4-30 MHz range are directly converted by the synthesizer to the tunable IF without the necessity for an intermediate up-conversion.

FREQUENCY STABILITY: The use of the phase-locked frequency synthesizer to generate crystal-stable high frequency oscillator signals, plus the use of crystal-controlled conversion and beat frequency oscillators, results in only one tunable oscillator in the HRO-500—the VFO (or interpolation oscillator) which tunes only the 500 kHz range between 2980-3480 kHz. As a

consequence, negligible drift is introduced in the conversion processes. VFO stability is particularly superior for four important reasons: The VFO frequency is quite low, making drift (as a function of oscillator frequency) a very small number; the tuning range of the VFO is limited to 500 kHz, allowing accurate temperature compensation over its range; the use of transistors in the VFO eliminates the warm-up drift characteristic of tube-type oscillators as the internal element structure of the tube expands with heat; and practically no heat is generated within the receiver itself because of its solid state circuitry. Changes in ambient temperature are well compensated, and the VFO transistor voltages are *electronically* regulated against changes in primary line voltage. Total drift of the HRO-500 from turn-on is 300 hertz per hour to two hours after turn-on, and better than 100 hertz/day (including a 40 volt change in A.C. input voltage) thereafter. Stability with respect to temperature is 50 hertz per °C.

DIAL CALIBRATION: The use of synthesized output from a single master crystal to generate crystal-stable high frequency oscillator injection signals permits the HRO-500 to incorporate only one tunable oscillator; the linear VFO or interpolation oscillator. Since it tunes the same frequency range at all times, regardless of HFO frequency, it may be accurately calibrated to one kilohertz. The 1-kHz calibration markings are $\frac{1}{4}$ " apart, and the use of National's well known epicyclic PW dial mechanism provides an effective scale length of 12 feet. An additional 5:1 reduction is incorporated between the PW dial and its tuning knob to permit a selectable tuning ratio of 10 kHz or 50 kHz per knob revolution. Dial accuracy is one kHz over the entire 500 kHz tuning range of the VFO, and an internal calibrating crystal oscillator provides marker signals at 50 kHz intervals rather than the usual 100 kHz. Since a single crystal is used for all HFO injection frequencies in the synthesizer, rather than separate crystal oscillators, there is negligible change in dial accuracy or need for recalibration when switching from band to band. Over-all synthesizer output frequency accuracy after calibration at 10 MHz is within 250 hertz throughout the tuning range of the HRO-500. The use of a solid state VFO, in addition, eliminates the change in calibration resulting from vacuum tube aging.

SELECTIVITY: I.F. selectivity in the HRO-500 is obtained by means of a *tunable* six-pole filter employing ferrite cup-cores at 230 kHz. Bandwidths (at 6 db) available are 500 hertz, 2.5 kHz, 5 kHz, and 8 kHz to meet any combination of SSB, CW, or AM receiving conditions. The shape factor (6-60 db) afforded by the six pole filter is nominally 2.5:1 in the 2.5 kHz bandwidth. Selectable sideband or single signal CW reception is afforded by means of **Passband Tuning** in the 500 hertz and 2.5 kHz bandwidths. The frequency of the filter is moved across the IF passband with the front-panel **Passband Tune** control to enable

the operator to "drop out" interfering signals *without changing the frequency of the desired signal*.

A **Rejection Tuning** filter with an extremely sharp rejection notch may also be controlled from the front panel to eliminate interfering heterodynes. Heterodyne rejection capability of this filter is 50 db.

Front-end selectivity and image rejection in the HRO-500 is unusually high. Three tuned circuits are used in the RF stage instead of two, and intermediate frequencies are chosen so that image rejection is a minimum of 50 db throughout the tuning range. Unlike previous transistorized receivers, resistance of the HRO-500 to cross modulation and overload (dynamic range) is closely comparable to vacuum tube equipment. The excellent dynamic range of the HRO-500 has been achieved by means of careful attention to front-end selectivity, use of silicon transistors to allow higher injection voltages, a low noise RF stage to provide high sensitivity without excessive gain, and inclusion of high selectivity immediately after the first mixer.

AGC: The HRO-500 incorporates an AGC system of high relative merit (5 db change in output for input variation between 10 and 100,000 μ v) with attack and release times optimized for SSB/CW/AM reception without pops, clicks, or disablement due to noise pulses. Although a flat AGC system is very desirable for clear-channel applications, under certain conditions of high background signal level (such as frequently encountered in the amateur or marine bands) intelligibility of the desired signal is impaired because of AGC action on background signals which increases them in amplitude. The normal procedure in such instances is to reduce the RF gain of the receiver in order to reduce or eliminate AGC action. While performance of the receiver is improved, AGC action is lost and it is necessary to "ride" the gain control. The HRO-500, however, incorporates a front panel **AGC Threshold** control which allows the operator to insert up to 30 db of attenuation to all incoming signals, thereby "dropping out" the weaker background signals *without changing the amount or degree of AGC action*. The net result is superior performance when high background activity is encountered without AGC compromise for clear channel operation.

THE S-METER: is accurately calibrated in decibels above 1 microvolt as well as the familiar S1-S9 scale. The S-meter is accurately calibrated at the time of manufacture and may be recalibrated to any desired level of sensitivity by means of an internal adjustment provided inside the equipment.

SOLID STATE CIRCUITRY: The HRO-500 is a departure from conventional transistorized equipment in that the necessity for easy field maintenance in remote locations has been recognized in its design, as well as the desirability of sufficient panel space for knobs, dials, and controls. Accordingly, while the receiver is far more compact than an equivalent vacuum tube

equipment, no attempt has been made to "miniaturize" the HRO-500 by the use of cordwood construction, printed circuits, etc. All transistors are mounted in plug-in sockets and all components are hand-wired. To further improve access and reduce component density, most components are mounted on sub-assembled vertical circuit boards. As a result, circuit-tracing and maintenance is easier than in most vacuum tube equipment of less sophistication. The use of total solid state circuitry in the design of the HRO-500 results in advantages never before realized in commercial communications receivers: greatly improved reliability over tube-type equipment because of the far longer life of transistors and the elimination of performance deterioration from tube "aging"; vastly increased versatility in terms of portable or field operation since the HRO-500 may be operated directly from a 12 V.D.C. source (without intermediate converters) as well as from 115/230 V.A.C. 50/60 hertz sources; practically zero internal heat generation and minuscule power drain—200 ma. @ 50 mw audio output from a 12 V.D.C. source or 15 watts from a 115/230 V.A.C. line; instantaneous operation from turn-on without the warm-up drift characteristic of tube equipment.

REMOTE CONTROL AND AUXILIARY OUTPUTS: The HRO-500 will find wide use in remote control applications, and accordingly may be externally controlled for primary power, R.F. gain, Audio gain, and receiver mute.

All supply voltages and both NPN and PNP AGC are available at the rear panel as well as detector output.

BFO, VFO, synthesizer, 230 kHz I.F. and 26 MHz oscillator outputs are also available at the rear panel. Audio output may be selected from 3.2 ohms or 600 ohms balanced center tapped terminals.

Antenna jacks are provided for 50 ohm unbalanced, high impedance, and VLF antenna inputs.

A two terminal jack with reverse polarity protection is provided on the rear panel for 12 V.D.C. input, which may be instantly selected instead of 115/230 V.A.C. input by means of a rear panel switch. The A.C. line cord is detachable for battery or portable operation.

APPLICATIONS: The HRO-500 has been designed for any application requiring either limited or extraordinary frequency coverage with uniformly excellent dial calibration and frequency stability. All facilities necessary for superior SSB, CW, FSK and AM reception are incorporated. The use of solid state technology provides far greater versatility for portable or remote operation than previously available with tube-type equipment, and results in simplified power and cooling requirements where one or many receivers must be operated singly or simultaneously.

The HRO-500 is designed for use in HF or VLF point-to-point communication systems, field monitoring applications, surveillance and direction-finding systems, and amateur radio installations. Its extraordinary frequency coverage, calibration, sensitivity and high image rejection makes the HRO-500 an ideal laboratory instrument for wide-range detection, calibration, spectrum analysis and frequency measurement.

SECTION 2 INSTALLATION

2.1 GENERAL:

Carefully unpack the HRO-500 and set aside all packing material for possible future use. Accessory plugs and the line cord are separately packed in the shipping carton. Lift the lid by turning the fasteners counterclockwise one-quarter turn and inspect for visible damage. Make sure all transistors and crystals are properly seated in their sockets. If damage is evident, immediately notify and file claim with the carrier.

The HRO-500 receiver may be operated under environmental conditions ranging in temperature from 0° F to 110° F and in relative humidity from zero to 90 percent. The receiver may be stored in environments from -30° F to +150° F with humidities from zero to 90 per cent.

For maximum performance in the VLF range (5 to 500 kHz), it is recommended that the optional LF-10 preselector be connected between the antenna and the low-frequency input jack of the HRO-500. The LF-10 preselector must be plugged into the 18-terminal connector at the rear of the HRO-500. It may also be connected to the 50-ohm antenna input of the HRO-500 to provide external antenna transfer through the FUNCTION switch of the LF-10 preselector.

2.2 TABLE-TOP OR DESK INSTALLATION:

For table-top or desk use, the HRO-500 receiver requires an antenna, a 3.2-ohm loudspeaker or head-phone set, and a suitable power source. The power cord for 117-volt operation and all necessary connectors, except a PL-259 type connector required to enter the 50-ohm antenna connection, are shipped with the receiver. For operation on other than 117 volts AC 50-60 hertz, see paragraph 2.5 on power connections.

To obtain maximum performance under all operating conditions, it is recommended that the matching HRO-500TS table speaker be used with the HRO-500. The HRO-500TS and enclosure have been carefully designed to match the HRO-500 receiver.

2.3 RACK-MOUNTED INSTALLATION:

The HRO-500 may be rack mounted by use of the optional rack-mounting kit. The rack panel space required is 8¾ inches. The HRO-500 rack panel provided with the kit incorporates standard RETMA spacing on the rack-mounting screw notches.

The conditions and recommendations stated in paragraph 2.2 also apply to rack-mounted installations.

2.4 MOBILE INSTALLATION:

For mobile use, the HRO-500 receiver should be shock mounted. If the vehicle in which the receiver is to be installed is not intended for travel over rough terrain or will not be subjected to violent acceleration or deceleration in any plane, the HRO-500 may be used without shock mounting, provided that the receiver rests on its own mounting feet attached to the cabinet.

2.5 POWER CONNECTIONS:

2.5.1 117V AC SUPPLY

The HRO-500 receiver is shipped wired for 117V AC 50-60 hertz or 11 to 16 volt DC operation. Connection of the receiver to the 117V AC supply is made by plugging the two-prong female plug of the power cord into J-8 located at the rear of the receiver and inserting the other end into a 117V AC 50-60 hertz power outlet (see figure 1).

— CAUTION —

ACCIDENTAL CONNECTION OF 117V AC TO THE 11-16 VOLT DC INPUT PLUG MAY CAUSE SEVERE DAMAGE TO THE HRO-500. DO NOT ATTEMPT TO PLACE THE 117-VOLT POWER CORD ON THE 12-VOLT DC INPUT PLUG. ALWAYS REMOVE THE POWER CORD FROM THE 117V AC SUPPLY LINE BEFORE CONNECTING OR DISCONNECTING THE POWER CORD TO THE HRO-500.

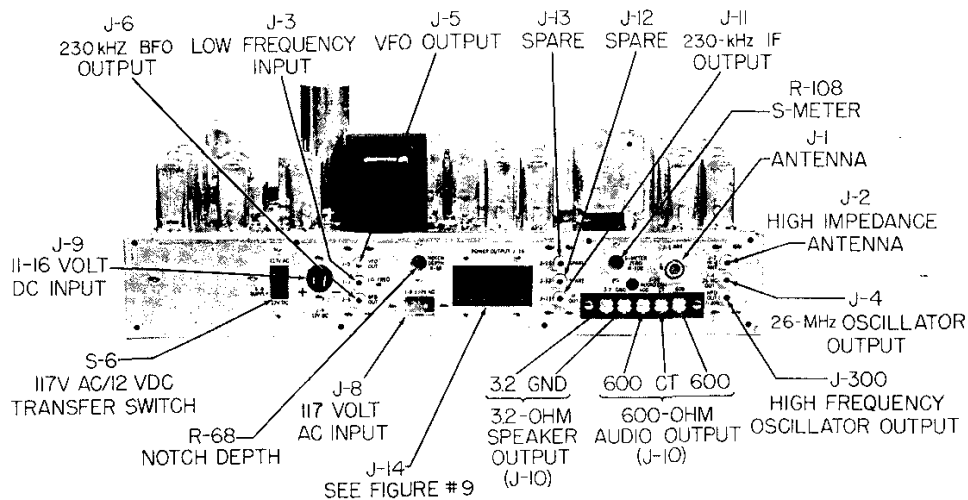

HRO-500 RECEIVER, REAR PANEL

FIGURE 1

To internally connect the 117-volt AC supply, the 117V AC/12V DC change-over switch S-6 located at the rear of the chassis must be depressed in the upper position. Under idling conditions, the HRO-500 will draw approximately 10 watts. The AC supply drain at 1.5 watts of audio output will be approximately 15 watts with the DIAL lamp switch in the OFF position and the pilot lamps extinguished; 22 watts with the DIAL lamp switch in the ON position and the pilot lamps illuminated.

2.5.2 234-VOLT AC OPERATION

The receiver may be rewired for 234-volt AC operation as shown in figure 2. Under these conditions, the power drain is as given above with the exception that the current drains will be reduced to approximately one half of the amount for 117-volt operation. Operation and connections will be the same as discussed in paragraph 2.5.1 for 117-volt operation.

2.5.3 11-16V DC OPERATION

The HRO-500 may be operated from an external 11-16 volt DC supply by supplying power through J-9 as shown in figure 1. The wide pin of J-9 is the negative supply input and the narrow pin is the positive supply input.

THE SUPPLY CONNECTIONS WILL SHORT CIRCUIT THE SUPPLY IF THERE IS AN EXTERNAL GROUND CONNECTION COMMON TO THE SUPPLY.

Internal reverse polarity protection is provided in the HRO-500 and will prevent damage to the receiver in the event of an accidental polarity reversal. To internally connect the 11-16 volt DC supply to the receiver, the 117V AC/12V DC change-over switch S-6 located at the rear of the chassis must be depressed in the downward position.

With the pilot lamps extinguished, the drain from a 12-volt DC source will be approximately 2.4 watts or 200 ma with 50-mw audio output; 9 watts or 750 ma with 2 watts of audio.

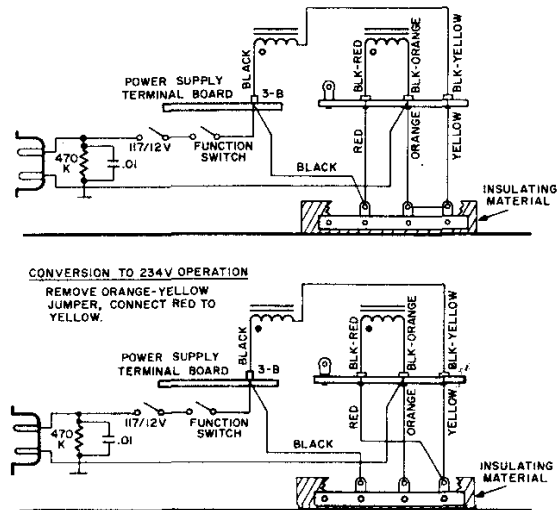

117/234-VOLT AC OPERATION, WIRING DIAGRAMS

FIGURE 2

— CAUTION —

ACCIDENTAL CONNECTION OF A HIGH-CAPACITY 11-16V DC SUPPLY TO THE 117V AC INPUT OF THE HRO-500 MAY CAUSE SEVERE DAMAGE TO THE HRO-500 POWER SUPPLY. THE CHASSIS OF THE HRO-500 IS CONNECTED TO THE NEGATIVE SUPPLY INPUT. ACCIDENTAL INTERCHANGE OF

With the pilot lamps illuminated, the DC supply drain will be approximately 8 watts or 680 ma with 50-mw audio output; 15 watts or 1250 ma with 1.5 watts audio output.

The HRO-500 may be run from dry batteries, such as combinations of flashlight cells or other batteries. For longest life with low-capacity batteries it is recommended that cells be added in series to obtain +15 volts DC. To extend the battery life it is recommended that the receiver be operated with the DIAL lamp switch set in the OFF position. Battery end-of-life conditions have been reached when the synthesizer fails to lock at the proper dial settings and the PHASE LOCK warning lamp will not extinguish.

2.6 ANTENNA CONNECTIONS:

— CAUTION —

THE RF TRANSISTOR IN THE FRONT END OF THE HRO-500 IS TAPPED WELL DOWN ON THE ANTENNA INPUT COIL. THEREFORE, THE HRO-500 IS NO MORE SUSCEPTIBLE TO DAMAGE FROM EXCESSIVE RF INPUT THAN A CONVENTIONAL VACUUM TUBE RECEIVER. HOWEVER, THE HRO-500 MAY FREQUENTLY BE USED AS AN AUXILIARY RECEIVER IN CONJUNCTION WITH A SEPARATE TRANSCEIVER OR TRANSMITTER-RECEIVER COMBINATION. NORMAL PRECAUTIONS ARE NECESSARY TO MAKE CERTAIN THAT THE ANTENNA LEAD TO THE HRO-500 IS ALWAYS DISCONNECTED, PREFERABLY GROUNDED, WHEN TRANSMITTING TO PREVENT DAMAGE TO THE INPUT CIRCUITS.

2.6.1 50-OHM COAXIAL CONNECTOR

Antennas of approximately 50 ohms impedance should be connected to the HRO-500 receiver through the UHF-type (SO-239) coaxial connector at the rear panel of the HRO-500 (see figure 1). The receiver presents a 50-ohm impedance to this connector. Maximum receiver performance on all bands from 500 kHz through 30 MHz will be obtained with a 50-ohm line matched to the antenna and the receiver.

2.6.2 HI-Z ANTENNA INPUT

When various random-length or short antennas are used with the HRO-500, it is recommended that the antenna connection be made through the high-impedance jack, J-2 (see figure 1). The impedance presented by J-2 is 10 pf of capacitance in series with a resistive impedance of greater than 10,000 ohms. J-2 may be used with high-impedance antennas over the frequency ranges from 500 kHz to 30 MHz.

2.6.3 LOW-FREQUENCY INPUT CONNECTIONS

The HRO-500 receiver may be used to receive signals from 5 kHz to 500 kHz by connecting an antenna to jack J-3 (see figure 1). When the antenna is connected to J-3, it should be noted that the sensitivity of the HRO-500 receiver is between 25 and 50 μv and that there is no preselection. For laboratory detection purposes and in many receiver locations, these conditions will permit excellent reception of low-frequency signals. The impedance presented by the HRO-500 receiver to input jack J-3 is approximately 1000 ohms.

To obtain maximum sensitivity and excellent preselection of low-frequency signals, it is recommended that the LF-10 low-frequency preselector be used with the HRO-500. When the LF-10 preselector is used with the HRO-500, the receiver will have an AM sensitivity of better than 2 μv for 10 db signal-plus-noise to noise ratio and preselection with two tuned circuits at the operating frequency to eliminate cross-modulation or overload.

2.7 AUDIO OUTPUT AND SPEAKER CONNECTIONS:

2.7.1 3.2-OHM SPEAKER

The HRO-500TS table speaker, or other 3.2-ohm speaker, may be connected to the 3.2-ohm output on terminal board J-10 at the rear of the receiver (see figure 1). If desired, the 3.2-ohm speaker leads may be terminated in a standard two-connector phone plug. Access to the 3.2-ohm output may be obtained through the front panel PHONES jack J-7.

2.7.2 EARPHONES

Either high-impedance or low-impedance type earphones may be used with the HRO-500. The earphone leads must be terminated in a standard two-connector, type PL-55, phone plug which may be inserted in the PHONES jack J-7 located on the front panel of the HRO-500 receiver. The low impedance of the phone jack feed permits use of either high or low-impedance phones. If a speaker is connected to the rear apron 3.2-ohm output, it will be silenced automatically when the earphone plug is inserted into the PHONES jack. The 600-ohm output will not be affected.

2.7.3 600-OHM AUDIO OUTPUT

A 600-ohm audio output connection is available at the rear of the HRO-500 on terminal board J-10. The 600-ohm winding of the output transformer is center-tapped and ungrounded to provide maximum versatility and to allow single-ended or center-tapped grounding when used to feed a 600-ohm line, such as telephone lines or 600-ohm voice coil transformers. The audio output level is controlled by the receiver AUDIO GAIN control and may be monitored by connecting an external meter or other power indicating device to the 600-ohm output terminals.

2.8 REMOTE CONTROL AND MUTING CIRCUITS:

2.8.1 TRANSMITTER CONNECTIONS

— CAUTION—

MANY TRANSMITTERS AND RECEIVERS EMPLOY SPECIAL MUTING OUTPUTS IN WHICH A VOLTAGE IS PRESENT. TO PREVENT DAMAGE TO THE HRO-500 MUTING CIRCUITS, USE A VOLTMETER TO BE ABSOLUTELY CERTAIN THAT NO VOLTAGE IS PRESENT ON THE MUTING LEADS FROM ACCESSORY EQUIPMENT BEFORE CONNECTING THEM TO THE HRO-500.

Transmitter interconnections, including receiver muting and antenna switching of the HRO-500, may be accomplished as shown in figure 3. The HRO-500 may be muted by several methods. Ground-reference muting may be obtained by grounding terminal 12 of J-14 to the receiver chassis ground as shown in figure 4. The receiver may also be muted by connecting terminal 13 of J-14 (+12 volt DC muting) to a +12-volt DC supply available on terminal 4 of J-14 as shown in figure 5 and figure 6B. The receiver may also be muted by connecting terminal 13 to any external +12-volt DC source as shown in figure 6A. It should be noted that all the muting methods described herein will cause the PHASE LOCK indicator lamp to flash. Therefore, the PHASE LOCK indicator of the HRO-500 will serve as an indication that the transmitter is in operation or that the receiver is muted.

The optional monitor-normal switch shown in the transmitter interconnection diagram (see figure 7) provides a means of using the HRO-500 to monitor the transmitted signal as picked up from the open receiver antenna connection at the relay. If this monitoring feature is not desired, the monitor-normal switch may be eliminated and connections made according to figure 3.

2.8.2 REMOTE OPERATION

The HRO-500 may be installed in a position remote from the operator for fixed general use. For remote operation, it is necessary that the receiver be preprogrammed for the proper channel frequency and for the correct mode of operation. However, the

operator may have complete control of RF gain and audio gain and the receiver muting. These features may be provided by making the required interconnections as shown in figure 8.

Remote audio gain control may be obtained by connecting a 10,000-ohm (logarithmic taper) audio gain control potentiometer to J-14 of the HRO. The audio gain control ground side should be connected to terminal 3; the center, to terminal 17; and the high side, to terminal 18.

Remote RF gain control of the HRO-500 may be obtained by connecting a 500-ohm RF gain control potentiometer to terminals 5 and 11 of J-14. Terminal 11 will be the remote RF gain line and terminal 5 will supply the +11-volt DC potential required for the RF gain control DC reference voltage. The remaining terminal of the potentiometer should be connected to Terminal 3 of J-14 through a 2200 ohm $\frac{1}{2}$ watt resistor. The HRO-500 will have minimum RF gain when the potentiometer arm is at the +11-volt terminal.

Remote receiver muting may be accomplished by either ground-reference muting or +12-volt DC muting as described in paragraph 2.8.1.

2.8.3 REMOTE POWER CONTROL

The remote operator may have complete power control of the HRO-500 by installing a SPST switch at the operator's position. This switch should be connected in series with either the 117-volt AC or 12-volt DC line used to power the receiver, depending on the particular installation.

2.8.4 CONTROLLING OTHER EQUIPMENT

The HRO-500 FUNCTION switch, when placed in the STBY position, mutes the receiver and closes contacts 1 and 2 of J-14. These contacts may be used to close an external circuit to control other equipment. For example, these contacts could be used for the transmit-receive switch as shown in the transmitter diagram, figure 3.

2.8.5 AUXILIARY OUTPUTS

Auxiliary input and output jacks are located on the rear of the receiver to allow monitoring, controlling auxiliary equipment and troubleshooting. The location of these auxiliary inputs and outputs are shown in figures 1 and 9. The function, nominal output level, internal impedance and frequency range are listed in the table below.

JACK	FUNCTION	INPUT/OUTPUT NOMINAL LEVEL	INTERNAL IMPEDANCE	FREQUENCY RANGE
J-4	26-MHz output	100 mv	50 Ω	26 MHz
J-5	VFO output	100 mv	100 Ω	2.98 — 3.48 MHz
J-6	BFO output	100 mv	47 Ω	230 kHz
J-11	IF output	—	50 Ω	230 kHz
J-14-17	Audio input	100 mv input (for full output)	10,000 Ω	Audio
J-14-18	Detector output	—	10,000 Ω	Audio
J-300	HFO output	100 mv	330 Ω	7.25-32.75 MHz

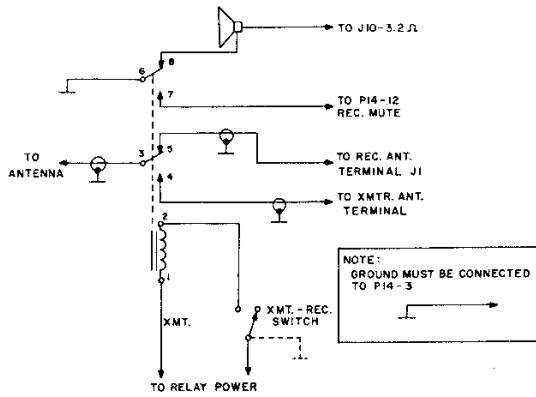

TRANSMITTER INTERCONNECTIONS WITHOUT MONITOR-NORMAL SWITCH

FIGURE 3

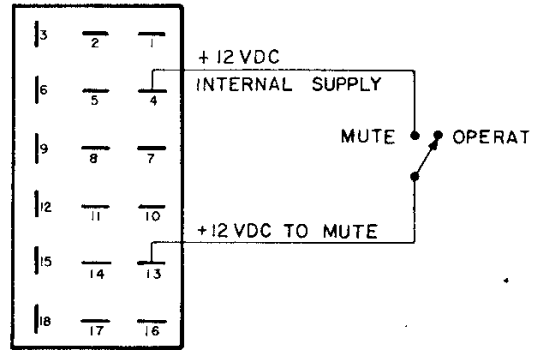

+12-VOLT DC MUTING, INTERNAL

FIGURE 5

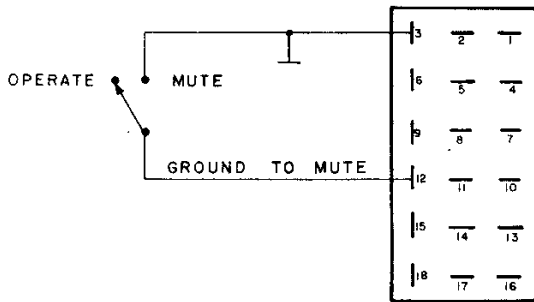

GROUND-REFERENCE MUTING

FIGURE 4

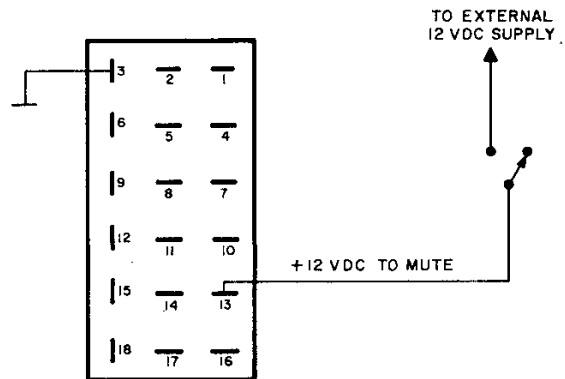

+12-VOLT DC MUTING, EXTERNAL

FIGURE 6A

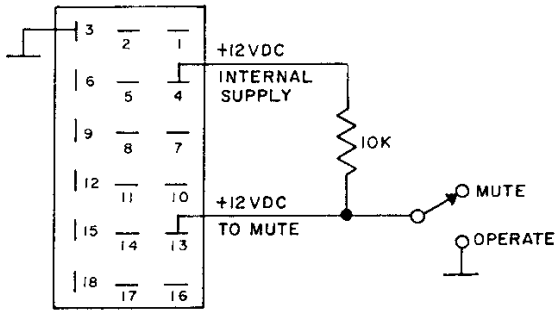

ALTERNATE METHOD OF MUTING FOR USE WITH AN EXTERNAL RELAY CONTACT WHICH IS GROUNDED TO OPERATE THE RECEIVER.

FIGURE 6B

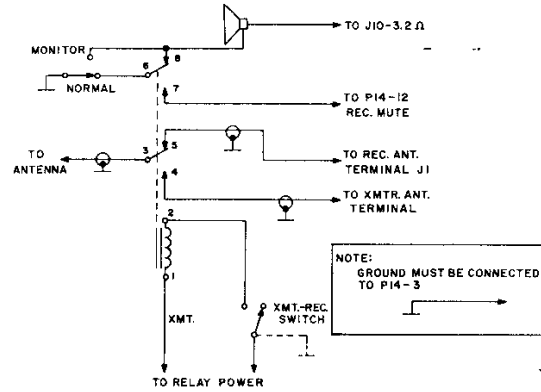

TRANSMITTER INTERCONNECTIONS WITH OPTIONAL MONITOR-NORMAL SWITCH

FIGURE 7

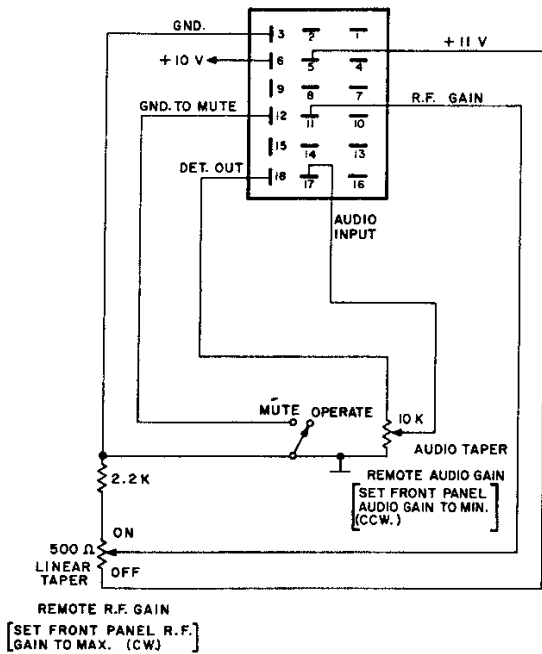

REMOTE RF-AUDIO GAIN CIRCUITS

FIGURE 8

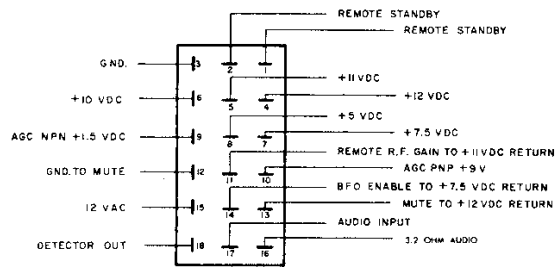

J-14 ACCESSORY SOCKET

FIGURE 9

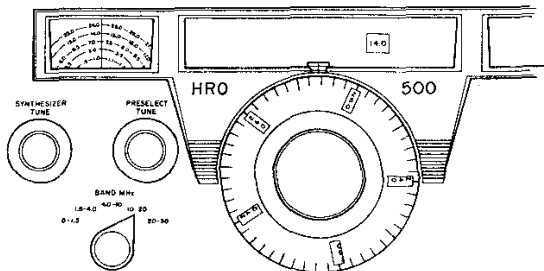

RECEIVER TUNING (14,253.2 kHz)

FIGURE 10

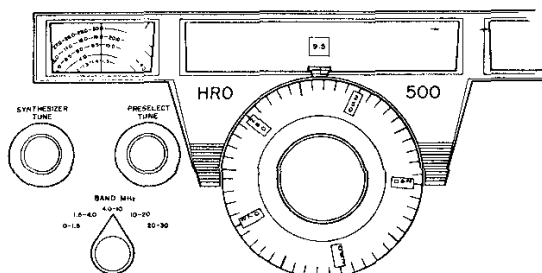

RECEIVER TUNING (9753.2 kHz)

FIGURE 11

SECTION 3 OPERATION

3.1 GENERAL:

It is assumed that the HRO-500 receiver has been properly installed as specified in Section 2 (Installation) before operation is attempted. Check to make certain that the antenna and speaker are properly connected, that proper power has been supplied to the HRO-500, and that the power change-over switch on the rear panel has been properly set for the power source in use.

Paragraphs 3.2 through 3.3.3 which follow are intended to provide the operator with only the basic information required to operate the HRO-500 receiver. Paragraphs 3.4 through 3.4.17 provide a detailed explanation of the HRO-500 controls. It is strongly recommended that the latter paragraphs be carefully studied to obtain maximum benefit from the HRO-500 receiver. Paragraphs 3.5 to 3.5.3 make various suggestions to obtain optimum HRO-500 performance.

3.2 FREQUENCY ADJUSTMENT AND SYNTHESIZER OPERATION:

3.2.1 FREQUENCY INDICATION

The HRO-500 receiver tunes the frequency range from 5 kHz to 30 MHz in sixty 500-kHz bands. Each 500-kHz band is selected by means of a phase-locked frequency synthesizer. The lowest frequency of the 500-kHz band in use appears on the SYNTHESIZER TUNE dial in the center window directly above the circular MAIN TUNING (kilohertz) dial. The MAIN TUNING dial is used to tune each 500-kHz band,

and is calibrated with linear 1-kHz divisions from zero to 500 kHz. The exact frequency to which the HRO-500 is tuned is determined by adding the kilohertz indication of the MAIN TUNING dial to the SYNTHESIZER TUNE dial indication in megahertz (as it appears in the center window). If the SYNTHESIZER TUNE dial indicates 14.0 megahertz and the MAIN TUNING dial indicates 253.2 kilohertz, then the HRO-500 receiver is tuned to 14,000 plus 253.2, or 14,253.2 kilohertz as illustrated in figure 10. If the SYNTHESIZER TUNE dial indicates 9.5 megahertz and the MAIN TUNING dial indicates 253.2 kilohertz, the receiver is tuned to 9500 plus 253.2, or 9753.2 kilohertz as illustrated in figure 11.

3.2.2 FREQUENCY ADJUSTMENT

To adjust the HRO-500 receiver to frequency, perform the following steps:

1. Turn the BANDSWITCH to the desired frequency range.

2. Rotate the SYNTHESIZER TUNE control until the low end of the desired 500-kHz band appears on the SYNTHESIZER TUNE dial. The desired 500-kHz band is, of course, the frequency in megahertz to which must be added the frequency in kilohertz as displayed on the MAIN TUNING dial to obtain the desired receiver frequency. As the SYNTHESIZER TUNE control is rotated, it will be noted that the PHASE LOCK lamp flashes and the receiver mutes as the synthesizer is tuned from one 500-kHz band to the next. The synthesizer is correctly adjusted when the desired 500-kHz band appears in the center

of the SYNTHESIZER TUNE dial window, the PHASE LOCK lamp is extinguished, and audio is heard from the speaker, providing the RF and AUDIO GAIN controls are properly set.

3. Adjust the MAIN TUNING dial to the frequency in kilohertz which must be added to the synthesizer frequency in megahertz for reception at the desired frequency.

4. Slowly rotate the PRESECTOR TUNE control until incoming noise or signals are loudest, or until the S-meter indicates maximum amplitude. It will be noted that the PRESECTOR TUNE control is ganged to the PRESECTOR TUNE dial scale in the upper left window of the HRO-500 receiver. The calibrations on the PRESECTOR TUNE dial are in five bands, corresponding to each of the bands selected by the BANDSWITCH.

— CAUTION —

ALWAYS SET THE PRESECTOR TUNE DIAL TO THE OPERATING FREQUENCY WITHIN PLUS OR MINUS ONE-HALF DIAL DIVISION. THIS IS NECESSARY TO INSURE MAXIMUM SENSITIVITY OF THE HRO-500, AS WELL AS GREATEST FREEDOM FROM IMAGE AND SPURIOUS SIGNAL RESPONSE. GENERALLY SPEAKING, THE OPERATION OF THE PRESECTOR TUNE CONTROL MAY BE CONSIDERED SIMILAR TO THAT OF A CALIBRATED ANTENNA TRIMMER CONTROL.

3.3 CONDENSED OPERATING INSTRUCTIONS:

The following instructions are intended to provide the operator with information necessary to quickly and easily adjust the HRO-500 receiver for reception of SSB, CW, or AM signals. Paragraphs 3.4 through 3.4.17 must be carefully studied for complete understanding of control operation.

Before operation of the HRO-500 receiver, the front panel controls should be set as follows:

- AUDIO GAIN fully counterclockwise (ccw)
- RF GAIN fully clockwise (cw)
- AGC THRESHOLD: ON
- DIAL lamp switch to the ON position
(unless battery operation dictates economy of battery use)
- BANDWIDTH switch at 5.0 kHz
- REJECTION TUNE: OFF
- FUNCTION switch: OFF

3.3.1 AM OPERATION

1. Turn the FUNCTION switch from OFF to AM. The dial lamps should illuminate, indi-

cating that the receiver circuits are now energized.

2. Adjust the receiver to the desired frequency as described in paragraph 3.2 above.
3. Rotate the concentric AUDIO GAIN control clockwise until a comfortable listening level is achieved.
4. Carefully peak the preselector as described in paragraph 3.2 above.
5. Interfering heterodynes may be reduced or eliminated by slowly rotating the REJECTION TUNE control until the interference is minimized.
6. For greater fidelity, the BANDWIDTH control may be turned to 8.0 kHz.

3.3.2 SSB OPERATION

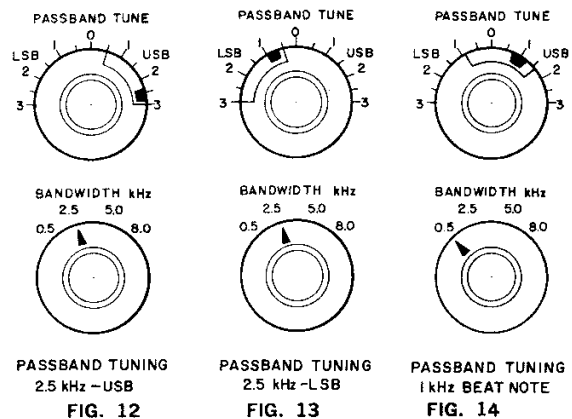

1. It is assumed that the HRO-500 receiver has been previously adjusted for AM operation.
2. Turn the FUNCTION switch to SSB.
3. Turn the BANDWIDTH switch to 2.5 kHz.
4. For single-sideband reception, turn the PASSBAND TUNE control until the wide sector outlined in white on the knob includes the 0.5 kHz to 3 kHz divisions on the panel (see figure 12). This sector on the PASSBAND TUNE control indicates the relative width and position of the 2.5 kHz filter with respect to the IF center (BFO) frequency. Zero on the front panel scale corresponds to this center frequency. The scale is calibrated in 1/2-kilohertz marks up to 3 kilohertz either side of zero.
5. For upper sideband reception, the PASSBAND TUNE control should be turned to the right of zero (USB); for lower sideband reception, the PASSBAND TUNE control should be turned to the left of zero (LSB) (see figure 13).

6. Interfering heterodynes may be rejected by use of the REJECTION TUNE control as described in paragraph 3.3.1 above.

3.3.3 CW RECEPTION

1. It is assumed that the HRO-500 receiver has been adjusted for SSB reception.
2. Turn the BANDWIDTH switch to 0.5 kHz (500-hertz filter bandwidth).
3. Turn the PASSBAND TUNE control to either side of zero so that the solid white sector of the PASSBAND TUNE knob spans the 1-kHz marking on the panel as shown in figure 14.

3.4 DETAILED USE OF HRO-500 CONTROLS:

3.4.1 DIAL LOCK

The HRO-500 DIAL LOCK control is a mechanical clutch which couples the MAIN TUNING (kilohertz) control to the linear tuning capacitor in the receiver. The DIAL LOCK may be used to adjust the MAIN TUNING dial for exact calibration, or may be used to prevent the MAIN TUNING control from being disturbed by either mechanical vibration or adjustment by unauthorized personnel.

To use the DIAL LOCK for calibration adjustment, turn the FUNCTION switch to CAL. In this mode of operation, the 50-kHz crystal standard oscillator provides calibrator signals every 50 kHz throughout the tuning range of the VFO. Adjust the MAIN TUNING dial to an exact multiple of 50 kHz and note whether or not it is zero beat with the output from the internal crystal calibrator. If not, adjust the MAIN TUNING dial to exact zero beat with the calibrator, and turn the DIAL LOCK knob 90° clockwise to lock the VFO tuning capacitor. The MAIN TUNING control may now be turned without changing the receiver frequency. It should be adjusted until the MAIN TUNING dial indicates the exact frequency of the 50-kHz calibrator signal. Now unlock the main tuning capacitor by rotating the DIAL LOCK knob 90° counterclockwise. It may be found more convenient during the calibration procedure to simply turn the DIAL LOCK knob part way through its rotation and hold it there while adjusting the MAIN TUNING dial instead of rotating it to its full clockwise position. It will be noted that rotation stops are built into the MAIN TUNING dial. The stops prevent accidental adjustment to the wrong 50-kHz calibration point.

3.4.2 SYNTHESIZER TUNE

The HRO-500 has a high-frequency oscillator, or HFO, that is phase-locked and synthesized to produce crystal-stabilized oscillator injection frequencies. The correct frequency of the high-frequency oscillator is selected in 500-kHz increments by the SYNTHESIZER

TUNE control. This control operates a drum dial calibrated in 60 500-kHz increments from 0.0 MHz to 29.5 MHz which appear on the SYNTHESIZER TUNE dial in the window directly above the MAIN TUNING (kilohertz) dial. As the SYNTHESIZER TUNE control is rotated, the 500-kHz increments will pass through the center of the SYNTHESIZER TUNE dial window and the PHASE LOCK indicator lamp will flash. These increments indicate the frequency in megahertz of the 500-kHz segment to which must be added the frequency in kilohertz indicated on the MAIN TUNING dial. When a number is correctly positioned in the center of the window, the PHASE LOCK indicator lamp will extinguish and receiver audio will be restored indicating that the synthesizer is locked to the frequency corresponding to the selected 500-kHz increment.

3.4.3 PHASE LOCK INDICATOR

The PHASE LOCK indicator lamp will flash and the receiver will mute when the synthesizer section of the HRO-500 receiver is not properly locked to a 500-kHz increment. When the SYNTHESIZER TUNE control is properly adjusted as described in paragraph 3.4.2, the PHASE LOCK indicator lamp will extinguish and the receiver output will become audible. As the SYNTHESIZER TUNE control is rotated to advance a new 500-kHz increment into the SYNTHESIZER TUNE dial window, the PHASE LOCK lamp will flash and the receiver output will be muted. When the new number is correctly positioned in the center of the SYNTHESIZER TUNE dial window, the PHASE LOCK indicator lamp will again extinguish and the receiver output signal will again become audible.

3.4.4 MAIN TUNING (KILOHERTZ)

The MAIN TUNING (kilohertz) control varies the output frequency of an accurate and stable linear VFO which is used as the second conversion oscillator in the HRO-500. The VFO is accurate to better than 1 kHz throughout its tuning range. The frequency to which the HRO-500 is tuned is determined by adding the frequency in kilohertz indicated on the MAIN TUNING dial to the frequency in megahertz indicated in the SYNTHESIZER TUNE dial window. In figure 10, for example, the 14.0 MHz SYNTHESIZER TUNE dial window indication plus the 253.2 kHz MAIN TUNING dial indication is equal to 14,253.2 kHz. In figure 11, the 9.5 MHz SYNTHESIZER TUNE dial indication plus the 253.2 kHz MAIN TUNING dial indication is equal to 9753.2 kHz.

3.4.5 PRESELECTOR TUNE

The HRO-500 has three RF-tuned circuits, two of which are ahead of the first RF stage to provide excellent freedom from in-band off-frequency signals, images, and other spurious responses. The PRESE-

LECTOR TUNE control is used to manually tune these circuits for maximum performance. The resonant frequency of the preselector is indicated on the PRESELECTOR TUNE dial which appears in the left window as shown in figures 10 and 11.

— CAUTION —

THE PRESELECTOR TUNE DIAL HAS BEEN CALIBRATED TO PREVENT ACCIDENTAL ADJUSTMENT TO IMAGE FREQUENCIES. ALWAYS SET THE PRESELECTOR TUNE DIAL TO THE SAME FREQUENCY THAT IS INDICATED BY THE SYNTHESIZER TUNE AND MAIN TUNING DIALS. CAREFULLY PEAK THE PRESELECTOR TUNE CONTROL IN THIS REGION FOR MAXIMUM SIGNAL RESPONSE. AFTER PEAKING, THE PRESELECTOR TUNE DIAL SHOULD INDICATE THE RECEIVER FREQUENCY $\pm \frac{1}{2}$ THE NEAREST CALIBRATION MARK. FAILURE TO SET THE PRESELECTOR TUNE CONTROL PROPERLY WILL RESULT IN EXTREMELY POOR IMAGE AND SPURIOUS SIGNAL REJECTION AND POOR SENSITIVITY. PRESELECTOR TUNE ACTION IS PARTICULARLY SHARP ON THE 0-1.5 AND 1.5-4.0 MHz BANDS. PARTICULAR CARE SHOULD BE TAKEN TO TRACK THE PRESELECTOR TUNE CONTROL ON THESE BANDS AS THE MAIN TUNING (KILOHERTZ) DIAL IS ADJUSTED. OTHERWISE, THE RECEIVER WILL SEEM INSENSITIVE.

3.4.6 BANDSWITCH

The BANDSWITCH selects the proper coil and tuning capacitor combinations to permit the HRO-500 receiver to tune the following frequency ranges: 0-1.5 MHz, 1.5-4.0 MHz, 4.0-10 MHz, 10-20 MHz, and 20-30 MHz. The BANDSWITCH operates in the RF and mixer stages, and also operates in the synthesizer local oscillator and burst generator stages.

3.4.7 AGC THRESHOLD CONTROL

The HRO-500 receiver incorporates an AGC system of high relative merit with attack and release times optimized for SSB/CW/AM reception without pops, clicks, or disablement due to noise pulses. A flat AGC system is very desirable for clear channel applications. Under certain conditions of high background signal level (such as frequently encountered in the amateur and marine bands), intelligibility of the stronger desired signal is impaired because of AGC action on background signals which increases them in amplitude. The normal procedure in such instances is to turn down the RF GAIN control of the receiver in order to reduce or eliminate AGC action on weaker background signals. Although the performance of the receiver is usually somewhat improved, AGC action

is lost and it becomes necessary to "ride" the gain control. The AGC THRESHOLD control in the HRO-500 allows the operator to insert 10, 20, or 30 db of attenuation in the incoming signal path, thereby "dropping out" the weaker background signals without changing the amount or degree of AGC action. Full AGC action is retained, thereby eliminating the need to "ride" controls, and the S-meter continues to function. To determine the strength of attenuated signals, it is only necessary to add to the S-meter indication a number in decibels corresponding to the amount of attenuation inserted with the AGC THRESHOLD control. The AGC THRESHOLD control may also be used to minimize cross-modulation on the broadcast band. Unlike most general coverage receivers, which are artificially reduced in sensitivity by their manufacturers on the broadcast band because of the extremely high signal levels often encountered, the HRO-500 is designed to operate at full usable sensitivity on these frequencies, thereby providing the required sensitivity when needed. As a result, cross-modulation may be encountered with the HRO-500 receiver on the broadcast band, but can be minimized or eliminated by artificially reducing the HRO-500 sensitivity at the operator's discretion by insertion of front-end attenuation with the AGC THRESHOLD control.

The following AGC THRESHOLD control positions are available to the operator:

OFF: In the OFF position, all AGC is removed from the HRO-500 receiver. To prevent overloading the receiver, it is recommended that the RF GAIN control setting should be such that the received signal does not drive the S-meter off scale.

ON: In this position, the HRO-500 operates normally with full AGC action. It should be noted that the RF GAIN control will affect the S-meter. Correct S-meter indications will not be obtained if the RF GAIN control is not turned fully clockwise for maximum gain.

10 DB, 20 DB, 30 DB: In these positions, full AGC action is provided in the receiver together with a nominal 10, 20, or 30 db of attenuation as desired between the first pair of RF tuned circuits and the RF amplifier stage.

The HRO-500 receiver will normally be operated with the AGC THRESHOLD control in the ON position. As mentioned above, in this position full AGC action is provided with no attenuation of incoming signals. Should reception conditions so indicate, the appropriate amount of attenuation can be inserted to optimize receiver performance. It should be noted at this point that the dynamic range and resistance to cross-modulation of the HRO-500 receiver is superior to that of many tube-type communications receivers. The AGC THRESHOLD control is incorporated in the HRO-500 to allow full usable sensitivity on the lower frequencies when needed and to provide superior performance when high-back-

ground activity is encountered; without AGC compromise for clear channel operation.

3.4.8 FUNCTION SWITCH

The FUNCTION switch is a five-position selector switch. This switch controls main power to the receiver and determines the stand-by, single-sideband/CW, amplitude modulation, and calibration modes of operation as follows:

OFF: When in the OFF position, the FUNCTION switch removes all power from the receiver in both AC and DC power input conditions.

STBY: In the stand-by condition, B+ voltage is applied to all internal oscillators of the HRO-500 but not to other stages in the receiver. In addition, terminals 1 and 2 of power output connector J-14 at the rear of the receiver are shorted to permit control of other external devices.

SSB (used for operation in SSB and CW modes): In this position, the receiver is fully operative. When the FUNCTION switch is set to SSB, the product detector is connected between the last IF stage and audio stages to permit either SSB or CW reception, and the BFO is activated.

AM: In this position, the AM diode detector is connected between the receiver IF and audio stages to permit AM reception, and the BFO is disabled.

CAL: In this position, the receiver is fully operative. When the FUNCTION switch is set to CAL, the product detector, BFO and 50-kHz calibration oscillator are activated to permit calibration of the receiver. To check the calibration of your HRO-500 receiver, refer to paragraph 3.4.1 above. It should be noted that the calibration oscillator is heard in the tunable IF of the HRO-500, not in the front end, so that the calibrator should not be used to peak the preselector.

3.4.9 AUDIO GAIN

The AUDIO GAIN control is the smaller concentric knob located at the lower left-hand corner of the receiver front panel and varies the audio output of the receiver.

3.4.10 RF GAIN

The RF GAIN control sets the basic gain level of the HRO-500 receiver. Since this control operates on the RF, tunable IF, and the first and second 230-kHz IF amplifier stages, it also determines the activity and calibration accuracy of the receiver S-meter. This control is the larger concentric knob located at the lower left-hand corner of the receiver front panel, and should normally be adjusted fully cw.

3.4.11 BANDWIDTH

The BANDWIDTH switch determines the basic receiver IF selectivity, and selects the following filter bandwidths: 8.0 kHz, 5.0 kHz, 2.5 kHz, and 0.5 kHz.

The 8.0 kHz and 5.0 kHz filter positions are fixed-tuned, while in the 2.5 kHz and 0.5 kHz positions, the filter may be tuned over a range of approximately ± 3 kHz (see paragraph 3.4.12 below).

The 8.0 kHz position is recommended for strong-signal, clear-channel AM reception. The 5.0 kHz position should be used for AM reception when weak-signal or crowded-band conditions prevail.

The 2.5 kHz position should be used for SSB operation, or AM operation when considerable adjacent channel interference is present. The excellent 6-60 db shape factor of 2.5:1, which is available through the six-pole ferrite cup-core filter, provides superior rejection of the unwanted sideband. The 2.5-kHz filter, in conjunction with the PASSBAND TUNE control (see paragraph 3.4.12), is continuously tunable over the IF passband of the receiver for USB or LSB mode of operation.

The 0.5 kHz position should be used for CW operation. This position also incorporates passband tuning of the filter which permits selection of the desired CW signal in the presence of other undesired signals without any change in the beat note frequency.

3.4.12 PASSBAND TUNE

The HRO-500 receiver incorporates a highly selective six-pole filter in the 0.5-kHz and 2.5-kHz bandwidth positions. The filter may be continuously tuned throughout the IF passband. The ability to tune the filter passband enables the operator of the HRO-500 to select either upper or lower sideband without changing the frequency of the incoming signal, or to "sort out" the CW signals in the IF passband of the HRO-500 without affecting their frequency or the pitch of their beat notes. In either the 2.5 kHz or 0.5 kHz selectivity positions, interfering signals may be "dropped off" the side of the filter while retaining the desired signal.

It will be noted that the PASSBAND TUNE control knob is marked with a wide sector (outlined in white) indicating the relative bandwidth of the 2.5-kHz filter. The panel is marked with divisions indicating relative frequency. These divisions extend to 3 kilohertz above and below the center of the passband. When the PASSBAND TUNE knob is rotated, the relative position of the 2.5-kHz filter in the passband is thereby indicated. Correspondingly, the narrow sector (solid white) on the PASSBAND TUNE control knob indicates the relative bandwidth and the position of the 0.5-kHz filter in the passband.

3.4.12.1 PASSBAND TUNING WITH THE 0.5-kHz FILTER

The 0.5-kHz filter may be tuned over a range of -1.5 kHz to $+4.5$ kHz about the BFO frequency. Zero on the PASSBAND TUNE calibration coincides with the frequency of the crystal-controlled BFO.

Normally, the 0.5-kHz sector (solid white) on the PASSBAND TUNE control knob will be set approximately 1 kHz away from the BFO as indicated on the panel calibration (see figure 14). This will result in a 1-kHz beat note when the desired signal is centered in the 0.5-kHz passband.

Adjustment of the filter to pass a CW beat note to suit the operator's preference is accomplished by using a strong steady carrier such as that from the crystal calibrator to produce an artificial beat note. The BANDWIDTH switch is set to the 2.5 kHz or 5.0 kHz position, and the MAIN TUNING (kilohertz) dial is adjusted until the desired beat note is heard. The BANDWIDTH switch is then turned to the 0.5 kHz position and the PASSBAND TUNE control slowly rotated until the beat note is loudest. At that setting of the PASSBAND TUNE control, all received signals will be loudest when their beat note is tuned to that frequency. Other undesired beat notes will be extremely low in amplitude, and true single-signal CW reception will be enjoyed. Should undesired interference from other CW signals be encountered, the PASSBAND TUNE control may be adjusted to tune the filter away from them without affecting the frequency of the desired signal. Using the PASSBAND TUNE control in this manner, it is possible to move the filter throughout the passband of the receiver to drop out interfering signals and select the desired signals—all without changing their relative frequency in the passband or the frequency of their beat notes. It is suggested that some time be taken to familiarize the operator with the operation of this control—preferably in a portion of the spectrum where there is considerable adjacent channel CW operation—since its use will frequently make the difference between no communication and solid copy. It may be pointed out that the operation of the 0.5-kHz filter and the use of the PASSBAND TUNE control may be dramatically illustrated by easily selecting the mark or space tones of an RTTY signal by use of the PASSBAND TUNE control alone.

3.4.12.2 PASSBAND TUNING WITH THE 2.5-kHz FILTER

The 2.5-kHz filter will normally be used for single-sideband operation, and should be adjusted so that the wide 2.5-kHz sector (outlined in white) on the PASSBAND TUNE control knob is offset approximately one-half kHz on either the upper-sideband or lower-sideband side of the crystal-controlled BFO frequency as shown in figures 12 or 13. The position of the 2.5-kHz filter in the passband to suit the individual operator's preference may be determined by tuning in an SSB signal in the 5.0 kHz position of the BANDWIDTH switch for most pleasing fidelity and response. The BANDWIDTH switch should then be turned to the 2.5 kHz position, and the PASSBAND TUNE control rotated until the audio response most closely approximates that obtained in the 5.0-kHz bandwidth. This position should be noted for future reference. It

should be understood that the further the filter is moved away from the BFO frequency, the greater will be the attenuation of the unwanted sideband. This may be important, for example, in making sideband suppression checks of received signals. In such instances, the 2.5-kHz sector (outlined in white) on the PASSBAND TUNE control knob should be moved 1 to 1.5 kHz way from zero. This position will provide maximum rejection of the unwanted sideband. Such performance is only obtained in a conventional receiver by actually tuning the receiver away from the signal with the main tuning control, thereby reducing intelligibility. It will be noted that adjacent channel "splatter" and heterodyne interference may be minimized or completely eliminated by moving the filter away from the interfering signal with the PASSBAND TUNE control. The PASSBAND TUNE control may easily be adjusted until a compromise between fidelity and adjacent channel rejection is obtained.

The combination of passband tuning in the HRO-500 plus the extremely effective REJECTION TUNE control described in the next paragraph offers a remarkable degree of freedom from adjacent channel interference.

3.4.12.3 REJECTION TUNE

The REJECTION TUNE control positions an extremely narrow rejection notch in the IF passband of the HRO-500. This control has a range of approximately ± 10 kHz about the receiver IF. The width of the notch is several hertz wide at -50 db, and several hundred hertz wide at -6 db. The REJECTION TUNE control also incorporates a 3:1 vernier for ease in positioning the rejection notch. The notch is completely outside the receiver passband when the control is in the OFF position. THE NOTCH SHOULD BE LEFT IN THIS POSITION WHEN NOT IN USE. This control may be used for removing interfering heterodynes or unwanted CW signals without materially affecting the intelligibility of the desired signal. Care should be taken to move the control very slowly, since the rejection notch is very narrow.

— CAUTION —

IN AM RECEPTION, CAREFULLY POSITION THE REJECTION TUNE CONTROL TO REMOVE THE UNDESIRE SIGNAL HETERODYNE AND NOT THE CARRIER OF THE DESIRE SIGNAL. IF THE WRONG REJECTION POINT IS SELECTED, THE DESIRE SIGNAL CARRIER WILL BE REMOVED AND THE RESULTING AMPLITUDE-MODULATED, SUPPRESSED-CARRIER SIGNAL WILL BE UNINTELLIGIBLE.

When severe distortion of AM signals is encountered due to "selective fading" of the carrier,

it is sometimes helpful to use exalted carrier reception. Set the FUNCTION switch to the SSB position and zero beat the carrier of the AM signal with the MAIN TUNING control. Set the filter with the PASSBAND TUNE control to receive only one sideband of the AM signal. Then set the rejection notch to remove the AM carrier with the REJECTION TUNE control. Since the product detector BFO signal now supplies the necessary carrier frequency for complete demodulation of the AM sideband, the dependency on the transmitted AM carrier has been removed and an improvement in fidelity and intelligibility will be obtained.

3.4.13 NOTCH DEPTH (REJECTION TUNE BALANCE)

The NOTCH DEPTH control, located on the rear panel of the receiver, determines the balance of the rejection tune circuit for best results. This control has been carefully positioned at the factory for maximum balance and usually will need no attention by the operator. If rejection of greater than -50 db cannot be obtained with the REJECTION TUNE control, the NOTCH DEPTH (rejection tune balance) control may require repositioning. This should be accomplished by tuning in a steady, strong carrier, such as the 50-kHz calibrator signal, and simultaneously adjusting the rear panel NOTCH DEPTH control and front panel REJECTION TUNE control until maximum rejection of the signal is obtained. To provide maximum balance over the entire range of the REJECTION TUNE control, the NOTCH DEPTH control should be set near the center of the REJECTION TUNE control range.

3.4.14 DIAL LAMP SWITCH

The DIAL lamp switch controls the power applied to the dial lamps which illuminate the S-meter scale, main tuning index, and the PRESELECTOR TUNE and SYNTHESIZER TUNE dials. During normal operation, this switch will be left in the ON position. During battery operation it may be desirable to conserve power to provide maximum battery life. Since the dial lamps draw more power from the supply than the rest of the receiver, the DIAL lamp switch should be set to the OFF position.

3.4.15 PHONES JACK

The front panel PHONES jack accepts a conventional, type PL-55, two-circuit, earphone plug. This jack will feed either high or low-impedance type earphones, or may be used to provide a front panel loudspeaker connection. The internal impedance of the PHONES jack is 3.2 ohms and the full 2 watt receiver audio output is available from it. It should be noted that the rear 3.2-ohm speaker terminals are opened when a phone plug is inserted into the PHONES jack, but the 600-ohm terminals are unaffected to allow monitoring of audio being fed to a line.

3.4.16 117V AC/12V DC SWITCH

The 117V AC/12V DC switch, located on the rear panel of the receiver, controls the input power connections to the HRO-500. For 117-volt AC operation, the top portion of the switch should be depressed. If 12-volt DC operation is desired, the bottom portion of the switch should be depressed. Correct power connections to the HRO-500 are required for either type of operation.

3.4.17 S-METER SENSITIVITY AND ZERO ADJUST

The S-METER ZERO adjust control is located on the rear panel of the HRO-500. To zero the S-meter, set the receiver FUNCTION switch to the AM position. The antenna connection to the receiver should be disconnected, or the receiver should be tuned to an unused frequency and the PRESELECTOR TUNE control tuned off resonance to insure minimum noise pickup on the antenna circuit. The S-METER ZERO adjust may then be used to set the S-meter pointer to zero on the S-units scale.

The S-meter has been carefully calibrated at the factory to indicate S-9 with a 50-uv input when the receiver is tuned to 4 MHz on the 1.5-4 MHz band. The S-meter Calibration Control, C-156, located under the receiver chassis, determines the S-meter sensitivity and normally will require no adjustment after the initial factory setting. It should be noted that the receiver S-meter sensitivity remains relatively constant from band to band. The S-meter is calibrated in db above a 1-uv input signal, and from zero to S-9 between a no-signal input and 40 db above 1 uv.

3.5 GENERAL SUGGESTIONS FOR EFFICIENT OPERATION OF THE HRO-500 RECEIVER:

3.5.1 ANTENNA MATCHING

The HRO-500 will operate at maximum rated sensitivity only when the receiving antenna presents the proper 50-ohm impedance to the receiver. Every effort should be made to provide a correct impedance match. For this reason, a separate high-impedance antenna input is provided on the rear panel of the HRO-500. This high-impedance antenna input may, in many instances, more closely match the terminal impedance of the random-length antennas often used because of the extraordinary frequency range of the HRO-500. When the receiver is used with antennas of random length, both the 50-ohm and high-impedance antenna inputs should be tried to determine best results. In extreme cases, an external antenna coupler or matching device should be employed.

3.5.2 BROADCAST BAND OPERATION

Unlike most general coverage receivers, the HRO-500 is designed to provide full rated sensitivity

in the broadcast band. Because of the extremely high signal levels in metropolitan areas, often exceeding 1.0 volt at the antenna terminals, general coverage receivers are frequently designed so that broadcast band sensitivity is only 10-50 μv or less to reduce cross-modulation resulting from high signal levels. Incorporation of the AGC THRESHOLD control in the HRO-500 (discussed in paragraph 3.4.7) allows the HRO-500 to be run at full sensitivity on the broadcast band in remote areas, with reduced sensitivity *at the operator's discretion* in metropolitan locations. In areas of high signal level, it will be found that the HRO-500 will tune most easily with at least 10 or 20 db of attenuation inserted in the signal path by means of the AGC THRESHOLD control. Care should also be taken to peak the PRESELECTOR TUNE control accurately on the desired station, since cross-modulation will be increased if the preselector is peaked on the station *causing* cross-modulation. It is particularly important to tune the preselector carefully on Bands 1 and 2 since its action is very sharp on these bands as discussed in paragraph 3.4.5.

3.5.3 LOW-FREQUENCY OPERATION

As delivered, the HRO-500 will tune the 5 kHz-500 kHz band with 25-50 μv sensitivity, but without preselection against interfering signals in the 500 kHz-1500 kHz region. In many applications, the LF-10 preselector, which provides full sensitivity and preselection, may not be necessary for satisfactory performance in the VLF region. To use the HRO-500 without the LF-10 preselector, it is necessary to attach a long wire antenna to the VLF input jack (J-3) on the rear apron, and adjust the SYNTHESIZER TUNE control so that 0.0 MHz appears in the synthesizer window. Antennas should not be connected to the 50-ohm or high-impedance inputs. It will be noted that the PRESELECTOR TUNE control has no effect in the 5 kHz-500 kHz region. The MAIN TUNING (kilohertz) dial now reads frequency directly in kHz. As the HRO-500 is tuned closer to its low limit, 5 kHz, it will be found necessary to increase IF selectivity by means of the BANDWIDTH switch to 2.5 kHz or 0.5 kHz in order to eliminate the beat note caused by the 26-MHz oscillator in the HRO-500.

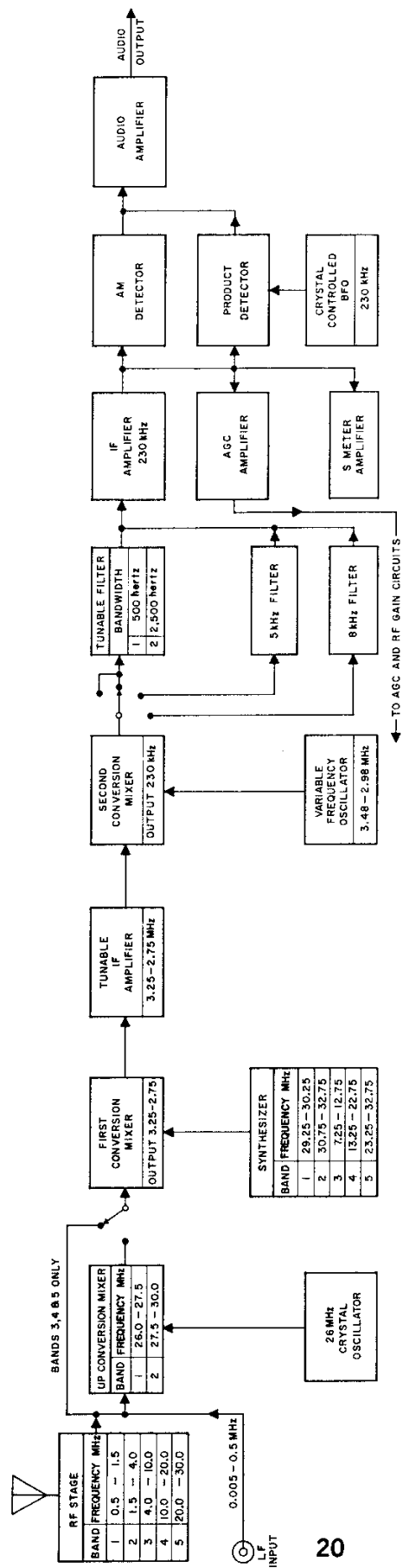

HRO-500 RECEIVER, BASIC BLOCK DIAGRAM

FIGURE 15

SECTION 4
THEORY OF OPERATION

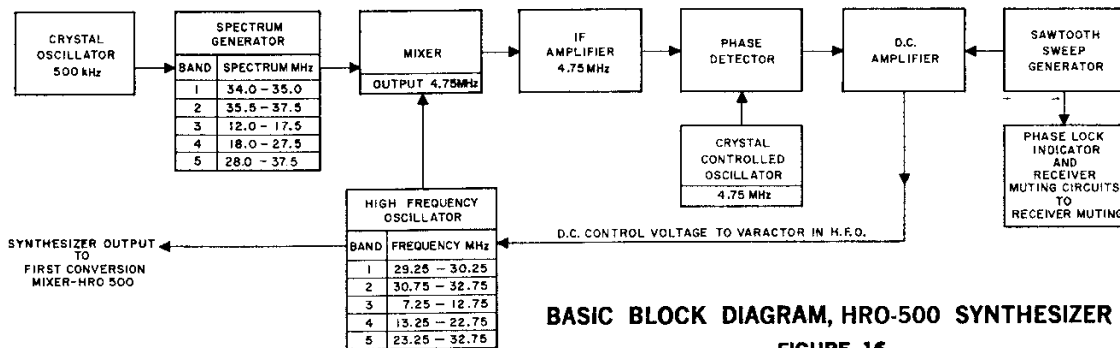

4.1 THE RECEIVER: BASIC DESCRIPTION

Figure 15, a basic block diagram of the HRO-500 receiver, illustrates the major functional sections of the receiver and the signal and oscillator frequencies throughout the system. The HRO-500 receiver functions as a triple-conversion receiver for frequencies between 5 kHz and 4 MHz. In this frequency range, the incoming signal frequency is first up-converted to 26 MHz plus the signal frequency. The resulting signal between 26.005 MHz and 30 MHz is mixed with the synthesizer output to produce the tunable IF frequency of 3.25 MHz to 2.75 MHz. A tracked oscillator then converts this tunable IF signal to the final IF frequency of 230 kHz. Frequencies between 4 MHz and 30 MHz are directly converted to the tunable IF and, in turn, to the final 230 kHz IF. The receiver functions as a double-conversion superheterodyne in the frequency range between 4 MHz and 30 MHz.

Incoming signals between 500 kHz and 30 MHz are fed through the RF stage, which is switched in five ranges. The output of the RF stage is coupled to the up-conversion mixer on Bands 1 and 2 and is coupled directly to the first conversion mixer on Bands 3, 4, and 5. The separate low-frequency input used between 5 kHz and 500 kHz by-passes the RF stage and is connected directly to the up-conversion mixer. A 26-MHz crystal oscillator provides injection to the up-conversion mixers. The resulting output on Bands 1 and 2 is coupled to the first conversion mixer.

The oscillator input to the first conversion mixer, a series of fifty-two discrete frequencies lying between 7.25 MHz and 32.75 MHz, is obtained from the synthesizer portion of the HRO-500 which is discussed in detail in paragraphs 4.2 and 4.4. This series of frequencies will mix any desired 500-kHz range of the HF spectrum to the tunable IF frequency between 3.25 MHz and 2.75 MHz. To select a desired 500-kHz segment of the HF spectrum, it is necessary to set the BANDSWITCH to the desired preselector range. Bandswitch sections in the RF stage, the up-conversion mixer, and the synthesizer connect these circuits

for proper operation and selection of signals in the basic preselector band. In the event that low-frequency reception is desired, the BANDSWITCH must be placed in position 1 for proper up-conversion mixer and synthesizer operation even though the RF stage is not used.

The tunable IF amplifier output lying between 3.25 MHz and 2.75 MHz is coupled to the second conversion mixer together with the output of the variable frequency oscillator operating between 3.48 MHz and 2.98 MHz. The tunable IF amplifier and variable frequency oscillator are tracked. The output of the second conversion mixer is at 230 kHz.

Output from the second conversion mixer is fed to the various IF filter circuits. The BANDWIDTH switch selects the tunable filter, the 5-kHz filter, or the 8-kHz filter, depending on the operator's preference. Output from each of these filters is coupled to the input of the 230-kHz IF amplifier.

Output from the 230-kHz IF amplifier feeds the AM detector, the product detector, the AGC amplifier, and the S-meter amplifier. The output of a crystal-controlled BFO is also fed to the product detector. The front panel FUNCTION switch then selects between the AM or product detector as desired by the operator. The signal is finally processed through the audio amplifier and into a suitable speaker or line termination.

4.2 THE SYNTHESIZER: BASIC DESCRIPTION

Operation of the synthesizer portion of the HRO-500 is best understood by reference to the synthesizer block diagram, figure 16. Fifty-two discrete oscillator signals are generated from the harmonics of a single, highly stable, crystal oscillator operating at 500 kHz. These discrete oscillator frequencies occur at intervals of 500 kHz starting at 7.25 MHz and ending at 32.75 MHz. In addition to generation of the high-frequency oscillator signals, phase lock indicator circuits provide a front panel warning

that the synthesizer circuits are out of lock. Receiver muting circuits prevent reception of unwanted or annoying signals until such time as proper high-frequency oscillator injection has been restored.

The stable 500-kHz crystal oscillator drives a spectrum generator providing a coherent burst of energy. The coherent nature of the spectrum generator signal insures that the output will contain only harmonics of the original 500-kHz reference frequency. The harmonic content will, however, have an amplitude distribution around the tuned frequency of the spectrum generator with the harmonics of maximum amplitude always occurring at the spectrum generator frequency. The nature of the frequency and time domain of the spectrum generator signal is illustrated in figure 17. The spectrum generator is bandswitched and tracked to the high-frequency oscillator so that the harmonic of maximum amplitude will fall between 12 MHz and 37.5 MHz as required for proper phase lock and control of the synthesizer portion of the HRO-500.

The output of the spectrum generator is coupled to a mixer together with a signal from the high-frequency oscillator. The high-frequency oscillator is 4.75 MHz below the desired spectrum generator output. A 4.75 MHz IF signal is obtained. This signal is, in turn, amplified and fed to the phase detector.

A second crystal-controlled oscillator operating at 4.75 MHz provides the gating signal to the phase detector. If the output from the IF amplifier at 4.75 MHz is not identical to the output from the 4.75-MHz crystal-controlled oscillator, an audio beat note is generated whose frequency is the difference between the oscillator and the IF output frequencies. This audio beat note is amplified by the DC amplifier and applied to a varactor in the high-frequency oscillator circuit. The audio signal thus applied will cause the high-frequency oscillator to sweep in frequency at the beat note rate, resulting in a sweep of the 4.75-MHz IF amplifier output. Within one cycle the IF amplifier output should approach and equal the output of the 4.75-MHz crystal-controlled oscillator, at which time the polarity of varicap control is such that the two frequencies will lock together. With the now identical frequencies, there can be no audio beat note. There will be, however, a DC output whose amplitude and polarity is determined by the phase-angle difference between the two signals arriving at the phase detector. Any drift of the high-frequency oscillator will cause a phase-angle change and, in turn, a DC output change of proper polarity will be applied to the varactor and cancel the original drift. Thus, the high-frequency oscillator is phase-locked on a cycle-for-cycle basis with the desired harmonic of the 500-kHz crystal-controlled reference oscillator. Reference to figure 18 will indicate the various oscillator frequencies required for the fifty-two high-frequency oscillator outputs between 7.25 MHz and 32.75 MHz.

When phase lock control is lost, the high-frequency oscillator signal may be widely removed from that required to phase lock with the desired spectrum generator output harmonic. A sweep generator is incorporated to vary the varactor voltage from +3 to +8 volts by the sweep generator sawtooth, thus insuring a wide frequency scan of the high-frequency oscillator until a 4.75-MHz IF amplifier output again occurs at the phase detector. The 4.75-MHz output will cause the phase loop to lock and the sawtooth generator to cease operation.

During such times that the phase loop is sweeping, the output of the sawtooth generator is detected and amplified to light the PHASE LOCK indicator lamp on the front panel. Additional circuits filter the lamp information and generate a muting signal to silence the 230-kHz receiver IF during those periods when the phase loop is out of lock. When phase lock is restored, the sawtooth sweep generator can no longer function, the PHASE LOCK indicator lamp is extinguished, and the receiver is restored to normal operation.

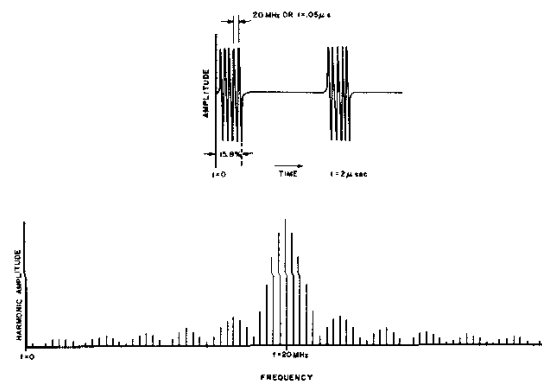

SPECTRUM GENERATOR, FREQUENCY AND TIME DOMAIN

FIGURE 17

4.3 THE RECEIVER: DETAILED DESCRIPTION

The detailed block diagram, figure 19, indicates each individual receiver stage, functional transistor, and functional diode. It further indicates the elementary nature of BAND and FUNCTION switching and the number of tuned circuits associated with each coupling network.

Signal inputs between 500 kHz and 30 MHz are coupled through two tuned circuits to the RF amplifier. The output of the RF amplifier contains an additional tuned circuit tracked to signal frequency. The BANDSWITCH and PRESELECTOR TUNE controls function in both the RF amplifier input and output to provide proper antenna matching, selectivity, and tuning throughout the HF spectrum. A detailed discussion is found in paragraph 4.3.1.

<i>Bandswitch RF Amplifier</i>	<i>26-MHz Osc.</i>	<i>Up Conversion Mixer Output</i>	<i>First Conversion Mixer Input</i>	<i>High-Frequency Oscillator Tuned Buffer, Untuned Buffer</i>	<i>Synthesizer Tune</i>	<i>Spectrum Generator Output</i>
0.0 MHz to 1.5 MHz	26 MHz	26 MHz to 27.5 MHz	26.0 MHz to 27.5 MHz	29.25 MHz	0.0 MHz	34.0 MHz
				29.75 MHz	0.5 MHz	34.5 MHz
				30.25 MHz	1.0 MHz	35.0 MHz
1.5 MHz to 4.0 MHz	26 MHz	27.5 MHz to 30 MHz	27.5 MHz to 30 MHz	30.75 MHz	1.5 MHz	35.5 MHz
				31.25 MHz	2.0 MHz	36.0 MHz
				31.75 MHz	2.5 MHz	36.5 MHz
				32.25 MHz	3.0 MHz	37.0 MHz
				32.75 MHz	3.5 MHz	37.5 MHz
4.0 MHz to 10 MHz	OFF	None	4.0 MHz to 10 MHz	7.25 MHz	4.0 MHz	12.0 MHz
				7.75 MHz	4.5 MHz	12.5 MHz
				8.25 MHz	5.0 MHz	13.0 MHz
				8.75 MHz	5.5 MHz	13.5 MHz
				9.25 MHz	6.0 MHz	14.0 MHz
				9.75 MHz	6.5 MHz	14.5 MHz
				10.25 MHz	7.0 MHz	15.0 MHz
				10.75 MHz	7.5 MHz	15.5 MHz
				11.25 MHz	8.0 MHz	16.0 MHz
				11.75 MHz	8.5 MHz	16.5 MHz
				12.25 MHz	9.0 MHz	17.0 MHz
12.75 MHz	9.5 MHz	17.5 MHz				
10 MHz to 20 MHz	OFF	None	10 MHz to 20 MHz	13.25 MHz	10.0 MHz	18.0 MHz
				13.75 MHz	10.5 MHz	18.5 MHz
				14.25 MHz	11.0 MHz	19.0 MHz
				14.75 MHz	11.5 MHz	19.5 MHz
				15.25 MHz	12.0 MHz	20.0 MHz
				15.75 MHz	12.5 MHz	20.5 MHz
				16.25 MHz	13.0 MHz	21.0 MHz
				16.75 MHz	13.5 MHz	21.5 MHz
				17.25 MHz	14.0 MHz	22.0 MHz
				17.75 MHz	14.5 MHz	22.5 MHz
				18.25 MHz	15.0 MHz	23.0 MHz
				18.75 MHz	15.5 MHz	23.5 MHz
				19.25 MHz	16.0 MHz	24.0 MHz
				19.75 MHz	16.5 MHz	24.5 MHz
				20.25 MHz	17.0 MHz	25.0 MHz
				20.75 MHz	17.5 MHz	25.5 MHz
				21.25 MHz	18.0 MHz	26.0 MHz
21.75 MHz	18.5 MHz	26.5 MHz				
22.25 MHz	19.0 MHz	27.0 MHz				
22.75 MHz	19.5 MHz	27.5 MHz				
20 MHz to 30 MHz	OFF	None	20 MHz to 30 MHz	23.25 MHz	20.0 MHz	28.0 MHz
				23.75 MHz	20.5 MHz	28.5 MHz
				24.25 MHz	21.0 MHz	29.0 MHz
				24.75 MHz	21.5 MHz	29.5 MHz
				25.25 MHz	22.0 MHz	30.0 MHz
				25.75 MHz	22.5 MHz	30.5 MHz
				26.25 MHz	23.0 MHz	31.0 MHz
				26.75 MHz	23.5 MHz	31.5 MHz
				27.25 MHz	24.0 MHz	32.0 MHz
				27.75 MHz	24.5 MHz	32.5 MHz
				28.25 MHz	25.0 MHz	33.0 MHz
				28.75 MHz	25.5 MHz	33.5 MHz
				29.25 MHz	26.0 MHz	34.0 MHz
				29.75 MHz	26.5 MHz	34.5 MHz
				30.25 MHz	27.0 MHz	35.0 MHz
				30.75 MHz	27.5 MHz	35.5 MHz
				31.25 MHz	28.0 MHz	36.0 MHz
31.75 MHz	28.5 MHz	36.5 MHz				
32.25 MHz	29.0 MHz	37.0 MHz				
32.75 MHz	29.5 MHz	37.5 MHz				

HRO-500 FREQUENCY CHART

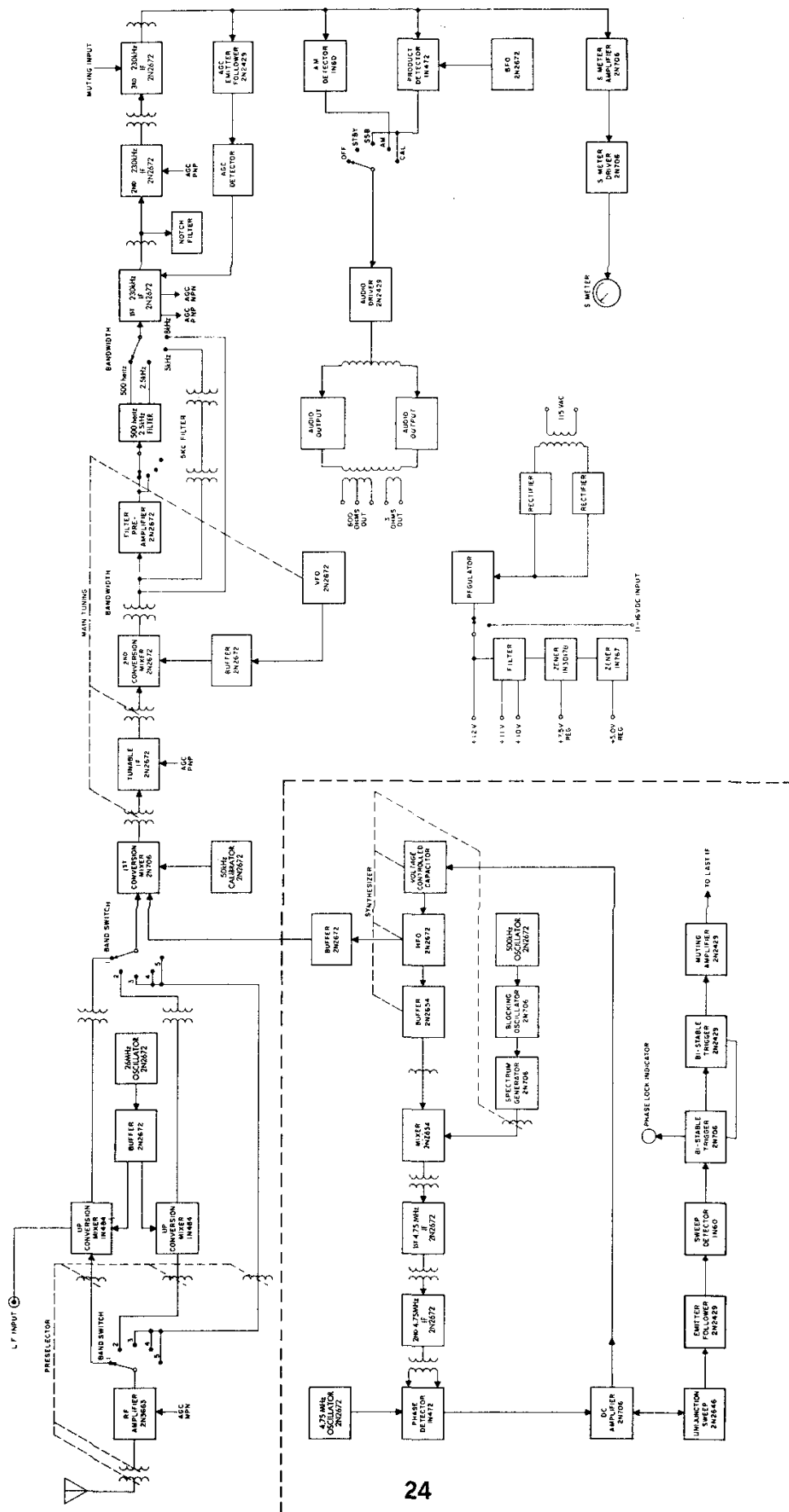

HRO-500 RECEIVER, DETAILED BLOCK DIAGRAM

FIGURE 19

When operating on Band 1, the BANDSWITCH connects the RF amplifier output to an up-conversion mixer whose output is a double-tuned bandpass circuit operating in the frequency range from 26 MHz to 27.5 MHz. When the BANDSWITCH is placed on band 2, the output of the RF amplifier is coupled to an up-conversion mixer whose output is connected to a double-tuned bandpass circuit operating between 27.5 MHz and 30 MHz. A 26 MHz crystal oscillator operates on Bands 1 and 2 and feeds a buffer amplifier, and in turn, each of the up-conversion mixers. A separate low-frequency input connection is provided to the up-conversion mixer used for Band 1 operation, by-passing the RF amplifier to allow low-frequency signals to be directly converted to the frequency range between 26 MHz and 26.5 MHz. The up-converters are discussed in paragraph 4.3.2.

When the BANDSWITCH is placed in positions 3, 4, or 5, the output of the RF amplifier is directly connected to the first conversion mixer. On Bands 1 and 2, the input to the first conversion mixer is selected from the appropriate up-conversion mixer. The synthesizer output is coupled to the first conversion mixer as the local oscillator signal. The frequency selected from the synthesizer is always such that the desired 500-kHz segment of the HF spectrum will create a difference in frequency between 3.25 MHz and 2.75 MHz. Paragraph 4.3.3. discusses the first conversion mixer.

The tunable IF amplifier discussed in paragraph 4.3.4 operates between 3.25 MHz and 2.75 MHz and contains four tuned circuits, two in its input and two in its output path. The amplified IF signal is connected to the second conversion mixer together with an output from the VFO operating between 3.48 MHz and 2.98 MHz. A VFO buffer provides injection to the second conversion mixer and isolation of the oscillator. The second conversion mixer and VFO are discussed in paragraph 4.3.5.

The output of the second conversion mixer is coupled through two 8-kHz wide-tuned circuits to the filter preamplifier and six-pole tunable filter and to the 5-kHz wide-tuned circuits. When the BANDWIDTH switch is placed in the 500 hertz position or the 2.5 kHz position, the input of the first 230-kHz IF amplifier is coupled to the six-pole filter. When the BANDWIDTH switch is placed in the 5 kHz position, the second conversion mixer output is coupled through four tuned circuits to the first 230-kHz IF amplifier. When the BANDWIDTH switch is placed in the 8 kHz position, the second conversion mixer output is coupled through the two 8-kHz wide-tuned circuits directly to the IF amplifier. The filter circuits are discussed in paragraph 4.3.6.

A single-tuned circuit and rejection notch filter are employed between the first and second IF amplifiers. A double-tuned circuit provides selectivity between the second and third 230-kHz IF amplifiers and a single-tuned circuit is used in the output of the third 230-kHz IF amplifier. IF circuits are discussed in paragraph 4.3.7. The IF output is coupled to the AGC emitter follower, the AM detector (see paragraph 4.3.9), the product detector (see paragraph 4.3.10), and the S-meter amplifier. The FUNCTION switch connects the audio amplifier to either the AM detector or product detector as required. A separate crystal-controlled BFO provides oscillator injection to the product detector at 230 kHz. The audio driver feeds the push-pull audio output stages and, in turn, the loudspeaker or 600-ohm audio line. Paragraph 4.3.11 describes the audio amplifier.

The S-meter amplifier and driver directly feed the S-meter independently of AGC system action (see paragraph 4.3.12). The AGC emitter follower feeds the AGC detector and, in turn, the first 230-kHz IF amplifier. The first 230-kHz IF stage also functions as an AGC amplifier and sense inverter. AGC outputs for both PNP and NPN transistors are thus obtained. The PNP AGC output is coupled to the tunable IF amplifier and the second 230-kHz IF amplifier. The NPN AGC information is coupled to the RF amplifier. AGC circuits are discussed in paragraph 4.3.8.

A separate 50-kHz crystal calibrator is provided for calibration of the main VFO dial. The 50-kHz calibrator signal is fed to the first conversion mixer output and is heard in the tunable IF frequency range on all bands. Details are contained in paragraph 4.3.13.

4.3.1 THE RF AMPLIFIER

Input from the 50-ohm antenna jack J-1 is coupled through the BANDSWITCH to 50-ohm taps in the RF input transformers T-1, T-2, T-3, T-4, and T-5. Input from the high-impedance antenna input, J-2, is coupled through 10 pf to the preselector tuning capacitor C-4A. The primary and secondary windings of the antenna coils are tuned respectively by the preselector tuning capacitor sections C-4A and C-4B, together with suitable padding capacitors and trimmers selected by the BANDSWITCH sections S1-1F and S1-2F. Low-impedance taps on the input transformer secondaries are selected by the BANDSWITCH and coupled to the AGC THRESHOLD switch, which provides an insertion loss of 0, 10, 20, or 30 db through the resistive network composed of resistors R-1, R-2, R-3, R-4, and R-5. The output from the AGC THRESHOLD switch is directly coupled to the base of the RF amplifier Q-1.

The RF amplifier collector coils L-2, L-3, L-4, L-5, and L-6 serve as the collector load for the RF amplifier. They are tuned by the preselector tuning capacitor section C-4C together with suitable padding and trimming capacitors selected by the BANDSWITCH section S1-3R. Low-impedance taps on these collector coils are also selected by the BANDSWITCH to match and feed the following stages.

4.3.2 THE UP-CONVERTERS

The up-converter diodes CR-1 and CR-2 are used only on Bands 1 and 2 of the HRO-500, covering frequency ranges from 5 kHz to 4 MHz. When the BANDSWITCH is placed on Band 1, amplified and preselected signals in the range from 500 kHz to 1.5 MHz are coupled from the RF amplifier collector coil L-4 to the up-converter mixer CR-1. The low-frequency input range from 5 kHz to 500 kHz is coupled from the low-frequency input jack J-3 to the up-converter diode CR-1 through the resistive network composed of R-11 and R-12. The output circuit of up-converter CR-1 contains transformer T-6, a double-tuned circuit operating as a bandpass circuit between 26 MHz and 27.5 MHz. The low-impedance tap in the secondary winding of T-6 provides matching to the following stages.

When the BANDSWITCH is placed on Band 2, incoming amplified and preselected signals in the range from 1.5 MHz to 4 MHz are coupled from the RF amplifier collector coil L-5 directly to the up-converter diode CR-2. Transformer T-7 functions as a bandpass circuit between 27.5 MHz and 30 MHz in the up-converter output. A low-impedance tap in the secondary winding of T-7 provides matching to the following stage.

The 26-MHz oscillator Q-2 operates as a modified Pierce circuit. The 26-MHz coil L-19 and capacitor C-39 serve as a collector load for Q-2. Feedback is obtained through the 26-MHz crystal X-1 directly to the base of Q-2. A 26-MHz output is obtained from the collector of Q-2 and coupled through capacitor C-42 to the base of the 26 MHz buffer Q-4. The coil L-7 and capacitors C-44 and C-45 operating at 26 MHz serve as the collector load for the 26-MHz buffer. The 26-MHz output is coupled through capacitors C-31 and C-32 to the up-converter diodes CR-1 and CR-2. A separate low-impedance output is obtained across the capacitive divider composed of C-44 and C-45 and coupled to the 26-MHz output jack J-4 on the rear apron of the HRO-500.

4.3.3 THE FIRST CONVERSION MIXER

Outputs from the up-converter bandpass coils T-6 and T-7 and the preselector coils L-2, L-3, and L-6 are selected by the BANDSWITCH and coupled directly to the base of the first conversion mixer Q-3 through capacitor C-74. A signal from the high-frequency oscillator in the synthesizer section of the HRO-500 is coupled through capacitor C-47 to the emitter of the first conversion mixer Q-3. The coupling capacitor C-47 and choke L-28 constitute a high-pass section to eliminate any unwanted low-

frequency information which may arrive from the synthesizer channel. The choke L-28 also represents a very low impedance in the emitter return path to the desired tunable IF signal between 3.25 MHz and 2.75 MHz. The collector of the first conversion mixer is coupled directly to a matching tap in the primary of transformer T-8, the input to the tunable IF amplifier.

4.3.4 THE TUNABLE IF AMPLIFIER

The double-tuned transformer T-8 provides selectivity in the frequency range from 3.25 MHz to 2.75 MHz. The primary and secondary are tuned respectively by the main tuning capacitor sections C-52A and C-52B. A low-impedance tap in the secondary winding provides for impedance matching to the tunable IF amplifier Q-5. A capacitive attenuator composed of capacitors C-54 and C-60 reduces the signal level at this point to avoid excessive gain and overload prior to final signal filtering. The collector of the tunable IF amplifier is coupled to the matching tap in transformer T-9, which also provides selectivity between 3.25 MHz and 2.75 MHz. The primary and secondary windings of T-9 are tuned by main tuning capacitor sections C-52C and C-52D. A low-impedance tap in the secondary winding of T-9 provides impedance matching to the second conversion mixer. Coupling is accomplished through capacitor C-61.

4.3.5 THE SECOND CONVERSION MIXER AND VFO

The VFO Q-7 operates in a grounded-base configuration. The VFO coil L-10 is tuned by main tuning capacitor section C-52E. The special plate shape, wide spacing, and use of a noncumulative serrated tracking section provide excellent stability and a linear frequency characteristic. The VFO circuit has been carefully adjusted to provide a calibration accuracy of ± 1 kHz across the entire 500-kHz band. Careful temperature compensation and the use of highly stable components insures a thermal drift characteristic not exceeding 100 hertz in any ten-minute period. Feedback for the oscillator section is obtained through capacitor C-72 to the emitter from a low-impedance tap in collector coil L-10. The VFO buffer Q-8 is very lightly coupled to the VFO circuits through capacitor C-75. Capacitor C-70 provides a high degree of buffer swamping so that changes in buffer characteristics will be negligible in their effect on the VFO circuit. A resistor, R-41, in the buffer collector circuit provides a low-impedance VFO output at jack J-5 on the rear apron of the HRO-500.

The VFO signal occurring across resistors R-39 and R-40 in the VFO buffer emitter return is coupled through capacitor C-66 to the emitter of the second conversion mixer Q-6. The tunable IF signal between 3.25 MHz and 2.75 MHz on the base of the second conversion mixer is subtracted from the VFO signal to obtain the 230-kHz IF output. The choke

L-8 and capacitor C-64 are selected to provide a high-impedance emitter return to the oscillator injection signal occurring between 3.48 MHz and 2.98 MHz and a very low-impedance return in the emitter circuit to the mixer output frequency of 230 kHz.

The collector of the second conversion mixer is impedance matched to the double-tuned 8-kHz transformer T-10. A high impedance output is obtained from the secondary of T-10 through capacitor C-76 to the double-tuned 5-kHz transformers T-11 and T-12. The four tuned circuits contained in transformers T-11 and T-12 provide the basic 5-kHz bandwidth of the HRO-500 receiver.

A low-impedance tap is also provided in the secondary of the 8-kHz transformer T-10. A 230-kHz IF signal is coupled from this low-impedance tap through the resistive attenuator made up of R-32 and R-33 to provide a basic 8-kHz bandwidth for the final 230-kHz IF amplifier. The output from the tap on the secondary of T-10 is also coupled directly to the base of the filter preamplifier Q-9 through coupling capacitor C-109.

4.3.6. THE 230-kHz FILTER AND FILTER PREAMPLIFIER

The filter preamplifier Q-9 operates at 230 kHz and provides gain to overcome the insertion loss of the 230-kHz tunable filter. The collector of the filter preamplifier is matched to the collector load L-17 which resonates with capacitor C-112 at 230 kHz. Output from the filter preamplifier is coupled through capacitor C-112 to the six-pole tunable IF filter.

The six-pole tunable IF filter uses six LC-tuned circuits. The inductors L-11, L-12, L-13, L-14, L-15, and L-16 are wound in ferrite cup-cores for extremely high Q and are carefully matched for precise control of filter tuning and bandwidth. The inductors in each case are resonated by the filter tuning capacitor sections C-89A through C-89F and by the additional trimming and padding capacitors associated with each coil. Coupling between the filter elements is accomplished by a series of capacitive taps such as that composed of C-90 and C-91 and similar components on each of the additional filter coils.

The BANDWIDTH switch S-3 is incorporated as an integral part of the 230-kHz tunable IF filter. In the 500 hertz position, capacitors C-115, C-117, C-118, C-119, and C-121 function as coupling elements between each of the filter sections. Output from the final filter section is obtained from the capacitive tap between C-106 and C-107. When the BANDWIDTH switch is placed in the 2.5 kHz position, capacitors C-116, C-122, C-123, C-184 and C-185 function as coupling elements between the filter sections. Additional damping circuits are added by capacitors C-114 and C-120 and resistors R-45 and R-46. Output is again obtained from the capacitive tap in the final filter section.

When the BANDWIDTH switch is placed in the 5 kHz position, the filter output is disconnected and output is obtained from the capacitive divider composed of C-81 and C-82 on the secondary of the 5-Kc bandwidth transformer T-12. When the BANDWIDTH switch is placed in the 8 kHz position, output is obtained from the resistive attenuator previously discussed on the secondary of the 8-kHz bandwidth transformer T-10.

Typical bandwidth and filter curves for all settings of the BANDWIDTH switch are illustrated in figure 20.

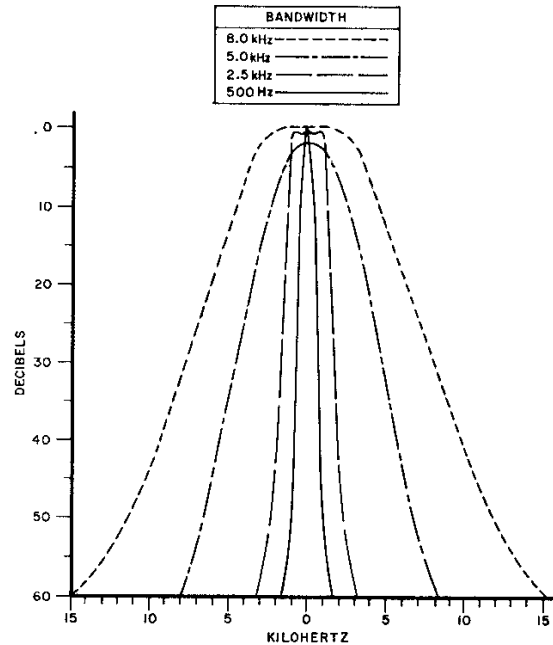

IF SELECTIVITY

FIGURE 20

4.3.7. THE 230-kHz IF AMPLIFIER

The selected 230-kHz output from the BANDWIDTH switch is coupled through capacitor C-137 to the base of the first 230-kHz IF amplifier Q-12. A single-tuned coil L-120 in the collector circuit serves as a collector load. The capacitors C-139 and C-140 serve as tuning elements for L-20 and provide a capacitive tap for impedance matching to the bifilar notch circuit. The notch tuning coil L-22 is resonated by the notch tuning capacitor C-145 and the impedance matching network composed of capacitors C-143 and C-144. The notch circuit presents an impedance to the center of the bifilar notch coil L-21 which creates a frequency of zero coupling near the resonant point of the notch tuning circuit. The resistor R-67 and NOTCH DEPTH control R-68 are adjusted to provide a resistive balance to the resistive component presented by the notch tuning circuit. At frequencies well removed from the notch frequency, there is no attenuation across the bifilar notch coil

L-21. The 230-kHz IF signal is, in turn, coupled through capacitor C-147 to the base of the second 230-kHz IF amplifier Q-13. Capacitor C-146 serves as a terminating impedance for the bifilar notch circuit. The double-tuned transformer T-13 operating at 230 kHz serves the collector load of the second 230-kHz IF amplifier Q-13. The collector of the IF amplifier is impedance matched to the primary of T-13. A low-impedance tap on the secondary of T-13 provides impedance matching to the third 230-kHz IF amplifier Q-14.

The single-tuned coil L-23 serves as the collector load for the third 230-kHz IF amplifier. The collector is matched to L-23 by an inductive tap. An output is obtained through capacitor C-191 directly from the collector of the third 230-kHz IF amplifier and fed to the AGC emitter follower. An output from the top of the 230-kHz coil L-23 is also coupled to the AM detector and through capacitor C-161 to the product detector. An additional output is obtained directly from the collector of the third 230-kHz IF amplifier for the S-meter detector. A low-impedance tap on coil L-23 provides a 230-kHz IF output signal at jack J-11 on the rear apron of the HRO-500.

4.3.8 THE AGC CIRCUITS

The 230-kHz IF signal from the collector of the third 230-kHz IF amplifier Q-14 is coupled through capacitor C-191 to the base of the AGC emitter follower. The amplified signal appears across R-56 in the emitter circuit and is coupled through capacitor C-134 to the AGC voltage doubler composed of CR-7 and CR-8. The low-impedance feed from the emitter follower permits rapid charging of the AGC capacitor C-130 in a positive polarity with respect to the AGC return reference. This positive potential cannot discharge backwards through the AGC voltage doubling diode CR-8, and must discharge through resistor R-51. This results in effective fast-attack, slow-release AGC action. The AGC voltage doubler return path is connected to the RF GAIN control which operates in a voltage divider network between the +12 volt source and ground in such a manner that adjustment of the RF GAIN control will control the reference level from which AGC voltage is developed. This reference level is directly coupled to the AGC voltage doubler and the AGC capacitor and in turn the AGC bus.

When the AGC THRESHOLD switch is in the OFF position, the AGC voltage doubler output is disconnected from the AGC bus. RF GAIN control information is coupled through resistor R-123 to provide RF gain information on the AGC bus. An external connection is provided through R-129 to J-14, pin 11, to allow external control of the RF gain.

AGC information is applied to the base return of the first 230-kHz IF amplifier Q-12. A change in AGC or RF gain control information will cause a change of current in the first 230-kHz amplifier. This will develop a change in voltage across R-64 and R-66 in the first 230-kHz IF amplifier collector circuit. Increasing signal strength will result in positive-going AGC information relative to the RF gain reference level. This will move the first 230-kHz IF amplifier Q-12 towards cutoff and reduce its gain. The decreasing current will result in a positive-going change across the emitter resistor, R-62, which is coupled to the tunable IF amplifier Q-5, and the base of the second 230-kHz IF amplifier Q-13.

The same signal change will result in a negative-going voltage change across resistor R-64 in the collector of the first 230-kHz IF amplifier Q-12. This voltage is applied to the base of the RF amplifier Q-1 and will reduce the gain of the RF amplifier. The positive-going AGC potential for PNP transistors is referenced to approximately +8.5 volts and is connected to J-14, pin 10, on the rear apron of the HRO-500. The negative-going AGC potential for use with NPN transistors is referenced to approximately +1.5 volts and is available at J-14, pin 9, for use with external NPN transistors.

4.3.9 THE AM DETECTOR

A 230-kHz signal from L-23, the IF output coil, is coupled to CR-9, the AM detector. Capacitor C-157 provides RF by-passing and the AUDIO GAIN control R-98 serves as the detector load. AM detector output is directly available on J-14, pin 18, on the rear apron of the HRO-500.

4.3.10 THE PRODUCT DETECTOR AND BFO

The BFO transistor Q-15 functions as a crystal-controlled Pierce oscillator. L-24, together with capacitors C-167 and C-168, provide the collector load. Feedback is accomplished through the 230-kHz crystal, X-3, to the base of Q-15. A BFO output is obtained from the capacitive divider composed of C-167 and C-168 and is connected to the BFO output jack J-6 on the rear apron of the HRO-500. A low-impedance inductive tap provides BFO signal for injection to the product detector diodes CR-4A and CR-4B through capacitor C-163 and C-164. High level signal at 230-kHz output from L-23 is coupled through capacitor C-161 to the primary of the product detector coil T-14. The secondary of this coil is center-tapped and untuned, providing two signals 180° apart in phase which are applied to the product detector diodes. The product detector output is filtered and connected through the FUNCTION switch S-4 to the detector output on J-14, pin 18, and also to the AUDIO GAIN control R-98.

The BFO is enabled through the FUNCTION switch S-4 in the single-sideband (SSB) and calibrate (CAL) positions by application of +7.5 volts. In the OFF, STBY, and AM positions, the BFO is disabled. The BFO enabling circuit is also connected to J-14, pin 14, on the rear apron to permit remote BFO enable-disable when desired.

4.3.11 THE AUDIO AMPLIFIER

The audio signal on the AUDIO GAIN control is coupled through capacitor C-174 to the base of the audio driver Q-22. An external audio input is provided on J-14, pin 17, to allow input from external audio sources or to permit the use of an external AUDIO GAIN control connected between the detector output J-14, pin 18, and the audio input.

The audio driver transformer T-16 serves as collector load for the audio driver stage. The secondary of this transformer is center-tapped to drive the push-pull audio output stage. The center-tapped audio output transformer T-17 matches the load to the audio output transistor pair Q-20 and Q-21. The secondary of the audio output transformer contains a 3.2-ohm winding and a balanced center-tapped 600-ohm winding which permits use of center-tapped ground, single-ended ground, or ungrounded 600-ohm line termination. In addition, the PHONES jack J-7 permits insertion of high- or low-impedance headphones across the 3.2-ohm speaker winding. All audio output connections are made on the audio terminal strip J-10.

4.3.12 THE S-METER CIRCUITS

230-kHz output is obtained directly from the collector of the third 230-kHz IF amplifier Q-14 through trimmer C-156, the S-meter calibration adjustment. This signal is applied directly to the base of the S-meter detector Q-24. The S-METER ZERO adjustment, R-108, is connected in the S-meter detector base return to vary the bias on this circuit. Adjustment of the S-METER ZERO potentiometer will alter DC current flow in the S-meter detector and provide for zero set. The 230-kHz IF signal is rectified in the base-to-emitter junction of the S-meter detector transistor Q-24 and results in a DC output signal at the junction of C-172 and R-109. The S-meter information is then coupled through R-109 and R-110 to the base of the S-meter amplifier Q-23. Resistors R-113, R-114, R-115 and transistor Q-23 form a bridge circuit with the S-meter connected across the arms. This bridge circuit is essentially balanced when the S-meter is at zero. Incoming signals will unbalance the bridge through transistor Q-23 and cause proper S-meter indication. The S-meter is calibrated in db above 1 microvolt input and in S units from S-1 to S-9.

4.3.13 THE CRYSTAL CALIBRATOR

Transistor Q-10 is used as separate 50-kHz crystal calibrator. The calibrator circuit functions in a modified Pierce configuration. Inductor L-18 and capacitor C-126 form the collector load for the calibrator transistor Q-10. Feedback is obtained through the 50-kHz crystal X-2 to the transistor base. Trimming capacitor C-125 permits accurate adjustment of the 50-kHz calibrator frequency.

4.4 THE SYNTHESIZER: DETAILED DESCRIPTION

Examination of the detailed block diagram, figure 19, will help in understanding the detailed synthesizer discussion to follow. Basically, a 500-kHz crystal-controlled reference oscillator is coupled to a blocking oscillator for pulse shaping. The output pulse is used to key the burst generator, providing the necessary coherent output burst. These stages are referred to as the spectrum generator as discussed in paragraph 4.4.1.

The high-frequency oscillator has two buffer stages: the first, an untuned buffer inserted between it and the first conversion mixer of the receiver proper; and the second, a tuned buffer provided between the high-frequency oscillator and the mixer preceding the comparison IF circuits as discussed in paragraph 4.4.5.

The mixer at the input to the 4.75 MHz comparison IF receives signals from the high-frequency oscillator by way of the tuned buffer and directly from the spectrum generator. The mixer output at 4.75 MHz is amplified through two IF amplifier stages and fed as a balanced signal to the phase detector. The mixer and two IF stages are considered in paragraph 4.4.2.

The separate 4.75 MHz oscillator which feeds the phase detector is considered as part of the phase detector circuit in paragraph 4.4.3.

Output from the phase detector is fed to the DC amplifier. The amplified output is applied to the varactor for control of the high-frequency oscillator as discussed in paragraph 4.4.4.

The sweep circuit functions as part of the DC amplifier circuit, but will be considered separately in paragraph 4.4.6.

Finally, the output from the sweep circuit is connected to the sweep detector through an emitter follower. The output of the sweep detector is used to trigger a bi-stable trigger circuit and to operate the PHASE LOCK indicator on the front panel. An output is also derived from this bi-stable trigger circuit to supply information to the muting amplifier which controls the gain of the last 230-kHz IF amplifier in the receiver proper, as discussed in paragraph 4.4.7.



500-KC SYNCHRONIZING PULSE WAVEFORM
FIGURE 21

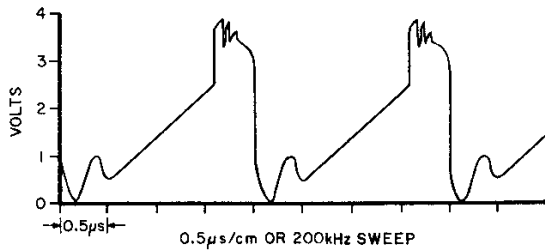

BLOCKING OSCILLATOR, BASE WAVEFORM
FIGURE 22

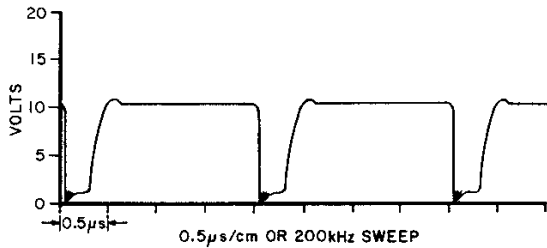

BLOCKING OSCILLATOR, COLLECTOR WAVEFORM
FIGURE 23

4.4.1 THE SPECTRUM GENERATOR

The crystal-controlled 500-kHz reference oscillator is a conventional Pierce circuit. L-301 functions as the collector load. Feedback is obtained through the 500-kHz crystal, X-300, to the base of the transistor Q-300. This oscillator has been designed to be well overdriven so that collector current flows during a small percentage of the 500-kHz repetition rate. The resistor R-305 in the collector return path is used to develop a short positive pulse coincident with periods of collector current conduction. The waveform is illustrated in figure 21.

Q-301 is a blocking oscillator adjusted to free-run at a frequency just below 500 kHz. The pulse from the 500-kHz crystal oscillator is coupled to the block-

ing oscillator base circuit through the blocking oscillator transformer T-300. This pulse synchronizes the blocking oscillator frequency to the frequency of the crystal-controlled oscillator. Capacitor C-300 and resistor R-306 determine the basic blocking oscillator repetition rate. The blocking oscillator base waveform is illustrated in figure 22. Limiting diodes are used on the primary and secondary of the blocking oscillator transformer to prevent inductively induced voltage transients which might harm the blocking oscillator transistor. A large amplitude negative pulse illustrated in figure 23 is available from the collector winding of the blocking oscillator transformer.

The negative pulse is coupled to the base of the burst generator transistor Q-302 through capacitor C-401. The collector of the burst generator is connected to a high Q tuned circuit. The burst generator is biased to that high-collector current flows at all times, except when a pulse is present. When current flows the collector impedance is very low. This impedance combined with a resistor R-310 in the collector path places heavy damping on the tuned circuit. When the blocking oscillator pulse arrives at the base of the burst transistor, the system is driven to cutoff, collector current flow ceases, and damping is removed from the tuned circuits. The stored magnetic energy in the tuned circuit will cause a high-amplitude oscillation which is interrupted at the 500-kHz reference frequency. The coils L-305, L-306, and L-307 in association with padding and trimming capacitors, a tuning capacitor section C-373 and a bandswitch section S-301-IF, provide band-switching and tracking of the burst generator free-running frequency to the frequency of desired harmonic output. The spectrum generator output waveform is illustrated in figure 24 for three bands.

The blocking oscillator coil and circuit are constructed so that the output pulse width has approximately a 15.8 percent duty cycle. This duty cycle causes a harmonic output from the spectrum generator which is essentially zero at all frequencies which are nineteen harmonics removed from the desired harmonic frequency. Harmonics occur every 500 kHz, therefore, the harmonic which is removed from the desired harmonic by 9.5 MHz is eliminated. This frequency corresponds to the image frequency of the 4.75-MHz IF operating in conjunction with the high-frequency oscillator. Thus, the system is relatively free of images and no additional selectivity or harmonic filtering is needed prior to use of the burst generator signal in the comparison mixer.

4.4.2 THE COMPARISON IF CIRCUITS

Coupling capacitors C-311 through C-315 are used to insure substantially constant amplitude from the burst oscillator to the comparison mixer Q-306. The output of the spectrum generator and a signal from the high-frequency oscillator are coupled to-

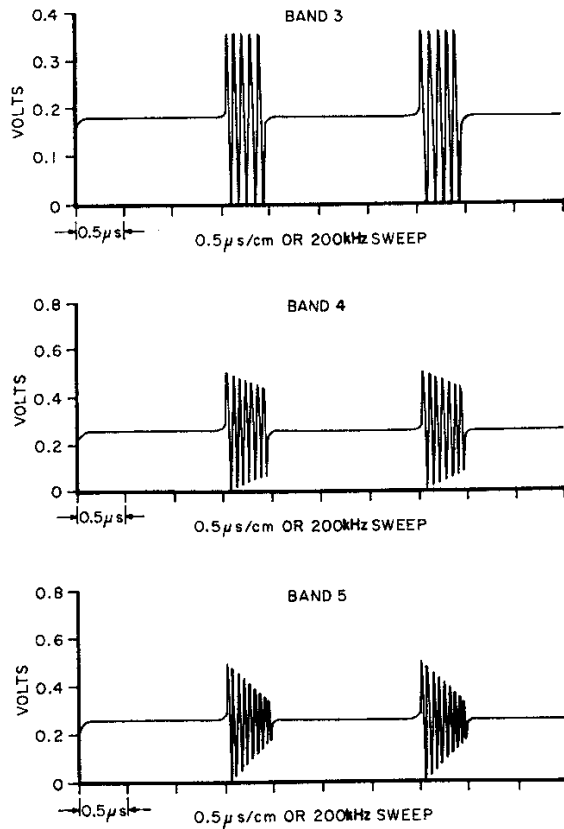

SPECTRUM GENERATOR OUTPUT
MEASURED AT JUNCTION OF C345 AND C346

SPECTRUM GENERATOR, OUTPUT WAVEFORM FIGURE 24

gether at the base of Q-306, which functions as a conventional transistor mixer. The double-tuned transformer T-301 in the collector circuit of the comparison mixer provides selectivity and gain. A neutralizing section of the primary winding provides transistor neutralization through capacitor C-351. A secondary tap on the transformer matches the base impedance of Q-307, the first 4.75-MHz amplifier, through capacitor C-398.

A double-tuned transformer T-302 again provides gain and selectivity. Neutralization of the first IF amplifier is accomplished through capacitor C-397. A matching tap is coupled to transistor Q-308, the second 4.75-MHz IF amplifier, through capacitor C-354. This amplifier is biased just above cutoff by resistors R-335 and R-337. In this manner, very weak signals resulting from unwanted mixer products or noise will occur in the cutoff region of the transistor and will not be amplified. The desired IF amplifier signal has sufficient amplitude to override the cutoff bias and will actually drive transistor Q-308 into saturation providing effective limiting of unwanted amplitude modulation which may occur on the IF signal. Transformer T-303 serves as collector load for gain and selectivity in the collector circuit of Q-308.

Neutralization is provided through capacitor C-360. The secondary of T-303 is a balanced center-tapped winding providing two 4.75-MHz outputs with a 180° phase difference for the phase detector.

4.4.3 THE PHASE DETECTOR

The diodes CR-301A and CR-301B (a matched pair) are fed with the balanced output from T-303. This output is approximately 4 volts peak-to-peak in amplitude. An independent 4.75-MHz signal is derived from the 4.75-MHz oscillator Q-309. The crystal X-301 operating at 4.75 MHz serves as a collector load for transistor Q-309. The oscillator is operated in a grounded-base configuration with feedback from collector-to-emitter through capacitors C-363 and C-364. A 4-volt oscillator signal is applied in parallel to the phase detector diodes through capacitors C-368 and C-369. This gating signal in conjunction with the signals from the comparison IF will cause one of the diodes to conduct more heavily than the other, resulting in either a positive or a negative output at the junction of R-343 and R-344. Actually, the DC amplifier is so constructed that negative signals will take it beyond cutoff. Therefore, phase lock will always be obtained with a positive output sense from the phase detector. In normal operation, phase lock control will normally be obtained for phase detector voltages between +0.3 and +0.8 volts.

4.4.4 DC AMPLIFIER AND VARACTOR CONTROL

The positive DC output from the phase detector is filtered by the low-pass section made up of L-322 and C-371. In addition, resistor R-342 and capacitor C-370 adjust the gain-frequency characteristic to insure phase-lock stability. The output of the phase detector is coupled directly to the base of Q-310, the DC amplifier. Resistor R-345 in the collector circuit serves as the collector load. The amplified signal occurring at the collector of the DC amplifier will normally fall in the range between +3 and +8 volts when the synthesizer is properly operating and locked. This DC output is further filtered by R-346 and L-311, together with the capacity of the coaxial cable, and is applied to the varactor C-188. A tuning capacitor section C-332B, in series with the varactor return, is used to reduce the effectiveness of varactor control while tuning across a synthesizer band. This insures that the amount of control which the varactor can exert on the high-frequency oscillator is essentially constant across any one tuning band. Capacitor C-389 provides additional varactor control on Band 1 and capacitor C-333 establishes minimum varactor control on Bands 2 through 5. The varactor C-188 is actually connected to the tuned circuits across the tuning capacitor C-332A so that varactor control will be substantially constant from band-to-band depending on the padding capacitors in use.

A DC clamping voltage is provided by resistor R-350 and R-351 and is applied to the DC amplifier output bus through clamping diode CR-300. When the DC amplifier output is below +3 volts, the diode will be forward-biased and will prevent further operation of the DC amplifier. This prevents control of the varactor in very low voltage regions to prevent excessive frequency control and improper synthesizer unlocking when tuning from one 500-kHz segment to another.

4.4.5 THE HIGH-FREQUENCY OSCILLATOR

The high-frequency oscillator is operated in a grounded-base mode with a tuned circuit functioning as the collector load. Feedback is obtained through capacitors C-335 and C-337. The inductors L-308, L-309, and L-310 are bandswitched and padded to insure proper frequency range and synthesizer dial calibration. The synthesizer tuning capacitor C-332A is controlled by the SYNTHESIZER TUNE control. The inductor L-308 is used commonly between Bands 1, 2, and 5. Additional padding adjustments C-328 and C-329 provide for range set on Bands 1 and 2.

An output from the emitter is coupled through C-336 to the base of Q-304, the tuned buffer amplifier. The coils L-315, L-316, and L-317 serve as collector loads for the buffer and are tuned by the synthesizer tuning capacitor section C-332C and the associated trimmers and padders selected by band-switch sections S-300-2F and S-300-2R. An output is taken directly from the collector through C-343 and C-344 to feed the comparison mixer Q-306, thus completing the phase-lock loop.

An additional output is obtained from the high-frequency oscillator Q-303 directly from the collector circuit through capacitor C-334 and is coupled to the base of the untuned buffer Q-305. A 330-ohm resistor R-316 in the collector circuit provides high-frequency oscillator output at jack J-300 on the rear apron of the HRO-500. A 330-ohm resistor R-318 in the emitter circuit provides the injection signal for the first conversion mixer of the receiver.

4.4.6 THE SWEEP CIRCUIT

When the phase loop circuit is not locked, the high-frequency oscillator Q-303 may not be near a frequency 4.75 MHz below the desired harmonic output from the spectrum generator and the system will not lock. To overcome this possibility, a unijunction sweep circuit is incorporated in the HRO-500 synthesizer. Q-311 is coupled to the DC amplifier output by means of a network composed of R-349 and C-374. This network has the additional function of providing gain frequency characteristics in the con-

rol circuit to insure stable phase loop operation. In the event that there is no IF output, there will be no output from the phase detector and the DC amplifier Q-310 will be cut off. Under these conditions, capacitor C-374 will charge towards the 10-volt supply potential through resistors R-345, R-346, and R-349, causing a ramp or sawtooth voltage to exist on the varactor control lead. During this time, the emitter of Q-311 has a very high impedance and does not affect the external circuit. When the firing potential of the unijunction transistor Q-311 is reached, the emitter-to-base 1 characteristic will rapidly become a very low impedance causing capacitor C-374 to be rapidly discharged to chassis. As the potential on capacitor C-374 approaches zero, there will no longer be sufficient energy to maintain the discharge condition of the unijunction transistor and the emitter-to-base 1 characteristic will rapidly revert to a high impedance. Capacitor C-374 will again charge towards the supply potential and a repetitive sawtooth will be created. This sawtooth will swing the varactor through a considerable capacity range and cause a wide and rapid frequency scanning of the high-frequency oscillator until such time as a 4.75-MHz IF signal results. At this time, a DC output will be obtained from the phase detector. Collector current will flow in the DC amplifier, causing a voltage drop in R-345 such that capacitor C-374 can no longer charge to the breakdown potential of the unijunction transistor. At this time, phase lock control has been resumed and the sawtooth sweep will cease.

4.4.7 PHASE LOCK INDICATOR AND RECEIVER MUTING CIRCUITS

The sawtooth appearing at the base of the unijunction transistor Q-311 is coupled through capacitor C-158 to an emitter follower Q-19. When the phase loop is locked, there is no sawtooth and there is no information at the base of Q-19. If for any reason phase lock control is lost, a sawtooth will appear at the base of Q-19 and be amplified by the emitter follower across resistor R-81. This sawtooth is in turn, applied to the sweep detector diode CR-6. This will generate a positive voltage on the base of Q-18, one half of a bi-stable trigger circuit. The positive voltage is amplified across resistors R-84 and R-86 in the collector circuit of Q-18 and, in turn, is applied to the base of Q-17 as a negative-going signal. This negative signal will cause Q-17 to conduct heavily and light PL-6, the PHASE LOCK indicator lamp. The positive voltage now appearing across PL-6 is, in turn, coupled back to the base of Q-18, the first half of the bi-stable trigger circuit, through resistor R-89. The positive feedback from PL-6 insures rapid turn-on of the indicator lamp. When phase lock control is resumed, the sawtooth waveform will disappear, the positive signal on the base Q-18 will gradually decay, and the PHASE LOCK indicator lamp, PL-6, will be extinguished.

The negative signal available at the collector of Q-18 is also coupled through R-87 to the base of Q-16, the muting diode. This negative signal will cause the muting diode, Q-16, to conduct heavily, resulting in a potential of less than +11 volts on the emitter of Q-14, which will cut off the third 230-kHz IF amplifier of the receiver.

An input is provided from J-14, pin 13, through resistor R-82 to the bi-stable trigger circuit. Application of a positive voltage, such as +12 volts available from the power supply output, will cause the receiver to mute and the PHASE LOCK warming lamp to be illuminated. An additional input is provided from J-14, pin 12, directly to the base of the muting diode and collector of the bi-stable trigger Q-18. Grounding this input lead at J-14 will also result in muting of the receiver and illumination of the PHASE LOCK indicator lamp.

4.5 THE POWER SUPPLY: BASIC DESCRIPTION

A block diagram of the power supply is included as part of figure 19. The 117 volt, 50-60 hertz AC supply is fed to the power transformer. The secondary is connected to the power supply rectifiers and, in turn, to a series electronic regulator. The output of this regulator is approximately 12 volts positive DC. A transfer switch provides for connection of the power supply filters and zener diodes to the output of the electronic regulator when the HRO-500 is operated on the 117V AC line or directly to the 11-16V DC input when the HRO-500 is operated from a DC source. The +12-volt output is additionally filtered with taps provided for +11 and +10 volts in the filter circuits. The +10 volts is applied to a zener diode which provides a +7.5 volt regulated output. The 7.5 volt regulated output is further applied to a second zener diode which provides +5 volts of regulated output.

4.5.1 THE POWER SUPPLY: DETAILED DESCRIPTION

Considering the schematic in detail, the primary of the power transformer T-18 is split into two 117V windings. These windings are operated in parallel for 117-volt operation and in series for 234-volt operation. The FUNCTION switch S-4 is used for direct primary power switching. The 117V AC/12 V DC transfer switch S-6 disconnects the primary of the power transformer from the AC line in the event of DC operation. A 12.6-volt AC secondary on the power transformer feeds the panel lamps. The panel lamp switch S-5, located on the front panel, permits the operator to turn the panel lamps on or off. A contact on the 117V AC/12 V DC transfer switch S-6 disconnects the power transformer secondary and connects the 11-16V input directly to the panel lamp circuit.

A balanced secondary winding on the power transformer T-18 is coupled to the rectifiers CR-11 and CR-12. This winding is designed to develop a 24-volt DC output after rectification. The ground return of the power supply circuit is arranged through the regulator transistor, Q-25, in such a way that +12 volts is developed at the output of the power supply rectifiers and -12 volts is developed at the center tap of the transformer winding. A zener diode connected from the +12-volt power supply output to the base of the regulator transistor serves as a voltage reference and transfers any power supply output fluctuation directly to the base of the regulator transistor, thereby varying the impedance between the collector and grounded emitter of the regulator transistor, Q-25, in such a manner that any variation in power supply output is effectively cancelled by a variation in the resistance of the power supply center-tap return. All variations due to fluctuating load or line voltages will occur in the negative leg of the power supply and there will be no change in the +12-volt output. A third pole on the 117V AC/12V DC transfer switch is used to select the output of the 117V AC supply or to directly select the 11-16V DC input. A reverse polarity protection diode, CR-14, is wired directly in series with the 11-16V DC input to prevent damage to the HRO-500 in the event of reverse-polarity application.

The +12-volt output is directly used in some stages. Additional filtering is obtained through resistor R-119 and capacitor C-135C. The voltage drop occurring in R-119 provides a +11-volt output from the power supply. This output is again filtered by resistor R-118 and capacitor C-135B to provide a +10-volt output from the power supply. The 10-volt supply is then dropped through resistor R-117 to the zener diode CR-10 to provide a highly regulated +7.5-volt output. This output is again dropped through resistor R-116 and regulated by the zener diode CR-3 to provide a stable +5-volt output for all of the critical oscillators. Distribution of power is shown in detail in figure 25. All of the various power supply outputs are available on J-14 on the rear apron of the HRO-500 according to the following list:

- +12 volts—pin 4
- +11 volts—pin 5
- +10 volts—pin 6
- +7.5 volts—pin 7
- +5 volts—pin 8
- ground (common negative)—pin 3

Pins 1 and 2 of the accessory plug J-14 are connected to the FUNCTION switch. When the FUNCTION switch is placed in the stand-by (STBY) position, terminals 1 and 2 are connected together for control of external relays or transmitter. In all other positions of the FUNCTION switch, the external connections on pins 1 and 2 of J-14 are open-circuited.

+ 24 VOLTS			
Q-25	Power Supply Regulator		
RECEIVER		SYNTHESIZER	
+ 12 VOLTS			
Q-1	RF amplifier	Q-302	Burst generator
Q-14	Third 230 kHz IF amplifier	Q-16	Muting circuit
Q-20, Q-21	Audio output RF GAIN return	Q-17, Q-18	Bi-stable trigger circuit
+ 11 VOLTS			
Q-4	26 MHz buffer	Q-306	4.75 MHz mixer
Q-3	First conversion mixer	Q-307	First 4.75 MHz IF amplifier
Q-22	Audio driver	Q-308	Second 4.75 MHz IF amplifier
Q-24	S-meter detector	Q-19	Indicator emitter follower
Q-11	AGC emitter follower	Q-310	DC amplifier
Q-23	S-meter bridge amplifier		
+ 10 VOLTS			
Q-6	Second conversion mixer	Q-302	Burst generator bias
Q-5	Tunable IF amplifier	Q-301	Blocking oscillator
Q-9	Filter preamplifier	Q-311	Unijunction sweep
Q-12	First 230 kHz IF amplifier	CR-300	Clamping diode bias
Q-13	Second 230 kHz IF amplifier		
+ 7.5 VOLTS			
Q-2	26 MHz oscillator	Q-304	High-frequency oscillator tuned buffer
Q-3	First conversion mixer	Q-305	High-frequency oscillator untuned buffer
Q-15	BFO	Q-309	4.75 MHz oscillator
Q-10	50 kHz crystal calibrator		
+ 5 VOLTS			
Q-7	Variable frequency oscillator	Q-300	500 kHz oscillator
Q-8	Variable frequency oscillator buffer	Q-303	High-frequency oscillator

POWER SUPPLY DISTRIBUTION

FIGURE 25

SECTION 5
HRO-500 TEST AND ALIGNMENT

5.1 GENERAL:

HRO-500 TEST AND ALIGNMENT PROCEDURES SHOULD BE PERFORMED ONLY BY QUALIFIED PERSONNEL.

Any one of the laboratory adjustment or test procedures may be performed individually, provided that the proper test setup and preliminary adjustments are made. All warnings, cautions, and notes applicable to a particular procedure should be strictly heeded. If an abnormal indication is obtained during the performance of these procedures, troubleshooting and repair of the circuit under test is indicated. For general troubleshooting procedures, refer to paragraph 5.6. To assure satisfactory receiver performance after repairs have been made, repeat the alignment or test procedure applicable to the circuit in which the repair was made.

5.2 EQUIPMENT REQUIRED:

Vacuum tube voltmeter (VTVM) or AC/DC volt-ohm-milliammeter (VOM) with sensitivity of 20,000 ohms per volt or better

Signal generator covering the range from 50 kHz to 50 MHz with properly terminated and calibrated output

Frequency counter, crystal calibrator, or other means of accurate signal generator frequency calibration

High-frequency oscilloscope covering the range from DC to 30 MHz with a sensitivity of 50 mv per centimeter or better and a low-capacity input probe

Sweep generator capable of sweeping at approximately 60 hertz over a frequency range from approximately 25 MHz to 31 MHz

Mechanical sweep drive capable of sweeping at approximately 1 hertz over a frequency range from approximately 200 kHz to 240 kHz when used with the signal generator.

Standard audio output meter

Audio oscillator covering the range from 10 hertz to 100 kHz

Suitable alignment tools for adjustment of coils and capacitors

HRO-500TS matching speaker

5.3 INITIAL CONTROL SETTINGS:

FRONT PANEL

FUNCTION switch	OFF
BANDSWITCH	4.0-10 MHz
RF GAIN	Full cw (clockwise)
AUDIO GAIN	Full ccw (counterclockwise)
SYNTHESIZER TUNE	9.5 MHz
PRESELECTOR TUNE	10.0 MHz
MAIN TUNING	500 kHz
REJECTION TUNE	OFF
PASSBAND TUNE	Narrow white rectangle centered at zero
AGC THRESHOLD	OFF
DIAL lamp switch	To right: ON
BANDWIDTH switch	8 kHz

REAR PANEL

NOTCH DEPTH	As received, or set to mid-range
S-METER ZERO	As received, or set to mid-range
117V AC/12V DC switch	117V AC position

INTERNAL CONTROLS

S-meter sensitivity	As received, or 1/4 turn from maximum capacity
---------------------	--

5.4 POWER SUPPLY VOLTAGE TEST:

Check that all HRO-500 controls are set to the positions indicated in paragraph 5.3. Apply 117V AC, 50-60 hertz power to the rear panel 117V AC connector J-8. Set the front panel FUNCTION switch to the CAL position. Using either the VTVM or VOM, measure the power supply voltages at the accessory connector J-14 on the rear panel. The power supply output voltages should be as shown in the table below.

J-14 POWER SUPPLY OUTPUT VOLTAGES

Chassis or Pin 3 Ground Reference

Pin No.	Volts, DC	Tolerance
4	+12 V	±10%
5	+11 V	±10%
6	+10 V	±10%
7	+7.5 V	±10%
8	+5 V	±10%
9	+1.5 V	±½ V
10	+8.5 V	±10%

5.5 ALIGNMENT:

5.5.1 AUDIO TESTS

Check that all HRO-500 controls are set to the positions indicated in paragraph 5.3. Connect the audio output meter to the receiver audio output through either the front panel PHONES jack J-7 or to the rear panel 3.2-ohm and GND terminals of J-10. Connect the speaker leads and the oscilloscope input leads across the audio output meter terminals. Set the audio output meter impedance to 3.2 ohms and the power multiplier to 5 watts full scale. Turn the FUNCTION switch from OFF to either SSB, AM, or CAL. Apply a 0.06-volt, 400-hertz signal from the audio oscillator output leads between pin 18 of J-14 (detector output) and ground. Turn up the AUDIO GAIN control and listen to be sure that there is audio output.

Disconnect the speaker and rotate the AUDIO GAIN control slowly cw until the audio output meter indicates 2 watts. The oscilloscope display should show no distortion at the 2-watt output level. Advance the audio oscillator output level for a maximum indication on the audio output meter. The meter should indicate more than 3 watts of power output. The oscilloscope display will show definite clipping.

Decrease the audio oscillator output level until the audio output meter indicates 2 watts. Rotate the AUDIO GAIN control slowly ccw until the audio output meter indicates approximately 10 mw. Connect the speaker across the audio output meter terminals and listen to the 400-hertz tone. There should be no evidence of distortion.

Frequency response may be checked by observing the audio output meter as the audio oscillator frequency is varied. To maintain a constant input to the audio amplifier while checking the frequency response, the audio oscillator output should be monitored with the AC scale of the VTVM or VOM. The frequencies at which the audio output meter indications have dropped by 6-db should not be lower than 5.5 kHz and not higher than 100 hertz.

After completing the audio tests, remove all test equipment leads connected to the HRO-500 receiver.

5.5.2 PRELIMINARY S-METER ADJUSTMENT

With the FUNCTION switch in the AM position, the S-meter should indicate 0 on the S-UNITS scale. If it does not, adjust the rear panel S-METER ZERO control R-108 until the S-meter reads 0 S-units.

5.5.3 BFO AND PRODUCT DETECTOR ALIGNMENT

Check that all HRO-500 controls are set to the positions indicated in paragraph 5.3. Remove the muting transistor, Q-16, and turn the FUNCTION switch to the SSB position. Connect the signal generator through a 0.01-μf capacitor to the base of the third IF transistor Q-14. Set the signal generator frequency to exactly 230 kHz by comparison to the frequency counter or other calibrating means, and set the output to approximately 0.1 volt without modulation. Connect the HRO-500TS speaker to the 3.2-ohm and GND terminals of J-10.

Advance the AUDIO GAIN control in a cw direction until a beat note is heard. Connect the oscilloscope input leads to the BFO output jack, J-6, to monitor the BFO output level. Adjust the tuning core of L-24 for zero beat. As L-24 is adjusted, the BFO output as displayed on the oscilloscope should not be less than 70 per cent of the maximum level obtainable.

Connect the audio output meter to the receiver audio output through either the front panel PHONES jack J-7 or the 3.2-ohm and GND terminals on the rear panel terminal strip J-10. Tune the signal generator until a beat note of approximately 400 hertz is obtained at the audio output terminals. Peak the product detector transformer, T-14, by adjusting the tuning core for maximum audio output. Note the maximum output meter indication.

After completing the BFO and product detector alignment procedure, remove all test equipment leads connected to the HRO-500 receiver and insert the muting transistor, Q-16, into its socket.

5.5.4 AM DETECTOR CHECK

Remove the muting transistor, Q-16. Connect the signal generator through a 0.01- μ f capacitor to the base of the third IF transistor, Q-14. Set the signal generator for approximately 230 kHz and 0.1 volt. Modulate the signal generator 30 per cent with 400 hertz. Connect the HRO-500TS speaker and audio output meter to the 3.2-ohm and GND terminals of J-10.

Turn the FUNCTION switch to the AM position. A 400-hertz audio output should be obtained. To compare the relative gains of the AM and product detectors, the Product Detector Test as described in paragraph 5.5.3 above must be performed. Do not change the setting of the AUDIO GAIN control between the two tests. The output meter should indicate a change in output of less than 6 db between the two tests.

After completing the AM detector check, remove all test equipment leads connected to the HRO-500 receiver and insert the muting transistor, Q-16, into its socket.

5.5.5. 230-kHz IF ALIGNMENT

Check that all HRO-500 controls are set to the positions indicated in paragraph 5.3. Remove the muting transistor, Q-16. Connect the HRO-500TS speaker to the 3.2-ohm and GND terminals of J-10. Connect the signal generator through a 0.01- μ f capacitor to the base of the second conversion mixer transistor, Q-6. Set the signal generator to approximately 230 kHz. If BFO alignment of paragraph 5.5.3 has been performed, turn the FUNCTION switch to SSB position and zero beat the signal generator. If paragraph 5.5.3 has not been performed, set the signal generator to exactly 230 kHz by comparison to the frequency counter or other calibrating means.

With the FUNCTION switch in the AM position and the BANDWIDTH switch in the 8.0 kHz position, adjust the tuning cores of L-23, T-13 (top and bottom), L-20, and T-10 (top and bottom) for a peak, or maximum S-meter indication, in the order given.

— CAUTION —

TO PREVENT OVERLOADING AND IMPROPER TUNING IN THE IF SYSTEM, THE SIGNAL GENERATOR OUTPUT SHOULD BE REDUCED AS REQUIRED TO MAINTAIN MID-SCALE S-METER INDICATIONS DURING ALIGNMENT. MAKE SURE THAT THE TUNING CORES IN ALL TWO-WINDING TRANSFORMERS ARE SET TO THE OUTSIDE END OF THE WINDINGS. TUNING CORES WHICH ARE IMPROPERLY SET BETWEEN WINDINGS WILL PRODUCE UNWANTED COUPLING. THIS, IN TURN, WILL CAUSE IMPROPER RESPONSE AS WELL AS EXTREME DIFFICULTY DURING ALIGNMENT. TO ASSURE PROPER CORE ADJUSTMENT, TURN EACH CORE TOWARDS ITS EXTREME OUTER POSITION. THEN TURN THE CORE TOWARDS THE CENTER OF THE COIL UNTIL A RESPONSE IS OBTAINED. STOP TURNING AT THE FIRST RESPONSE POINT.

After completing the 230-kHz IF alignment, remove all test equipment connected to the HRO-500 receiver and insert the muting transistor, Q-16, into its socket.

5.5.6 NOTCH CIRCUIT ALIGNMENT

Check that all HRO-500 controls are set to the positions indicated in paragraph 5.3. Remove the muting transistor, Q-16. Connect the signal generator through a 0.01- μ f capacitor to the base of the second conversion mixer, Q-6. Connect the HRO-500TS speaker and audio output meter to the 3.2-ohm and GND terminals of J-10. Turn the FUNCTION switch to the SSB position. Set the signal generator near 230 kHz without modulation and adjust for a beat note of 400 hertz. Turn the REJECTION TUNE control to the center of its range. A noticeable drop in the audio output of the receiver should be noted. If necessary, advance the signal generator output control as required to maintain the audible beat note during alignment.

Alternately adjust the tuning core of the notch tuning coil, L-22, and the rear panel NOTCH DEPTH control, R-68, for minimum audio output. Since L-22 and R-68 interact slightly, each control should be alternately adjusted for minimum output until the signal generator output is advanced 60 db above the level required for the same audio level when the REJECTION TUNE control is in the OFF position.

After completing the notch circuit alignment, remove all test equipment leads connected to the HRO-500 receiver and insert the muting transistor, Q-16, into its socket.

5.5.7 5-kHz FILTER ADJUSTMENT

Check that all HRO-500 controls are set to the positions indicated in paragraph 5.3. Remove the muting transistor, Q-16. Connect the signal generator through a 0.01- μ f capacitor to the base of the second conversion mixer transistor, Q-6. Connect the HRO-500TS speaker to the 3.2-ohm and GND terminals of J-10. Set the signal generator to exactly 230 kHz by comparison to the frequency counter or other calibrating means. If section 5.5.3 has been performed, the signal generator may be set to zero beat without calibration.

Turn the FUNCTION switch to the AM position and modulate the signal generator output 30 per cent with 400 hertz. With the BANDWIDTH switch in the 5.0 kHz position, adjust the tuning cores on the top and bottom of T-12 and T-11 for a peak, or maximum S-meter indication. Observe the core position and overload CAUTION in paragraph 5.5.5.

After completing the 5-kHz filter adjustment, remove all test equipment leads connected to the HRO-500 receiver and insert the muting transistor, Q-16, into its socket.

5.5.8 500-HERTZ AND 2.5-kHz FILTER ALIGNMENT

The six-tuned-circuit passband tuning filter of the HRO-500 is designed so that careful alignment in the narrow 0.5 kHz position of the BANDWIDTH switch will result in approximately the correct response in the 2.5 kHz position. For the best 2.5 kHz passband response, laboratory alignment with a mechanical sweep drive and an oscilloscope presentation should be used.

Check that all HRO-500 controls are set to the positions indicated in paragraph 5.3. Remove the muting transistor, Q-16. Connect the signal generator through a 0.01-mfd capacitor to the base of the second conversion mixer transistor, Q-6.

Couple the mechanical sweep drive to the 230-kHz signal generator tuning knob. Adjust the mechanical sweep drive controls so that the signal generator sweeps a frequency range of 6 to 8 kHz on either side of 230 kHz. Connect the sweep output of the mechanical drive to the horizontal amplifier of the oscilloscope. Connect the AM detector output to the vertical oscilloscope amplifier. **MAKE SURE THAT BOTH OSCILLOSCOPE AMPLIFIERS ARE DC COUPLED.** Keep the sweep speed motor at zero and adjust the motor drive knob so that the signal generator is set at exactly 230 kHz by comparison with the frequency counter or external calibrator. If paragraph 5.5.3 has been performed, the signal generator may be set by turning the FUNCTION switch to the SSB position, the signal generator modulation off, and zero beating the signal generator with the receiver BFO.

Turn the PASSBAND TUNE control knob fully ccw. The center of the narrow white band on the PASSBAND TUNE control knob should be between 1.5 and 2 on the panel scale at LSB. If it is not, loosen the setscrews and reposition the knob on the shaft. Rotate the PASSBAND TUNE control knob cw until the narrow white band is centered on zero.

With the BANDWIDTH switch in the 0.5 kHz position, adjust the unmodulated signal generator output for a half-scale S-meter indication and carefully recheck the signal generator frequency. Carefully adjust trimmer capacitors C-108, C-104, C-101, C-98, C-95, and C-94 for a peak, or maximum S-meter indication, in the order given.

— CAUTION —

ALL SIX CAPACITORS MUST GO THROUGH PEAKS WITH THEIR ADJUSTING SCREWS SET AT LESS THAN $2\frac{1}{2}$ TURNS FROM MAXIMUM CAPACITY. IF THIS CONDITION CANNOT BE MET, OR DIPS OCCUR IN THE OUTPUT WHEN THE TRIMMER ADJUSTMENT IS MADE, REPEAT THE ALIGNMENT IN THE SEQUENCE GIVEN.

If any of the above trimmer capacitors cannot be peaked within the $2\frac{1}{2}$ turn limit, set the trimmer to a point $\frac{1}{2}$ turn from maximum capacity and adjust the tuning core of the corresponding ferrite cup-core for a peak.

— CAUTION —

MAKE SURE THAT THE FERRITE TUNING CORES ARE ENGAGED AT LEAST $\frac{1}{4}$ TURN IN THE MATING THREADS. DO NOT TRY TO FORCE TUNING CORES PAST MAXIMUM ROTATION. STOP TURNING THE MOMENT SOME RESISTANCE TO ROTATION IS DETECTED OR THE CORE THREAD WILL BE STRIPPED.

After output peaks are obtained on all six trimmer capacitors, peak the filter preamplifier coil, L-17, by carefully adjusting the tuning core for a maximum S-meter indication. To prevent overloading the IF amplifier, be careful to reduce the signal generator output in order to maintain S-meter indications at approximately one-half scale.

5.5.8.1 FILTER TRACKING

With the PASSBAND TUNE control knob turned fully cw (highest frequency), adjust the sweep drive motor knob to position the signal generator on the peak response. Repeak the six trimmer capacitors C-108, C-104, C-101, C-98, C-95, and C-94 in the order given.

Turn the PASSBAND TUNE control fully ccw (lowest frequency). Readjust the signal generator dial for maximum response and peak the six trimmer capacitors carefully, noting whether each trimmer capacitor requires more or less capacity. If less trimmer capacity is required to obtain a peak or maximum S-meter indication, the tuning range for that particular trimmer capacitor and coil combination is too broad. Conversely, if more trimmer capacity is required to obtain a peak, the tuning range is too narrow.

Return each capacitor which was not properly peaked to its original setting and continue turning it considerably beyond that point to a new trial position. Then repeak the associated coil only by adjusting its tuning core for maximum output or S-meter indication. Repeat this procedure for each trimmer capacitor.

When new trial settings have been made on all the trimmers and inductors which were not peaked properly, return the PASSBAND TUNE control to its full cw (highest frequency) position and repeat the tracking procedure. Only a few trial settings of the trimmer capacitors and inductors should be necessary to attain satisfactory filter tracking. This condition is achieved when none of the six trimmer capacitors needs to be adjusted after checking the peaks with the PASSBAND TUNE control in the full ccw (lowest frequency) position.

5.5.8.2 2.5-kHz FILTER ADJUSTMENT AND TEST

Turn the BANDWIDTH switch to 2.5 kHz. Center the bracketed area (2.5 kHz) of the PASSBAND TUNE control knob on the zero mark of the front panel scale. Turn the mechanical sweep generator sweep speed control to approximately 1 sweep per second and obtain an oscilloscope trace of the filter response. A properly functioning filter will produce a trace similar to that shown in figure 26.

If the trace resembles either figure 27 or figure 28, very carefully adjust C-101 to bring up the lower amplitude filter peaks. Some adjustment of C-94 may also be necessary.

— CAUTION —

DO NOT ADJUST C-108, C-104, C-98, OR C-95.

After shaping the 2.5-kHz filter response, rotate the PASSBAND TUNE control to its full cw (highest frequency) position. Turn the BANDWIDTH switch to the 8.0 kHz position for one or two generator sweeps. Observe the 8.0 kHz passband trace. Then

return the BANDWIDTH switch to the 2.5 kHz position. Observe the filter response as the PASSBAND TUNE control is rotated slowly from its full cw (highest frequency) position towards the mid-range point and onward to its full ccw (lowest frequency) position. The trace should resemble figure 29, which is a composite of several sweeps.

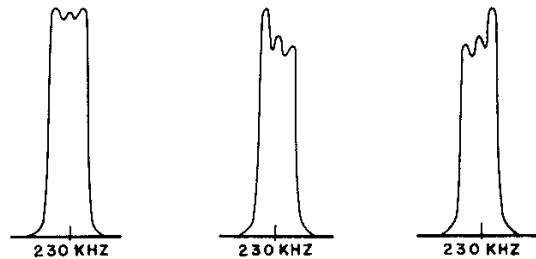
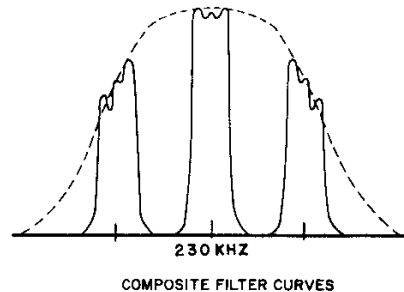

FIG. 26

FIG. 27

FIG. 28



FILTER RESPONSE CURVES AND OSCILLOSCOPE TRACE COMPOSITE

FIG. 29

5.5.8.3 2.5-kHz FILTER ADJUSTMENT AND TEST (ALTERNATE PROCEDURE)

For field alignment, check knob position and align the filter for maximum receiver output with the BANDWIDTH switch in the narrow 0.5 kHz position with the signal generator set as described in paragraph 5.5.8. Set tracking with signal generator as described in paragraph 5.5.8.1. Reset the signal generator to zero beat with the 230-kHz BFO. Check the 2.5 kHz bandwidth by turning AGC ON and advancing the signal generator output for an S-meter indication of 60 db. Slowly turn the PASSBAND TUNE control to cross the 230-kHz signal. S-meter variations should not be over 6 db. If this test condition cannot be met, slightly adjust C-101 and C-94 to minimize passband filter ripple.

This completes the filter alignment. Remove the oscilloscope, mechanical sweep generator, and signal generator connections. Insert the muting transistor, Q-16, into its socket.

5.5.9 TUNABLE IF AND PRELIMINARY VFO ALIGNMENT

Check that all HRO-500 controls are set to the positions indicated in paragraph 5.3. Remove the muting transistor, Q-16. Connect the signal generator to the base of the first mixer transistor, Q-3, through a 0.01- μ f capacitor. Connect the HRO-500TS speaker and audio output meter to the 3.2-ohm and GND terminals of J-10. Turn the FUNCTION switch to the AM position and the BANDWIDTH switch to the 5.0 kHz position.

Turn the MAIN TUNING control until the dial indicates 500. Observe the capacitor rotor plates. They should be approximately 8° from their fully meshed position. To check the 8°, clamp the DIAL LOCK by rotating 90° cw. Then turn the MAIN TUNING control ccw until the dial stops. Unclamp the DIAL LOCK by rotating 90° ccw. Turn the MAIN TUNING dial back to 500. The capacitor rotor plates should now be fully meshed. If not, loosen the setscrews which fasten the split gear to the main tuning shaft and rotate the rotor plates to full mesh. Be sure the anti-backlash portion of the gear has a displacement of approximately one tooth by checking the split gear displacement at the gear springs. Tighten the setscrews with the dial set at 500.

Reset the main tuning clutch to mid-position by the following procedure: Rotate the MAIN TUN-

ING dial to 475. Lock the DIAL LOCK. Rotate the MAIN TUNING dial back to 500. Unlock the DIAL LOCK.

Set the signal generator for 400 hertz, 30 per cent AM modulation. Align the VFO and tunable IF section of the receiver according to the directions given in figure 30.

Repeat Steps 1 through 4 as required to achieve proper alignment of each adjustment at both band ends. After completing the VFO and tunable IF alignment, remove the test equipment connections to the HRO-500 and replace the muting transistor, Q-16.

5.5.10 SYNTHESIZER 4.75-MHz COMPARISON IF ALIGNMENT

To make the required test points accessible for the alignment of the synthesizer IF stage, the synthesizer IF cover must be removed. This may be accomplished by removing the ten screws which attach the cover to the vertical synthesizer sub-chassis.

After removing the synthesizer IF cover, check that all HRO-500 controls are in the positions indicated in paragraph 5.3. Then remove the burst generator and tuned buffer transistors Q-302 and Q-304. Connect the signal generator through a 0.01- μ f capacitor to the base of the synthesizer mixer transistor Q-306.

<i>Step</i>	<i>Signal Generator Frequency</i>	<i>MAIN TUNING Dial</i>	<i>Adjust</i>	<i>Indications and Remarks</i>
1	2.75 MHz	500	L-10	Adjust to place 2.75 MHz in IF passband as indicated by maximum output.
2	2.75 MHz	500	T-9 top and bottom T-8 top and bottom	Adjust for maximum output. Reduce generator input level to maintain S-meter below S-9.
3	3.25 MHz	0	C-68	Adjust to place 3.25 MHz in IF passband as indicated by maximum output.
4	3.25 MHz	0	C-58 C-55 C-51 C-49	Adjust for maximum output. Reduce generator input level to maintain S-meter below S-9.

TUNABLE IF AND PRELIMINARY VFO ALIGNMENT

FIGURE 30

Turn the FUNCTION switch to the SSB or AM position. Tune the signal generator to exactly 4.75 MHz without modulation by comparison to the frequency counter or other calibrating means. Remove the 4.75-MHz crystal X-301. Connect either the VTVM or oscilloscope to the junction of CR-301A, C-368, and R-343.

Advance the signal generator output control until the output is visibly displayed on the oscilloscope or VTVM. Be careful not to saturate the synthesizer IF amplifier. Then adjust the top and bottom tuning cores of transformers T-303, T-302, and T-301 for maximum output in the order given.

Advance the signal generator output control until the output indication reaches a maximum level which indicates saturation of the IF output stage. This saturation output level should be greater than 3 volts P-P or 1.5 volts DC when the signal generator output is set for less than 30,000 microvolts.

After completing the synthesizer IF alignment, remove the signal generator and oscilloscope connections to the HRO-500 receiver. Replace the synthesizer IF cover, the 4.75-MHz crystal X-301, and transistors Q-302 and Q304.

5.5.10.1 SYNTHESIZER IF ALIGNMENT (ALTERNATE PROCEDURE)

In most instances, it may be assumed that the 4.75 MHz crystal is very near the correct frequency. The signal generator frequency may be set by comparison to the 4.75-MHz crystal oscillator. Remove the synthesizer IF cover as described in paragraph 5.5.10. Connect a headphone set to the junction of CR-301A, C-368, and R-343 on the synthesizer IF board. With controls set as in paragraph 5.5.10, tune the signal generator to 4.75 MHz. Adjust the generator for an audible zero beat before removing the crystal X-301. Remove the headphone connection and proceed as in paragraph 5.5.10.

5.5.11 SYNTHESIZER HIGH-FREQUENCY OSCILLATOR AND TUNED BUFFER ALIGNMENT

Check that all HRO-500 controls are set to the positions indicated in Section 5.3. Remove the synthesizer IF cover as described in paragraph 5.5.10. Remove the 4.75-MHz crystal, X-301. Remove the unjunction sweep generator transistor, Q-311, the blocking oscillator transistor, Q-301, and the burst generator transistor, Q-302. Turn the FUNCTION switch to the SSB or AM position. Connect an ex-

ternal 5-volt bias circuit which is shown in figure 31 to the junction of R-346, R-349, CR-300, and L-311. Connect the signal generator through a 10 pf capacitor to the junction of C-345 and C-346 at the synthesizer IF input. Connect the VTVM or oscilloscope to the junction of CR-301A, C-368, and R-343. Set the unmodulated signal generator output for approximately 100,000 microvolts.

Align the synthesizer high-frequency oscillator and the tuned buffer amplifier according to the chart in figure 32. In each step, the signal generator frequency should be accurately set by comparison to the frequency counter or other calibrating means.

— CAUTION —

STEPS 1 AND 2 AND ALL CHECKS ON BAND 5 MUST BE COMPLETED. BEFORE STEPS 3 AND 4, 5 AND 6 ARE ATTEMPTED. THIS IS NECESSARY BECAUSE THE BAND 5 COIL IS ALSO USED ON BANDS 1 AND 2. ADJUSTMENT OF L-308 WILL HAVE A MAJOR EFFECT ON BANDS 1 AND 2, AS WELL AS ON BAND 5.

Repeat each pair of steps as required to insure proper alignment at each end of the band in use.

If difficulty is encountered during the synthesizer high-frequency oscillator alignment, the alternate procedure of paragraph 5.5.11.1 may help determine the cause.

Replace the synthesizer IF cover, crystal X-301, and transistors Q-301, Q-302, and Q-311. Disconnect all test equipment.

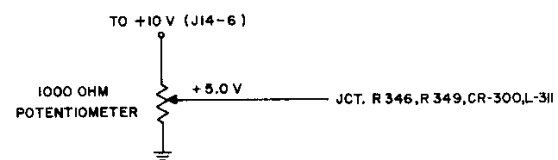

HIGH-FREQUENCY OSCILLATOR ALIGNMENT BIAS

FIGURE 31

5.5.11.1 SYNTHESIZER HIGH-FREQUENCY OSCILLATOR (ALTERNATE ALIGNMENT)

Prepare the HRO-500 for alignment as in paragraph 5.5.11. Do not connect the signal generator or the oscilloscope. Instead, proceed as follows:

<i>Step</i>	<i>Bandswitch</i>	<i>Synthesizer Tune</i>	<i>High-Frequency Oscillator</i>	<i>Signal Generator</i>	<i>Adjust</i>	<i>Indications and Remarks</i>
1	Band 5 20 MHz-30 MHz	20 MHz	23.25 MHz	28.0 MHz	L-308 bottom L-315 bottom	Adjust to place 28.0 MHz in IF passband as indicated by maximum output. Adjust for maximum output. Reduce signal generator output as required to avoid IF saturation.
2	Band 5 20 MHz-30 MHz	29.5 MHz	32.75 MHz	37.5 MHz	C-323 C-375	Adjust to place 37.5-MHz in IF passband as indicated by maximum output. Adjust for maximum output. Reduce signal generator output as required to avoid IF saturation.
3	Band 1 0-1.5 MHz	1.0 MHz	30.25 MHz	35.0 MHz	C-327 C-382	Adjust to place 35.0 MHz in IF passband as indicated by maximum output. Adjust for maximum output. Reduce signal generator output as required to avoid IF saturation.
4	Band 1 0-1.5 MHz	0.0 MHz	29.25 MHz	34.0 MHz	C-328	Adjust to place 34.0 MHz in IF passband as indicated by maximum output.
5	Band 2 1.5-4.0 MHz	3.5 MHz	32.75 MHz	37.5 MHz	C-326 C-380	Adjust to place 37.5 MHz in IF passband as indicated by maximum output. Adjust for maximum output. Reduce signal generator output as required to avoid IF saturation.
6	Band 2 1.5-4.0 MHz	1.5 MHz	30.75 MHz	35.5 MHz	C-329	Adjust to place 35.5 MHz in IF passband as indicated by maximum output.
7	Band 4 10 MHz-20 MHz	10 MHz	13.25 MHz	18 MHz	L-309 L-316	Adjust to place 18 MHz in IF passband as indicated by maximum output. Adjust for maximum output. Reduce signal generator output as required to avoid IF saturation.
8	Band 4 10 MHz-20 MHz	19.5 MHz	22.75 MHz	27.5 MHz	C-324 C-377	Adjust to place 27.5 MHz in IF passband as indicated by maximum output. Adjust for maximum output. Reduce signal generator output as required to avoid IF saturation.
9	Band 3 4.0-10 MHz	4 MHz	7.25 MHz	12 MHz	L-310 L-317	Adjust to place 12 MHz in IF passband as indicated by maximum output. Adjust for maximum output. Reduce signal generator output as required to avoid IF saturation.
10	Band 3 4.0-10 MHz	9.5 MHz	2.75 MHz	17.5 MHz	C-325 C-379	Adjust to place 17.5 MHz in IF passband as indicated by maximum output. Adjust for maximum output. Reduce signal generator output as required to avoid IF saturation.

SYNTHESIZER AND TUNED BUFFER ALIGNMENT

A calibrated general coverage receiver or other detector (such as a grid dip oscillator) covering 7-33 MHz should be lightly coupled to the collector of the tuned buffer transistor, Q-304. Use less than 2 pf of coupling capacity to minimize loading effects. Proceed according to the instructions in figure 32. In each step, tune the detector to the high-frequency oscillator frequency. Then adjust as indicated to place the high-frequency oscillator signal in the external detector passband. Adjust the buffer alignment for maximum amplitude as indicated on the external detector. Disconnect all test equipment and replace synthesizer IF cover, crystal X-301, and transistors Q-301, Q-302, and Q-311.

5.5.12 SYNTHESIZER LOCK CHECKS

Set the FUNCTION switch to the SSB or AM position. Set the BANDSWITCH and SYNTHESIZER TUNE control to the conditions given in Step 1 of figure 32. When these conditions are set up, the synthesizer should lock, as evidenced by the extinguishing of the PHASE LOCK indicator lamp. If the synthesizer does not lock, turn the SYNTHESIZER TUNE control to either side about the indicated dial setting. If the synthesizer still does not lock, refer to the synthesizer spectrum generator test in paragraph 5.5.13 and trouble shoot as required. The waveforms of figures 33 and 34 illustrate typical sweep conditions at the synthesizer 4.75-MHz comparison IF output.

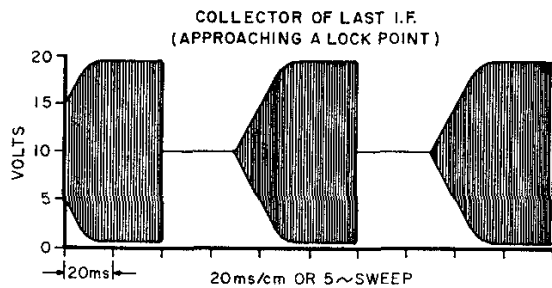

SWEEP WAVEFORM AT COLLECTOR OF LAST IF

FIGURE 33

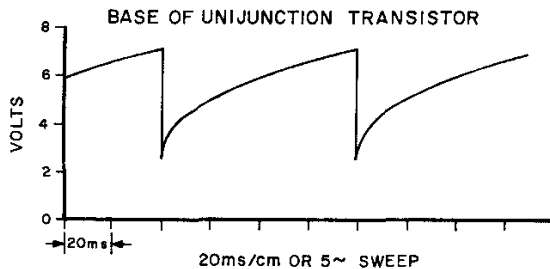

SWEEP WAVEFORM AT BASE OF UNIJUNCTION TRANSISTOR

FIGURE 34

When the synthesizer can be made to lock under the conditions given in Step 1 of the table, check the position of the number in the SYNTHESIZER TUNE dial window as the SYNTHESIZER TUNE control is turned to its unlocked conditions on either side of the proper locked position. Some readjustment of the high-frequency oscillator coil and trimmers may be required to properly center the number in the SYNTHESIZER TUNE window. Be sure to check that the proper HF oscillator frequency has been obtained by checking the frequency of the signal at the high-frequency oscillator frequency given in figure 32. This check may be made by following the instructions of paragraph 5.5.11.1.

Check for locked conditions at the detector frequency given in Step 2 of figure 32. Then check for locked conditions at all synthesizer frequencies between the frequencies given in Steps 1 and 2 by turning the SYNTHESIZER TUNE control to each number in succession. The PHASE LOCK indicator lamp should flash between each lock point and remain extinguished as each number is properly positioned in the SYNTHESIZER TUNE dial window.

Repeat the lock checks as given above for Steps 3 and 4, 5 and 6, 7 and 8, 9 and 10. When each band is set at both ends, check for a locked condition at each frequency within the band. When all lock checks are satisfactory, the synthesizer alignment is complete.

5.5.13 SYNTHESIZER SPECTRUM GENERATOR TEST

The synthesizer spectrum generator section has been carefully aligned and tested at the factory and normally needs no alignment. To insure that the spectrum generator is functioning properly, observe the waveforms by setting the FUNCTION switch to AM or SSB, removing the spectrum generator cover, and connecting the oscilloscope input leads to the test points specified for each waveform shown in figures 21, 22, 23, and 24.

If suitable lock points are not obtained as discussed in paragraph 5.5.12, the free-running frequency of the burst generator should be checked. This may be done by several methods. A general coverage receiver or spectrum analyzer may be coupled lightly to the coaxial output lead from the spectrum generator bandswitch section S301-1R. A signal will be heard at every 500-kHz point on the external receiver or analyzer. The signal of greatest amplitude should occur at or near the required spectrum generator frequency, depending on the setting of the BANDSWITCH and SYNTHESIZER TUNE control. See figure 32 for proper spectrum generator frequencies.

A different check may be made without external equipment by choosing a SYNTHESIZER TUNE frequency near the center of the BANDSWITCH range in use. Loosen the setscrews on the pulley of the spectrum generator tuning capacitor, C-373. Slowly rotate the spectrum generator tuning capacitor in either direction from the point at which it was set and observe whether a lock is obtained. If the synthesizer is already locked, the synthesizer should fall out of lock as the capacitor is rotated to either side of the set point. This check may be repeated at all band centers and band ends to check spectrum generator tracking.

This check may be made with greater accuracy by removing the synthesizer IF cover according to the directions in paragraph 5.5.10. Connect the VTVM or oscilloscope to the junction of CR-301A, C-368, and R-343. Note the IF output amplitude indicated by the VTVM or oscilloscope before loosening the setscrews on the pulley of the spectrum generator tuning capacitor. Then rotate the capacitor in either direction from the point at which it was set. Maximum synthesizer IF output should be obtained at or near the set point.

Rotate the SYNTHESIZER TUNE control to its full ccw travel. Observe that the synthesizer tuning capacitor, C-332, is fully meshed. Fully mesh the spectrum generator tuning capacitor, C-373, and tighten all setscrews. Remove the test equipment and replace all covers.

5.5.14 26-MHz OSCILLATOR CHECK

Check that all HRO-500 controls are set to the positions indicated in paragraph 5.3. Turn the FUNCTION switch to the SSB or AM position and the BANDSWITCH to the 0-1.5 MHz position (Band 1). Connect the oscilloscope to the 26-MHz buffer output at the junction of L-7, C-31, C-32, and C-44. Adjust the tuning core of the 26-MHz oscillator coil L-19 for maximum output. Turn the FUNCTION switch to OFF, then back to the AM position. Check for reliable starting of the oscillator. Finally, adjust C-44 for maximum output from the buffer.

5.5.15 UP-CONVERTER PASSBAND ALIGNMENT

Set all HRO-500 controls to the positions indicated in paragraph 5.3. Set the FUNCTION switch in the SSB or AM position and the BANDSWITCH in the 0-1.5 MHz position. Remove the 26-MHz crystal X-1 and short the collector of the synthesizer high-frequency oscillator Q-303 to ground. Connect the sweep generator to the junction of R-10 and C-193. Connect an oscilloscope to the junction of C-74 and the bandswitch section S-3R. Lightly couple the signal generator to C-74 for a frequency marker signal. Set the marker signal generator for frequencies

between 26 MHz and 30 MHz and the output to 100,000 microvolts without modulation.

Connect the sweep signal from the sweep generator to the oscilloscope horizontal amplifier and obtain an oscilloscope presentation of the response of transformer T-6. Then adjust the top and bottom tuning cores of T-6 for an oscilloscope waveform as shown in figure 35. Check the critical points of the response curve with the signal generator marker.

Turn the BANDSWITCH to the 1.5-4.0 MHz position. Connect the sweep generator to the junction of C-33 and L-5. The other connections will remain as given above. Obtain an oscilloscope presentation of the response of transformer T-7. Adjust the top and bottom tuning cores of T-7 for a response curve as shown in figure 36. Check the critical points of the response curve with the marker generator.

Disconnect the marker generator, sweep generator, and oscilloscope leads: Insert the 26-MHz crystal X-1 into its socket and remove the short from the collector of the high-frequency oscillator transistor Q-303.

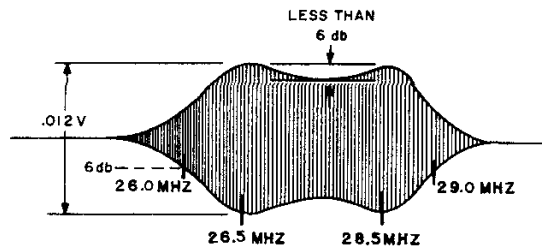

RESPONSE: BANDPASS TRANSFORMER T-6

FIGURE 35

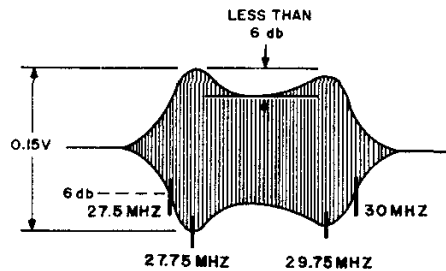

RESPONSE: BANDPASS TRANSFORMER T-7

FIGURE 36

5.5.15.1 UP-CONVERTER PASSBAND ALIGNMENT (ALTERNATE PROCEDURE)

If no sweep generator is available, the up-conversion bandpass transformers T-6 and T-7 may be aligned with only a signal generator and a general coverage receiver by performing the alternate alignment procedure described below.

To align the 0-1.5 MHz up-conversion bandpass transformer T-6, check to be sure that the FUNCTION switch is in the SSB or AM position and the BANDSWITCH is in the 0-1.5 MHz position. Remove the 26-MHz crystal X-1 and short the collector of the high-frequency oscillator Q-303 to ground. Connect the signal generator, tuned to 27 MHz, to the junction of R-10 and C-193. Connect a general coverage receiver, tuned to 27 MHz, through a coaxial cable to the junction of C-74 and bandswitch section S1-3R. All leads should be short and well shielded to minimize stray coupling effects around transformer T-6. Shunt the secondary of T-6 with a 100-ohm resistor across C-34. Peak the primary of T-6 (bottom tuning core) for maximum output on the receiver.

Remove the 100-ohm resistor from the secondary of T-6 and shunt the primary of T-6 with a 100-ohm resistor across C-35. Peak the secondary of T-6 (top tuning core) for maximum output. Disconnect the 100-ohm resistor.

To align the 1.5-4.0 MHz up-conversion bandpass transformer T-7, turn the BANDSWITCH to the 1.5-4.0 MHz position. Connect the signal generator tuned to 28.75 MHz, to the junction of C-33 and L-5. Tune the general coverage receiver to 28.75 MHz. Shunt the secondary of T-7 with the 100-ohm resistor across C-37. Peak the primary of T-7 (bottom tuning core) for maximum output.

Remove the shunt resistor from the secondary of T-7 and shunt the primary of T-7 with a 100-ohm resistor across C-36. Peak the secondary of T-7 (top core) for maximum output on the receiver.

On completion of the alternate up-converter passband alignment procedure, disconnect the 100-ohm shunt resistor and all test equipment. Remove the short from the collector of the high-frequency oscillator transistor Q-303 and insert the 26-MHz crystal X-1 into its socket.

5.5.16 PRESELECTOR ALIGNMENT

Set the HRO-500 controls as indicated in paragraph 5.3. Set the FUNCTION switch to AM, MAIN TUNING dial as indicated, BANDWIDTH switch to 5 kHz, AGC to ON, and AUDIO GAIN control as required. Connect the signal generator to the 50-ohm antenna connector J-1. Match the signal generator output properly to present a 50-ohm resistive source to the receiver antenna terminal. Set the signal generator for 400 hertz, 30 per cent AM

modulation at the frequencies indicated. Connect the HRO-500TS speaker and audio output meter to the 3.2-ohm and GND terminals of J-10. Then align the preselector according to figure 37.

After completion of preselector alignment, remove all test equipment from the HRO-500.

5.5.17 S-METER CALIBRATION AND AGC TEST

Set all HRO-500 controls to the positions indicated in paragraph 5.3. Turn the BANDWIDTH switch to the 1.5-4.0 MHz position. Set the SYNTHESIZER TUNE dial to 3.5 MHz. Turn the FUNCTION switch to SSB and the AGC THRESHOLD control to ON. Connect a properly terminated, unmodulated signal generator to the 50-ohm antenna connector J-1 on the rear apron of the receiver. Set the signal generator frequency to approximately 4 MHz and the output to 50 μ v. Tune in the signal generator with the MAIN TUNING dial and carefully maximize the output with the PRESELECTOR TUNE control. Note the S-meter indication. If the S-meter does not indicate S-9 or 40 db, adjust the S-meter calibration control, C-156, for the correct indication.

To check the AGC release time, turn the AGC THRESHOLD control to OFF. The S-meter should indicate full scale. Turn the AGC THRESHOLD control to ON. The S-meter indication should return to S-9 in approximately 1 second. If the S-9 indication is obtained in less than 1 second, the AGC circuit requires troubleshooting.

Set the signal generator attenuator control for a 50,000 μ v output. The S-meter should indicate approximately 80 db. If the S-meter pointer is below 70 db or against the full-scale stop, the AGC circuit is not functioning properly and requires troubleshooting.

5.5.18 FINAL FREQUENCY CALIBRATION: SYNTHESIZER

Turn all controls to the positions indicated in paragraph 5.3. Turn the FUNCTION switch to AM or SSB. Couple the frequency counter to the collector of the 500-kHz blocking oscillator transistor Q-301 through a 10-pf coupling capacitor. Observe the counter frequency indication, and adjust C-301 for an indication of exactly 500 kHz. Remove the counter connections.

Remove the synthesizer IF amplifier cover. Couple the frequency counter to the junction of CR-301A, C-368, and R-343 through a 10-pf coupling capacitor. Observe the counter frequency indication, and if necessary, adjust C-366 for an indication of exactly 4.750 MHz. Remove the counter connections and replace the synthesizer IF cover.

<i>Band</i>	<i>Synthesizer Tune</i>	<i>Main Tuning</i>	<i>Preselector Tuning</i>	<i>Signal Generator</i>	<i>Adjust</i>	<i>Indications and Remarks</i>
0.0-1.5 MHz Band 1	0.5 MHz	10	510 kHz	510 kHz	L-4 T-3 bottom T-3 top	Adjust for maximum output. Reduce signal generator input as required to avoid overload. The S-meter may be used as an overload - indicator. Maintain the S-meter at or below mid-scale. Repeat the adjustments at each end of a band as required to achieve proper tracking.
0.0-1.5 MHz Band 1	1.0 MHz	490	1490 kHz	1490 kHz	C-25 C-13 C-12	
1.5-4.0 MHz Band 2	1.5 MHz	250	1.75 MHz	1.75 MHz	L-5 T-4 bottom T-4 top	
1.5-4.0 MHz Band 2	3.5 MHz	250	3.75 MHz	3.75 MHz	C-26 C-15 C-14	
4.0-10 MHz Band 3	4.0 MHz	250	4.25 MHz	4.25 MHz	L-6 T-5 bottom T-5 top	
4.0-10 MHz Band 3	9.5 MHz	250	9.75 MHz	9.75 MHz	C-27 C-17 C-16	
10-20 MHz Band 4	10.0 MHz	250	10.25 MHz	10.25 MHz	L-2 T-1 bottom T-1 top	
10-20 MHz Band 4	19.5 MHz	250	19.75 MHz	19.75 MHz	C-23 C-9 C-8	
20-30 MHz Band 5	20.0 MHz	250	20.25 MHz	20.25 MHz	L-3 T-2 bottom T-2 top	
20-30 MHz Band 5	29.5 MHz	250	29.75 MHz	29.75 MHz	C-24 C-11 C-10	

PRESELECTOR ALIGNMENT

FIGURE 37

5.5.18.1 FINAL FREQUENCY CALIBRATION: SYNTHESIZER (ALTERNATE PROCEDURE)

Set the HRO-500 controls to the positions indicated in paragraph 5.3. Connect a suitable antenna or accurately known frequency standard to the 50-ohm antenna connector J-1. Connect the HRO-500TS speaker to the 3.2-ohm and GND terminals of J-10. Turn the FUNCTION switch to AM. Adjust the SYNTHESIZER, MAIN TUNING, and PRESELECTOR TUNE controls to receive WWV at 15, 10, or 5 MHz, or an alternate frequency standard. If the frequency standard is used, set the SYNTHESIZER TUNE, PRESELECTOR TUNE, and MAIN TUNING controls to receive the highest frequency signal or harmonic available within the receiver range. Turn the RF GAIN control fully cw and set the AUDIO GAIN control as desired to receive the WWV or frequency standard signal.

Lightly couple the HRO-500 spectrum generator to the receiver input terminals by wrapping an insulated wire which is connected to the HI-Z antenna connector J-2 around the burst generator transistor Q-302. A beat note between the harmonic from the spectrum generator and the WWV or frequency standard should be heard. Adjust the

500-kHz crystal trimmer C-301 to bring this beat note to zero beat.

Tune the MAIN TUNING control to place the WWV carrier or frequency standard signal on one side of the IF passband to permit slope detection. Any images of the spectrum generator signal will show up as FM on the high-frequency oscillator DC control circuit. Correct adjustment of the 4.75-MHz oscillator signal will bring these images into zero beat with the desired harmonic of the spectrum generator. Adjust the 4.75-MHz oscillator trimmer C-366 to zero beat this slope-detected FM response. Then repeat the 500-kHz trimmer adjustment C-301 as given in the paragraph above. This completes the synthesizer calibration. Remove the spectrum generator coupling lead and test connections.

5.5.19 50-kHz CALIBRATOR ADJUSTMENT

Turn all controls to the positions indicated in paragraph 5.3. Turn the FUNCTION switch to CAL and couple the frequency counter to the junction of R-48, R-47, and the base of the 50-kHz calibrator transistor Q-10. Observe the counter frequency indication, and if necessary, adjust C-125 to obtain an indication of exactly 50 kHz. Remove the frequency counter connections.

5.5.19.1 50-kHz CALIBRATOR ADJUSTMENT (ALTERNATE PROCEDURE)

Check the synthesizer calibration as given in paragraph 5.5.18 above. The 50-kHz calibrator adjustment described as follows depends on an accurately calibrated synthesizer. Set all controls as indicated in paragraph 5.3 and connect the HRO-500TS speaker to the 3.2-ohm and GND terminals at J-10. Turn the FUNCTION switch to SSB and set the MAIN TUNING dial to zero beat a signal from WWV or a frequency standard signal against the BFO. Then turn the FUNCTION switch to the CAL position which activates the 50-kHz calibrator. Adjust the calibrator trimmer C-125 for zero beat with the WWV and BFO signals. This completes the 50-kHz calibrator adjustment. However, the MAIN TUNING dial may be accurately calibrated at this dial setting in the following manner: Turn the DIAL LOCK knob 90° cw to the locked position. Adjust the MAIN TUNING control for a MAIN TUNING dial indication of zero or 500, depending upon the synthesizer frequency chosen to receive the WWV or frequency standard signal. Then return the DIAL LOCK knob to its unlocked position by rotating it 90° ccw.

5.5.20 26-MHz OSCILLATOR CALIBRATION

Turn all controls to the positions given in paragraph 5.3. Turn the BANDSWITCH to the 0-1.5 MHz position. Set the FUNCTION switch to AM or SSB. Connect a counter capable of indicating frequencies up to 30 MHz to the 26-MHz oscillator output J-4 on the rear apron. Observe the counter frequency indication, and if necessary, adjust L-19 to obtain an indication of exactly 26.000 MHz. Remove the counter connections.

5.5.20.1 26-MHz OSCILLATOR CALIBRATION (ALTERNATE PROCEDURE)

Check the synthesizer calibration as given in paragraph 5.5.18 above. Set all controls as indicated in paragraph 5.3. Connect the HRO-500TS speaker to the 3.2-ohm and GND terminals of J-10. Set the BANDSWITCH to the 0-1.5 MHz position. Turn the FUNCTION switch to the CAL position. Tune a signal from a frequency standard or a signal from a broadcast station whose frequency is known to be an even multiple of 50 kHz. Adjust the 26-MHz oscillator coil L-19 for zero beat between the broadcast or frequency standard signal and the combined BFO and 50-kHz calibrator signals.

This completes the 26-MHz oscillator adjustments. Remove the antenna or frequency standard signal from the 50-ohm antenna connector J-1.

5.5.21 230-kHz BFO CRYSTAL OSCILLATOR (ALTERNATE PROCEDURE)

The 230-kHz BFO crystal was set in paragraph 5.5.3. If desired, it may be rechecked as follows:

Turn all controls to the positions given in paragraph 5.3. Turn the FUNCTION switch to the SSB position. Connect the counter to the BFO output jack J-6 on the rear apron of the receiver. Observe the counter frequency indication. If necessary, adjust L-24 to obtain an indication of exactly 230 kHz. Remove the counter connections.

5.5.22 VFO FREQUENCY ADJUSTMENTS

Check that all HRO-500 controls are set to the positions indicated in paragraph 5.3. Connect the HRO-500TS speaker to the 3.2-ohm and GND connections of J-10. Set the main tuning clutch to mid-position following the procedure in paragraph 5.5.9. Turn the FUNCTION switch to the CAL position. Set the MAIN TUNING control to indicate 500 on the MAIN TUNING dial. Adjust the VFO inductance tuning core L-10 for zero beat with the 50-kHz calibrator signal.

Set the MAIN TUNING dial to zero. Adjust the VFO trimmer capacitor C-68 for zero beat. Repeat the above steps several times as required to insure that both end frequencies are correct.

5.5.23 VFO LINEARITY ADJUSTMENT

A special linearity adjustment (consisting of two segmented plates and a stator) is incorporated on the rear section of the HRO-500 main tuning capacitor. After adjustment of the VFO frequency at 2.98 MHz and 3.48 MHz as described in paragraph 5.5.22, it will be necessary to set the VFO linearity.

Set all controls as indicated in paragraph 5.3. Set the FUNCTION switch to CAL. Connect the HRO-500TS speaker to the 3.2-ohm and GND terminals of J-10. Turn the MAIN TUNING control to approximately 450. Zero beat with the 50-kHz calibrator signal should occur at exactly 450 to within $\pm\frac{1}{4}$ dial division (± 250 hertz). If the dial indication is outside these limits, set the dial to exactly 450. Then carefully "knife" (bend) the proper frequency correction plate segment at the end of the main tuning capacitor to obtain zero beat. A long screwdriver may be used to knife these plates or a special alignment tool may be fashioned if desired.

If zero beat occurs at a dial indication below 450, the plate segments will have to be moved away from the stator. If zero beat occurs above 450, the plate segments should be moved toward the stator.

Repeat the above procedure at each multiple of 50 kHz. As these frequency correction segments are knifed, be sure that they form a smooth curved line. This will minimize the run-out between the 50-kHz calibration points.

If an accurate frequency standard having 20 or 25 kHz harmonics is available, these harmonics may be injected into the receiver through the 50-ohm antenna connector J-1. These harmonics may be

checked against proper VFO dial indications to insure maximum dial calibration accuracy over the entire MAIN TUNING dial scale.

5.5.24 VFO TEMPERATURE COMPENSATION

The VFO temperature compensation capacitor C-200 has been carefully set at the factory and normally needs no readjustment. If VFO components have been replaced, it may be necessary to readjust the temperature compensation capacitor. The VFO frequency and linearity adjustment procedures should be performed prior to this procedure. Connect a suitable antenna or accurate frequency standard to the receiver antenna connector J-1. Connect the HRO-500TS speaker to the 3.2-ohm and GND connections of J-10. Tune to WWV or the frequency standard harmonic with the FUNCTION switch set to SSB. Carefully zero beat this signal against the BFO. Then raise or lower the ambient temperature around the receiver approximately 30°F. After one half hour or longer, note the change in the beat note and the direction of tuning necessary to return to zero beat. If this direction is up-scale (toward zero), increase the setting of the temperature compensating trimmer (C-200) by turning it towards its maximum capacity setting. If the direction is down-scale (toward 500), decrease the setting of C-200. Reset the MAIN TUNING control to the correct MAIN TUNING dial indication and reset the VFO trimmer C-68 to zero beat to re-establish proper calibration.

Repeat the above procedure until the receiver is satisfactorily temperature compensated. If necessary, VFO end frequency adjustments and linearity adjustments should be repeated according to the instructions in paragraphs 5.5.21 and 5.5.22.

5.6 TROUBLESHOOTING:

This section contains general information about transistors and their basic characteristics to aid service personnel in isolating circuit malfunctions and repairing the receiver transistor circuits. Typical transistor characteristics, NPN and PNP transistor basic circuit connections, and base diagrams are

included. Specific service information, including a transistor voltage chart, a power supply distribution table, and general troubleshooting procedures are also included.

5.6.1 GENERAL TROUBLESHOOTING PROCEDURE

1. Determine the malfunctioning section or stages in the receiver by observation, signal injection, or other well-known servicing techniques.

2. Check the transistor voltages in the malfunctioning stage area. Typical transistor voltages for PNP and NPN transistors are shown in the following chart. For detailed voltages see section 5.6.5.

3. Apply a signal to the malfunctioning area. Check its alignment and the individual stage outputs. This should localize the trouble to a few components. These components may be replaced to correct the malfunction.

PNP	
Typical emitter-to-supply voltage	1 V
Typical base-to-supply voltage	0.2 V above emitter-to-supply voltage
Typical collector-to-ground voltage	0 V
NPN	
Typical emitter-to-ground voltage	1 V
Typical base-to-ground voltage	0.3 V above emitter-to-ground voltage
Typical collector-to-ground voltage	approximately equal to supply

5.6.2 TYPICAL TRANSISTOR CHARACTERISTICS AND PARAMETERS

<i>Symbols</i>	<i>Characteristic</i>	<i>Small Signal Transistors</i>	<i>Power Transistors</i>
Z in (base)	Input impedance	500 Ω	100 Ω
Z out (collector)	Output impedance	100 K Ω	10 K Ω
Z load	Stable load impedance	5 K Ω	50 Ω
Power gain	Single-stage power gain	20-30 db	20-30 db
Beta	DC current gain (Beta)	30-150	60-100

5.6.3 ~~BASE DIAGRAMS AND~~
MISCELLANEOUS INFORMATION

Base diagrams of 3-terminal small signal transistors are illustrated in figure 38.

Base diagrams of 4-terminal small signal transistors are illustrated in figure 39.

Base diagrams of power transistors or TO-3 case are illustrated in figure 40.

The basic bias network for PNP transistors is shown in figure 41.

The basic network for NPN transistors is shown in figure 42.

Drive cord diagrams are shown in figures 43 and 44.

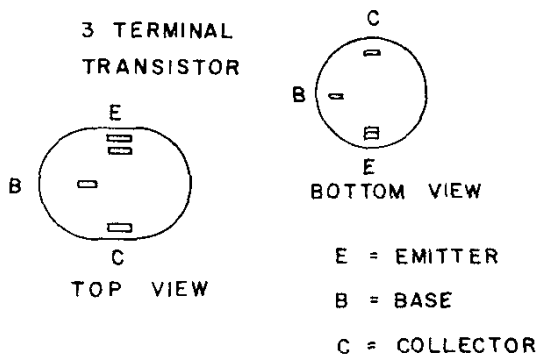

3-TERMINAL TRANSISTOR SOCKET
(BOTTOM VIEW)

FIGURE 38

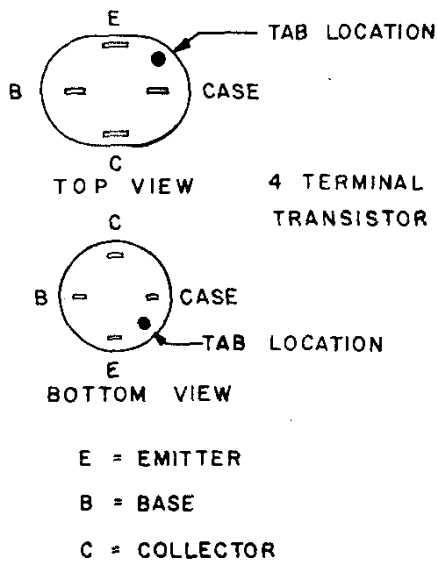

4-TERMINAL TRANSISTOR SOCKET
(BOTTOM VIEW)

FIGURE 39

TO-3 CASE POWER TRANSISTOR

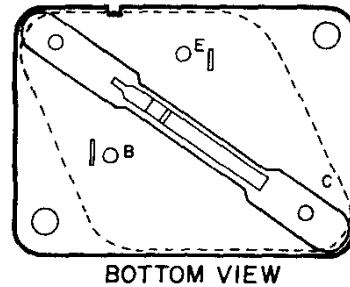
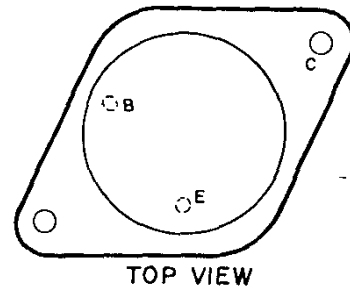

E = EMITTER
B = BASE
C = COLLECTOR

TO-3 CASE POWER TRANSISTOR SOCKET
(BOTTOM VIEW)
FIGURE 40

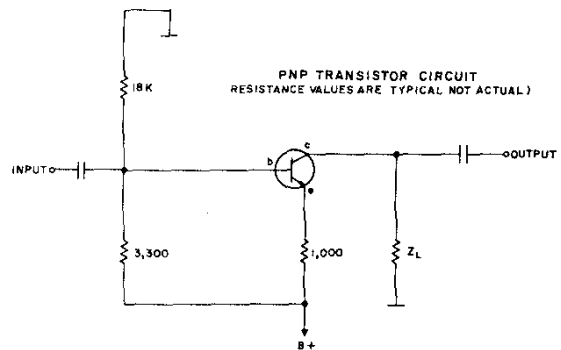

PNP TRANSISTOR BIAS CIRCUIT
FIGURE 41

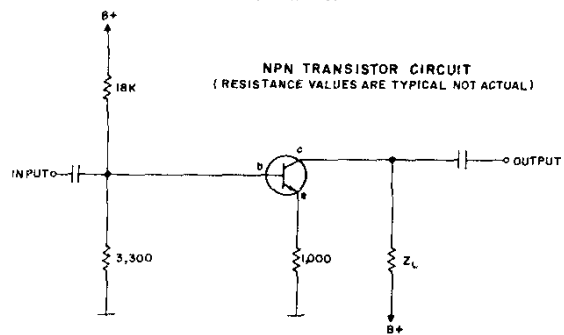

NPN TRANSISTOR BIAS CIRCUIT
FIGURE 42

5.6.4 RECEIVER POWER SUPPLY VOLTAGE DISTRIBUTION TABLE

The following DC voltage measurements are taken with a VTVM or a VOM with an input resistance of at least 20,000 ohms per volt. Receiver controls are set as follows:

SYNTHESIZER TUNE: 3.5 MHz
 PRESELECTOR TUNE: 3.5 MHz
 RF GAIN: Full cw (clockwise)
 AF GAIN: Full ccw (counterclockwise)
 BANDWIDTH switch: 8 kHz
 AGC THRESHOLD: OFF
 FUNCTION switch: CAL
 DIAL lamp switch: ON
 BANDWIDTH switch: 8 kHz
 REJECTION TUNE: OFF

— CAUTION —

DO NOT ATTEMPT TO MEASURE CIRCUIT RESISTANCES WITH AN OHMMETER. SEVERAL COMMERCIAL OHMMETERS DEVELOP LARGE POTENTIALS ACROSS THE OHMMETER LEADS WHICH ARE CAPABLE OF DESTROYING TRANSISTORS. IT IS STRONGLY RECOMMENDED THAT ALL TROUBLESHOOTING BE BASED ONLY ON THE TRANSISTOR TERMINAL VOLTAGE CHART GIVEN BELOW.

Transistor	Function	Voltage		
		Emitter	Base	Collector
Q-1	RF Amplifier	0.86	1.6	11.2
Q-2	26-MHz Oscillator	6.1	5.9	0
Q-3	First Conversion Mixer	0.42	0.9	7.5
Q-4	26-MHz Buffer	8.8	8.7	0
Q-5	Tunable IF	8.8	8.6	0
Q-6	Second Conversion Mixer	8.7	8.4	0
Q-7	VFO	4.1	4.3	0.29
Q-8	VFO Buffer	3.1	3.3	0.33
Q-9	Filter Preamplifier	8.6	8.3	0
Q-10	Crystal Calibrator	6.6	6.9	0
Q-11	AGC Emitter Follower	6.3	6.0	1.4
Q-12	First 230-kHz IF	8.5	8.3	1.8
Q-13	Second 230-kHz IF	8.9	8.6	0
Q-14	Third 230-kHz IF	8.9	8.7	0.84
Q-15	BFO	7.0	6.8	0
Q-16	Muting	9.8	11.8	GND
Q-17	Bi-stable Trigger	12.0	11.9	0
Q-18	Bi-stable Trigger	0	0	11.8
Q-19	Emitter Follower	5.2	4.8	GND
Q-20	Audio Output	11.8	11.7	0
Q-21	Audio Output	11.8	11.7	0
Q-22	Audio Driver	6.8	6.6	1.4
Q-23	S-meter Bridge Amplifier	0.1	0.73	9.5
Q-24	S-meter Detector	0.69	1.18	10.0
Q-25	Regulator	GND	-0.15	-12.4
Q-300	500-kHz Oscillator	4.25	4.5	0.6
Q-301	Blocking Oscillator	GND	-0.68	8.6
Q-302	Burst Generator	GND	-0.1	0.89
Q-303	HFO	3.7	3.85	0.45
Q-304	Tuned Buffer	6.4	6.2	0.52
Q-305	Untuned Buffer	6.1	5.8	1.4
Q-306	Mixer	8.9	8.7	0.12
Q-307	4.75-MHz IF	8.4	8.2	0.11
Q-308	4.75-MHz IF	9.0	8.8	1.3
Q-309	4.75-MHz Oscillator	6.4	6.4	1.26
Q-310	DC Amplifier	0.15	0.78	5.8
Q-311	Unijunction Sweep	9.3	5.9	GND

5.6.5 PILOT LIGHT REPLACEMENT

5.6.5.1* DRUM DIAL AND OR DIAL INDEX PILOT LIGHTS

To replace the drum dial and or dial index pilot lights, the mask and drum dial mechanically coupled to the SYNTHESIZER TUNE control must be removed.

Remove the mask by removing the screws which attach the mask to the hubs at each end of the mask.

The mask may now be removed by lifting it out through the front panel slot.

Loosen the set screws which attach the mask hub and drum to the gear box and remove the two screws which attach the assembly to the notch tuning capacitor bracket. Now remove the drum dial by sliding it to the right and then lifting it out through the slot at the top of the panel. The dial index and drum pilot lights are now accessible.

Replace the defective pilot lamp. After replacing the dial index and or drum dial pilot lamps, replace

the synthesizer drum dial, the drum support and pilot lamp holder assembly, and the mask.

After replacing, align the drum dial first by turning the SYNTHESIZER TUNE control ccw to its maximum capacity position with the BANDSWITCH in the 0-1.5 MHz position. Align the white horizontal line on the synthesizer drum dial with the center of the window. Then position the mask so that the white line appears through the rectangular opening in the mask which is nearest the gear box.

5.6.5.2 DIAL INDEX PILOT LAMP

To replace the pilot lamp in the front panel dial index, the mask and drum dial mechanically coupled to the SYNTHESIZER TUNE control must be removed. This may be accomplished by first removing the right side gusset, filter cover, S-meter, the synthesizer drum support, and pilot lamp assembly as described in paragraph 5.6.7.1 above, and then removing the mask and drum dial as follows.

Remove the mask by removing the screws which attach the mask to the rectangular pivot blocks at each end of the mask. Loosen the setscrew on the left pivot block and rotate the mask to clear the

drum. The mask may now be removed by lifting it out through the front panel slot.

Remove the drum dial by loosening the setscrews which attach the drum to the gear box, sliding it to the right, and then lifting it out through the slot at the top edge of the front panel. The dial index pilot lamp holder is now accessible.

Replace the defective pilot lamp. After replacing the dial index pilot lamp, replace the synthesizer drum dial, the drum support and pilot lamp assembly and the mask.

After replacing, align the drum dial first by turning the SYNTHESIZER TUNE control ccw to its maximum capacity position with the BANDSWITCH in the 0-1.5 MHz position. Align the white horizontal line on the synthesizer drum dial with the center of the window. Then position the mask so that the white line appears through the rectangular opening in the mask which is nearest the gear box.

After aligning the drum dial and mask, replace the S-meter, filter cover and right side gusset.

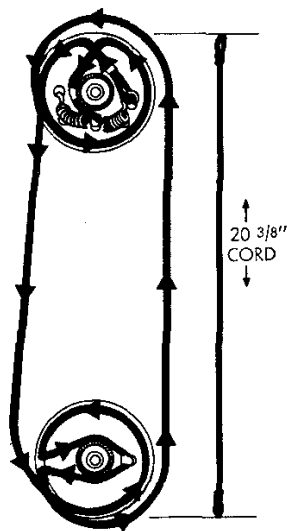

SYNTHESIZER TUNE
DRIVE CORD
DRIVE PULLEYS SHOWN AT MAXIMUM
COUNTERCLOCKWISE ROTATION

DRIVE CORD—SYNTHESIZER TUNE

FIGURE 43

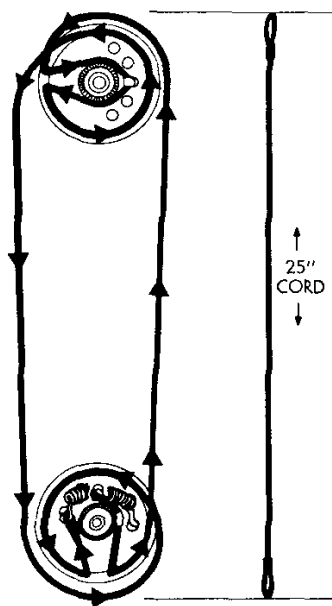

SYNTHESIZER BANDSWITCH
DRIVE CORD
DRIVE PULLEYS SHOWN AT MAXIMUM
COUNTERCLOCKWISE ROTATION

DRIVE CORD—SYNTHESIZER BANDSWITCH

FIGURE 44

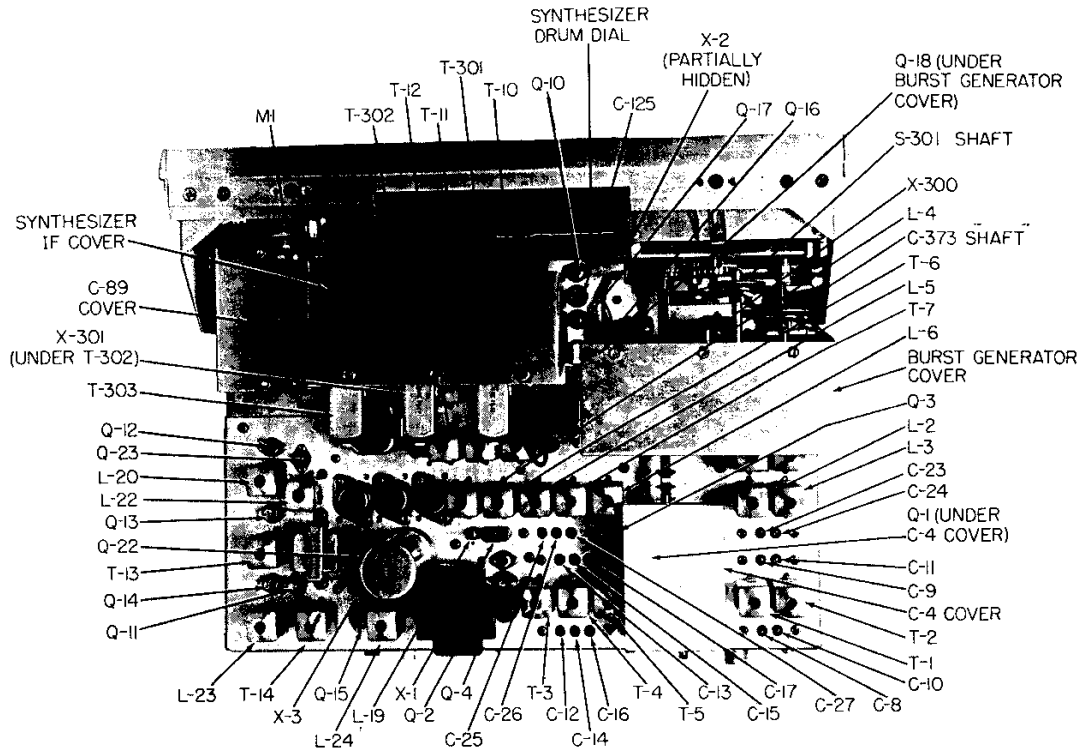

HRO-500 RECEIVER CHASSIS, TOP VIEW

FIGURE 45

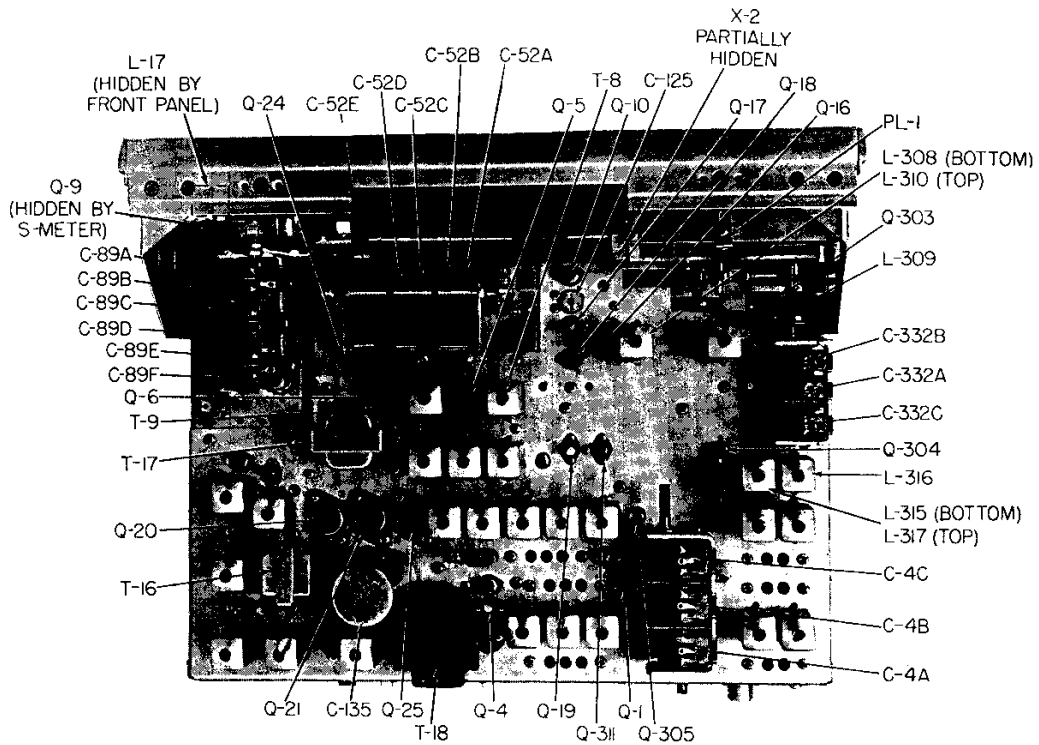

HRO-500 RECEIVER CHASSIS, WITH SYNTHESIZER AND COVERS REMOVED, TOP VIEW

FIGURE 46

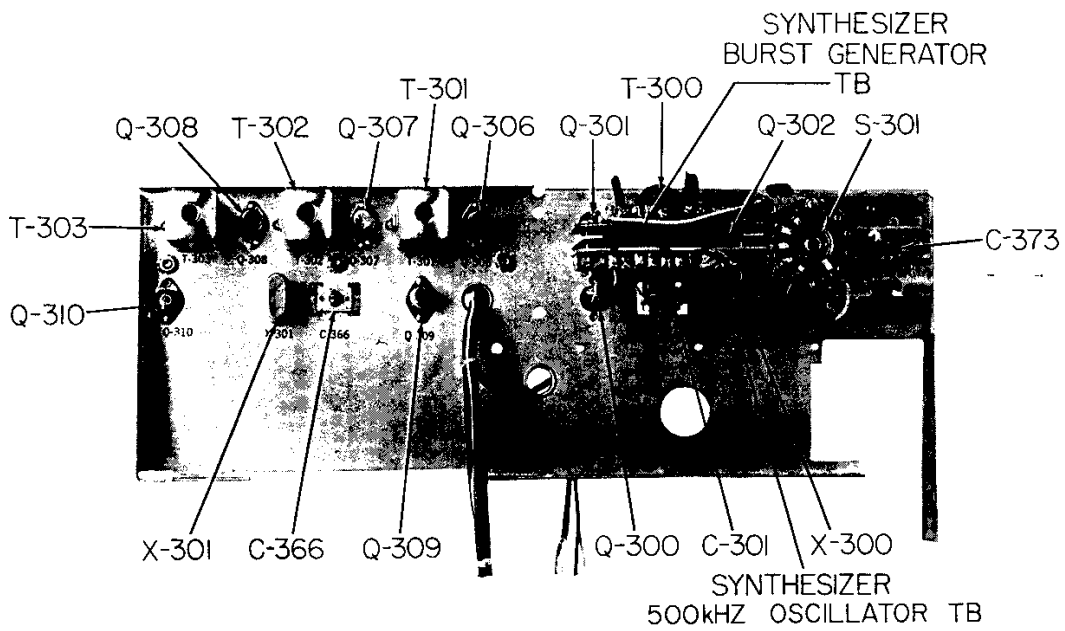

SYNTHESIZER CHASSIS, REAR VIEW

FIGURE 47

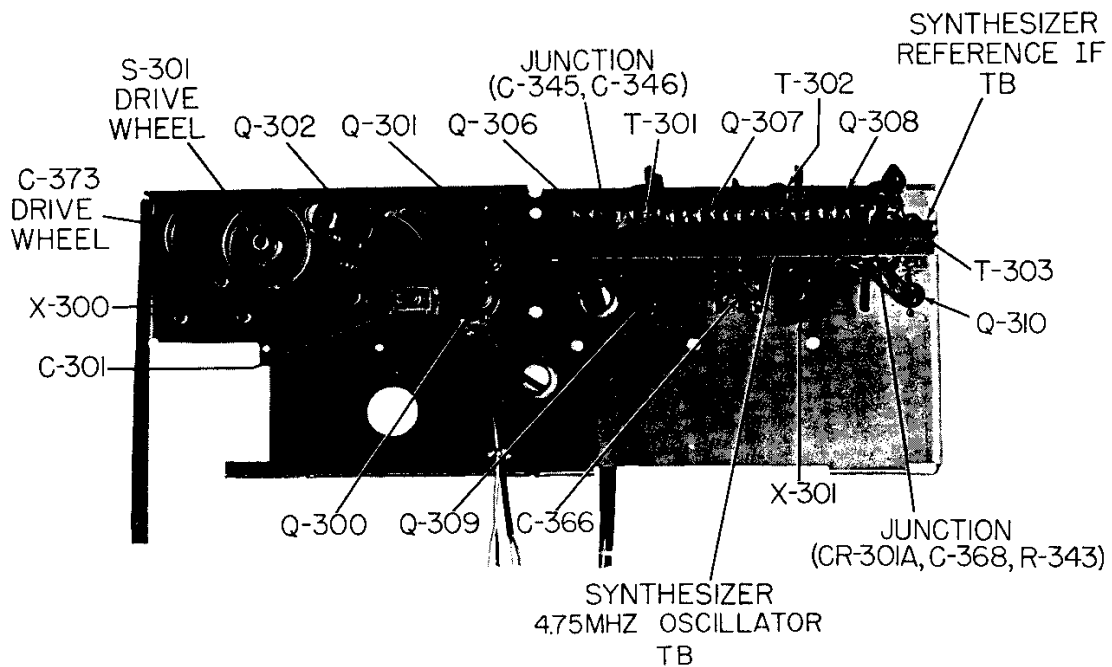

SYNTHESIZER CHASSIS, FRONT VIEW

FIGURE 48

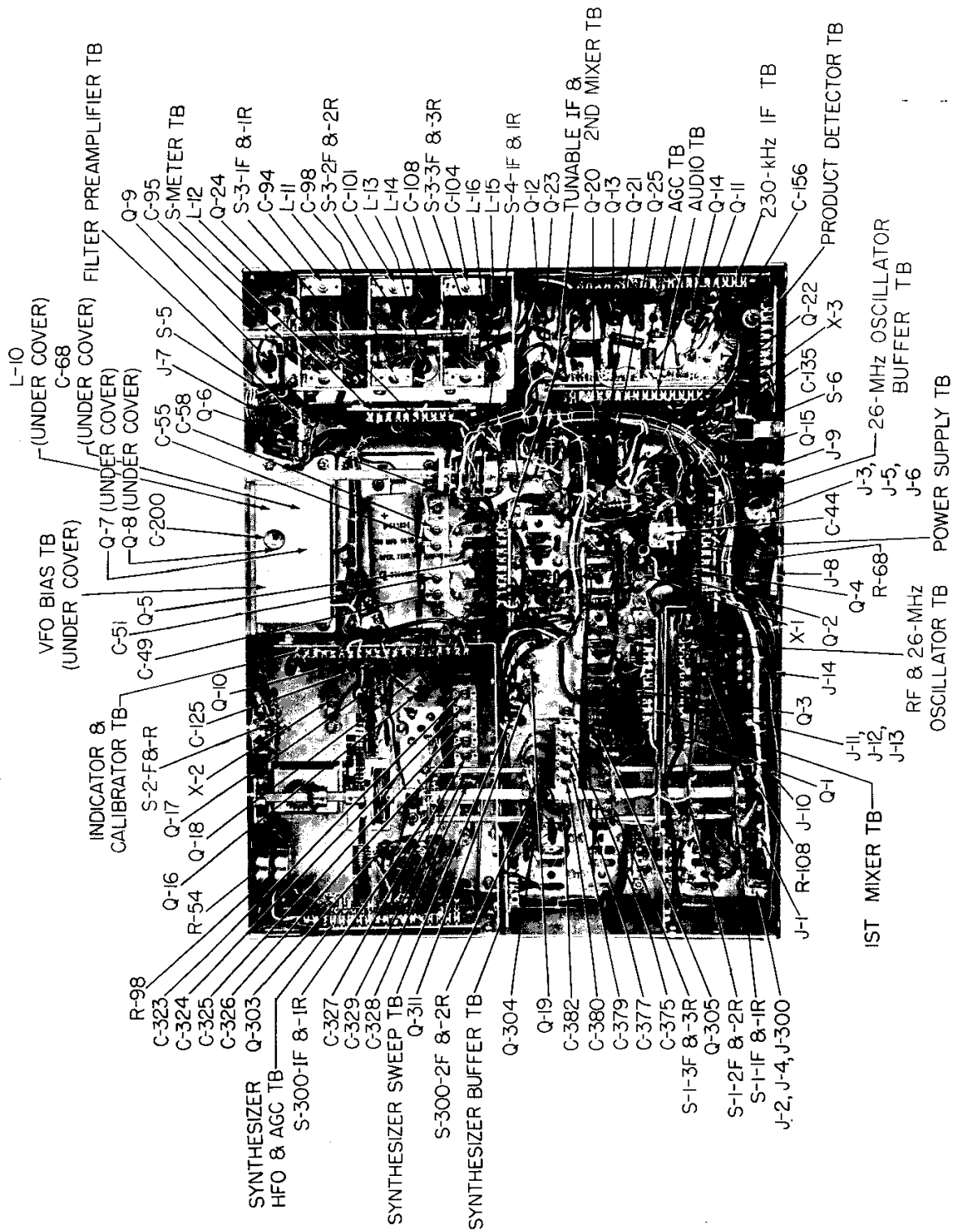

HRO-500 RECEIVER CHASSIS, BOTTOM VIEW
 FIGURE 49

SECTION 6

HRO-500 SPECIFICATIONS

FREQUENCY RANGE: Five kilohertz to 30 MHz in sixty 500 kHz bands, continuous coverage.
MODES: Selectable upper or lower sideband, MCW, FSK, AM, CW.

POWER REQUIREMENTS:

- A. Pilot lamp switched off
1. 117/234 V.A.C. 50-60 hertz; 10 watts at 50 mw audio output, 15 watts at 1.5 watts audio output.
 2. 12.6 V.D.C.; 2.5 watts (200 ma.) at 50 mw audio output, 6.5 watts (525 ma.) at 1.5 watts audio output.
- B. Pilot lamps switched on.
1. 117/234 V.A.C. requires additional 7 watts
 2. 12.6 V.D.C. requires additional 590 ma.

CALIBRATION ACCURACY: Within one kHz per 500 kHz band.

SYNTHESIZER ACCURACY: Within 250 hertz over entire tuning range when zeroed at 10 MHz.

RESET ACCURACY (Including Visual Error): Within 250 hertz.

TUNING DIAL BACKLASH: Less than 50 hertz.

TUNABILITY: Within 2 hertz.

MAIN TUNING RATIO: Two-speed; 50 kHz/revolution (flywheel) or 10 kHz/revolution.

MAIN TUNING BANDSPREAD: 1/4" per kilohertz; 12 feet per 500 kHz band.

CALIBRATOR: 50 kHz crystal controlled.

FREQUENCY STABILITY:

- A. In room ambients: 300 hertz per hour from point of turn-on to two hours after turn-on; better than 100 hertz per day thereafter.
- B. With respect to temperature: 50 hertz per °C.
- C. With respect to A.C. supply variation: essentially none for ±27% change.

R.F. INPUT IMPEDANCE: 50 ohm unbalanced (nominal); also separate high impedance unbalanced input for use with random antennas.

SENSITIVITY (500 kHz-30 MHz):

A. AM (Nominal): Better than 2.0 uv for 10 db S/N.

B. SSB/CW (Nominal): Better than 1.0 uv for 10 db S/N.

SENSITIVITY (Five kHz-500 kHz): 25-200 uv for 10 db S/N without LF-10 preselector; equal to HF sensitivity when LF-10 preselector is used.

SELECTIVITY:

A. 6 db bandwidths available; 500 hertz; 2.5 kHz, 5.0 kHz; 8.0 kHz.

B. Filter Design: six-pole LC type operating at 230 kHz; tunable through 6 kHz range in 500 hertz and 2.5 kHz bandwidths.

C. Filter shape factor (Nominal): 2.5:1 (6-60 db) in 2.5 kHz bandwidth.

D. Audio filtering provisions incorporated in LF-10 preselector.

HETERODYNE REJECTION FACILITIES: 230 kHz bi-filar notch (REJECTION TUNE control) with ±10 kHz range around IF passband; minimum rejection capability of 50 db. Also.

PASSBAND TUNE control (of tunable six-pole filter) permits rejection of adjacent channel interference without change in frequency of desired signal.

IMAGE REJECTION (500 kHz-30 MHz.): Averages 80 db; minimum 50 db.

SPURIOUS RESPONSES TO OFF-TUNE EXTERNAL SIGNALS: Minimum 50 db rejection.

INTERNALLY GENERATED SPURIOUS SIGNALS: All less than 2.0 uv equivalent signals (between 500 kHz and 30 MHz.) except for two discrete responses at 2.75 MHz and 3.0 MHz.

AGC: Time constant; 60 millisecond attack, 3 sec. delay. AGC merit; average 5 db output change for input increase from 10 to 100,000 uv.

AUDIO FREQUENCY RESPONSE: 100 hertz-5500 hertz within 6 db.

AUDIO OUTPUT DISTORTION (Nominal): 0.5 watts, 3.2%; 1.0 watts, 4.4%; 2.0 watts, less than 10%.

AUDIO HUM: Better than 60 db below maximum output.

AUDIO OUTPUTS: 3.2 ohms to rear panel and front panel headphone jack; 600 ohms balanced with center tap (ground reference or floating) to rear panel.

REMOTE CONTROL PROVISIONS: R.F. Gain; A.F. Gain; Receiver Mute; BFO On-Off; Power On-Off.

METERING: Front panel meter calibrated in db above 1.0 uv and from 0 to S-9 between no-signal and 40 db above 1.0 uv.

AGC THRESHOLD CONTROL: R.F. input attenuator; 0-30 db in nominal 10 db steps.

FRONT PANEL CONTROLS: SYNTHESIZER TUNE (MHz); PRESELECTOR TUNE; PASSBAND TUNE; REJECTION TUNE; MAIN TUNING (kHz); R.F. GAIN; A.F. GAIN; BANDSWITCH; AGC On-Off-Threshold Control (to 30 db); FUNCTION Off-Standby-SSB-AM-Calibrate; DIAL LAMPS On-Off; BANDWIDTH 500 hertz-2.5 kHz-5.0 kHz-8.0 kHz; DIAL LOCK; PHASE LOCK Warning.

REAR PANEL CONTROLS: S-Meter Zero; Rejection Tune Balance; 117/234 V.A.C.-12.6 V.D.C. Selector Switch.

REAR PANEL OUTPUTS: BFO (230 kHz, 47 ohm, 100 mv); VFO (2980-3480 kHz, 100 ohm, 100 mv); synthesizer (500 kHz increments between 7.25 MHz and 32.75 MHz, 330 ohm, 100 mv); 26 MHz oscillator (50 ohm, 100 mv); I.F. (50 ohm, output dependent upon signal level); detector (10,000 ohm, output dependent upon signal level); audio; two spare connectors.

REAR PANEL INPUTS: 50 ohm unbalanced H.F. antenna; high impedance unbalanced H.F. antenna; low frequency; 117/234 V.A.C.; 12.6 V.D.C.; sidetone oscillator or external audio.

REAR PANEL VOLTAGE OUTPUTS: +12 V.D.C., +11 V.D.C., +10 V.D.C., +7.5 V.D.C. regulated, +5 V.D.C. regulated, +1.5 V NPN A.G.C., +9 V PNP A.G.C.

ENVIRONMENTAL CONDITIONS:

A. Ambient operating temperatures: -20° C to +45° C.

B. Humidity: to 90%.

MTBF: 3820 hours per NAVSHIPS 93820.

SIZE: 7 7/8" H, 16 1/2" W, 12 3/4" D.

WEIGHT: 32 pounds.

ALTERNATE CONFIGURATIONS: RMK-5 rack mounting kit for HRO-500 installation (per Mil-Std. 189) in 8 3/4" H x 19" W rack space; HRO-500P portable version with built-in loudspeaker, self-contained rechargeable battery power, and waterproof carrying case.

ACCESSORIES: LF-10 (five kHz-500 kHz preselector); HRO-500-TS matching table speaker (7" H x 5 7/8" W x 12 3/4" D); WPC-5 waterproof carrying case.

SPECIFICATIONS

SECTION 7
PARTS LIST

SOCKETS, JACKS, AND PLUGS

J-1	Coaxial Connector, Antenna	A51479
J-2, J-4, J-300	Jack, HI-Z Antenna, 26 MHz and HFO Out	A51084
J-3, J-5, J-6	Jack, LO-Freq In, VFO, and BFO	A51084
J-7	Jack, Phones	A50793-3
J-8	Socket, 117V AC Power	A51081
J-9	Socket, 12V DC, Jones, 2-T, Male Chassis Mounted	A51267
P-9	Plug, Jones, 2-T, Female	A51268
J-10	Terminal Board, Speaker	A51080-5
J-11, J-12, J-13	Jack, IF, Spare and Spare	A51084
J-14	Socket, Jones, 18-T, Female Chassis Mount	A51083
P-14	Plug, Jones, 18-T, Male	B51265
	Socket, Transistor, 3-Terminal	A50981
	Socket, Transistor 4-Terminal	A51725
	Socket, Power Transistor	B51068
	Socket, Crystal	A50799
	Socket, Indicator Lamp	A51246
	Socket, Panel Lamp Assembly (3 Sockets)	B51601
	Socket, Panel Lamp (Drum) (2 Sockets)	B51184

POTENTIOMETERS

R-54, R-98	Potentiometer, RF Gain and Audio Gain	B51272
R-68	Potentiometer, Depth	B50088
R-108	Potentiometer, S-meter, Zero	B51282-1

DIODES

CR-1, CR-2	Diode, 1N541	1N541
CR-7, CR-8	Diode, 1N484	A51672
CR-3	Diode, Zener, 5 V, 1N761-2	1N761-2
CR-4 (2), CR-301 (2)	Diode, Matched Pair 1N541	1N542
CR-6, CR-9, CR-300	Diode, 1N60	1N60
CR-10	Diode, Zener, 7.5 V, 1N3017B	A51343-1
CR-11, CR-12	Diode, Columbus Electronics (CEC-105)	A51294-2
CR-13	Diode, Zener, 13V, $\pm 5\%$	B52020-8
CR-15, CR-302, CR-303	Diode, 1N295X	1N295X
CR-14	Diode, Solitron 2A50 (1N1908) (1N4513)	A51707-4
C-402	Diode, Varactor, (Sylvania D6650)	A51875
C-390	Diode, Varactor, Pacific Semiconductor VC-47	A51307-9

COILS AND TRANSFORMERS

T-1	Transformer, Antenna 10 MHz to 20 MHz	B51023
T-2	Transformer, Antenna 20 MHz to 30 MHz	B51024
T-3	Transformer, Antenna .5 MHz to 1.5 MHz	B51705
T-4	Transformer, Antenna 1.5 MHz to 4 MHz	B51021
T-5	Transformer, Antenna 4 MHz to 10 MHz	B51022
T-6	Transformer, Bandpass 26.5 MHz to 27.5 MHz	B51030
T-7	Transformer, Bandpass 27.5 MHz to 30 MHz	B51031
T-8	Transformer, First Mixer Output	B51045
T-9	Transformer, Tunable IF 2.75 MHz to 3.25 MHz	B51049
T-10	Transformer, 230 kHz, 8-kHz Bandwidth	B51047
T-11, T-12	Transformer, 230 kHz, 5-kHz Bandwidth	B51048
T-13	Transformer, Second 230 kHz IF	B51054
T-14	Coil, Product Detector	B51335
T-16	Transformer, Audio Driver	B51649
T-17	Transformer, Audio Output	B51062
T-18	Transformer, Power (115-230V)	C51622
T-301, T-302	Transformer, IF 4.75 MHz Reference	B51380
T-303	Transformer, IF 4.75 MHz Output	B51379
T-300	Coil, Blocking Oscillator	B51085
L-2	Coil, RF Output 10 MHz to 20 MHz	B51028
L-3	Coil, RF Output 20 MHz to 30 MHz	B51029
L-4	Coil, RF Output .5 MHz to 1.5 MHz	B51025
L-5	Coil, RF Output 1.5 MHz to 4.0 MHz	B51026
L-6	Coil, RS Output 4 MHz to 10 MHz	B51027
L-10	Coil, VFO	B50992
L-11, L-12, L-13, L-14, L-15, L-16	Coil, Ferrite Filter	A51251
L-17	Coil, 230-kHz Filter, Preamplifier	B51051
L-18	Coil, Crystal Calibrator	B51264
L-19	Coil, 26-MHz Oscillator	B51032
L-20	Coil, First 230-kHz IF	B51053
L-21	Coil, Bifilar T	B51067
L-22	Coil, Bifilar Tuning	B51056
L-23	Coil, Third 230-kHz IF	B51052
L-24	Coil, BFO	B51334

L-315, L-317	Coil, HFO Buffer Bands 3 and 5	B50932
L-316	Coil, HFO Buffer Band 4	B50939
L-301	Coil, 500-kHz Oscillator Coil	B51264
L-305	Coil, Spectrum Generator Bands 1, 2, and 5	B51345
L-306	Coil, Spectrum Generator Band 4	B51346
L-307	Coil, Spectrum Generator Band 3	B51344
L-309	Coil, HFO Band 4	B50935
L-308, L-310	Coil, HFO Bands 3 and 5	B50936

CHOKES

L-7	Coil, .68 μ h	C50750-11
L-26	Coil, 1.5 mh	B17305
L-28	Coil, 3.3 μ h	C50750-19
L-300, L-302, L-303, L-304, L-311, L-312, L-314, L-318, L-319, L-321	Coil, 100 μ h	C50750-37
L-1, L-27, L-323	Coil, 220 μ h	A50206-1
L-25	Coil, 750 μ h	C50527-5
L-320	Coil, 1 mh	A50206-2

SWITCHES

S-1	Switch, Band, Main Assembly	C51035
S-2	Switch, AGC, Pad	B51369
S-3	Switch, Bandwidth	C50973
S-4	Switch, Function	B51269
S-5	Switch, Toggle (Panel Lamps)	A51616
S-6	Switch, Rocker (AC-DC) 3 PDT	A51257
S-300	Switch, Synthesizer Band	C51019
S-301	Switch, Band Burst	B51189

KNOBS

Knob, Main Tuning	NPS-22N2LA
Knob, Synthesizer and Preselector Tuning	NPS-9G2LA
Knob, Audio Gain	NPS-9N3LB
Knob, RF Gain	A51677-1
Knob, Bandswitch	NPS-9K2LA
Knob, Rejection Tune (Notch)	A51612-1
Knob, Skirt, Rejection Tune	A51292-1
Knob, Passband Tune	A51647-1
Knob, Bandwidth	NPS-9F2LA
Knob, Function Switch	A51679-1
Knob, AGC Threshold	A51646-1
Knob, Dial Lock	B51175

FIXED CAPACITORS

C-316, C-387	Capacitor, Mica, 18 pf $\pm 2\%$ 100V	NCS-15-180-G-1
C-386	Capacitor, Mica, 22 pf $\pm 2\%$ 100V	NCS-15-220-G-1
C-317	Capacitor, Mica, 24 pf $\pm 2\%$ 100V	NCS-15-240-G-1
C-311, C-312, C-315	Capacitor, Mica, 27 pf $\pm 2\%$ 100V	NCS-15-270-G-1
C-335	Capacitor, 33 pf $\pm 2\%$ 100V	CC-20-UJ-330-G
C-178, C-179, C-180, C-181, C-182, C-183	Capacitor, Mica, 47 pf $\pm 2\%$ 100V	NCS-15-470-G-1
C-114, C-120	Capacitor, Mica, 68 pf $\pm 2\%$ 100V	NCS-15-680-G-1
C-321, C-1	Capacitor, Mica, 75 pf $\pm 2\%$ 100V	NCS-15-750-G-1
C-318	Capacitor, Mica, 82 pf $\pm 2\%$ 100V	NCS-15-820-G-1
C-5, C-30	Capacitor, Mica, 91 pf $\pm 2\%$ 100V	NCS-15-910-G-1
C-322	Capacitor, Mica, 100 pf $\pm 2\%$ 100V	NCS-15-101-G-1
C-331	Capacitor, Mica, 165 pf $\pm 2\%$ 100V	A51946-1
C-29	Capacitor, Mica, 220 pf $\pm 2\%$ 100V	NCS-15-221-G-1
C-90, C-92, C-96, C-99, C-102, C-105	Capacitor, Mica, 510 pf $\pm 1\%$ 100V	NCS-15-511-F-1
C-91, C-93, C-97, C-100, C-103, C-106	Capacitor, Mica, 1500 pf $\pm 1\%$ 100V	NCS-15-152-F-1
C-71	Capacitor, Ceramic, 5 pf $\pm .5$ pf NPO (Special)	CC-20-SH-050-D
C-201	Capacitor, Ceramic, 5 pf $\pm 5\%$ N330	CC-20-UJ-050-D
C-69	Capacitor, Ceramic, 10 pf $\pm 5\%$ N1500	CC-20-P3K-100-D
C-83, C-84, C-85, C-86, C-87, C-88	Capacitor, Ceramic, 68 pf $\pm 2\%$ N330	A51254
C-135	Capacitor, Electrolytic, 3000, 600, 600 mfd 25V	C51066

VARIABLE CAPACITORS

C-4	Capacitor, Variable, Preselector Tuning	C51034
C-52	Capacitor, Variable, Main Tuning	C50982
C-89	Capacitor, Variable, Passband Tuning	C50927
C-145	Capacitor, Variable, Rejection Tuning	B51079
C-332	Capacitor, Variable, Synthesizer Tuning	C51011
C-373	Capacitor, Variable, Burst Circuit Tuning	B51274

TRIMMERS

C-8, C-10	Capacitor, Trimmer Assembly (Antenna)	B50993-3
C-9, C-11	Capacitor, Trimmer Assembly (RF Base)	B50993-3
C-12, C-14, C-16	Capacitor, Trimmer Assembly (Antenna)	B50993-2
C-13, C-15, C-17	Capacitor, Trimmer Assembly (RF Base)	B50993-2
C-23, C-24	Capacitor, Trimmer Assembly (RF Collector)	B50993-3
C-25, C-26, C-27	Capacitor, Trimmer Assembly (RF Collector)	B50993-2
C-44	Capacitor, Trimmer (26-MHz Buffer)	A51383-2
C-49, C-53, C-55, C-58	Capacitor, Trimmer Assembly (Tunable IF)	B51304-4
C-68	Capacitor, Trimmer NPO (VFO Tuning)	B19783-2
C-94, C-95	Capacitor, Trimmer (Filter)	A50980
C-98, C-101		
C-104, C-108		
C-125	Capacitor, Trimmer NPO (50 kHz Oscillator)	B19783-2
C-156	Capacitor, Trimmer 8-60 pf (S-meter Sensitivity)	A51383
C-200	Capacitor, Trimmer NPO 5-25 pf (VFO Temp. Comp.)	B19783-2
C-301	Capacitor, Trimmer 1.5-20 pf (500 kHz Oscillator)	A50137-3
C-323, C-324, C-325, C-326, C-327, C-328, C-329	Capacitor, Trimmer Assembly (Synthesizer HFO)	B51304-5
C-366	Capacitor, Trimmer (4.75 MHz Oscillator)	A50137-3
C-375, C-377, C-379, C-380, C-382	Capacitor, Trimmer Assembly (Synthesizer HFO)	B51304-1

TERMINAL BOARDS

Terminal Board, Synthesizer Sweep	B51279
Terminal Board, Synthesizer Buffer	B51012
Terminal Board, Synthesizer HFO and AGC	B51867
Terminal Board, Synthesizer, Reference IF	B51005
Terminal Board, Synthesizer 4.75 MHz Oscillator	B51004
Terminal Board, Synthesizer 500-kHz Oscillator	A51252-2
Terminal Board, Synthesizer Burst Generator	B51253-2

Terminal Board, RF and 26-MHz Oscillator	B51043
Terminal Board, Tunable IF and Second Mixer	B51046
Terminal Board, 230-kHz IF	B51055
Terminal Board, AGC	B51060
Terminal Board, S-meter	B51258
Terminal Board, Filter Preamplifier	B51050
Terminal Board, 26-MHz Oscillator Buffer	B51341
Terminal Board, Indicator and Calibrator	B51289
Terminal Board, VFO Bias	B50991-2
Terminal Board, First Mixer	B51042
Terminal Board, Product Detector	B51058
Terminal Board, Audio	B51063
Terminal Board, Power Supply	B51064

TRANSISTORS

Q-1	Transistor, 2N3663 General Electric	
Q-2, Q-4, Q-5, Q-6, Q-7, Q-8, Q-9, Q-10, Q-12, Q-13, Q-14, Q-15, Q-300, Q-304, Q-305, Q-307, Q-308, Q-309	Transistor, 2N2672 Amperex	or 2N2188 Texas Instruments
Q-11, Q-16, Q-17, Q-19, Q-22	Transistor, 2N2429, Amperex	or 2N2375 Texas Instruments
Q-3, Q-18, Q-23, Q-24, Q-301, Q-302, Q-310	Transistor, 2N706, Texas Instruments	
Q-20, Q-26	Transistor (Matched Pair), TI3027, Texas Instruments	or 2N1168, Delco
Q-25	Transistor, TI3027, Texas Instruments	or 2N1168, Delco
Q-303, Q-306,	Transistor (4-pin), 2N2654, Amperex	or 2N2997 Texas Instruments
Q-311	Transistor, Unijunction, 2N2646, General Electric	or 2N489 Texas Instruments

GEAR BOX

Gear Box Housing	C51151-3
Shaft, Vertical, Mask Drive	A51158
Miter Gear, Mask Drive	A51152
Special Miter Gear, Mask Drive	A51153
Shaft, Transverse, Drum Drive	A51165
Helical Gear, Drum Drive	A51170-1
Hollow Shaft, Mask Drive	A51164
Special Miter Gear, Mask Drive	A51157
Pinch Shaft, Synthesizer Tuning Drive	A51162
Fly Wheel, Synthesizer Tuning Drive	A51392
Pinion Shaft, Synthesizer Tuning Drive	A51161
Disc, Drive, Synthesizer Tuning Drive	A51160-1
Hub, Synthesizer Tuning Drive	A51156-2
Worm Gear, Synthesizer Tuning Drive	B51170-2
Gear 115T, Synthesizer Tuning Drive	A51599-1
Shaft, Fiberglass, Preselector	A50818-5
Gear, Anti-Backlash, Preselector	A51154-2
Couplink, Preselector	B25000
Shaft, Preselector Dial	A51163
Dial, Preselector	A51617
Gear, Spur, Preselector Drive	B51155-1
Ball Vernier Assembly, Preselector	A51728

GEARS, SHAFTS, COUPLINGS, AND DRIVE TRAIN

Clamp, Dial Lock	A51173
Cam Shaft, Dial Lock	B51174
Clamp Guide, Dial Lock	B51286
Spring, Dial Lock	B234-1
Bandswitch Detent	B20662-2
Bandswitch Shaft Coupling	A12611
Bandswitch Pulley Assembly	A51276-1
Bandswitch Shaft	A50854
Bandswitch Miter Gear	A51152
Function Switch Shaft	A50818-4
Shaft, Coupling, Function Switch	B25000
Synthesizer Tune Pulley and Hub Assembly	A51276-1
Main Tuning Capacitor Worm Gear	C50982-2

COVERS

Cover, Rear Synthesizer	C51631-1
Cover, Front Synthesizer	C51631-2
Cover, Filter Tuning Capacitor	C51386
Cover, Preselector Tuning Capacitor	C51387
Cover, Filter	C50989
Cover, VFO	B51340
Cover, VFO Coil	A51987

MISCELLANEOUS PARTS

Gusset, Left	D51347-3
Gusset, Right	D51347-4
Bracket, Synthesizer Tuning Gang	A51071
VFO Extrusion Sub-Assembly	D50983
Shield Bracket, Filter	C50971
Mounting, Worm Gear (VFO)	A51339
Shield, Bandswitch Mounting	C50958
Stand Off Terminal	A51078-1
Indicator Lamp Cap (Red)	A51248-1
Mounting Plate, Indicator Lamp	A51287
Washer, Phones Jack	H-638-2
Nut, Phones Jack	A50363
Drum Stud and Holder Assembly	A51183
Dial Cylinder, Calibrated	B52133
Cylinder Mask	B52131
Window, Front Panel	B51076-1
Dial Cord Assembly, Bandswitch	B19347-12
Dial Cord Assembly, Synthesizer, Tune	B19347-13
Screws, Power Transistor Mounting	A50029-31
Mica Washer, Power Transistor	A51305
Index, Main Tuning	C51293
Function Switch Mounting Bracket	A51256
Panel Bushing, Function Switch	A50840
Pinut, Panel Bushing	B19322-8
Ground Strap, Synthesizer Capacitor	A51388
Connector, Male (Lamp Harness)	A51384-2
Connector, Female (Lamp Harness)	A51384-1
Clutch Assembly Main Tuning	A51729
Main Tuning Dial Assembly	A51731
Main Tuning Ball Vernier Assembly	A51730
Front Panel Complete	A51732
Cabinet	A51733
Insulator Block, Burst Tuning	B51266
Hub Mask — Left	A52130-1
Hub Mask — Right	A52130-2

MISCELLANEOUS ELECTRICAL

PL-6	Indicator Lamp Sylvania -6ESB	A51246-1
PL-1, PL-2	Panel Lamp #47	NPL47
PL-3, PL-4	Panel Lamp #53X	A51985
PL-5	Panel Lamp #1815	NPL1815
	Line Cord	B51077
M-1	S-meter	C51342
X-1	Crystal, 26 MHz	A51377
X-2	Crystal, 50 kHz	A51373
X-3	Crystal, 230 kHz	A51374
X-300	Crystal, 500 kHz	A51375
X-301	Crystal, 4.75 MHz	A51376