

**INSTRUCTION
MANUAL
YO-301**

YAESU MUSEN CO., LTD.

TOKYO JAPAN.

YO-301 MONITORSCOPE
OPERATION MANUAL



GENERAL

The model YO-301 Monitorscope is a measuring instrument for radio amateur use. This unit consists of a monitor of "on the air" signal and an oscilloscope. A two tone signal generator is built in for single sideband transmitter adjustment. The main function of the monitorscope is to monitor the transmitted signal on the scope. It can also be used to observe the signal received with an optional receiver adapter kit. The cabinet and front panel design of the YO-301 matches that of the FT-301 series of amateur SSB equipment.

SPECIFICATIONS

VERTICAL AMPLIFIER

Input Impedance	-	1M ohm 50 PF
Input Attenuator	-	X1, X10, X100 and Ground
Sensitivity	-	20 mV/Div (P-P)
Frequency Response	-	2 Hz to 4 MHz -3 dB 9 MHz to 10.7 MHz
Maximum Input Voltage	-	600V DC + AC Peak

HORIZONTAL AMPLIFIER

Input Impedance	-	100K ohm 100 PF
Sensitivity	-	300 mV/Div (P-P)
Sensitivity Adjustment	-	Variable
Frequency Response	-	10 Hz to 250 kHz -3 dB
Sweep Frequency	-	10 Hz to 10 kHz variable
Maximum Input Voltage	-	30V DC + AC Peak

TONE GENERATOR

Frequency	-	1500 Hz and 1900 Hz app.
Output Voltage	-	20 mV (P-P) nominal 115 mV (P-P) maximum

TRANSMITTER MONITOR

Frequency Coverage	-	1.8 MHz to 54 MHz
Input Impedance	-	50 to 75 ohms
Signal Power Limit	-	10 watts to 500 watts
Input Attenuator	-	5 steps
Insertion Loss	-	less than 0.5 dB
Display	-	Envelope, Trapezoid and Cross Pattern

GENERAL

Picture Tube	-	C312P1
Picture Tube Anode Voltage	-	1.3 KV
Power Requirement	-	100/110/117/200/220 or 234 Volts AC at 50/60 Hz, 15 VA
Size	-	213 (W) x 125 (H) x 295 (D) mm
Weight	-	6 Kg app.

SEMICONDUCTORS

FET :	2SK30A	5 pcs
SILICON Transistor :	2SA733P	2 pcs
	2SC372O	8 pcs
	2SC373	1 pce
	2SC1514	4 pcs
DIODE :	1N60	3 pcs
	1S1588	3 pcs
	1S1830	1 pce
	1DZ61	2 pcs
	SIR150	4 pcs
ZENER DIODE :	RD6AM	2 pcs
	RD8.2FA	1 pce
	RD15FA	1 pce

ACCESSORIES

Coax Cable (1)	- 5D2V both ends with coax plug	2 pcs
Coax Cable (2)	- RG-58A/U with one end coax and the other end RCA plug	1 pce
Shielded Wire (1)	- RCA plug and clips	1 pce
Shielded Wire (2)	- RCA plug and 4P mike plug	1 pce
RCA Plug	2 pcs
Fuse 0.5A	3 pcs

CONTROLS & SWITCHES

Prior to using the monitorscope, it is recommended that you study and thoroughly understand the function of each control and switch described below:

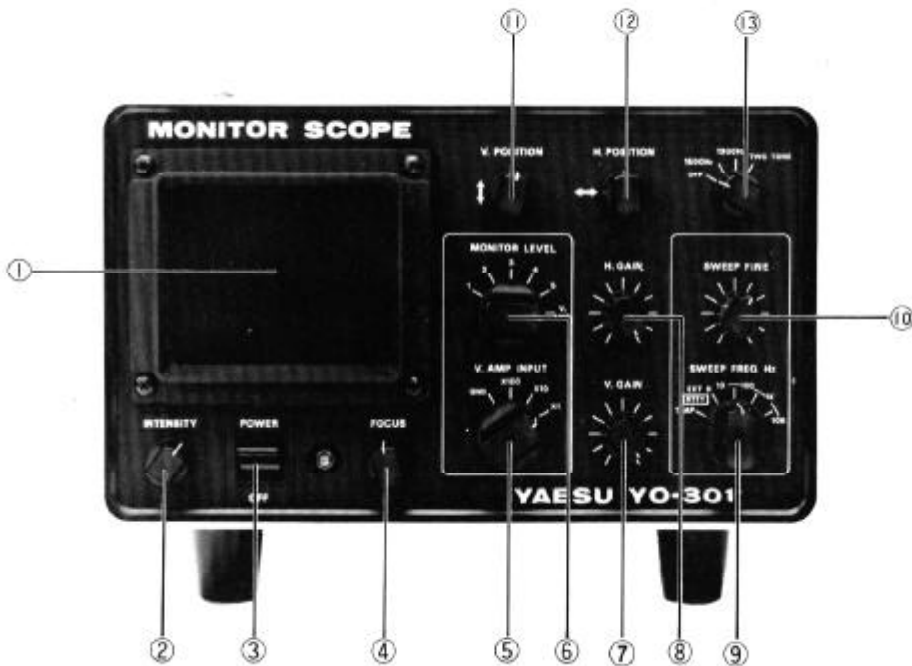

FRONT PANEL

- | | | | |
|-----|--------------|---|---|
| (1) | PICTURE TUBE | - | Displays pattern on this surface. A 6 mm division scale is provided. |
| (2) | INTENSITY | - | This control varies the brightness of the pattern on the scope screen. Excessive brightness may burn the phosphor on the face of the CRT (Cathode Ray Tube). |
| (3) | POWER | - | Apply AC power at ON position. |
| (4) | FOCUS | - | This control is used to adjust the clear and sharp surface. There may be some interaction between this control and the INTENSITY control. Adjust this control for the clearest trace. |
| (5) | V. AMP INPUT | - | This switch has two functions. It is an attenuator and also selects the input level to the vertical amplifier. At G position, the vertical input is grounded. |

- (6) MONITOR LEVEL - This is a six position switch. Positions 1 through 5 are used as an attenuator for the transmit signal monitor. This switch should be set to V. AMP position for receiver monitor or oscilloscope use.
- (7) V. GAIN - This control is used to vary the gain of the vertical amplifier. When the monitorscope is used as a transmitter monitor, the pattern height cannot be varied by this control. The transmitted signal pattern can be varied by the monitor level control.
- (8) H. GAIN - This control is used to vary the gain of the horizontal amplifier.
- (9) SWEEP FREQ - This switch selects the horizontal sweep frequency range and horizontal input. The sweep frequency covers from 10 Hz to 10 kHz in 3 steps as shown on scale. At EXT H. (RTTY) the horizontal input is selected to the external signal and this position is also used for RTTY cross pattern observation. The TRAP position is used for trapezoid pattern monitoring.
- (10) SWEEP FINE - This control is used for a fine tuning of the sweep frequency set by the SWEEP FREQ switch.
- (11) V. POSITION - This control determines the vertical position of the displayed pattern.
- (12) H. POSITION - This control determines the horizontal position of the displayed pattern.
- (13) TONE SELECTOR - This switch is used for internal two tone signal generation and selects either 1500 Hz, 1900 Hz or both of them.

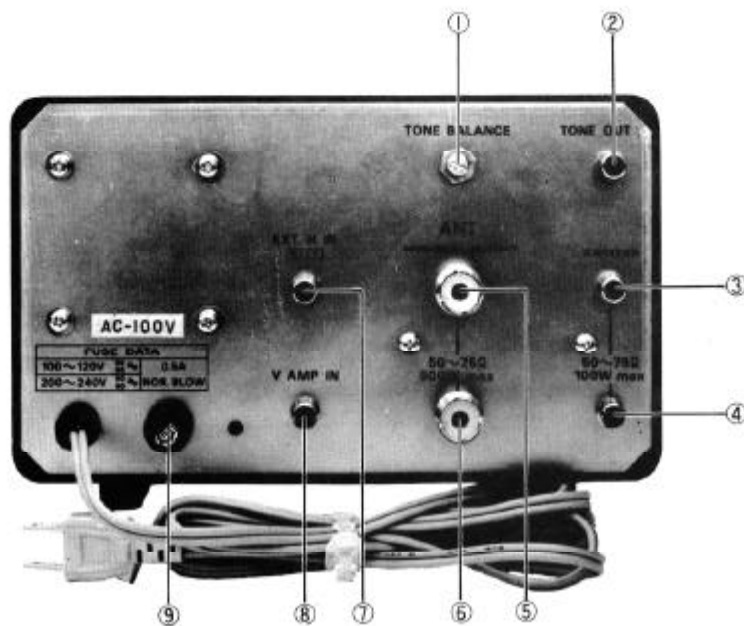

REAR PANEL

- | | | | |
|--------|--------------|---|--|
| (1) | TONE BALANCE | - | This control is used to balance the output level of the two tone signal. |
| (2) | TONE OUT | - | This control is the output terminal of the internal two tone signal. |
| (3)(4) | EXCITER | - | This terminal is used for trapezoid pattern monitoring. |
| (5)(6) | ANT. | - | Two coax connectors for transmitter signal monitoring. |
| (7) | EXT. H IN | - | Input terminal for the horizontal amplifier. |
| (8) | V AMP IN | - | Input terminal for the vertical amplifier. |
| (9) | FUSE | - | Fuse holder. |

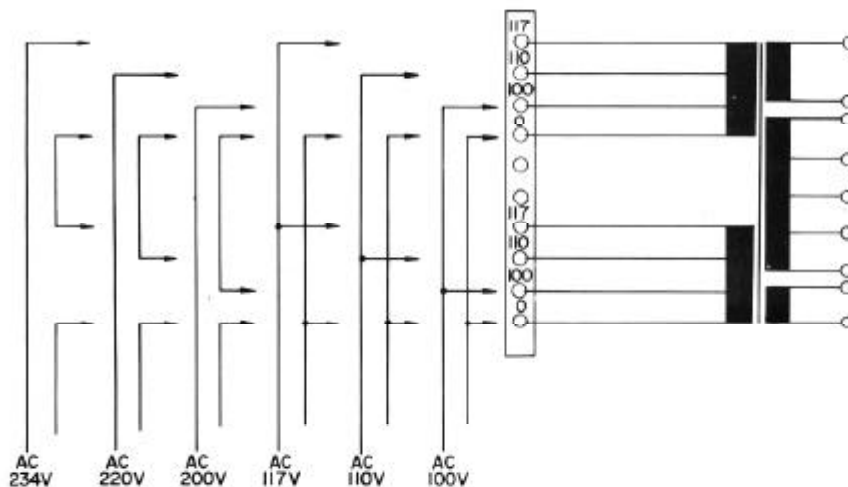

Figure 1

YO-301

INSTALLATION

The monitorscope may be installed side by side with radio communication equipment for transmitter or receiver signal monitoring. The YO-301 monitorscope is designed to be used in many areas of the world using the power line supply voltage that may differ from the operator's local supply voltage. Therefore, before connecting the AC cord to the power outlet, be sure that the voltage marked on the rear of the monitorscope agrees with the local AC supply voltage.

CAUTION

PERMANENT DAMAGE WILL RESULT IF IMPROPER
AC SUPPLY VOLTAGE IS APPLIED TO THE MONITORSCOPE.

INITIAL SETTING OF THE CONTROLS

The following set-up procedure is required prior to operating the monitorscope.

POWER	-	OFF		
INTEN	-	12 o'clock position		
FOCUS	-	12	"	"
V. POSITION	-	12	"	"
H. POSITION	-	12	"	"
V. GAIN	-	12	"	"
H. GAIN	-	12	"	"
SWEEP FINE	-	12	"	"
V. AMP. INPUT	-	X100		
SWEEP FREQ	-	10 Hz - 100 Hz		
MONITOR LEVEL	-	V. AMP.		
TONE SELECTOR	-	OFF		

Set the POWER switch to ON position and wait until a bright trace is present on the screen of the scope. Adjust the INTEN control for a proper brightness. Excessive brightness for prolonged period of time may burn the phosphor on the CRT screen.

Adjust the FOCUS control for a clear and sharp trace. There is an interaction between this control and the INTEN control. Therefore, adjust them for the best focus at the desired brightness.

Adjust the H. POSITION and V. POSITION to bring the spot to the center of the screen. Rotate the H. GAIN control and observe that the spot produces a horizontal line in the center of the screen.

OPERATION

TRANSMITTER MONITORING

The following instructions are for the transmitter which has a 50 - 75 ohm coaxial output.

- (1) Connect the RF output of the transmitter (transceiver) or linear amplifier to either coaxial connector marked ANTENNA on the rear of the monitorscope. Connect the dummy load or antenna to the other coaxial connector marked ANTENNA. Refer to Figure 2.

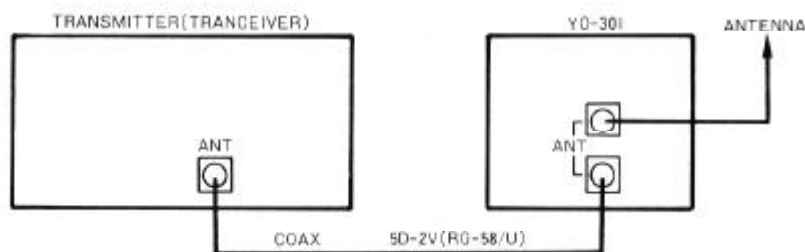

Figure 2

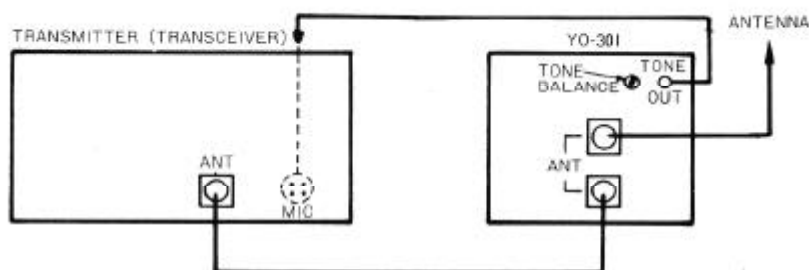

Figure 3

- (2) Set the MONITOR LEVEL switch to proper setting as shown in Table 1.

OUTPUT	MONITOR LEVEL	HEIGHT
5W	5	5 DIV.
15W	4	6 DIV.
100W	3	6 DIV.
100W	2	5 DIV.
500W	1	6 DIV.

Table 1 (Measured With 50ohm Dummy Road)

- (3) Push the POWER switch of the monitorscope and adjust the controls as described in the initial adjustment procedure.
- (4) Turn on the transmitter and adjust the H. GAIN, SWEEP FREQ and SWEEP FINE controls for the desired pattern display.
- (5) Internal tone generator signal may be used for SSB or AM transmitter with the shielded cable. Use either 1500 kHz or 1900 kHz for signal tone test. In SSB transmission, set the TONE SELECTOR switch to TWO TONE position. Refer to Figure 3
- (6) Refer to the patterns on Page 10 for the evaluation of the transmitted signal.

NOTE: For a two tone test, the amplitude of each tone signal should be set to the same value.

Connect the tone signal output to the VERT AMP IN. Set the TONE switch to 1500 kHz and adjust the VERT GAIN until the display reaches two scales.

Then, set the TONE switch to 1900 Hz and adjust TONE BALANCE on rear panel until same height is obtained as the 1500 kHz signal.

The following are typical transmitted signal patterns displayed on the monitorscope screen when it is connected as in Figure 1.

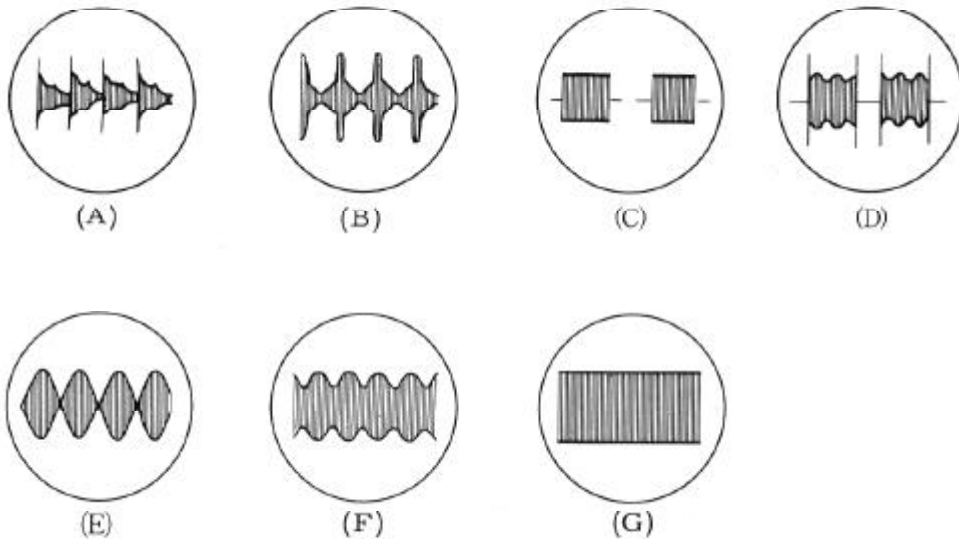

Figure 4

- (A) SSB signal voice modulated. Correctly adjusted.
- (B) SSB signal voice modulated. Excessive mic gain or insufficient loading. Flat topping can be seen.
- (C) Pure CW signal.
- (D) CW signal with hum and key click.
- (E) SSB signal two tone modulated. Correctly adjusted.
- (F) SSB signal two tone modulated. Carrier leaking.
- (G) SSB signal single tone modulated. Correctly adjusted.

RF TRAPEZOID TEST

Set up the monitorscope and the transmitting equipment as illustrated in Figure 5 for linearity test of the RF amplifier. The patterns from this test are called trapezoid patterns. Press down the TRAP switch on the front panel.

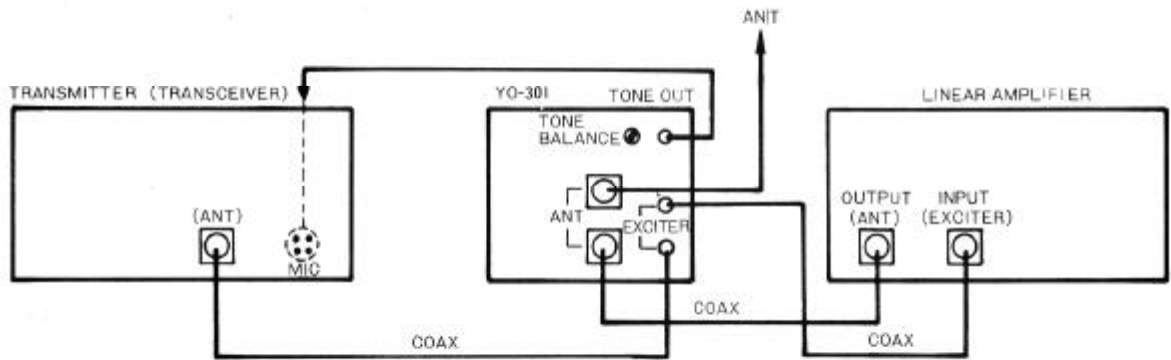

Figure 5

- (1) Connect a coaxial cable from the output of the exciter to one of the connectors marked EXCITER and connect the other connector to the input of the linear amplifier under test with a coaxial cable as illustrated in Figure
- (2) Connect a coaxial cable from the RF output connector of the linear amplifier to one of the ANTENNA connectors on the monitorscope. Connect the dummy load or antenna to the other ANTENNA connector of the monitorscope.
- (3) Connect a shielded cable from the TONE OUT of the monitorscope to the microphone input of the exciter.
- (4) Turn ON the POWER switch of the monitorscope and adjust the controls as described in the initial adjustment procedure.
- (5) Set the SWEEP FREQ switch to TRAP position and the tone signal switch to the TWO TONE position.
- (6) Turn on the exciter and linear amplifier and adjust the switch and H. GAIN control of the monitorscope for the desired pattern display.
- (7) Refer to the patterns on Page 12 for the evaluation of the linearity of the linear amplifier under test.

NOTE: To avoid the burn-out of the screen phosphor when there is no output from the transmitter, the INTENSITY control should be set as low as possible.

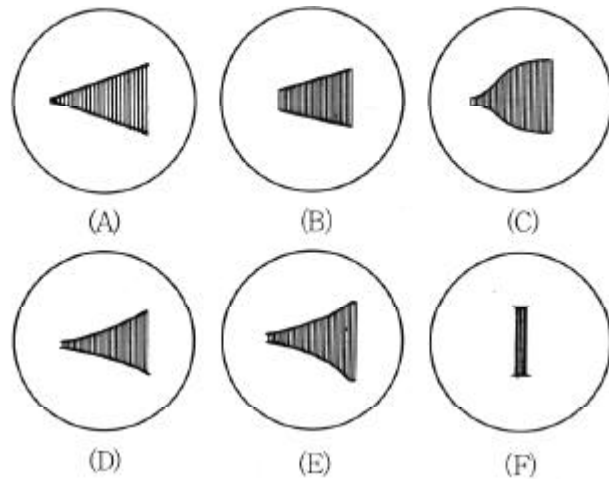

Figure 6

- (A) Good linearity.
- (B) Modulation less than 100% and good linearity.
- (C) Non-linear pattern indicating overdrive, insufficient antenna loading, grid current curvature or regeneration.
- (D) Non-linear pattern indicating regeneration or excessive grid bias.
- (E) Non-Linear and parasitic oscillation on modulation peak.
- (F) Unmodulated carrier.

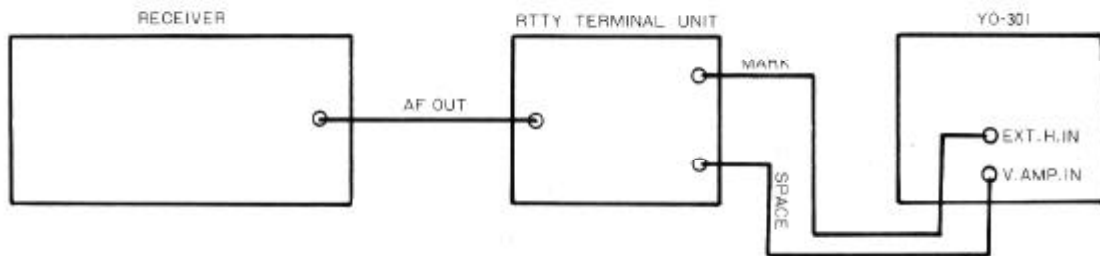

Figure 7

RTTY CROSS TEST

- (1) Connect a shielded cable from the mark terminal of the RTTY terminal unit to the HORIZ input and the other cable from the space terminal to the V. AMP. INPUT of the monitorscope, as illustrated in Figure 7.
- (2) Set the front panel controls as described in the initial adjustment procedures. Then set the V. AMP. INPUT to V. AMP. and the SWEEP FREQ to EXT. H (RTTY) position. Make sure that the INTENSITY control is set as low as possible to protect the screen when no signal is applied to the monitorscope.
- (3) The mark and space output of the terminal unit should be adjusted for an equal output when the receiver is properly tuned in. To check the equal output, insert the mark and space signal alternately into the vertical input of the scope and adjust the balance potentiometer of the terminal unit until equal height is obtained.
- (4) After setting the balance potentiometer for equal output as described above, adjust the V. GAIN AND H. GAIN controls for a cross pattern of equal length of horizontal and vertical trace. Once the desired pattern has been set, the gain controls on the monitorscope should not be changed.

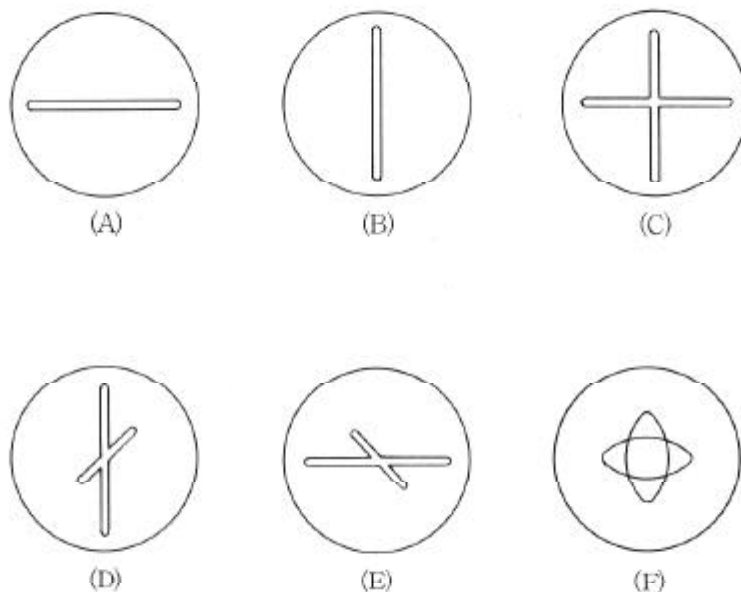

Figure 8

RECEIVER MONITORING

The YO-301 Monitorscope can be used to monitor the receiving signal when it is properly connected to the receiver. The IF signal is applied to the V. AMP IN terminal and MONITOR LEVEL is set to V. AMP position.

FOR FT-301:

The IF output is provided with Pin 4 of the accessory socket. Pin 6 is connected to ground.

FOR FT-221:

As the IF output is not provided, the following modification is necessary.

- (1) Remove SSB IF unit from its socket.
- (2) Solder the 5 PF ceramic capacitor and a 47 cm length of the coax cable as illustrated in Fig. 9.
- (3) Install coax cable as illustrated in Fig. 10 and 11.
- (4) Disconnect wire from ALC connector and use the terminal for IF output.
- (5) Solder the coax cable to the ALC connector and solder the 100K ohm 1/4W resistor between ALC terminal and ground.

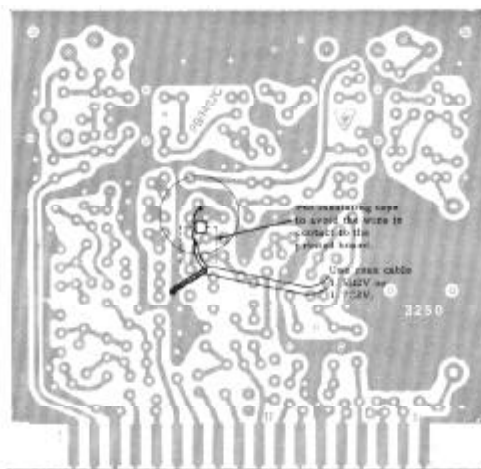
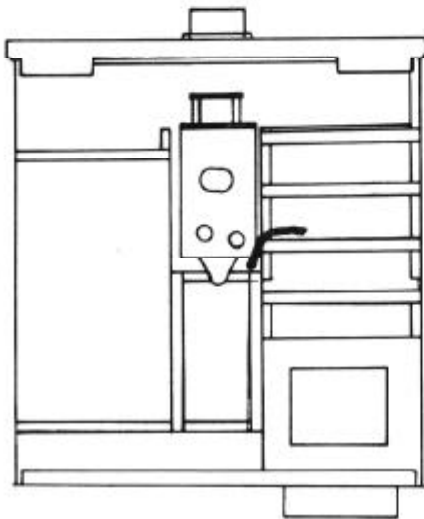
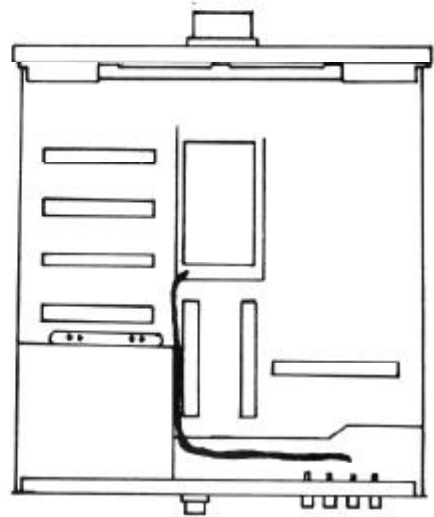

Figure 9



TOPVIEW

Figure 10



BOTTOM VIEW

Figure 11

FOR FT-101:

An IF out connector is provided with this model, however, the IF output from this connector is not sufficient for YO-301, therefore, requiring the following modification.

- (1) Remove PB-1183 from its socket.
- (2) Solder the 5 PF capacitor and coax cable as illustrated in Fig 12.
- (3) Reinsert the PB-1183 to its socket.
- (4) Disconnect the coax cable from the IF out connector and solder the other end of the coax cable installed in Step (2). Solder the outer conductor of the coax cable to ground.
- (5) Solder the 100K ohm 1/4W resistor between the inner and outer conductors of the cable at the connector.
- (6) Peak T109 after above modification.

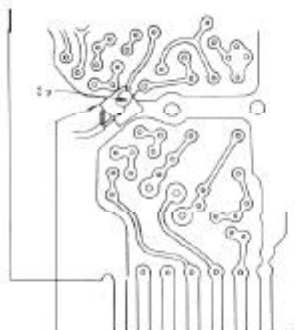

Put insulating tape to avoid the wire to contact to the printed board.

Figure 12

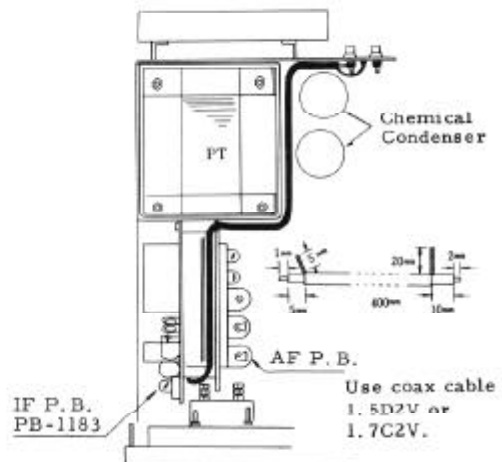

Figure 13

FOR FR-101:

- (1) Locate the IF printed board, PB-1251, and solder the 5 PF capacitor and coax cable as illustrated in Fig 14
- (2) Install the coax cable as illustrated and solder the other end of the coax cable to AUX connector on rear panel.
- (3) Solder the 100K ohm 1/4W resistor between the inner and outer conductors of the coax cable at the AUX connector.
- (4) Peak T119 after the above modification.

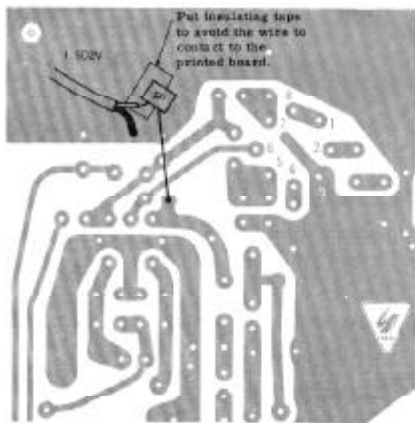

Figure 14

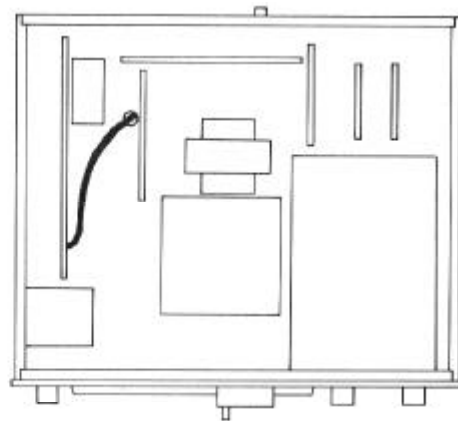

Figure 15

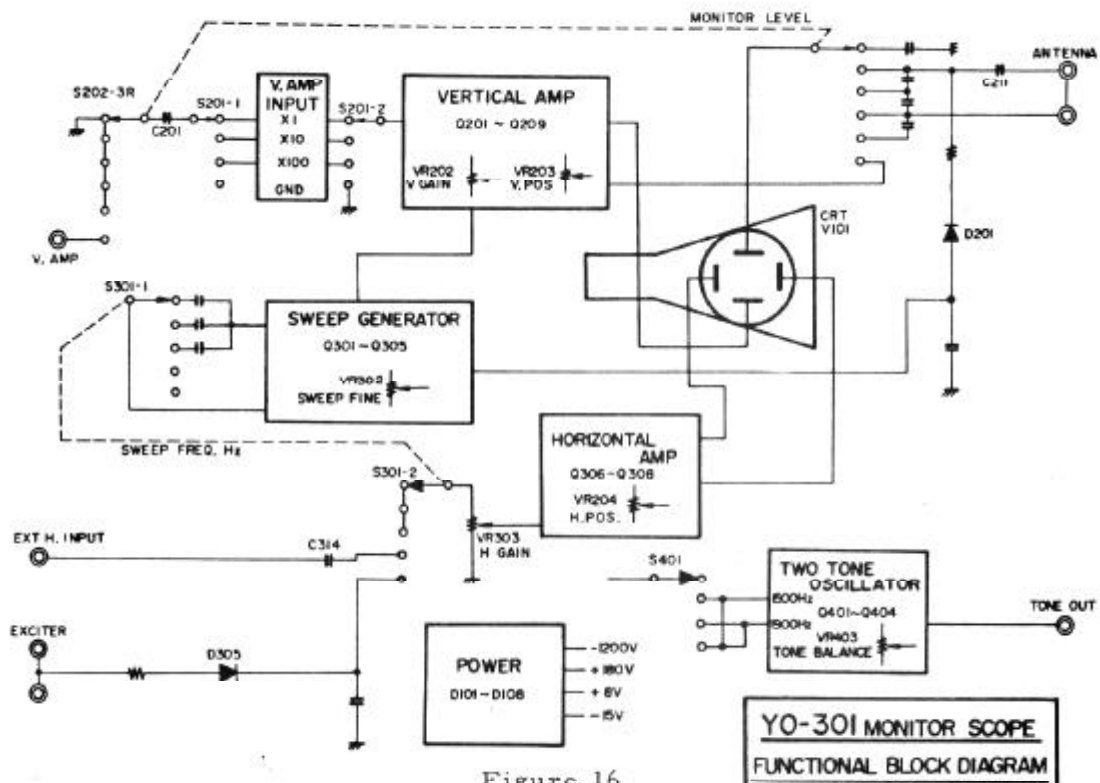

Figure 16

CIRCUIT DESCRIPTION

The block diagram may be helpful in order to understand the performance of the monitor scope.

VERTICAL AMPLIFIER CIRCUIT

The signal applied to V. AMP. IN J201 is coupled through an attenuator S201 and V. GAIN potentiometer to the high input impedance amplifier, Q202, 2SK30AY from which the signal is delivered to the following stage at low impedance. Q201 and Q203, 2SC372 O, work as a protecting circuit for large input voltage by clipping the signal peaks.

The output from Q202 is then applied to a differential amplifier consisting of Q204 and Q205, 2SC1215 which converts the input signal to balance output to be delivered to the following push-pull buffer amplifiers, Q206 and Q207, 2SC372 O. The signal is further amplified by a vertical amplifier Q208 and Q209, 2SC1514 and then fed to vertical deflection electrodes, Y+ and Y-.

HORIZONTAL AMPLIFIER CIRCUIT

The horizontal signal selected by the SWEEP FREQ switch S301 is applied through H. GAIN potentiometer, VR303 to amplifier Q306, 2SK30AY which converts the high input impedance to low output impedance. The output is amplified by a horizontal amplifier Q307 and Q308, 2SC1514 and then fed to the horizontal deflection electrodes X+ and X-.

SWEEP CIRCUIT

A multivibrator consisting of Q304 and Q305, 2SC372 O produces a saw-toothed sweep signal at the emitter of Q305. The saw-toothed sweep signal is amplified by Q302 and Q303, 2SC372 O and then fed through SWEEP FREQ switch S301 to the horizontal amplifier.

The sweep frequency covers 100 Hz to 10 kHz continuously by SWEEP FREQ switch and SWEEP FINE control. A portion of the vertical signal is fed to a buffer amplifier Q301, 2SK30AY of which the output signal is used for synchronization of the sweep frequency.

TWO TONE GENERATOR CIRCUIT

The Wien-bridge oscillator Q402 and Q404, 2SK30AGR oscillate 1900 Hz and 1500 Hz sine wave respectively. The bias voltage is stabilized by Q401 and Q403, 2SA733P and the output level is set to the same value by TONE BALANCE control VR403.

The signal is fed to a buffer amplifier Q405, 2SC373 and the signal level is set by TWO TONE LEVEL control VR404.

TRANSMITTER MONITOR CIRCUIT

A portion of the transmitter power is sampled through C211 from the feed line when the transmitter's antenna feed line is connected to the ANTENNA connectors of the monitorscope. The sampled RF voltage is applied through a MONITOR LEVEL switch S202 to the vertical deflection plate in order to obtain proper height on the display screen. Since the input circuit is untuned, the monitorscope can be used up to 100 MHz, however, some distortion of the pattern may be observed when used on 144 MHz band.

The RF voltage is detected by an envelope detector, D201, 1N60 and used to synchronize the sweep generator for a stable display of the signal.

When the exciter output is fed through the EXCITER terminals to a linear amplifier and the output of the linear amplifier is fed through the ANTENNA connectors to the antenna, a portion of the exciter signal is detected by the envelope detector D305, 1N60 and fed through the horizontal input selector switch to the horizontal deflection plate. The output of the linear amplifier is fed to the vertical deflection plate displaying the trapezoidal pattern in order to check the linearity of the linear amplifier.

POWER SUPPLY

The power transformer has two primary windings for the selection of various AC supply voltage. Unless otherwise specified, the power transformer is wired for 100 Volts AC operation. The secondary of the transformer has three windings to deliver four different DC voltages and AC heater voltage for the cathode ray tube.

The diodes, D101 through D104, 1S1R150 provide -1200 Volts DC from 470 Volts winding for the CRT in full wave voltage doubler circuit. The 190 Volt winding provides 180 Volts DC with full wave rectifier circuit consisting of D105 and D108, 1S1830 for the vertical and horizontal amplifier.

The D106 and D107, 1DZ61 provide 30 Volts DC for the transistors.

The 30 Volts DC is regulated by a zener diode, D109, RD15FA and D110, RD82FA providing +8 Volts and -15 Volts.

MAINTENANCE & ALIGNMENT

The YO-301 has been carefully aligned and tested at the factory using precise test instruments prior to shipment, and, under normal usage, should only require the usual attention given to any electronic equipment. Service, or replacement of major components, may require substantial realignment, however, under no circumstances should the realignment be attempted unless the operation of the monitorscope is fully understood and the malfunction has been fully analyzed and traced to misalignment. Service work should only be performed by experienced personnel using proper equipment.

W A R N I N G

DANGEROUS HIGH VOLTAGES OF MORE THAN 1200 VOLTS ARE PRESENT, THEREFORE, EXTREME CAUTION SHOULD BE TAKEN WHENEVER MAKING ANY ADJUSTMENT INSIDE THE CABINET. BEFORE REMOVING THE CABINET, UNPLUG THE POWER PLUG FROM THE AC LINE. CHECK THE HIGH VOLTAGES IN THE CAPACITORS BY SHORTING THE HIGH VOLTAGE LINE TO GROUND WITH AN INSULATED SCREWDRIVER.

1. Frequency Response Compensation of Vertical Attenuator (TC201, TC202).

Apply a pure square wave (50 Hz - 5 kHz), to the vertical input and observe the display on CRT. Adjust TC201 for X10 position and TC202 for X100 position until the same wave form as in the X1 position is obtained.



Over Compensation



CORRECT



Less Compensation

Figure 17

2. Vertical Amplifier Balance (VR201).

Wait for 30 minutes after the switch is turned on. Check the position of display when the vertical gain control is widely rotated. If the display moves up or down, then adjustment of the balance is required.

Set V. AMP INPUT switch to GND and V. GAIN control to a fully CCW position. Adjust V. POSITION control to set the display (horizontal line) in the center of the CRT screen.

Rotate V. GAIN control to a fully CW position. If the display moves, adjust VR201 until the display stays at the center of the screen regardless of the V. GAIN control position.

3. Two Tone Generator (VR401 - VR404).

Adjust VR401 and VR402 until a pure, stable sine wave of 1500 Hz and 1900 Hz is available.

The 1900 Hz output voltage is adjusted by VR404 and balanced with the 1500 Hz output voltage by a TONE BALANCE control VR403 on rear panel.

4. Astigmatism (VR101).

This adjustment is only necessary when the CRT is replaced. Set the FOCUS control to 12 o'clock position. Adjust VR101 for sharp focusing.

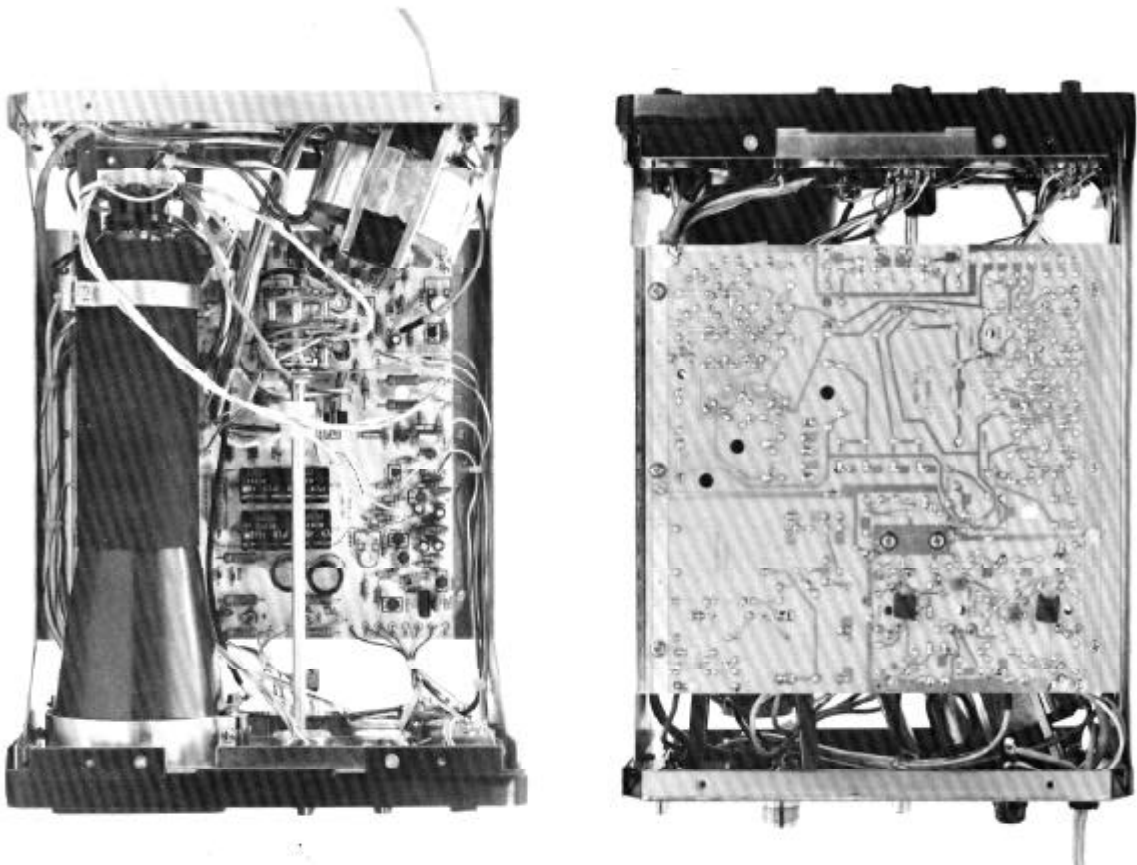

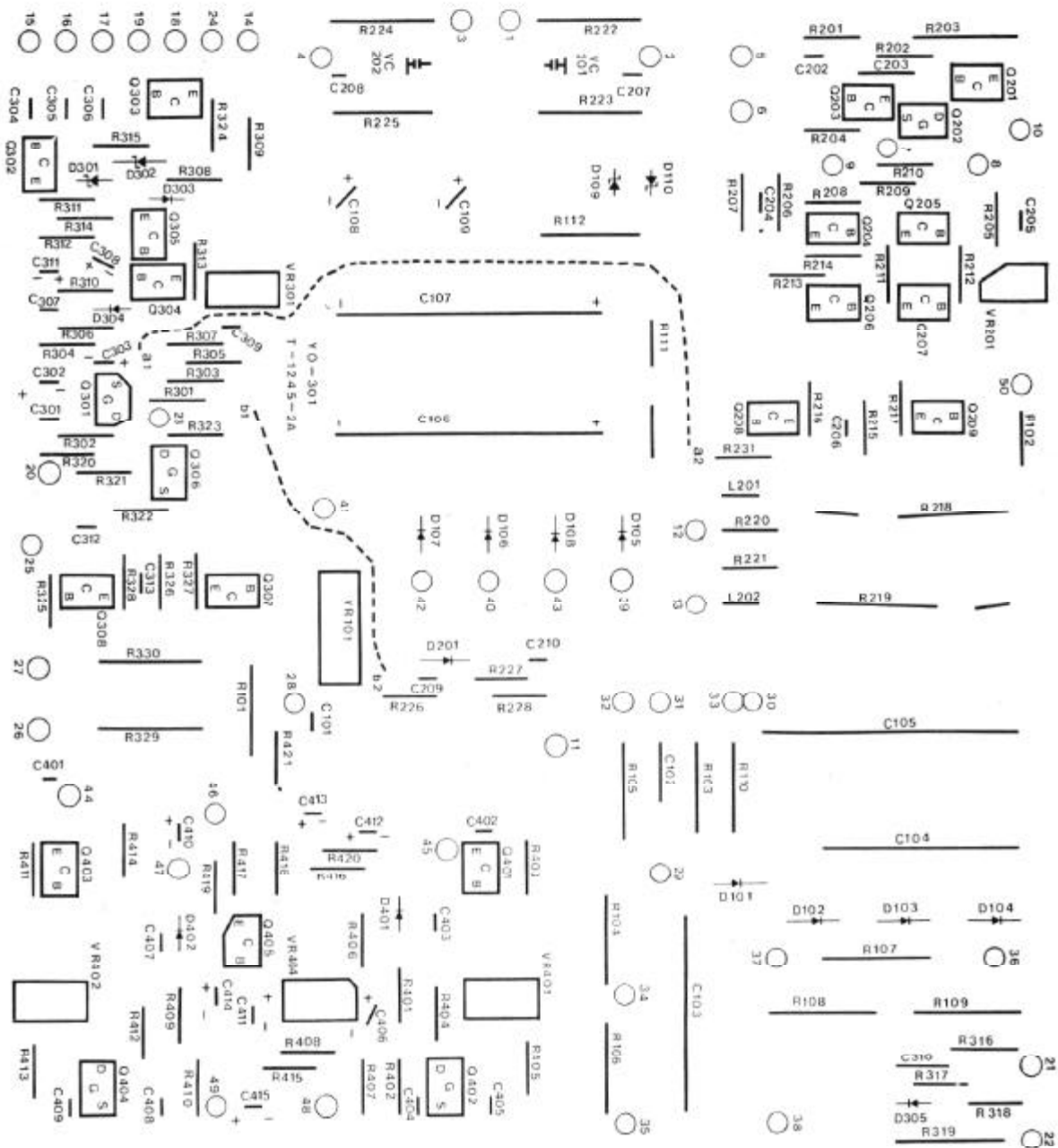
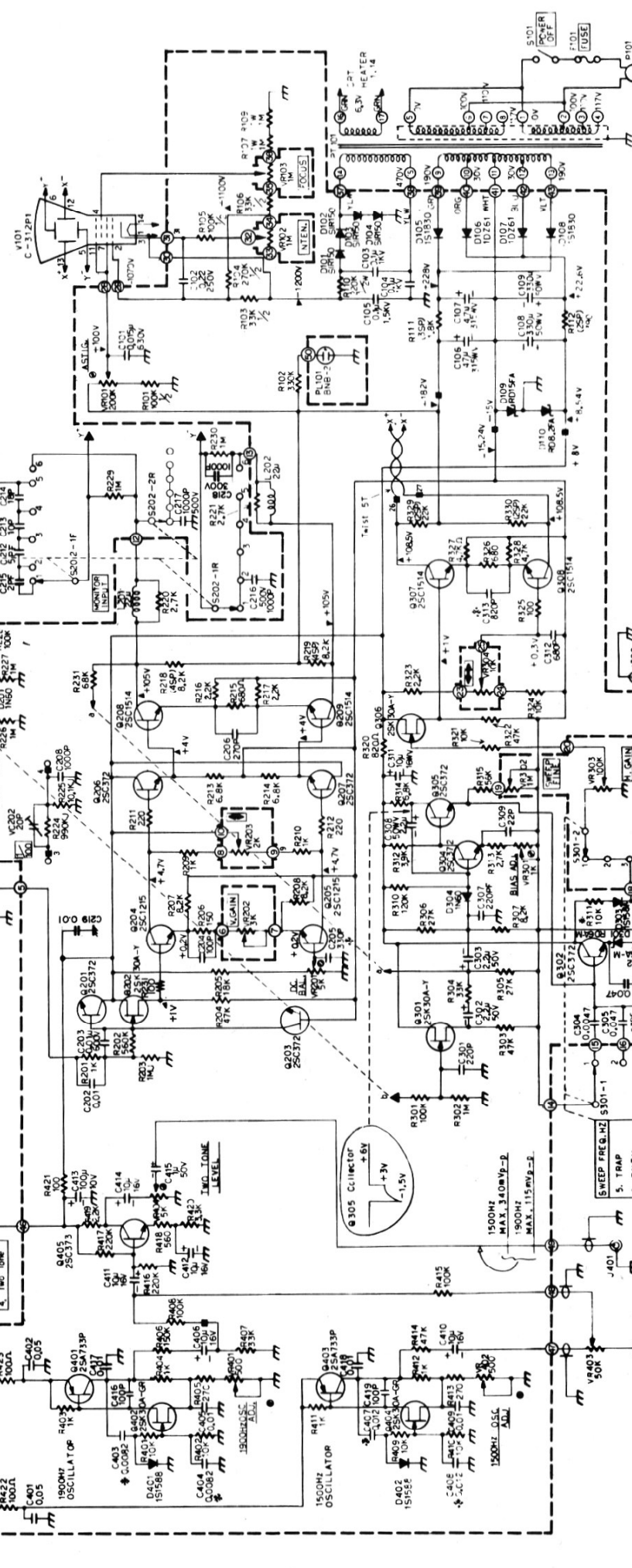
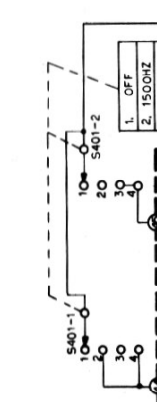
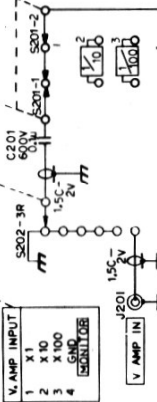
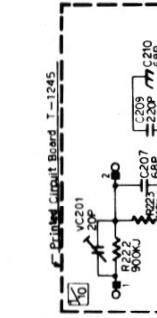
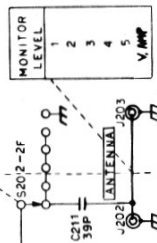

Figure 18

NOTE: PANEL MARKING.
P.C.B.
NOT ON P.C.B.

CAP. μ F P=PF
RES. UNMARKED OHMS. Ω M
FACTORY ADJ.



YO-301
CIRCUIT DIAGRAM

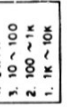

PARTS LIST

PB PRINTED CIRCUIT BOARD		222	½W PYJ	900KΩ
T-1245		224	½W PYJ	990KΩ
		203	½W PYJ	1MΩ
V CATHODE RAY TUBE				
101	C312P1	317	1 W PSJ	47KΩ
		107	1 W PSJ	1MΩ
Q FET & TRANSISTOR		109	1 W PSJ	1.2MΩ
402, 404	FET 2SK19GR			
202, 301, 306	FET 2SK19Y			
401, 403	Tr 2SA733P	METALIC FILM		
201, 203, 206, 207	Tr 2SC372O	112	2 W	390Ω
302-305		329, 330	2 W	22KΩ
405	Tr 2SC373	111	3 W	1.8KΩ
204, 205	Tr 2SC1215	218, 219	4 W	8.2KΩ
208, 209, 307, 308	Tr 2SC1514			
VR POTENTIOMETER				
D DIODE		401, 402	V10K8-2-2	500Ω
201, 304, 305	Ge 1N60	301	V10K8-2-2	1KΩ
106, 107	Si 1DZ61	201, 404	V10K8-2-2	5KΩ
303, 401, 402	Si 1S1588	403	V16L4N10SB	50KΩ
105, 108	Si 1S1830	101	V18K3-2B	200KΩ
101-104	Si 51R150	203	V24L5N20KC-B	2KΩ
301, 302	Zener RD6A-M	202	V24L5N20KC-C	3KΩ
110	Zener RD8.2FA	304	V24L5N20KC-B	10KΩ
109	Zener RD15FA	303	V24L5N20KC-B	100KΩ
		302	V24L5N20KC-B	1MΩ
		102, 103	V24L5N 8×10 20KC-B	1MΩ
R RESISTOR				
CARBON FILM				
231, 325, 421-423	¼W	100Ω		
206	¼W	150Ω		
211, 212	¼W	220Ω		
405, 413	¼W	270Ω		
418	¼W	560Ω		
215, 326	¼W	680Ω		
320	¼W	820Ω		
201, 209, 210	¼W	1KΩ		
403, 404, 411, 412				
216, 217, 323, 419	¼W	2.2KΩ		
313	¼W	2.7KΩ		
220, 221, 420	¼W	3.3KΩ		
312	¼W	3.9KΩ		
327, 328	¼W	4.7KΩ		
213, 214, 314	¼W	6.8KΩ		
207, 208, 307, 309	¼W	8.2KΩ		
311, 317, 318, 321, 324	¼W	10KΩ		
401, 402, 409, 410				
205	¼W	18KΩ		
305, 305	¼W	27KΩ		
304, 407	¼W	33KΩ		
204, 303, 322, 414	¼W	47KΩ		
315	¼W	56KΩ		
231, 308	¼W	68KΩ		
228, 301, 316, 408, 415	¼W	100KΩ		
310	¼W	120KΩ		
406	¼W	150KΩ		
416, 417	¼W	220KΩ		
102	¼W	330KΩ		
202	¼W	560KΩ		
226, 227, 302	¼W	1MΩ		
C CAPACITOR				
DIPPED MICA				
		209, 301, 307	50WV	220PF
		206	50WV	270PF
		205	50WV	330PF
		215	500WV	2PF
		212	500WV	5PF
		213	500WV	10PF
		214	500WV	18PF
		309	500WV	22PF
		211	500WV	39PF
		207, 210	500WV	68PF
		204, 416, 419	500WV	100PF
CERAMIC DISC				
		219, 405, 409, 417, 418	50WV	0.01μF
		315, 401, 402	50WV	0.05μF
		216, 217, 218	500WV	0.001μF
MYLAR				
		208, 403, 404, 407, 408	50WV	0.001μF
		304	50WV	0.0047μF
		*403, 404	50WV	0.0082μF
		202	50WV	0.01μF
		407, 408	50WV	0.012μF
		305	50WV	0.047μF
STYROL				
		310	50WV	470PF
		312	50WV	680PF
		*313	50WV	820PF
METALIZED FILM				
103, 106	½W PSJ	33KΩ		
101, 105	½W PSJ	100KΩ	306	100WV 0.47μF
110	½W PSJ	220KΩ	102, 314	250WV 0.22μF
104	½W PSJ	270KΩ	203	630WV 0.01μF
229, 230	½W PSJ	1MΩ	101	630WV 0.15μF
			201	630WV 0.1μF
225	½W PYJ	10.1KΩ		
223	½W PYJ	110KΩ	ELECTROLYTIC	

