

# *FS* 246 KEY SYSTEM

## INSTALLATION AND OPERATION MANUAL

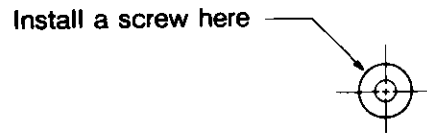

**Southwestern Bell  
Freedom Phone®**

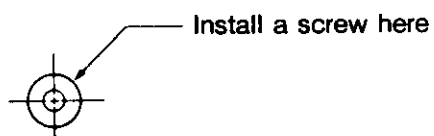
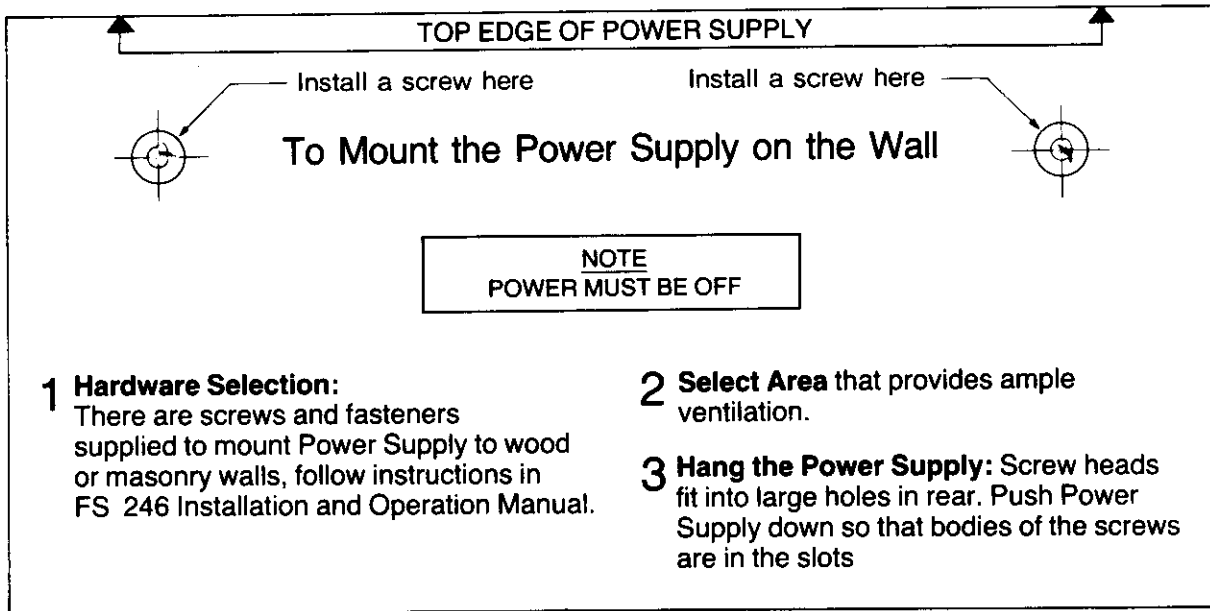

CLEARANCE LINE

## TO MOUNT THE KSU ON THE WALL

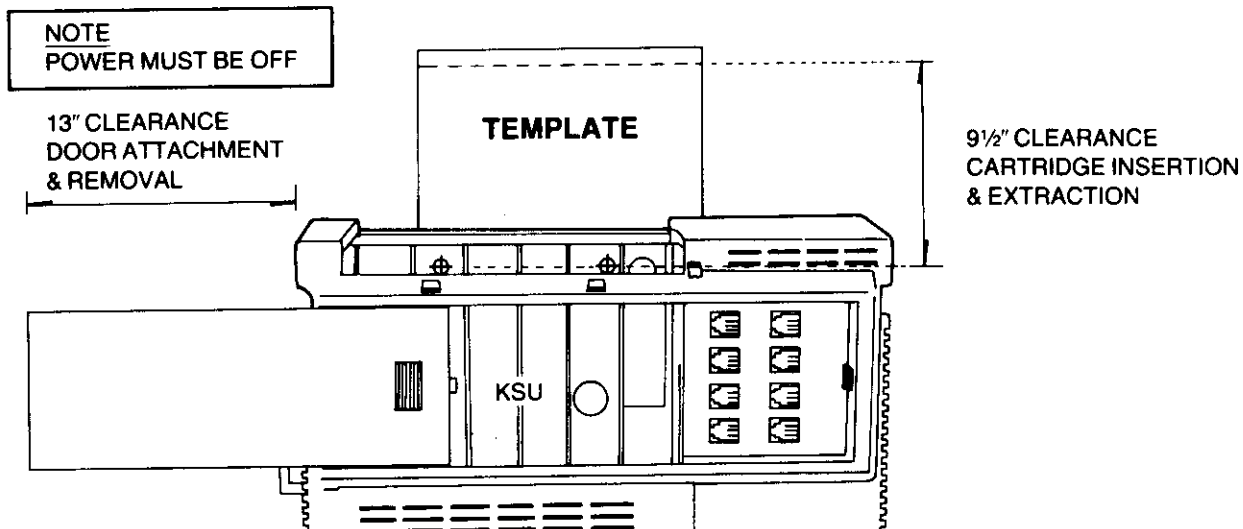

- 1 Hardware Selection:**  
There are screws and fasteners supplied for mounting to dry wall, plaster, wood or masonry walls.

- 2 If Mounting on Dry Wall or Plaster:**  
Be sure to follow mounting instructions as specified in FS 246 Installation and Operation Manual.

- 3 Attach the KSU to the Wall:**  
Hang the KSU (screw head into large opening of slot). Push the KSU down, then a little to the right and down again.

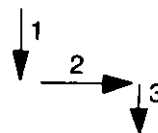

TOP OF KSU

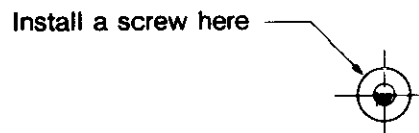
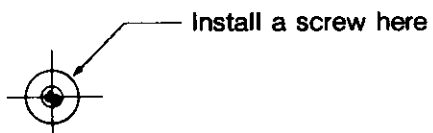

— FS 246 —  
KEY SYSTEM

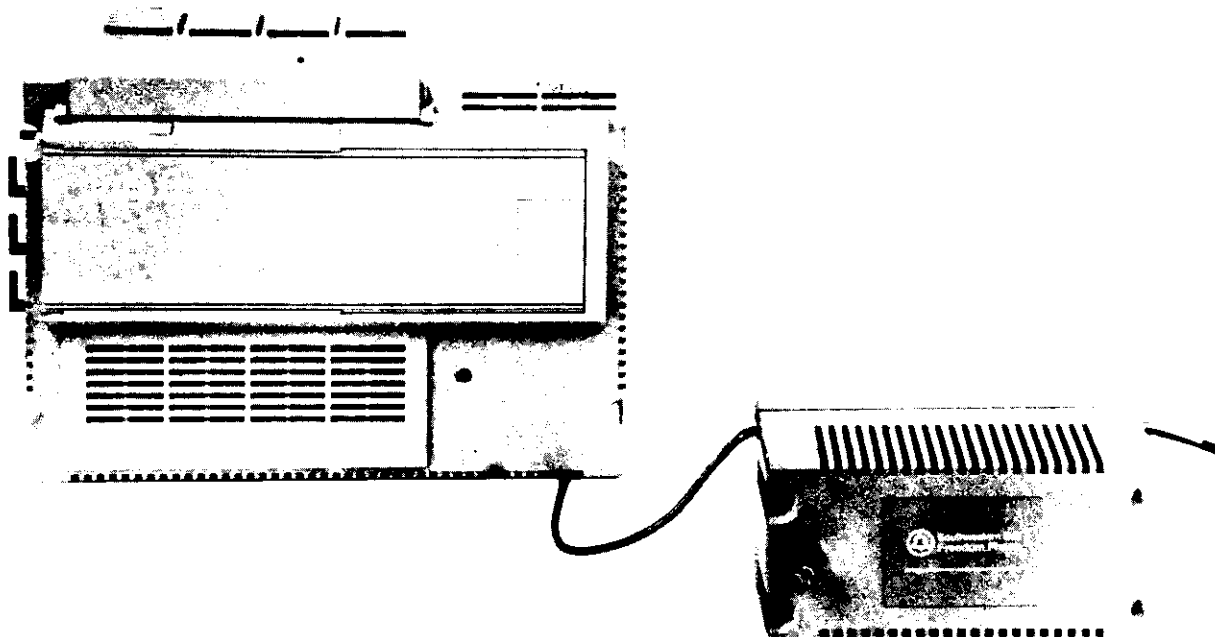

SOUTHWESTERN BELL TELECOMMUNICATIONS, INC.  
FREEDOM PHONE DIVISION  
7442 SHADELAND STATION WAY  
INDIANAPOLIS, IN 46256-3925

# **KSU INSTALLATION AND OPERATION MANUAL**

## **THIS MANUAL SHOULD BE READ COMPLETELY BEFORE INSTALLING AND OPERATING THIS SYSTEM.**

This KEY SERVICE SYSTEM will not only fill all your present needs, but can be expanded to take care of your future requirements as well. As you read this MANUAL, you will realize that you have a multitude of functions at your fingertips. In order to take advantage of these useful features, learn to operate this system by following all the instructions printed here and in the OWNER'S MANUALS of the STATIONS and CARTRIDGES that you may buy.

## **TABLE OF CONTENTS**

<b>GLOSSARY</b> .....	2
<b>INTRODUCTION</b> .....	3
<b>FCC WANTS YOU TO KNOW</b> .....	4
<b>RADIO FREQUENCY INTERFERENCE</b> .....	4
<b>FEATURES</b> .....	5
<b>UNPACKING</b> .....	7
<b>INSTALLATION</b>	
YOU WILL NEED THESE ITEMS BEFORE YOU INSTALL .....	7
<b>INSTALLATION INSTRUCTIONS</b>	
<b>PRECAUTIONS: SITE PLANNING CHECK LIST</b> .....	8
<b>IF YOU SELECT WALL MOUNTING</b> .....	9
<b>TEMPLATE FOR WALL MOUNTING T 246 POWER SUPPLY</b> .....	10
<b>TEMPLATE FOR WALL MOUNTING FS 246 KSU</b> .....	11
<b>CONNECTING THE FUNDAMENTAL SYSTEM</b> .....	12
<b>STATION CABLING</b> .....	13
<b>OPERATION CHECK</b> .....	14
<b>TRIAL TESTING YOUR KSU</b> .....	14
<b>FS-800 AND FS-900 DIAGNOSTIC TEST</b> .....	16
<b>SYSTEM DIAGNOSTIC TESTING</b> .....	16
<b>FS 900 DIAGNOSTIC DISPLAY CHART</b> .....	17
<b>CONNECT THE KSU TO THE OUTSIDE TELEPHONE LINES</b> .....	18
<b>EXPANDING THE SYSTEM</b> .....	18
<b>INSERTING EXPANSION CARTRIDGES</b> .....	20
<b>OPTIONAL CARTRIDGES WITH ADDED FEATURES</b> .....	21
<b>INSTALLATION OF OPTIONAL FEATURES</b>	
<b>DOOR ANNOUNCER</b> .....	22
<b>EXTERNAL PAGING</b> .....	23
<b>MUSIC ON HOLD</b> .....	24
<b>PROGRAMMING AND TABLES</b> .....	25
<b>PRIVACY &amp; DIALING MODES PROGRAMMING, DIP SWITCH POSITIONS</b> .....	43
<b>PROBLEMS AND SOLUTIONS</b> .....	44
<b>DISPLAY SYMBOL CHART</b> .....	45
<b>BATTERY REPLACEMENT</b> .....	46
<b>CARE AND MAINTENANCE</b> .....	46
<b>REPAIR SERVICE</b> .....	46
<b>LIMITED WARRANTY</b> .....	47

## GLOSSARY

In this manual you may find words you are not familiar with. If you refer to the definitions listed below, you will find it easier to install and operate this system.

1. **CO**—Central Office (OUTSIDE Line) installed by Telephone Company.
2. **KSU**—Key Service Unit is the core of this multi-CO line system
3. **STATION**—Individual telephone operated only by connection to the KSU
4. **BASIC STATION**—Fully featured station
5. **EXECUTIVE STATION**—Fully featured station with speakerphone and digital display.
6. **MASTER STATION**—Station connected to extension No. 20 and has the capability of programming certain features of the system.
7. **CARTRIDGES**—Pre-programmed circuits that add additional capabilities to the system.  
**Note:** See "EXPANDING THE SYSTEM" on page 18 for details of the different types of cartridges available.
8. **DTMF**—TONE Dialing
9. **INTERCOM**—A call placed from one station to another station in the system without using a CO line.
10. **DSS**—Direct Station Selection—One- button INTERCOM connection to any other station.
11. **MODULAR PLUGS**—Molded portion at the ends of wires or cords used to inter-connect the parts of the system when they are plugged into the proper receptacles
12. **TEMPLATE**—Guide to aid in mounting the KSU and the POWER SUPPLY.
13. **AWG**—American wire gauge standards.
14. **FLASH TIME**—Time duration of return to an "ON HOOK" condition using the FLASH button.
15. **DEFAULT**—The KSU contains some preset, factory-programmed features which you can alter according to your needs, through programming.
16. **PBX**—Private Branch Exchange
17. **PABX**—Private Automatic Branch Exchange.

## **INTRODUCTION**

The Freedom Phone full-featured Key Service Unit with its advanced program control configuration allows the user to install the system easily without help of any specialist.

The FS 246 Key Service Unit (KSU) has immediate capability for two (2) outside lines and four (4) stations. The KSU can be easily expanded to handle up to six (6) outside lines and 16 stations by inserting optional cartridges.

Advantages of the system include:

- **Variety of Service Features**

Because of the advanced technology, the FS 246 provides various features with program control.

- **High Reliability**

The system is manufactured and tested under strict quality control standards established by Southwestern Bell Telecom-Freedom Phone.

- **Easy Installation and Maintenance**

Line expansion and additional special features can be easily provided by inserting optional cartridges. All connections are made through standard modular connections.

- **Compact Configuration**

The system is divided in three parts—KSU, station and Power Supply, all of which can be installed on the wall or on the desk anywhere due to the compact and unique design. The separate Power Supply keeps its heat out of the KSU for longer component life.

- **Flexible Programming**

Flexible program control provides addition or reconfiguration of various functions without any wiring.

## **FCC WANTS YOU TO KNOW**

This equipment complies with Part 68 of the FCC rules. On the rear of this equipment is a label that contains, among other information, the FCC Registration Number and Ringer Equivalence Number (REN) for this equipment. You must, upon request, provide this information to your telephone company.

The REN is useful to determine the quantity of devices you may connect to your telephone line and still have all of those devices ring when your telephone number is called. In most, but not all areas, the sum of the REN's of all devices connected to one line should not exceed five (5.0). To be certain of the number of devices you may connect to your line, as determined by the REN, you should contact your local telephone company to determine the maximum REN for your calling area.

If your telephone equipment causes harm to the telephone network, the Telephone Company may discontinue your service temporarily. If possible, they will notify you in advance. But if advance notice is not practical, you will be notified as soon as possible. You will be informed of your right to file a complaint with the FCC.

Your telephone company may make changes in its facilities, equipment, operations or procedures that could affect the proper functioning of your equipment. If they do, you will be notified in advance to give you an opportunity to maintain uninterrupted telephone service.

If you experience trouble with this telephone equipment, the telephone company may ask that you disconnect this equipment from the network until the problem has been corrected or until you are sure that the equipment is not malfunctioning.

This equipment may not be used on coin service provided by the telephone company. Connection to party lines is subject to state tariffs.

## **RADIO FREQUENCY INTERFERENCE**

**WARNING:** This equipment generates, uses, and can radiate radio frequency energy and if not installed and used in accordance with this Installation and Operation Manual, may cause interference to radio communications. It has been tested and found to comply with the limits for a Class A computing device pursuant to Subpart J of Part 15 of FCC Rules, which are designed to provide reasonable protection against such interference when operated in a commercial environment. Operation of this equipment in a residential area is likely to cause interference in which case the user at his own expense will be required to take whatever measures may be required to correct the interference.



# **FEATURES**

**Expandable System** – Designed for one (1) to six (6) telephone lines, connect up to 16 separate stations. Expand with easy-to-install cartridges.

**Attendant Arrangement** – The Master Station (Station #20) has capability for processing incoming calls and programming system features.

**Intercom** – Five (5) simultaneous intercom voice paths with privacy.

**Add-On Conference** – Add a third party to your call in progress.

**Multi-Line Access** – Gives access to more outside lines than might otherwise be available on individual phones.

**Automatic Redial** – Automatically continues to redial a busy number up to 15 times, from any station.

**System Speed Dialing** – 40 telephone numbers can be pre-programmed and are available at each station by a two (2) digit code.

**Call Transfer** – Calls can be easily transferred by any station to another station.

**Privacy On All Calls** – Programmable privacy feature on CO lines. This causes the CO line being used to be unavailable to other stations in the system.

**Mute** – Permits private conversation with those near you while the party at the other end of the line is not able to hear you.

**Night Ring Service** – System can be programmed to select those stations that will receive incoming calls after business hours.

**Paging on Intercom** – You can page from any station on intercom. Your page is heard on the speakers of all stations.

**Do Not Disturb** – Any station can activate this feature to prohibit incoming intercom calls. The caller will receive a busy signal.

**Off-Hook Signalling** – If someone is trying to reach you while you are talking, there will be an audible signal and information on the display in the Executive Station.

**Diagnostic Program** – Various system checks can be displayed on the Executive Station.

**Battery Back-Up** – Memory and Programming is retained even if your power is interrupted for up to seven (7) days.

**Hold** – There are two types of HOLD functions: Universal and Exclusive. Incoming calls can be placed on HOLD for the purpose of originating another call or returning to a previously held line. "Universal Hold" can be disengaged by any station, while "Exclusive Hold" can only be disengaged by the station which originated the HOLD.

**Extended Range from Station to KSU** – Stations can be connected to the KSU for a distance of up to 1,000 feet.

## **FEATURES CONTINUED**

**KSU Storage Versatility** – Wall mount or place on a shelf or table.

**Fully Modular Connectors and Jacks** – Insures easy installation for CO lines and stations.

**Emergency Single Line Telephones** – Two (2) single line phones can be connected to the KSU and are operational during power failure.

**Intercom Mode Selection** – Programmable by each station, allows either ringing or automatic answering.

**Flash Time** – Length of flash time can be programmed by Master Station.

**Flash** – This feature allows you to send a timed hookflash according to PBX or telephone company switching equipment specifications, or to release a call and re-establish dial tone.

**Pulse and Tone Dialing** – Pulse or tone dialing can be individually programmed for each CO line.

**Incoming Ring Volume Switch and Speaker Volume Control** – Both Basic and Executive stations are equipped with Ring Volume Switch and Speaker Volume Control.

**Classes of Station Service** – Programmable control enables you to assign each Station the ability or inability of both answering incoming and placing outgoing calls and to use various features. (Toll restrictions with exceptions, CO line restrictions, private lines, etc.)

**System and Station Tone Dialing Options** – The KSU is programmable to accept individual stations that activate a “burst” tone or individual stations that send a continuous tone as a number key is pressed.

### **NOTE: TONE DIALING (DTMF)**

The stations normally supplied with this system produce a short burst of DTMF tones when the keys are depressed. If you need continuous DTMF tones for special applications, then you can order specially equipped stations. ALL OF THE STATIONS CONNECTED TO THE SYSTEM MUST BE OF THE SAME TYPE.

## **HEARING AID COMPATIBILITY**

The FS 800 and FS 900 are Hearing Aid Compatible and stations can be used with a properly equipped hearing aid.

## **UL LISTED AND FCC REGISTERED**

## UNPACKING

Carefully remove the KEY SERVICE UNIT and its accessories from the shipping carton. If there is any visible damage, do not use the unit. Notify your dealer or shipping carrier immediately.

Keep the shipping carton and packing materials as well as all literature.

The following items are included in this carton:

- |                                |  |
|--------------------------------|--|
| 1 – FS 246 Key Service Unit    | 1 – Template for Wall Mounting FS 246 KEY SERVICE UNIT                           |
| 1 – T 246 Power Supply         | 1 – Template for Wall Mounting T 246 POWER SUPPLY                                |
| 1 – Purchase Registration Card | 4 – Each Screws and Fasteners for FS 246 Key Service Unit and T 246 Power Supply |

For future reference, write in the Serial Numbers below. You will find it on the rear of the KSU, and on the bottom of the POWER SUPPLY.

Model No. FS 246                      Serial No. \_\_\_\_\_

Model No. T 246                      Serial No. \_\_\_\_\_

Purchased from: \_\_\_\_\_                      Date \_\_\_\_\_

## INSTALLATION

YOU WILL NEED THESE ITEMS BEFORE YOU INSTALL THE SYSTEM

Do not attempt to install this Key Service Unit until you have read this Manual completely. Then, prepare the following:

- A. Power Supply
- B. Stations (only FS 800 and/or FS 900 Keysets)
- C. Interconnecting cables, modular cords and modular jack terminal boxes (NOT INCLUDED)  
The interconnecting cable between the KSU jack terminals and the station jack terminals must be 4 wire: 2 pair, twisted at approximately 8 to 10 inches, properly color coded with an outer vinyl jacket.

**NOTE 1:** IF YOU HAVE USED THE SPECIFIED VINYL COATED INTERCONNECTING CABLE AND YOU SEE THE SPEAKER OR MONITOR LED FLASHING, THEN YOU MUST REVERSE THE CONNECTIONS OF THE YELLOW AND BLACK CABLE WIRES TO THE JACK TERMINAL.

**NOTE 2:** See ENCLOSED ACCESSORY BROCHURE listing JACK TERMINALS and other items that may be required for installation.

If you are going to mount this system on a wall, you also need—

- D. Templates for mounting the KSU and Power Supply (INCLUDED)
- E. Anchors and screws for mounting (INCLUDED)
- F. Any tools required for fastening screws

If all of your tools and equipment are on hand, then you are now ready to start installation.

# INSTALLATION INSTRUCTIONS

## PRECAUTIONS: SITE PLANNING CHECK LIST

- \_\_\_\_\_ Select the KSU location to minimize station cable run lengths. DO NOT exceed measurements of 1,000 feet. (Use 24 AWG, 2 pair twisted cable for lengths up to 500 feet and 22 AWG, 2 pair twisted cable for lengths from 500 to 1,000 feet.) The 1,000-foot length is the maximum one-way measurement from the KSU to the station.
- \_\_\_\_\_ Ample air space should be provided for the KSU and the Power Supply since they are convection cooled. DO NOT block the cooling vents located on the top and bottom of the KSU or the Power Supply. Never place anything on top of the KSU or the Power Supply.
- \_\_\_\_\_ Select a wall that is strong enough to support twice the weight of the equipment.
- \_\_\_\_\_ The equipment must be located in a climate-controlled room, not to exceed 120 degrees F or fall below 36 degrees F.  
The equipment location should not be exposed to direct sunlight, high humidity, heat, dust, or strong magnetic fields (such as heavy motors or large copy machines).
- \_\_\_\_\_ Prepare a floor plan for the keyset locations. Include each keyset's intercom number (20–35). Intercom number 20 is the Master Programming station.
- \_\_\_\_\_ Ensure that all wires and cables going to and coming from the KSU and Power Supply are properly routed and kept safely out of the way.
- \_\_\_\_\_ Allow room near the KSU for the external paging amplifier and the external music source, if used. To avoid interference, the music source should be placed 5 to 10 feet (1.5 to 3 meters) away from the KSU.
- \_\_\_\_\_ Make sure there are AC outlets for a music source and a paging amplifier, if they are to be installed. These outlets MUST NOT be on the same circuit as the outlet for the KSU.
- \_\_\_\_\_ Place the KSU and the Power Supply within the range of a 105–132VAC, 15A, single phase, power source. A dedicated outlet is required. Do not use an extension cord.
- \_\_\_\_\_ Be sure to carefully remove the cardboard packing surrounding the memory battery.

You have a choice of either placing the unit flat on a shelf or mounting it on a wall. If your preference is for wall mounting, then as an aid, use the Templates included for both the KSU and the Power Supply installation. It would be easier to set the dip switches (on the side of the KSU) before it is wall mounted. Dip switch diagram and setting instructions may be found on page 43.

## **IF YOU SELECT WALL MOUNTING**

1. Select hardware that will support the system when it is mounted.
2. Place the KSU Template on the wall where you plan on mounting it. Be sure there are no restrictions such as walls, shelves or anything else obstructing the unit.
3. Drive the screws into the wall exactly where it is indicated on the template. Leave enough of the screw extended to hang the KSU on. Slip the KSU over the screw heads and pull down, to the right and down again.
4. For Power Supply, drive the screws into the wall exactly where it is indicated on the template. Slip the Power Supply over the screws and pull down.

**NOTE:** If you select wall mounting, leave at least a 9" clearance above the KSU for insertion and removal of cartridges and a 13" space to the left of the KSU for removal of the sliding door. (see template)

## **INSTALLATION ON DRY WALL OR PLASTER**

**NOTE:** It is necessary for the KSU to be supported if using this method of installation. Please follow the directions below carefully.

1. Obtain a piece of plywood about 11" x 6 1/2" x 1/4".
2. Mount the plywood on the wall using 2 toggle bolts (available at hardware store).
3. Place template for mounting KSU on the plywood.
4. Follow the instructions for "INSTALLATION ON WOOD."

## **INSTALLATION ON WOOD**

1. Use enclosed template to determine the location of the attaching screws.
2. Install screws through the template card and into the wall.
3. Leave 3/16" of the screw exposed to mount the unit.

## **INSTALLATION ON MASONRY**

1. Use the enclosed template to determine the location for the attaching screws.
2. Use a 7/32" masonry drill bit and drill the two holes
3. Insert the plastic anchors and install two long screws.
4. Leave 3/16" of the screw exposed to mount the unit.

# TEMPLATE FOR WALL MOUNTING T 246 POWER SUPPLY

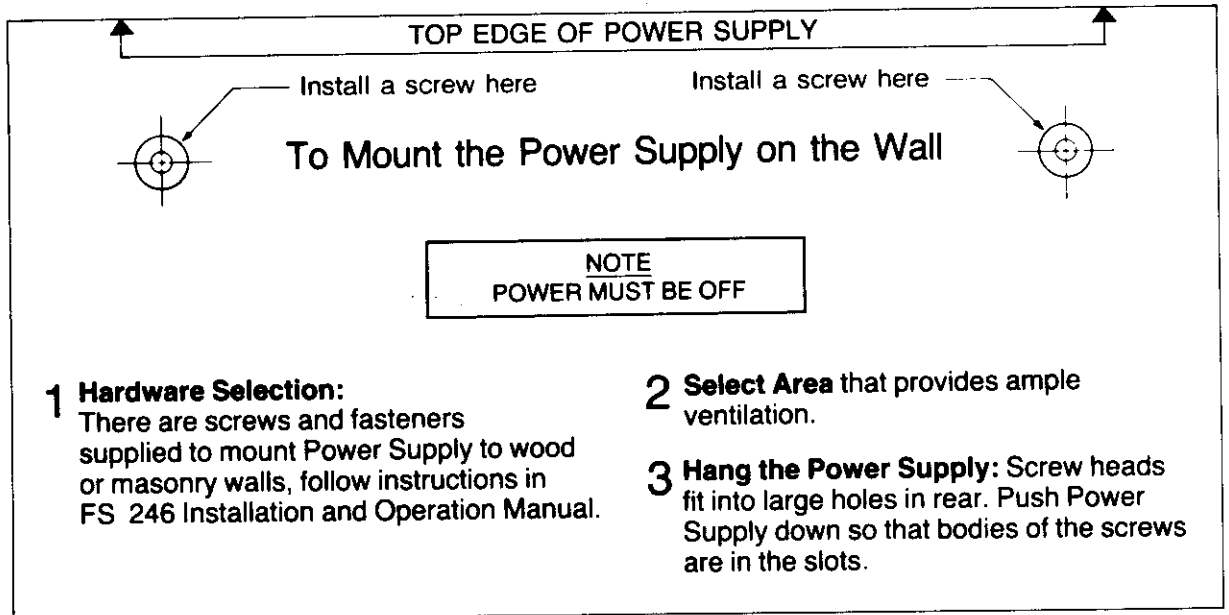

# TEMPLATE FOR WALL MOUNTING FS 246 KSU

## TO MOUNT THE KSU ON THE WALL

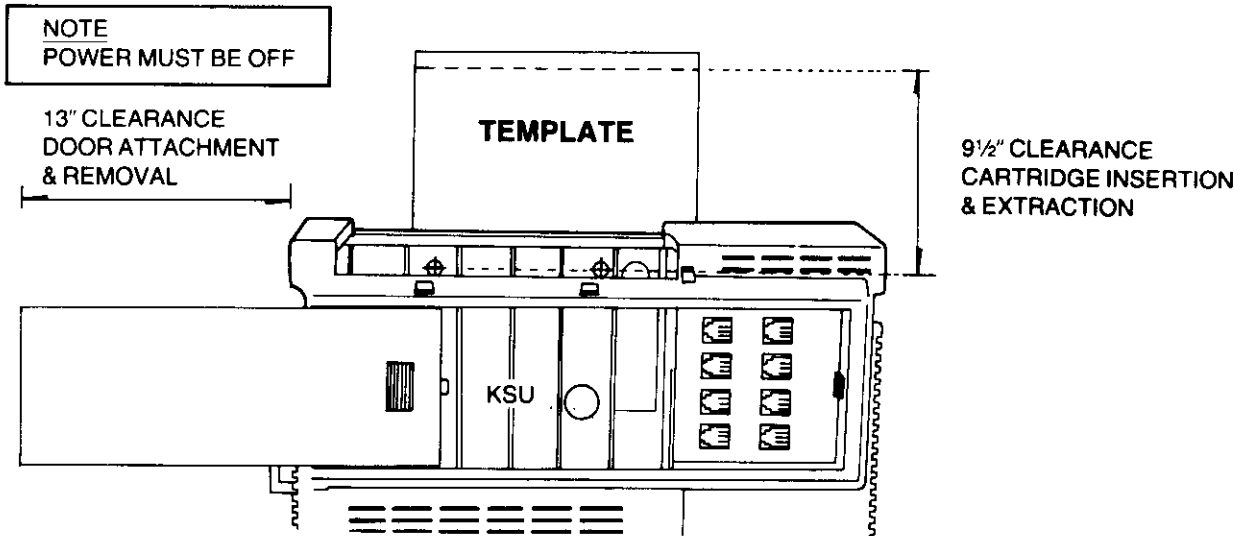

### 1 Hardware Selection:

There are screws and fasteners supplied for mounting to dry wall, plaster, wood or masonry walls.

### 2 If Mounting on Dry Wall or Plaster:

Be sure to follow mounting instructions as specified in FS 246 Installation and Operation Manual.

### 3 Attach the KSU to the Wall:

Hang the KSU (screw head into large opening of slot). Push the KSU down, then a little to the right and down again.

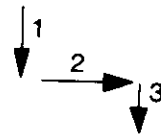

TOP OF KSU

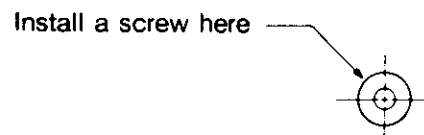
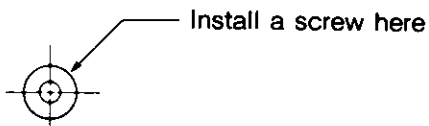

# CONNECTING THE FUNDAMENTAL SYSTEM

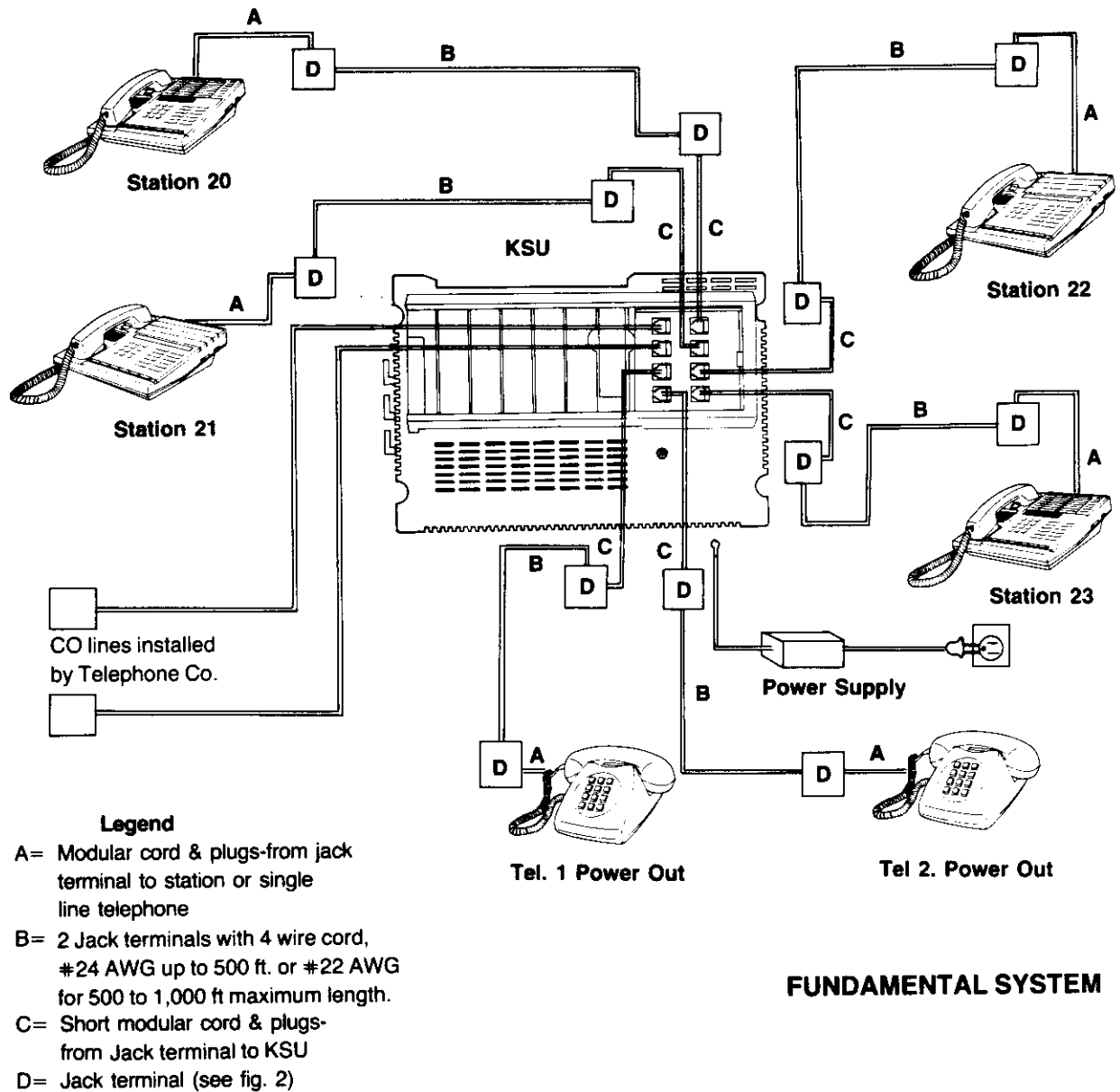

**FUNDAMENTAL SYSTEM**

**FIGURE 1**



## **STATION CABLING**

Using the floor plan in pre-installation planning, run 2-pair (4 wires) twisted cable 24 AWG up to 500 feet or 22 AWG up to 1000 feet from the KSU to each station location. Label both ends of every cable with the station INTERCOM number (20–35). Follow these guidelines when running cable:

1. DO NOT run cables parallel to fluorescent light fixtures or AC lines not in conduit. If these obstacles are unavoidable, run the cable across them at right angles.
2. DO NOT run station cables inside electrical conduit already occupied by AC power cable. To do so is a violation of the National Electrical Code.
3. DO NOT run station cables near equipment with electric motors or past strong magnetic fields (copy machines, heavy motors, arc welding equipment, etc.)
4. DO NOT place station cables where they can be rolled over by office furniture or stepped on.
5. DO NOT allow the total cable length from the KSU jack terminal to each station jack terminal to exceed 1,000 feet.

### **PRE-EXISTING CABLE**

**2 PAIR STRAIGHT or RANDOM TWIST WIRE**—Long runs of this type cabling (25 ft or more) may cause increased background noise or digital crosstalk.

**25 PAIR**—Most older 25 pair is not twisted pairs and will result in increased background noise or digital audio crosstalk. Newer 25 pair with twisted pairs will give satisfactory results. Unused pairs may need to be grounded to keep noise levels down.

DO NOT run external loud bells, klaxon horns or CO Lines on pairs grouped with station wiring.

Connect each station cable at the KSU and at the station as described below. Refer to figure 2 on page 15.

1. Mount the jack terminals for the KSU (D) as close to the KSU as possible.
2. Plug modular cord (C) (up to 14 feet in length) into the KSU.
3. Run the modular cord in front of the KSU and to the left side wire guides. Thread the cords through the wire guides and plug the free end into the jack terminal. (D)
4. Ensure that each station cable is correctly labeled with the station INTERCOM number.
5. The modular cord supplied with each station is 14 feet long. Therefore, the modular jack assembly for the station must be within this distance.

## **OPERATION CHECK**

After all the wiring has been completed:

1. Plug DC power cord from Power Supply into the jack at the bottom of the KSU.
2. Check to make sure that your outlet will accommodate 3 prongs and that one connection is to a connected ground. Plug the AC power cord of the Power Supply into the 120V AC 60Hz, 3 socket receptacle.
3. The red LED on the KSU will turn on indicating power is being supplied to the KSU.
4. SPEAKER (MONITOR) LED will flash for a short time, then go OFF.
5. If any station's SPEAKER (MONITOR) LED flashes continually, it indicates that there may be a wiring error in the connection to that station.  
FIRST REVERSE THE YELLOW AND BLACK INTERCONNECTING WIRES FROM THE CABLE TO THE JACK TERMINAL. If the LED continues to flash, see Problems and Solutions.

## **TRIAL TESTING YOUR KSU**

1. To make a trial OUTSIDE call
  - a. Lift the handset
  - b. After receiving a dial tone, press the key of a line accessible to that extension
  - c. Dial the number
2. To make a trial INTERCOM call
  - a. Lift the handset
  - b. After receiving a dial tone, dial the number of a valid extension you want to call

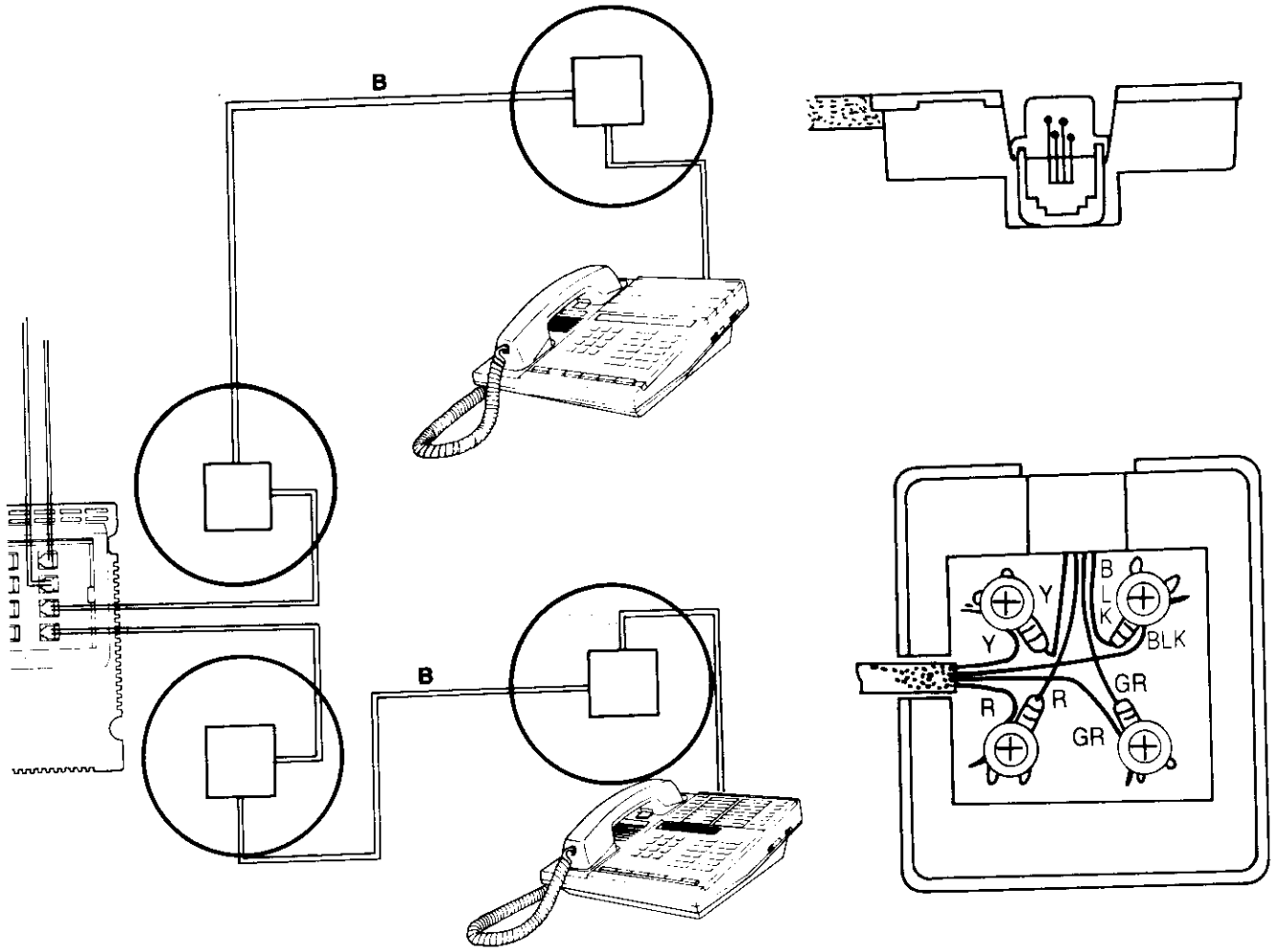

**NOTE:** CONNECT THE WIRES SO THAT COLORS CORRESPOND AS SHOWN IN THIS DIAGRAM. HOWEVER, IF THE SPEAKER OR MONITOR LED FLASHES CONTINUALLY IT MEANS THAT THE WIRING FOR THIS STATION MUST BE CHANGED. TO CORRECT THIS, REVERSE THE YELLOW AND BLACK WIRES FROM THE INTERCONNECTING CABLE TO THE JACK TERMINAL, (YELLOW TO BLACK AND BLACK TO YELLOW) LEAVING THE RED AND GREEN WIRES CONNECTED AS SHOWN.

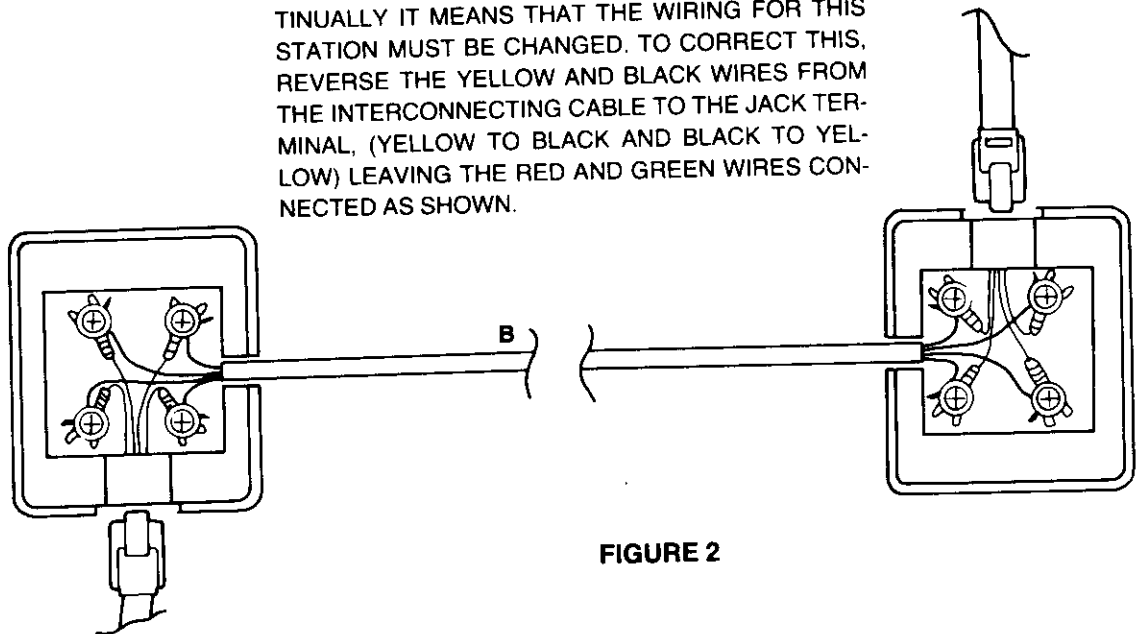

**FIGURE 2**

## FS 800 DIAGNOSTIC TEST

Upon plugging the KSU Power Supply into the outlet, you should observe the following indications if your system is properly connected:

The MONITOR LED will show a RAPID flash until data communication is accomplished between the KSU and the station.

## FS 900 DIAGNOSTIC TEST

Upon plugging the KSU Power Supply into the outlet, you should observe the following indications if your system is properly connected:

- a. The SPEAKER LED will show a RAPID flash until data communication is accomplished between the KSU and the station.
- b. Your display will show 

TEST 0
--------
- c. The display will go blank.

**NOTE:** IF YOU WANT TO KNOW YOUR STATION NUMBER, DO THE FOLLOWING:

- a. Press the \* key.
- b. Press number 4 on the Dial keys. The display will show your station number.
- c. To return to either a blank or time display, press the \* key again.

## SYSTEM DIAGNOSTIC TESTING

After you have tested the stations, you should test the system.

1. TONE and LED test
  - a. Press the \* key and then press the number 5 on the DIAL keys.
  - b. You will hear one ring tone.
  - c. On the FS-900, the display will show 

P-9-5
-------
  - d. All LEDs on the station will FLASH in sequence, beginning with the INTERCOM LED and ending with OUTSIDE Line number 6 LED.
2. FUNCTION TEST  
To perform a system function test and test your station, refer to the chart on the next page.
3. WHEN THIS TEST IS COMPLETE  
Press the \* key twice.

**NOTE:** If you receive a call during the Function Test, it will terminate the test. To reinstate the test, start with Tone and LED test.

# DISPLAY CHART

The chart below is a representation of letters and numbers as they will actually appear on the display of your station at various times.

PRESS THIS KEY	DISPLAY WILL SHOW	
INTERCOM	INTE	
MUTE/DND	DND	
CONFERENCE	CONF	
CALL WAITING	CALL	
CALL TRANS./NRS	TRSF	
SPEAKER	SPER	
SPEED/STORE	SPEED	
AUTO REDIAL	REDIAL	
FLASH	FLASH	
PRIVACY	PH	
TONE/PAUSE	TONE	
HOLD	HOLD	
OUTSIDE LINES 1-6	CO 3	— LINE NUMBER (1 to 6)
SPEED DIAL 1-16	SPD 3	— KEY NUMBER (1-16)
SET TIME	TIME	
AM PM	AMP	
ALARM	ALARM	
DATE	DATE	
DIAL KEYS 0-9	DIG 3	— DIAL KEY NUMBER (0 TO 9)
*KEY	DIG A	
# KEY	DIG b	

## **CONNECT THE KSU TO THE OUTSIDE TELEPHONE LINES**

1. The local telephone company will terminate the OUTSIDE line at a jack terminal. This should be located adjacent to the KSU. There will be one jack terminal for each OUTSIDE line installed.
2. Identify each OUTSIDE line jack with the telephone number, and decide which telephone numbers are to be connected to the KSU lines 1 thru 6.
3. Use a short modular cord sufficient in length to connect the KSU to the OUTSIDE line.
4. Make an OUTSIDE call from one of the stations to make sure the OUTSIDE line is operating properly.

## **EXPANDING THE SYSTEM**

The fundamental FS 246 system (consisting of FS 246 KEY SERVICE UNIT and T 246 POWER SUPPLY) is equipped with 2 OUTSIDE lines and 4 stations. The maximum capacity is 6 OUTSIDE lines and 16 stations.

Expansion cartridges are available to increase the number of OUTSIDE lines by 2 at a time, and to increase the number of station lines by 4 at a time.

Affixed to the rear of the front sliding door is a label with a drawing of correct cartridge placement. (Consult the drawing for proper insertion.)

**NOTE: DO NOT ATTEMPT TO REMOVE OR INSERT CARTRIDGES WITH POWER ON OR TOP AND FRONT DOORS ATTACHED!**

FS 10 STATION CARTRIDGE  
FS 20 LINE CARTRIDGE

<b>LINE CAPACITY</b>	<b>BASIC</b>	<b>MAXIMUM</b>	<b>INCREMENT</b>
C.O. LINE (OUTSIDE) FS 20	2	6	2
STATION FS 10	4	16	4

SEE FIGURE 3 ON NEXT PAGE FOR PROPER SEQUENCING AND LABELING OF CARTRIDGES.

**DISCONNECT AC POWER  
BEFORE INSERTING OR  
REMOVING CARTRIDGES**

**CARTRIDGES MUST ONLY  
BE INSERTED INTO THE  
DESIGNATED SLOTS  
AS SHOWN.**

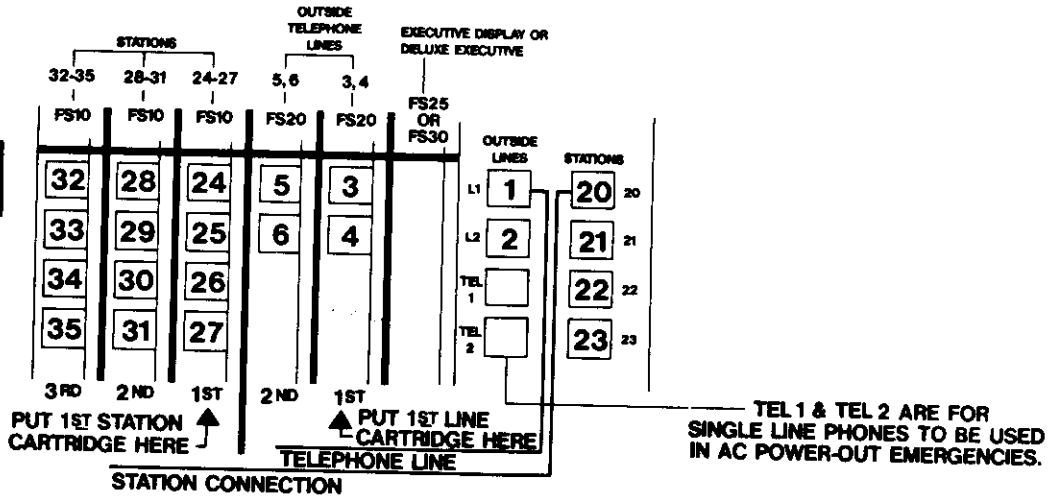

**FIGURE 3**

## INSERTING EXPANSION CARTRIDGES

(1) Remove the slide front door and top cover.

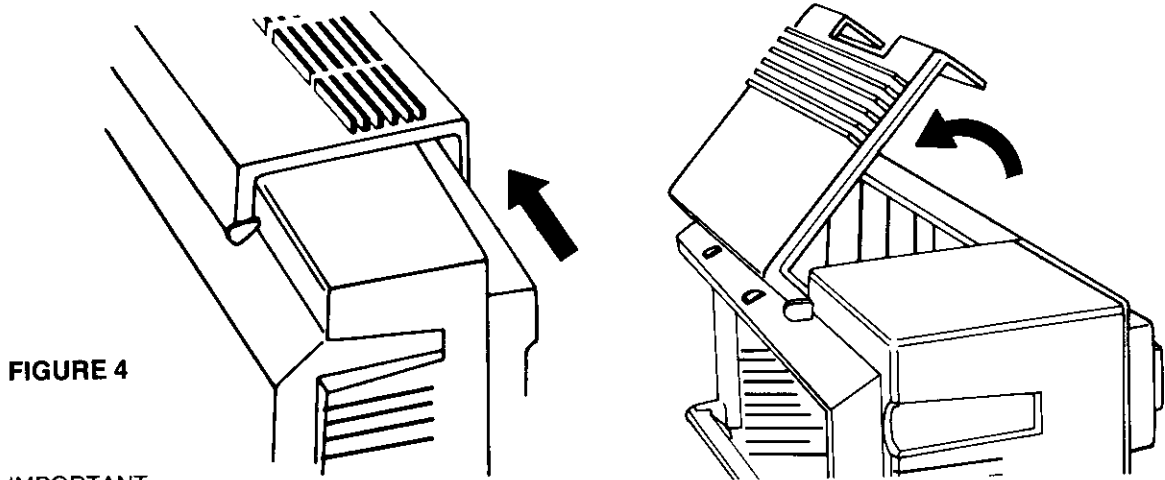

**FIGURE 4**

**IMPORTANT:**

**DO NOT TOUCH THE CONNECTORS ON THE BOTTOM OF THE CARTRIDGE. DO NOT TOUCH THE PC BOARD INSIDE THE KSU WHERE THE CARTRIDGES WILL BE INSERTED.**

### **TO INSERT THE CARTRIDGE:**

- (a) Place it in the proper position, facing as on the sketch, and let it drop down.
- (b) With a little pressure (not a lot), force the cartridge so that it locks on to the PC Board connectors beneath it.
- (c) If it does not lock, you have not made contact and must go through steps (a) and (b) again.

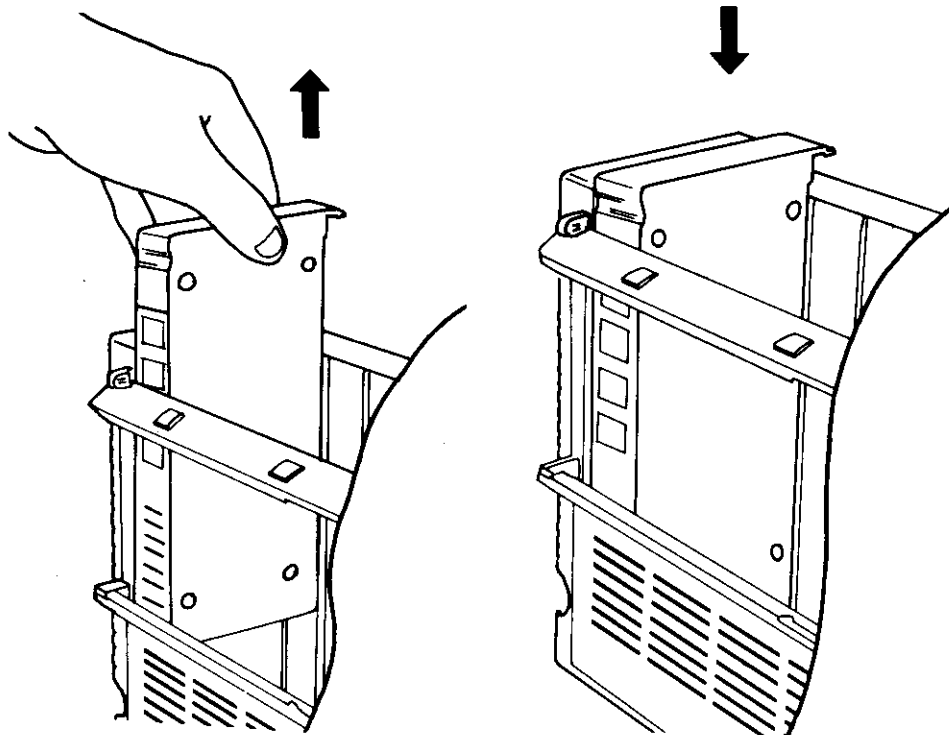

**FIGURE 5**



## **OPTIONAL CARTRIDGES WITH ADDED FEATURES**

FS 25 Executive Display Cartridge—This cartridge gives Real Time Clock feature to all Executive stations (FS 900).  
FS 30 Deluxe Executive Cartridge—In addition to the Real Time Clock feature of the FS 25, this cartridge also has Door Announcer Capability/External Paging and Music-on-Hold feature.

**NOTE:** Only one FS 25 or FS 30 cartridge is required per system.

1. Door Announcer—When coupled with optional Door announcer unit, provides communication between door and any station.
2. External Paging—This feature permits you to page someone or make an announcement through an external paging amplifier system.
3. Music on Hold—Gives you the opportunity to have your choice of music played to the party on any line while that party is on Hold.

**NOTE:** Either Door Announcer feature or External Paging feature can be selected for use. Default is for use of the DOOR ANNOUNCER. To change programming to be able to use the EXTERNAL PAGING feature, see Program #10.

## **OPERATING OPTIONAL FEATURES**

### A. Door Announcer FS 36

1. To adjust the volume level for the Door Announcer, insert and turn a small flat blade screw driver into the smallest hole on the front of the FS 30 Optional Cartridge.
2. For instructions on operating the Door Announcer, refer to the Owner's Manual included with the Door Announcer.

### B. External Paging

**NOTE 1:** Be certain you are programmed to have External Paging available to your station. (see program #10)

**NOTE 2:** Adjust the sound level of the page the same way it is adjusted for the Door Announcer. (see A1 above)

To make Your External Page:

1. Pick up the handset (or press the SPEAKER key of your Executive station).
2. Press the \* key and state your message.
3. To terminate your page message, hang up the handset (or press the SPEAKER key of your Executive station).

### C. Music On Hold

On your receiver amplifier select the radio station you want and tune it in for the best reception you can get.

Adjust the volume on your amplifier.

# INSTALLATION OF OPTIONAL FEATURES

## Door Announcer (figure 6)

Install as shown below using the templates in the Door Announcer Owner's Manual to mount the Door Announcer and Interface Box.

Items required for installation are:

Door Announcer and interface Box (FS 36)

Optional Cartridge (FS 30)

2 Pairs of Twisted Cables

See diagram below for installation

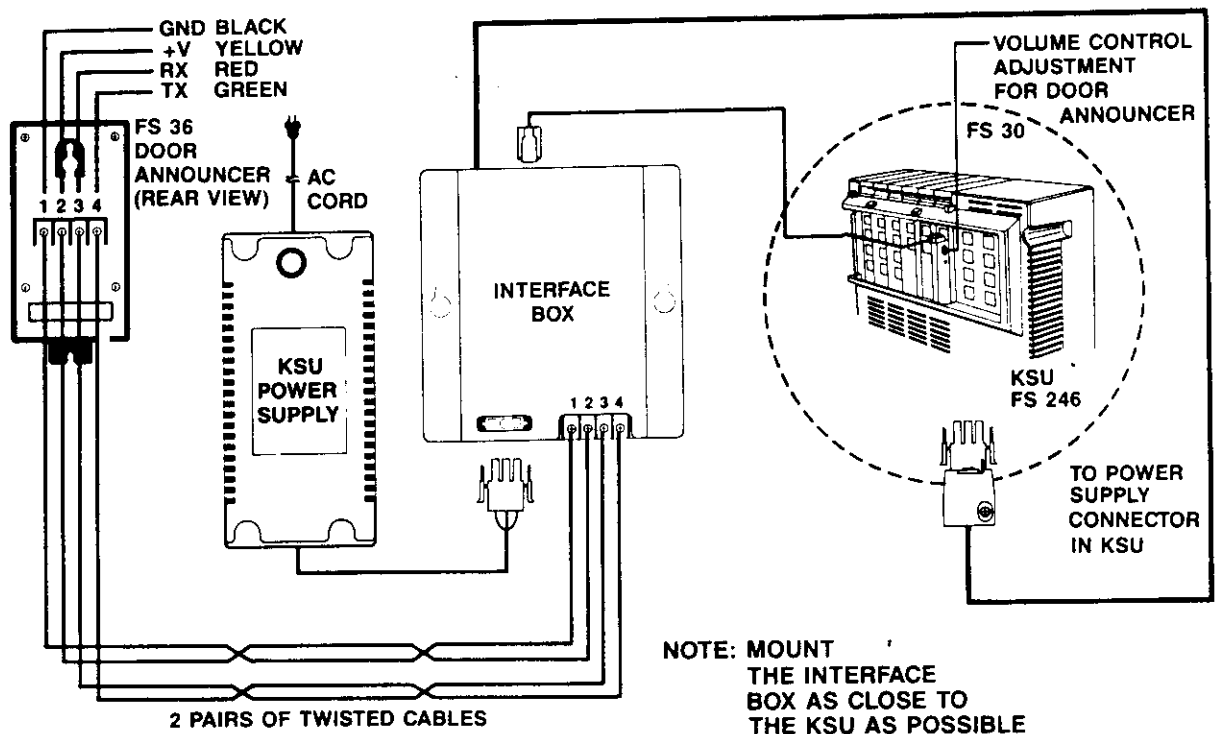
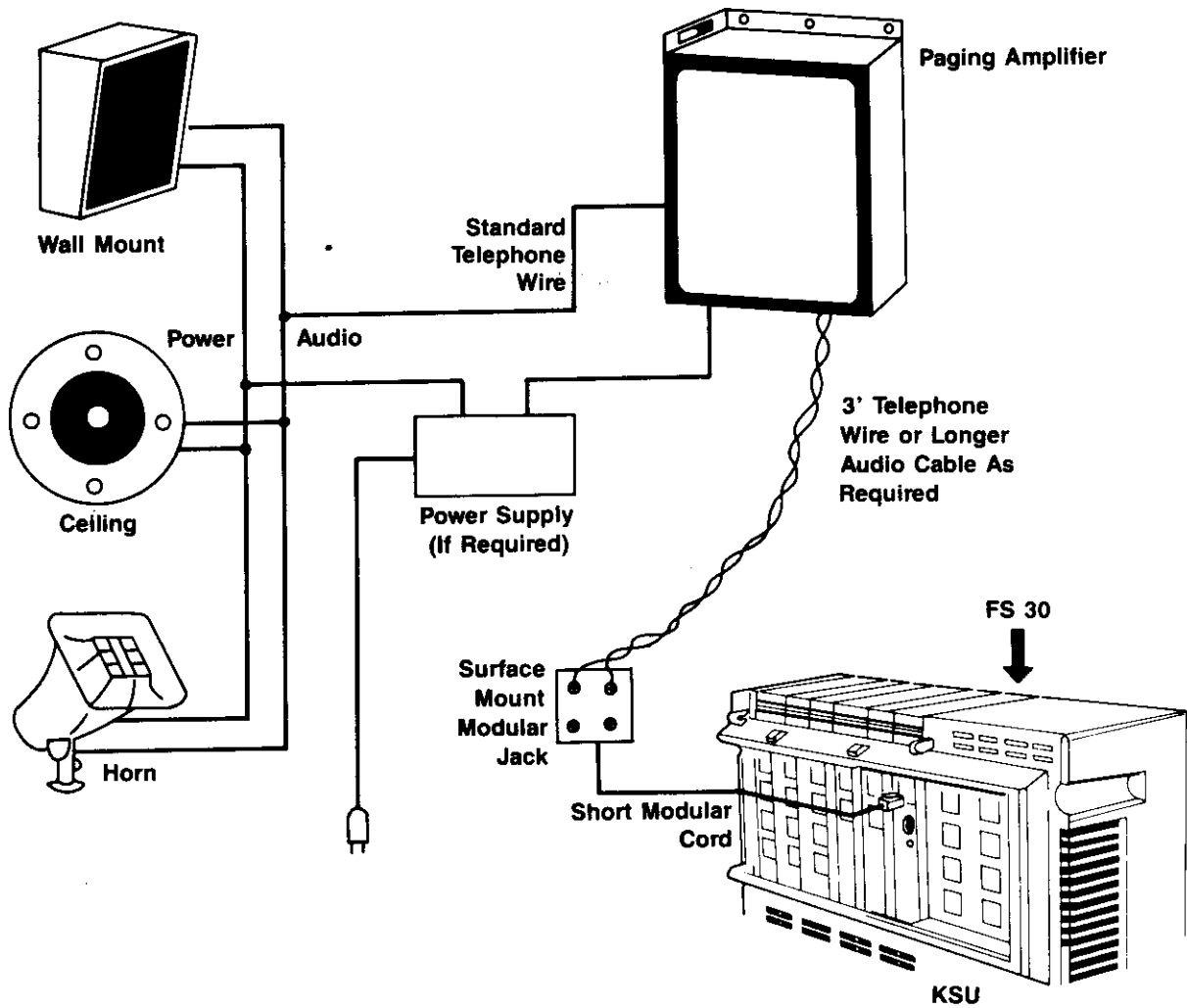

FIGURE 6

## External paging – (one way distributed amplified paging system (figure 7)

To do this you need the following:  
Optional Cartridge FS 30  
Loudspeaker or Loudspeakers  
An Amplifier  
Appropriate Interconnecting Wiring

See sketch below for installation:



**NOTE:** Your hook-up may differ, depending on the external paging equipment.

**FIGURE 7**

**External Paging is Accessed Using \* Key.**

## Music-On-Hold (figure 8)

To activate this feature you need the following:  
Optional Cartridge FS 30  
A Receiver/Amplifier  
Sufficient Audio Cable for connecting

See sketch below for installation:

If the music source requires an antenna locate it well away from the KSU and its wiring

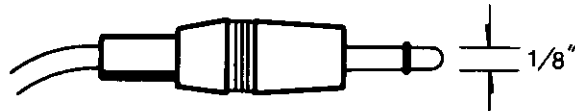
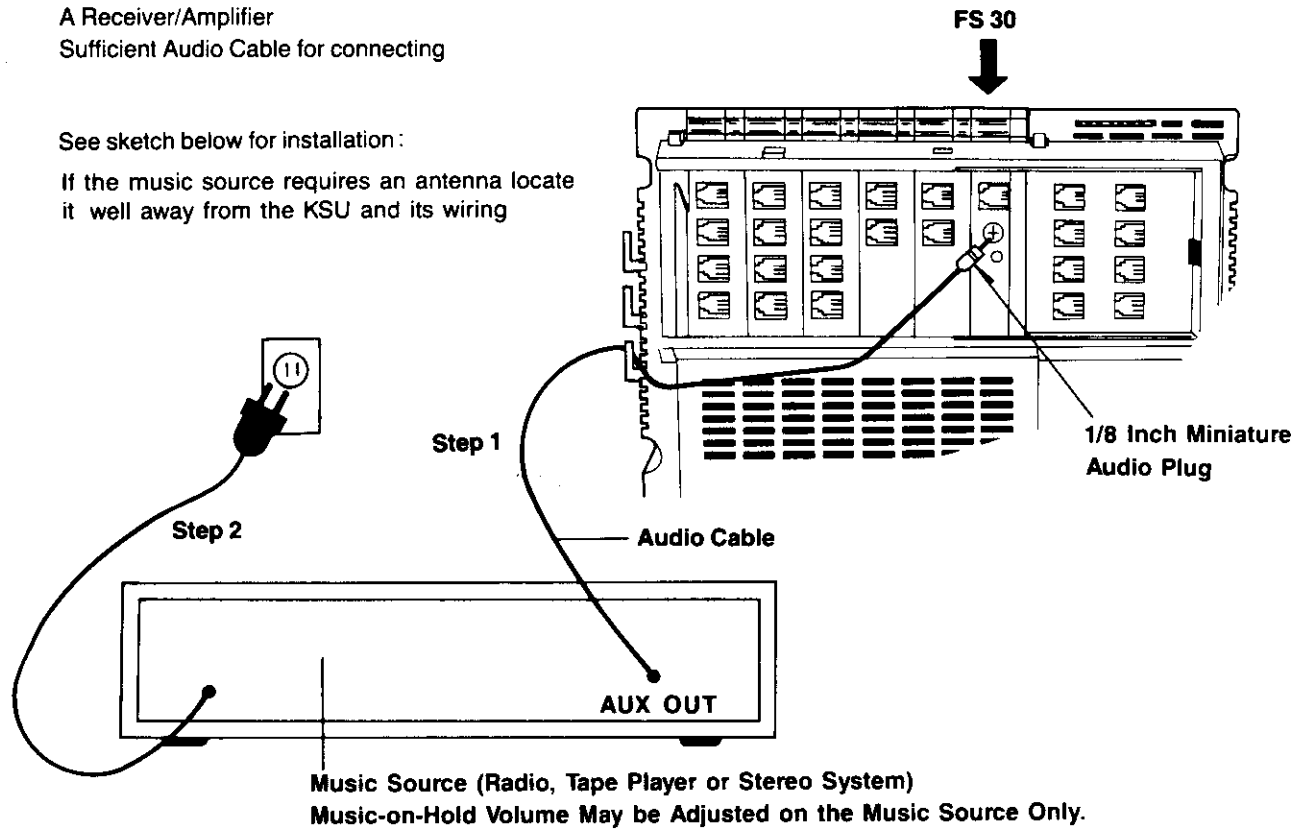

1/8 Inch, Miniature Audio Plug

**NOTE:** The use of OFF-THE-AIR Broadcasts from Radio Stations requires licensing from appropriate agencies. Un-authorized use may subject you to substantial penalties.

**FIGURE 8**

**FS-246**

**— PROGRAMMING —**

# PROGRAMMING AND TABLES

**NOTE 1.** FOR EXPLANATION REGARDING DISPLAY ON DISPLAY-EQUIPPED STATIONS, REFER TO DISPLAY CHART ON PAGE 17.

**NOTE 2.** THE SYSTEM PROGRAMMING CAN ONLY BE DONE BY THE MASTER STATION, WHICH IS THE STATION CONNECTED AS NO. 20. THIS STATION CAN BE EITHER A BASIC OR EXECUTIVE STATION. AN EXECUTIVE STATION IS PREFERRED BECAUSE IT HAS A DISPLAY TO CONFIRM THE PROGRAMMING. THE DISPLAY REFERENCES LISTED BELOW ASSUME YOU ARE USING AN FS 900 STATION .

This section of the Manual provides instructions for programming your System with the capability to operate various features.

The Features in this section can be applied to every station within the Key Telephone System. When you first turn on the System, the features will operate on every station because they have been factory preprogrammed. Whatever features are preprogrammed initially, are known as Default. You may choose to accept them or to change them.

Each description provides you with the program's Default status and the instructions for entering new status.

All new entries must be made at the Master station (#20) and the programming sequence should be followed.

1. Determine your needs and requirements.
2. Follow the programming instructions for each feature and enter the programs on the worksheet in pencil, prior to programming the system.

**NOTE:** You must retain a worksheet with your programming information for several reasons.

- a. As a quick reference sheet to simplify the entry of information during programming.
- b. A permanent record of your system's personalized information base (essentially needed to reprogram the system).

All the new programming must be made only at the Master Key station (#20), when that station is not in use and the handset is in the cradle. Please be aware of the following:

1. When the \* or # key is pressed at the start of programming, the display will show : P†9-

(symbol for programming)

When programming code is pressed, the display will show: P†9- and code number.

And this display status will continue until the programming is completed.

2. When programming is completed, if you are using an Executive station and the Executive Display Cartridge or Deluxe Executive Cartridge is installed, the display will show the time. If not, the display will be blank.
3. Once the programming data is stored it will be protected against power failure.
4. If the programming sequence is completed, the system generates 0.5 seconds of tone confirming the programmed data is stored.
5. If while you are programming, you make an error (the display will show the letter "E"), just repeat the programming procedure to correct it.
6. This Key System will not accept invalid programming instructions and will not permit damage to the program memory. To prevent such an occurrence, if the programming sequence is wrong, the system will stop the programming and generate an error tone signal 4 times and the display will either go blank or show present time if system is equipped with FS 25 or FS 30 optional cartridge.

## Program #1. Time and Date

Time and date are set at the Master station (#20) only and the information is shown on all of the Executive stations in the system. When setting or resetting of either Time or Date is required, always set both Time and Date.

Set Time first, then Date.

**NOTE:** Neither # nor \* keys are used in programming Time and Date.

A: To Set Time:

1. Press the SET TIME key. The display will show: HH - mm

HH = Hours

mm = Minutes

2. Press the Dial keys for the time you want. (4 digits must be entered)
3. Press the AM/PM key for PM setting only.

**Example:** You want to set 2:05 PM

Press: 0 2 0 5 and the AM/PM key.

The display will show: P 2-05

To start time press the SET TIME key again and the displays on all of the FS 900 Executive stations in the system will show the time operating.

B: To Set Date:

**Note:** While you are programming the Date, on the display you will see the month, day and year. Once programming is complete only the month and day will be displayed. Programming the year will automatically accurately adjust the months and days (including leap year).

1. Press the ALARM key. Your display will show: mm - dd - yy

mm = month

dd = day

yy = year

2. Press the DIAL keys for the date you want (6 digits must be entered)

**Example:** You want to set January 2, 1987.

Press: 0 1 0 2 8 7 for 01-02-87

To complete programming and start the Date running, press SET TIME key again.

**NOTE:** To see the date, press DATE key. To go back to Time display, press the DATE key again or wait for a short time. Display will automatically return to Time.

## Program #2. System Speed Dial

This feature allows all stations to dial 40 programmed OUTSIDE telephone numbers using a two digit code (from 10 to 49) for each. Each programmed telephone number is to be no more than 32 digits including pauses.

### A. To Store a telephone Number.

1. Press the SPEED/STORE key. The display will show 
2. On the DIAL keys (12 numeric keys) press the two (2) digit SPEED DIAL code that will correspond to the telephone number you want stored.

The display will show:

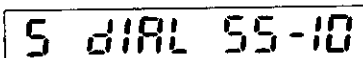

3. Dial the telephone number you wish stored on the DIAL keys. Press the TONE/PAUSE key for each Pause you wish to insert (each pause is equal to one digit).
4. To complete the program, press the SPEED/STORE key.

(Repeat 1 thru 4 for each number to be stored)

**Example:** If you wish to store telephone number 718-555-3654, and the code number is 25:

Press SPEED/STORE key

Press on the DIAL keys:

2 5 7 1 8 5 5 5 3 6 5 4

Press SPEED/STORE key

It is recommended that you list the programming in the appropriate Table prior to actual programming.



**Enter your telephone numbers on Program 2 Table below**

Speed Dial  
Access  
Numbers

Speed Dial Telephone Numbers (Maximum 32 Digits)

10	
11	
12	
13	
14	
15	
16	
17	
18	
19	
20	
21	
22	
23	
24	
25	
26	
27	
28	
29	
30	
31	
32	
33	
34	
35	
36	
37	
38	
39	
40	
41	
42	
43	
44	
45	
46	
47	
48	
49	



**Enter your OUTSIDE Line Access on Program 3 Table below**

Program Entries

0 = Deny Access

1 = Allow Access

**PROGRAMMING INFORMATION**

STATION NUMBERS	PRESS KEY	STATION CODE NO.	CO-1	CO-2	CO-3	CO-4	CO-5	CO-6	PRESS KEY
20	#	10							#
21	#	11							#
22	#	12							#
23	#	13							#
24	#	14							#
25	#	15	1	1	1	1	1	0	#
26	#	16							#
27	#	17							#
28	#	18							#
29	#	19							#
30	#	20							#
31	#	21							#
32	#	22							#
33	#	23							#
34	#	24							#
35	#	25							#

## Program #4. OUTSIDE Line Ringing and Optional Services (Door Announcer and NRS-Night Ring Service-Assignment)

This procedure allows you to program each station to receive or not to receive a ring signal from each OUTSIDE Line from the Door Announcer and from the Night Ring Service.  
 Night Ring Service is the assignment of a station or those stations that will receive a ring signal when there is an incoming call on any of the CO Lines after business hours.

**NOTE:** The DOOR ANNOUNCER signal will ring at the lowest number station programmed to receive the signal successively up to the highest number programmed station providing the programmed stations are busy.  
 If the DOOR ANNOUNCER signal reaches a programmed station that is not busy, but does not answer, the ring signal will continue up to 10 seconds and then it will stop.

DEFAULT-All OUTSIDE Line ringing services in use.

1 1 1 1 1 1                    +    1                    +    1                    =    8 DIGITS  
 6 OUTSIDE LINES                    DOOR ANNOUNCER                    NRS  
 RING SELECTION

- A. To Program each station:
1. Press the # key.
  2. The Stations have 2-digit code numbers as listed in the table below. Use these code numbers for programming. Press the correct code number.

### STATION CODE NUMBERS

<u>STATION</u>	<u>STATION CODE NO.</u>	<u>STATION</u>	<u>STATION CODE NO.</u>
20	30	28	38
21	31	29	39
22	32	30	40
23	33	31	41
24	34	32	42
25	35	33	43
26	36	34	44
27	37	35	45

3. Select ring assignment using "0" for no ring (or no service) and "1" for ring (or service assignment). (See DEFAULT, 8 digit number)

The ring assignment must be entered in the following order:

6 OUTSIDE Line ring selection, Door Announcer and Night Ring Service.

4. Press the # key to complete the program.  
 Repeat steps 1 thru 4 for each station in the system.

**Example:** Station 22 is to receive a ring signal on lines 1 and 3 only. (Use a digit 0 or 1 for each line installed or not.) (see step 3). There is no optional Door Announcer used and the station is to receive Night Ring Service.

Press # key  
 Press 3 2  
 Press 1-0-1-0-0-0-0-1  
 Press # key

**Record the data on Program 4 Table below**

Program Entries

0 = Deny Ringing

1 = Allow Ringing

**PROGRAMMING INFORMATION**

STATION NUMBERS	PRESS KEY	STATION CODE NO.	CO-1	CO-2	CO-3	CO-4	CO-5	CO-6	DOOR ANNCR	NIGHT RING	PRESS KEY
20	#	30									#
21	#	31									#
22	#	32									#
23	#	33									#
24	#	34									#
25	#	35									#
26	#	36									#
27	#	37									#
28	#	38									#
29	#	39									#
30	#	40									#
31	#	41									#
32	#	42									#
33	#	43									#
34	#	44									#
35	#	45									#

## Program #5. Station Calling Restrictions (Class of Service)

This program enables you to designate which station can or can not make local calls and long distance toll calls.

DEFAULT is no restriction.

A. There are three types of Classes available:

Class A – Station is not limited by any restriction. (Class Code No. 2) – (DEFAULT)

Class B – Station is restricted from making long distance toll calls. (Class Code No. 1) – (800 or 1-800 can always be dialed.)

Class C – Station can place no outside calls. (Class Code No. 0) – (911 can always be dialed.)

B. Program Class of Service

1. Press # key

2. Press 2 digit Station Code Number for the stations you are changing the data for.

**NOTE:** The 2 digit Station Code Number must be used when programming.

STATION CODE NUMBERS			
<u>STATION NUMBER</u>	<u>STATION CODE NO.</u>	<u>STATION NUMBER</u>	<u>STATION CODE NO.</u>
20	50	28	58
21	51	29	59
22	52	30	60
23	53	31	61
24	54	32	62
25	55	33	63
26	56	34	64
27	57	35	65

3. Press the Class Code Number for the Class of Service you want for this station.

Not Restricted station – Number 2

Long distance Toll Restricted station – Number 1

Restricted station – Number 0

4. To complete programming, press # key.

**Example:** When programming station 20 for class A, station 21 for class B, and station 22 for class C:

<u>STATION #</u>	<u>NO RESTRICTIONS</u>	<u>LONG DISTANCE TOLL CALLS RESTRICTED</u>	<u>FULL RESTRICTION</u>
20	DEFAULT NO PROGRAMMING REQUIRED		
21		PRESS # KEY PRESS 5 1 1 PRESS # KEY	
22			PRESS # KEY PRESS 5 2 0 PRESS # KEY

**Record the data on Program 5 Table below**

Program Entries  
 Class C = Outgoing Restricted = 0  
 Class B = Local Calls = 1  
 Class A = No Restriction = 2

**PROGRAMMING INFORMATION**

STATION NUMBERS	PRESS KEY	STATION CODE NUMBER	CLASS CODE NUMBER	PRESS KEY
20	#	50		#
21	#	51		#
22	#	52		#
23	#	53		#
24	#	54		#
25	#	55	2	#
26	#	56		#
27	#	57		#
28	#	58		#
29	#	59		#
30	#	60		#
31	#	61		#
32	#	62		#
33	#	63		#
34	#	64		#
35	#	65		#

## **Program #6A . Exceptions to OUTSIDE Call Restrictions**

Three separate 7 digit telephone numbers can be programmed to be available for all stations that have been restricted from making OUTSIDE calls (Class C).

The memory location numbers for the 3 "Exception" telephone numbers are:

- NO. 70 – 1st telephone number
- NO. 71 – 2nd telephone number
- NO. 72 – 3rd telephone number

To Program the stations to be able to dial these three numbers:

1. Press # key.
2. Enter one of the three 2 digit memory location numbers. (70, 71, 72)
3. Enter the 7 digit telephone number you wish to exempt from restrictions.
4. To complete programming, press # key.

Enter all data on Table 6A on following page.

Repeat steps 1 thru 4 for the remaining two (2) telephone numbers you wish to exempt.

**Example:** stations restricted from making local calls can call the fire department at telephone number 123-4567.

1. Press # key.
2. Press 7 0 1 2 3 4 5 6 7.
3. Press # key.

## **Program #6B . Exemption (NPA) to Long Distance Restrictions**

(NPA = Numbering Plan Area) (Memory Location #80)

There are eight different 3 digit area codes that can be programmed to be available for all stations that have been restricted from making Long Distance Toll calls (Class B).

To Program an NPA exception:

1. Press # key.
2. Enter the storage Memory location number 80.
3. Enter 3 digit area codes (as many as you need, up to 8 area codes equalling 24 digits).
4. To complete programming press # key.

Enter all data on Table 6B on following page.

**Example:** If you want to allow stations programmed to Class B restrictions to call numbers in 3 area codes:  
(212,201, and 203)

1. Press # key.
2. Press 8 0 2 1 2 2 0 1 2 0 3.
3. Press # key.



## PROGRAM 6A ENTRIES

PROGRAMMING INFORMATION									
PRESS KEY	MEMORY LOCATION NUMBER	7-DIGIT NUMBER							PRESS KEY
#	70								#
#	71								#
#	72								#

## PROGRAM 6B ENTRIES

PROGRAMMING INFORMATION																								
PRESS KEY	MEMORY LOC#	8 THREE-DIGIT AREA CODES																		PRESS KEY				
#	80																							#

## Program #7. Flash Time (Memory Location #90)

This feature provides to the system (all stations) a programmed time period of flash time once the FLASH key is pressed. The flash time can be determined according to PBX characteristics when the system is installed behind PBX. A choice of three different flash times is available and can be programmed in memory location #90.

FLASH TIME	500 MSEC	FLASH TIME CODE: 0
FLASH TIME	700 MSEC	FLASH TIME CODE: 1
FLASH TIME	1.5 SEC	FLASH TIME CODE: 2

DEFAULT: 700 MSEC FLASH TIME CODE : 1

To Program Flash Time:

1. Press # key.
2. Enter the memory location number 90.
3. Enter the desired flash time code.
4. To complete the program press # key.

**Example:** Flash Time has to be 500 msec:

Press # key.  
Enter 9 0 0.  
Press # key.

PROGRAMMING INFORMATION			
PRESS KEY	MEM LOC #	FLASH TIME CODE	PRESS KEY
#	90		#

0 = 500 mS  
1 = 700 mS  
2 = 1.5 S

## Program #8. Call Transfer (Memory Location #91)

The system can be programmed for one of the two different modes of CALL TRANSFER.

1. The transferred call stays at the station transferred to for 90 seconds, then is dropped if no one answers. If the station is busy, the call will remain on the line until it is answered. (Call Transfer Code 0).
2. If the transferred call is not answered within 45 seconds, the OUTSIDE line will be reconnected to the Call Transfer originator (call Transfer Code 1).

CALL TRANSFER Memory Location is number 91.

DEFAULT: CALL TRANSFER CODE 0

To Program Call Transfer Mode:

1. Press # key.
2. Enter the memory location number 91.
3. Enter either "0" or "1" as you wish.
4. To complete programming, press # key.

PROGRAMMING INFORMATION			
PRESS KEY	MEM LOC #	CALL TRANSFER CODE	PRESS KEY
#	91		#

0 = Stays  
1 = Returns

**Example:** You want to use Call Transfer mode option 2, Call Transfer Code 1.

Press # key.  
Enter 9 1 1.  
Press # key.

## Program #9. Line Exception (Memory Location #92)

This feature is used for all stations that are programmed Class B and C restrictions. (SEE PROGRAM #5.)  
 After you have programmed your stations according to Programs 5 and 6, then you have the option of giving these stations access to one or more designated Outside lines.  
 This programming can be used when the Key Telephone System is installed behind PBX or special Outside line is designated as Tie line.

DEFAULT: All 6 outside lines are restricted: 0 0 0 0 0 0

To retain Line Restriction enter 0.

For exception to Line Restriction enter 1.

To Program Line Exception:

1. Press # key.
2. Enter the program location number 92.
3. Enter either "0" or "1" for each Outside line sequentially.
4. To complete programming press # key.

**Example:** Outside Lines 1 and 3 are line exceptions

Press # key.

Enter 92101000 (for lines 1 thru 6).

Press # key.

PROGRAMMING INFORMATION								
PRESS KEY	MEM LOC #	LINES						PRESS KEY
		1	2	3	4	5	6	
#	92							#

0 = Retain Restrictions

1 = Exception to Line Restrictions

## Program #10. Choice of Door Announcer or External Paging (Memory Location #94)

If you are connecting a Door Announcer, FS 36, you do not use this program—use this program only if you wish to connect External Paging instead of Door Announcer to the FS 30 Deluxe Executive Cartridge.

External Paging enter 1.

To Program:

1. Press # key
2. Enter the program location number 94.
3. Enter 1.
4. To complete programming press # key again.

PROGRAMMING INFORMATION			
PRESS KEY	MEM LOC #	DOOR ANNOUNCE EXTERNAL PAGE	PRESS KEY
#	94		#

0 = Door Announcer  
1 = External Paging

- NOTE 1.** You may want to use a Door Announcer to replace already programmed External Paging. To do this, reprogram by following steps 1 thru 4 above, but enter 0 instead of 1 in step 3. Reprogram those stations you want to receive the DOOR ANNOUNCER signal by following instructions in Program #4, on page 32.
- NOTE 2.** To operate the Door Announcer or External Paging, refer to "Operating Optional Features" on page 21.

## Program #11. Off-Hook Signalling (Memory Location #95)

The system (each station) can be programmed so that a station that is in-use (off-hook) will receive a ring signal from the C.O. Lines for which they have ring assignment when either in-use (an intercom call or other C.O. call) or not in-use.

In the DEFAULT MODE, when a station is off-hook (on an intercom call or a C.O. call) the telephone will not interrupt the user with a ring signal from a C.O. Line which normally has ring assignment. It will only provide a visual indication on the LED located on the C.O. LINE BUTTON.

DEFAULT: NO OFF-HOOK SIGNALLING IN THE SYSTEM

TO PROGRAM FOR NO OFF-HOOK SIGNALLING ENTER 0.

TO PROGRAM FOR OFF-HOOK SIGNALLING ENTER 1.

Every one of the 16 stations (whether connected or not) must be programmed to be alerted or not by Off-Hook Signalling.

Programming for each individual station is done in numerical sequence. The 1st digit will be for station 20, the 2nd will be for station 21 and so on, until station 35, the last one to be programmed is entered.

To program Off-Hook Signalling:

1. Press # key.
2. Enter the memory location 95.
3. Enter the number "1" or "0" for each station.
4. To complete programming, press the # key.

**Example:** You want stations 24,25,28 and 34 to have Off-Hook Signalling

Press # key

Enter 95

Enter 0 0 0 0 1 1 0 0 1 0 0 0 0 0 1 0

Press # key

PROGRAMMING INFORMATION																		
PRESS KEY	MEMRY LOC #	20	21	22	23	24	25	26	27	28	29	30	31	32	33	34	35	PRESS KEY
#	95																	#

## Program #12. Long Line Compensation (Memory Location #96)

All CO LINES can be programmed to increase the transmit and receive voice volume levels when necessary.

DEFAULT: NO LONG LINE COMPENSATION

TO PROGRAM FOR LONG LINE COMPENSATION ENTER 1  
 TO PROGRAM FOR NO LONG LINE COMPENSATION ENTER 0

If you wish to increase the voice volume level on one or more CO LINES, then every one of the CO LINES must be programmed to have or not to have LONG LINE COMPENSATION.

TO PROGRAM:

1. Press the # key.
2. Enter the program location 96.
3. Enter the number "1" or "0" for each CO LINE.
4. To complete programming, press the # key.

### EXAMPLE:

You want CO LINES 2 and 4 to have LONG LINE COMPENSATION

Press #key

Enter 96

Enter 0 1 0 1 0 0

Press # key

PROGRAMMING INFORMATION								
PRESS KEY	MEM LOC #	C. O. LINES						PRESS KEY
		1	2	3	4	5	6	
#	96							#

0 = No Long Line Compensation

1 = Long Line Compensation

# PRIVACY & DIALING MODES PROGRAMMING

- Switch Positions 1 thru 6 should individually be set to the type of dialing provided on that particular OUTSIDE Line. Switch number 1 corresponds to Line number 1, and so on.

The systems are normally shipped with switches 1 thru 6 preset to the pulse dialing position. It is suggested that you verify this condition.

- Special Station DTMF Dialing

**NOTE:** If you use all special keysets for continuous tone dialing, move switch 7 to position "b". Standard keysets have burst tone dialing. Check with your supplier if you are uncertain as to what type keysets you have purchased.

- PRIVACY

PRIVACY is factory preprogrammed. If you do not want PRIVACY on OUTSIDE telephone calls, move switch number 8 to position "a".

## DIP SWITCH POSITIONS

**NOTE:** DIP SWITCHES LOCATED ON THE RIGHT SIDE OF KSU.

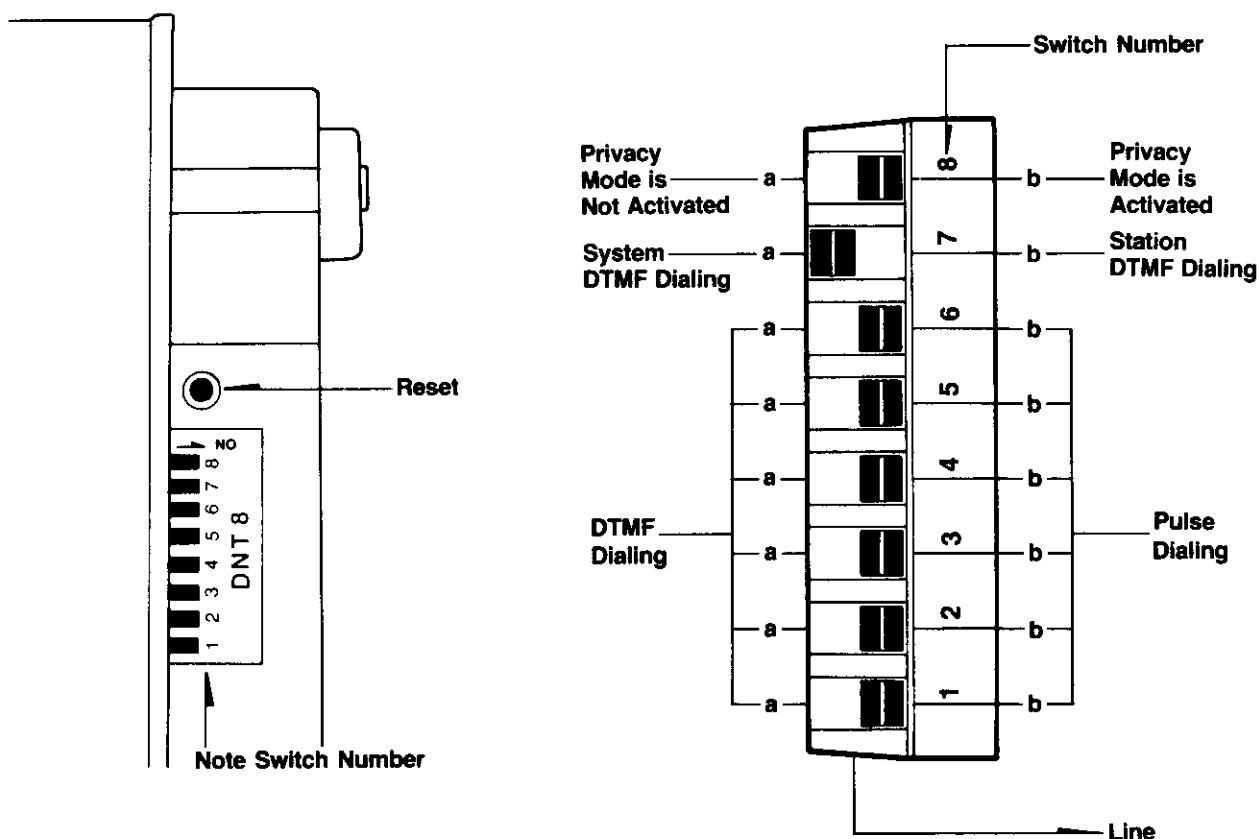

FIGURE 9

**NOTE:** AFTER YOU MAKE ALL THE SWITCH POSITION CHANGES YOU REQUIRE, PRESS THE RESET BUTTON.

**ALL THE MEMORY AND PROGRAM INFORMATION WILL NOT BE ERASED WHEN YOU RESET THE SYSTEM.**

# **PROBLEMS AND SOLUTIONS**

## **PROBLEM: DEAD STATIONS AND LED POWER INDICATOR ON THE KSU IS NOT LIT.**

### **Possible Causes**

NO POWER TO THE KSU.

### **Solutions**

1. CHECK IF YOUR AC OUTLET IS ACTIVE.
2. CHECK THE FUSE IN THE POWER SUPPLY.
3. CHECK THE CONNECTIONS FROM THE POWER SUPPLY TO THE KSU.

## **PROBLEM: DEAD STATIONS BUT LED POWER INDICATOR ON KSU IS LIT.**

### **Possible Causes**

THE CPU IS NOT OPERATING.

### **Solutions**

1. PRESS THE RESET BUTTON NEAR THE DIP SWITCH ON THE KSU.
2. DISCONNECT THE POWER SUPPLY FROM THE KSU. REMOVE THE BATTERY FOR AT LEAST 3 MINUTES AND THEN REINSTALL THE BATTERY AGAIN. RECONNECT THE POWER SUPPLY.

## **PROBLEM: VARIOUS FEATURE LEDS ARE ON STEADY AND SOME CO LINES ARE NOT ACCESSIBLE TO EITHER SOME OR ALL OF THE STATIONS.**

### **Possible Causes**

KSU IS NOT IN DEFAULT MODE.

### **Solutions**

1. DISCONNECT THE POWER SUPPLY FROM THE KSU. REMOVE THE BATTERY FOR AT LEAST 3 MINUTES AND THEN REINSTALL THE BATTERY AGAIN. RECONNECT THE POWER SUPPLY.

## **PROBLEM: SUDDENLY THE ENTIRE SYSTEM STOPS AND DOES NOT START WORKING AGAIN FOR EITHER A SHORT OR PROLONGED PERIOD.**

### **Possible Causes**

AC VOLTAGE (110V) IS NOT STABLE.

### **Solutions**

1. REMOVE THE PLUG FROM THE AC OUTLET. WAIT FOR 1 MINUTE AND REINSERT IT.
- NOTE: IF THIS OCCURS FREQUENTLY, ADDING AN AC STABILIZER SHOULD CORRECT THE PROBLEM.

## **PROBLEM: IF YOUR SYSTEM HAS BEEN PROGRAMMED FOR TONE DIALING BUT YOU CANNOT DIAL IN TONE ON ALL OF THE TELEPHONE LINES.**

### **Possible Causes**

1. DIP SWITCH IS SET IMPROPERLY.
2. SWITCH NUMBER 7 MAY NOT BE IN THE CORRECT POSITION.

### **Solutions**

1. REPROGRAM THE DIP SWITCH AND THEN RESET THE KSU.
2. PLACE SWITCH NUMBER 7 IN THE SYSTEM DTMF DIALING POSITION AND THEN RESET THE KSU.

IDENTIFYING THE CAUSE OF A PROBLEM MAY INVOLVE CONNECTING THE PROBLEM KEYSSET AT ANOTHER LINE NUMBER OR DIRECTLY CONNECTING TO THE KSU TO DETERMINE WHETHER THE KEYSSET, CARTRIDGE, KSU, OR WIRING IS DEFECTIVE.



## DISPLAY SYMBOL CHART

A : A	H : H	O : O	V : V	3 : 3
B : b	I : I	P : P	W : W	4 : 4
C : C	J : J	Q : Q	X : X	5 : 5
D : d	K : K	R : R	Y : Y	6 : 6
E : E	L : L	S : S	Z : Z	7 : 7
F : F	M : M	T : T	1 : 1	8 : 8
G : G	N : N	U : U	2 : 2	9 : 9
				10 : 0

---

(Example)

SPEAKER Key

SPERK

## **BATTERY REPLACEMENT**

### **A. TYPE**

1. Your FS 246 Key Service Unit uses a rechargeable 3.6 Volt Ni-Cad battery (model # ZM04198) (Installed). Used as a memory backup, this battery is constantly recharging while the KSU is in operation. It provides a memory retention time of 1 week in the event of a power failure. The total life span of this battery in normal use is approximately 5 years. Replacement batteries are available from Southwestern Bell Telecommunications Freedom Phone Division.

### **B. INSTALLATION OF REPLACEMENT BATTERIES**

**NOTE:** Any information stored in the memory unit of your KSU will be deleted upon removal of the old battery. It is highly advisable that any INFORMATION STORED IN THE MEMORY BE WRITTEN DOWN BEFORE YOU ATTEMPT TO REPLACE THE BATTERY.

If your KSU is wall mounted above 4 feet, you may find it easier to replace the battery by temporarily removing the KSU from the wall

1. Disconnect Power Supply by removing plug from wall socket.
2. Remove sliding Front door of KSU and disconnect the wires from the Optional Cartridge and the cartridge next to it.
3. Lift and remove cartridge top cover and remove only the Optional Cartridge and the cartridge next to it.
4. Lift and remove battery cover lid located in the rear of the Optional Cartridge slot.
5. Install battery with the end of the battery labeled + corresponding with the end of the battery slot labeled +.
6. Replace battery cover lid, cartridges, wires, sliding front door, and top cover.
7. Connect Power Supply back into wall socket and reprogram KSU (Procedure described in section of this manual entitled PROGRAMMING).

## **CARE AND MAINTENANCE**

Using a soft cloth to dust off your KSU is recommended. Never use liquids, abrasives, or solvents and never spray a cleaning fluid of any kind onto your KSU.

## **REPAIR SERVICE**

If you continue to have problems, disconnect your KSU, package it carefully along with a copy of your purchase receipt and ship it prepaid and insured (for your protection) to:

**SOUTHWESTERN BELL TELECOMMUNICATIONS, INC.  
FREEDOM PHONE DIVISION  
7442 Shadeland Station Way  
Indianapolis, IN 46256-3925**

## **LIMITED WARRANTY**

This Freedom Phone Key Service Unit and Power Supply are warranted to the original consumer purchaser to be free from defects in materials and workmanship under normal installation, use and service for a period of one (1) year from the date of purchase as shown on the purchaser's receipt.

The obligation of Southwestern Bell Telecommunications, Inc., Freedom Phone Division, under this warranty shall be limited to repair or replacement (at our option), during the warranty period of any part which proves defective in material or workmanship under normal installation, use and service, provided the product is returned to Southwestern Bell Telecommunications, Inc., Freedom Phone Division (address below) or to one of our authorized Service Centers **TRANSPORTATION CHARGES PREPAID**. Products returned to us or to an authorized Service Center must be accompanied by a copy of the purchase receipt. In the absence of such purchase receipt, the warranty period shall be one (1) year from the date of manufacture.

This warranty shall be invalid if the product is damaged as a result of defacement, misuse, abuse, neglect, accident, destruction or alteration of the serial number, improper electrical voltages or currents, repair, alteration or maintenance by any person or party other than our own service facility or an authorized Service Center, or any use violative of instructions furnished by us.

This one year warranty is in lieu of all other expressed warranties, obligations or liabilities. **ANY IMPLIED WARRANTIES, OBLIGATIONS, OR LIABILITIES, INCLUDING BUT NOT LIMITED TO THE IMPLIED WARRANTIES OF MERCHANTABILITY AND FITNESS FOR A PARTICULAR PURPOSE, SHALL BE LIMITED IN DURATION TO THE ONE YEAR DURATION OF THIS WRITTEN LIMITED WARRANTY.** Some states do not allow limitations on how long an implied warranty lasts, so the above limitation may not apply to you.

**IN NO EVENT SHALL WE BE LIABLE FOR ANY SPECIAL, INCIDENTAL OR CONSEQUENTIAL DAMAGES FOR BREACH OF THIS OR ANY OTHER WARRANTY, EXPRESSED OR IMPLIED, WHATSOEVER.** Some states do not allow the exclusion or limitation of special, incidental or consequential damages so the above limitation or exclusion may not apply to you.

This warranty gives you specific legal rights, and you may also have other rights which vary from state to state.

SOUTHWESTERN BELL TELECOMMUNICATIONS, INC.  
FREEDOM PHONE DIVISION  
7442 Shadeland Station Way  
Indianapolis, IN 46256-3925