



# FlexSet 120S and 121S User Guide

---

(Version 15.5)



*Creating a new world of IPportunities*

The information contained in this document is proprietary and is subject to all relevant copyright, patent and other laws protecting intellectual property, as well as any specific agreement protecting TADIRAN TELECOM LTD.'s (herein referred to as the "Manufacturer") rights in the aforesaid information. Neither this document nor the information contained herein may be published, reproduced or disclosed to third parties, in whole or in part, without the express, prior, written permission of the Manufacturer. In addition, any use of this document or the information contained herein for any purposes other than those for which it was disclosed is strictly forbidden. The Manufacturer reserves the right, without prior notice or liability, to make changes in equipment design or specifications.

Information supplied by the Manufacturer is believed to be accurate and reliable. However, no responsibility is assumed by the Manufacturer for the use thereof nor for the rights of third parties which may be affected in any way by the use thereof.

Any representation(s) in this document concerning performance of the Manufacturer's product(s) are for informational purposes only and are not warranties of future performance, either express or implied. The Manufacturer's standard limited warranty, stated in its sales contract or order confirmation form, is the only warranty offered by the Manufacturer in relation thereto.

This document may contain flaws, omissions or typesetting errors; no warranty is granted nor liability assumed in relation thereto unless specifically undertaken in the Manufacturer's sales contract or order confirmation.

Information contained herein is periodically updated and changes will be incorporated into subsequent editions. If you have encountered an error, please notify the Manufacturer. All specifications are subject to change without prior notice.

© Copyright by TADIRAN TELECOM LTD., 2001-2007.

All rights reserved worldwide.

The Coral is Protected by U.S. Patents 6,594,255; 6,598,098; 6,608,895; 6,615,404

All trademarks contained herein are the property of their respective holders.

---

---

## Table of Contents

<b>Introduction</b> .....	<b>1</b>
Conventions.....	2
Related Documentation .....	3
<b>FlexSet Overview</b> .....	<b>4</b>
Front View .....	4
Component Descriptions .....	5
Handset Hook and Telephone Number .....	7
Desk Elevation at 28° .....	8
Desk Elevation at 60° .....	9
Wall Mounting.....	10
Using the Display Panel .....	11
Using the Fixed and Navigator Keys .....	12

---

---

<b>Operating the FlexSet.....</b>	<b>13</b>
Overview.....	13
Using the Telephony Features .....	14
Using the System Defined Fixed Keys .....	15
Second Party Speaker Status .....	16
Using the Speakerphone or Headset .....	17
Volume Adjustment .....	22
Ring Adjustment .....	23
Making Calls .....	24
Making Internal Calls.....	25
Making External Calls.....	33
Receiving and Answering Calls .....	40
During Idle .....	42
Return Calls.....	47

---

---

<b>Station Telephony Features</b> .....	<b>50</b>
Overview.....	50
Account Code.....	51
ACD and UCD Hunt Groups.....	53
Activation Code .....	57
Auto Set Relocate.....	58
Auto Set Relocate: Permanent.....	59
Auto Set Relocate: Temporary .....	60
Boss Groups.....	61
Boss Groups: Using.....	62
Boss Groups: Privacy.....	63
Boss Groups: Exclusive Hold .....	64
Boss Groups: Call Forwarding.....	65
Call Forwarding / Follow Me.....	67
Call Log .....	71
Call Pickup.....	74

---

---

Caller ID Control .....	75
Calls Waiting: Receiving .....	76
Camp On (Call Back).....	78
Cancellation Code .....	80
Canned Messages.....	81
Conference (Multi-Party) Calls .....	83
Conference Calls: Meet Me .....	84
Conference Calls: Conference Multi-Party Lock.....	85
Conference Calls: Conference View/Release .....	86
COS Switchover .....	87
Directory .....	88
Divert Call.....	94
Do Not Disturb (DND).....	95
ELA (Extension Line Appearance) .....	97
ELA Group Line Keys: Programming .....	98
ELA Groups: Using.....	100

---

---

ELA Groups: Privacy .....	102
ELA Groups: Exclusive Hold .....	103
Executive Privilege .....	104
FlexiCall.....	105
Freedom .....	110
Group Calls.....	111
Group Calls: Preset Conference Activation .....	114
Group Calls: Temporary Conference Activation .....	115
Group Calls: Joining .....	116
Group Calls: Adding Participants (when not part of the Call) .....	117
Group Calls: Adding Participants (by Group Operator) .....	118
Group Calls: Submitting Request to Speak.....	119
Group Calls: Controlling Permission to Speak .....	120
Group Calls: Forced Release of a Participant .....	121
Group Calls: Forced Release of an Entire Group Call.....	122
Headset Only.....	123

---

---

Help: Requesting .....	124
Help: Answering .....	125
Hold .....	126
Individual Remote System Services (IRSS) - Freedom.....	127
Malicious Call Trace .....	134
Messages: Options.....	135
Messages: Voice Mail.....	138
Music Options.....	149
Mute Microphone.....	150
Page Queue .....	151
Paging: Announcing, Public Address .....	155
Paging: Voice Paging .....	156
Paging: Zone Page.....	158
Park .....	159
Phone Lock.....	161
Programming: Feature Keys.....	162



---

---

Programming: Button Labeling .....	169
Recording a Call .....	172
Redial .....	173
Relay (Accessory) .....	176
Reminder .....	177
Room Status .....	178
Series Call .....	180
Silent Monitoring .....	181
Speed Dialing: Private Library .....	184
Speed Dialing: Using Private and Public Libraries .....	188
Touch-Tone Dialing (DTMF) for Other Common Carriers (OCC).....	189
Transfer (Xfer) .....	190
Transfer: Broker/Consultation/3-Way Conference Call .....	194
Wakeup .....	198
Whisper Paging .....	200

---

---

<b>Attendant Features .....</b>	<b>203</b>
Available Functions .....	203
Call Forward .....	206
Canned Messages.....	208
Malicious Call Trace .....	211
Room Status.....	212
WakeUp.....	214
Call Charge.....	216
Station Setup Features.....	218
System Features .....	221
Trunk Setup Features.....	227
<b>Setup.....</b>	<b>232</b>
Overview.....	232
Coral Telephony Features .....	233
Zip Tone/Version (FlexSet 120S-Type A / 121S) .....	240
Call Log/Zip Tone/Version (FlexSet 120S-Type B) .....	241

---

---

<b>Appendix A: Glossary .....</b>	<b>330</b>
<b>Appendix B: Tones .....</b>	<b>335</b>
<b>Appendix C: LED Indications (Programmable Keys) .....</b>	<b>338</b>
<b>Appendix D: ISDN Cause Numbers.....</b>	<b>339</b>
<b>Index: Soft Keys and Feature Codes .....</b>	<b>345</b>

---

---

# Introduction

The FlexSet 120S/121S or Terminal with soft keys meets all your telephony and office needs. The benefits you receive from working with the FlexSet will become an invaluable part of your work environment. While the technology employed in the FlexSet is state of the art, using the telephone is simple and straightforward. You will immediately appreciate the easy to reach soft keys. Depending on the state of the telephone, the display automatically changes to provide you with the appropriate options.

Many of the feature options, which have been assigned during initial installation, are provided on an extension (station) basis. Feature allocation may also be redefined to suit changing working stations or adapted to your individual requirements by your system administrator. Not every feature in this guide may have been installed in your system, or at your extension. Check with your system administrator for a list of the specific features installed. This *User Guide* provides a full description of the capabilities and operation of the FlexSet 120S (version 3.5 and later) and the FlexSet 121S terminals.

The main section of this guide is organized according to the two distinct feature types – Station Features and Attendant Features. The appendices, located at the end of this guide, give basic explanations of special terms and operations used throughout the guide, and are useful to consult for a fuller explanation of telephony terms.













**NOTE!** *FlexSet 121S requires Coral Version 15.5 and later.*

---

---

## Conventions

The following typographical conventions are used throughout this guide.

Example	Description
	Icons are used to represent the actual fixed and navigator keys. See <a href="#">page 12</a> and <a href="#">page 6</a> for a complete listing.
	Soft key names appear in a clear distinctive box. See <a href="#">page 260</a> for a complete listing.
<b>HOLD</b>	Emphasized (bold) text indicates system-defined fixed keys or Direct Station Selection (DSS) user programmable keys. See <a href="#">page 15</a> for a complete listing.
Press  and enter the station/room number, or scroll through the list using  .	The scroll icon (  ) indicates that the following soft keys (when available) can be used to scroll through lists:  ,  ,  ,  ,  ,  . You can also use the  and  buttons to scroll through lists.
<i>“See <a href="#">Ring Adjustment</a>”</i>	Text in italics refers you to another section of the guide or to other Coral system manuals. The blue font indicates that this is a clickable cross-reference link. Italicized text is also used for notes.
EXCLUSIVE HOLD	Text in Courier font indicates a display message

---

---

## ***Related Documentation***

- Attendant Console User Guide
- FlexSet 280, 280D, 280D-Z, 120, 120D and 120L User Guide
- Program Interface and Database Reference Manual (Version 15.5)
- Terminal Equipment (FlexSet) Installation Manual

---

---

# FlexSet Overview

## Front View

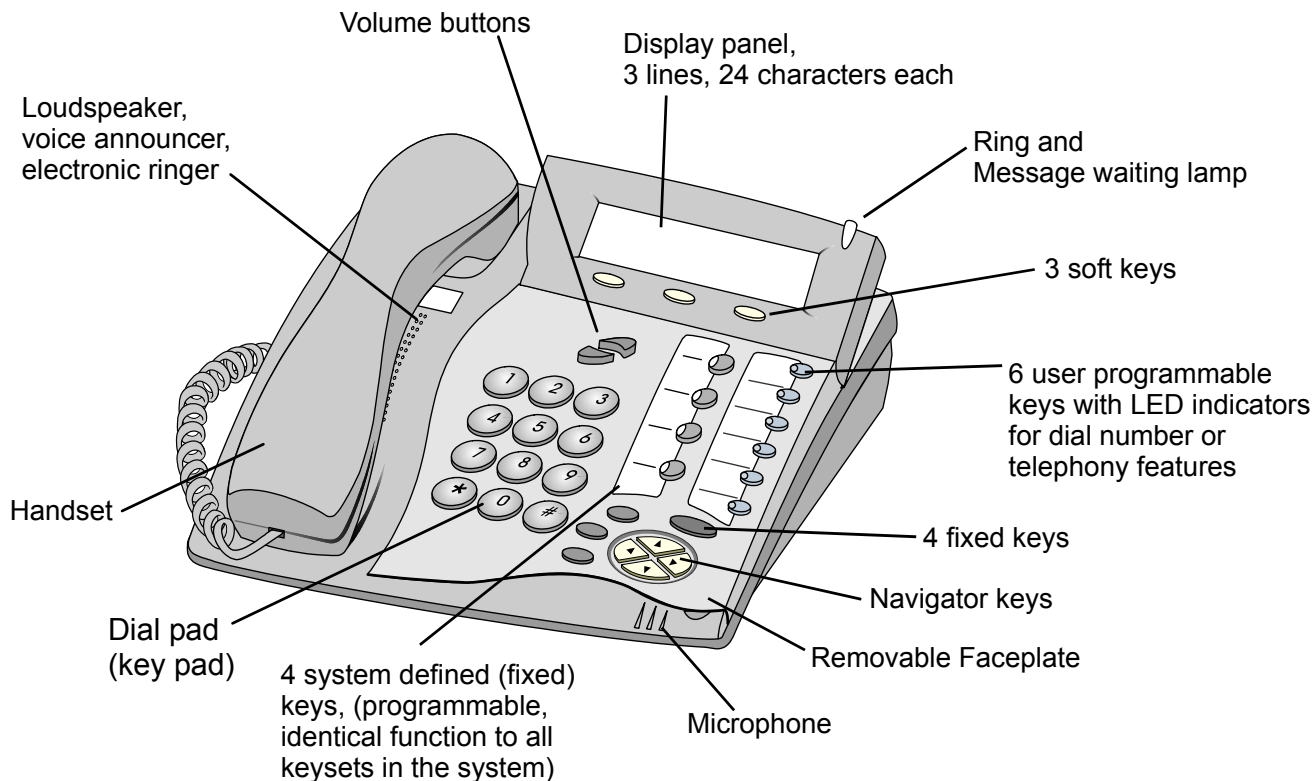

---









---

## Component Descriptions

The following table defines controls, buttons and keys found on the FlexSet.

Component	Description
<b>Dial Pad (Key Pad)</b>	Digit buttons used for dialing phone numbers or extension numbers.
<b>FlexSet Display</b>	The display is composed of three lines: System lines (1 <sup>st</sup> and 2 <sup>nd</sup> lines), and function options (on 3 <sup>rd</sup> line) according to FlexSet status. See <a href="#">Using the Display Panel on page 11</a> .
<b>Handset</b>	Works as typical phone handset.
<b>Headset</b>	Non-manufacturer headset purchased by customer (see <a href="#">page 16</a> , <a href="#">page 21</a> , and <a href="#">page 235</a> ).
<b>Hook Switch</b>	On-hook or off-hook for handset.
<b>Handset Latch</b>	Used to catch the handset when wall mounted or for elevated (60° or higher) desktop mounts.
<b>Loudspeaker</b>	Output sound device used in hands free operation, paging, background music and ringing.
<b>Microphone</b>	Input sound device used in hands free operation.
<b>Ring and Message Waiting Lamp</b>	Lamp flashes at a slow rate, indicating that a message is waiting. Lamp flashes at a faster rate (to the beat of the ring) when the phone is ringing.



Component	Description
<b>Programmable Keys (DSS)</b>	<p>Provides a shortcut to a string of dial commands or telephone number, by using a pre-defined key, known as a DSS (Direct Station Selection) key. Instead of dialing a number or dial commands, this can be done by pressing the programmed key.</p> <p>Several dial commands, in a series, may be programmed into one DSS key - useful for one-button speed dialing, voice response and voice mail system access, and other complex dialing patterns. Features keys can be programmed exactly as they are programmed in the FlexSet 280D and 120D series keysets.</p> <p>There are Six user programmable keys on the FlexSet 120S/121S A red LED lights when a key is activated. See <a href="#">Programming: Feature Keys on page 162</a>.</p>
<b>System-defined Keys</b>	<p>Four system-wide programmed keys (market dependent) for basic features: <b>SPKR</b>, <b>LOOP</b> (used as <b>LINE</b> key), <b>Xfer</b> and <b>Hold</b> (see <a href="#">page 15</a>).</p>
<b>Fixed keys</b>	<p>   and  (see <a href="#">Using the Fixed and Navigator Keys on page 12</a>).</p>
<b>Navigator Keys</b>	<p>   and  Up/down, right/left arrows used to move from one option to another on the display. Used for selecting without choosing or activating the option. See <a href="#">Using the Fixed and Navigator Keys on page 12</a>.</p>
<b>Soft keys</b>	<p>Located below the display panel, keys used to directly activate the feature option. See <a href="#">Using the Telephony Features on page 14</a>.</p>
<b>Volume Buttons</b>	<p>Adjust the volume (see <a href="#">Volume Adjustment on page 22</a>) of the following components:</p> <ul style="list-style-type: none"> <li>• Ringer - from idle or while the phone is ringing (see <a href="#">Ring Adjustment on page 23</a>)</li> <li>• Speaker/Handset/Headset - during a conversation (see <a href="#">Using the Speakerphone or Headset on page 17</a>)</li> <li>• Background Music - during idle and when turned on</li> </ul>

---

---

## ***Handset Hook and Telephone Number***

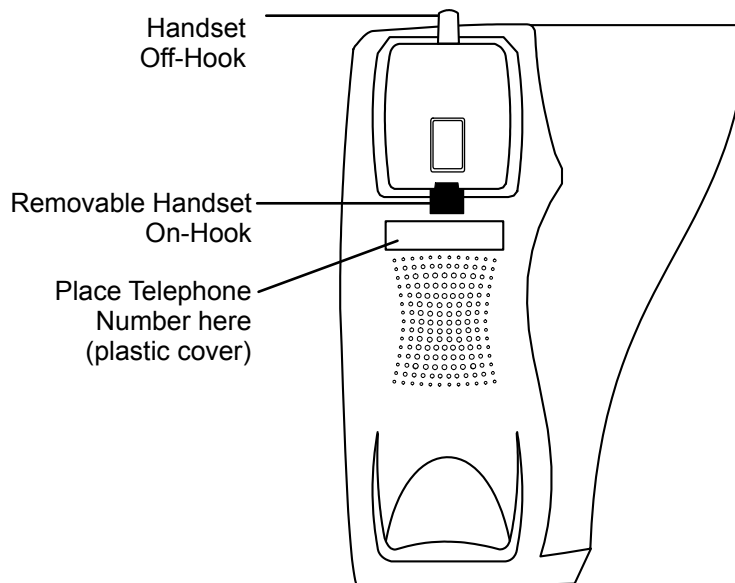

---

---

## Desk Elevation at 28°

**NOTE!** For full instructions regarding desk elevation, refer to the Coral Terminal Equipment Installation Manual.

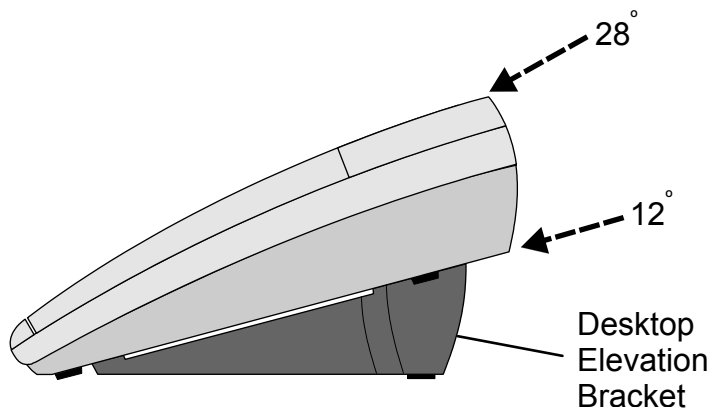

---

---

## Desk Elevation at 60°

**NOTE!** For full instructions regarding desk elevation, refer to the Coral Terminal Equipment Installation Manual.

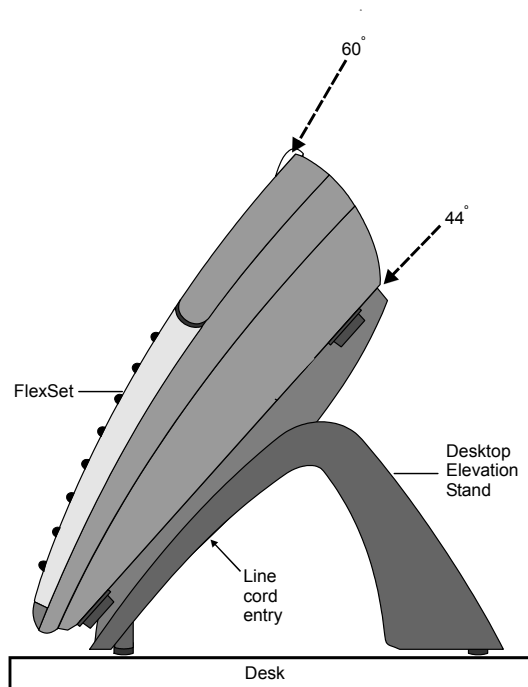

---

---

## Wall Mounting

The FlexSet can be wall mounted when required.

**NOTE!** For full instructions regarding wall mounting your phone, refer to the Coral Terminal Equipment Installation Manual.

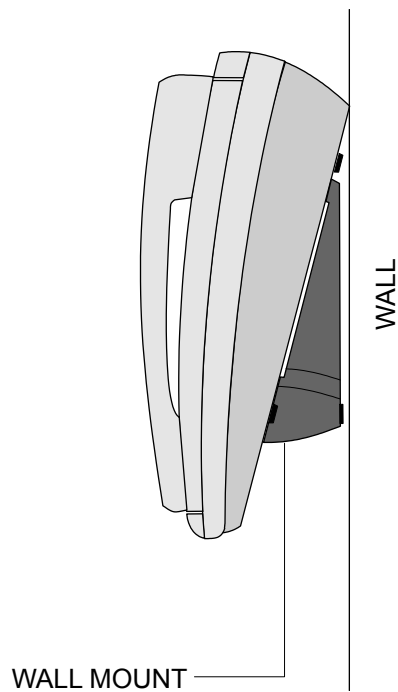

---

---

## Using the Display Panel

The **FlexSet Display** provides an easy-to-use control interface. On this display several different classes of function information and controls are found. During normal operation the active function assumes control over the entire area of the display and all of the soft keys. Meanwhile, the System Lines (1<sup>st</sup> and 2<sup>nd</sup> lines) which usually, in idle state, include the time, date, site name, station name and number, automatically change to relay pertinent information about telephony states and operations, and the calling party's information.

Three soft keys located immediately below the display screen, act as triggers for any currently displayed FlexSet function or option. All of the information on the display panel (3<sup>rd</sup> line) continually changes to reflect options related to the current state of the FlexSet. In this manner, no matter which state the telephone is in (i.e. Idle, Ringing, etc.) the relevant option is always next to and enabled by one of the soft keys.

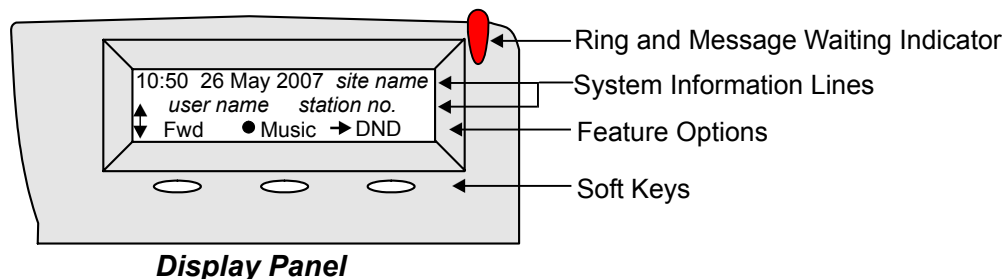









---

---

## Using the Fixed and Navigator Keys

The following table lists all theFlexSet fixed keys and describes the actions they invoke.

Fixed Key	Action
	Activates a telephony feature after selecting it with the navigator keys (same as using the soft key).
	Returns to the previous menu or list.
	For future use.
	Provides access to all theFlexSet functions available during idle via the Features menu and provides access to the other Main Menu options (see <a href="#">page 42</a> ). <b>NOTE!</b> In order for the Main Menu options to appear on the display panel, you must press and hold the <b>OK</b> button for at least three seconds.
	Moves the cursor (→) left and right, or goes to the next or previous menu or list when the cursor is at the end of a line.
	Used to scroll soft key option lists when ↓, ↑ or ↕ appear on the display line above the soft keys. Press  to scroll back one menu or list;  to scroll forward one menu or list.

---

---

# Operating the FlexSet

## Overview





Operating the phone is as simple as pressing a button. Operate the phone using a combination of soft and fixed keys. The phone options appear in the display area on the bottom line of the display panel, and automatically change to reflect the current state of the telephone.

FiveThree soft keys, located immediately below the display panel, allow you to enable the relevant options as they appear. The soft key options change every time the phone status changes.

Four system-defined keys are provided, the functions of which are system-wide programmable. Typical functions for these keys are: **HOLD**, **XFER**, **LOOP** and **SPKR** (see [Using the Fixed and Navigator Keys on page 12](#)).

Soft key functions can also be selected by pressing on the navigator keys. Pressing on the respective **arrow** moves the location of the cursor to the next function. To activate the required function, press **ENTER** .

Use **ESC** or **Esc** to bring theFlexSet display to the beginning of the soft key options. When the **Esc** soft key does not appear on the display panel, press the left key  instead to return to the previous soft key options.

Press up/down keys  and  to scroll through lines of the soft key feature options. Press left/right keys  and  to move from one option to the next on the displayed line.

A selected option is indicated by an arrow at its left ( Fwd).

Additional options on a lower line of the display are indicated by a down arrow ( Msg).

Additional options on a higher line of the display are indicated by an up arrow ( RoomSt).

Additional options on both a lower and higher line of the display are indicated by a double arrow ( Remind).

An activated option is indicated by a bullet at its left ( Fwd).

A selected and activated option is indicated by a bold arrow at its left ( Fwd).



---

---

## Using the Telephony Features

You do not have to memorize any access codes to activate any of the rich array of Coral system telephony features.

Each state change in the phone (such as from idle to ring, ring to answer, answer to transfer, etc.) causes the associated state-related features to appear on the display panel. Simply choose the feature you would like to activate by pressing its associated soft key. When the feature is activated, a bullet appears next to the feature. As shown below, while in Idle mode when DND (Do Not Disturb) is off, no bullet appears next to DND. When DND is activated, a bullet is displayed next to DND.

Page 1

10:50	26 May 2007	Company xyz
	<i>user name</i>	<i>station number</i>
↕→ Fwd	Music	DND

### **DND OFF**

Page 2

	*DND*	
	<i>user name</i>	<i>station number</i>
↕→ Fwd	Music	•DND

### **DND ON**

**NOTE!** Figures depicting the various display panel (3-soft key) options appear throughout this guide. Where a list, menu or sub-menu continues through several lines, these are indicated as Page 1, Page 2, etc. The location of the soft key options that appear in the figures in this guide may differ from their actual locations on your FlexSet.

Several telephony features are toggle switches. Therefore, the first time you press a feature's soft key, the feature is activated or turned on. The second time you press the same feature's soft key, the feature is canceled or turns off automatically.

See [Index: Soft Keys and Feature Codes on page 259](#) for an alphabetic list of all available feature options.

## Using the System Defined Fixed Keys

Four FlexSet buttons are programmed during installation, and are the same for each keyset system-wide. These fixed system keys cannot be programmed from the telephone, and can only be be changed, system-wide, by the system administrator. The four system-defined fixed keys are different from site to site. The default features are:

<b>Hold</b>	The Hold key is used for placing a party on Hold while another call is made or received. The held party can hear one of the following: music, ring-back tone, busy tone or no sound at all, as defined system-wide. (see <a href="#">Hold on page 126</a> ).
<b>Transfer/ Recall (XFER)</b>	While engaged on a call you can activate a feature by pressing the Transfer key. When using Transfer, a special distinctive dial tone is heard, enabling you to either transfer the call, or activate a feature. Transfer puts the second party on Hold and provides one of the following: music, ring-back tone, busy tone or no sound at all, as defined system-wide (see <a href="#">Transfer (Xfer) on page 190</a> ).
<b>LOOP</b>	The <b>LOOP</b> key is used for making and receiving calls. When several <b>LOOP</b> keys are in use, the station acts as if it is a multi-line instrument. To program additional <b>LOOP</b> keys, see <a href="#">Programming: Feature Keys on page 162</a> : <ul style="list-style-type: none"> <li>• default <b>LOOP</b> access code: #121</li> <li>• default <b>LOOP Originating Only</b> access code: #125</li> </ul>
<b>Speaker (SPKR)</b>	The Speaker key is used to converse hands-free. When conversing through the speaker, voice volume can be adjusted. Volume of call monitoring, paging, etc. can also be adjusted by using the volume control buttons. See <a href="#">page 17</a> and <a href="#">page 22</a> .

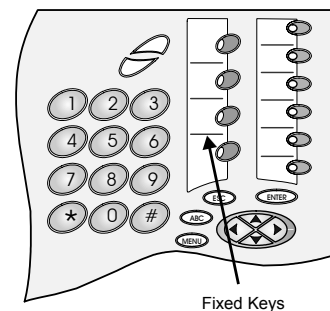

---

---

## Second Party Speaker Status

ANSWER (2nd party) (2nd party) SPKR ON ↓→ Page_Q                      xfer                      Hold
--

This feature alerts you when the loudspeaker of the party you are conversing with is activated for hands-free or group conversation. A Speaker tone and display message notify you when the called/calling party is in SPKR mode, or if they switch to SPKR mode during a call.

Therefore, when advised that the second party's keyset (FlexSet, DKT, T207M or T208M) is in Speakerphone mode, you can choose to refrain from publicizing private information.

### **Detection of your party's activated loudspeaker:**

A speaker tone is heard and the SPKR ON message flashes on the second line of the display:

- when you answer a call initiated with an activated loudspeaker
- when the called party answered you with an activated loudspeaker
- during a call, when the second party activates the loudspeaker

---

---

## ***Using the Speakerphone or Headset***

The FlexSet is equipped with a speaker so that it can operate as a speakerphone. This enables you to converse without lifting the handset. Pressing the speakerphone (**SPKR**) key automatically switches on the microphone and speaker. All dialing or conversation is automatically hands-free; the handset remains on the cradle.

There are, however, several ways of using the speaker key, such as: in conjunction with a headset, or when **SPKR** is programmed for on/off operation, and using the **[Spk/Hs]** (Speaker/Handset) soft key to switch between the handset and the speaker.

### **Hands-Free Conversation**

#### **With handset on cradle:**

When the handset is on the cradle and **SPKR** flashes, you can speak hands-free by pressing the flashing **SPKR** key or by using one of the methods described in [Making Calls on page 24](#).

#### **Switchover from speakerphone to handset:**

When you are using the speakerphone and want to use the handset for private conversation, lift the handset. The **SPKR** key LED will go off.

#### **Switchover from handset to speakerphone:**

When you are using the handset and want to use the speakerphone, first press **SPKR**. When the **SPKR** key LED is lit, replace the handset on the cradle.

#### **Disconnecting calls:**

Either press the lit **SPKR** key when the handset is on the cradle or replace the handset onto the cradle when the **SPKR** key LED is off.

#### **Call monitoring (when programmed for combined audio):**

When you are using the handset and wish to activate the speaker for group listening, press **SPKR**. When the LED is lit, the combined audio is active. To return to private conversation, press **SPKR** again. The LED will go off.

---

---

## Using the Spk/Hs Soft key (when the phone is programmed for SPKR On/Off key):

### When using headset (or handset is off cradle):

When your phone is equipped with a headset, you can answer and disconnect calls by pressing the **SPKR** On/Off key. When the **SPKR** key LED is lit, you are connected. Pressing the lit key will disconnect the call. To switch between handset and hands-free operation, you must press **[Spk/Hs]** from the phone display.

### With handset on cradle:

If the phone rings and **SPKR** flashes, you can speak hands-free by pressing the flashing **SPKR** key. The key LED will now be steadily lit.

### Switchover from speakerphone to handset:

When you are using the speakerphone and want to use the handset for private conversation, lift the handset. The **SPKR** key LED will remain lit.

### Switchover from handset to speakerphone:

When you are using the handset and want to use the speakerphone, first press **[Spk/Hs]**, then when the LED is lit, place the handset on the cradle.

### Disconnecting calls:

There are two ways to disconnect calls:

- Pressing the lit **SPKR** key.
- Returning the handset or pressing hookswitch when **[Spk/Hs]** is off (a bullet is not displayed).

---

---

## When the Phone is programmed as Headset Only and for SPKR On/Off key

### When your phone is equipped with a headset:

When the Headset Only feature is activated (see [Headset Only on page 123](#)), and **SPKR** is set to operate as On/Off (connect/release) switch, you can answer and disconnect calls by pressing **SPKR**.

### When the key LED is lit:

You are connected. Pressing the lit key will disconnect the call.

### Disconnecting calls:

Press the lit **SPKR** key.

#### **NOTES!**

- See your system administrator to program **SPKR** to operate as an On/Off switch.
- When the phone is set for Zip Tone mode (see page 240 or page 241), the ring sounds at the headset only, rather than through the speaker.
- If the phone is defined as Headset Only (see [Headset Only on page 123](#)), the speakerphone will not operate.

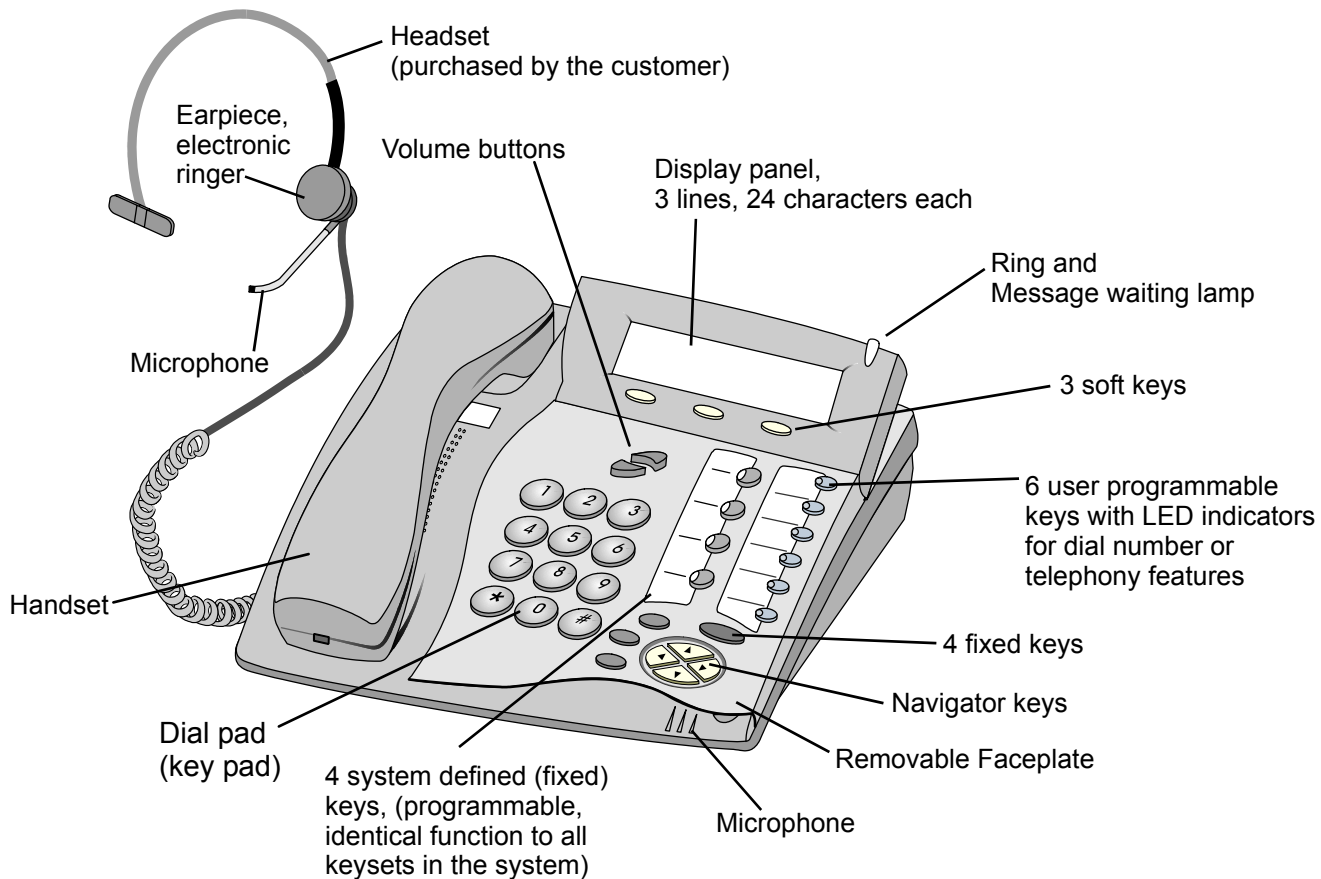

---

---

## Headset Cord Disconnect

- Headset Cord Disconnect enables activating a selected preprogrammed key by disconnecting the handset/headset cord. The feature enables you to automatically invoke a keyset function such as Do Not Disturb, Login/Logout, Attended/Unattended, Call Forward, or any other preprogrammed key function, upon disconnection of the headset cord.
- One of the Headset Cord Disconnect purposes is to block a telephone from accepting calls when the headset cord is disconnected. Any call forwarding to the keyset will be automatically cancelled when the feature is activated.
- This feature is generally combined with the Headset Only feature to allow calls to be conducted via the headset/handset even if the cradle switch is on-hook.

**NOTE!** *The Headset Cord Disconnect feature does not work with all headset equipment. The feature is operable only with headsets that do not use auxiliary equipment, such as splitters, volume amplifiers, external headset/handset switches.*

- See your system administrator for the programmable button assigned for this feature.
- The corresponding button should be programmed to perform the required function.

### Operation

- If a key is preprogrammed with a feature having ON/OFF states (e.g. Do Not Disturb), the system will toggle the feature Off when the Cord is connected, and On when the Cord is disconnected. The Login/Logout function is excluded from this rule, as it operates in the reverse mode.
- If the key is programmed with a feature without ON/OFF states, the system will operate the same key contents when connecting/disconnecting the cord (e.g. dialing an external number).
- When enabled by disconnecting the cord, the feature can be disabled also by pressing the button.
- The feature activated by pressing a button when the cord is plugged in, will remain active when the cord is disconnected.
- Connecting the cord will cancel the feature that has been activated by pressing a programmable key or dialing a feature code when the cord was disconnected.



---

---

## Volume Adjustment

Press the volume buttons to increase or decrease the volume of the phone loudspeaker and handset.

### Volume Buttons

Volume Up

Volume Down

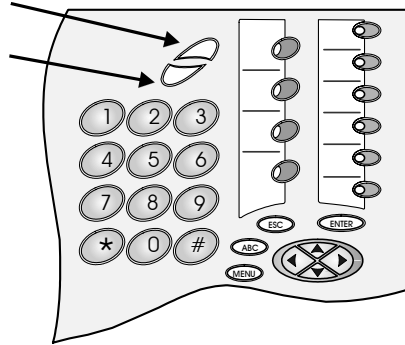



While the volume is being changed, the top line of the display shows the volume level.

**Speaker** and **Music** volume levels range from a MIN unit value of 0 to a MAX unit value of 15 (24dB range).

The **Handset** volume level ranges from a MIN unit value of 0 to a MAX unit value of 7 (12dB range).

Speaker, Background Music and Handset each has its own audio level and is independently influenced by volume buttons as follows:

- **Speaker:** When conversing through the speaker, voice volume can be adjusted. Volume of call monitoring, paging, etc. can also be adjusted. This can also be done from idle.
- **Speakerphone:** When conversing hands-free, the built-in sensitive microphone is used to amplify your voice. The system operates in such a way that the two connecting parties (i.e. you and the far side) cannot be heard simultaneously; the stronger party is heard. Press  to hear the far side more strongly, press  to be heard more easily (or to break in).
- **Background Music:** When in idle, and background music is turned on, music volume can be adjusted.
- **Handset:** When conversing through the handset or headset, receiver volume can be adjusted.

---

---

## Ring Adjustment

The ring volume (as well as phone cadence and pitch) can be changed by using the soft keys from idle. The ring volume can also be adjusted by using the volume buttons while the phone is ringing. You can use this to change the ring of two different telephones in the same room. Also note that the Message Lamp lights in beat with the ring while the phone is ringing.

### Adjusting the ring volume level while ringing:

Press the up or down volume buttons. The ring volume level ranges from 0 (MIN ring) to 15 (MAX ring).

### Adjusting the ring level from idle:

1. Select **[Setup]** and press **[Ring]**.
2. There are three ring sound elements that can be adjusted:
  - [Volume]** change by pressing **[Vol-Up]**, **[Vol-Dn]**. Ring volume ranges from 0 to 15.
  - [Cadenc]** change by pressing **[Next]**, **[Prev]**. The cadence ranges from 0 to 7.
  - [Type]** change pitch by pressing **[Next]**, **[Prev]**. The pitch ranges from 0 to 7.
3. Choose the desired sound element by choosing the related **[Cadenc]**, **[Type]**, **[Volume]** soft key.
4. Use the variously defined soft keys to choose a higher or lower adjustment. Listen for a tone you like.
5. Press **SPKR** to set (or wait for the system to automatically reset ring adjustment).



#### **CAUTION!**

*The Ringer is disabled and the FlexSet cannot receive calls when DND or Call Forward All are indicated by bullet and \*DND\* or \*FwdAll\* messages on the display.*

---

---

## Making Calls

To place a call use any of the following methods:

- Lift the handset and dial from the dial pad.
- Press **SPKR** and begin dialing directly from the dial pad.
- Begin dialing without lifting the handset. The Speaker is automatically activated.
- Press any idle (LED not lit) DSS or **LOOP, LOOP** originating only, or **LINE** key, and after hearing a dial tone begin dialing.

The options available in each of the selected FlexSet states are described on the following pages:

### Internal Calls

<i>Upon Hearing Ringback Tone</i> .....	page 25
<i>Upon Hearing Reorder Tone</i> .....	page 27
<i>Upon Hearing Busy Tone</i> .....	page 28
<i>During a Call</i> .....	page 30
<i>During a Break In</i> .....	page 32

### External Calls

<i>Upon Hearing Ringback Tone</i> .....	page 35
<i>Upon Hearing Busy Tone</i> .....	page 37
<i>During a Call</i> .....	page 38

---

---

## Making Internal Calls

### Upon Hearing Ringback Tone

After dialing an internal destination number, the following features appear on your FlexSet display when you hear a ringback tone. Wait for answer or press the nearby soft key to activate the required feature.

See [page 14](#) for further details.

**NOTE!** A message indicating the called party's status (or other relevant information) may appear on the second line of the display until you answer the call (see [Canned Messages on page 81](#)).

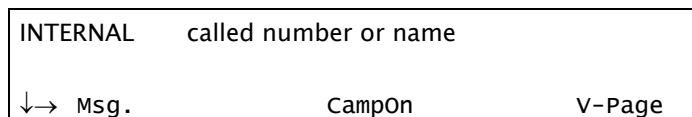

**Msg.** **Leave Message.** If no one answers your call, use this feature to leave a “message” at the called party’s station. This feature lights the message waiting lamp at the called party’s station indicating that a message was left, and it leaves a simple message such as CALL SUSAN on the destination station’s keyset display. See [Messages: Options on page 135](#).

**Msg-Wt** **Message Waiting.** The Attendant can use this feature to leave a message waiting indication at a busy or idle station, room or group. See [Leaving a message indication at a busy or non-answering station: on page 137](#).

**CampOn** **Camp On, also known as Call Back.** When a station does not answer, you may request that the system automatically call you back when the required destination number is available. See [Camp On \(Call Back\) on page 78](#).

**V-Page** **Voice Page** the called party’s keyset station using this feature. Your call is automatically answered and your voice heard over the called party’s speakerphone. See [Paging: Voice Paging on page 156](#).

---

---

**Mute** can be activated during ringback so that when the call is answered your side of the conversation is muted and the called party will not hear you. When this feature is activated by the **Mute** on/off toggle switch, a bullet appears to the left of **Mute**. The mute feature deactivates the microphone for your speakerphone and handset or headset. Press the toggle key again to reactivate the microphone (see [Mute Microphone on page 150](#)).

**Number** is used to briefly display the caller's dial number instead of the name.

---

---

## Upon Hearing Reorder Tone

After dialing an internal station that is idle, but has been set to Do Not Disturb or UNATTEND, the following features are available. After dialing a station and receiving a reorder tone, override can be applied by pressing **[DNDOvr]**.

DONT DIST	called number or name
↓→ Msg.	CampOn Brk-In

**[CampOn]**

**Camp On**, also known as **Call Back**. Use this feature to have the system automatically call you back when the DND destination station becomes available. See [Camp On \(Call Back\) on page 78](#).

**[SendCw]**

Not used during reorder tone.

**[V-Page]**

**Voice Page** the called party's keyset station using this feature. Your call is automatically answered and your voice heard over the called party's speakerphone after the Voice Page tone stops. See [Paging: Voice Paging on page 156](#).

**[Mute]**

**Mute** can be activated during reorder tone so that when the Do Not Disturb is overridden, your side of the conversation is muted and the called party will not hear anything. When this feature is activated by the **[Mute]** on/off toggle switch, a bullet appears to the left of **[Mute]**. The mute feature deactivates the microphone for your speakerphone and handset or headset. Press the toggle key again to reactivate the microphone. See [Mute Microphone on page 150](#).

**[Msg.]**

**Leave Message**. Use this feature to leave a "message" at the called party's station. This feature lights the message waiting lamp at the called party's station indicating that a message was left, and it leaves a simple message such as CALL SUSAN on the destination station's display. See [Messages: Options on page 135](#).

**[Brk-In]**

**Break In** operates as **[DNDOvr]**.

**[DNDOvr]**

**DND Override** enables an authorized user to send a ring tone thus overriding the Do Not Disturb status. When you hear the reorder tone, if DON'T DIST or UNATTENDED message appears, override can be applied and your call can be put through to the station.

---

---

## Upon Hearing Busy Tone

After dialing an internal destination number, the following features appear on your display when you hear a busy tone. Hang up or press one of the soft keys.

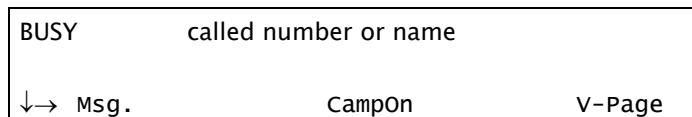

**Msg.** **Leave Message.** Use this feature to leave a “message” at a busy station. This feature lights the message waiting lamp at the busy station and leaves a simple message such as CALL SUSAN on the destination station’s keyset display. See [Messages: Options on page 135](#).

**Msg-Wt** **Message Waiting.** The Attendant can use this feature to leave a message waiting indication at a busy or idle station, room or group. See [Leaving a message indication at an idle station: on page 136](#).

**CampOn** **Camp On,** also known as **Call Back.** Use this feature to have the system automatically call you back when the busy destination station is available. See [Calls Waiting: Receiving on page 76](#).

**Brk-In** **Break-In** enables an authorized user to break into an established two party call. Both conversing parties will hear the Break In warning tone. Your voice will be heard after the warning tone stops. During Break-In you can release the ports or alternate between parties. See [During a Break In on page 32](#).

**NOTE!** Only stations with appropriate COS may activate the Break-In feature.

**SendCw** **Send Call Waiting** is used to send a call waiting tone to the busy party. This feature is also known as *Call Waiting* or *Call Offer*. The station is now aware that another call is waiting. Your side hears a second (quicker) ringback tone (system-wide defined).

---

---

V-Page

**Voice Page** the called party's keyset station using this feature. The other party receives a message that they are being paged. Your voice is heard over the called party's speakerphone after the warbling tone stops. See [Paging: Voice Paging on page 156](#).

Number

**Number** is used to briefly display the caller's dial number instead of the name.

Mute

**Mute** can be activated during busy tone so that if you break-in, your side of the conversation is muted for silent monitoring (handset, headset and speakerphone). When this feature is activated by the [Mute](#) on/off toggle switch, a bullet appears to the left of [Mute](#). The mute feature deactivates the microphone for your speakerphone and handset or headset. Press the toggle key again to reactivate the microphone. See [Mute Microphone on page 150](#).

S.Mon2

**2-Way Silent Monitoring** is used to monitor both sides of a 2-way conversation simultaneously. This feature can be activated from idle, or while attempting to call a busy or non-answering destination. At the prompt, dial the station or dial number. See [Silent Monitoring on page 181](#).

CallWt

**Calls Waiting** can be used to view the number of calls waiting for you during a conversation. See [ACD and UCD Hunt Groups on page 53](#).



---

---

## During a Call

The following features are available during an internal call:

ANSWER 2nd party name or number
↓→ Page_Q                      xfer                      Hold

**Page Q**

**Page Queue** places your call on hold by sending it to one of ten Page Queue destinations. You are then free to page all the system members from your FlexSet and announce that there is a call for Mr. Doe on a specific Page Queue Line. The call can be picked up from any system station. See [Page Queue on page 151](#).

**Xfer**

**Transfer** passes your call to another destination. Pressing **Xfer** places the called party on Hold. Dial a number (internal or external), and disconnect to transfer the call, or first announce the call and then disconnect. See [Transfer \(Xfer\) on page 190](#).

**Hold**

**Hold** places the active call on hold. See [Hold on page 126](#).

**Mute**

**Mute** can be activated during a conversation to mute your side of the conversation (handset, headset and speaker-**phone**). When this feature is activated by the **Mute** on/off toggle switch, a bullet appears to the left of **Mute**. The mute feature deactivates the microphone for your speakerphone and handset or headset. Press the toggle key again to reactivate the microphone. (see [Mute Microphone on page 150](#)).

**CallWt**

**Calls Waiting** can be used to view the number of calls waiting for you during a conversation. See [ACD and UCD Hunt Groups on page 53](#).

**Park**

**Park** your call at your station so that you can pick it up at another system station. See [Park on page 159](#).

**Number**

**Number** is used to briefly display the caller's dial number instead of the name.

---

---

**Spk/Hs**

**Speaker/Headset** toggles between speaker and the handset operation. See [Using the Speakerphone or Headset on page 17](#).

**Privac**

**Privacy** puts your FlexSet into **Privacy** mode. This prevents other members of your Boss Group or ELA Group from accidentally joining your conversations.

**ExHold**

**Exclusive Hold** puts your FlexSet into **Exclusive Hold** mode. This ensures that a call placed on hold can be retrieved only at your station. If Exclusive Hold is cancelled, the call put on hold can be retrieved by any other member of your Boss Group or ELA Group.

**DND-WP**

**Do Not Disturb - Whisper Page** is used to enable or block your FlexSet from receiving a message whispered by another station. When this feature is activated, a bullet appears next to **DND-WP**. If you press while on a call, the feature will be active for the duration of the current call only. Ensure **DND-WP** is activated to block your phone from receiving a message whispered by another station.

---

---

## During a Break In

After dialing a busy destination number and choosing **[Brk-In]** (see [Upon Hearing Busy Tone on page 28](#)), both conversing parties can hear your voice. You may press **SPKR** or hang up in order to allow the continuation of the call, or press on one of the following soft keys.

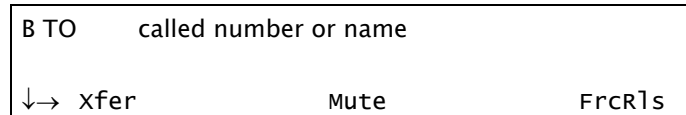

- [Xfer]** **Transfer** is used to converse in private with the caller party (from the original 2-way call). The called party is released. See [Transfer \(Xfer\) on page 190](#).
- [Mute]** **Mute** can be activated during a Break In to mute your side, allowing you to listen to the conversation but not speak. When this feature is activated by **[Mute]** on/off toggle switch, a bullet appears to the left of **[Mute]**. The mute feature deactivates the microphone for your speakerphone and handset or headset. Press the toggle key again to reactivate the microphone (see [page 150](#)).
- [FrcRls]** **Forced Release** enables an authorized user to end the conversation and release two ports actively connected to each other.
- [Dest]** **Destination** is used to converse, in private, with the 3<sup>rd</sup> party. The called party is put on hold. Press again for 3-way conversation.
- [Source]** **Source** is used to converse, in private, with the called party. The 3<sup>rd</sup> party is put on hold. Press again for 3-way conversation.
- [CallWt]** **Calls Waiting** can be used to view the number of calls waiting for you during a conversation.
- [Number]** **Number** is used to briefly display the two port dial numbers instead of the names.
- [Spk/Hs]** **Speaker/Headset** toggles between speaker and the handset operation. See [Using the Speakerphone or Headset on page 17](#).

---

---

## Making External Calls

### When Making External Calls:

- In some systems an outside dial tone must be heard before dialing can begin.
- In some systems using Automatic Routing Selection, internal dial tone or no tone is heard after dialing the access code.
- In some cases (as defined by Class of Service) dialing must begin with a Forced Account code before the called number can be dialed. When Forced Account code is required, the distinctive dial tone will be heard after dialing the external line code, and the ENTER ACCOUNT # message appears on the top line. See [Account Code on page 51](#) and [Caller ID Control on page 75](#).
- **Stop Dial.** Press `[StopDI]` or # after the external number to tell the system that you have finished sending digits over a trunk line. In response the system sends your call immediately towards the destination without waiting for inter-digit time out.
- In certain systems the cost, or number of meter units of the call are displayed, after an external call terminates. This appears for a short while, or until another call is made or received, in the format defined for your system.
- Some systems may be programmed with a limit to the duration of outgoing external calls. Once the limit is reached, the call will be automatically disconnected.
- On external calls routed via an ISDN trunk, call messages are displayed (such as connection status, call fail, etc.). Most messages are for system administrators and technicians and will not be seen during normal operation (see the Message Definitions table below).

Message	Definition
NO B.C:	If the Bearer Capability of the trunk or dial service you are attempting to connect to does not match your station's COS.
NON ISDN ROUTE:	If your station's COS is set to ISDN only and call attempts are made through a trunk group not defined as <b>ISDN only</b> .
QUE GROUP #:	In certain systems if no trunk is available the call may be held in a queue and this displays the number of the queue.

---

---

<b>Message</b>	<b>Definition</b>
CO DISC./USER BUSY:	The party called is engaged.
ON HOOK BY/NORMAL CLEAR:	The called party has hung up (on hook, idle).
CO DISC./CALL REJECTED:	The call cannot be completed because the called party does not allow it.
CO DISC./CAUSE #:	ISDN protocols define error messages, with codes indicating the cause of failed connections. See <a href="#">Appendix D: ISDN Cause Numbers on page 253</a> .

---

---

## Upon Hearing Ringback Tone

After dialing an external destination number, the following features appear on your FlexSet display when you hear the ringback tone. Wait for an answer or press one of the soft keys to activate the required feature.

OUT	trunk line		
DIAL	outside telephone number		
↓→	Msg.	CampOn	Mute

[Msg.]

**Leave Message** is used when dialing a network destination.

If no one answers your call, use this feature to leave a “message” at the called party’s station. This feature lights the message lamp at the called party’s station indicating that a message was left, and a simple message such as CALL SUSAN is left on the destination station’s keyset display. See [Messages: Options on page 135](#).

[Mute]

**Mute** can be activated during ringback so that when the call is answered your side of the conversation is muted and the called party will not hear you. When this feature is activated by the [Mute] on/off toggle switch, a bullet appears to the left of [Mute]. The mute feature deactivates the microphone for your speakerphone and handset or headset. Press the toggle key again to reactivate the microphone. (see [Mute Microphone on page 150](#)).

[AutRdl]

**Auto Redial** is used to have the system automatically redial the unanswered destination. Further redial options are available after activation (see [Redial on page 173](#)).

1. Press [AutRdl]. The system will now automatically redial at timed intervals.
2. When the called party answers, press the flashing **SPKR** key or lift the handset to enable conversation.

[ElapTm]

**Elapsed Time** - not used during ringback.

[CallWt]

**Calls Waiting** is used to view the number of calls waiting for you. See [ACD and UCD Hunt Groups on page 53](#).

---

---

FlashTk	<b>Flash on Trunk</b> is used to send a signal through the system to trunk lines in order to operate certain types of features that are available on the second system. The second system is a telephone switching center, PABX or another Coral system. This feature is also known as Calibrated Opening.
Number	<b>Number</b> is used to briefly display the trunk dial number instead of the name.
Park	Not used during ringback.
StopDI	<b>Stop Dialing</b> is not used during ringback. Press this button <i>before</i> you hear ringback tone, in order to notify the system when dialing out has been completed. In response the system sends your call immediately towards the destination without waiting inter-digit time out.
OCC	<b>OCC</b> is used for users connected with pulse trunks and/or for when your FlexSet is defined with Auto Transfer. This feature enables you to send touch-tone dialing (DTMF tones) over non-DTMF trunks or stations for applications or services (such as Voice Mail) requiring DTMF tones. See <a href="#">Touch-Tone Dialing (DTMF) for Other Common Carriers (OCC) on page 189</a> .
Series	Not used during ringback.
CampOn	<b>Camp On</b> , also known as <b>Call Back</b> . When a network station does not answer, you may request that the system automatically call you back when the required destination number is available. See <a href="#">Calls Waiting: Receiving on page 76</a> .

---

---

## Upon Hearing Busy Tone

After dialing an external destination, the following features appear on your FlexSet display when you hear a busy tone. Hang up and dial later or press the nearby soft key to activate the required feature.

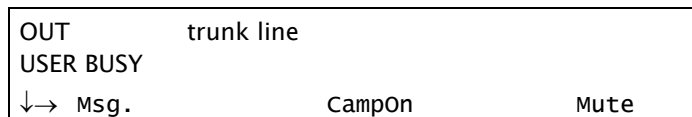

[Msg.]

**Leave Message** is used when dialing network destinations and not external destinations.

Use this feature to leave a “message” at a busy station. This feature lights the message waiting lamp at the called party’s station indicating that a message was left, and it leaves a simple message such as CALL SUSAN on the destination station’s keyset display. See [Messages: Options on page 135](#).

[CampOn]

**Camp On**, also known as **Call Back**. Used only when dialing network destinations and not external destinations. When the network station is busy, you may request that the system automatically call you back when the required destination number is available. See [Calls Waiting: Receiving on page 76](#).

[AutRdl]

**Auto Redial** is used to have the system automatically redial the unanswered destination. Further redial options are available after activation (see [Redial on page 173](#)).

[Save#]

**Save Number** is used to save the dial number of the busy destination. The saved number can then be redialed by pressing [Redial] [Saved#] from idle (see [Redial on page 173](#)).

**NOTE!** *The saved number will remain in memory until another number is saved by repeating the above procedure.*



---

---

## During a Call

The following features are available during an external call:

EXT ANS	trunk line
DIAL	outside telephone number
↓→ Page_Q	xfer
	Hold

**Page Q**

**Page Queue** places your call on hold by sending it to one of ten Page Queue destinations. You are then free to page all the system members from your FlexSet and announce that there is a call for Mr. Doe on a specific Page Queue Line. The call can be picked up from any system station. See [Page Queue on page 151](#).

**Xfer**

**Transfer** passes your call to another destination. Pressing **Xfer** places the called party on hold. Dial a number (internal or external). Disconnect to transfer the call, or first announce the call and then disconnect. See [Transfer \(Xfer\) on page 190](#).

**AutRdl**

**Auto Redial** is used for outgoing calls only. Use Auto Redial to have the system automatically redial the unanswered destination. Further redial options are available after activation. See [Redial on page 173](#).

**Hold**

**Hold** places the active call on hold. See [Hold on page 126](#).

**Mute**

**Mute** can be activated during a conversation to mute your side of the conversation (handset, headset and speakerphone). When this feature is activated by the **Mute** on/off toggle switch, a bullet appears to the left of **Mute**. The mute feature deactivates the microphone for your speakerphone and handset or headset. Press the toggle key again to reactivate the microphone. (see [Mute Microphone on page 150](#)).

**ElapTm**

**Elapsed Time** toggle feature is used to view or cancel the call duration in HH:MM:SS format up to 13 hours (12:59:59). See [Setup on page 232](#).

- 
- 
- Save#** **Save Number** is used to save the dial number of the called external destination. The saved number can then be redialed by pressing **Redial** **Saved#** from idle (*see [Redial on page 173](#)*).
- NOTE!** *The saved number will remain in memory until another number is saved by repeating the above.*
- Park** **Park** your call at your station so that you can pick it up at another system station. See [Park on page 159](#).
- CallWt** **Calls Waiting** is used to view the number of calls waiting for you during a conversation.
- FlshTk** **Flash on Trunk** is used to send a signal through the system to trunk lines in order to operate certain types of features that are available on the second system. The second system is a telephone switching center, PABX or another Coral system. This feature is also known as Calibrated Opening.
- Number** **Number** is used to briefly display the trunk dial number instead of the name.
- OCC** **OCC** is used for users connected with pulse trunks and/or when your FlexSet is defined with Auto Transfer. This feature enables you to send touch-tone dialing (DTMF tones) over non-DTMF trunks and stations<sup>6</sup> for applications or services (such as Voice Mail) requiring DTMF tones. See [Touch-Tone Dialing \(DTMF\) for Other Common Carriers \(OCC\) on page 189](#).
- Series** **Series** is used to mark an external call before transferring it to a third party. This causes the call to return to you after the third party hangs up. This feature can *only* be used during conversation.
- AcctCd** **Account Code** is used to enter an account code for the current external call. The code is marked on the SMDR printout. See [Account Code on page 51](#).
- Privac** **Privacy** puts your FlexSet into **Privacy** mode. This prevents other members of your Boss Group or ELA Group from accidentally joining your conversations.
- ExHold** **Exclusive Hold** puts your FlexSet into **Exclusive Hold** mode. This ensures that a call placed on hold can be retrieved only at your station. If Exclusive Hold is cancelled, the call put on hold can be retrieved by any other member of your Boss Group or ELA Group.

---

---

## Receiving and Answering Calls

There are several ways to answer calls. Answer the call directly by using the conventional methods such as pressing the flashing **SPKR** key, lifting the handset or pressing any flashing key (DSS, LOOP, Line, etc). Other options include using one of the state-related Coral system telephony features before you answer or diverting the unanswered call. The state related features automatically appear, as shown in the display below:

The caller ID is displayed on the top line.

**NOTE!** If caller ID has been blocked (see [Caller ID Control on page 75](#)), the # *RESTRICTED* message for incoming internal calls or # *UNAVA* message for incoming external calls appears on the top line instead.

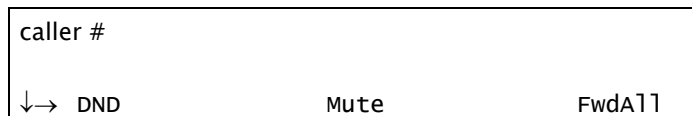

**[DND]** **Do Not Disturb** is used to send a reorder (busy) tone to the incoming call, thus avoiding answering the call. Once DND is activated, all incoming calls will receive reorder tones. See [Do Not Disturb \(DND\) on page 95](#).

**[Mute]** **Mute** can be activated during ringing (before answering) so that when the call is answered your side of the conversation is muted, and the caller will not hear you. When this feature is activated by the **[Mute]** on/off toggle switch, a bullet appears to the left of **[Mute]**. The mute feature deactivates the microphone for your speakerphone and handset or headset. Press the toggle key again to reactivate the microphone. (see [Mute Microphone on page 150](#)).

**[FwdAll]** **Call Forward All.** Use this feature to forward all incoming calls to another destination. To operate, press **[FwdAll]** when your FlexSet is ringing and select the destination. See [Call Forwarding / Follow Me on page 67](#).

---

---

**[All-E]** **Call Forward All External.** Relevant for external calls only. Use this feature to forward all incoming external calls to another destination. To operate, press **[All-E]** when your FlexSet is ringing and select the destination. See [Call Forwarding / Follow Me on page 67](#).

**[Number]** **Number** is used to briefly display the caller's dial number instead of the name.

**[CallWt]** **Calls Waiting** is used to view the number of calls waiting for you (including this incoming call).

**Tip:** See [Divert Call on page 94](#). *Divert is used to divert an incoming call to another system station, group or Library number. Press a preprogrammed DIVERT CALL to XXXX key.*

---

---

## During Idle

The following telephony features appear by default on the third line of your FlexSet display during idle. Alternatively, they can be reached by pressing (FlexSet 120S type B only) **MENU** > **Feat**.

**Tip:** *Features and their locations in the idle state may be redefined to suit changing working stations or adapted to your individual requirements by your system administrator. Not every feature in this guide may have been installed in your system, or at your extension. Check with your system administrator for a list of the specific features installed.*

10:50	26 May 2007	Company xyz
	<i>user name</i>	<i>station number</i>
↓→ Msg	CALLog	Dir

- 
- 
- Msg** is used to view, answer and delete messages, or to leave a message at another system station or at a network number. See [Messages: Options on page 135](#).
- CALLog** allows you to view and redial the most recent incoming/ outgoing calls. See [Call Log on page 71](#).
- Dir** provides you with a searchable directory listing. Both Shared and Personal records are combined and organized alphabetically, for easy retrieval. See [Directory on page 88](#).
- Fwd** enables you to define the conditions under which incoming calls to your station are forwarded to another destination. See [Call Forwarding / Follow Me on page 67](#).
- DND** is used to block all incoming calls to your station. See [Do Not Disturb \(DND\) on page 95](#).
- Music** enables you to activate or cancel background music through the speakerphone, and choose between the available system-defined music sources. See [Music Options on page 149](#).
- FlexiC** allows you to set a telephone located outside the enterprise as your FlexSet's double. Use this feature to edit FlexiCall options. See [FlexiCall on page 105](#).
- Redial** is used to redial the last dialed number, or a number that has been saved. See [Redial on page 173](#).
- Page Q** retrieves a held Page Queue call. A Page Queue call can be picked up from any system station. See [Page Queue on page 151](#).
- Hold** retrieves a call from hold. See [Hold on page 126](#).
- Remind** is used to set, review, or cancel reminders, which will ring your FlexSet at a designated time. More than one reminder can be programmed. See [Reminder on page 177](#).
- Call Pickup** enables you to pickup another ringing station in your system. See [Call Pickup on page 74](#).
- Camp On**, also known as **Call Back**. When a network station is busy or does not answer, you may request that the system automatically call you back when the required destination number is available. See [page 78](#).
- Park**. When a call is parked at your station, **Park** appears with a bullet to the left. Use this function to retrieve the call. See [Park on page 159](#).

---

<code>V-Page</code>	<b>Voice Page</b> is used to call another keyset station. The called keyset station will automatically answer the voice page, acting in a similar manner to an intercom. See <a href="#">Paging: Voice Paging on page 156</a> .
<code>WhspPg</code>	<b>Whisper Page</b> is used to quietly page one party of a two party call. The other party does not hear the whisper page. See <a href="#">Whisper Paging on page 200</a> .
<code>SltMon</code>	<b>Silent Monitor</b> enables an authorized (COS and AUTHORIZATION) user to monitor any port, station or trunk (except conference), without warning to the monitored party. See <a href="#">Silent Monitoring on page 181</a> .
<code>AcctCd</code>	<b>Account Code</b> is used to mark an external call (incoming or outgoing) with an account code, which can be used for later reference/billing. Used to enter an account code for the current external call.. See <a href="#">Account Code on page 51</a> .
<code>IdCtrl</code>	<b>Caller ID Control</b> overrides the system-defined caller ID defaults when making external calls (as well as internal calls, depending on system-wide settings). Thus, if your ID is sent by default when calling external numbers, selecting this will block the number, and vice versa. See <a href="#">Caller ID Control on page 75</a> .
<code>WakeUp</code>	<b>Wake Up</b> is used to set, review, or cancel wakeup calls which will ring your FlexSet at a designated time. More than one wakeup call can be programmed. See <a href="#">Wakeup on page 198</a> .
<code>aWake</code>	<b>Attendant WakeUp</b> is relevant for Attendant Console only. Press <code>aWake</code> to access the attendant wakeup options. See <a href="#">WakeUp on page 214</a> .
<code>Cnflns</code>	<b>Conference Inspect</b> allows you to release a conference participant from an ongoing conference. You may also view the participant list. See <a href="#">Conference Calls: Conference View/Release on page 86</a> .
<code>GpCall</code>	<b>Group Calls</b> is used to activate Group Call Conference features. See <a href="#">Group Calls on page 111</a> .
<code>AcCdUcd</code>	<b>ACD/UCD Options</b> is used to activate ACD/UCD features for Call Center or Hunt group agents. See <a href="#">ACD and UCD Hunt Groups on page 53</a> .
<code>Lock</code>	<b>Phone Lock</b> is used to prevent unauthorized persons from using your phone line. Incoming calls may still be answered. See <a href="#">Phone Lock on page 161</a> .
<code>Exec</code>	<b>Executive Privilege</b> is used to copy all the COS features from any system station to your telephone, in order

---

---

`COS-Sw`

to use features or to dial numbers restricted to the current station. See [Executive Privilege on page 104](#).

**COS Switchover** is used to change your Class of Service from Primary to Secondary or vice versa. Different COS give different dial and feature capabilities to a particular station. See [COS Switchover on page 87](#).

`Setup`

**Setup** is used to program your station for specific feature activation. See [Setup on page 232](#).

`Trace`

**Malicious Call Trace** is used to record the next  $x$  (a system-defined variable) calls to your FlexSet. A list of these calls can be sent to a printer or terminal. See [Individual Remote System Services \(IRSS\) - Freedom on page 127](#).

`aTrace`

**Attendant Call Trace** is relevant for Attendant Console only. Use Attendant Malicious Call Trace to set or print a call trace for any station. See [Malicious Call Trace on page 211](#).

`RoomSt`

**Room Status (or Canned Messages)** is used to toggle the room status definition (or canned message) of your station on or off. See [Room Status on page 178](#) or [Canned Messages on page 81](#).

`aRmSts`

**Attendant Room Status (or Attendant Canned Messages)** is relevant for Attendant Console only. Use the Attendant Room Status feature to toggle the room status definition (or canned message) of any station on or off. See [Room Status on page 212](#) or [Canned Messages on page 208](#).

`BG:Fwd`

**Boss Group: Call Forward** enables you to define the conditions under which incoming calls to your Boss Group are forwarded to another destination. See [Boss Groups: Call Forwarding on page 65](#).

`aFwd`

**Attendant Call Forward** is relevant for Attendant Console only. Used by the attendant to program stations, boss groups and ACD/UCD groups so that incoming calls ring at another destination. See [Call Forward on page 206](#).

`Charge`

**Call Charge** is relevant for Attendant Console only. This attendant feature shows the charges accumulated per station. The attendant may reset and print the Charge Table content. See [Call Charge on page 216](#).

`St.Set`

**Station Setup** is relevant for Attendant Console only. Station Setup allows the attendant to define stations for specific feature activation. See [Station Setup Features on page 218](#).



---

---

Tk.Set

**Trunk Setup** is relevant for Attendant Console only. Trunk Setup allows the attendant to define trunks for specific feature activation. See [Trunk Setup Features on page 227](#).

System

**System Setup** is relevant for Attendant Console only. System features (time, public library, etc) can be edited from this menu. See [System Features on page 221](#).

---

---

## Return Calls

### Options

This class of calls typically indicates Return calls from busy or no answer stations, user errors, system errors or messages that are sent back to the attendant after an operation has succeeded or failed. Calls that are returned to the attendant generally require additional operations. To help you identify the type of return call that is pending, accompanying detailed messages are also shown on the console display.

Use the following guide to navigate through this topic:

<i>Attendant: Intercepted Calls</i> .....	page 48
<i>Attendant: Message Waiting Delivery</i> .....	page 137
<i>Attendant: Ports Without Disconnect Supervision</i> .....	page 49
<i>Attendant: WakeUp Fail</i> .....	page 214
<i>Hold Return</i> .....	page 126
<i>Message Delivery</i> .....	page 136
<i>Page Queue Return</i> .....	page 151
<i>Parked Call Return</i> .....	page 159
<i>Reminder Rings</i> .....	page 177
<i>Series Call Return</i> .....	page 180
<i>Transfer is not Completed</i> .....	page 191
<i>WakeUp Rings</i> .....	page 214

---

---

## Intercepted Calls (Attendant Station)

The attendant may be called upon to assist with intercepted calls to a station. A station's call could be intercepted for the following reasons:

- **Dial Fail:** Incomplete number dialed.
- **COS Fail:** Class of Service denies the use of a certain feature.
- **Toll Barrier:** Block on certain external numbers.
- **Undefined Destination:** The destination is not recognized by the system.
- **Passcode Fail:** Illegal Account Code. VFAC number is not recognized by the system.

INTCPT	caller #	COS #
DIAL/COS/T-BAR/UNDEFINED/FAIL	dialed #	
↓→ DND	Mute	FwdAll

### Answering Intercept:

1. Answer the call. The intercepted caller number and its COS number are displayed on the first line of the display. The second system line displays a written fail message and the dialed number, feature code or outgoing destination number.
2. Ask the caller for the dialed number. If the number is incorrect or a denied feature, the attendant can transfer the call to another destination.

---

---

## Ports Without Disconnect Supervision (Attendant Station)

When two Ports Without Disconnect Supervision (PWDS) are connected, the length of conversation allowed is predetermined. The attendant is called from time to time to control the connection.

PWDS	CALL	your #	
party #1	PWDS	party #2	
↓→ DND		Mute	FwdA11

*Your phone rings*

BTO	party #1	party #	
↓→ xfer		Mute	FrcR1s

*Connected parties hear break-in warning tone*

### Answering return calls – PWDS:

1. Answer the call.
2. The connected parties hear break-in warning tone.
3. Listen for conversation.
4. If the conversation has ended, press **[FrcR1s]** (Forced Release).  
Otherwise, press **SPKR** to continue the call for another period of time.

---

---

# Station Telephony Features

## **Overview**

The following pages detail the rich array of Coral system telephony features available on your FlexSet. Features are accessed by use of the context-sensitive soft keys for ease of use, providing you with a wealth of functionality within easy grasp.

The features can also be operated by using their system dial codes so that they may be programmed into the programmable keys. For more detailed information on feature default dial codes, see [Index: Soft Keys and Feature Codes on page 259](#).

Any feature can be programmed into a programmable key by using its feature code and any required destination number. For example, you may want to program a CALL FWD SUSAN key that automatically forwards all your calls to Susan (see [page 162](#) for instructions on how to program a feature key).

This section is organized alphabetically, on a feature-by-feature basis. Use of this guide is straightforward, with each feature listed separately. However, certain features have various user options. In this case, all of the options are listed under the major feature name; examples of this are ACD & UCD Groups, Boss Groups, ELA Groups and Group Calls.

**NOTE!** The following pages list the features that are available on your FlexSet. Not every feature in this list may have been installed in your system, or at your station/extension. Features are dependent on the assigned Class of Service (COS) levels. Check with your system administrator for a list of the specific features installed.

---

---

## Account Code

An account code can be entered before or during an external (incoming or outgoing) call, causing the call to be marked with the account code on the SMDR (Station Message Detailed Records) printout.

Depending upon your system definition, up to 16 digits are available for account numbers. Only one account number entry is allowed for a single call. Any additional number show the message “ALREADY SET”. Should you dial a wrong account number (when VFAC is installed in your system), the error message “PASSCODE FAIL” appears.

Select  and enter the Account Code.

*Page 1*

10:50	26 May 2007	Company xyz
<i>user name</i>	<i>station number</i>	
†→ S1tMon	<input type="text" value="AcctCd"/>	IdCtr1

*Page 2*

ENTER ACCOUNT # ACCOUNT NUMBER ***** Enter Destination *****
--

---

---

## Activating during external call:

1. Select `[AcctCd]`.
2. Dial the relevant account number.
3. Listen for the confirmation tone.
4. Continue with the call or hang-up.

**NOTE!** *Last Number Redial code, Saved Number code or Speed Number can also be used instead of an outside line where applicable.*

## Activating from idle:

1. Select `[AcctCd]`.
2. Enter the relevant account number or press the outside line key.
3. Enter the external line access code.
4. Dial the external number.
5. Continue with the call.

## Forced Account Code:

In some cases (as defined by Class of Service) dialing must begin with a Forced Account code before the called number can be dialed. When Forced Account code is required, the distinctive dial tone will be heard after dialing the external line code, and the `ENTER ACCOUNT #` message appears on the top line. See [Making External Calls on page 33](#).

---

---

## ACD and UCD Hunt Groups

An ACD/UCD group is a number of stations operating together for the purpose of automatic call distribution. The ACD/UCD groups form the building blocks for modern call centers. The Automatic/Uniform Call Distribution Systems improve incoming call handling by queuing and routing callers. They are used in businesses handling a large volume of incoming calls. ACD/UCD systems prevent incoming callers from receiving busy tones. They encourage callers to wait rather than ring elsewhere.

The incoming calls are distributed among a group of agents. Agents can log in or out of the group. When all lines are in use, an announcement plays for callers waiting in queue. If the queue is full, calls are routed to a predetermined telephone number.

Calls incoming to an ACD/UCD group are answered by free agents, according to system wide defined rules. The most commonly used rule by an ACD is for the longest waiting call to be answered by the agent who has been waiting for a call for the longest period of time. UCD groups do not provide call distribution to the longest waiting staff. The UCD system automatically delivers each incoming call to the next available agent's line.

Select [AcidUcd](#) to access the ACD and UCD options.

Page 1

10:50	26 May 2007	Company xyz
	<i>user name</i>	<i>station number</i>
↑→	<a href="#">AcidUcd</a>	Lock Exec

Page 2

ACD & UCD Hunt Groups		
↓→	Callwt	LoadID LogI/O



---

---

**CallWt** provides you with the ability to view the number of calls waiting for any ACD group. To view the number of waiting calls, press **CallWt**, and enter the ACD group number at the prompt.

Alternatively, if the Calls Waiting ACD# programmable key for your group is flashing, view the number of waiting calls for your group (even during a call) by simply pressing the key. The number of waiting calls is displayed on the top line.

*To program a Calls Waiting ACD# key, see [page 162](#).*

**LoadID** is used to load your ID into the system, identifying you as an ACD agent. A bullet appears next to **LoadID** to indicate your ID is loaded.

Once registered within the system, you may join as many ACD Groups as required. Your ID remains in the system provided you remain logged into at least one ACD Group. You may load a different ID number while logged in, which will override the previous ID.

1. Press **LoadID**. Your current ID number appears on the display.
2. Enter your ID number at the prompt (4 digits).
3. Listen for the confirmation tone.

**LogI/O** enables you to join or leave an ACD Group. You may belong to more than one group simultaneously. To join an ACD group:

1. Press **LogI/O**.
2. Dial the ACD group. The ID number is displayed on the middle line.
3. Choose **Set** to join the group or **Cancel** to leave the group.
4. Listen for the confirmation tone. The ASSIGN message indicates that you are logged in, while the DE-ASSIGN message on the top line indicates you are logged out.
5. If you have not loaded your ACD 4 digit ID number, the NO ID, LOGIN message appears. In this instance, load your ID number and restart the login process.
6. To join additional groups, repeat Steps 1-4.
7. If you are a member of more than one ACD group, use the Primary Login feature (see [below](#)) to define one of those groups as your primary group.

---

---

**PrmLog**

**Primary Login Group.** If you are a member of more than one ACD group, you can use this feature to define one of those groups as your primary group. Once you have logged into your primary group, waiting calls will always be routed to you from this group *first*.

1. Press **PrmLog**.
2. Dial the primary ACD group number.
3. Choose **Set** to join the group or **Cancel** to leave the group.
4. If you have not loaded your ACD 4-digit ID number, the NO ID, LOGIN message appears. Load your ID number.

If this feature is activated, a bullet appears next to **PrmLog**.

**NOTE!** *If no group is defined as primary or if log out is defined for the primary group, then the first group you logged into (previous page) is defined as primary by system.*

**RlsRsm**

**Release/Resume.** Press **RlsRsm** to temporarily leave all the ACD/UCD groups of which you are a member. Press again to rejoin your group/s. When released a bullet appears next to **RlsRsm**.

The top line will show RELEASED ALL when you leave your group/s and RESUMED ALL when you rejoin.

You will be automatically released from all groups of which you are a member if you do not answer a call within a predetermined time (defined system-wide).

**RlsUCD**

**Release UCD** is used to temporarily exit (or rejoin) the UCD group of which you are a member.

1. Press **RlsUCD**.
2. Dial your UCD Hunt group number.
3. Press **Set** to exit or **Cancel** to rejoin.
4. Listen for the confirmation tone.

**NOTE!** *You can preprogram a feature key for use as a toggle key. To program a Release/Resume UCD# key, use feature code #1991 followed by the specific UCD group number.*

---

---

**WrapTm**

**Wrap Time** is used to provide an idle ACD/UCD group member with a time-out period between consecutive group calls. The time-out period is determined for each group on a system-wide basis. This feature allows the agent to utilize the wrap-up code without interference from outside calls.

1. Press **WrapTm**.  
WRAP-UP ON appears on the system display line and a bullet appears next to **WrapTm**.
2. Press **WrapTm** again to end the Wrap-Up time interval.  
WRAP-UP OFF appears on the system display line.

**WrapCd**

**Wrap Code** is used to send the appropriate wrap-up code for the last incoming ACD call you answered. See your ACD Supervisor for an updated list of codes.

1. Press **WrapCd**
2. Dial the appropriate 4-digit code number.
3. Listen for the confirmation tone.

**ACDBsy**

**Busy ACD Group**, an Attendant feature, enables the attendant to define the maximum number of calls that can be placed in a waiting queue for any ACD group. Once this number is reached, additional calls arriving at the ACD group will hear the busy tone.

1. Press **ACDBsy**.
2. Dial an ACD group number or press the  buttons to scroll between the ACD groups.  
**Next** and **Prev** appear, which can also be used to scroll between groups.
3. Choose **Charge** (change call number) to change the maximum number of callers that will hear the busy tone.
4. Enter a 3-digit number with leading zeros, up to 254 (e.g. 023 for 23).
5. Choose **Cancel** to delete the limitation.
6. Press **Exit** to terminate.

**MoveSt**

**Auto Set Relocate** (move station) is designed for use as hot seat-feature in call center environments, allowing you to move your station and all your station's predefined features to a new location. See [Auto Set Relocate on page 58](#).

---

---

## ***Activation Code***

Use the Activation code (default code: #11, #\*1, or \*1) as required when programming features.

The following symbol in this manual indicates an activation code: ✓

See your system manager, as to which activation code is used in your system. The activation code can be entered by dialing or programming a key with the code, or adding the code to the program of a feature key.

---

---

## Auto Set Relocate

Auto Set Relocate enables you to transfer your station and all your station's predefined features to a new location, thus sparing you the inconvenience of having to re-enter all the stored speed numbers and to reset previously defined features at your new permanent or temporary location. This feature enables you to use any FlexSet available from your Coral system while keeping your unique extension dial number. FlexSets are defined to have either the Permanent (see [page 59](#)) or Temporary (see [page 60](#)) Auto Set Relocate feature enabled. Before activating this feature, contact your system administrator to determine what your Auto Set Relocate setting is. If you are defined as permanent, you will not be able to use temporary (unless redefined by your system administrator), and vice versa.

**NOTE!** *When invoking the Auto Set Relocate feature, incorrect information may be sent to the local Emergency or E911 Center. Before activating this feature, contact your local administrator to ensure that your new and current system profiles are compatible with the E911 Center.*

Auto Set Relocate is accessed by selecting   from the idle screen.

Page 1

10:50	26 May 2007	Company xyz
	<i>user name</i>	<i>station number</i>
↑→ COS-Sw	<input type="button" value="Setup"/>	Trace

Page 2

Feature Setup
↑→ EXH01d <input type="button" value="MoveSt"/>

Page 3

RELOCATE ENTER SOURCE NO.
------------------------------

---

---

## Auto Set Relocate: Permanent

When defined for permanent relocation, this feature enables you to swap phones within the same Coral system by assigning one FlexSet the profile of the other FlexSet, and vice versa. All the phones' properties, numbering, programmable keys, membership in groups, etc. are automatically exchanged. This feature facilitates the phone relocation procedure, eliminating the need for traditional phone moves that involve physical disconnection of the station wires and reconnection at another location. Both source and destination phones (see figure below) should be FlexSets. The Auto Set Relocate is activated at the destination station. The phone swap holds until a reverse swap is performed.

### Activating from the Destination (new) location

1. Select **[Setup]** **[MoveSt]** or **[AcUcd]** **[MoveSt]**.
2. Dial your (source) station number.
3. Enter your (source) passcode (4 digits).
4. Dial the activation code ✓.
5. The station now initializes with the source profile.

### Reversing from the Source (original) location

Repeat the above procedure from your original source location.

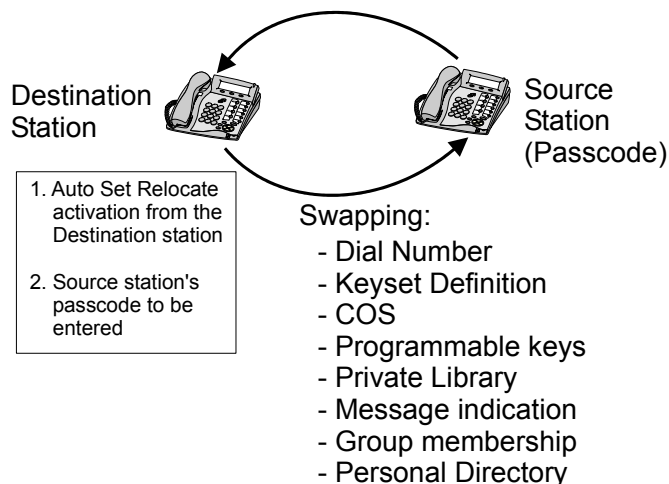

---

---

## ***Auto Set Relocate: Temporary***

When defined for temporary relocation, this feature allows a temporary move of your extension from one location to another, while preserving your extension's original setup. The Auto Set Relocate function enables you to access customized features of your FlexSet from another FlexSet. By activating the feature you can relocate all of your (source) phone's programmable keys, numbering, membership in groups, etc. to another (destination) phone located elsewhere within the same Coral system. As this takes place, the source phone acquires the full profile of the destination phone, and vice versa.

The Auto Set Relocate is activated at the destination station. The temporary phone swap is automatically reversed at midnight. Reactivating Auto Set Relocate at the already swapped destination station causes:

- Automatic cancellation of the first relocation
- Exchange of the new (third user's) phone profile with the destination phone profile

### **Activating from the Destination (new) location:**

1. Select **[Setup] [MoveSt]** or **[AcdUcd] [MoveSt]**.
2. Dial your (source) station number.
3. Enter your (source) passcode (4 digits).
4. Dial the activation code ✓.
5. The station now initializes with the source profile.

### **Canceling from the Destination (new) location:**

1. Select **[Setup] [MoveSt]** or **[AcdUcd] [MoveSt]**.
2. Dial your (source) station number.
3. Enter your (source) passcode (4 digits).
4. To cancel, dial the cancellation code ✕.
5. The station now initializes with its original profile.

---

---

## ***Boss Groups***

A Boss Group is a number of stations operating together in which the individual stations may or may not simultaneously ring, as defined by the system per Boss Group.

Members of a Boss group share a **LINE** key which functions very much like a common line among keysets. The appropriate **LINE** key flashes at all stations when a call arrives and can then be answered by any group member.

Calls directed to a Boss Group ring at all members assigned to ring within the group, then may be directed to any members that are assigned to ring after a delay (ring delay after time-out).

When set to ring at a specific station, the call can be either transferred to any group member or picked up by any group member when the original group member is not in exclusive hold. Any group member can join a conversation for '1A2' or 3-way conversation by pressing the appropriate illuminated **LINE** key, but only when the original group member is not in **Privacy** mode. Additional members can join to make a 4-way conversation when allowed system-wide, and none of the three participants have **Privacy** on.

To program a line key, see [page 162](#).

The maximum number of lines available for your group is defined on a per group basis.

Use the following guide to navigate through this section:

<a href="#">Boss Groups: Using</a> .....	page 62
<a href="#">Boss Groups: Privacy</a> .....	page 63
<a href="#">Boss Groups: Exclusive Hold</a> .....	page 64
<a href="#">Boss Groups: Call Forwarding</a> .....	page 65



---

---

## ***Boss Groups: Using***

### **Making calls:**

1. Press a free **LINE** key.
2. Dial the required number.

**NOTE!** *The line key LED of all group members changes from off to steady on.*

### **Receiving calls:**

When the line flashes (note that the telephone may also ring):

1. Press the flashing **LINE** key or, if phone rings, lift the handset.
2. Answer the call.

**NOTE!** *The line key LED of all group members now changes from flashing to steady on.*

### **Joining a group conversation (1A2 type):**

You can join any group conversation when a **LINE** key is lit, with two exceptions:

- When the member's station is set to privacy, in which case the message **PRIVACY** is displayed and a reorder tone is heard, or
- When another member has already joined the conversation and the group is not defined for 4 members, in which case the message **ILLEGAL** is displayed and a reorder tone is heard.

To join the group conversation, press the lit **LINE** key.

---

---

## ***Boss Groups: Privacy***

As a Boss Group member you can put your telephone into **Privacy** mode. This prevents other FlexSet stations within your Boss Group from accidentally joining your conversations.

The feature can be utilized for a specific call or for all calls.

### **Operating Privacy for all calls**

To operate this feature for all calls, see [page 238](#).

### **Operating Privacy for current call**

You may override the station Privacy setting on a call-by-call basis. Thus, if your station is in **Privacy** mode, you may remove the Privacy restriction and allow others to join your conversation; alternatively if your station is not in **Privacy** mode, you may apply Privacy to a specific call.

This is done by pressing **[Privac]** during a call. Press this key to toggle the feature on and off. This key can be pressed as many times as necessary.

Once Privacy is defined for your station (all calls) the Privacy key LED remains illuminated, and a bullet is displayed next to **[Privac]**, even if the key is pressed to temporarily override the Privacy feature. However, when your call is completed the telephone will return to the permanent status, private or non-private, as previously defined for all calls.

---

---

## ***Boss Groups: Exclusive Hold***

As a Boss Group member, you can put your telephone into Exclusive Hold mode. This ensures that a call you place on hold can be retrieved only at the station where Exclusive Hold was originally placed. If Exclusive Hold is cancelled, the call put on hold can be retrieved by any other member of your Boss Group, by pressing the flashing **LINE** key. The feature can be utilized for a specific call or for all calls.

### **Operating Exclusive Hold for all calls**

To operate this feature for all calls, see [page 238](#).

### **Operating Exclusive Hold for current call**

You may override the station Exclusive Hold setting on a call-by-call basis. Thus, if your station is in Exclusive Hold mode, you may remove the Exclusive Hold restriction and allow others to pick up your held call; alternatively if your station is not in Exclusive Hold mode, you may apply Exclusive Hold to a specific call. This is done by pressing **[ExHold]** during a call before pressing **HOLD**. Press this key to toggle the feature on and off. This key can be pressed as many times as necessary. If your telephone is not in Exclusive Hold mode for all calls, press **[ExHold]** before you press **[Hold]**. Press **[Hold]** to place a call into Exclusive Hold. The **LINE** on hold will remain steady on at all other FlexSets, and the call will only be retrievable from your station.

### **Transferring call to a group member (during conversation):**

Once Exclusive Hold is defined for your station (all calls) the Exclusive Hold key LED remains illuminated, and a bullet is displayed next to **[ExHold]**, even if the key is pressed to temporarily override the Exclusive Hold feature. However, when your call is completed the telephone will return to the permanent status, as previously defined for all calls. If your telephone is in Exclusive Hold mode for all calls, press **[ExHold]** before you press **[Hold]**.

1. Press **[Hold]**. The **LINE** on hold will flash at all FlexSets.
2. Listen for the confirmation tone.
3. Inform the party to whom you wish to transfer on which line the call is on hold.

### **Returning or picking up a call on hold:**

Press the flashing **LINE** key.

---

---

## Boss Groups: Call Forwarding

Calls arriving at your Boss Group can be forwarded, according to certain criteria, to ring at various destinations.

Calls incoming from an external source only can be forwarded using `All-E`, `Busy-E`, `NoAn-E`, and `Time-E`. Additionally, calls from Internal and External sources can be forwarded to different destinations, as described on [page 70](#).

Possible destinations are operator, station/group, external number via public and private speed call library, DVMS pre-recorded message, UNA/central bell, group call, or network number (and the Boss Group itself for external calls).

Boss Group Call Forwarding options are accessed by selecting `BG:Fwd` from idle state.

Page 1

```
10:50 26 May 2007 Company xyz
      user name  station number
↑→ Trace                RoomSt      BG:Fwd
```

Page 2

```
Boss Group: Call Forward
E=External
↓ All                All-E                •Busy
```

`All` or `All-E`

**Forward All.** Forwards your incoming Boss Group calls to another destination. The destination can call back or return calls to your group, and outgoing calls can still be placed from within the group.

`Busy` or `Busy-E`

**Forward Busy.** Forwards your incoming Boss Group calls to another destination when your Boss Group lines are all busy.

`NoAns` or `NoAn-E`

**Forward No Answer.** Forwards your incoming Boss Group calls to another destination when none of your Boss Group lines are being answered.

`Time` or `Time-E`

**Forward Timed.** Forwards your incoming Boss Group calls to another destination during specific, system-defined time periods. See table on [page 68](#).

---

---

## Operating Boss Group: Call Forward:

1. Select **[BG:Fwd]**.
2. Press the required forwarding option (**[All]**, **[All-E]**, **[Busy]**, **[Busy-E]**, **[NoAns]**, **[NoAn-E]**, **[Time]**, **[Time-E]**).
3. Press **[St/Gp#]** and dial your boss group number, OR  
Scroll between groups by using **[PortUp]**, **[FastUp]**, **[PortDn]** and **[FastDn]**.
4. To set Call Forward, choose **[Dest]** and dial the destination number to which calls are to be forwarded, OR  
To cancel Call Forward, choose **[Cancel]**.
5. Press **SPKR** or **[Exit]** to exit and save.

---

---

## Call Forwarding / Follow Me

Calls arriving at your station can be forwarded to ring at various destinations, depending on the state of the terminal (all, busy, no answer, timed). In addition to the forwarding options detailed above, your FlexSet can distinguish between calls arriving from an internal or external source when forwarding.

Calls incoming from an external source only can be forwarded using **[All-E]**, **[Busy-E]**, **[NoAn-E]**, and **[Time-E]**. Additionally, calls from Internal and External sources can be forwarded to different destinations, as described on [page 70](#). Possible destinations are operator, station/group, external number via public and private speed call library, DVMS pre-recorded message, UNA/central bell, group call, or network number (and the station itself for external calls).

A bullet appears next to any active forwarding feature on the Forwarding Options screen (page 2 below), and an additional bullet appears next to **[Fwd]** on the idle screen (Page 1 below).

Forwarding options are accessed by pressing **[Fwd]** from idle state.

Page 1

10:50	26 May 2007	Company xyz
	<i>user name</i>	<i>station number</i>
↑→	• <b>[Fwd]</b>	Music DND

Page 2

Call Forwarding		
E=External BNA=BusyNoAns		
↓→	FwdAll	All-E •Busy

---

---

[FwdAll] or [All-E]

**Forward All.** Forwards your incoming calls to another destination. The destination can call back or return calls to your terminal, and you can still place outgoing calls from your terminal.

If [FwdAll] or [All-E] is activated, a \*FwdAll\* message appears on the top line to remind you that this feature has been activated at your station, and the Distinctive Dial Tone sounds upon lifting your handset (see [Appendix B: Tones on page 249](#)).

**NOTE!** Call Forward All activation is also available during an incoming call (when ringing). See [below](#).

[Busy] or [Busy-E]

**Forward Busy.** Forwards your incoming calls to another destination when your terminal is busy.

[NoAns] or [NoAn-E]

**Forward No Answer.** Forwards your incoming calls to another destination when you do not answer within a system-defined number of rings.

[BNA] or [BNA-E]

**Forward Busy/No Answer.** Forwards your incoming calls to another destination when your terminal is busy, or when you do not answer within a predetermined number of rings. [BNA] enables you to program [Busy] and [NoAns] in one action, while [BNA-E] enables you to program [Busy-E] and [NoAn-E] in one action.

[Undef]

**Undefined.** Forwards your incoming calls to another destination when your station is unplugged.

[Time] or [Time-E]

**Forward Timed.** Forwards your incoming calls to another destination during specific, system-defined time periods. The system-defined time can include up to two separate time periods, for example, between 12:00pm and 12:30pm and between 6:00pm and 6:30pm your calls can be forwarded to the front desk.

Use the following table to document the system-defined time periods:

Time Period	From	To
1 <sup>st</sup>		
2 <sup>nd</sup>		

[FllwMe] or [Fllw-E]

**Follow Me.** Allows you to collect your calls from another station. The source station is then put into a Call Forward All state; [FwdAll] or [All-E] respectively.

---

---

## Operating Call Forward:

1. Choose the required forwarding option ([FwdAll], [All-E], [Busy], [Busy-E], [NoAns], [NoAn-E], [BNA], [BNA-E], [Undef], [Time], [Time-E]).
2. You may scroll through the other forwarding options with the  button or [Next] and [Prev].
3. To set Call Forward, dial the destination number, OR  
To cancel Call Forward, choose [Cancel], OR  
To change the Call Forward destination, choose [Dest] to enter destination and dial the destination number.
4. Listen for confirmation tone.

## Operating Follow Me:

1. Choose [FlwMe] or [Flw-E] from the location where you wish the calls to be forwarded.
2. Dial the number of your own (source) station (i.e. from which you wish to collect the calls).  
A \*FOLLOW ME *source user name*\* message appears on the top line of your destination station.
3. To activate, choose [Set].  
OR  
To cancel, choose [Cancel].
4. Listen for confirmation tone.

## Canceling Follow Me from the source location:

1. Choose [FwdAll] or [All-E] from your own (source) station.
2. Choose [Cancel].
3. Listen for confirmation tone.



## Internal/External Call Forwarding

In addition to the forwarding options detailed above, your FlexSet can distinguish between calls arriving from an internal or external source when forwarding. For each forwarding feature (forward all, when busy, on no answer, etc), you can program your FlexSet to forward your calls as follows:

- Forward Internal and External calls to the same destination
- Forward Internal and External calls to different destinations
- Forward Internal calls only, while External calls keep ringing at your station
- Forward External calls only, while Internal calls keep ringing at your station

This is demonstrated in the following table using the **[FwdAll]** and **[All-E]** feature as an example:

Case	Forward Option			Resultant Call Destination	
	<b>[FwdAll]</b> Set To:		<b>[All-E]</b> Set To:	Internal Calls Go To	External Calls Go To
1	Cancel (not set)	and	Cancel (not set)	Your Station	Your Station
2	Destination X	and	Cancel (not set)	Destination X	Destination X
3	Cancel (not set)	and	Destination Y	Your Station	Destination Y
4	Destination X	and	Destination Y	Destination X	Destination Y
5	Destination X	and	Destination Y (programmed as Your Station)	Destination X	Your Station

Possible destinations for X are: operator, station/group, external number via public and private speed call library, DVMS pre-recorded message, UNA/central bell, group call, or network number.

Possible destinations for Y are the same as for X, plus your own station number, thus facilitating forwarding of internal calls to another destination, whilst retaining external calls at your own station, as shown in Case 5 above.

---

---

## Call Log

The Call Log feature allows you to view and redial the most recent outgoing and incoming calls to your station. (The maximum number of calls that can be stored in the log are determined by your type of phone and system setup, as defined by your system administrator.) Calls are displayed with the name and number (where available).

If the name is unavailable, just the number will be shown.

If the number is unavailable, the Call Log will display `Unknown Number`.

If the number is restricted, the Call Log will display `Restricted Number`.

If incoming calls are not answered, a message indicating the number of new calls is displayed on the FlexSet idle screen:

`< xx New Calls >`, where `xx` indicates the number of new calls. This count is reset to zero once the Call Log is viewed, and is not shown again until there are new calls logged.

For FlexSet 120S (Type B), see Call Log Setup options, on *page 241*.

Press `[CALLog]` to access the Call Log options. If no calls are logged for your station, the `< No Calls Logged >` message is displayed.

*Page 1*

10:50	26 May 2007	Company xyz
<02 New Calls>		
↓→ Msg	<code>[CALLog]</code>	Dir

*Page 2*





Call Log		
→ Out	•In	ESC

---

---

 **Outgoing Call Log** is used to view the most recent outgoing calls made from your station.

 **Incoming Call Log** is used to view the most recent calls made to your station.

A bullet appears next to  or  to indicate when outgoing or incoming calls are logged for your station. If no calls are logged, pressing  or  displays the < No Calls Made > or < No Calls Received > message, respectively.

Page 3

In	10:00 29 May, 2006		
↓√	01: Steve Williams 7652345 (xx)		
→	Delete	Dial	Number

Use  to scroll through the call records. The calls are listed in order of receipt/dialing, and are numbered accordingly at the left of the call display, with the most recent listed first. In the example above, 01: Steve Williams 7652345 indicates that Steve Williams was the most recent person to call/be called.

**NOTE!** The maximum number of calls that can be stored in the log are determined by your type of phone and system setup, as defined by your system administrator. *Once this number is reached, any new calls added to the call log will result in the oldest record being deleted, on a first in, first out basis.*

If an incoming call was originally answered, or has subsequently been dialed from the call log record, the ‘√’ symbol appears to the left of the call display, as shown in the above example.

The keyset excludes duplicate numbers in the Call Log. A duplicate number is one that has called your station, or that has been called, more than once. Only the most recent call is displayed for each logged name/number. The number of times that they called is displayed in parentheses after the name and number, as shown in the diagram above. Once the Call Log has been viewed, this number resets to zero and is hidden.

---

---

For FlexSet 120S (Type B): When new incoming calls are viewed in the Call Log, and the Call Log is set to hide duplicate numbers ( **Duplic** = No , as described on *page 241*), the number of times that they called is displayed in parentheses after the name and number. Once the Call Log has been viewed, this number resets to zero and is hidden.

The following options are available:

**Delete** Choose **Delete** to delete the selected entry from the call log.

**Dial** Choose **Dial** to dial the selected entry from the call log.

**Name** / **Number** If the combined size of the logged name and number is larger than the display area (19 characters), the display shows only the name. An additional context-sensitive soft key is presented allowing you to toggle between viewing the number or the name. When a name is displayed, choose **Number** to view the dial number. When a number is displayed, choose **Name** to view the name.

---

---

## Call Pickup

This feature enables you to pick up any ringing station or central bell within your system or pre-programmed Pickup Group.

Press **[Pickup]** to access the Pickup options.

Page 1

10:50	26 May 2007	Company xyz
<i>user name</i>	<i>station number</i>	
↑→ Remind	<b>[Pickup]</b>	Campon

Page 2

Call Pickup		
→ Direct	Group	Night

**[Direct]** **Direct Call Pickup** (default dial number: #180 or 77) is used to answer any ringing station in your system. At the prompt, dial the number of the station that is ringing and answer the call.

**[Group]** **Group Call Pickup** (default dial number: #181 or 76) is used to answer any ringing station in your Pickup Group. The call connects immediately upon pressing **[Group]**.

**NOTE!** See your system administrator to define your own Pickup Group.

**[Night]** **Night Call Pickup** (default dial number: #192) is used to answer incoming calls after the attendant leaves or when a central bell is ringing. Normally this feature is activated for incoming calls during the night answering period. The call connects immediately upon pressing **[Night]**.

---

---

## Caller ID Control

This feature enables you (from idle) to allow or restrict the presentation of your phone number from appearing on the display of the called external party (as well as internal party, depending on system-wide settings). Your telephone is pre-set in the system to either restrict or display for all calls. Use **[IdCtrl]** to override this setting on a per-call basis (if permitted by COS).

Press **[IdCtrl]** to dial using ID Control.

Page 1

```
10:50  26 May 2007  Company xyz
                user name  station number
↑→ S1tMon                AcctCd                [IdCtrl]
```

Page 2

```
DIAL
ID. RESTRICTED
***** Enter Destination *****
```

### Operating Caller ID Control:

1. Press **[IdCtrl]**.
2. Dial the number.
3. Your call automatically connects. If your Coral system is set to restrict caller ID, it will now be presented to the called party, and vice versa.

**NOTE!** When you have a Caller ID programmed key, the LED is lit when Caller ID Control is restricted from your station.

## Calls Waiting: Receiving

The call waiting tone, voice paging tone or muted ring indicates that another call is waiting for you to answer. When you hear this tone, or when the second row displays a call waiting message, you have the following choices:

Action		Method
Current Call	Waiting Call	
<b>Hold</b>	Answer	<ol style="list-style-type: none"> <li>1. Press <b>[Hold]</b></li> <li>2. Upon hearing the ring, answer the waiting call</li> </ol>
Join in 3-way mode		Press flashing button (only available if your FlexSet is defined as Auto Join)
<b>Continue</b>	Redirect	Press a preprogrammed DIVERT CALL to XXXX key. See <a href="#">Divert Call on page 94</a> . Divert is used to divert an incoming call to another system station, group or Library number.
<b>Continue</b>	View number of waiting calls	<ul style="list-style-type: none"> <li>• Press <b>[CallWt]</b> (see <a href="#">Receiving and Answering Calls on page 40</a>); or</li> <li>• For a specific ACD group, press a preprogrammed <b>Call Waiting ACD</b> DSS button</li> </ul>

Action		Method
Current Call	Waiting Call	
<b>Hold/Continue</b>	<p>Join in Broker/ Consultation/3-Way/ Combination Conference Call</p> <p>(All the following features are activated after the waiting call is answered.)</p>	<p>Press to put the current call on hold and answer the waiting call. Press again to establish one of the following call types:</p> <p><b>To activate a Broker Call</b></p> <ul style="list-style-type: none"> <li>Press <b>[XFER]</b> to alternate between the parties (any number of times) Then either:</li> <li>Press <b>[SPKR]</b> or hang up in order to allow conversation between the two parties; <i>or</i></li> <li>Press <b>[FrcRls]</b> to release all parties and press <b>[SPKR]</b></li> </ul> <p><b>To activate a Consultation Call</b></p> <p>When your conversation is concluded, press <b>[XFER]</b> to return to the original call (the consultation is released)</p> <p><b>To activate a 3-Way Call</b></p> <ul style="list-style-type: none"> <li>Press <b>[FrcRls]</b> to release the third party and return to original call (same as Consultation Call); <i>or</i></li> <li>Press <b>[XFER]</b> to connect all three parties</li> </ul> <p><b>To activate a Combination Call</b></p> <ol style="list-style-type: none"> <li>Press <b>[XFER]</b> to put the third party on hold</li> <li>After concluding the private conversation, press <b>[XFER]</b> to complete a 3-Way Conference Call</li> </ol> <p><b>To add members to a 3-Way Call (Continuous Conference)</b></p> <ul style="list-style-type: none"> <li>Press the <b>Last Party Release</b> DSS key to release the last party to join the conference; <i>or</i></li> <li>Press to connect a new member to a 3-way call (becomes Continuous Conference Call)</li> </ul>



---

---

## Camp On (Call Back)

Use this feature when a station or a network destination is busy or does not answer, or when an outside line is busy, to request that the system automatically call you back when the required destination number or line is available. (Upon hearing a busy tone originating from an external destination, use the auto redial [\[AutRd\]](#) feature instead - see [page 35](#).)

Answering the call causes the camped on station to immediately ring.

Camp On can also be operated from idle.

Camp On is automatically cancelled after a system-wide defined period after activation.

Press [\[CampOn\]](#) to camp on to the unavailable line.

Page 1

```
10:50  26 May 2007  Company xyz
                user name  station number
↑→ Remind                Pickup                \[CampOn\]
```

Page 2

```
CAMPING ON
LIST EMPTY
***** Enter Destination *****
```

### Camping On upon hearing a busy tone:

1. Press [\[CampOn\]](#) after hearing the busy tone.
2. The *CAMPING ON Name* message appears to inform you that you are camped on.  
Alternatively, press [\[SendCw\]](#) to send a call waiting tone to the busy station. The station is now made aware that another call is waiting. Your side hears a second (quicker) ringback tone (system-wide defined).

---

---

## Camping On while your FlexSet is idle:

1. Press **[CampOn]**.
2. Dial the destination number.
3. The *CAMPING ON Name* message appears to inform you that you are camped on.

## Entering additional destinations to the Camp On list:

1. Press **[CampOn]**.
2. Choose **[Dest]** to enter destination.
3. Dial the destination number.
4. The *CAMPING ON Name* message appears to inform you that you are camped on.

## Canceling a number from the Camp On list:

1. Press **[CampOn]**.
2. Use **[Next]** or the  button to scroll through the list of Camp On destinations and select a destination.
3. Choose **[Cancel]** to cancel Camp-On.

When the line is available, the system will call you back. Answer the call to automatically dial the camped on station/trunk (or should you hear the distinctive dial tone (defined system-wide), press **[CampOn]** to initiate ringing).

**For Trunks Only:** *After the trunk line is free, you must continue dialing the outside dial number for external numbers.*

---

---

## ***Cancellation Code***

Use the Cancellation code (default code: #10, #\*0, or \*0) as required when programming features.

The following symbol indicates a cancellation code: ✖

See your system manager, as to which cancellation code is used in your system. The cancellation code can be entered by dialing or programming a key with the code, or adding the code to the program of a feature key.

---

---

## Canned Messages

Use this feature to set one of any 16 canned messages for your station. Any internal caller to your station sees this message displayed on the second line of their display panel until you answer the call.

Canned message texts are pre-programmed by your system administrator. They can be used to indicate your status (or any other pertinent information) to the calling party. Contact your system administrator for the list of canned message texts used in your organization. Use the [Table on page 82](#) to list the canned messages available at your telephone.

**NOTE!** Check with your system administrator whether your Coral system supports the Canned Messages or Room Status feature. If your Coral system supports the Room Status feature (see [page 178](#)), the Canned Message feature is unavailable.

Press **[RoomSt]** to access the Canned Messages options.

Page 1

```
10:50 26 May 2007 Company xyz
      user name  station number
↑→ [RoomSt]
```

Page 2

```
Room Status
↓→ RmSts0          RmSts1          RmSts2
```

**[RmStsx]**

Press the required Canned Message soft key (**[RmStsx]** where  $x=0$  to 15, see [Table on page 82](#)) to activate. The canned message appears on the top line. When activated, a bullet is shown next to **•[RmStsx]**, and next to **•[RmSts]**. To cancel, press the relevant lit **•[RmStsx]** key again.

**NOTE!** The first canned message that you activated is the one that appears on the internal caller's display panel. Therefore, to set a new message ensure that you cancel all previous messages.

**Canned Message - Text and User Access Codes**

<b>Canned Message Number</b>	<b>Soft Key</b>	<b>Access Code (Dial Pad#)</b>	<b>Canned Message Text</b>
0	[RmSts0]	7026	
1	[RmSts1]	7027	
2	[RmSts2]	7028	
3	[RmSts3]	7029	
4	[RmSts4]	7030	
5	[RmSts5]	7031	
6	[RmSts6]	7032	
7	[RmSts7]	7033	
8	[RmSts8]	7034	
9	[RmSts9]	7035	
10	[RmSs10]	7036	
11	[RmSs11]	7037	
12	[RmSs12]	7038	
13	[RmSs13]	7039	
14	[RmSs14]	7040	
15	[RmSs15]	7041	

---

---

## **Conference (Multi-Party) Calls**

Conference calls allow several users to carry on a multi-party conversation. Up to 6 or 15 participants are permitted, depending on the system hardware assigned to the conference call.

Use the following guide to navigate through this section:

<a href="#">Conference Calls: Meet Me</a> .....	page 84
<a href="#">Conference Calls: Conference Multi-Party Lock</a> .....	page 85
<a href="#">Conference Calls: Conference View/Release</a> .....	page 86

---

---

## Conference Calls: Meet Me

### Joining a conference:

Dial the conference number (7098-7099) at the assigned time.

**NOTE!** A warning tone will be heard by all the participants.

### Adding an additional party to a conference:

1. Press **Xfer**.
2. Dial the assigned conference number.
3. Press **SPKR** or hang up to leave the conference, or remain on the line to stay connected to the conference.

**NOTE!** A warning tone will be heard by all the participants.

### Leaving a conference:

Press **SPKR** or hang up.

### Force Releasing an entire conference:

Press **FrcRls**.

---

---

## **Conference Calls: Conference Multi-Party Lock**

The authorized participant can block other users from joining an ongoing conference. Conference Lock acts as an on/off switch, locking and unlocking the conference as required.

Press **CnfLck** once to lock the conference. Press again to Unlock.

**NOTE!** *If you “lock” the conference and leave, you will not be able to rejoin until another conference member “unlocks”.*



---

---

## Conference Calls: Conference View/Release

This feature allows an authorized user, from idle, to release a conference participant from an ongoing conference. The feature also allows viewing the participant list.

Press **[Cnflns]** to access this feature.

Page 1

10:50	26 May 2007	Company xyz
	<i>user name</i>	<i>station number</i>
↑→ wakeup	<b>[Cnflns]</b>	GpCall

Page 2

CONF. INSPECT
ENTER CONF NUM
***** Enter Destination *****

Page 3

RELEASE Participant Name		
CONF Conference #		
↓ Parti#	Prev	Next

1. Press **[Cnflns]**.
2. Dial the Conference number.
3. Choose **[Parti#]** and dial the participant number or use the **[Next]** and **[Prev]** to scroll between participants and choose which one should be released.
4. Choose **[FrcRls]** to activate Forced Release for the participant displayed on the top line. No confirmation tone will be heard.
5. If the Conference contains no participants, the display shows CONF EMPTY on the top line.
6. Press **SPKR** or **[Exit]** to exit. You may repeat this process for any number of participants.

---

---

## COS Switchover

Each station has a Primary and Secondary Class Of Service (COS), which provides the basis for dialing and feature capabilities for a particular station. Use this feature to change your Class of Service from Primary to Secondary or vice versa.

Press **[COS-Sw]** to access this feature.

Page 1

```
10:50 26 May 2007 Company xyz
      user name  station number
†→ [COS-Sw]          Setup          Trace
```

Page 2

```
COS CHANGE
ENTER PASSCODE
```

Page 3

```
YOUR PRIMARY
COS IS: 0
→Primry    Second
```

1. Press **[COS-Sw]**.
2. Dial your 4-digit Passcode. *To define your passcode, see [Setup: Passcode](#) on [page 232](#).*
3. Press **[Second]** to switch to your secondary COS or **[Primry]** to return to your primary COS.
4. Listen for the confirmation tone.

**NOTE!** COS Switchover is denied when your phone is in Checkout mode.

---

---

## **Directory**

This feature provides a searchable directory listing. Both Shared and Personal records are combined and organized alphabetically, for easy retrieval. A search result can be dialed at the touch of a key.

The Directory enables:

- Fast search by name
- Number retrieval and autodial
- Add/edit entries to the Personal directory

**Shared Directory** is composed of the following internal and external numbers:

- Public Speed Call Library
- Hunt Group
- Boss Group
- All stations defined in the system

**Personal Directory** is a self-built database of external telephone numbers. It is accessible only from the station at which it was entered.

An entry to the Personal Directory is distinguished from a Shared Directory entry by a preceding asterisk.

Calls arriving to your station are matched against entries to your Personal Directory. Incoming calls from contacts listed in the directory are shown on the display as they appear in the Directory.

---

---

## To search through the Directory:

**NOTE!** Both Shared and Personal directories are accessed by the first constituent of an entry. If an entry consists of a given name and a family name, the search will look for the attribute listed first.

1. Press **[Dir]** or dial feature code ## or #1994.
2. For Personal Directory contacts press **[Priv]** or dial the feature code #9.
3. Enter all or part of the name of your contact party using the alphanumeric keys (see [Keypad – Alphabetic Mode and Editing Keys on page 91](#)).

You may also use the volume  keys, **[Next]** and **[Prev]** to scroll through the Directory.

4. While the name or number of the retrieved contact party is displayed, you can do one of the following:
  - Place a call by pressing **[Dial]** or asterisk (\*) - see steps below.
  - Modify a Personal Directory contact information by pressing **[Edit]** or dialing #2. See [To modify an entry to the Personal Directory: on page 89](#).
  - Permanently remove a Personal Directory entry by pressing **[Remove]** or dialing #0. See [To remove an entry from the Personal Directory: on page 90](#).

## To place a call from the Directory:

To place a call from within the Directory, press **[Dial]** or asterisk (\*) while the name or number of the retrieved contact party is displayed.

## To modify an entry to the Personal Directory:



1. Press **[Edit]** or dial #2 while the name or number of the retrieved contact party is displayed.
2. Edit the name using the alphanumeric keys. Up to 16 characters are allowed (press **[LoCase]**, **[UpCase]**, **[Char]**, **[Digit]**, **[Space]**, **[BckSpC]** as required). See [Keypad – Alphabetic Mode and Editing Keys on page 91](#).
3. To edit the number press **[Number]** or the  key.
4. To edit the name press **[Name]**.

- 
- 
5. To save the changes press **Save** or press the  key.
  6. To place a call press **Dial** or asterisk (\*). Save the changes and call the saved contact.

## To remove an entry from the Personal Directory:

To permanently delete an entry (personal directory only), press **Remove** or dial #0 while the entry is displayed. You will not be able to restore the deleted entry. The entry subsequent to the one removed appears on the display.

## To add a new entry to the Personal Directory:

1. Press **Dir** or dial feature code ## or #1994.
2. Press **New** or dial #1.
3. At the prompt, enter the name of your contact party using the alphanumeric keys. Up to 16 characters are allowed (press **LoCase**, **UpCase**, **Char**, **Digit**, **Space**, **BckSpC** as required). See [Keypad – Alphabetic Mode and Editing Keys on page 91](#).
4. Press **Number** or press the  key.
5. At the prompt, enter the telephone number of your contact party (do not enter the outside line access code).
6. Press **Save** or press the  key to save the entry (an asterisk marks the saved entry as a Personal one).

OR

Press **Dial** or press asterisk (\*) to save the entry and call the saved contact.

**NOTE!** Any attempt to make an entry in excess of the number of entries allowed by the system, or to assign a dial number already existing on the Directory to a new contact, will fail.

## Keypad – Alphabetic Mode

Use the keypad to make new entries or navigate through the directory to a specific entry. The cursor advances automatically when a different key is pressed. If two consecutive letters are on the same key, wait for the cursor to disappear before proceeding to the next key. The following table indicates the key presses used to input the required letters. This table may override the designations on your keypad.

For example, to enter “ANN” press: 2 ABC 6 MNO 6 MNO WAIT 6 MNO 6 MNO  
A N N

KEYS	CHARACTERS			
	Press:	1 Time	2 Times	3 Times
<span style="border: 1px solid black; padding: 2px;">1</span>	–	–	–	–
<span style="border: 1px solid black; padding: 2px;">2 ABC</span>	A	B	C	–
<span style="border: 1px solid black; padding: 2px;">3 DEF</span>	D	E	F	–
<span style="border: 1px solid black; padding: 2px;">4 GHI</span>	G	H	I	–
<span style="border: 1px solid black; padding: 2px;">5 JKL</span>	J	K	L	–
<span style="border: 1px solid black; padding: 2px;">6 MNO</span>	M	N	O	–
<span style="border: 1px solid black; padding: 2px;">7 PQRS</span>	P	Q	R	S
<span style="border: 1px solid black; padding: 2px;">8 TUV</span>	T	U	V	–
<span style="border: 1px solid black; padding: 2px;">9 WXYZ</span>	W	X	Y	Z
<span style="border: 1px solid black; padding: 2px;">*</span>	–	–	–	–
<span style="border: 1px solid black; padding: 2px;">0</span>	–	–	–	–
<span style="border: 1px solid black; padding: 2px;">#</span>	–	–	–	–

## Editing Keys

The Directory service allows you to easily retrieve a telephone number by keying a name of your contact and to place a call to the search result as soon as the match is found. The available key combinations are listed in the table below.

Options marked with a diamond (♦) are applicable for the Personal Directory only.

Option	Soft Key	Access Code (Dial Pad#)	Description
Personal Directory ♦	[Priv]	#9	Access the personal directory subset only.
Delete Entry ♦	[Remove]	#0	Delete the displayed personal entry. (There is no option to restore the deleted entry.)
New Entry ♦	[New]	#1	Add a new entry to your Personal Directory.
Modify Entry ♦	[Edit]	#2	Edit the displayed personal entry.
Backspace ♦	[BckSpc]	#3	Erase the last entered character or digit.
Space ♦	[Space]	#4	Insert a space between words.
Name/Number	[Number]	#5	Toggle between name and number of your contact. To program a Name/Number toggle button, use feature code #128.
	[Name]		
Save ♦	[Save]	N/A	Save the displayed contact.
Send	[Dial]	*	Place a call to the displayed contact and save.
Scroll	[Next]		Scroll through the Directory entries, contact by contact (entries are alphabetically organized).
	[Prev]		

Option	Soft Key	Access Code (Dial Pad#)	Description
Caps Lock ♦ Uppercase/Lowercase Characters	LoCase	Designated DSS button	Toggle between uppercase and lowercase characters. To program the Caps Lock toggle button, contact your system administrator for the Caps Lock feature code.
	UpCase		
Character/Digit ♦	Char	Designated DSS button	Toggle between digits and characters. To program the Character/Digit toggle button, contact your system administrator for the Character/Digit feature code.
	Digit		



---

---

## Divert Call

Enables you to divert an incoming call while actively engaged in another call, or while an idle station is ringing, without answering it. The call you are engaged in is not interrupted, nor is the incoming caller aware of the diversion. The destination can be any permissible dial number in the system. Typically Divert Call can be used to send an incoming call to a boss group, a secretary, or to voice mail, by making Library the destination of the diversion. This feature can be utilized only if you have a programmed DIVERT CALL key with a destination upon receiving an incoming call. The caller name or number is displayed on the top left.

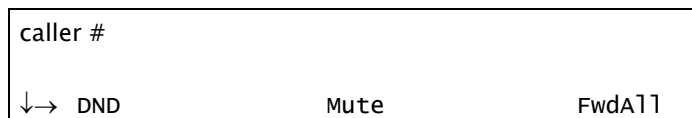

### To activate during ringing:

1. Press a preprogrammed **DIVERT CALL to XXXX** key.
2. The incoming call is diverted to the programmed destination; the current call continues uninterrupted or the station remains idle.

#### **NOTES!**

- See [page 162](#) for instructions on how to program a key. To program a **DIVERT CALL** key, use feature code #1445, followed by the destination number. You may program as many keys as you want, each with a different destination.
- Possible destinations are operator, station/group, network number, public speed call library, DVMS pre-recorded message, UNA/central bell or group call.
- Your station must be defined as multi-appearance to be able to divert a new call while engaged in a previous one.

---

---

## Do Not Disturb (DND)

Use the Do Not Disturb feature to block all incoming calls to your station. When blocked, you can still receive Voice Page calls and you are still able to make outgoing calls.

Any call forwarding to your telephone is automatically cancelled when you activate the DND feature. Only a station that has DND Override privilege will be able to call your telephone.

When the feature is activated, the calling station will see the DONT DIST message (or UNATTENDED for Attendant) and hear the reorder tone.

This feature is accessible via **[DND]** from idle or when receiving an incoming call.

```
10:50  26 May 2007  Company xyz
      user name    station number
↓→ Fwd           Music           [DND]
```

To activate, press the **[DND]** toggle key once. To cancel, press the **[DND]** toggle key again.

**NOTE!** *Should you hear a reorder tone, DND is denied at your station (as defined by the Class of Service).*

When the feature is activated, a bullet (or thick arrow) appears next to **[DND]** and a \*DND\* message briefly appears on the top line to remind you that the feature is activated.

```
10:50  26 May 2007  Company xyz
      user name    station number
↓→ Fwd           Music           •[DND]
```

---

---

## Do Not Disturb Override

This feature can be applied to stations that are idle, but have been set to Do Not Disturb or Unattended. After dialing a station and receiving a reorder tone, if the DONT DIST or UNATTENDED message appears on the top line, an authorized user can override the DND using this feature and your call can be put through to the station.

1. Press **[DNDOvr]** or **[Brk-In]**.
2. Listen for the ringback tone and wait for an answer.

---

---

## ***ELA (Extension Line Appearance)***

Similar to the Boss Group feature (see [page 61](#)), an ELA Group is a number of stations operating together in which the individual stations share a common line appearance. Unlike a Boss Group, the ELA Group number is the extension number of the first (main) ELA member station. Therefore, there are no ELA NPL type numbers reserved in the system.

Up to 32 ELA line keys may be programmed on each group member station. When an ELA-defined line key flashes, it flashes at all the member stations. Any member may answer the call by pressing the flashing line key. The line key remains lit as long as the call is in progress. In addition to flashing, member stations may be alerted to incoming calls by an accompanying ring. The ring setting (whether the ring is immediate, delayed, or no ring) can be determined at each member station if at least one line key is defined by the user.

If the ELA call is put on hold, the line key flashes at all the member stations and any member (provided the privacy feature is not activated) may break-in to the call by pressing the flashing line key. To place a call, a member may press any available line key; the line key remains lit at all member stations for the duration of the call.

Use the following guide to navigate through this section:

<a href="#">ELA Group Line Keys: Programming</a> .....	page 98
<a href="#">ELA Groups: Using</a> .....	page 100
<a href="#">ELA Groups: Privacy</a> .....	page 102
<a href="#">ELA Groups: Exclusive Hold</a> .....	page 103

---

---

## ELA Group Line Keys: Programming

Each FlexSet in an ELA Group can be programmed with up to 32 ELA line keys. To learn about the different uses of ELA line keys, see [below](#).

**NOTE!** *In order for ELA calls to be received on the main ELA station, the station must be defined as multi-appearance and be a member of an ELA group. You may belong to more than one ELA group.*

### To Program ELA Line Keys:

1. Press **[Setup]** **[ProgKy]**.
2. Press the DSS key you want to program as the ELA line key.
3. Dial the ELA LINE feature code (default: #17718).
4. Dial the ELA Group number (main ELA station extension number).
5. Continue to enter the Ring State (see [below](#)).
6. Enter the line key number (00 to 31). Two digits must be entered.
7. Press the selected DSS key again.
8. Press **SPKR** to release.

### ELA: Defining the ELA Line Keys Ring State

Only one type of ring state may be defined on your station. (If your station is member of more than one ELA group, you can define different ring states for each ELA group).

Although you are prompted to set the ring state each time when programming individual ELA line key (see [above](#)), you can use this feature to override any previous ring state definition and set one ring state for all the ELA line keys. Note that the last ring state defined (whether using this ELA feature or when programming an ELA line key) will apply to all the ELA line keys.

**NOTE!** *Regardless of the ring state defined for your station, the line key flashes for all incoming ELA Group calls and remains lit for the duration of the call.*

---

---

Press [ELA] from idle and then dial the ELA Group number to define the ring state of ELA line keys.

Page 1

10:50	26 May 2007	Company xyz
<i>user name</i>	<i>station number</i>	
↑→ RoomSt]	<input type="checkbox"/> [ELA]	

Page 2

EXT. LINE APPEAR
***** Enter Destination *****

Page 3

EXT. XXXX		
→ Yes	No	Delay

- [Yes]      **Yes** is used to define ELA line keys to immediately ring at your station upon receiving an ELA Group call.
- [No]        **No** is used to define ELA line keys to not ring at your station upon receiving an ELA Group call.
- [Delay]     **Delay** is used to define ELA line keys to ring at your station upon receiving an ELA Group call after a system-defined timeout period.

---

---

## ELA Groups: Using

### Calling an ELA Group:

- Dial the ELA Group number.

**NOTE!** *The line key LED of the ELA main station as well as all group members flashes and may also ring (see [ELA: Defining the ELA Line Keys Ring State on page 98](#)).*

### Making calls:

1. Press a free ELA **LINE** key.
2. Dial the required number.

**NOTE!** *The line key LED of the ELA main station as well as all group members changes from off to steady on for the duration of the call.*

### Receiving calls:

When the line flashes (note that the telephone may also ring - see [page 98](#)):

1. Any ELA member may press the flashing **LINE** key or, if phone rings, lift the handset.
2. Answer the call.

**NOTE!** *The line key LED of all group members now changes from flashing to steady on for the duration of the call.*

### Putting a call on hold:

- Press a programmed HOLD key at your station.

**NOTE!** *If Exclusive Hold is defined at your station, then pressing Hold causes an exclusive hold state such that the call can only be retrieved from your station. See [ELA Groups: Exclusive Hold on page 103](#).*

---

---

## Retrieving a call from on hold:

- Any member of the ELA Group may press a flashing **LINE** key, provided that the Exclusive Hold feature was not activated for the call (see [ELA Groups: Exclusive Hold on page 103](#)).

## Breaking in to an ELA call:

- Any member of the ELA Group may break-in to a call by pressing the lit **LINE** key, provided that the Privacy feature was not activated for the call (see [ELA Groups: Exclusive Hold on page 103](#)). Both parties hear a break-in warning tone before you join the conversation.



---

---

## **ELA Groups: Privacy**

As an ELA Group member you can put your telephone into **Privacy** mode. This prevents other FlexSet stations within ELA Group from joining or breaking in to your conversations. The feature can be utilized for a specific ELA call or for all ELA calls.

### **Operating Privacy for all ELA calls:**

1. To **activate** Privacy, press **[Setup] [Privac]**.  
The message PRIVACY is displayed.  
When this feature is activated, a bullet appears next to **[Privac]**.
2. To **cancel** Privacy, press **[Privac]** again.  
The message NO PRIVACY is displayed.

You may override the station Privacy setting on a call-by-call basis. Privacy is a toggle feature. Thus, if your station is in Privacy mode, you may remove the Privacy restriction and allow others to join your conversation; alternatively, if your station is not in Privacy mode, you may apply Privacy to a specific call.

**NOTE!** *Once Privacy is defined for your station (for all calls) a bullet is displayed next to **[Privac]**, even if the key is pressed to temporarily override the Privacy feature. However, when your call is completed the telephone will return to the permanent status, private or non-private, as previously defined for all calls.*

---

---

## ***ELA Groups: Exclusive Hold***

As an ELA Group member, you can put your telephone into **Exclusive Hold** mode. This ensures that a call you place on hold can be retrieved only at the station where Exclusive Hold was originally placed. If Exclusive Hold is cancelled, the call put on hold can be retrieved by any other member of the ELA Group, by pressing the flashing **LINE** key. The feature can be utilized for a specific call or for all calls.

### **Operating Exclusive Hold for all ELA calls**

1. To **activate** Exclusive Hold, press **[Setup]** **[ExHold]**.  
The message EXCLUSIVE HOLD is displayed.  
When this feature is activated, a bullet appears next to **[ExHold]**.
2. To **cancel** Exclusive Hold, press **[ExHold]** again.  
The message NON EXCL. HOLD is displayed.

You may override the station Exclusive Hold setting on a call-by-call basis. Exclusive Hold is a toggle feature. Thus, if your station is in EXCLUSIVE HOLD mode, you may remove the Exclusive Hold restriction and allow others to pick up your held call; alternatively, if your station is not in EXCLUSIVE HOLD mode, you may apply Exclusive Hold to a specific call. This is done by pressing **[ExHold]** during a call before pressing **HOLD**. Press this key to toggle the feature on and off. This key can be pressed as many times as necessary. If your telephone is not in **Exclusive Hold** mode for all calls, press **[ExHold]** before you press **[Hold]**. Press **[Hold]** to place a call into Exclusive Hold. The **LINE** on hold will remain steady on at all other FlexSets in the ELA Group, and the call will only be retrievable from your station.

### **Transferring call to a group member (during conversation):**

Once Exclusive Hold is defined for your station (all calls) a bullet is displayed next to **[ExHold]**, even if the key is pressed to temporarily override the Exclusive Hold feature. However, when your call is completed the telephone will return to the permanent status, as previously defined for all calls. If your telephone is in **Exclusive Hold** mode for all calls, press **[ExHold]** before you press **[Hold]**.

1. Press **[Hold]**. The **LINE** on hold will flash at all FlexSets in the ELA Group.
2. Listen for the confirmation tone.
3. Inform the party to whom you wish to transfer on which line the call is on hold.

---

---

## Executive Privilege

Use this feature to temporarily copy all the COS features from any system station to your FlexSet, enabling you to use features or to dial numbers restricted at your current station. After **one** call, the current FlexSet returns to its previous COS.

Some FlexSets may be denied the Executive Privilege feature, as defined by the current Class of Service.

Press **[Exec]** to access this feature.

*Page 1*

```
10:50 26 May 2007 Company xyz
      user name  station number
↓→ Acducd           Lock      [Exec]
```

*Page 2*

```
EXECUTIVE

*** Enter Dial # ***
```

### Operating Executive Privilege:

1. Press **[Exec]**.
2. Dial the station number.
3. Dial the passcode of that station (*see [Setup on page 232](#)*).

Now the current FlexSet resembles the other station. Continue to dial as you would from that station.

---

---

## FlexiCall

Calls ringing at your Coral station can simultaneously ring at any designated internal or external phone (such as home phone, mobile, and second station) and can be answered at either phone. Your FlexSet can distinguish between calls arriving from an internal or external source when ringing at the remote destination (see [Internal/ External FlexiCall on page 106](#)). Calls can be transferred back to the original FlexSet anytime during the call.

The FlexiCall feature is an ideal solution for office applications requiring a “courtesy” telephone, and applications requiring an extension telephone to a system FlexSet. The FlexiCall feature may be used also to “semi-connect” ancillary devices such as answering machines, fax machines, or data modems to your FlexSet, without using a separate telephone number.

The remote destination rings even when your office FlexSet is disconnected.

The remote destination does not ring if any of the following features is activated at your Coral station: *Do Not Disturb*, *Call Forward All*, *Call Forward Busy*, *Call Forward Timed*, *Auto Answer*.



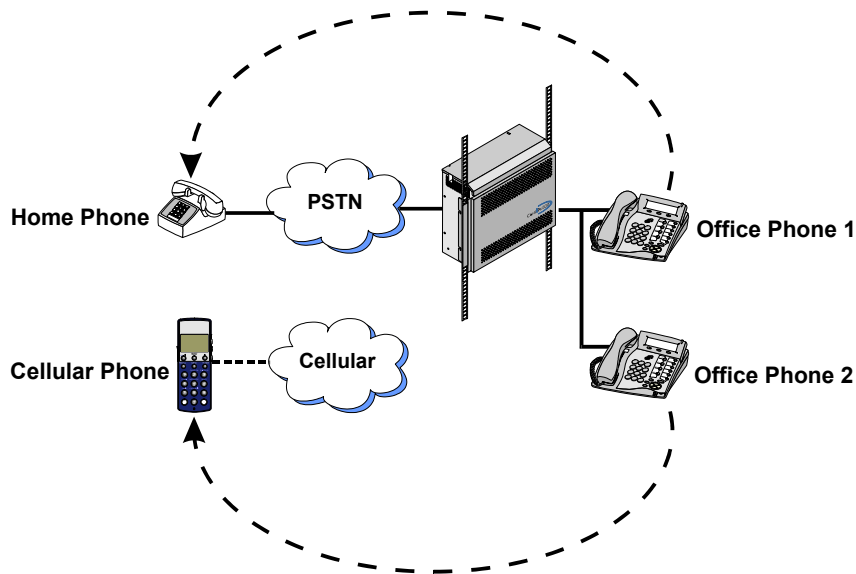





The remote destination does not ring for the following incoming calls: *Group call*, *Boss Group call* (only first member of a Boss Group will ring), *ELA Group call* (only one member of an ELA Group will ring), *Bell/UNA*, *Reminder*, *Wakeup*, *Voice Page*.



## Internal/External FlexiCall

You can distinguish between calls arriving from an internal or external source when operating the FlexiCall feature. You can set calls arriving to your FlexSet to concurrently ring at your remote phone as follows (see table below):

- Internal and External calls ring at your remote phone.
- Only internal calls ring at your remote phone.
- Only external calls ring at your remote phone.

Case	To set		Set FlexiCall options as follows:		
	Internal Calls ring at:	External Calls ring at:	FlexiCall All Set to:	FlexiCall Internal Set to:	FlexiCall External Set to:
1			Disabled	Activated	Disabled
2			Disabled	Disabled	Activated
3			Enabled	Irrelevant	Irrelevant
4			Disabled	Activated	Activated



= your Coral Station



= your remote phone

---

---

Press **[FlexiC]** to access the FlexiCall options.

Page 1

10:50	26 May 2007	Company xyz
	<i>user name</i>	<i>station number</i>
↑→ <b>[FlexiC]</b>	Redial	Page_Q

Page 2

FlexiCall Remote Dest		
→ All	Extern	Intern

**[All]** **All Incoming Calls** is used to define your remote destination for **all** incoming calls.

**[Extern]** **External Calls** is used to define your remote destination for all incoming **external** calls.

**[Intern]** **Internal Calls** is used to define your remote destination for all incoming **internal** calls.

## To Operate FlexiCall:

1. From idle press **[FlexiC]**.
2. Choose the required FlexiCall option ( **[All]**, **[Extern]**, or **[Intern]** ).
3. To set FlexiCall, dial your remote destination number (internal number or Public/Private Library number) at which calls will ring simultaneously with your Coral station.  
A remote destination can be: *an operator, station, network number, UNA/ Central Bell, or external number (stationary or cellular) via Public/Private Speed Call Library.*
  - To cancel FlexiCall, choose **[Cancel]**;
  - To change the FlexiCall destination, choose **[Dest]** and dial the remote destination number.
4. Listen for the confirmation tone.

**NOTE!** **[Intern]** and **[Extern]** calls may be routed to different destinations. If **[All]** is defined, it overrides the settings for Internal and External.

---

---

## Receiving Calls at a Remote Destination

If your remote destination is located outside the enterprise (PSTN or public cellular network), you can answer all your FlexSet calls from your remote destination. Once you answer a call at your remote destination, your remote phone will be activated as a part of the Coral system and you have the following options:

Function	Dial	Use to:
Place a new call	*1	Listen for a dial tone indicating that you can place a call to a new contact. Your original conversing party will be disconnected.
Transfer call	*2	A dial tone prompts you to enter the required transfer number. Transfer can be screened or unscreened. To return to the original conversing party (when transfer destination is busy or does not answer) dial *2 again.
Switch to Broker/ Consultation/3-Way Conference call	*2	A dial tone prompts you to enter the required third party number. Depending on your Class of Service definitions, one of the following party functions will be activated (see <a href="#">Broker/ Consultation/3-Way Conference call on page 131</a> ): Broker Call, Consultation, 3-Way, or Combination of Broker/Consultation/3-Way Conference Call
Divert call to Coral station	*3	A dial tone prompts you to enter a divert number. You will be disconnected and your conversing party will be transferred to the divert number. Your number will not show on the divert party's display.
Access voice mail/IVR	*4	For instructions on accessing voice mail from an IRSS phone, see <a href="#">page 109</a> .
Divert call to your FlexSet	*5	You will be disconnected and your conversing party will be transferred to your Coral station. Your number will not show on your FlexSet's display. If your station does not answer within the system-defined time-out period, the call will return to your remote phone.
Call Recording/ Help Requesting	*6	Used to Start/Stop Recording incoming calls (requires a system-wide defined Navigator application). Or send Help request (requires a pre-selected system-wide defined keyset station), see <a href="#">page 124</a> .

---

---

### To activate voice mail/IVR from your remote phone:

You can access your voice mailbox, retrieve messages and setup voice mail options for your Coral station.

1. Answer the remote call.
2. Dial \*1. Listen for the dial tone. Your original party will be released.
3. Dial the voice mail or IVR dial number (see table [below](#)).
4. At the automated voice mail answer, dial the voice mail remote access code followed by your station number to access your station's voice mail box.
5. Dial \*4 as soon as the automated voice mail answers. This allows the system to recognize the voice mail (or IVR) commands.
6. Choose the required option from the voice mail or IVR system menu.

**NOTE!** Contact your system administrator for the voice mail (IVR) dial number and voice mail remote access code. Use the table below to record that number and code:

**Voice Mail (IVR) Numbers/Codes**

Voice Mail (IVR) Dial Number	Voice Mail Remote Access Code



---

---

## **Freedom**

See [Individual Remote System Services \(IRSS\) - Freedom on page 127](#).

---

---

## Group Calls

Group Calls are conference calls, allowing participation of up to 100 members at a time. Two options are offered:

- Preset Group Calls comprised of predefined members
- Add On (Temporary) Group Calls containing no predefined members, where participants are added from the Group Call initiator station

Each Group Call has its own unique dial number. Group Call members can be internal stations or external numbers dialed through Public Library numbers.

When a Group Call is placed, all stations defined as registered members for that particular group ring. As a member joins the conference (i.e. answers the incoming group call ring), all actively participating members can be alerted by a defined warning tone. Unanswered stations will continue ringing until the defined timeout period is completed, without disturbing the conference.

Depending on the system settings, a warning tone may be heard by a conference initiator upon activating the group call, and by all the participants every time a participant joins (or leaves) an ongoing conference. Group members may be blocked from joining the conference once the ringing has stopped. The conference may, if desired, be locked to those users that are not listed on the system as the conference registered members. When the Group Call is not locked, the non-registered members may join an ongoing conference by dialing the Group Call access code, or be connected by a registered member.

The conference is controlled by a user defined as the *Group Operator*.

Participants may join a conference with the ability to speak and hear each other, or in the **Mute** mode to only hear other group members. In case of a muted conference, only the Group Call initiator has the right to speak. Other participants can be granted permission to speak by the *Group Operator*. These options are set in the Group Call definitions. An authorized user can force release a participant or terminate an entire conference.

---

---

## Defining a Group Call Operator:

If you are authorized to be a Group Call Operator you can define another (COS defined) station as the operator of a group call.

1. Press the preprogrammed Group Call Operator DSS key, or dial the Group Call operator code (#17716).

See [Programming: Feature Keys](#) on [page 162](#) for instructions on how to program a DSS key.

2. Dial the keyset station number.

**NOTE!** If you are authorized to be a Group Call Operator you can also dial your own station number to define yourself as the group call operator.

## Group Call Access Codes

Use the following form to write in your group call details:

Group Call Members	Group Operator	Group Call Access Code (group #)	Conference Number (conf #)

---

---

Use the following guide to navigate through this section:

<a href="#">Group Calls: Preset Conference Activation</a> .....	page 114
<a href="#">Group Calls: Temporary Conference Activation</a> .....	page 115
<a href="#">Group Calls: Joining</a> .....	page 116
<a href="#">Group Calls: Adding Participants (when not part of the Call)</a> .....	page 117
<a href="#">Group Calls: Submitting Request to Speak</a> .....	page 119
<a href="#">Group Calls: Controlling Permission to Speak</a> .....	page 120
<a href="#">Group Calls: Forced Release of a Participant</a> .....	page 121
<a href="#">Group Calls: Forced Release of an Entire Group Call</a> .....	page 122

Press **GpCall** to access the Group Call options.

Page 1

10:50	26 May 2007	Company xyz
	<i>user name</i>	<i>station number</i>
↑→ wakeup	CnfIns	<b>GpCall</b>

Page 2

Group Call Conference		
→ PrtRel	GrpRel	AddOn

**PrtRel** **Participant Release** is used to allow an authorized user to release a participant from an ongoing conference. The feature does not allow the user to view the list of participants. See [page 121](#).

**GrpRel** **Group Release** is used to allow an authorized user to release the entire group call. See [page 122](#).

**AddOn** **Temporary Add On.** The Temporary Conference feature allows an authorized user to establish an Add-On (Temporary) Group Call by adding participants as the conference is being set up. See [page 115](#).

---

---

## **Group Calls: Preset Conference Activation**

Preset Group Calls are comprised of a number of specified members whose stations ring simultaneously when an assigned Group Call number is dialed. This feature allows a conference initiator to contact all the registered members with one button press. The maximum number of participants is 100, depending on the system configuration.

### **Calling a Preset Group:**

1. Press the preprogrammed Group Call DSS key, or dial the Group Call access code.  
*See [Programming: Feature Keys](#) on [page 162](#) for instructions on how to program a DSS key.*
2. All the member stations start ringing.
3. Wait for members to join, listen for the warning tone (if defined system-wide) every time a member answers.
4. Start speaking when the CONF COMPLETED message appears momentarily on the display (the message indicates that all non-answered stations have stopped ringing).
5. If none of the member stations answered, the NO ANSWER message appears.

**NOTE!** For Group Call access code, see the table on [page 112](#).

---

---

## **Group Calls: Temporary Conference Activation**

The Temporary Conference feature allows an authorized user to establish an Add-On (Temporary) Group Call by adding participants as the conference is being set up. For this purpose, vacant Group Calls containing no preset members are defined system-wide. The Group Call initiator adds members from his/her station. A Temporary Group Call may include internal stations and/or external telephone numbers via a public speed call library. A few preset group calls may be joined to an Add-On Group Call via Public Libraries.

### **Calling a Temporary Group:**

1. Press **[GpCall]** **[AddOn]**.
2. Listen for the dial tone.
3. Dial the Group Call access code.
4. Press **[AddPrt]**.
5. Dial the required station and/or Public Library. To add additional members, repeat from Step 1.  
Up to 5 or 14 destinations can be added, depending on the system configuration.
6. To delete a participant, press **[DelPrt]**. Press **[DelPrt]** again to delete additional participants. This operates on a last-in-first-out basis – the participant added most recently will be deleted first, followed by the next most recent, and so on.
7. Press **[Call]** to initiate the Group Call.  
All the called stations will now start ringing. As each member joins you will hear a warning tone (if defined system-wide).
8. Start speaking when the CONF COMPLETED message appears momentarily on the display (the message indicates that all non-answered stations have stopped ringing).

---

---

## **Group Calls: Joining**

The registered members join a conference being initiated by answering the incoming group call.

Provided the conference is not locked against non-registered participants, they can join the conference by dialing the group call access code or can be transferred to the group call by an authorized user.

### **Joining a Group Call:**

While your phone is ringing:

1. Answer the ringing phone or press the lit Group Call DSS key.
2. A warning tone will be heard by all participants (if defined system-wide).

After station has stopped ringing:

1. Press the lit Group Call DSS key or dial the Group Call access code.
2. A warning tone will be heard by all participants (if defined system-wide).

**NOTE!** *When the group is defined as blocked against joining an ongoing conference, the BUSY message will be displayed and the busy tone will be heard.*

### **Leaving a Group Call:**

1. Press **SPKR** or hang up.
2. A warning tone will be heard by all participants (if defined system-wide).

---

---

## **Group Calls: Adding Participants (when not part of the Call)**

Allows an authorized user to transfer a new participant to an established conference. The feature enables a user engaged in a conversation to add his conversing party to the ongoing conference. The feature can be enabled when the Group Call is not locked against non-registered participants, and connecting to the ongoing conference is not restricted.

### **Adding an additional participant to an ongoing Group Call:**

While connected to a station/trunk:

1. Press **Xfer**.
2. Listen for the dial tone.
3. Press the lit Group Call DSS key or dial the Group Call access code.  
A warning tone will be heard by all participants (if defined system-wide).
4. Both the new participant and yourself are connected to the group call.

#### **NOTES!**

- *When the group is defined as locked against non-registered participants, and one of the conversing parties is not registered, the reorder tone is heard and the **CNF LOCK** message is displayed. The registered party joins successfully, while the non-registered party is disconnected. If neither are registered members, both conversing parties will be disconnected.*
- *When the group is defined such that no new participant can join an ongoing conference, both conversing parties will be disconnected. The busy tone is heard and the **BUSY** message is displayed.*



---

---

## Group Calls: Adding Participants (by Group Operator)

Allows the group operator to add participants to an established conference of which the group operator is also a participant.

### Adding an additional participant to an ongoing Group Call:

1. Press the preprogrammed **ADD MEMBER** DSS key during an established conference; the corresponding DSS key is lit.

**NOTE!** See [page 162](#) for instructions on how to program a DSS key. To program an **ADD MEMBER** key, use feature code #1304.

2. Press the member's preprogrammed DSS key.

#### **NOTES!**

- *You cannot manually dial the internal/public/private library number. Therefore, you will need to assign DSS keys for each conference member (up to 6 or 15, depending on system hardware) you want to be able to add to a Group Call following this procedure.*
- *DSS buttons may also be programmed with Trunk Groups followed by an external dial number to enable joining external members. These members, however, are subject to all previous group call definitions, where they must be given the right to speak or remain in Mute mode while listening to the Group Call (see [page 119](#)).*

3. The member's phone rings.

The **ADD MEMBER** DSS key LED is turned off and the member's DSS key lights at the Group Operator's station.

4. The member answers and joins the group call.

**NOTE!** *The **ADD MEMBER** DSS LED remains lit when attempting to add a non-legal dial number to the Group Call, allowing you to attempt another number.*

---

---

## **Group Calls: Submitting Request to Speak**

Members may be permitted to participate in a Group Call with the ability to speak and hear each other, or in the **Mute** mode. In case of a muted conference only a Group Call initiator has the right to speak. The user defined as *Group Operator* can set his own station to the audible mode, while connected to the conference, and may grant the right to speak to other participants.

This feature allows you to request permission to speak from the *Group Operator*. The request is submitted while your current conference is in progress, without disturbing it.

### **Sending a request to speak to the group operator:**

1. Press the **Speech Request** DSS key or fer. (To program a *Speech Request* key, use *Help* feature access code #1443, followed by the *Group Operator* dial number.)
2. Continue attending the current conference, while watching the **Speech Request** key LED and the second line of the display.
3. The TRX . ON message indicates that you are given permission to speak.
4. The TRX . OFF message indicates that the permission to speak is taken away from you.

---

---

## **Group Calls: Controlling Permission to Speak**

This function is relevant for Group Calls defined to admit participants only in **Mute** mode. This feature allows the Group Operator to grant a participant permission to speak – either by operator's own initiative or as a response to the Request to Speak sent by a Group Call participant. The operator can ignore the Request to Speak, or act as described below. To utilize the feature, the Group Operator's keyset must be equipped with a display and the DSS buttons programmed with participants' dial numbers.

### **Responding to the request to speak:**

1. Listen for the muted ring and check the station number/name displayed.
2. Press the flashing DSS button associated with the station that is requesting permission to speak.
3. Notify the participant that permission to speak is given.

### **Initiating permission to speak:**

1. Press the steadily lit DSS button associated with the required participant.
2. Ask the participant to start speaking.

### **Retracting permission to speak:**

1. Notify the participant that the permission will be retracted.
2. Press the flashing DSS button associated with the participant to be muted.

**NOTE!** *A Group Operator who left the conference and rejoined in the Mute mode must give himself permission to speak by pressing the steadily lit DSS button pre-programmed with his own dial number.*

---

---

## **Group Calls: Forced Release of a Participant**

This feature allows an authorized user, from idle, to release a participant from an ongoing conference. The feature does not allow the user to view the list of participants.

### **Releasing a single participant:**

1. Press **[GpCall]** **[PrtRel]**.
2. Listen for the dial tone.
3. Dial the participant number or press the programmed DSS key.
4. Press **[FrcRls]** - no confirmation tone will be heard.
5. Press **[Exit]** to exit.

The group operator can also release a participant from an ongoing conference provided that the operator is authorized to release Group Call participants in the COS.

### **Releasing a participant (Group Call Operator):**

1. Press the preprogrammed **RELEASE MEMBER** DSS key during an established conference; the corresponding DSS key is lit.

**NOTE!** See [page 162](#) for instructions on how to program a DSS key. To program an **RELEASE MEMBER** key, use feature code #1305.

2. Press the member's preprogrammed DSS key.

**NOTE!** You cannot manually dial the internal/public/private library number.

3. The member is disconnected from the conference.  
The member's DSS key is extinguished at the Group Operator's station.
4. The member returns to `Idle` state.

---

---

## ***Group Calls: Forced Release of an Entire Group Call***

This feature allows an authorized user to release the entire group call from idle.

### **Releasing an entire Group Call:**

1. Press **[GpCall]** **[GrpRel]**.
2. Listen for the dial tone.
3. Dial the access code of the required Group Call.
4. Press **[FrcRls]** - no confirmation tone will be heard.
5. Press **[Exit]** to exit.

---

---

## Headset Only

The feature is designed for users operating in **Headset** mode. It is of particular value at information centers where the headset option is the most efficient way of communication. When activated, the Headset Only feature causes calls to be conducted via the headset and disables the FlexSet's microphone and loudspeaker, along with the features that use these devices, e.g. background music, voice page, etc. Calls are conducted via the headset even if the cradle switch is on-hook, enabling a user to make full use of the hands-free operation.

**NOTES!** When utilizing Headset Only feature:

- The **SPKR** key should be programmed as an ON/OFF (connect/release) key. See your system administrator.
- The phone can be set for **Zip Tone** mode. This mode is used to sound the ring tones directly through the headset, rather than through the speaker. (For **Zip Tone** setup, see page 240 or page 241)
- Refer to [page 19](#) for instructions on operating a FlexSet programmed as Headset Only.

### To activate Headset Only:

- Press **[Setup]** **[HeadSt]**

A bullet appears to the left of **[HeadSt]**.

### To disable Headset Only:

- Press **[Setup]** **•[HeadSt]**

---

---

## Help: Requesting

The Help Requesting feature allows you to alert a pre-selected station while you are in conversation with a request for help. The Help feature is operated while your current call is in progress, without disrupting the call. Once you have agreed upon a partner for the help procedure, a predetermined action can take place between you and your partner when Help is activated.

A DSS key must be programmed to activate Help Requesting.

### Programming a Help Requesting key:

1. Press **[Setup]** **[ProgKY]**.
2. Choose and press the DSS key.
3. Dial feature access code (default dial number: #1443).
4. Dial the destination station.  
The destination must be another keyset equipped with a display.
5. Press the selected DSS key again.
6. You may program many keys, each with a different destination.  
To program additional keys, repeat Steps 1 - 5.

### Sending a Help Request:

During a call when you need help, press the **HELP** DSS key and continue the call, while watching the **HELP** key LED. Your **HELP** key LED is lit while the destination phone rings. The LED flashes when the call is answered.

The destination station displays the help message on the station display while the station is ringing. Wait for help or press the **HELP** key again.

**NOTE!** *Discuss with co-worker/partner what Help procedure should be performed when Help is requested.*

---

---

## ***Help: Answering***

This feature allows you to receive a call for help from another station.

### **Answering a Help Request:**

1. Answer the call, listen for the confirmation tone and check the station number displayed.
2. Press **SPKR** or hang up to release.
3. Take help action as agreed.

**NOTE!** *If engaged in a call when help is requested, a muted ring tone and message is received. Terminate the call or put it on hold and answer, so the requesting station knows that you have received the request for help.*



---

---

## Hold

A calling party can be placed on hold while another call is made. The held party can hear one of the following: music, reorder tone, busy tone or no sound at all as defined system-wide.

Call Hold is accessible via **[Hold]** or **HOLD**.

Page 1

10:50	26 May 2007	Company xyz
	<i>user name</i>	<i>station number</i>
†→ Page_Q	Xfer	<b>[Hold]</b>

Page 2

CALL HOLD	Name
→ Next	ReConn

During a call, press **[Hold]** or **HOLD** to place the second party on hold.

The **[Hold]** soft key is shown with a bullet next to it, indicating that a call has been placed on hold at your station. A \*HOLD\* message appears on the top line to remind you that a call is held at your station. The **HOLD** LED is lit and **LOOP** flashes.

### Retrieving the call from Hold:

Press the flashing **LOOP** key to connect or:

1. Press **[Hold]** or **HOLD**.
2. Choose **[ReConn]**. If more than one party has been placed on hold, scroll between names by using **[Next]**.
3. The held calls are returned in “first in/first out order”.

If you do not return to the call on hold within a predetermined amount of time, the call will automatically return to you.

If your telephone is defined (by the system administrator) as Hard **HOLD**, the message CALL ON HOLD appears after placing a call on hold. When Hard Hold is activated on a call, your station will be considered busy for additional incoming calls; however, outgoing calls can still be made.

---

---

## Individual Remote System Services (IRSS) - Freedom

The Freedom feature, also known as Individual Remote System Services (IRSS), enables you to connect an off-site non-Coral phone (such as your home phone or mobile) to the Coral and make calls from within the system. Many of the Coral's extensive features (e.g. transfer, conference call, voice mail, access to public and private libraries) are available from this off-site phone. The off-site telephone operates as a virtual station in the Coral network, retaining the original features of the external telephone in addition to the Coral features.

**NOTE!** To enable the IRSS feature at your Coral station, you must first program a Private/Public Library number with your off-site phone number (see [page 237](#) and [page 224](#)). Use the table below to record library numbers that contain your IRSS destination.

Private/Public Library Number:	IRSS Off-Site Phone Number

### To enable IRSS (from remote phone providing caller ID):

1. Dial IRSS feature code #17714.
2. At the dial tone, enter the number of a Private/Public Library containing your off-site phone number.
3. Listen for the confirmation tone.

### To cancel IRSS:

1. Dial IRSS feature code #17714.
2. At the dial tone, dial the cancellation code ✕.
3. Listen for the confirmation tone.

---

---

## Placing IRSS Calls:

For IRSS calls placed from phones that send Caller ID, the IRSS feature must be enabled at your Coral station. See steps below.

For IRSS calls placed from phones that do not send Caller ID information, the IRSS feature must be enabled using the Executive Privilege feature. See [page 128](#).

### To place a call from IRSS phone providing Caller ID:

1. Place a call to your desk phone. Listen for the distinctive dial tone.
2. If a passcode is required (as defined by the Class of Service), enter it now.
3. At the dial tone, dial the number of the person you wish to call.

Possible destinations can be *external number (stationary or cellular) or network number, or a Coral destination, including station, trunk/trunk group, dial service, routing access, public/private library, voice mail.*

If your destination is an external number, it should be preceded by the outside line access code.

You can activate any of the options described in the table on [page 130](#).

### To place a call from IRSS phone that does not provide Caller ID:

This applies for IRSS calls from off-site phones that do not possess a Caller ID number and, therefore, cannot be identified by the Coral.

**NOTE!** *Some telephones may be denied the Executive Privilege feature (defined by Class Of Service). In order to use Executive Privilege your station must be defined with a passcode.*

1. Place a call to the Executive Privilege number (contact your system administrator for that number).
2. Listen for the dial tone.
3. Dial your own Coral station number.
4. Dial your 4-digit passcode. Listen for the distinctive dial tone.
5. Dial the required destination number.

---

---

Possible destinations can be: *external number (stationary or cellular), network number, or a Coral destination, including station, trunk/trunk group, dial service, routing access, public/private library, and voice mail.*

**NOTE!** *If your destination is an external number, it should be preceded by an external line access code.*

- If your destination is voice mail (IVR access code), skip to [page 132](#).
  - If your destination is a FlexiCall All feature, skip to [page 132](#).
  - To enable another IRSS phone, skip to [page 133](#).
6. Listen for the ringback tone.
  7. Wait for an answer.
  8. You can activate any of the options described in the table [below](#).

## Options available while in an established IRSS call

Function	Dial	Use to:
<b>Place a new call</b>	*1	Listen for a dial tone indicating that you can place a call to a new contact. Your original conversing party will be disconnected.
<b>Transfer call</b>	*2	A dial tone prompts you to enter the required transfer number. Transfer can be screened or unscreened. To return to the original conversing party (when transfer destination is busy or does not answer) dial *2 again.
<b>Switch to Broker/ Consultation/3Way Conference Call</b>	*2	A dial tone prompts you to enter the required third party number. Depending on your Class of Service definitions, one of the following party functions will be activated (see <a href="#">Broker/ Consultation/3-Way Conference call on page 131</a> ): <ul style="list-style-type: none"> <li>• Broker Call</li> <li>• Consultation</li> <li>• 3-Way</li> <li>• Combination of Broker/Consultation/3-Way Conference Call</li> </ul>
<b>Divert call to a Coral station</b>	*3	A dial tone prompts you to enter a divert number. You will be disconnected and your conversing party will be transferred to the divert number. Your number will not show on the divert party's display.
<b>Access voice mail/IVR</b>	*4	For instructions on accessing voice mail from an IRSS phone, see <a href="#">below</a> .
<b>Call Recording/ Help Requesting</b>	*6	Used to Start/Stop Recording outgoing calls (requires a system-wide defined Navigator application). Or send Help request (requires a pre-selected system-wide defined keyset station), see <a href="#">page 124</a> .

---

---

## Broker/Consultation/3-Way Conference call

While engaged in an established FlexiCall or IRSS call, you can use one of the options listed below, as defined by your Coral station Class of Service. See [page 194](#) for more information on Broker/Consultation/3-Way Conference calls.

Function	Use to:
<b>Broker Call</b>	<b>To activate a Broker call:</b> <ol style="list-style-type: none"><li>1. Dial *2.</li><li>2. Dial the third party and wait for an answer.</li><li>3. Dial *2 to alternate between parties (any number of times). When you hang up, the other parties will remain in conversation.</li></ol>
<b>Consultation Call</b>	<b>To activate a Consultation call:</b> <ol style="list-style-type: none"><li>1. Dial *2.</li><li>2. Dial the number of the person you wish to consult with.</li><li>3. When your conversation is concluded, dial *2 to return to the original call. The consulted party will be released.</li></ol>
<b>3-Way Conference Call</b>	<b>To activate a 3-Way Conference call:</b> <ol style="list-style-type: none"><li>1. Dial *2.</li><li>2. Dial the number of the person you wish to add on to the call.</li><li>3. When the party answers, dial *2 for a 3-way call.</li></ol>
<b>Combination of Broker/Consultation/3-Way Conference Calls</b>	<b>To activate any combination of Broker/Consultation/3-Way Conference calls:</b> <ol style="list-style-type: none"><li>1. Dial *2.</li><li>2. Dial the third party number and wait for an answer.</li><li>3. Dial *2. The third party is put on hold.</li><li>4. When you have concluded your private conversation, dial *2 to complete a 3-way Conference call.</li></ol>

---

---

## To activate Voice Mail/IVR from your IRSS phone:

You can access your voice mailbox, retrieve messages and setup voice mail options for your Coral station.

1. Place a call to your desk phone. Listen for the distinctive dial tone.
2. Dial the voice mail or IVR dial number (contact your system manager for the dial number and access code).
3. At the automated voice mail answer, dial the voice mail remote access code followed by your station number to access your station's voice mail box.
4. Dial \*4 as soon as the automated voice mail answers. This allows the system to recognize the voice mail or IVR commands.
5. Choose the required option from the voice mail or IVR menu.

**NOTE!** Contact your system administrator for the voice mail (IVR) dial number and voice mail remote access code. Use the table below to record that number and code:

Voice Mail (IVR) Dial Number	Voice Mail Remote Access Code

---

---

## To activate the FlexiCall All feature from your IRSS phone:

1. Place a call to your desk phone. Listen for the distinctive dial tone.
2. Dial the FlexiCall All feature code #17710.
3. At the dial tone, dial the destination number. Wait for the confirmation tone.

Possible destinations are: *operator, station, network number, UNA/Central Bell or external number (stationary or cellular) via Public/Private Speed Call Library.*

## To cancel the FlexiCall All feature from your IRSS phone:

1. Place a call to your desk phone. Listen for the distinctive dial tone.
2. Dial the FlexiCall All feature code #17710.
3. At the dial tone, dial the cancellation code ✖. Wait for the confirmation tone.

## To enable a new IRSS phone from your present IRSS phone:

1. Place a call to your desk phone.
2. At the distinctive dial tone, dial the passcode assigned to your station.
3. At the tone, dial IRSS feature code #17714.
4. At the tone, dial the number of the private library containing the number of the remote phone to be designated as your **new IRSS phone**.
5. Listen for the reorder tone. You are now disconnected. You can now access your station from your newly assigned IRSS phone.

## To cancel IRSS feature from your IRSS phone:

1. Repeat Steps [1-3](#) above.
2. Dial the cancellation code ✖. The IRSS feature is deactivated at your Coral station.



---

---

## Malicious Call Trace

This feature records the next *x* (a system-defined variable) calls to your FlexSet. A list of the calls can also be sent to a printer or terminal.

Press **Trace** to access the Malicious Call Trace options.

Page 1

10:50	26 May 2007	Company xyz
	<i>user name</i>	<i>station number</i>
↑→ COS-Sw	Setup	<b>Trace</b>

Page 2

Malicious Call Trace	
→ On/Off	Print

**On/Off**

**Malicious Call Trace On/Off** toggles the Malicious Call Trace on or off. If this feature is activated, a bullet appears next to **On/Off**, and next to **Trace** on the Idle screen.

**NOTE!** *If there are insufficient system resources for the feature to be available at your station, the message NO TRACE RECORD will be displayed.*

**Print**

**Malicious Call Trace Print** sends a list of the calls to a terminal or printer. The message CALL TRACE PRINT appears. The listing is not deleted when printed; it may be printed later with subsequent updates.

The details recorded are: originating number (for external calls: ANI if available or trunk number if not available), your station number and the time of calls.

**NOTE!** *Malicious Call Trace must previously be activated, or the message CALL TRACE OFF will appear and the action will not be completed.*

---

---

## Messages: Options

You can leave a message at another station and conversely, any station can leave a message at your station.

Press **[Msg]** to access the message options.

Page 1

```
10:50 26 May 2007 Company xyz
      user name  station number
↓→ •[Msg]          CALLog          Dir
```

Page 2

```
Message Options
→ •[Msg.]          MsgCan          Msg-Wt
```

**[Msg.]** **Leave Message** is used to leave a message at another station, or to access messages left at your station.

### Viewing and answering messages left at your station:

1. The message lamp flashes and a bullet appears next to the **[Msg]** and **[Msg.]** keys when there is a message waiting. The message consists of simple text, such as CALL SUSAN, or CALL VOICE MAIL, which is displayed on the top line.
2. Choose one of the following options after pressing **[Msg.]**:

**[Prev]** To view the previous message. If there is no previous message, LIST START appears on the top line.

**[Next]** To view the next message. If there are no other messages, then LIST END appears on the top line.

**[Dial]** or **[Call]** To call back the message sender. The message lamp is turned off if there are no other messages. *To call the Voice Mail, see [page 138](#).*

**[Dest]** / **[LveMsg]** To leave a message at another system station, dial a station, boss group or network number, and listen for the confirmation tone.

**[Cancel]** To cancel the message and the flashing message lamp without calling back the message sender.

**[Number]** To briefly display the number of the person who left a message.

---

---

## Leaving a message at another system station from idle when message list is empty:

1. Press **[Msg]**.
2. Press **[Dest]** or **[LveMsg]** and dial a station, boss group or network number.
3. Listen for the confirmation tone.  
You will hear a reorder tone when trying to leave a message at stations not equipped with a flashing message lamp.

## When your phone rings (message delivery):

1. Answer the call and check the station number displayed.
2. Deliver the relevant message.

**NOTE!** A message left at a Boss Group turns ON the message lamp of the first Boss Group member only.

**[MsgCan]**

**Message Cancel** allows you to cancel a message that you left at another station.

1. Press **[MsgCan]**.
2. Dial the station, boss group or network number at which you left a message.
3. Listen for the confirmation tone.

**[Msg-Wt]**

**Message Waiting.** The Attendant can use this feature to leave a message waiting indication at a busy or idle station, room or group.

## Leaving a message indication at an idle station:

1. Press **[Msg-Wt]** (Message Waiting).
2. Choose **[StRmGp]** and dial a station/room/group number, or scrollf through the list using **[CC]**.
3. Choose **[Set]** to assign or **[Cancel]** to deassign message.
4. Press **SPKR** or **[Exit]** to exit.

**NOTE!** A message left at a Boss Group activates the message lamp of the first member of that Boss Group only.

---

---

## Leaving a message indication at a busy or non-answering station:

1. Press **[Msg-Wt]** (or press **XFER** and dial 7) when hearing the busy tone or the station does not answer.
2. Listen for the confirmation tone.

## When your phone rings (message waiting delivery):

station or room #	MSG.	your #
MESSAGE ANSWER		
↓→ DND	Mute	FwdAll

### *Your phone rings*

ANSWER station or room #		
↓→ Page_Q	xfer	Hold

### *During message delivery*

## Answering a Message Waiting return call:

1. Answer the call and check the station number displayed.
2. Deliver the relevant message.
3. Message Waiting Indication for the relevant station will be cancelled automatically on answering if defined as a Hot Line,  
OR  
Press **[Msg-Wt]** to cancel the Message Waiting indication.
4. Press **SPKR** or hang up to release.

**NOTE!** *The method of canceling Message Waiting Indication is defined system-wide; Message Waiting Return calls can be defined system-wide as Hot Lines.*

---

---

## Messages: Voice Mail

You can use the Voice Mail feature to access your personal voice messaging system. The Coral system operates a dynamic voice mail system, which guides you through retrieval and handling of your messages, as well as administration of your voice mail options, using clear and logical voice and on-screen directions. Messages are displayed in order, with the most recent listed first.

If new voice mails have arrived at your station, a message indicating the number of new voice mails is displayed on the idle screen: < xx New V-mails >, where xx indicates the number of new voice mail messages. This count is reset to zero once the Voice Mail feature has been accessed, and is not shown again until there are new messages waiting.

There are several ways to access the Voice Mail options:

- Press **MENU** and choose **V-mail**.
- When there is a message waiting indication, press **Msg** **Msg.**, then select **CALL Voice Mail** (where *Voice Mail* is your local voice mail site name), and choose **Dial** or **Call**.
- Press the associated DSS key (see [Programming: Feature Keys on page 162](#) for programming a DSS key).
- Dial the Voice Mail access code (as defined by the system administrator).

Page 1

10:50	26 May 2007	Company xyz
	<i>user name</i>	<i>station number</i>
↓→	<b>Msg</b>	CALLog
		Dir

Page 2

Message Options		
→	<b>Msg.</b>	MsgCan
		Msg-Wt

---

---

*Page 3*

CALL VoiceMail		
↓→ Prev	Next	<input type="button" value="Dial"/>

*Page 4*

iCMC–Main Menu		
<1 New Msg>		
→ New	Old	Leave

**New Messages** can be played, deleted, archived and redirected (see below).

**Old Messages** can be played, deleted, archived and redirected (see below).

*Page 5*

01/02	New	10:00	10/10 2006
caller name	caller #		
↓→ Next	Play	Delete	

---

---

## New and Old Message Options

Note that functions may operate differently before, during and after playback (as explained below).

Before/After Playback:

**Next** / **Prev** **Next/Previous** displays the next/previous message header in the list.

**Play** / **Replay** **Play/Replay** is used to hear the current message.

**Delete** **Delete** is used to erase the current message from your message box. The next message header in the list is displayed.

**Archiv** **Archive** is used to save the current message in your archive list. The next message header in the list is displayed.

**Reply** **Reply** is used to send a message to the caller who left the original message, where the caller is a station with a voice message box.

**Redir** **Redirect** is used to send the current message to another station.

**Back** **Back** is used to return to the previous menu.

During Playback:

**Next** / **Prev** **Next/Previous** plays the next/previous message in the list.

**Pause** **Pause** is used to interrupt the message during playback.

Press **Resume** to continue the message from where you left off, or press **Back** to return to the previous menu.

**Rewind** **Rewind** is used to backtrack the currently playing message by 4 seconds. Press again to rewind an additional 4 seconds, and so on.

**FFwd** **Fast Forward** is used to track the currently playing message forward by 4 seconds. Press again to fast forward an additional 4 seconds, and so on.

**Delete** **Delete** is used to erase the current message from your message box. The next message in the list is played.

**Archiv** **Archive** is used to save the current message in your archive list. The next message in the list is played.

**Reply** **Reply** is used to send a message to the caller who left the original message, where the caller is a station with a voice message box.

---

---

**Redir**

**Redirect** is used to send the current message to another station.

**Back**

**Back** is used to return to the previous menu.

**Leave**

**Leave Message** is used to leave a message at another system station. Dial a station, boss group or network number, and listen for the confirmation tone.

**Setup**

**Setup** directs you to the Setup Menu. See [Voice Mail: Setup Options on page 142](#).

**SysMgr**

**System Manager Options Menu**. For authorized users only. See [Voice Mail: System Manager Options on page 148](#).

**Exit**

**Exit** directs you to the Exit Menu.

The following options are available from the Exit Menu:

**Quit**

**Quit** exits the Voice Mail system.

**Main**

**Main** accesses the Voice Mail Main Menu.

**Back**

**Back** returns to the previous menu display.



---

---

## Voice Mail: Setup Options

Press **[Setup]** from the Voice Mail menu to access the Voice Mail setup options. At each stage of the setup process, follow the audible directions given.

```
iCMC-Setup Options
< 1 New Msg >
↓→ Greet           Trans           Deliv
```

**[Greet]**

**Greetings Menu.** You may record a number of personal greetings for your mailbox. Along with a standard greeting, you may also record an alternate greeting for use during holidays, weekends, or time away from the office. When provided by your system setup, you may also record a busy or internal greeting, which is used in conjunction with the standard greeting.

```
iCMC-Setup Greetings
< 1 New Msg >
↓→ Currnt         Switch         Stdrd
```

**[Currnt]**

**Current Greeting** enables you to change the active current greeting, and rerecord the standard and busy or alternate greetings.

**[Switch]**

**Switch Greeting** enables you to select between the standard and alternate greetings to be used as the current greeting.

**[Stdrd]**

**Standard Greeting** enables you to record the standard voice mail greeting.

**[Busy]**

**Busy Greeting** enables you to record, activate or deactivate the greeting played when your station is busy.

**[Alt]**

**Alternate Greeting** enables you to record the alternate greeting (designed for when you are on holiday, away from the office, etc).

**[Back]**

**Back** returns to the previous menu display.

---

---

[Exit]

**Exit** directs you to the Exit Menu.

[Trans]

**Transfer Options Menu.** You may change the transfer or call handling options for your mailbox. There are two call transfer menus that can be displayed. One menu is displayed if call transfer to your extension is enabled, and the other is displayed if call transfer is disabled.

The following menu options are available when call transfer to your extension is disabled.

```

iCMC-Transfer Options
< 1 New Msg >
→ Enable           Back           Exit

```

[Enable]

**Enable** allows you to transfer to your extension and go to the Enabled menu.

[Back]

**Back** returns to the previous menu display.

[Exit]

**Exit** directs you to the Exit Menu.

The following menu options are available when call transfer to your extension is disabled.

```

iCMC-Transfer Options
< 1 New Msg >
↓→ Disabl         Chg#           Screen

```

[Disabl]

**Disable** allows you to disable transfer to your extension and go to the Disabled menu.

[Chg#]

**Change Transfer Number** enables you to change the number of the extension to which calls are transferred (e.g. your voice mail box number or co-worker's extension).

[Screen]

**Call Screening** is used to define whether callers are asked to record their name before the call is transferred. The person who receives the transfer will hear "Call from <name>".

**NOTE!** *If the person to whom the call is transferred rejects the call, or is not available, the recorded name is not saved.*

---

---

[Holdng]

**Call Holding** defines whether callers have the option to wait on hold if the extension is busy, or to be automatically transferred to the voice mail.

[Back]

**Back** returns to the previous menu display.

[Exit]

**Exit** directs you to the Exit Menu.

[Deliv]

**Delivery Options Menu.** Your station has four Voice Mail notification delivery numbers. These numbers are called Work, Home, Pager, and Spare. If enabled for use, the voice mail system will attempt to deliver notification of any messages left for you to these numbers during programmed time periods.

There are three visual menus associated with the delivery phone numbers. One menu selects the phone to be edited, one menu shows the options available when the phone is disabled, and one menu shows the options available when the phone is enabled.

The following menu options are available to select the delivery phone to be edited.



[Work]

**Work** enables you to go to the Work phone edit menu.

[Home]

**Home** enables you to go to the Home phone edit menu.

[Pager]

**Pager** enables you to go to the Pager edit menu.

[Spare]

**Spare** enables you to go to the Spare phone edit menu.

[Back]

**Back** returns to the previous menu display.

[Exit]

**Exit** directs you to the Exit Menu.

---

---

The following menu options are available once a delivery phone has been selected and delivery is disabled.

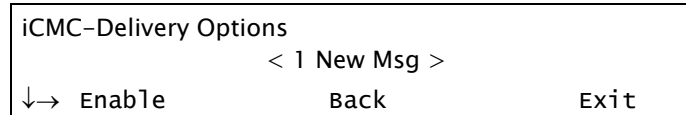

**Enable**

**Enable Delivery** is used to activate delivery of Voice Mail notifications to the phone selected and go to the Enabled menu for that phone.

**Back**

**Back** returns to the previous menu display.

**Exit**

**Exit** directs you to the Exit Menu.

The following menu options are available once a delivery phone has been selected and delivery is enabled.

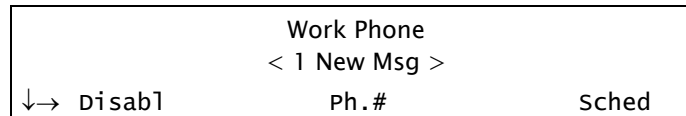

**Disabl**

**Disable Delivery** allows you to disable message delivery for the currently selected phone and go to the delivery phone disabled menu.

**Ph.#**

**Phone Number** enables you to edit the number of the delivery phone.

**Sched**

**Delivery Schedule** enables you to change the time period during which the message will be delivered to this phone.

**Urgent**

**Delivery Mode** enables you to change the delivery mode setting to:

**Each** (sends a notification for every message received); OR

**Urgent** (sends a notification for all urgent messages received).

**NOTE!** *A separate notification is sent for each message.*

---

---

**Back**

**Back** returns to the previous menu display.

**Exit**

**Exit** directs you to the Exit Menu.

**Group**

**Groups Menu.** You may own message groups in the voice mail system. The following menu options are available to edit message groups in the system.

```

iCMC-Group Options
< 1 New Msg >
↓→ Create          Edit          List

```

**Create**

**Create Group** enables you to create a new message group.

**Edit**

**Edit Group** enables you to edit an existing message group.

**List**

**List Groups** enables you to hear a list of all message groups.

**Delete**

**Delete Group** enables you to delete an existing message group.

**Back**

**Back** returns to the previous menu display.

**Exit**

**Exit** directs you to the Exit Menu.

**Pers**

**Personal Options Menu.** Your personal options control how you are listed in the voice mail system. The following menu options are available to edit personal subscriber settings.

**NOTE!** Both DTMF input and soft key button presses are valid from this menu.

```

iCMC-Personal Options
< 1 New Msg >
↓→ Code          SpName          Dir

```

**Code**

**Security Code** enables you to change or delete your security code.

**SpName**

**Spelled Name** enables you to change the spelling of your name in the voice mail system.

---

---

**Dir**

**Directory Listing** enables you to include or remove your name from the directory list.

**RcName**

**Recorded Name** enables you to change your recorded name.

**Email**

**Email** enables the system to deliver notification of any messages left for you to an email address.

**NOTE!** *Email notification is only available for email integration packages (e.g. Novell GroupWish, Lotus cc:Mail).*

**Back**

**Back** returns to the previous menu display.

**Exit**

**Exit** directs you to the Exit Menu.

---

---

## Voice Mail: System Manager Options

**SysMgr**

**System Manager Options.** You may have access to System Manager options, dependent upon your administrative settings. The following menu options are available to edit system manager settings.

**NOTE!** Both DTMF input and soft key button presses are valid from this menu.

```
iCMC-System Manager Options
< 1 New Msg >
↓→ ChgBox          Greet          Sched
```

**ChgBox**

**Change Mailbox** enables you to add, edit or delete mailboxes, and to delete user passcodes.

**Greet**

**System Greetings** enables you to record system greetings.

**Sched**

**System Schedule** enables you to edit the system schedule and system time.

**Info**

**System Information** enables you to listen to system information, including system ID, number of active ports, voice board driver versions, current time, software version and total recorded time in the system.

**Oper**

**Operator Settings** enables you to modify the operator box settings and fax options (including fax number).

**Back**

**Back** returns to the previous menu display.

**Exit**

**Exit** directs you to the Exit Menu.

---

---

## Music Options

If your system is equipped with a music source, you may choose to listen to music through your telephone speaker, when the FlexSet is in Idle mode. Music is automatically suspended during calls.

Press **[Music]** to access the Music options.

Page 1

10:50	26 May 2007	Company xyz
	<i>user name</i>	<i>station number</i>
↑→ Fwd	<b>[Music]</b>	DND

Page 2

Background Music	
→ On/Off	Tuner

**[On/Off]**

**Music On/Off** is used to toggle the music on or off. If this feature is activated, a bullet appears next to **[On/Off]**, and next to **[Music]** on the Idle screen.

**[Tuner]**

**Music Tuner** is used to choose between the available system-defined music sources.

1. Scroll through the available music sources using **[Next]** and **[Prev]**.
2. Select the desired music source by pressing **[Set]**.
3. Press **SPKR** to exit without saving.

Music volume can be adjusted by using the  keys.



---

---

## ***Mute Microphone***

During a conversation you may need to temporarily turn off the microphone on your telephone (handset and speakerphone). This will prevent the other party from hearing a portion of your conversation. The **[Mute]** key is an on/off switch and can be pressed as many times as necessary.

The mute feature deactivates the microphone for your speakerphone and handset or headset. Press the toggle key again to reactivate the microphone.

### **To turn off the microphone during a call:**

- Press **[Mute]**.

Party cannot hear your side of the conversation.

A bullet appears to the left of **[Mute]**.

### **To return to 2-way conversation:**

- Press the lit **•[Mute]**.

---

---

## Page Queue

Page Queue allows you to park a call (up to ten calls can be multi-parked simultaneously) on designated Page\_Q numbers by sending the call to one of ten Page Queue destinations. Once parked, a call can be either retrieved at another station or you can page someone else to pick up the call at any station or group of stations. You can page any system member from your FlexSet and announce that there is a call for Mr. Doe on Page Queue Line x. The call can be picked up from any system station by dialing the Page Queue access code (default access codes are 7060-7069).

**NOTE!** *To pick up the call, Mr. Doe should dial from any station to the relevant Page-Queue number (default numbers 7060-7069). If the call is not picked up within a predetermined time, it will automatically return to the originating station from which Page Queue was placed.*

The party placed on Page Queue may hear one of the following: music, recorded tone, busy tone or no sound at all, as defined system-wide for each Page Queue.

### To place a call in Page Queue:

1. While on a call, press **[Page Q]** to access the Page Queue options

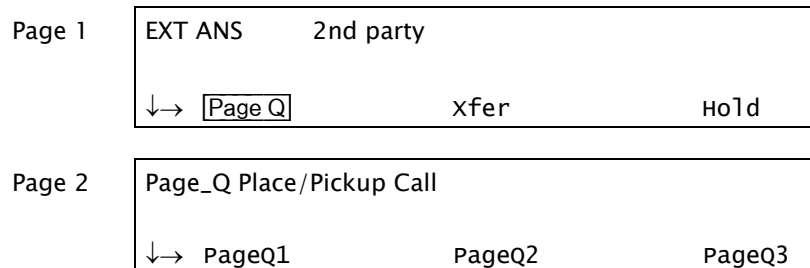

2. Press a free **[Page Qx]** (*ten options* see [Table on page 154](#)) to send the call to Page Queue number *x*.
3. Listen for the confirmation tone.

---

---

4. Announce that there is a call on Page\_Q line *x*.

Using available communication means notify another user to pick up the call.

Usually announcing a call for pick up includes the name of the person being notified and the relevant Page\_Q number.

**NOTES!** You can use one of the following methods to announce a call:

- Make a public address over PA speakers (see [page 155](#)).
- Voice page a specific station (see [page 156](#)).
- Voice page a group of stations (see [page 158](#)).

### To pick up a call placed in Page Queue (from any station):

1. Lift the handset of any telephone.
2. Dial assigned Page\_Q access code (7060-7069, see [Table on page 154](#)).
3. Begin speaking.

### To pick up a call placed in Page Queue (from Page Queue originating station):

1. Press **•[Page Q]** to access the Page Queue options.

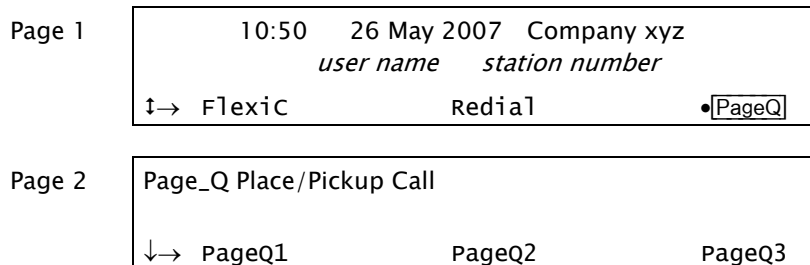

2. Press the relevant lit **•[Page Qx]** (*ten options* see [Table on page 154](#)) to retrieve the call from Page Queue number *x*.
3. Begin speaking.

---

---

## Return Call:

If the call is not picked up within a predetermined time, it will automatically return to the originating station from which Page Queue was placed.

1. Press **SPKR** or pick up the handset to answer.
2. Begin speaking.

NANS	page Q dial#	2nd party#
→ DND	Mute	FwdA11

---

---

### Page Queue - Access Codes

Page queue Number	Soft Key	Access Code (Dial Pad#)
1	[PageQ1]	7060
2	[PageQ2]	7061
3	[PageQ3]	7062
4	[PageQ4]	7063
5	[PageQ5]	7064
6	[PageQ6]	7065
7	[PageQ7]	7066
8	[PageQ8]	7067
9	[PageQ9]	7068
10	[PagQ10]	7069

---

---

## **Paging: Announcing, Public Address**

When a public address system is attached to the Coral system, use this feature to announce a message over your system's Public Address (PA) speakers.

Use the form [below](#) to write in locations and their associated access codes.

### **Paging a message over public address:**

1. Press **PAGE XXXX** DSS key or dial PA access code.
2. Announce your message.
3. Press **SPKR** or hang up to release.

**NOTE!** See [Programming: Feature Keys on page 162](#) for instructions on how to program a DSS key.

#### **PA Paging - Access Codes**

<b>Area/Location</b>	<b>Access Code</b>
1.	7074
2.	7075
3.	7076
4.	7077
5.	7078
6.	7079

---

---

## Paging: Voice Paging

This feature enables you to voice page another keyset (FlexSet, DKT, T207M or T208M) from your FlexSet. Essentially this feature is an intercom allowing persons to converse between stations, or can be employed as a simple pager.

Press **V-Page** to access the Voice Page feature.

Page 1

10:50	26 May 2007	Company xyz
<i>user name</i>	<i>station number</i>	
↕→ Park	<b>V-Page</b>	whspPg

Page 2

VOICE PAGE
***** Enter Destination *****

### Voice Paging a single keyset station:

When Busy:

- Press **V-Page** upon reaching a busy keyset station to send a message to the other party that they are being paged.

When Unanswered:

- Press **V-Page** upon hearing the ringback tone at unanswered keyset station. The call will automatically connect.

From Idle:

1. Press **V-Page**.
2. Dial a keyset station number.
3. Listen for the Voice Page tone and begin speaking.

**NOTE!** When you hear reorder tone and *DNT DIS VP* message appears, the station is protected from receiving voice page calls. (See [Voice Page Receive](#) on [page 234](#) for configuration instructions.)

---

---

## Answering a Voice Page:

1. Listen for the voice page (warbling) tone.
2. If you are in a conversation, either place the call on hold or hang up, then continue with the following steps:

*When Auto Answer is Defined, see [Setup on page 232](#):*

- When the tone stops, the voice page automatically connects through the speaker.  
Converse hands-free, or lift the handset for private conversation.

*When Manual Answer is Defined, see [Setup on page 232](#):*

- Press the flashing **SPKR** key or lift the handset.



---

---

## Paging: Zone Page

Use this feature to page a pre-programmed group of keysets (FlexSet, DKT, T207M or T208M) within a zone, area or dispersed within your company. The entire group can be paged by dialing the Zone Page access code (default dial numbers: 7300 to 7309).

Use the form [below](#) to write in the various paging zones or areas in your company and their associated access codes.

### Sending a Zone Page:

1. Dial the Zone Page Access Code or press a pre-programmed DSS key with the Access Code number.  
(See [Programming: Feature Keys on page 162](#) for instructions on how to program a DSS key.)
2. Announce your message to the group.
3. Disconnect when you finish announcing.

**NOTE!** See your system administrator to view or define the zone group access codes and their respective members.

**Zone Paging - Access Codes**

Area/Location	Access Code	Area/Location	Access Code
1.	7300	6.	7305
2.	7301	7.	7306
3.	7302	8.	7307
4.	7303	9.	7308
5.	7304	10.	7309

---

---

## Park

During a call, use Park to place the second party on hold at your station so that it can be picked-up at another station. The **[Park]** soft key is shown with a bullet next to it, indicating that a call has been parked at your station. The parked party hears music or a tone (system-defined).

Press **[Park]** to Park a call, or to retrieve from Park.

### Parking a Call:

1. While on a call press **[Park]**.
2. Listen for the confirmation tone.

The call goes into Park and **LOOP** flashes at your station. Your station is free to make other calls.

*Page 1*

10:50	26 May 2007	Company xyz
<i>user name</i>	<i>station number</i>	
↑→ <b>[Park]</b>	V-Page	whspPg

*Page 2*

CALL PARK	Name
→ Next	ReConn

### Retrieving a Parked Call (from any station):

1. Lift the handset of any telephone.
2. Press **[Park]** or dial Park feature code #183.

- 
- 
3. Dial the station number at which the call was parked. If more than one party has been placed on Park, scroll between names by using **[Next]**.
  4. Begin speaking.

## Retrieving a Parked Call (from the originating station where the call was parked):

Press the flashing **LOOP**, **LINE**, or DSS key and begin speaking.

OR

1. Press **[Park]**.
2. Choose **[ReConn]** or dial the activation code ✓. If more than one party has been placed on Park, scroll between names by using **[Next]**, or by pressing the  button.
3. Begin speaking.

## Return Call:

If the parked call is not picked up within a predetermined time (system-defined timeout), the call will automatically return to the originating station from which the park was made.

1. Press **SPKR** or pick up the handset to answer.
2. Begin speaking.

RECALL	2nd party#	
→ DND	Mute	FwdAll

**NOTE!** *More than one call can be parked at a single station, but calls are retrieved on a first-in, first-out basis (FIFO). That is, the first parked call (first-in) will be the first call that is picked up (first-out). However, if multi-parking is required it is recommended that the Page Queue feature be used instead (see [Page Queue on page 151](#)).*

---

---

## Phone Lock

Use this feature to prevent unauthorized persons from using your phone line. Incoming calls may still be answered.

Press **[Lock]** to lock your FlexSet.

Page 1

10:50	26 May 2007	Company xyz
<i>user name</i>	<i>station number</i>	
↑→ AcctCd	<b>[Lock]</b>	Exec

Page 2

PHONE UNLOCK ENTER PASSCODE
--------------------------------

Page 3

10:50	26 May 2007	Company xyz
<i>user name</i>	<i>station number</i>	
UnLock	UnLock	UnLock

### Locking/unlocking your phone:

1. Press **[Lock]** or **[Unlock]**.
2. Dial your 4-digit Passcode number. *To define your passcode, see [Setup: Passcode on page 235](#).*
3. Listen for the confirmation tone.
4. When your phone is locked, all outbound dialing is prohibited, and FlexSet features are not accessible. All soft keys are replaced with **[Unlock]**. Attempting to dial a number or access a feature results in the PHONE LOCKED message being displayed.

---

---

## Programming: Feature Keys

The FlexSet comes equipped with 4 system-defined (fixed) keys as well as user programmable keys. You are able to program most of the programmable keys from the FlexSet itself.

There are 6 user programmable keys for the FlexSet 120S/121S (see [page 4](#)).

Press **[Setup]** **[ProgKy]** to access the Key Programming options.

*Page 1*

10:50	26 May 2007	Company xyz
	<i>user name</i>	<i>station number</i>
↑→ COS-Sw	<b>[Setup]</b>	Trace

*Page 2*

Feature Setup		
↑→ <b>[Progky]</b>	Prefer	PrvLib

*Page 3*

PROGRAM	
SELECT BUTTON.	
→ Prev	Next

---

---

The programmable buttons may include either dial numbers (stations, groups, trunks, trunk groups, etc.) or Coral feature activation codes. Several dial commands, in a series, may be programmed into one programmable key - useful for one-button speed dialing, voice response and voice mail system access, and other complex dialing patterns.

Features keys can be programmed exactly as they are programmed in the FlexSet 120D series keysets.

Use the following guide to navigate through this topic:

<a href="#">Programming Feature Keys</a> .....	page 164
<a href="#">Programming Boss Group Line Keys</a> .....	page 165
<a href="#">Programming ELA Group Line Keys</a> .....	page 166
<a href="#">Programming: Button Labeling</a> .....	page 169
<a href="#">Index: Soft Keys and Feature Codes</a> .....	page 259
<a href="#">Programming Keys: Examples</a> .....	page 167

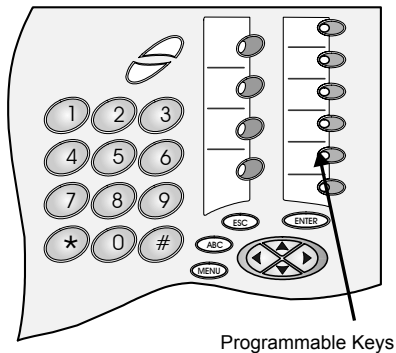

---

---

## Programming Feature Keys

### To Program Feature Keys:

1. Press **[ProgKy]**.
2. Press the DSS/Feature key you wish to program.
3. Dial the numbers exactly as you would normally to enable the feature or to speed dial.
4. If the button is already programmed, the contents appear on the system lines.
5. Press the DSS/Feature key again to save the contents to memory.

### To View Programmed Key Contents:

1. Press **[ProgKy]**.
2. Press programmed key.
3. View contents on system lines.
4. If the length of the number exceeds the display size, press the **[Next]** button to scroll through additional digits.
5. Press **SPKR** to release.

### To Delete Programmed Key Contents:

1. Press **[ProgKy]**.
2. Press the programmed key.
3. View contents on system lines.
4. Press **[Prev]** or the  button.
5. Press the programmed key again to delete.

---

---

## Programming Boss Group Line Keys

Each FlexSet in a Boss Group can be programmed with up to 6 line keys. The use of programmed line keys assists in defining the various ways in which a Boss Group can answer incoming calls. To learn about the different uses of Boss line keys, see [Boss Groups on page 61](#).

### To Program Line Keys:

1. Press **[ProgKy]**.
2. Press the **LINE NN** DSS key you wish to program.
3. Dial Boss LINE feature code (default dial number: #126).
4. Dial the Boss Line number (**00** = first line, **01** = second line, etc. up to **05**). Two digits must be entered.
5. Dial the Boss Group number.
6. Press the selected **LINE NN** DSS key again.
7. Press **SPKR** to release.

**NOTE!** *Do not perform the above steps if your FlexSet has a button preprogrammed with a number of the trunk reserved for your Boss Group. This button will be used as a line key.*



---

---

## Programming ELA Group Line Keys

Each FlexSet in an ELA Group can be programmed with up to 32 ELA line keys. To learn about the different uses of ELA line keys, see [ELA \(Extension Line Appearance\) on page 97](#).

### To Program ELA Line Keys:

1. Press **[Setup][ProgKy]**.
2. Press the **LINE NN** DSS key you want to program.
3. Dial the ELA LINE feature code (default dial number: #17718).
4. Dial the ELA Group number (main ELA station number).
5. Dial the Ring State digit, as follows (one digit must be entered):
  - [3] Delay- Delay** ringing after a system-defined timeout period.
  - [6] - No** ring upon receiving an ELA Group call.
  - [9] - Yes** immediately ring upon receiving an ELA Group call.
6. Dial the ELA Line number (**00** = first line, **01** = second line, etc. up to **31**). Two digits must be entered.
7. Press the selected **LINE NN** DSS key again.
8. Press **SPKR** to release.

## Programming Keys: Examples

Key Contents	Key Description	Procedure/Example
DSS (Direct Station Selection)	Permits you to make or transfer a call to an extension or trunk by using a defined key, and provides a busy lamp indication for stations or trunks programmed under a DSS key.	To program a DSS key for extension <b>4577</b> : Press <b>[ProgKy]</b> , press the key you wish to program and then the extension number <b>4577</b> . To conclude, press the key again.
Single feature	Permits you to activate or cancel a single Coral feature.	To program a key to turn the Do Not Disturb (DND) feature on and off: Press <b>[ProgKy]</b> , press the key you wish to program and then the feature code <b>#145</b> . To conclude, press the key again.
Series of features	Permits you to program a series of features under a single key; useful for one-button speed dialing, voice response and voice mail system access, and other complex dialing procedures. The SPKR code <b>#120</b> must be programmed between each successive feature sequence.	To program a key to simultaneously turn off the DND and transfer all calls to a library number programmed for voice mail: Press <b>[ProgKy]</b> , press the key you wish to program and then the feature code <b>#145</b> . Dial twice, in succession, SPKR code <b>#120</b> . Enter feature code <b>#141 7000</b> (an example of a library number). To conclude, press the key again. <b>NOTE!</b> <i>In order for this to work properly, one of the two features must be previously activated.</i>
Feature key without confirmation tone or display	Permits you to activate or cancel a feature or series of features without hearing a confirmation tone or seeing a display. The SPKR code <b>#120</b> must be programmed <b>twice</b> after each successive feature sequence.	Follow the directions above and dial twice, in succession, SPKR code <b>#120</b> after library code <b>7000</b> .

Key Contents	Key Description	Procedure/Example
Series of features with LED indication	<p>Permits you to activate or cancel a series of features with the LED being controlled by the key pressing order. When the key is pressed the first time, the LED will light and the features will be activated. When the key is pressed again, the LED will be extinguished, regardless of the current state of the features.</p> <p><b>NOTE!</b> <i>The <b>LED On/Off</b> feature code #1301 must be programmed before the first feature code is entered in order to function properly.</i></p>	<p>To program a key to simultaneously turn on both the DND and idle display features:</p> <p>Press <b>[ProgKy]</b>, press the key you wish to program and then the LED On/Off feature code <b>#1301</b> and feature code <b>#145</b>. Dial twice, in succession, SPKR code <b>#120</b>. Enter feature code <b>#137</b>. To conclude, press the key again.</p>
Outside telephone number (Speed Key)	<ul style="list-style-type: none"> <li>Permits you to program a key to dial an outside telephone number.</li> </ul>	<p>To program a key to dial <b>(914)354-8132</b> over trunk group 9:</p> <p>Press <b>[ProgKy]</b>, press the key you wish to program and then enter the trunk group number (9) followed by the area code <b>914</b> and the number <b>3548132</b>. To conclude, press the key again.</p>
XDA (External Destination Appearance)	<p>Permits you to program a DSS key to provide a common line appearance of external destinations for Boss Group members. When the external destination calls into the Boss Group, its Public Library key lights at all the boss group member's stations.</p>	<p>Program each Boss Group member with a DSS key containing the reserved Public Library number for the external destination.</p>

---

---

## **Programming: Button Labeling**

The FlexSet includes a removable faceplate for the programmable buttons on the phone, enabling the user to label the buttons.

The DESI™ Plus Labeling System is used to label the buttons on the FlexSet. DESI Plus is a user-friendly and powerful telephone designation strip program, which allows an office printer to quickly create labels custom-designed for various FlexSets.

The FlexSet comes with a preprinted DESI label inserted beneath the faceplate. Additional blank DESI Labels may be purchased from your dealer in letter or A4 sized paper. The sheets of peel-off stickers are provided to label the FlexSet buttons with names and phone numbers. To choose the appropriate label sheet layout designated for the specific FlexSet model, refer to the table below.

Use DESI software downloaded from the manufacturer's site: [http://www.tadirantele.com/products\\_terminals.asp](http://www.tadirantele.com/products_terminals.asp) or from the DESI site: <http://www.desi.com> to print the labels from your computer. Follow the online download instructions.

FlexSet Model	Label Sheet Catalog #		Details
	Letter, (8 ½ x 11")	A4	
120S, 121S	7244-7400432	7244-7400422	10 buttons, with Navigator

---

---

## Printing the multi-designation label:

- Use the DESI software to select the layout of your multi-designation label (as described on the previous page)
- Enter the button content names per button location
- Feed your printer with the label sheet
- From the DESI Plus/DESI Lite menu, choose *File > Print*

**NOTE!** *The left column on the multi-designation label is intended for the four system-defined fixed keys. Other columns are intended for the programmable speed dial keys.*



Lift up to remove cover

### **Button labelling for FlexSet 120S/121S**

---

---

## Inserting the telephone number:

1. Insert a pointed tool into the hole located on the plastic plate covering the blank telephone number, as shown in the figure below.
2. Lift upward to remove the plastic plate.
3. Peel off the printed label intended for the telephone number.
4. Insert the printed label.
5. Put the plastic plate back in place over the phone number.

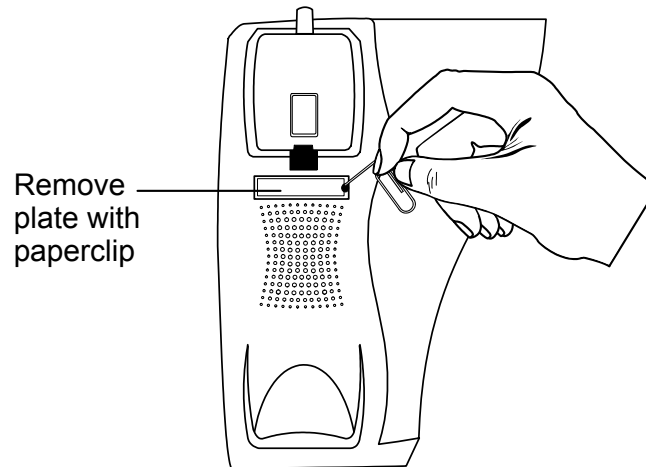

---

---

## ***Recording a Call***

This feature allows you to start recording while in conversation with a second party, 3-way or multi-party conference. It is operated while the current call is in progress, without disrupting the call.

The Coral system must be equipped with a uCMC, iCMC, CMC, WiCMC or CMC for Windows.

The feature is activated by pressing a toggle RECORD key (a programmed HELP key with APDL as the destination). The RECORD key is used as a trigger for a predefined destination (APDL) to start recording the call to the user's voicemail box.

### **Programming a Record key:**

1. Press **[Setup]** **[ProgKY]**.
2. Choose and press the DSS key.
3. Dial **HELP** feature access code (default dial number: #1443).
4. Dial the destination APDL.
5. Press the selected DSS key again.

### **To Start Recording the Call:**

1. During a call, in order to record the conversation, press the **RECORD** DSS key and continue the call.
2. Recording starts when the **RECORD** key LED flashes.

### **To Stop Recording the Call:**

1. During a call that is already being recorded, press the **RECORD** DSS key again to end the recording.

---

---

## Redial

Redialing options are accessed by pressing **[Redial]** from idle state.

Page 1

10:50	26 May 2007	Company xyz
<i>user name</i>	<i>station number</i>	
↑→ FlexiC	<b>[Redial]</b>	Page_Q

Page 2

Redial Numbers		
→ Last#	Saved#	AutRd1

**[Last#]** **Last Number Redial** is used to redial the last number (most recent number) dialed from this FlexSet. You can also press asterisk key (\*) from the dial pad to redial the most recent number.

**[Saved#]** **Saved Number Redial** is used to redial an outside number that you have stored in memory. A number can be saved during a conversation, when you hear a busy tone, or when the dialed number is not answered by choosing **[Saved#]**.

**NOTE!** *As opposed to Last Number Redial, the saved number will remain in memory until another number is saved by repeating the above procedure.*

**[AutRd]** **Auto Redial** is used to repeatedly redial an outside number that is busy. More than one number can be stored in the Auto Redial list. A number can be entered for auto redialing either when you hear the busy tone when making an external call (see [Upon Hearing Busy Tone on page 37](#)), or upon hearing ringback (see [Upon Hearing Ringback Tone on page 35](#)), or from idle before making an external call (see [below](#)). The number will be redialed until the external phone rings, or up to a system-defined number of attempts, before the number is erased from the Auto Redial list.



---

---

## Activating Auto Redial from idle (before making an external call):

1. Press **[AutRdl]**.
2. Dial the required outside line access code or press the relevant preprogrammed outside line key.  
Possible outside line access codes are *trunk number*, *trunk group number*, *routing access*, *dial service*, *private/public library number*, *last number redial code*, or *saved number code*.

3. Dial the outside number.

4. Press **[Enable]**.

The number will now automatically redial at timed intervals. When the called party answers, press the flashing **SPKR** key or lift the handset to enable conversation.

Once Auto Redial has been activated, the following options appear in idle state after pressing **[AutRdl]**. The features in the following table affect all numbers in the redial list.

To	Press	Display Message	Feature Key LED	Comments
<b>Cancel</b>	<b>[CanAll]</b>	AUTO REDIAL / LIST EMPTY	Off	Deletes all numbers in the redial list. A confirmation tone is heard.
<b>Freeze</b>	<b>[FrzAll]</b>	HOLD SET	Flashing	Ceases all automatic dialing. Confirmation tone is heard.
<b>Restart (release from freeze)</b>	<b>[RstAll] / SPKR</b>	HOLD REMOVED	On	Re-enables dialing of the "Frozen" numbers.
<b>Add</b>	<b>[Add]</b>		On	Adds another external number to the redial list.

Press **[Next]** and **[Prev]** to scroll through the redial list. When the required number is found the Auto Redial features (see table below) can be directly activated for the selected number. Press **SPKR** to exit.

To	Press	Display Message	Feature Key LED	Comments
<b>Select a saved redial number</b>	[Next] / [Prev]	REP DIAL # nn ttt dddddddd	On	Selects the next or previous number in the redial list.
<b>Enable</b>	[Enable] / SPKR			Exits the redial feature and returns to normal keyset operation.
<b>Restart (release from freeze)</b>	[Restar]	REP DIAL # nn HOLD REMOVED	On	Re-enables dialing of the selected number.
<b>Immediately Dial</b>	[ImDial]	CONFIRMED	On	Confirms the selected number and immediately dials.
<b>Cancel</b>	[Cancel]		On	Deletes the selected number.
<b>Freeze</b>	[Freeze]	REP DIAL # nn h HOLD SET	Flashing	Ceases dialing the selected number.
<b>Assign Priority (double redial cycle)</b>	[Prior]	REP DIAL # nn P PRIORITY SET	On	Increases the redialing rate for a selected number.
<b>Cancel Priority</b>		REP DIAL # nn PRIORITY REMOVED	On	Remove Priority - Returns selected number to standard redial cycle.

nn = serial number (01, 02, 03...), tttt = outside line access code or name, dddd = external telephone number

**NOTE!** *It is recommended that you program a feature key to make the most out of the Auto Redial feature. To program an Auto Redial feature key, see [Programming: Feature Keys on page 162](#). Default Auto Redial access code: #178.*

---

---

## Relay (Accessory)

You can switch a relay on or off in order to activate certain external devices, such as external alarm, or electric lock. These devices are installed by your company. Use the form below to write down the types of external devices and their associated codes that are installed.

### Activating/deactivating Relay:

1. Dial the Relay Code (Default Dial Numbers: 7086 to 7091).
2. Choose  to turn relay on;  
OR  
Choose  to turn relay off.
3. Listen for the confirmation tone.

**Relay Codes**

External Device	Relay Access Code
1.	7086
2.	7087
3.	7088
4.	7089
5.	7090
6.	7091

---

---

## Reminder

Use this feature to set, review, or cancel reminders, which will ring your FlexSet at a designated time. You can set reminders to ring your FlexSet at one or more designated times. If you do not answer the call, the FlexSet will ring three more times at one minute intervals. More than one reminder can be programmed. Press **[Remind]** to access the Reminder menu.

Page 1

10:50	26 May 2007	Company xyz
	<i>user name</i>	<i>station number</i>
↑→ <b>[Remind]</b>	Pickup	CampOn

Page 2

REMINDER	12:00PM	
→ New	Next	Cancel

### Entering a Reminder request:

To enter a reminder request, press **[Remind]**, enter the time you wish to be called at the ENTER TIME prompt, and choose **[AM]** or **[PM]**. Note that four digits are required for a 12-hr clock: (i.e. 0805 for 8:05).

To add another reminder time, choose **[New]** and continue as above.

To scroll through the reminder list, press **[Next]**.

To cancel the selected reminder time (displayed on the top line), choose **[Cancel]**.

### When Reminder call rings:

When the FlexSet rings, the REMIN message appears on the top line indicating that this is a reminder call. Press **SPKR** to answer the call; The ANSWER REMIN message appears on the top line. Choose one of the following:

1. Press **[Snooze]** to have the system call you again later (after a system-defined time period).
2. Press **SPKR** again to cancel the reminder.

---

---

## Room Status

Used to turn the Room Status definition of your station on or off. There are 16 different Room Status definitions. Use the [Table on page 179](#) to write in the various room statuses and related access codes available at your telephone.

This feature is applicable for Hotel/Motel use. In cases where this is required, specific instructions will be given.

**NOTE!** Check with your system administrator whether your Coral system supports the Room Status or Canned Messages feature. If your Coral system supports the Canned Messages feature (see [page 81](#)), the Room Status feature is unavailable.

Press **[RoomSt]** to access the Room Status options.

Page 1

10:50	26 May 2007	Company xyz
<i>user name</i>	<i>station number</i>	
↑→	<b>[RoomSt]</b>	

Page 2

Room Status			
↓→	RmSts0	RmSts1	RmSts2

**[RmStsx]**

Press the required Room Status soft key (**[RmStsx]** where  $x=0$  to 15, see [Table on page 82](#)) to activate. The status definition appears on the top line. When activated, a bullet is shown next to **[RmStsx]**, and next to **[RmSts]** on the idle screen.

To cancel, press the relevant lit **•[RmStsx]** key again.

---



---

### Room Status - Names and User Access Codes

Room Status Number	Soft Key	Access Code (Dial Pad#)	Name
0	[RmSts0]	7026	
1	[RmSts1]	7027	
2	[RmSts2]	7028	
3	[RmSts3]	7029	
4	[RmSts4]	7030	
5	[RmSts5]	7031	
6	[RmSts6]	7032	
7	[RmSts7]	7033	
8	[RmSts8]	7034	
9	[RmSts9]	7035	
10	[RmSs10]	7036	
11	[RmSs11]	7037	
12	[RmSs12]	7038	
13	[RmSs13]	7039	
14	[RmSs14]	7040	
15	[RmSs15]	7041	

---

---

## **Series Call**

Series is used to mark an external call before transferring it to a third party. This causes the call to return to you after the third party hangs up. This feature can *only* be used during conversation.

### **Marking a call as a Series Call:**

1. During conversation, press `[Series]` to mark the call.
2. Listen for the confirmation tone.
3. Transfer the call when you are ready.

The marked call will now return to you after the third party has hung up.

**NOTE!** *Should you try to mark a call that has already been marked the error message `ALREADY SET` will appear.*

### **When your telephone rings (third party hangs up):**

1. The call will return to you with the `SERIES` message displayed.
2. Answer the call as normal when your station rings.
3. Ask calling party if transfer to another party is required; or Set up the call as a series call; or Hang up.

---

---

## Silent Monitoring

This feature enables an authorized (COS and AUTHORIZATION) user to monitor and/or record (may require additional hardware) any system port, station, trunk, etc. in any state (except data and conference), without audio or visual warning to the monitored party. While monitoring a port, your telephone returns a busy signal for all incoming calls.

The volume can be adjusted using the  buttons whilst monitoring, and you can whisper by pressing `[WhspPg]`.

Press `[SlMon]` to access the Silent Monitoring options.

Page 1

10:50	26 May 2007	Company xyz
<i>user name</i>	<i>station number</i>	
↑→ <code>[SlMon]</code>	AcctCd	IdCtrl

Page 2

Silent Monitoring	
↓→ Split	Both

`[Split]` (or `[S.Mon1]` in FlexSet 120S type B) **1-Way Split Silent Monitoring** is used to monitor either side of a 2-way conversation separately. Only one of the conversing parties can be heard at any one time. This feature can be activated from idle only, as follows:

1. Press `[Split]` (or `[S.Mon1]` in FlexSet 120S type B).



- 
- 
2. At the prompt, dial the station number of the original destination (1<sup>st</sup> party), then:
    - To monitor the 1<sup>st</sup> conversing party, choose **[Origin]** or dial the cancellation code ✕
    - To monitor the 2<sup>nd</sup> conversing party, choose **[Prtnr]** or dial the activation code ✓
    - To cancel Split Silent Monitor, press **SPKR** or hang up.

**NOTE!** *If you hear the reorder tone when attempting to monitor a call, the port is SECURED against monitoring.*

**[Both]** (or **[S.Mon2]** in FlexSet 120S type B) **2-Way Silent Monitoring** is used to monitor both sides of a 2-way conversation simultaneously. This feature can be activated from idle, or while attempting to call a busy or non-answering destination.

**NOTE!** *This feature requires a CNSsl card, an 8DRCF, an 8DRCM card or a CNF card to be installed in the system. When a CNF card is installed, it must be defined as C3-WAY.*

## Operating from idle:

1. Press **[Both]** (or **[S.Mon2]** in FlexSet 120S type B).
2. At the prompt, dial the station number.

Options available while monitoring:

- To cancel 2-way Silent Monitor, press **[Abort]**, **SPKR** or hang up.
- To whisper to the 1<sup>st</sup> party, press **[WhspPg]**.

## Operating upon hearing busy or ringback tone:

1. Dial the station.
2. Upon hearing busy or ringback tone, press **[Both]** (or **[S.Mon2]** in FlexSet 120S type B).  
OR  
Press **[Xfer]** and dial 9.

---

---

Options available while monitoring:

- To cancel 2-way Silent Monitor, press **[Abort]**, **SPKR** or hang up.
- To whisper to the 1<sup>st</sup> party, press **[WhspPg]**.

**NOTE!** *If you hear the reorder tone when attempting to monitor a call either the port is protected against monitoring (SECURED) or All conference card ports are engaged (NO RESOURCE).*

---

---

## ***Speed Dialing: Private Library***

You may program your telephone with your own private Speed Dial directory, which can be used to speed dial long numbers. Each entry is called a Private Library Number. The Private Library can be programmed with an external or internal dial number. You can also use a Private Library to dial external or network numbers for features that allow only internal destinations such as Call Forward, Divert and Hunt features. When entering external dial numbers, make sure to include the external access code into the Private Library number as well.

The speed dial numbers are programmed per station and are unique to each station. Therefore, dialing the same private library number at one station will most likely include a different destination than dialing the same Private Library number at another station. Use the table below to write down your Coral Speed Dial numbers.

**Private Library - Speed Dial Numbers**

<b>Private Library Number</b>	<b>Private Library Contents (Destination)</b>
7000	
7001	
7002	
7003	
7004	
7005	
7006	
7007	
7008	
7009	

---

---

## Programming a new Private Library:

Private Libraries are saved via the Coral system with your station number but not in your FlexSet's memory.

Private Library is accessible from the Setup menu. Press **[Setup]** **[PrvLib]** to access the Private Library options.

Page 1

10:50	26 May 2007	Company xyz
	<i>user name</i>	<i>station number</i>
↑→ COS-Sw	<b>[Setup]</b>	Trace

Page 2

Feature Setup		
↑→ ProgKy	Prefer	<b>[PrvLib]</b>

Page 3



PRIVAT LIBRARIES		
↓→ Lib#	Prev	Next

**[Lib#]** **Library** is used to select a new Private Library number.

**[Prev]** **Previous** scrolls to the previous Private Library.

**[Next]** **Next** scrolls to the next Private Library.

### To program or change a Private Library Speed Dial number

1. Press **[Setup]** **[PrvLib]**.
2. Choose **[Lib#]** and dial the Library number to be programmed or scroll through the list of private library numbers using **[Next]** and **[Prev]** or the  and  keys.

- 
- 
3. The Library number (e.g.: PRIVAT LIB 7000) appears on the top line of the display. The Library contents appear on the second line of the display.

**NOTE!** Use the table on [page 184](#) to write down your Coral Private Speed Dial numbers (default Private Library numbers are 7000 to 7009, these may differ in your system, see your system administrator for your system's Private Library numbers).

4. Dial the digits you would normally dial to place the call (include outside line access code). Insert required dial parameters in between the dialing digits when needed. These parameters appear over pages on your FlexSet display. Press the relevant soft key when needed. The list of dial parameters is given below:

**NOTES!** Possible outside line access codes are: trunk number, trunk group number, dial service, routing access or another public/private library number.

*The number of digits that can be programmed, including Codes and Pause (time delay), is limited by the system (defined system-wide). Should you try entering a longer digit string than allowed, the system will give the error message LENGTH EXCEEDED, and programming will stop.*

**Extrn#** **External telephone number.** Choose this to program or change an external number in the required Library number. Dial the required external number. Press **SPKR** to save your entry, or **Next** or **Prev** to save this number and select a new library number.

**Next** **Next** is used to view the next Library number.

**Prev** **Previous** is used to view the previous Library number.

**Cancel** **Cancel** is used to delete the Library contents.

After entering the outside access code, when entering digits into the Library number, you may also enter any one of these special dial codes in between the digits to enhance dialing:



**Pause** **x sec** **Time Delay (seconds)** where  $x=1$  to 9: Introduces a delay of  $x$  seconds before the following digits are dialed.

**Codes** **Final** **Final Digit** (stop dial). Indicates to the system to stop dialing the outside number (display shows ‘.’).

---

<code>[Codes]</code> <code>[FreeDI]</code>	<b>Free Dial.</b> Offers the user a free time interval in which he is able to dial any number of digits.
<code>[Codes]</code> <code>[Pulse]</code>	<b>Dial Pulse.</b> Notifies the system that all following digits will be Dial Pulse digits.
<code>[Codes]</code> <code>[Tone]</code>	<b>Dial Tone (DTMF).</b> Notifies the system that all following digits will be DTMF digits.
<code>[Codes]</code> <code>[DspOff]</code>	<b>Display Off.</b> Inhibits the display of the Library contents on the FlexSet. Also used for Call Accounting System (digits displayed as ‘_’).
<code>[Codes]</code> <code>[DspOn]</code>	<b>Display On.</b> Enables the display of the Library contents on the FlexSet. Also used for Call Accounting System.
<code>[Codes]</code> <code>[WaitDT]</code>	<b>Wait for Dial Tone.</b> Asks the system to wait for Dial Tone before dialing the digits.
<code>[Codes]</code> <code>[Dsp -]</code>	<b>Display Dash (-).</b> Displays a dash (-) within the dialing number on the FlexSet.
<code>[Codes]</code> <code>[FlshTk]</code>	<b>Flash Trunk.</b> Sends a Calibrated Opening (Flash) over a trunk line (display shows hf).
<code>[Codes]</code> <code>[Dial*]</code>	<b>Dial Asterisk (*).</b> Dials an asterisk (*) as part of the dialing number.
<code>[Codes]</code> <code>[Dial#]</code>	<b>Dial Pound (#).</b> Dials a pound sign (#) as part of the dialing number.

## Deleting a single Private Library Number from memory:

1. Press `[Setup]` `[PrvLib]`.
2. Choose `[Lib#]` and dial the Library number to be removed or scroll through the list of private library numbers using `[Next]` and `[Prev]` or the  and  keys.
3. The Library number (e.g.: PRIVAT LIB 7000) appears on the top line of the display. The Library contents appear on the second line of the display.
4. Choose `[Cancel]`.
5. Press **SPKR** to exit.

---

---

## ***Speed Dialing: Using Private and Public Libraries***

Speed dialing using a Private Library or system Public Library number is basically the same, therefore the process is described generally for both dialing systems. If Public Speed Dialing is available on your system, consult your company directory for library numbers.

### **To dial a Public or Private Speed dial number:**

1. Lift handset.
2. Dial speed call library number (Private or Public).

Notes:

- 1) In some cases the Speed Dialing number must be followed by a Forced Account code. When Forced Account code is required the distinctive dial tone is heard after dialing the speed call library number.
- 2) Certain speed dialing numbers require that you dial the relevant outside line access code. When required, the dial tone is heard after dialing the Speed call library number.

---

---

## Touch-Tone Dialing (DTMF) for Other Common Carriers (OCC)

Enables you to send DTMF tones using the dial pad over non-DTMF trunks and stations during any call (FlexSet to trunk, FlexSet to FlexSet, 3-Way Conference, Meet-Me Conference, etc.). In this way you can control any device (such as Voice Mail, IVR, start/stop recording a call, etc.) requiring DTMF response.

The party information is displayed on the top line. The digits are displayed on the second line as they are dialed and the corresponding DTMF tones are heard by all parties to the call.

**NOTE!** FlexSets defined with Auto Transfer must use this feature even when sending DTMF tones to DTMF trunks and stations.

ANSWER      party info
DIAL 123456...
↑→ <input type="checkbox"/> OCC

The OCC feature is an on/off toggle switch. Press  once to activate DTMF mode; press again to return to normal mode.

### Activating using soft keys:

1. Press .
2. Dial the required digits.

### Activating using preprogrammed key:

1. Press the preprogrammed **OCC** key.
2. Dial the required digits.

**NOTE!** To learn how to program a key, see [page 162](#). To program an OCC key, use feature code #127.



---

---

## Transfer (Xfer)

You can transfer both internal and external calls to other users within your system or outside it. Transfer routes a call you received to an idle station. It can also link a call you held to other ports. When Auto transfer is defined at a station, dialing a number will automatically transfer that number, thus initial use of **Xfer** or **XFER** is not necessary, although subsequent actions do require pressing **Xfer** (as defined in this manual). This feature is typically utilized by attendants. Remaining procedures are the same as for a regular transfer. A call can be screened or unscreened:

- **Screened Transfer (Consultation Transfer):** You may announce the call before transferring.
- **Unscreened Transfer (Direct transfer, Blind transfer, Unsupervised transfer or Cold transfer):** You may transfer the call without a prior announcement or without notifying the recipient. When the destination is busy, hanging up will cause the system to camp on (external call only) to the busy station.

### Transferring an established call:

1. During a call, press **Xfer** or **XFER**.
2. Dial the third party destination number.
3. Choose one of the following options:
  - Wait for an answer to announce the call and disconnect (screened transfer).

You can now alternate between the two parties and speak privately with one while the other is put on hold by choosing the relevant flashing Exclude Source/Destination soft keys.

- If **Source** is flashing, choose **Source** to speak privately with the first party.
- If **Dest** is flashing, choose **Dest** to speak privately with the second party.
- If neither **Source** nor **Dest** are flashing, choose either **Source** or **Dest** and then converse 3-way.
- If you are in 3-way and you wish to converse privately again with any party; choose either the **Source** or **Dest** and the other party will again be put on hold.
- Press **Xfer** to release the destination (second) party and return to 2-way conversation with the source.
- Choose **FrcRls** to release all parties.
- Choose **3-Way** to establish a 3-way call.

---

---

**OR**

- Disconnect to automatically transfer the call (unscreened transfer).  
If the 3rd party is busy or does not answer, the call will return to you with the relevant BUSY or NO ANSWER message.

NANS	station unanswered #	original #
NO ANSWER	unanswered #	
→	DND	Mute
		FwdA11

***Station does not answer***

SBSY	busy station #	original #
BUSY	busy #	
→	DND	Mute
		FwdA11

***Station is busy***

Answer the return call, then either:

- Ask the calling party if they wish to transfer to another party.
- Hang up.
- Press **CampOn** to automatically camp on to the station from which the call was transferred.

## Transferring a held call:

Use transfer of a held call to connect an incoming call to the held party, such as when you have to locate someone for a caller.

1. Press **Xfer** or **XFER**. While the party is being held, dial a destination number.
2. Press the flashing DSS key associated with the held call.
3. Press **SPKR** or hang up to transfer the call.

---

---

## Transfer: Split Call

Split call allows you to alternate between two other parties, by pressing soft keys defined as Exclude Source and Exclude Destination. The feature also allows 3-way conversation by merely pressing one of the keys, **[Source]** or **[Dest]**, when the bullet next to that key is steadily lit. This feature can be activated in any sequence, any number of times. When you speak privately, with either the Source or Destination, the other party is automatically put on hold.

**Source:** the first party with whom a connection was made.

**Destination:** the second party with whom a connection was made.

The following table allows identifying the progress of split calls when your FlexSet is not equipped with a message display.

Keys		Status
Source	Dest	
On	Flashing	Speaking privately with source (first party)
Flashing	On	Speaking privately with destination (second party)
On	On	3-way conversation

### Activating Split Call on conversation:

1. Press **[Xfer]**.
2. Dial the destination number and wait for an answer.
3. You can now alternate between the two parties and speak privately with one while the other is put on hold by pressing the relevant flashing key.
4. Press the flashing **[Source]** to speak privately with the first party; or  
Press the flashing **[Dest]** to speak privately with the second party; or  
You can press **[3-Way]** or the key with a steadily lit bullet and then converse 3-way.

- 
- 
5. If you wish to converse privately again with any party:  
Press either the **[Source]** or **[Dest]** key and the other party will again be put on hold.
  6. If you wish to release the destination (second) party and return to 2-way conversation with the source, press **[Xfer]**.
  7. If you wish to release all parties press **[FrcRls]**.

---

---

## ***Transfer: Broker/Consultation/3-Way Conference Call***

Your telephone can be set up to use one or all (if your Transfer COS is defined as ALL) of the following three-party transfer functions, as defined by your Transfer COS definition (consult your system administrator for details).

Each action is performed by first pressing **Xfer** (transfer) or **XFER**; however, for stations where Auto Transfer is defined (in the Class of Service), transfer will take place as soon as the required number is dialed. This will take effect only the first time that the transfer takes place. Subsequent actions do require pressing **Xfer** as defined in this manual.

<b>Function</b>	<b>Use to:</b>
<b>Broker Call</b>	This feature allows you to put a call on hold and then converse privately with a third party, while switching between the two calls. The party not in conversation is automatically put on hold and cannot hear any other conversation. See <a href="#">Transfer: Broker on page 195</a> .
<b>Consultation Call</b>	This feature allows you to consult with a third party. While consulting, the original caller will be put on hold. After consultation is complete the two original parties will be reconnected and the consulted party is then released. See <a href="#">Transfer: Consultation on page 196</a> .
<b>3-Way Conference Call</b>	This feature allows you to bring a third party into an ongoing conversation. All three parties can converse in a three party conference. See <a href="#">Transfer: 3-Way Conference on page 196</a> .
<b>Combination of Consultation/ Broker/ 3-Way Conference</b>	This feature allows you to change a conversation from broker to consultation to 3-way conference by pressing <b>Xfer</b> or <b>XFER</b> while in conversation. The first transfer allows you to converse privately with a third party. The second transfer allows you to speak privately with the original party, while the third party is put on hold. The third transfer places you in a 3-way conversation with all parties.

---

---

## Transfer: Broker

During a call, use this feature to connect to a third party while placing the original (source) party on hold. You may continue to switch between the two calls (parties). The party not in conversation is automatically put on hold.

1. During the call, press **Xfer** or **XFER**.
2. Dial the third party dial number.
3. Wait for an answer.

The original party is placed on hold. You may now speak freely with the third party.

4. The following options are now available:
  - Press **Broker** or **Source** or **Dest** to alternate between the calls any number of times. **Source** and **Dest** flash depending on which party you are connected to.
  - Press a non-flashing **Source** or **Dest** soft key for a 3-way call.
  - Press **FrcRls** in order to release all parties and press **SPKR**.
  - Press **SPKR** or hang up in order to allow conversation between the two parties.

**NOTE!** *If you do not succeed in establishing the Brokered call, your Transfer COS definition may not be set to use the Broker Call function. Consult your system administrator for details.*

---

---

## Transfer: Consultation

This feature allows you to consult with a third party while the original caller (or called party) is automatically placed on hold. After the consultation is complete, the two original parties are reconnected and the consulted party is released.

1. During the call, press **Xfer** or **XFER**.
2. Dial the third party dial number.
3. When your call is answered, the original party is placed on hold so that you may converse privately with the second party.
4. After the consultation is concluded, press **Conslt** or **Xfer** to return to the original call and disconnect from the consulted party.

**NOTE!** *If you do not succeed in establishing the Consultation call, your Transfer COS definition may not be set to use the Consultation Call function. Consult your system administrator for details.*

## Transfer: 3-Way Conference

During a call you can use this feature to add another party to the call, creating a 3-way Conference call.

1. During the call, press **Xfer** or **XFER**.
2. Dial the third party dial number.
3. Wait for the third party to answer.
4. Press **3-Way** or **XFER** to connect all 3 parties. If your COS definition is defined as ALL, then you must press **3-Way** again to establish the 3-way call;  
*or*  
Press **FrcRls** to release the third party and to return to the original call (same as consultation call).

---

---

Other options after 3-way call is established:

- Press **Xfer** or **XFER** again to release the third party, and continue conversing with the original party.
- Press the lit **Source** to converse privately with the first (Source) party that you connected to. The third (Destination) party is put on hold while you converse and **Dest** flashes.
- Press the lit **Dest** to converse privately with the second (Destination) party that you connected to. The second (Source) party is put on hold while you converse and **Source** flashes.
- Press the flashing **Dest** or **Source** soft key to switch between the Source and Destination parties.
- Press **3-Way** to reconnect all three parties again.
- Press **FrcRls** to end the call (3-Way or 2-Way).

**NOTE!** *If you do not succeed in establishing a 3-way call, your Transfer COS definition may not be set to use the 3-Way Call function. Consult your system administrator for details.*



---

---

## Wakeup

Use this feature to program your FlexSet to ring at designated times. If you do not answer the call, the FlexSet will ring three more times at one-minute intervals. If you do not answer by the third call, the wakeup call is routed to the attendant and a wakeup report is printed.

Press **WakeUp** to access the Wakeup options.

Page 1

10:50	26 May 2007	Company xyz
	<i>user name</i>	<i>station number</i>
↑→ <b>WakeUp</b>	CnfIns	GpCall

Page 2

WAKEUP 10:00am		
→ New	Next	Cancel

### Entering first Wakeup request:

1. Press **WakeUp**.
2. Enter the time you wish to be called at the ENTER TIME prompt.  
Note that four digits are required for a 12-hr clock: (i.e. 0805 for 8:05)
3. Choose **AM** or **PM**.

**NOTE!** *If you hear a reorder tone, Wakeup is denied at your station (as defined by Class of Service). In order to make use of this feature, request that the attendant activate Wakeup at your station.*

4. To add another Wakeup time, choose **New** and continue as above.
5. To scroll through the Wakeup list, press **Next**.
6. To cancel the selected Wakeup time (displayed on the top line), choose **Cancel**.

---

---

## When Wakeup call rings:

When the FlexSet rings, the WAKE CALL NAME/NUM message appears on the top line indicating that this is a Wakeup call. Press **SPKR** to answer the call. Choose one of the following:

1. Press **Snooze** to have the system recall you later; or
2. Press **SPKR** to cancel the reminder.

---

---

## Whisper Paging

This feature allows an authorized user to break into an ongoing call, without interfering with the call itself, by whispering to one of the conversing parties. A Whisper Tone, in and out, is heard by the side whispered to.

The second party engaged in the original call hears neither tone, nor the whisper, and the whisperer cannot hear the second conversing party. The party whispered to continues to hear the second party, and also hears the whisperer in lowered volume. The party whispered to can reject the whisper page; alternatively, all whisper pages can be automatically rejected by enabling *Do Not Disturb Whisper Page* - [\[Setup\] \[DND-WP\]](#) See [Setup on page 232](#).

This feature can also be activated while in Silent Monitor and then the whisperer can be heard as well as hear the two parties conversing.

Press [\[WhspPg\]](#) to Whisper Page a station.

Page 1

10:50	26 May 2007	Company xyz
	<i>user name</i>	<i>station number</i>
↑→ Park	V-Page	<a href="#">[WhspPg]</a>

Page 2

WHSPR PAGE
*Enter Destination*

## Sending a Whisper Page:

1. Press [\[WhspPg\]](#).
2. Dial a station number.
3. Listen for the whisper tone.
4. Deliver the message and disconnect.

---

---

## NOTES!

- Whisper Page may not be sent to FlexAir handsets (T-402, T-404, T-408, T-304) and IP stations (T207M, T208M, T207S, T208S and FlexSet-IP 280S).
- This feature can be activated while you are silent monitoring the whispered party (see [Silent Monitoring on page 181](#)). Then you can be heard by the whispered party, as well as hear the two conversing parties.
- When you hear the reorder tone and the `DND WHISPER` message appears, the station is protected from receiving whisper paging calls.
- If you hear the reorder tone and the `ON-HOOK BY` message appears, the receiving party has rejected your whisper page.

## Receiving a Whisper Page:

1. Hear the whisper tone.
2. Listen to the whispered message when the tone stops.

**NOTE!** *If the second party hangs up the call while you are in whisper mode, you may continue to converse with the whispering party without the need to reestablish the call. A `RECONNECT (whisperer #/name)` message appears.*

## Rejecting an ongoing Whisper Page:

1. Press `[DND-WP]` upon receiving notice of an incoming whisper page.  
The Whisper Page message disappears. Continue talking privately with the second party.
2. If required, press `[DND-WP]` again to enable your FlexSet to receive other whisper calls.

---

---

## Placing the second party on hold and talking privately to the whisperer:

1. Press the flashing DSS key (pre-programmed with the whisperer dial number) or the flashing second **LOOP** key. The original conversing party is put on hold.
2. Converse with the whisperer.
3. After the whisperer disconnects, you are automatically reconnected to the original conversing party.

**NOTE!** *If you double-press the flashing DSS key (or the second **LOOP** key), this will initiate a 3-way call.*

---

---

## Attendant Features



### ***Available Functions***





The following pages list the Attendant features that are available on your FlexSet. Attendant features are available only when the station is defined as having Attendant station privileges. Not every Attendant feature listed may have been installed in your system, or at your station/extension. Attendant features are dependent on the assigned Class of Service (COS) levels. Check with your system administrator for a list of the specific features installed.

Most attendant features are activated upon other stations. The available features are displayed below. These features are accessed from idle.

10:50	26 May 2007	Company xyz
	<i>user name</i>	<i>station number</i>
↑→ awk	aTrc	aRmSts

## Available Functions

Function Option	Mnemonic	Function Explanation
[Dest]	Destination	Any station, trunk, ACD/UCD Hunt Group, Boss Group and Public Library port defined in the system.
[St#] [St/Rm#]	Station # Station/Room #	Port dial number defined in the Coral system for a telephone line.
[St/Gp#] [StRmGp]	Station/Group # Station/Room/ Station Group	A number of stations linked together (members) for a common function such as ACD/UCD group or Boss Group. A station can be defined as a member of many ACD/UCD groups and/or Boss Groups.
[Trunk#]	Trunk Dial #	Dial Number assigned to a trunk.
[TrkGP#]	Trunk/Group Number	A number of trunks linked together (members) for a common outgoing function.
[FastUp]	Fast Up Scroll	Used to fast scroll forward to the next assigned feature.
[FastDn]	Fast Down Scroll	Used to fast scroll backward to the previous assigned feature.
[Next]	Next	Used to scroll forward port by port through available ports. While scrolling, the port name/number appears on the top line.
		Operates similarly to [Next]. Keeping the  button depressed will scroll forward continuously.
[Prev]	Previous	Used to scroll backward port by port through available ports. While scrolling, the port name/number appears on the top line. Once you reach the first port on the list, this option changes to another option.

Function Option	Mnemonic	Function Explanation
		Operates similarly to <b>[Prev]</b> . Keeping the  button depressed will scroll backward continuously.
	Scrolling	The scroll icon used in this document indicates features for which scroll lists are available, namely the <b>[PortUp]</b> , <b>[PortDn]</b> , <b>[Next]</b> , <b>[Prev]</b> , <b>[FastUp]</b> and <b>[FastDn]</b> soft keys,  and  buttons.
<b>[Cancel]</b>	Cancel	Used to cancel or to deassign a selected feature.
<b>[Set]</b>	Activate	Used to activate or to assign a selected feature.
<b>[Exit]</b>	Exit/Terminate	Same as pressing <b>SPKR</b> . Used to determine the end of the feature programming or to escape from the current operation.



---

---

## Call Forward

The attendant may program stations, boss groups and ACD/UCD groups so that incoming calls ring at various destinations, depending on the state of the terminal (all, busy, no answer, timed).

These features can also be operated directly from a user station when defined by the COS, without attendant involvement.

Calls incoming from an external source only can be forwarded using `[All-E]`, `[Busy-E]`, `[NoAn-E]`, and `[Time-E]`. Additionally, calls from Internal and External sources can be forwarded to different destinations, as described in [Internal/External Call Forwarding on page 70](#).

Possible destinations are *operator, station/group, external number via public and private speed call library, DVMS pre-recorded message, UNA/central bell, group call, or network number (and the station itself for external calls)*.

Attendant Call Forwarding options are accessed by pressing `[aFwd]` from idle state.

Page 1

```
10:50 26 May 2007 Company xyz
      user name  station number
↑→ aRmSts          BG:Fwd          [aFwd]
```

Page 2

```
Attendant: Call Forward
E=External BNA=BusyNoAns
↓→ All          All-E          Busy
```

`[All]` or `[All-E]`

**Forward All.** The attendant may program stations, boss groups and ACD/UCD groups so that incoming calls ring at another destination. The destination can call back or return calls to the source, and the user can still place outgoing calls from their telephone. The Distinctive Dial Tone sounds upon lifting the handset at the user's station.

---

---

**[Busy]** or **[Busy-E]** **Forward Busy.** The attendant may program stations and boss groups so that incoming calls ring at another destination when the originally called station or group is busy.

**[NoAns]** or **[NoAn-E]** **Forward No Answer.** The attendant may program stations and boss groups so that incoming calls ring at another destination when the originally called station or group does not answer within a system-defined number of rings.

**[Time]** or **[Time-E]** **Forward Timed.** The attendant may program stations, boss groups and ACD/UCD Groups so that incoming calls ring at another destination during specified system-defined time periods. *See table on page 68.*

## Operating Attendant Call Forward:

1. Press **[aFwd]**.
2. Choose the required forwarding option (**[All]**, **[All-E]**, **[Busy]**, **[Busy-E]**, **[NoAns]**, **[NoAn-E]**, **[Time]**, **[Time-E]**).
3. Choose **[St/Go#]** and dial the originating station/group number, or scroll between stations/groups using **[GG]**.
4. To set Call Forward, choose **[Dest]** and dial the call forward destination number, OR  
To cancel Call Forward, choose **[Cancel]**.
5. Press **SPKR** or **[Exit]** to exit and save.

---

---

## Canned Messages

The Canned Messages feature is used to set a canned message for other stations. The attendant may set individual stations with any one of 16 canned messages so that internal callers to the station see the message displayed on the second line of their display panel until the call is answered.

Canned Messages can also be set directly from a user station, without attendant involvement (see [page 81](#)).

Canned message texts are pre-programmed by your system administrator. They can be used to indicate the station's status (or any other pertinent information) to the calling party. Contact your system administrator for the list of canned message texts used in your organization. Use the [Table on page 210](#) to list the canned messages available.

**NOTE!** Check with your system administrator whether your Coral system supports the Canned Messages or Room Status feature. If your Coral system supports the Room Status feature (see [page 212](#)), the Canned Message feature is unavailable.

Press `aRmSts` to access the Canned Messages options.

Page 1

10:50	26 May 2007	Company xyz
	<i>user name</i>	<i>station number</i>
↑→ <code>aRmSts</code>	BG:Fwd	aFwd

Page 2

Attendant: Room Status		
↓→ RmSts0	RmSts1	RmSts2

`RmStsx` Canned Message *x* (where *x*= 0 to 15, see [Table on page 210](#)).

---

---

## Operating Canned Messages:

1. Press the required Canned Message soft key. The canned message appears on the top line.
2. Press **[St/Rm#]** and enter the station/room number, or scroll through the list using **[G G]**.
3. Choose **[Set]** to activate, OR  
Choose **[Cancel]** to deactivate or reset.  
The status definition `ASSIGN/DEASSIGN` appears on the top line.
4. Press **SPKR** or **[Exit]** to exit and save.

**NOTE!** *The first canned message that you activated is the one that will appear on the internal caller's display panel. Therefore, to set a new canned message ensure that you cancel all previously set canned messages.*

**Canned Message - Text and Attendant Access Codes**

<b>Canned Message Number</b>	<b>Soft Key</b>	<b>Access Code (Dial Pad#)</b>	<b>Canned Message Text</b>
0	[RmSts0]	7010	
1	[RmSts1]	7011	
2	[RmSts2]	7012	
3	[RmSts3]	7013	
4	[RmSts4]	7014	
5	[RmSts5]	7015	
6	[RmSts6]	7016	
7	[RmSts7]	7017	
8	[RmSts8]	7018	
9	[RmSts9]	7019	
10	[RmSs10]	7020	
11	[RmSs11]	7021	
12	[RmSs12]	7022	
13	[RmSs13]	7023	
14	[RmSs14]	7024	
15	[RmSs15]	7025	

---

---

## Malicious Call Trace

The Attendant may initiate this feature that records the next *x* (a system-defined variable) calls to any station or room. A list of the calls can also be sent to a printer or terminal. Press **[aTrace]** to access the Attendant Malicious Call Trace options.

Page 1

10:50	26 May 2007	Company xyz
<i>user name</i>	<i>station number</i>	
↑→ Trace	<b>[aTrace]</b>	RoomSt

Page 2

Attendant: Call Trace	
→ On/Off	Print

**[On/Off]**

**Malicious Call Trace On/Off** toggles the Malicious Call Trace on or off.

1. Press **[On/Off]**.

**NOTE!** *If the system resources are insufficient for the feature to be available, the message NO TRACE RECORD appears.*

2. Choose **[St/Rm#]** and dial a station/room number, or scroll through the list using **[Page Up]** **[Page Down]**.
3. To start call trace, choose **[Set]**. To stop call trace, choose **[Cancel]**.

**[Print]**

**Malicious Call Trace Print** sends a list of the calls to a terminal or printer. Malicious Call Trace must previously be activated (*see On/Off above*), or the message CALL TRACE OFF will appear and the action will not be completed.

1. Press **[Print]**.
2. Choose **[St/Rm#]** and dial a station/room number, or scroll through the list using **[Next]** and **[Prev]** only.
3. Choose **[Set]** to print. The message CALL TRACE PRINT appears.

---

---

## Room Status

Used to turn the Room Status definition of a station on or off. There are 16 different Room Status definitions for each station. This feature is applicable for Hotel/Motel use. Contact your system administrator for their various definitions. Use the [Table on page 213](#) to write in the various room statuses.

**NOTE!** Check with your system administrator whether your Coral system supports the Room Status or Canned Messages feature. If your Coral system supports the Canned Messages feature (see [page 208](#)), the Room Status feature is unavailable.

Press **[aRmSts]** to access the Room Status options.

Page 1

10:50	26 May 2007	Company xyz
	<i>user name</i>	<i>station number</i>
↑→ <b>[aRmSts]</b>	BG:Fwd	aFwd

Page 2

Attendant: Room Status		
↓→ RmSts0	RmSts1	RmSts2

**[RmStsx]** Room Status *x* (where *x*= 0 to 15, see [Table on page 213](#)).

1. Press the required Room Status soft key. The status definition appears on the top line.
2. Press **[St/Rm#]** and enter the station/room number, or scroll through the list using **[CC]**.
3. Choose **[Set]** to activate, OR  
Choose **[Cancel]** to deactivate or reset.  
The status definition ASSIGN/DEASSIGN appears on the top line.
4. Press **SPKR** or **[Exit]** to exit and save.

---

---

**Room Status - Names and Attendant Access Codes**

<b>Room Status Number</b>	<b>Soft Key</b>	<b>Access Code (Dial Pad#)</b>	<b>Name</b>
0	[RmSts0]	7010	
1	[RmSts1]	7011	
2	[RmSts2]	7012	
3	[RmSts3]	7013	
4	[RmSts4]	7014	
5	[RmSts5]	7015	
6	[RmSts6]	7016	
7	[RmSts7]	7017	
8	[RmSts8]	7018	
9	[RmSts9]	7019	
10	[RmSs10]	7020	
11	[RmSs11]	7021	
12	[RmSs12]	7022	
13	[RmSs13]	7023	
14	[RmSs14]	7024	
15	[RmSs15]	7025	



---

---

## WakeUp

The attendant may program the system to call any room/station at a designated time.

If the user does not answer the initial wakeup call, recall will be attempted three times before the feature cancels (when defined system-wide).

If none of the recall attempts are answered, or the line is busy, or the handset is not on the cradle, then the attendant will receive a call with the NOT WOKEN message on the top line indicating that the wakeup call failed.

station or room #    NOT WOKEN
--------------------------------

Should such a failure occur, it is recommended that the attendant provide an alternate means for waking the guest.

Printouts are possible for: new/cancel, fail, success. The printout type is also defined system-wide.

Press `[aWake]` to access the Attendant WakeUp options.

*Page 1*

10:50	26 May 2007	Company xyz
	<i>user name</i>	<i>station number</i>
↑→ wakeup	<code>[aWake]</code>	CnfIns

*Page 2*

Attendant: WakeUp	
→ Reques	Report

---

---

**Reques**

**WakeUp Request** is used to program a station to ring at a specified time.

## Entering a new Wakeup Request:

1. Press **Reques**.
2. Choose **St/Rm#** and dial the station/room number, or scroll through the list using **⏪ ⏩**.
3. Choose **Set** to enter a new time for the station/room. The **ENTER TIME** message appears on the top line.
4. Dial in the wakeup time.

**NOTE!** Four digits are required for a 12-hr clock: (i.e. 0805 for 8:05).

5. Choose **AM** or **PM**.
6. Press **SPKR** or **Exit** to exit.

## Canceling Wakeup Request:

1. Press **Reques**.
2. Choose **St/Rm#** and dial a station/room number, or scroll through the list using **⏪ ⏩**.
3. Choose **Cancel** to delete the time.
4. Press **SPKR** or **Exit** to exit.

**Report**

**WakeUp Report** is used to print the wakeup requests that were not answered. The report may be sorted by the requested wakeup time, or by the station number, as defined system-wide.

1. Press **Report**.
2. The **WAKEUP REPORT** message appears on the top line of the display.
3. Listen for the confirmation tone. The printer automatically prints the report.

---

---

## Call Charge

The Call Charge feature is used to determine call charges accumulated per station.

Press **Charge** to access the Call Charge options.

Page 1

10:50	26 May 2007	Company xyz
<i>user name</i>	<i>station number</i>	
↑→ <b>Charge</b>	St.Set	Tk.Set

Page 2

Attendant: Call Charge	
→ Report	Reset

**Report** **Call Charge Report.** The Attendant may request the Call Charge printout at any time for a single station/room or for all stations/rooms without resetting the Charge Table content. This feature is useful for informing a hotel guest of current telephone charges.

### Printing for a single station/room:

1. Press **Report**.
2. Choose **St/Rm#** and dial a station/room number, or scroll through the list using **Next** and **Prev**.
3. Choose **Set** to print. The PRINTED message appears on the top line of the display.
4. Press **SPKR** or **Exit** to exit.

### Printing for all stations/rooms:

1. Press **Report**.
2. Choose **Set** to print.

- 
- 
3. Listen for the confirmation tone.

**Reset** **Call Charge Print and Reset** is used to reset the charge table back to zero and print the charges accumulated per station. The attendant may request print and reset for only one station/room or for all stations/rooms. This feature is useful for giving a hotel guest the telephone charges at checkout time.

## Printing and resetting the charge table:

### For a single station/room:

1. Press **Reset** (print with reset).
2. Choose **St/Rm#** and dial a station/room number, or scroll through the list using **Next** and **Prev**.
3. Choose **Set** to reset and print. The PRINTED WITH RESET message appears on the top and middle lines of the display.
4. Press **SPKR** or **Exit** to exit.

### For all stations/rooms:

1. Press **Reset** (print with reset).
2. Scroll to the beginning of the list using **Prev**.
3. Choose **Set** to reset and print.
4. Listen for the confirmation tone.

---

---

## Station Setup Features

The Station Setup Features menu allows an attendant to define stations for specific feature activation. Some of these features operate permanently, or until redefined. Other features operate on a one-time basis; after the feature is activated, it is then cancelled and must be redefined or reactivated in order to operate again.

Press **[St.Set]** to access the Station Setup Features.

Page 1

10:50	26 May 2007	Company xyz
	<i>user name</i>	<i>station number</i>
↑→ Charge	<b>[St.Set]</b>	Tk.Set

Page 2

Station Features – Setup		
↓→ ChkI/O	DND	HotDly

- ◆ **[ChkI/O]** **Check In/Check Out** enables certain activities to be performed automatically (primarily used for rooms/stations). These are: Room Block/Unblock, Charge Print, Canceling Existing Messages and Terminating DND. Additionally, if defined system-wide, Wakeup and Call Forward are cancelled and Charge is reset. In some systems (defined system-wide) this feature can be activated only on idle stations. If an attempt is made to activate the feature on a busy station, the **BUSY** message is displayed.
- ◆ **[DND]** **Do Not Disturb (DND)** is used to activate Do Not Disturb for a station or boss group. A caller to this station will hear a reorder tone, and only a station with DND override is able to call that station.
- ▣ **[HotDly]** **Hot Station Delay** is used to program a telephone to ring another station, automatically connect to a paging device, or automatically dial out *when the handset is taken off-hook, or **SPKR** is pressed, and no digits are dialed within the programmed first digit time-out.* Possible destinations are *operator, station, hunt group,*

---

---

*boss group, keyset voice page, zone group page, page public address, UNA/central bell, outside trunk call, public and private speed dial, pre-recorded DVMS message, group call, and network number.*

**NOTE!** *Hot Station Delay is not applicable for SIP telephones, such as: T207S and T208S.*

- ❑ **HotImm** **Hot Station Immediate** is used to program a telephone to immediately ring another station, automatically connect to a paging device, or automatically dial out *immediately when the handset is taken off-hook, or SPKR is pressed (or upon dialing from T207S and T208S telephones)*. Possible destinations are *operator, station, hunt group, boss group, keyset voice page, zone group page, page public address, UNA/central bell, outside trunk call, public and private speed dial, pre-recorded DVMS message, group call, and network number*.
- ◆ **OrgOnl** **Originating Only** is used to prohibit incoming calls from arriving at a station. In this case the user can only make outgoing calls, but is unable to receive calls. A caller to this station will hear the reorder tone.
- ◆ **Rstrct** **Outgoing Call Restriction** is used to prevent a station from making outgoing trunk calls.
- ◆ **Block** **Station Blocking** is used to temporarily prevent a station from both making and receiving calls. A caller to this station will hear the reorder tone.
- ◆ **TrmOnl** **Terminating Only** is used to prohibit a station from originating any telephone calls (internal or external). When defined as Terminating Only, the user can receive calls, but is unable to make calls.

---

---

## Operating features marked with **◆** (Above):

1. Choose the required feature option ( **ChkI/O**, **DND**, **OrgOnI**, **RstrctI**, **Block**, or **TrmOnI** ).
2. Press **St/Rm#** and dial a station/room number, or scroll through the list using .
3. Choose **Set** to activate (ASSIGN message appears), OR  
Choose **Cancel** to deactivate (DEASSIGN message appears).

**NOTE!** For **ChkI/O**, **Set** activates Check Out and **Cancel** activates Check In.

4. Press **SPKR** or **Exit** to exit.

## Operating features marked with **□** (Above):

1. Choose the required feature option ( **HotDly** or **HotImm** ).
2. Press **St/Rm#** and dial the originating station number, or scroll through the list using .
3. Choose **Dest** and dial the destination number, OR  
Choose **Cancel** to cancel feature.
4. Press **SPKR** or **Exit** to exit.

---

---

## System Features

The System Controls menu allows the attendant to program certain features for system-wide operations.

Press **[System]** to access the System Setup Features.

Page 1

10:50	26 May 2007	Company xyz
	<i>user name</i>	<i>station number</i>
↑→	<b>[System]</b>	

Page 2

System Features - Setup		
↓→	Alarm	ATT-To
		XfrD/N

**[Alarm]**

**Alarm** is used to identify and examine system alarms.

See the *PI & Database Reference Manual* for a detailed list of the alarm codes and their definitions.

1. Press **[Alarm]**.
2. Choose **[Next]** (next alarm) to scroll through the alarm list. The alarm number and its code are listed on the system lines.
3. Make a list of each alarm number to report to the technician.
4. Press **SPKR** or **[Exit]** to exit.



## Alarm message – LED status:

When an **ALARM** DSS key is programmed (default dial number: #1997), the LED status indicates the following conditions:

**Off:** No alarms

**Flashing:** Alarm condition has occurred

**Steady On:** Alarm condition remains but has been examined by the attendant

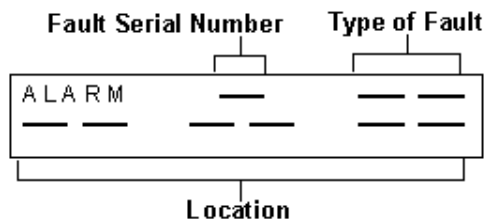

**Table of Alarm Types**

Type of Fault	Description	Action
60	Data Terminal Ready (DTR) not sent.	SMDR printer is malfunctioning and requires service.
61	SMDR backup buffer has reached 75% of its capacity. Only 25% of the number of records defined system-wide can now be accommodated in the space remaining.	The printer requires immediate service or the SMDR records will be lost.
other	—	Call service technician.

---

---

[ATT-To]

**Alternate Attendant Destination.** This feature enables you to program an alternate attendant destination or extension if the console is left unattended. After a time-out period, incoming calls to an unattended console will be re-routed to the selected destination and the attendant console will go into **Unattended** mode (see *Do Not Disturb (DND) on page 95*). Any action that is performed at the original console will force it back to **Attended** mode and the alternate destination back to normal operation.

Possible destinations are *station, hunt group, boss group, UNA/ central bell, pre-recorded DVMS message, public/private speed call, and group call.*

Program an alternate destination in the following way:

1. Press [ATT-To].
2. Dial the destination number where calls are to be forwarded, OR  
Choose [Dest] to change the destination, OR  
Choose [Cancel] to cancel the alternate destination.
3. Listen for the confirmation tone.

[XfrD/N]

**Day/Night Transfer** toggle feature. Press [XfrD/N] to switch from automatic to manual transfer between the various Day/Night service modes and back again. When set to Auto Transfer, a bullet is displayed next to [XfrD/N].

When set to Automatic, the system will transfer service modes without attendant supervision.

When set to Manual, the attendant must decide when to change modes using [Day/N1] and [Day/N2] (see below).

[Day/N1]

**Day/Night 1** toggles between Day (normal mode) and Night 1 service modes. When set to Night 1, a bullet is displayed next to [Day/N1].

[Day/N2]

**Day/Night 2** toggles between Day (normal mode) and Night 2 service modes. When set to Night 2, a bullet is displayed next to [Day/N2].

Use the table below to enter the relevant information concerning Day/Night Transfer. Contact your system administrator for Day/Night Transfer times and destinations.

## Day/Night Transfer Information

Service Mode	Start Time (for automatic transfer)	Incomplete Calls Destination	Intercept Calls Destination	COS Primary/Secondary
DAY				
NIGHT 1				
NIGHT 1				

**PubLib**

**Public Library** is used to program or update the Public Speed Call telephone library.

To update/add/cancel a Public Speed Dial number:

1. Press **PubLib**.
2. Choose **Lib#** and dial the library number, or scroll through the list of library numbers using **⏪ ⏩**.

The Library number/name (e.g. PUBLIC LIB 6000) appears on the top line of the display. The Library contents appear on the second line of the display.

3. Choose **Extrn#** and enter the digits you normally dial to place the external call, including the outside line access code. *Possible outside line access codes: trunk number, trunk group number, dial service, routing access or another public/personal library number and, for special purposes, station/group numbers.*

Special dial codes can be added to the outside dial number (see table [below](#)).

**NOTE!** A new number programmed into an existing library number will erase the old number, but will save the old library name.

4. Alternatively, choose **Cancel** to delete the Library contents.



### **CAUTION!**

When a library number is deleted, its name is also deleted. Names can only be entered by an authorized technician or system administrator.

5. Press **SPKR** or **Exit** to terminate.

---

---

The following table defines the special codes that may be used as part of the outside number.

<b>Codes</b>	<b>Description</b>
*x	Delay dialing by X seconds (x = 1 to 9)
#0	Stop dial (end of outside or network number)
#1	Outpulsing wait period during which user is able to dial any number of digits
#2	All digits following will be Dial Pulse
#3	All digits following will be DTMF
#4	Inhibits display (for Call Accounting System and key set display)
#5	Enables display (for Call Accounting System and key set display)
#6	Wait for second dial tone
#8	Display ' _ ' (for Call Accounting System and key set display)
#9	Calibrated Opening on trunk (FlashTk)
**	Dial * out
##	Dial # out

**NOTE!** *The number of digits that can be programmed, including dial codes, is limited by the Coral (defined system-wide). If you try entering a longer digit string than allowed the system will give the error message `LENGTH EXCEEDED`, and programming will stop.*

---

---

**Time** is used to change the system time and date to reflect the time and date where the Coral system is installed.

### Setting the time:

1. Press **Time**.
2. Dial the time, 4 digits (12 hour clock) use leading zeros, e.g. 0805 for 5 minutes after 8.
3. Choose **AM** or **PM**.
4. Choose **Set**.
5. Listen for the confirmation tone.

### Setting the date:

1. Press **Time**.
2. Choose **Date**.
3. Dial the date, 6 digit format: mm:dd:yy or dd:mm:yy (depending on your system setup). Use leading zeros.  
**For Example:** May 26, 2006 should be entered as *052606* in North America, *260506* in Europe.
4. Choose **Set**.
5. Listen for the confirmation tone.

---

---

## Trunk Setup Features

Trunk Controls allow the attendant to define the operation of system trunks for special use, such as for incoming or outgoing calls only, or for designation of a trunk as reserved for a particular group or specific station.

Press **[Tk.Set]** to access the Trunk Setup Features.

Page 1

10:50	26 May 2007	Company xyz
<i>user name</i>	<i>station number</i>	
↑→ Charge	St.Set	<b>[Tk.Set]</b>

Page 2

Trunk Features - Setup		
→ AutGrd	Block	BsyOut

◆ **[AutGrd]**

**Auto Guard** is used to view which of the trunks have been automatically blocked from use for outgoing calls by the Auto Guard feature. When **ASSIGN** appears in the display the trunk line is blocked. **DEASSIGN** means the trunk line is in use by the system. Auto Guard automatically blocks a trunk when the system detects no dial tone on a trunk.

### When a trunk is Assigned (Blocked):

When a trunk is in **ASSIGN** status (blocked), cancel the Auto Guard as follows:

1. Choose **[AutGrd]**.
2. Choose **[Trunk#]** and dial a trunk number, or scroll through the list using **[CG]**.
3. Choose **[Cancel]** to deactivate (**DEASSIGN** message appears).
4. Choose **[Exit]** or **SPKR** to terminate.

- 
- 
5. Make an external call on the specific trunk. If the call goes through, the line is okay. If the trunk is still blocked, call the technician and reactivate Auto Guard, by following [Steps 1](#) and [2](#) above and choosing `[Set]` to activate (ASSIGN message appears).

◆ `[Block]`      **Central Office (CO) Block** is used to view which of the trunks have been blocked at the central office. When ASSIGN appears in the display the trunk line is blocked for both outgoing and incoming calls. DEASSIGN means the trunk line is in use by the system.

◆ `[LAR]`      **Look Ahead Routing** is used to view the status of trunks/Dial Services that have been automatically blocked from use for outgoing calls. The Coral system automatically blocks a trunk/Dial Service in case of a failure to establish an outgoing connection via that trunk/Dial Service. The LAR Block feature enables an attendant to manually block/unblock the failed trunk/Dial Service.

When ASSIGN appears in the display the trunk/Dial Service line is blocked. DEASSIGN means the trunk/Dial Service line is in use by the system.

After unblocking a trunk/Dial Service, make an external call on the specific trunk/Dial Service. If the call goes through, the trunk/Dial Service is unblocked. If the trunk/Dial Service is still blocked, call the technician and re-activate LAR Block.

If LAR Block activation failed due to insufficient resources (the system ran out of LAR Service Timers), the message NO RESOURCE appears upon dialing activation code.

**NOTE!** *If the trunk/Dial Service was manually blocked, it can only be unblocked manually. Automatic unblock will not work in this case.*

■ `[DIL-X]`      **Direct In Line (DIL)** is used to program incoming CO lines to ring directly at a specific destination depending on the required service mode (Day, Night 1, Night 2), without intervention. Possible destinations are *operator, station, hunt group, boss group, UNA/central bell, public speed call, voice mail, modem, group call, pre-recorded DVMS message, wait queue and network number.*

■ `[DIL-D]`      DIL at Day service period.

■ `[DIL-N1]`      DIL at Night 1 service period.

■ `[DIL-N2]`      DIL at Night 2 service period.

- 
- 
- ◆ **BsyOut** **Busy Out** is used to block any trunk for both incoming and outgoing calls. (This feature may be used to block faulty trunks until the CO service is restored.) When **ASSIGN** appears in the display the trunk line is blocked. **DEASSIGN** means the trunk line is in use by the system.
  - ◆ **DropND** **Drop No Dial** is used to program an outgoing trunk to be dropped when a caller does not dial the first digit within a system-wide time limit. The trunk is then made available to other users.
  - ◆ **HotImm** **Hot Trunk Immediate** is used to program an outgoing trunk so that the trunk automatically and immediately connects to the system.
  - ◆ **HotDly** **Hot Trunk Delay** is used to program an outgoing trunk to automatically connect to the system, after first digit time-out, when no dialing has taken place.
  - ◆ **IncOnl** **Incoming Only** is used to reserve any trunk for incoming calls only, thereby preventing outgoing calls on that trunk.
  - ◆ **OutOnl** **Outgoing Only** is used to reserve any trunk for outgoing calls only. All incoming calls on that trunk will continue ringing with no answer and will not be transferred to any destination.
  - **RsvdTo** **Reserved To** is used to reserve any trunk and trunk group to a specific station or boss group. The reservation will prevent any other stations or boss group stations from making outgoing calls on these trunks.



---

---

## Operating features marked with ◆:

1. Choose the feature soft key ( **AutGrd**, **LAR**, **Block**, **BsyOut**, **DropND**, **HotImm**, **HotDly**, **IncOnl**, **OutOnl** ).
2. Choose **Trunk#** and dial a trunk number, or scroll through the list using .
3. Choose **Set** to activate (ASSIGN message appears), or  
Choose **Cancel** to deactivate (DEASSIGN message appears).
4. Choose **Exit** or **SPKR** to terminate.

## Operating features marked with □:

1. Choose the feature soft key ( **DIL-D**, **DIL-N1**, **DIL-N2**, **RsvdTo** ).
2. Choose **Trunk#** and dial a trunk number, or scroll through the list using .
3. Choose **Dest** and dial the destination number, or  
Choose **Cancel** to cancel feature.
4. Choose **Exit** or **SPKR** to terminate.



---

---

# Setup

## **Overview**

The general features of your FlexSet can quickly and easily be configured using the soft keys. Many of these features will only need to be configured once, however they can easily be reconfigured at any future stage should your requirements change.

The following pages detail the setup and configuration options:

<a href="#">Coral Telephony Features</a> .....	page 233
<a href="#">Zip Tone/Version (FlexSet 120S-Type A / 121S)</a> .....	page 240
<a href="#">Call Log/Zip Tone/Version (FlexSet 120S-Type B)</a> .....	page 241

---

---

## Coral Telephony Features

The Feature Setup menu enables you to adjust the general features of your FlexSet.

Press **[Setup]** to access the Feature Setup options.

Page 1

10:50	26 May 2007	Company xyz
	<i>user name</i>	<i>station number</i>
↑→ COS-Sw	<b>[Setup]</b>	Trace

Page 2

Feature Setup		
↓→ Ring	AutAns	VP-AA

**[Ring]** **Ring Adjustment** allows you to define the sound of your telephone ring. The following can be adjusted:

**[Volume]** **Volume** is used to change the volume of your FlexSet ring.

**[Cadenc]** **Cadence** is used to change the cadence of your FlexSet ring.

**[Type]** **Type** is used to change the type of your FlexSet ring.

You can adjust the ring volume, cadence and type with the  buttons, or by pressing **[Next]** and **[Prev]** (see [Ring Adjustment on page 23](#)).

---

---

[AutAns]

**Auto Answer** activates your phone to answer all incoming calls automatically via the speakerphone after a predetermined number of rings. Press [AutAns] once to activate; press again to deactivate. When activated, a bullet is displayed next to [AutAns].



**CAUTION!**

*Leaving your workstation while Auto Answer is activated will cause your station to answer an incoming call. All conversations in the room can be heard. A trunk call trapped in Auto Answer could lock up the trunk until released by the system.*

[VP-AA]

**Voice Page Auto Answer** activates your phone to answer all incoming Voice Pages automatically via the speakerphone after a predetermined number of rings. Press [VP-AA] once to activate; press again to deactivate. When activated, a bullet is displayed next to [VP-AA].

[VP-Rcv]

**Voice Page Receive** toggles the availability of your station to receive Voice Pages. Press [VP-Rcv] once to activate; press again to deactivate. When activated, a bullet is displayed next to [VP-Rcv].

[ElapTm]

**Elapsed Time Display** toggles the display of the time spent during an incoming or outgoing external or network call. When activated from idle, Elapsed Time makes the duration of a call automatically display whenever the call is established. When activated during a call, Elapsed Time displays duration of the current call.

The elapsed time is shown in HH:MM:SS format up to (13 hours) 12:59:59.

**NOTE!** *The system may be programmed with a limit on the duration of your external calls. Once this limit is reached, the call will be automatically disconnected.*

---

---

### From Idle:

- Press **[Setup]** **[ElapTm]** once to activate; press again to deactivate; a bullet is displayed next to **[ElapTm]** on the Setup screen, and next to **[ElapTm]** that is displayed whilst on a call.

### During a call:

- Press **[ElapTm]** once to activate or deactivate the Elapsed Time display. When the conversation is over, the Elapsed Time feature reverts to the state it was set to before the conversation started.

**[HeadSt]**

**Headset Only.** This feature is designed for users operating in **Headset** mode. When activated, the Headset Only feature causes calls to be conducted via the headset and disables the FlexSet microphone and loudspeaker, along with the features that use these devices (e.g. music, voice page). Calls are conducted via the headset, even if the cradle switch is on-hook.

Press **[HeadSt]** to activate and deactivate the Headset Only feature; when activated, a bullet is displayed next to **[HeadSt]**. See [Headset Only on page 123](#).

**[IdlDsp]**

**Idle Display.** When in **Idle** mode, the first line of the display shows the time, date and site name, and the second line displays your name and station number. Press **[IdlDsp]** to toggle the display of the system lines on/off.

**[Lang.]**

**Language.** Use this feature to set the language for your FlexSet display. The languages available differ according to the country. Scroll using **[Next]** and **[Prev]**, and then press **[Set]** to chose the language.

**[Pascod]**

**Passcode.** Your FlexSet can be defined with a unique passcode known only to you. This passcode allows you (if defined in your COS) to operate certain Coral FlexiCom features such as Phone Lock, Executive Privilege, Auto Set Relocate and COS Switchover. You can define the 4-digit passcode for your FlexSet only at your own FlexSet. Save your passcode in a safe place.

### To define your passcode (when no passcode is currently defined):

1. Press **[Pascod]**.
2. Enter your new passcode number at the prompt.
3. Redial the number to confirm, and listen for the confirmation tone.

---

---

### To change your passcode:

1. Press **[Pascod]**.
2. Enter your old passcode number at the prompt, followed by your new passcode number.
3. Redial the number to confirm, and listen for the confirmation tone.



### **CAUTION!**

*Once a passcode has been defined, the code is known only to you. If you forget the passcode you will not be able to utilize the features that require the code. Therefore, write your passcode number in a secure place for future reference.*

**[ProgKy]**

**Program Key.** The FlexSet comes equipped with 4 system-defined (fixed) keys as well as user programmable keys. You are able to program most of the programmable keys from the FlexSet itself. The programmable keys may be assigned to directly access other stations, station groups, trunks, trunk groups, or system features.

See [Programming: Feature Keys on page 162](#) for instructions on how to program a DSS key.

**[Prefer]**

**Preference** is used to prioritize specific trunk or line connections for your FlexSet. This causes the system to automatically choose the available line, loop or trunk in prioritized order when placing a call (lifting the handset, pressing **SPKR** or dialing a number).

### To view the priorities:

1. Press **[Next]** or the  button to scroll through the list.
2. Listen for the confirmation tone.

### To cancel priorities:

1. Press **[Cancel]** or dial the cancellation code **\*.**
2. Listen for the confirmation tone.

---

---

### To select priorities:

1. Select the required destinations by pressing the programmed DSS keys.

You can program a maximum of six priorities in any order:

- **OUTSIDE Line:** trunk/trunk group/dial service or routing access
- **LOOP** (default access code #121)
- **LOOP Originating Only** (default access code #125)
- **Boss Group Line Key**
- **ELA Line Key**

2. Press **[Set]** or dial the activation code ✓

3. Listen for the confirmation tone.

### NOTES!

- If you intend to select an OUTSIDE line as the first priority, you must program a **LOOP** or **LINE** key to be able to dial internal numbers. When activating a feature, press **LOOP** or **LINE** first, then dial the required number.
- This feature is useful if you make mostly trunk (external) calls. Assign a preference to an outside line(s), and each time you make a call, you will be connected directly to an external trunk.

**[PrvLib]**

**Private Library** is used to program your personal Speed Dial Directory. A Private Library can be used to speed dial long numbers. Also, you can use a Private Library to dial external or network numbers for features that allow only internal destinations such as Call Forward, Divert and Hunt features.

For a full explanation of this feature, see [Speed Dialing: Private Library on page 184](#).

**[Secure]**

**Security Line** is used to block another user from employing the Break In feature on your FlexSet extension. All Call Waiting and Break In feature tones are blocked. When activated, a caller attempting to break in to your station will receive a reorder tone. Only a station that has Security override privilege can break into your secured phone.

Press the **[Secure]** toggle switch to activate, and again to deactivate. A bullet is displayed next to **[Secure]** to indicate when the feature is activated.



---

---

[DND-WP]

**Do Not Disturb - Whisper Page** is used to enable or block your FlexSet from receiving a message whispered by another station. Press [DND-WP] from idle to block or enable your FlexSet from receiving whisper pages, and again to cancel. When this feature is activated, a bullet appears next to [DND-WP].

If you press while on a call, the feature will be active for the duration of the current call only.

**NOTE!** Ensure [DND-WP] is activated to block your phone from receiving a message whispered by another station.

[Privac]

**Privacy.** As a Boss Group member, you can put your FlexSet into **Privacy** mode. This prevents other members of your Boss Group from accidentally joining your conversations. See [Boss Groups: Privacy on page 63](#).

1. To **activate** Privacy, press [Setup] [Privac].  
The message PRIVACY is displayed.  
When this feature is activated, a bullet appears next to [Privac].
2. To **cancel** Privacy, press [Privac] again.  
The message NO PRIVACY is displayed.

[ExHold]

**Exclusive Hold.** As a Boss Group member, you can put your FlexSet into **Exclusive Hold** mode. This ensures that a call placed on hold can be retrieved only at your station. If Exclusive Hold is cancelled, the call put on hold can be retrieved by any other member of your Boss Group.

See [Boss Groups: Exclusive Hold on page 64](#).

1. To **activate** Exclusive Hold, press [Setup] [ExHold].  
The message EXCLUSIVE HOLD is displayed.  
When this feature is activated, a bullet appears next to [ExHold].
2. To **cancel** Exclusive Hold, press [ExHold] again.  
The message NON EXCL. HOLD is displayed.

---

---

MoveSt

**Auto Set Relocate** (move station) allows you to move your station and all your station's predefined features to a new location.

See [Auto Set Relocate on page 58](#).

IRSS

**Individual Remote System Services (IRSS) - Freedom** enables you to connect an off-site non-Coral phone (such as your home phone or mobile) to the Coral and make calls from within the system.

See [Individual Remote System Services \(IRSS\) - Freedom on page 127](#).

---

---

## Zip Tone/Version (FlexSet 120S-Type A / 121S)

The MENU function is used for setting various operating parameters for the FlexSet, as well as general maintenance functions. These options are set with their factory default values. However, you may wish to change the maintenance options to suit your individual needs.

To access the Menu options, press .

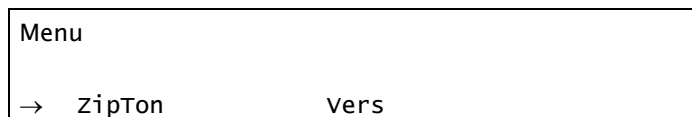

The following options are available from the Menu:

**ZipTon** **Zip Tone** enables you to set the operating ring mode of your FlexSet to **Normal** or **Zip tone**. Zip tone mode is used to sound the ring tones directly through the headset, rather than through the speaker. It is mainly used for attendants using headsets. The factory default is Normal ring (*see page 19*).

- To set your FlexSet to Normal ring, choose **No**.
- To set your FlexSet to Zip tone ring, choose **Yes**.

**Vers** **Version**. Displays the hardware and software version number of the various FlexSet components.

**Vers** FlexSet Version. The current version of the FlexSet, whether it was programmed on the manufacturer site or updated at the customer site.

**Base** Base Version. The original programmed version of the FlexSet, as received from the manufacturer.

---

---

## Call Log/Zip Tone/Version (FlexSet 120S-Type B)

The Tools function is used for setting various operating parameters for the FlexSet, as well as general maintenance functions. These options are set with their factory default values. However, you may wish to change the maintenance options to suit your individual needs.

To access the Tools options, press **MENU** and choose **Tools**, or choose **Setup** **Tools**.

*Page 1*

Menu
↑ Tools

*Page 2*

Tools		
CaLLog	ZipTon	Vers

The following options are available from the Tools menu:

**CaLLog** **Call Log Maintenance** enables the definition of several Call Log options. The Call Log enables users to view the most recent incoming and outgoing call details. See [Call Log on page 71](#).

The following options are available under the Call Log menu:

*Page 3*

Tools - Call Log		
delete	Extern	Intern

---

---

**Delete** enables you to delete outgoing or incoming call records, or both.

**Out** Deletes all outgoing call records.



**In** Deletes all incoming call records.

**Both** Deletes all call records.

**NOTE!** *Ensure that you wish to remove these calls from the Call Log before deleting, as there is no confirmation message.*

**Extern** enables you to set the outside line access code to be dialed when calling numbers from the Call Log. The default external access code is 9.

At the prompt, enter the required outside line access code and choose **Save**.

To delete a digit, select the digit using the   buttons and press \* to delete.

**Intern** enables you to include or exclude internal calls in the log.

- To include internal calls in the log, choose **Yes**.
- To exclude internal calls from the log, choose **No**.

A bullet appears next to **Intern** if internal calls are included.

**Duplic** setting includes or excludes duplicate numbers in the Call Log. A duplicate number is one that has called your station, or that has been called, more than once.

When set to **Yes**, duplicate numbers will be listed separately.

When set to **No**, only the most recent call will be displayed for each logged name/number. In this case, the number of times that they called is displayed in parentheses after the name and number as shown in the diagram above. Once the Call Log has been viewed, this number resets to zero and is hidden.

---

---

**ZipTon**

**Zip Tone** enables you to set the operating ring mode of your FlexSet to **Normal** or **Zip tone**. Zip tone mode is used to sound the ring tones directly through the headset, rather than through the speaker. It is mainly used for attendants using headsets. The factory default is Normal ring (see [page 19](#)).

- To set your FlexSet to Normal ring, choose **No**.
- To set your FlexSet to Zip tone ring, choose **Yes**.

**Vers**

**Version.** Displays the hardware and software version number of the various FlexSet components.

**Vers** FlexSet Version. The current version of the FlexSet, whether it was programmed on the manufacturer site or updated at the customer site.

**Base** Base Version. The original programmed version of the FlexSet, as received from the manufacturer.

---

---

## Appendix A: Glossary

Term	Description
<b>ACD/UCD Group</b>	Automatic Call Distribution and Uniform Call Distribution. Calls enter the system and are automatically routed to the ACD or UCD members based upon system definitions of availability and overflow.
<b>Attendant/Operator</b>	The individual responsible for answering incoming calls and transferring them to their required destinations, as well as attending to trunk, system and station feature controls.
<b>Auto Transfer</b>	When auto transfer is defined at a station, dialing the number to which a call is to be transferred will automatically transfer the call; use of the <b>XFER</b> key is not necessary. This feature is typically utilized by attendants. (See also <a href="#">Transfer/Xfer on page 248.</a> )
<b>Boss Group</b>	A Boss Group is a number of stations operating together in which the individual station may or may not ring simultaneously as defined by the system per Boss Group. The appropriate line key will flash at all stations set to ring at a specific station; the call can be either transferred to any group member or picked up by any group member when not in exclusive hold. Any group member can join a conversation by merely pressing the appropriate illuminated line key. However, only one additional member can join, and this is only when the original group member is not in privacy mode.
<b>Class Of Service (COS)</b>	A Class-of-Service (COS) consists of a list of features that are available to the telephone line user. However, the user may be denied certain features. Each internal telephone is marked with two classes-of-service, Primary and Secondary, which can be defined differently. In order to increase flexibility, the Coral system allows switching between the Primary and Secondary COS, but only one COS can be utilized at a time. When the telephone is in check-out mode, the telephone is marked by a system-wide defined COS and the user is denied this feature.

Term	Description
<b>CO Trunk Number (Incoming)</b>	The number that is dialed by an outside telephone user from the public network (through the Central Office) in order to call into the Coral system for an internal station. (Number listed in the local telephone directory).
<b>Database</b>	The memory in which the 'flexible database system information' is stored. Programming the database is usually carried out during installation, however, it is field- or remotely-modifiable.
<b>Dial</b>	For the purpose of this guide "Dial" means entering the relevant digits by pressing the number on the Dial Pad (Keypad) that operates a feature or sends a call to a destination. Dial also means pressing a key programmed with the feature or destination (DSS).
<b>Disconnect</b>	You may disconnect from an ongoing call by either pressing the Speaker key or by manually replacing the handset onto its cradle (i.e. hang up).
<b>Direct Station Selection (DSS)</b>	Permits you to make or transfer a call to an extension by using a defined key. DSS can also be used on all accessible system ports. Instead of dialing a number this can be done by pressing the programmed key. Also provides busy lamp field for programmed stations.
<b>ELA Group</b>	ELA Group is a number of stations (up to 32) operating together in which the individual stations share a common line appearance. When an ELA-defined line key flashes, it flashes at all the member stations. Any member may answer the call by pressing the flashing line key. If the ELA call is put on hold, the line key flashes at all the member stations and any member (provided the privacy feature is not activated) may break-in to the call by pressing the flashing line key. To place a call, a member may press any available line key; the line key remains lit at all member stations for the duration of the call.
<b>Extension</b>	Each Coral internal telephone is called a station or an extension.
<b>FlexSet 120S Type A</b>	When the FlexSet is controlled by the Coral main processor.



Term	Description
<b>FlexSet 120S Type B</b>	When the FlexSet is controlled by the FlexSet local processor.
<b>Forced Account Code</b>	A feature that forces the station user to dial an account code before having access to an outside line. A display equipped keyset user attempting to access an outside line without dialing the account code will receive the message "ENTER ACCOUNT #" on the display. After dialing the account code, the user will be able to continue dialing the intended number.
<b>Idle</b>	A station or extension that is not ringing or busy, therefore available for use.
<b>Intercept</b>	If you misdial or dial an unauthorized code (restricted to you), you will receive a reorder tone or will be routed directly to the attendant/operator/master extension, as defined in your system.
<b>Off-Hook</b>	Lifting the telephone handset from its cradle has the same effect as pressing a preprogrammed <b>LOOP</b> , <b>LINE</b> or <b>SPKR</b> fixed key, but automatically inhibits the Speakerphone facility. Off- hook provides the dial tone, which then enables you to dial or activate a feature.
<b>LINE</b>	The line key is used for making and receiving calls when the station is defined as a member of a Boss group or an ELA group. When several line keys are in use, the station will act as if it is a multi-line instrument.
<b>LOOP</b>	The loop key is used for making and receiving calls. When several loop keys are in use the station will act as if it is a multi-line instrument.
<b>On-Hook</b>	Replacing the telephone handset on its cradle – has the same effect as pressing the <b>Exit</b> or <b>SPKR</b> key.
<b>Outside Line Access Code</b>	A series of digits which must be dialed or keyed in order to gain access to a trunk or trunk group.

Term	Description
<b>Port</b>	Provides access to a device, station or trunk from within the system.
<b>Recall- Automatic</b>	The call that you have transferred to another extension that is busy or that does not answer, or that you have put on 'hold', which has returned to you after a predetermined time-out period.
<b>Station</b>	Each Coral internal telephone is called a station or an extension.
<b>Station Group</b>	A number of stations linked together (members) for a common function, such as ACD/UCD group or Boss group. A station can be defined as a member of many ACD/UCD groups and/or Boss groups.
<b>System-defined</b>	Ask your system administrator for these values.
<b>Telephony Features</b>	The FlexSet is part of the Coral family of telephones that have access to a rich array of telephony features that are user activated. The features supplied by the Coral system appear in the FlexSet display whenever the FlexSet is engaged.
<b>Time-Out</b>	A predetermined period of time allowed to complete a specific function. If the function is not completed, for example dialing, the caller is dropped and the exchange equipment freed for other users. (See also <a href="#">Recall- Automatic</a> above.)

Term	Description
<b>Transfer/Xfer</b>	While engaged on a call you can initiate a feature by pressing the XFER (Transfer) key. XFER provides you with a distinctive dial tone, which enables you to either transfer the call, or activate a feature. XFER puts the second party on Hold and provides one of the following: music, reorder tone, busy tone or no sound at all, as defined system-wide. If your Coral system is connected to another PABX you may have to use the FLASH key instead of the XFER key. The XFER key is used for local Coral system features, while the FLASH key is used to flash on trunks. In some systems, if you are not connected to a DTMF destination, transfer can be carried out by dialing '1' instead of pressing the XFER key. In some systems transfer is applied automatically when you dial a number. (See also <a href="#">Auto Transfer on page 244.</a> )
<b>Trunk</b>	An outside line from the telephone company that terminates at the customer's location.
<b>Trunk Group</b>	A number of trunks linked together (members) for a common outgoing function.
<b>Trunk Number</b>	The access code number that is dialed or keyed by station user in order to gain access to a specific outside line.
<b>Verified Forced Account Code (VFAC)</b>	A feature that forces the station user to dial a secret authorization account code before accessing an outside line. Before dialing is allowed, VFAC verifies the presence of the account code. If the code is not present, dialing is blocked. When the code is found, dialing is allowed. Except for verification, VFAC is the same as Forced Account Code.

---

---

## Appendix B: Tones

Tones are audible signals of various frequencies that give information about the status of calls and features. While using the Coral system, many different tones will be heard. These tones may vary for different locations, as each system is customized during installation. While the sounds of the tones themselves are not described, their general use is discussed below. In order to familiarize yourself with these tones, try accessing various features and listen to the resultant tone signals. The most frequently heard tones are:

Tone	Description
<b>Break-In/Break-Out Tone</b>	A warning tone received by a station user indicating that a third party has broken into, or is leaving (breaking out) an existing conversation.
<b>Break-In Warning</b>	Tone heard during the entire break-in period. Indicates that a third party is listening (not used in North America).
<b>Busy Tone</b>	Tone heard when the destination you have dialed (extension or trunk) is busy.
<b>Call Waiting Tone</b>	Tone heard at your station while engaged on a call or activating a feature indicating that another call is waiting to be answered (this appears only when multi-appearance is defined for your station).
<b>Confirmation Tone</b>	Tone heard indicating that the telephony feature has been activated or deactivated.
<b>Dial Tone</b>	Tone heard after off-hooking (lifting) your handset from idle.

Tone	Description
<b>Distinctive Dial Tone</b>	<p>This tone indicates that certain features are in use at your FlexSet, for example, when you have programmed your FlexSet not to receive calls with either Call Forward All, or Do Not Disturb, and you lift the handset. DDT is also heard between patterns of digits when dialing certain features, for example, Account Code feature. When the following features are applied at your telephone, the distinctive dial tone is heard when the handset is lifted:</p> <ul style="list-style-type: none"> <li>• Call Forward All</li> <li>• Call Forward All External</li> <li>• Do Not Disturb</li> <li>• Messages Waiting</li> <li>• Secondary COS</li> </ul>
<b>Key Click</b>	<p>When defined for the FlexSet, a tone heard when pressing any button on the dial pad.</p>
<b>Reorder Tone</b>	<p>You hear this tone at your FlexSet if:</p> <ul style="list-style-type: none"> <li>• You try to access a denied feature or misdial</li> <li>• You have stayed off-hook for too long before dialing</li> <li>• The station you have called does not answer within the predetermined interval</li> <li>• The station you have called is in Do Not Disturb status</li> </ul>
<b>Ringback Tone</b>	<p>Tone is heard when the destination you have dialed is ringing.</p>
<b>Second Ringback Tone</b>	<p>Tone that the calling party hears indicating that the called party is currently busy. When the called party disconnects, the waiting call will be the next one ringing to the destination.</p>

Tone	Description
<b>Speaker Status Tone</b>	Indicates that the second conversing party's keyset is in speakerphone mode. Enables you to keep your privacy when you call someone who answered the call or placed the call back to the speaker, and there are other people in the phone environment.
<b>Tick Tone</b>	A tone indicating that you may continue dialing.
<b>VIP Ring Tone</b>	A warbling tone heard when receiving a call from a station designated as VIP. Enables you to identify an incoming call as a high priority call.
<b>Voice Paging Tone</b>	A warbling tone heard when using the paging facility.
<b>Whisper Tone</b>	<p>Tone heard during a conversation indicating that a Whisper Page is about to be received from a third party. The second (conversing) party does not hear the tone.</p> <p><b>NOTE!</b> Ensure <code>[DND-WP]</code> is activated to block your phone from receiving a message whispered by another station.</p>

---

---

## Appendix C: LED Indications (Programmable Keys)

LED indications visually show the state of certain features. LEDs typically indicate that a feature is either activated (steady on) or is pending further commands or needs additional information (flashing). The LED indications usually go hand-in-hand with various messages when equipped with a display.

LED Indications	Description
<b>Off</b>	Indicates that the feature is inactive or the DSS destination is idle.
<b>Wink</b>	A signal that flashes at a fast rate of 120 pulses per minute (400/100mS). Typically indicates that a call is on hold or park, normally the telephone does not ring.
<b>Flashing</b>	A signal that flashes at a slow rate of 60 pulses per minute (800/200mS). Typically indicates that a call is pending, in most cases the station will also ring.
<b>Steady On</b>	Indicates that a feature programmed on that key is active. When defined as DSS, indicates that the port designated by this key is in use. When defined as a loop, line or speaker indicates that a call is in progress.
<b>Message Lamp</b>	Dedicated LED for message waiting indication. The message lamp may be enabled or disabled system-wide. The lamp does not interfere with a programmed MSG key.

**NOTE!** *In special cases the key may operate differently. See the relevant feature for explanations of various messages that can appear.*

---

---

## Appendix D: ISDN Cause Numbers

Cause #	CODE MEANING	ACTION
0	valid cause code not yet received	
1	unallocated (unassigned) number	check number and call again*
2	no route to specified transit network	notify system administrator
3	no route to destination	notify system administrator
4	send special information tone	
5	misdialed trunk prefix	
6	channel unacceptable	notify system administrator*
7	call awarded and being delivered in an established channel	no action
8	prefix 0 dialed but not allowed	
9	prefix 1 dialed but not allowed	
10	prefix 1 dialed but not required	
11	more digits received than allowed	
16	normal clearing (message displayed as text)	no action*
17	user busy (message displayed as text)	call later
18	no user responding	call later



<b>Cause #</b>	<b>CODE MEANING</b>	<b>ACTION</b>
19	no answer from user (user alerted)	call later
21	call rejected	call later
22	number changed	check number and call again*
23	reverse charging rejected	
24	call suspended	
25	call resumed	
26	non-selecting user clearing	
27	destination out of order	call later
28	invalid format (address incomplete)	check number and call again*
29	facility rejected	notify system administrator
30	response to status inquiry	
31	normal unspecified	no action*
33	circuit out of order	
34	no circuit/channel available	call later*
35	destination unattainable	
37	degraded service	
38	network out of order	wait and call later
39	transit delay range cannot be achieved	

<b>Cause #</b>	<b>CODE MEANING</b>	<b>ACTION</b>
40	throughput range cannot be achieved	
41	temporary failure	call later*
42	switching equipment congestion	call later
43	access information discarded	no action*
44	requested circuit/channel not available	notify system administrator
45	preempted	
46	precedence call blocked	
47	resource unavailable, unspecified	notify system administrator
49	quality of service not available	notify system administrator
50	requested facility not subscribed	notify system administrator
51	reverse charging not allowed	
52	outgoing calls barred	
53	outgoing calls barred within GUG	
54	incoming calls barred	
55	incoming calls barred within GUG	
56	call waiting not subscribed	
57	bearer capability not authorized	notify system administrator
58	bearer capability not presently available	call later

<b>Cause #</b>	<b>CODE MEANING</b>	<b>ACTION</b>
63	service or option not available, unspecified	notify system administrator
65	bearer capability not implemented	check destination is correct, try again from different compatible terminal, notify system administrator if message returns
66	channel type not implemented	notify system administrator
67	transit network selection not implemented	
68	message not implemented	
69	requested facility not implemented	notify system administrator
70	only restricted digital information bearer capability is available	notify system administrator
79	service or option not implemented, unspecified	notify system administrator
81	invalid call reference value	notify system administrator
82	channel does not exist	
83	a suspended call exists, but this call identity does not	no action*
84	call identity in use	no action*
85	no call suspended	no action*
86	call having the requested call identity has been cleared	no action*
87	called user not member of GUG	

<b>Cause #</b>	<b>CODE MEANING</b>	<b>ACTION</b>
88	incompatible destination	check destination is correct, try again from different compatible terminal, notify system administrator if message returns
89	non-existent abbreviated address	
90	destination address missing, and direct call not subscribed	
91	invalid transit network selection	notify system administrator
92	invalid facility parameter	
95	invalid message, unspecified	notify system administrator
93	mandatory information element is missing	notify system administrator
95	invalid message, unspecified	notify system administrator
97	message type non-existent or not implemented	notify system administrator
98	message not compatible with call state or messages type non-existent or not implemented	notify system administrator
99	information element non-existent or not implemented	notify system administrator
100	invalid information element contents	notify system administrator
101	message not compatible with call state	notify system administrator
102	recovery on timer expiry	no action*
103	mandatory information element length error	

---



---

Cause #	CODE MEANING	ACTION
111	protocol error, unspecified	notify system administrator
112	type of protocol not available	
113	ISUP not available	
127	interworking, unspecified	notify system administrator

\* If the message returns frequently, notify your system administrator

---

---

## Index: Soft Keys and Feature Codes

This appendix details the rich array of options available on your phone. Features are accessed by use of the context-sensitive soft keys. The features can also be operated by using their dial codes, so that they may be programmed into the programmable keys.

### Soft Key

These are the soft key options that appear on the bottom line of the display area of your phone. This column is arranged in alphabetical order. In situations where there are two or three features, one standard, one attendant, and one boss group:

- The attendant feature takes the format **aXXXXX**  
(for example, **Trace** and **aTrace**, where **Trace** is the standard feature and **aTrace** is the attendant feature).
- The boss group feature takes the format **BG:XXX**.  
(for example, **Fwd** and **BG:Fwd**, where **Fwd** is the standard feature and **BG:Fwd** is the boss group feature).

### Source

This is the route taken using the soft keys to reach this soft key message.

- **Feat** corresponds to the idle state (or FlexSet 120S type B: **MENU** > **Feat**)
- **Call** corresponds to the FlexSet state during a call (ongoing, ringing, etc.).

### Feature Code

The feature code is the default code (numbering plan) that is used to operate the relevant feature using the dial pad. The feature code can be used to pre-program the FlexSet DSS buttons with the specific feature.

When the soft key links to a sub-menu (e.g. pressing **Fwd** opens a list of forwarding options), “MENU” is used to show that this is a multilevel menu.

For more detailed information on how to use the feature codes and how to program them, refer to the *Coral FlexSet 280, 280D, 280D-Z, 120, 120D and 120L User Guide*, or the *Attendant Console User’s Guide*. See [page 162](#) for instructions on how to program a feature into a programmable key by using its feature code.

## Soft Key Reference

The following table lists details of each soft key and location of the feature in this manual.

### Soft Key Information

Soft Key	Source	Default Feature Code	What it Means	Reference
[1stsec] - [9thsec]	Setup>PrvLib>Pause	Ⓣ1 - Ⓣ9	Private Library (#193) – Delay 1-9 Seconds	<a href="#">page 184</a>
[3-Way]	Call	#122	Xfer: when COS is defined for 3-Way Conference Call	<a href="#">page 196</a>
[AcctCd]	Feat, Call	#1990	Account Code	<a href="#">page 51</a>
[ACDBsy]	AcidUcd	#1746	Used by the Attendant to define Max Calls Waiting for Busy ACD Group	<a href="#">page 53</a>
[AcidUcd]	Feat	MENU	ACD & UCD Hunt Groups: [CallWt] [LoadD] [LogI/O] [PrmLog] [RisRsm] [RisUCD] [WrapTm] [WrapCd] [ACDBsy]	<a href="#">page 53</a>
[Add]	Redial>AutRdl	#178	Auto Redial - Add number to the list	<a href="#">page 173</a>
[AddOn]	GpCall	#1449	Group call Temporary (Add on) Group Call	<a href="#">page 115</a>
[AddPrt]	GpCall, AddOn	#1449	Add Participant to Group Call	<a href="#">page 115</a>
[aFwd]	Feat	MENU	Attendant: Call Forward: [All] [All-E] [Busy] [Busy-E] [NoAns] [NoAn-E] [Time] [Time-E]	<a href="#">page 206</a>
[Alarm]	System	#1997	Alarm Display	<a href="#">page 221</a>

Soft Key	Source	Default Feature Code	What it Means	Reference
[All]	BG:Fwd	#168	Boss Group Call Forward All	<a href="#">page 65</a>
[All]	aFwd	#168	Attendant Call Forward All	<a href="#">page 206</a>
[All]	FlexiC	#17710	FlexiCall remote destination for ALL calls	<a href="#">page 105</a>
[All-E]	Fwd	#17702	Call forward all for External calls	<a href="#">page 67</a>
[All-E]	BG:Fwd	#17707	Boss Group - Call forward all for External calls	<a href="#">page 65</a>
[All-E]	aFwd	#17707	Attendant - Call Forward All for External calls	<a href="#">page 206</a>
[All-St]	Charge>Reset	#1978	Attendant – Charge, Reset for all stations	<a href="#">page 217</a>
[AM]	Remind, WakeUp, System>Time, aWake	2	Used to set time to AM (between midnight and noon)	<a href="#">page 226</a>
[aRmSts]	Feat	MENU	Attendant Room Status options: [RmSts0] [RmSts1].....[RmSts14] [RmSts15]	<a href="#">page 206</a>
[aTrace]	Feat	MENU	Attendant: Call Trace: [On/Off] [Print]	<a href="#">page 211</a>
[ATT-To]	System	#146	Alternate Attendant Destination	<a href="#">page 221</a>
[AutAns]	Setup	#138	Auto Answer (on/off)	<a href="#">page 232</a>
[AutGrd]	Tk.Set	#1998	Trunk AUTO GUARD	<a href="#">page 227</a>
[AutRdl]	Redial, Call	#178	Auto Redial: when calling a trunk & from idle. Charge options: [Next] [CanAll] [FrzAll] [RstAll] [Add]	<a href="#">page 173</a>
[aWake]	Feat	MENU	Attendant Wake Up options: [Reques] [Report]	<a href="#">page 214</a>



Soft Key	Source	Default Feature Code	What it Means	Reference
[BckSpC]	Dir	#3	Directory (##, #1994) Personal – (Backspace) Erase the last entered character	<a href="#">page 92</a>
[BG:Fwd]	Feat	MENU	Boss Group Call Forwarding options: [All] [All-E] [Busy] [Busy-E] [NA] [NoAn-E] [Time] [Time-E]	<a href="#">page 65</a>
[Block]	St.Set	#153	Station Blocking	<a href="#">page 218</a>
[Block]	Tk.Set	#157	Trunk CO Blocked Display	<a href="#">page 227</a>
[BNA]	Fwd	#147	Call Forward Busy/No Answer	<a href="#">page 67</a>
[BNA-E]	Fwd	#17705	Call Forward Busy/No Answer for External calls	<a href="#">page 67</a>
[Both]	(MENU) >Tools> CALLog>Delete		FlexSet Type B only. Delete BOTH incoming and outgoing calls	<a href="#">page 241</a>
[Brk-In]	Call	#124, hf-3	Break-In	<a href="#">page 32</a>
[Brk-In]	Call	#124, hf-3	Do Not Disturb Override	<a href="#">page 95</a>
[Broker]	Call	#122	Xfer: when COS=Broker Call	<a href="#">page 195</a>
[BsyOut]	Tk.Set	#155	Trunk Busy Out	<a href="#">page 227</a>
[Busy]	Fwd	#140	Call Forward Busy	<a href="#">page 67</a>
[Busy]	BG:Fwd	#167	Boss Group Call Forward Busy	<a href="#">page 65</a>
[Busy]	aFwd	#167	Attendant Call Forward Busy	<a href="#">page 206</a>

Soft Key	Source	Default Feature Code	What it Means	Reference
[Busy-E]	Fwd	#17701	Call Forward Busy for External calls	<a href="#">page 67</a>
[Busy-E]	BG:Fwd	#17706	Boss Group Call Forward Busy for External calls	<a href="#">page 65</a>
[Busy-E]	aFwd	#17706	Attendant Call Forward Busy for External calls	<a href="#">page 206</a>
[Cadenc]	Setup>Ring	#136	Ring Adjustment - Adjust Ring Cadence	<a href="#">page 232</a>
[Call]	Msg>Msg.	#175	Message - Call Back	<a href="#">page 138</a>
[CALLog]	Feat, Tools	N/A	Call log	<a href="#">page 71</a>
[CALLog]			Call log	<a href="#">page 71</a>
[CallWt]	Call	#1325	Number of Calls Waiting Display	<a href="#">page 53</a>
[CallWt]	AcdUcd	#1982	ACD: Calls Waiting Display	<a href="#">page 53</a>
[CampOn]	Feat	#176	Camp-On/Call-Back	<a href="#">page 78</a>
[CampOn]	Call	#176, hf-2	CampOn/Call-Back (appears when calling a port)	<a href="#">page 78</a>
[CanAll]	Redial>AutRdl	#178	Auto Redial - Cancel All numbers	<a href="#">page 173</a>
[Cancel]		#10, #*0	Cancel	<a href="#">page 80</a>
[CanPri]	Redial>AutRdl	#*9	Auto Redial (#178) - Cancel Priority	<a href="#">page 173</a>
[Change]	AcdUcd>ACDBsy	#11, #*1	Max Calls Waiting for Busy ACD Group (#1746)	<a href="#">page 53</a>



Soft Key	Source	Default Feature Code	What it Means	Reference
[Char]	Dir	N/A	Directory (##, #1994) Personal – Toggle between digits and characters	<a href="#">page 92</a>
[Charge]	Feat	MENU	Attendant Call Charge options: [Report] [Reset]	<a href="#">page 216</a>
[Chkl/O]	St.Set	#1970	Station Check In/Out	<a href="#">page 218</a>
[Cnflns]	Feat	#1983	CONFERENCE Inspect/Release Single Participant	<a href="#">page 86</a>
[Cnflck]	Call	#1441	CONFERENCE Lock (during conference)	<a href="#">page 85</a>
[Codes]	Setup>PrvLib	MENU	MENU for Special Dial Codes, in Private Library (#193): [Final] [FreeDl] [Pulse] [Tone] [DspOff] [DspOn] [WaitDT] [Dsp -] [FlshTK] [Dial *] [Dial #]	<a href="#">page 184</a>
[Conslt]	Call	#122	Xfer: when COS is defined as Consultation Call	<a href="#">page 196</a>
[COS-Sw]	Feat	#149	COS Switchover	<a href="#">page 87</a>
[Date]	System>Time	#188	Time Date – Set Date	<a href="#">page 221</a>
[Day/N1]	System	#185	Day/Night1 - Service Mode Select	<a href="#">page 221</a>
[Day/N2]	System	#184	Day/Night2 - Service Mode Select	<a href="#">page 221</a>
[Delete]	CALog		Delete call records	<a href="#">page 71</a>
[DelPrt]	GpCall, AddOn	#1449	Delete Participant from Group Call	<a href="#">page 115</a>
[Dest]	Call	#1322	Exclude Destination (Split Call)	<a href="#">page 192</a>
[Dest]	Pickup	#180, 77	Call Pickup Directed (Destination)	<a href="#">page 74</a>
[Dest]	Msg>Msg.	#175	Message - Leave A Message at another destination	<a href="#">page 135</a>

Soft Key	Source	Default Feature Code	What it Means	Reference
[Dial #]	Setup>PrvLib>Codes	##	Private Library (#193) – Dial # Out	<a href="#">page 184</a>
[Dial *]	Setup>PrvLib>Codes	**	Private Library (#193) – Dial * Out	<a href="#">page 184</a>
[Dial]	Msg>Msg.	#175	Message - Call Back	<a href="#">page 138</a>
[Dial]	CALLog>In CALLog>Out	N/A	Call log - Call Back (dial the selected entry from the call log)	<a href="#">page 71</a>
[Dial]	Dir	*	Directory (##, #1994) – Place a call to the displayed contact	<a href="#">page 92</a>
[Dial]	CALLog	N/A	Used to dial the recognized number	<a href="#">page 71</a>
[Digit]	Dir	##, #1994	Directory (##, #1994) Personal – Toggle between characters and digits	<a href="#">page 92</a>
[DIL-D]	Tk.Set	#164	Trunk Direct In Line at DAY service	<a href="#">page 227</a>
[DIL-N1]	Tk.Set	#163	Trunk Direct In Line at Night1 service	<a href="#">page 227</a>
[DIL-N2]	Tk.Set	#165	Trunk Direct In Line at Night2 service	<a href="#">page 227</a>
[Dir]	Dir	#9	Directory (##, #1994) – Access the personal directory subset only	<a href="#">page 92</a>
[Dir]	Feat	#1994	Directory phones	<a href="#">page 88</a>
[Direct]	Pickup	#180, 77	Call Pickup Directed (Destination)	<a href="#">page 74</a>
[DND]	Feat	#145	Do Not Disturb (or Attended / Unattended for Attendant)	<a href="#">page 95</a>
[DND]	St.Set	#1999	Station Do-Not-Disturb	<a href="#">page 218</a>

Soft Key	Source	Default Feature Code	What it Means	Reference
[DNDOvr]	Call	#124, hf-3	Do Not Disturb Override	<a href="#">page 95</a>
[DND-WP]	Setup	#1745	Whisper Page, (DND) Receiving (on/off)	<a href="#">page 232</a>
[DropND]	Tk.Set	#162	Trunk Drop On No Dial	<a href="#">page 227</a>
[Dsp -]	Setup>PrvLib>Codes	#8	Private Library (#193) – Display '-'	<a href="#">page 184</a>
[DspOff]	Setup>PrvLib>Codes	#4	Private Library (#193) – Inhibit Display	<a href="#">page 184</a>
[DspOn]	Setup>PrvLib>Codes	#5	Private Library (#193) – Enable Display	<a href="#">page 184</a>
[Duplic]	(MENU) >Tools >CALLog		Record the same ID number at all call appearances (Duplic=Yes) or only the last call appearance (Duplic=No)? (Relevant for FlexSet 120S-Type B)	<a href="#">page 241</a>
[Edit]	Dir	#2	Directory (##, #1994) Personal – Edit the displayed entry [BckSpC] [Space] [LoCase] [UpCase] [Digit] [Number] [Save] [Dial] [Exit]	<a href="#">page 92</a>
[ElapTm]	Setup, Call	#129	Call Elapsed Time Display (on/off)	<a href="#">page 232</a>
[Enable]	Redial>AutRdl	#178	Auto Redial - Activate	<a href="#">page 173</a>
[Esc]	CALLog	N/A	Escape (Terminate or Release)	<a href="#">page 71</a>
[Exec]	Feat	#170	Executive Privilege	<a href="#">page 104</a>
[ExHold]	Setup	#187	Boss Group: Exclusive Hold (on/off)	<a href="#">page 232</a>
[Exit]		N/A	Terminate or Release	

Soft Key	Source	Default Feature Code	What it Means	Reference
[Exit]	Cnflns	#1983	Conference View/Release – Exit	<a href="#">page 86</a>
[Extern]	(MENU) >Tools >CALLog		Outside line access code needed to access external trunks from CALL Log records. (Irrelevant for FlexSet 121S/281S)	<a href="#">page 241</a>
[Extern]	FlexiC	#17711	FlexiCall remote destination for External calls	<a href="#">page 105</a>
[Extrn#]	Setup>PrvLib	(#193)	Private Library – used to enter Outside Line Access Code followed by External Phone #	<a href="#">page 184</a>
[FastDn]	Tk.Set, St.Set	##5	Scroll Fast Backward (Rapidly goes backward to the previously assigned feature in a scroll list)	<a href="#">page 237</a>
[FastUp]	Tk.Set, St.Set	##3	Scroll Fast Forward (Advances rapidly to the next assigned feature in a scroll list)	<a href="#">page 237</a>
[Feat]	(MENU)		“Feature” used to reach Feature options, as shown during idle state. (Irrelevant for FlexSet 121S/281S)	<a href="#">page 42</a>
[Final]	Setup>PrvLib>Codes	#0	Private Library (#193) – End of number / Stop Dial	<a href="#">page 184</a>
[FlexiC]	Feat	MENU	FlexiCall Remote Destination options: [All] [Extern] [Intern]	<a href="#">page 105</a>
[Flw-E]	Fwd	#17713	Follow me for External calls	<a href="#">page 67</a>
[FlwMe]	Fwd	#189	Follow Me	<a href="#">page 67</a>
[FlshTk]	Call	#150	Flash On Trunk (Calibrated Opening)	<a href="#">page 38</a>
[FlshTk]	Setup>PrvLib>Codes	#9	Private Library (#193) – Flash On Trunk (Calibrated Opening)	<a href="#">page 184</a>

Soft Key	Source	Default Feature Code	What it Means	Reference
[FrcRls]	Call	#123	Forced Release	<a href="#">page 32</a>
[FrcRls]	Cnflns	#11, #*1	Conference View/Release (#1983) - Forced Release a selected Participant	<a href="#">page 83</a>
[FreeDI]	Setup>PrvLib>Codes	#1	Private Library (#193) – Outpulsing Wait Period for Free Dialing	<a href="#">page 184</a>
[Freeze]	Redial>AutRdl	#*6	Auto Redial (#178) - Freeze (Hold Set for specific number)	<a href="#">page 173</a>
[FrzAll]	Redial>AutRdl	#*6	Auto Redial (#178) - Freeze All (Hold Set for all numbers)	<a href="#">page 173</a>
[Fwd]	Feat	MENU	Call Forwarding options: [FwdAll] [All-E] [Busy] [Busy-E] [NoAns] [NoAn-E] [BNA] [BNA-E] [Time] [Time-E] [FlwMe] [Flw-E]	<a href="#">page 67</a>
[FwdAll]	Fwd, Call	#141	Call Forward All: when phone rings OR from idle	<a href="#">page 67</a>
[GpCall]	Feat	MENU	Group Call Conference options: [PrtRel] [GrpRel] [AddOn]	<a href="#">page 111</a>
[Group]	Pickup	#181, 76	Call Pickup Group	<a href="#">page 74</a>
[GrpRel]	GpCall	#1447	Group Call. Release the entire group	<a href="#">page 122</a>
[HeadSt]	Setup	#1302	Head Set Only (on/off)	<a href="#">page 232</a>
[Hold]	Feat, Call	#171	Call Hold	<a href="#">page 126</a>
[HotDly]	Tk.Set	#161	Trunk Hot Delayed	<a href="#">page 227</a>
[HotDly]	St.Set	#182	Station Hot Delay	<a href="#">page 218</a>
[HotImm]	Tk.Set	#160	Trunk Hot Immediate	<a href="#">page 227</a>

Soft Key	Source	Default Feature Code	What it Means	Reference
[HotImm]	Tk.Set	#166	Station Hot Immediate	<a href="#">page 218</a>
[IdCtrl]	Feat	#1444	Caller ID Control	<a href="#">page 75</a>
[IdIDsp]	Setup	#137	Idle Display (on/off)	<a href="#">page 232</a>
[ImDial]	Redial>AutRdl	#11, #*1	Auto Redial (#178) - Immediate Dial	<a href="#">page 173</a>
[In]	CALLog	N/A	Incoming received calls	<a href="#">page 71</a>
[IncOnl]	Tk.Set	#158	Trunk Incoming Only	<a href="#">page 227</a>
[Intern]	FlexiC	#17712	FlexiCall remote destination for Internal calls	<a href="#">page 105</a>
[Extern]	 >Tools>CALL		Outside line access code needed to access external trunks from CALL Log records. (Irrelevant for FlexSet 121S/281S)	<a href="#">page 241</a>
[Intern]	 >Tools>CALLog		Whether INTERNAL calls are saved (external calls are always saved)	<a href="#">page 241</a>
[IRSS]	Setup	#17714	Destination for IRSS (Individual Remote System Services)	<a href="#">page 232</a>
[Lang]	Setup	#1328	“Language” Multilingual Display	<a href="#">page 232</a>
[LAR]	Tk.Set	#1979	Look Ahead Routing – Block	<a href="#">page 227</a>
[Last#]	Redial	#143, *	Last Number Redial	<a href="#">page 173</a>
[Lib#]	System>PubLib	#194	Public Library – Library Number#	<a href="#">page 221</a>
[Lib#]	Setup>PrvLib	#193	Private Library – Used to enter specific Private Library number#	<a href="#">page 184</a>



Soft Key	Source	Default Feature Code	What it Means	Reference
[Line]	Call	#126	Line for Boss Group Programmed key (Line # + Boss Group#)	<a href="#">page 61</a>
[LoadID]	AcdUcd	#1973	ACD: Load ID	<a href="#">page 53</a>
[LoCase]	Dir	N/A	Directory (##, #1994) Personal – Toggle between uppercase and lowercase characters	<a href="#">page 92</a>
[Lock]	Feat	#148	Phone Dial Lock	<a href="#">page 161</a>
[LogI/O]	AcdUcd	#1974	ACD: Log-In/Out	<a href="#">page 53</a>
[LveMsg]	Msg>Msg.	#175	Message - Leave A Message at another destination	<a href="#">page 135</a>
[MoveSt]	Setup,	N/A	Move Station: Auto Set Relocate or Terminal Portability (Default feature code Not Available)	<a href="#">page 58</a>
[Msg.]	Feat>Msg, Call	#175, #5, hf-5	Message (when calling a station or from idle)	<a href="#">page 135</a>
[Msg]	Feat	MENU	Message options: [Msg.] [MsgCan] [Msg-Wt]	<a href="#">page 135</a>
[MsgCan]	Feat>Msg	#1440	Message Cancel	<a href="#">page 135</a>
[Msg-Wt]	Feat>Msg, Call	#156	Attendant Message Waiting: when calling a station or from idle	<a href="#">page 137</a>
[Music]	Feat	MENU	Background Music options: [On/Off] [Tuner]	<a href="#">page 149</a>
[Mute]	Call	#1320	Mute Microphone	<a href="#">page 150</a>
[Name]	Dir	#5	Directory (##, #1994) – Toggle between number and name of your contact	<a href="#">page 92</a>

Soft Key	Source	Default Feature Code	What it Means	Reference
[Name]	CALLog	N/A	Used to display the party name instead of the number	<a href="#">page 71</a>
[New]	Dir	#1	Directory (##, #1994) Personal – Add a new entry	<a href="#">page 92</a>
[New]	Remind	#172	Reminder – Add New Time	<a href="#">page 177</a>
[New]	WakeUp	#173	Wakeup – Add New Time	<a href="#">page 198</a>
[Next]		#*2	Advances forward through a scroll list one step at a time Same as 	
[Night]	Pickup	#192	Night Answer (Bell/UNA Pickup)	<a href="#">page 74</a>
[NoAn-E]	Fwd	#17703	Call forward no answer for External calls	<a href="#">page 67</a>
[NoAn-E]	BG:Fwd	#17708	Boss Group - Call forward no answer for External calls	<a href="#">page 65</a>
[NoAn-E]	aFwd	#17708	Attendant - Call forward no answer for External calls	<a href="#">page 206</a>
[NoAns]	Fwd	#142	Call Forward No Answer	<a href="#">page 67</a>
[NoAns]	BG:Fwd	#169	Boss Group - Call Forward No Answer	<a href="#">page 65</a>
[NoAns]	a:Fwd	#169	Attendant - Call Forward No Answer	<a href="#">page 206</a>
[Number]	Dir	#5, #128	Directory (##, #1994) – Toggle between name and number of your contact. [BckSp] [Name] [Save] [Dial] [Exit]	<a href="#">page 92</a>
[Number]	CALLog	N/A	Used to display the party number instead of the name	<a href="#">page 71</a>
[Number]	Call	#128	Display port Number instead of port Name, for a system-wide period of time	

Soft Key	Source	Default Feature Code	What it Means	Reference
[OCC]	Call	#127	Send Tones (DTMF) for OCC (Other Common Carriers)	<a href="#">page 151</a>
[On/Off]	Music	#135	Music On/Off	<a href="#">page 149</a>
[On/Off]	Trace	#1740	Malicious Call Trace - on/off	<a href="#">page 127</a>
[On/Off]	aTrace	#1742	Attendant Malicious Call Trace - on/off	<a href="#">page 211</a>
[OrgOn]	St.Set	#151	Station Originating Only	<a href="#">page 218</a>
[Origin]	SltMon, S.Mon1	#1448	Used to monitor the 1st conversing party.	<a href="#">page 181</a>
[Out]	CALLog	N/A	Outgoing calls made	<a href="#">page 71</a>
[OutOn]	Tk.Set	#190	Trunk Outgoing Only	<a href="#">page 227</a>
[Page Q]	Feat, Call	MENU	Page_Q Place/Pickup Call options: [PageQ1] [PageQ2] .....[PageQ9] [PagQ10]	<a href="#">page 151</a>
[PageQ1] - [PagQ10]	Page_Q	7060- 7069	Page Queue 1-10	<a href="#">page 151</a>
[Park]	Feat, Call	#183, #7, 79	Call Park	<a href="#">page 159</a>
[Parti#]	Cnflns	#1983	Conference View/Release - Conference Participant #	<a href="#">page 86</a>
[Pascod]	Setup	#179	Passcode Change	<a href="#">page 232</a>
[Pause]	Setup>PrvLib	MENU	Options for Delay Dialing X seconds, in Private Library (#193): [1 sec] [2 sec] [3 sec] [4 sec] ... [9 sec]	<a href="#">page 184</a>

Soft Key	Source	Default Feature Code	What it Means	Reference
<a href="#">Pickup</a>	Feat	MENU	Pickup options to answer a ringing call: <a href="#">Direct</a> <a href="#">Group</a> <a href="#">Night</a>	<a href="#">page 74</a>
<a href="#">PM</a>	Remind, WakeUp, SystemSys>Time, aWake	7	Used to set time to PM (between noon and midnight)	
<a href="#">Prefer</a>	Setup	#131	Preference	<a href="#">page 232</a>
<a href="#">Prev</a>		#*4	Moves backwards through the scroll list one step at a time. Same as  .	
<a href="#">Primry</a>	COS-Sw	#10, #*0	COS Switchover (#149) - Select Primary COS	<a href="#">page 87</a>
<a href="#">Print</a>	Trace	#1741	Malicious Call Trace - Printout	<a href="#">page 134</a>
<a href="#">Print</a>	aTrace	#1743	Attendant Malicious Call Trace - Printout	<a href="#">page 211</a>
<a href="#">Priori</a>	Redial>AutRdl	#*8	Auto Redial (#178) - Priority Assign	<a href="#">page 173</a>
<a href="#">Privac</a>	Setup	#186, #6	Boss Group: Privacy (on/off)	<a href="#">page 232</a>
<a href="#">PrmLog</a>	AcdUcd	#1442	ACD: Primary Log-In	<a href="#">page 53</a>
<a href="#">ProgKy</a>	Setup	#139	Programming Key	<a href="#">page 232</a>
<a href="#">Prtner</a>	SltMon, S.Mon1	#1448	Used to monitor the 2nd conversing party.	<a href="#">page 181</a>
<a href="#">PrtRel</a>	GpCall	#1446	Group call Release of a Participant	<a href="#">page 121</a>
<a href="#">PrvLib</a>	Setup	#193	Programming Private Library	<a href="#">page 184</a>
<a href="#">PubLib</a>	System	#194	Programming Public Library	<a href="#">page 221</a>



Soft Key	Source	Default Feature Code	What it Means	Reference
[Pulse]	Setup>PrvLib>Codes	#2	Private Library (#193) – Dialing Pulses	<a href="#">page 184</a>
[Redial]	Feat	MENU	Redial Number options: [Last#] [Saved#] [AutRdl]	<a href="#">page 173</a>
[Remind]	Feat	#172	Reminder Request	<a href="#">page 177</a>
[Remove]	Dir	#0	Directory (##, #1994) Personal – Remove the displayed entry	<a href="#">page 92</a>
[Report]	aWake	#1971	Attendant Wakeup Report Printout	<a href="#">page 214</a>
[Report]	Charge	#1972	Station Call Charge Printout	<a href="#">page 216</a>
[Reques]	aWake	#1980	Attendant Wakeup Request	<a href="#">page 214</a>
[Reset]	Charge	#1978	Station Call Charge Reset with Printout	<a href="#">page 216</a>
[Restar]	Redial>AutRdl	##*7	Auto Redial (#178) - Restart (Cancel Freezing)	<a href="#">page 173</a>
[Ring]	Setup	#136	Ring Adjustment options: [Vol-Up] [Vol-Dn] [Cadenc] [Type]	<a href="#">page 23</a>
[RlsRsm]	AcdUcd	#1975	ACD/UCD: RLS/Resume all	<a href="#">page 53</a>
[RlsUCD]	AcdUcd	#1991	UCD Release/Resume	<a href="#">page 53</a>
[RmSts0] – [RmSs15]	RoomSt	#7026- #7041	Room Status and Canned Message 0-15	<a href="#">page 178</a>
[RmSts0] – [RmSs15]	aRmSts	#7010- #7025	Attendant Room Status and Canned Message 0-15	<a href="#">page 212</a>
[RoomSt]	Feat	MENU	Room Status and Canned Message options: [RmSts0] [RmSts1].....[RmSs14] [RmSs15]	<a href="#">page 178</a>



Soft Key	Source	Default Feature Code	What it Means	Reference
[RstAll]	Redial>AutRdl	#178	Auto Redial - Restart All	<a href="#">page 173</a>
[Rstrct]	St.Set	#154	Station Outgoing Call Restriction	<a href="#">page 218</a>
[RsvdTo]	Tk.Set	#159	Trunk Reserved To	<a href="#">page 227</a>
[S.Mon1]	SltMon	#1448	Silent Monitor 1-Way Splitting	<a href="#">page 181</a>
[S.Mon2]	SltMon, Call	#1981, hf-9	Silent Monitor 2-Way Both	<a href="#">page 181</a>
[Save#]	Call	#196, #9	Save External Number for future redialing	<a href="#">page 173</a>
[Save]	Dir	##, #1994	Directory Personal (Edit/New) – Save the displayed entry	<a href="#">page 92</a>
[Saved#]	Redial	#196, #9	Saved Number Redial, from Idle State	<a href="#">page 173</a>
[Second]	COS-Sw	#11, #*1	COS Switchover (#149) - Select <b>Secondary</b> COS	<a href="#">page 87</a>
[Secure]	Setup	#17700	Security Line (on/off)	<a href="#">page 237</a>
[SendCW]	Call	hf-8	Send Call Wait tone / CampOn Offhook / Call Offer / 2 <sup>nd</sup> Ring	<a href="#">page 28</a>
[Series]	Call	#195	Series Call	<a href="#">page 38</a>
[Set]	Music>Tuner	#11, #*1	Music Source (#1329) - Set to save the selected source	<a href="#">page 149</a>
[Setup]	Feat	MENU	Feature Setup options: [Ring] [AutAns] [VP-AA] [VP-Rcv] [ElapTM] [HeadSt] [IdlDsp] [Lang] [Pascod] [ProgKy] [Prefer] [PrvLib] [Secure] [DND-WP] [Privac] [ExHold] [MoveSt] [IRSS]	<a href="#">page 233</a>

Soft Key	Source	Default Feature Code	What it Means	Reference
[SltMon]	Feat	MENU	Silent Monitoring options: [S.Mon1] [S.Mon2]	<a href="#">page 181</a>
[Snooze]	Call	4	On receiving Reminder and Wakeup Calls – Snooze	<a href="#">page 177</a>
[Source]	Call	#1321	Exclude Source (Split Call)	<a href="#">page 192</a>
[Space]	Dir	#4	Directory (##, #1994) Personal – Insert a space between words	<a href="#">page 92</a>
[Spk/Hs]	Call	#1323	Handset/Speaker	<a href="#">page 16</a>
[St.Set]	Feat	MENU	Station Features – Setup (Attendant only): [Chk/O] [DND] [HotDly] [HotImm] [OrgOn] [Rstrct] [Block] [TrmOn]	<a href="#">page 218</a>
[St#]	St.Set		Enter Station #, in Attendant features	<a href="#">page 218</a>
[St/Gp#]	BG:Fwd	#168, #167, #169, #1984	Enter Boss Group dial number in [BG:Fwd] <ul style="list-style-type: none"> <li>• (#168) [FwdAll]</li> <li>• (#167) [Busy]</li> <li>• (#169) [NoAns]</li> <li>• (#1984) [Time]</li> <li>• (#17709) [Time-E]</li> </ul>	<a href="#">page 65</a>
[St/Gp#]	aFwd, St.Set		Station/Group #, in Attendant features	<a href="#">page 203</a>
[St/Rm#]	aWake>Reques, aTrace, aRmSts, Charge	#1980, #1742, #1743	Station/Room #, in Attendant features	<a href="#">page 203</a>
[StopDI]	Call	#130, #	Stop Dial	<a href="#">page 33</a>

Soft Key	Source	Default Feature Code	What it Means	Reference
[StRmGrp]			Enter Station/Room/Group #, in Attendant features	<a href="#">page 203</a>
[System]	Feat	MENU	System Features - Setup (Attendant only): [Alarm] [ATT-To] [XfrD/N] [Day/N1] [Day/N2] [PubLib] [Time]	<a href="#">page 221</a>
[Time]	System	#188	Time/Date Set	<a href="#">page 221</a>
[Time]	aFwd	#1984	Attendant Call Forward Timed	<a href="#">page 206</a>
[Time]	Fwd	#1985	Call Forward Timed	<a href="#">page 67</a>
[Time]	BG:Fwd	#1984	Boss Group Call Forward Timed	<a href="#">page 65</a>
[Time-E]	Fwd	#17704	Call forward time for External calls	<a href="#">page 67</a>
[Time-E]	BG:Fwd	#17709	Boss Group Call forward time for External calls	<a href="#">page 65</a>
[Time-E]	aFwd	#17709	Attendant Call forward time for External calls	<a href="#">page 206</a>
[Tk.Set]	Feat	MENU	Trunk Features - Setup (Attendant only): [AutGrd] [Block] [BsyOut] [DIL-D] [DIL-N1] [DIL-N2] [DropND] [HotImm] [HotDly] [IncOnl] [OutOnl] [RsvdTo]	<a href="#">page 227</a>
[Tone]	Setup>PrvLib>Codes	#3	Private Library (#193) – Dialing DTMF Tones	<a href="#">page 184</a>
[Tools]			FlexSet 120S/2800S Type B. Tool kit.	<a href="#">page 241</a>
[Trace]	Feat	MENU	Malicious Call Trace options: [On/Off] [Print]	<a href="#">page 134</a>
[TrkGrp#]	Tk.Set		Enter Trunk Group #, in Attendant features	<a href="#">page 227</a>
[TrmOnl]	St.Set	#152	Station Terminating Only	<a href="#">page 218</a>



Soft Key	Source	Default Feature Code	What it Means	Reference
[Trunk#]	Tk.Set		Enter Trunk Dial Number in Attendant features	<a href="#">page 227</a>
[Tuner]	Music	#1329	Music Source# Select	<a href="#">page 149</a>
[Type]	Setup>Ring	#136	Ring Adjustment - Adjust Ring Type (Pitch)	<a href="#">page 232</a>
[UpCase]	Dir	N/A	Directory (##, #1994) Personal – Toggle between lowercase and uppercase characters	<a href="#">page 92</a>
[Vers]	 >Tools		FlexSet (Type B) Version. Software and Factory Boot version	<a href="#">page 241</a>
[Vers]			FlexSet (Type A) Version. Software and Factory Boot version	<a href="#">page 240</a>
[Vol-Dn]	Setup>Ring (> Volume)	#136	Ring Adjustment - Volume Down	<a href="#">page 232</a>
[Volume]	Setup>Ring	#136	Ring Adjustment - Adjust Ring Level	<a href="#">page 232</a>
[Vol-Up]	Setup>Ring (> Volume)	#136	Ring Adjustment - Volume Up	<a href="#">page 232</a>
[VP-AA]	Setup	#133	Voice Page Auto Answer (on/off)	<a href="#">page 232</a>
[V-Page]	Feat, Call	#191, #3, hf-6	Voice Page activation	<a href="#">page 156</a>
[VP-Rcv]	Setup	#134	Voice Page Receiving (on/off)	<a href="#">page 232</a>
[WaitDT]	Setup>PrvLib>Codes	#6	Private Library (#193) – Wait for Dial Tone	<a href="#">page 184</a>
[WakeUp]	Feat	#173	Wake Up Request	<a href="#">page 198</a>

Soft Key	Source	Default Feature Code	What it Means	Reference
[WhspPg]	Feat, Call	#1744	Whisper Page, Announcing	<a href="#">page 200</a>
[WrapCd]	Acducd	#1977	ACD: Wrap-Up Code	<a href="#">page 53</a>
[WrapTm]	Acducd	#1976	ACD/UCD: Wrap-Up Time	<a href="#">page 53</a>
[Xfer]	Call	#122	Transfer/Hookflash	<a href="#">page 190</a>
[XfrD/N]	System	#1993	Day/Night Transfer (Auto/Manual)	<a href="#">page 221</a>
[ZipTon]			FlexSet Type A. Zip Tone for headset? (Y/N)	<a href="#">page 240</a>
[ZipTon]	 >Tools		FlexSet Type B. Zip Tone for headset? (Y/N)	<a href="#">page 241</a>



International Headquarters  
Tadiran Telecom Business Systems Ltd.  
18 Hasivim St., P.O.Box 450  
Petach-Tikva 49105, Israel  
Tel. +972-3-9262000, Fax. +972-3-9262310

---

USA Headquarters  
Tadiran Telecom, Inc.  
4 Tri Harbor Court  
Port Washington, NY 11050  
Tel. +1-516-632-7200, Fax. +1-516-632-7210

---

Visit us at our website <http://www.tadirantele.com>  
Email: [coral@tadirantele.com](mailto:coral@tadirantele.com)

**Coral™ FlexSet 120S and 121S**  
**User Guide (Coral IPx and Coral FlexiCom)**  
**1st Edition 2006**