

Page	Description
1	Table of Contents
2	Audio
3	Body Controller Front J1, J2
4	Body Controller Front J3, Cables
5	Body Controller Front J4
6	Body Controller Left J1
7	Body Controller Left J2, OHC
8	Body Controller Right J1
9	Body Controller Right J2, J5
10	Body Controller Dashboard
11	Brake Controls
12	CAN Chassis
13	CAN Party
14	CAN Vehicle
15	Door Front Left
16	Door Front Right
17	Door Rear
18	Drive Inverters
19	Driver Assistance
20	HV Battery & HVIL
21	HV Penthouse
22	HVAC Case Subassembly
23	HVAC Thermal Subassembly
24	Restraints Airbags
25	RF/Special Cables
26	Seats Front Left
27	Seats Front Right
28	Security Controls
29	Steering
30	Ultrasonics
31	Power Distribution, E-Fuse VCFront, J1-J4
32	Power Distribution, E-Fuse VCFront, J5-J12
33	Power Distribution, E-Fuse VCLeft, J1-J3
34	Power Distribution, E-Fuse VCLeft, J4-J9
35	Power Distribution, E-Fuse VCRight, J1-J3
36	Power Distribution, E-Fuse VCRight, J4-J9
37	Power Distribution, Grounding A,B,C Pillars
38	Power Distribution, Grounding Frunk
39	Power Distribution, Grounding Trunk

Table 1: Abbreviations

LF	Left Front	RF	Right Front
LR	Left Rear	RR	Right Rear
LHS	Left-Hand Side	RHS	Right-Hand Side

Table 2: Harness Designators

A	LH BODY	Q	PARCEL SHELF
B	RH BODY	R	LH RR DOOR
C	CENTER CONSOLE	S	RH RR DOOR
D	LH FR DOOR	T	LIFT GATE
F	FR FASCIA	U	THERMAL
G	RR FASCIA	V	GLASS
H	HV PENTHOUSE	W	FRUNK
J	IP	X	REAR SUBFRAME
K	HEADLINER	Y	FRONT SEATS
L	FRONT END MODULE		
N	FRONT SUBFRAME		
P	RH FR DOOR		

Table 3: Wire Color Designators

BK	Black	OG	Orange
BN	Brown	RD	Red
BU	Blue	VT	Violet (Purple)
GN	Green	WH	White
GY	Gray	YE	Yellow

Table 4: Wire Type Designators

FLRY	Thin wall 105C rated, regular stranded PVC insulated [FLRY-A]
FLRB	Thin wall 105C rated, bunched conductor PVC insulated [FLRY-B]
MCIV	Thin wall 105C rated, compressed conductor PVC (halogen free) insulated
XR15	Thin wall 150C rated, cross-linked polyolefin, high flexible
FLXB	Thin wall 125C rated, cross-linked polyolefin, high flexible, halogen free insulated
3TBL	Thick wall 105C rated, aluminum conductor PVC insulated

Table 5: Option Codes

DRIVR	Driver Seat
PASSN	Passenger Seat
LHST	Left side Seat
RHST	Right Side Seat
FOG	Fog Light
MCOLM	Manual Steering Column
PCOLM	Power Steering Column
BAUDIO	Premium Audio
PAUDIO	Cold Weather Package
COLDW	Left Hand Drive
LHD	All Wheel Drive
AWD	Rear Wheel Drive
RWD	Base Interior Lights
PINLT	Premium Interior Lights
PMIRROR	Premium Mirror with Powerfold
RENA	Region North America
CSUSP	Coil Suspension
PREMST	Premium Seat

General Notes:

- Switches [Relays] are shown in their inactive [de-energized] state.
- Splices may be split across pages for visual clarity with respect to the function displayed on the particular page.
- Some connectors are split across multiple pages for clarity.
There is no overall reference in this document for the signals routed to a specific connector.
- Wire sizes are specified in mm² cross-sectional area (CSA) per SAE 1127/8
- Wire Specification: 60V, thin-wall PVC (ISO type or equivalent).
Default wire type to be rated 60VDC/25VAC and -40C to 105C operating temperature.
See DIN 13602 or ISO 6722 for detailed specifications.
- Unless otherwise specified at the device pins, terminal plating is to be Tin or Pre-Tin

TERMINAL PLATING

- GOLD TERMINAL NECESSARY
- SILVER PLATING NECESSARY

- Inline connector gender specification is based on the terminal type.
Inline connectors with "M" suffix have male, tab or pin terminals
Inline connectors with "F" suffix have female, receptacle or socket terminals

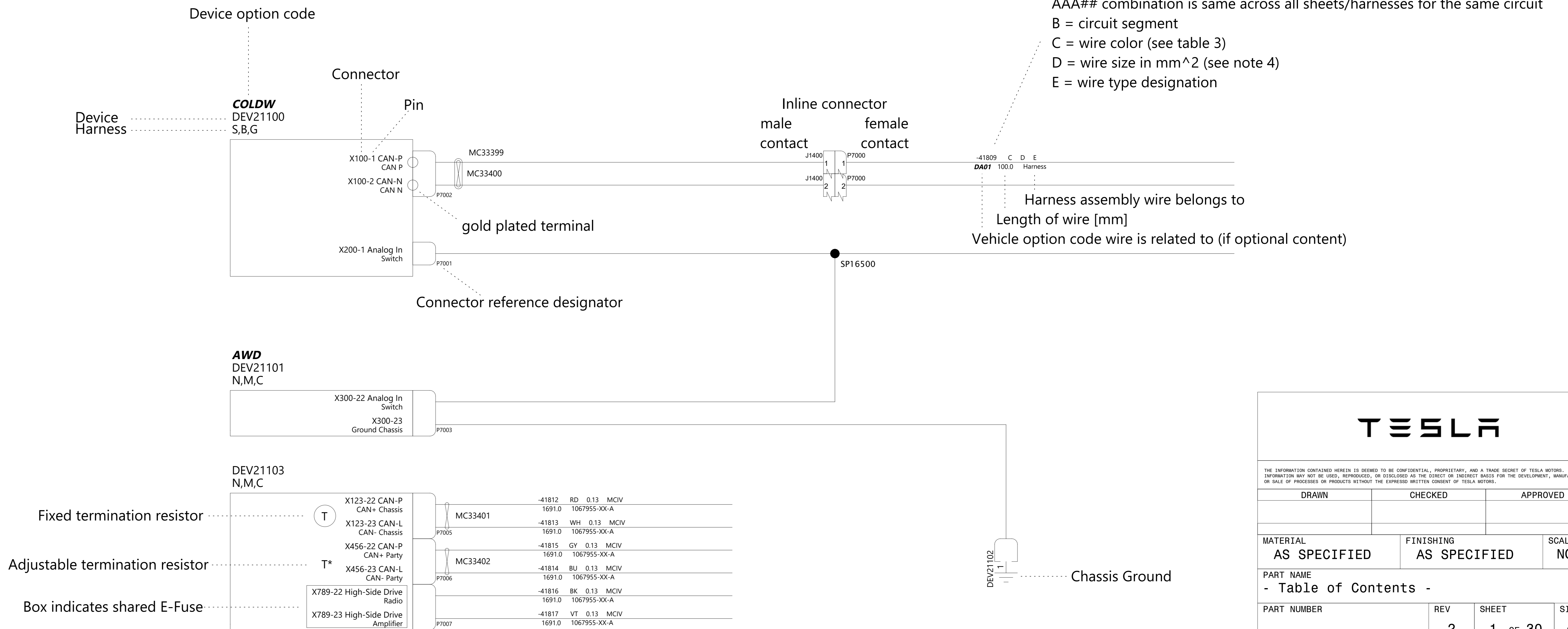

TESLA			
THE INFORMATION CONTAINED HEREIN IS DEEMED TO BE CONFIDENTIAL, PROPRIETARY, AND A TRADE SECRET OF TESLA MOTORS. THIS INFORMATION MAY NOT BE USED, REPRODUCED, OR DISCLOSED AS THE DIRECT OR INDIRECT BASIS FOR THE DEVELOPMENT, MANUFACTURE, OR SALE OF PROCESSES OR PRODUCTS WITHOUT THE EXPRESS WRITTEN CONSENT OF TESLA MOTORS.			
DRAWN	CHECKED	APPROVED	
MATERIAL AS SPECIFIED	FINISHING AS SPECIFIED	SCALE NONE	
PART NAME - Table of Contents -			
PART NUMBER	REV	SHEET	SIZE
	2	1 OF 30	A0

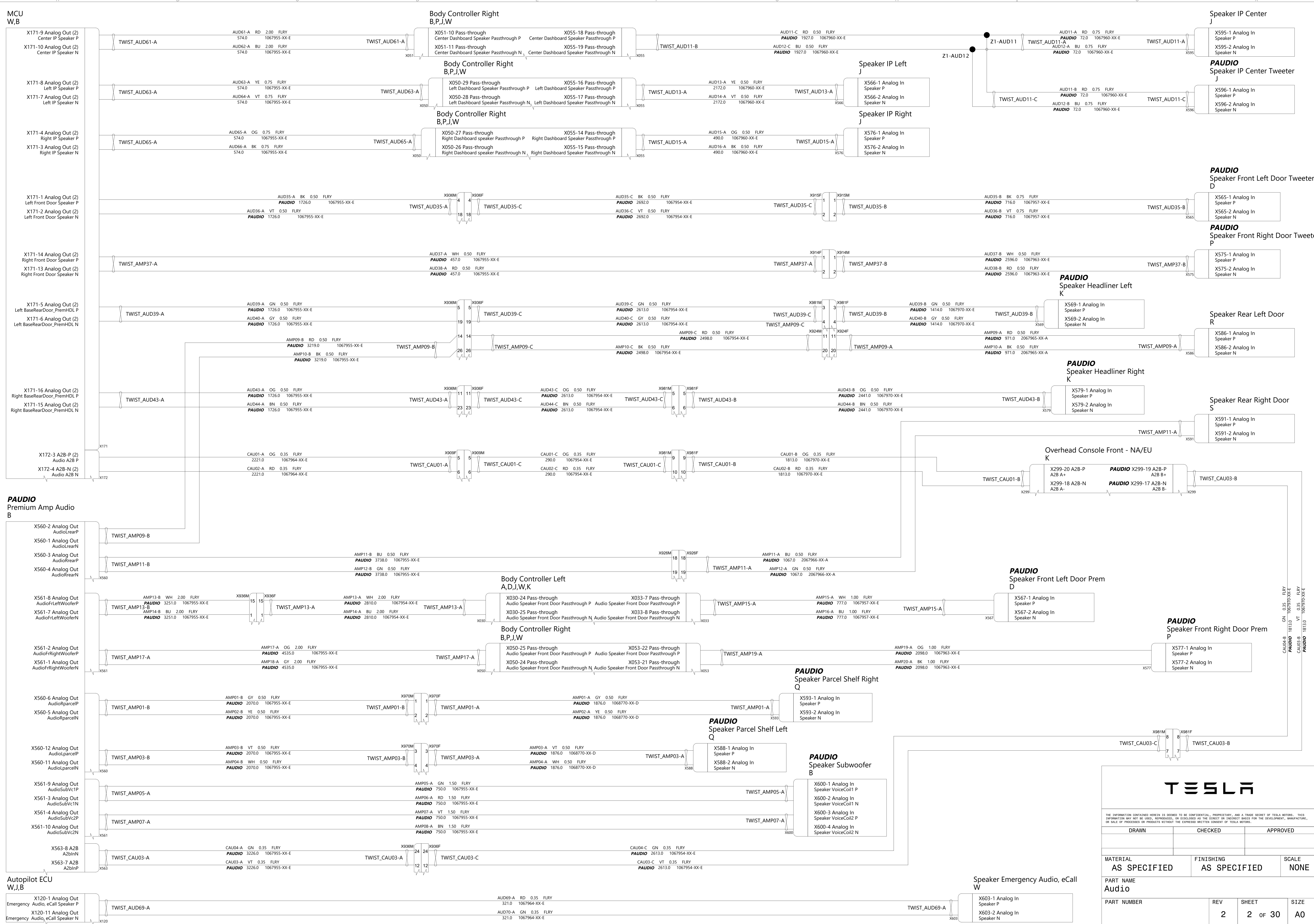

THE INFORMATION CONTAINED HEREIN IS DEEMED TO BE CONFIDENTIAL, PROPRIETARY, AND A TRADE SECRET OF TESLA MOTORS. THIS INFORMATION MAY NOT BE USED, REPRODUCED, OR DISCLOSED AS THE DIRECT OR INDIRECT BASIS FOR THE DEVELOPMENT, MANUFACTURE, OR SALE OF PROCESSES OR PRODUCTS WITHOUT THE EXPRESSED WRITTEN CONSENT OF TESLA MOTORS.

DRAWN	CHECKED	APPROVED
MATERIAL AS SPECIFIED	FINISHING AS SPECIFIED	SCALE NONE
PART NAME Audio		
PART NUMBER	REV 2	SHEET 2 OF 30
		SIZE A0

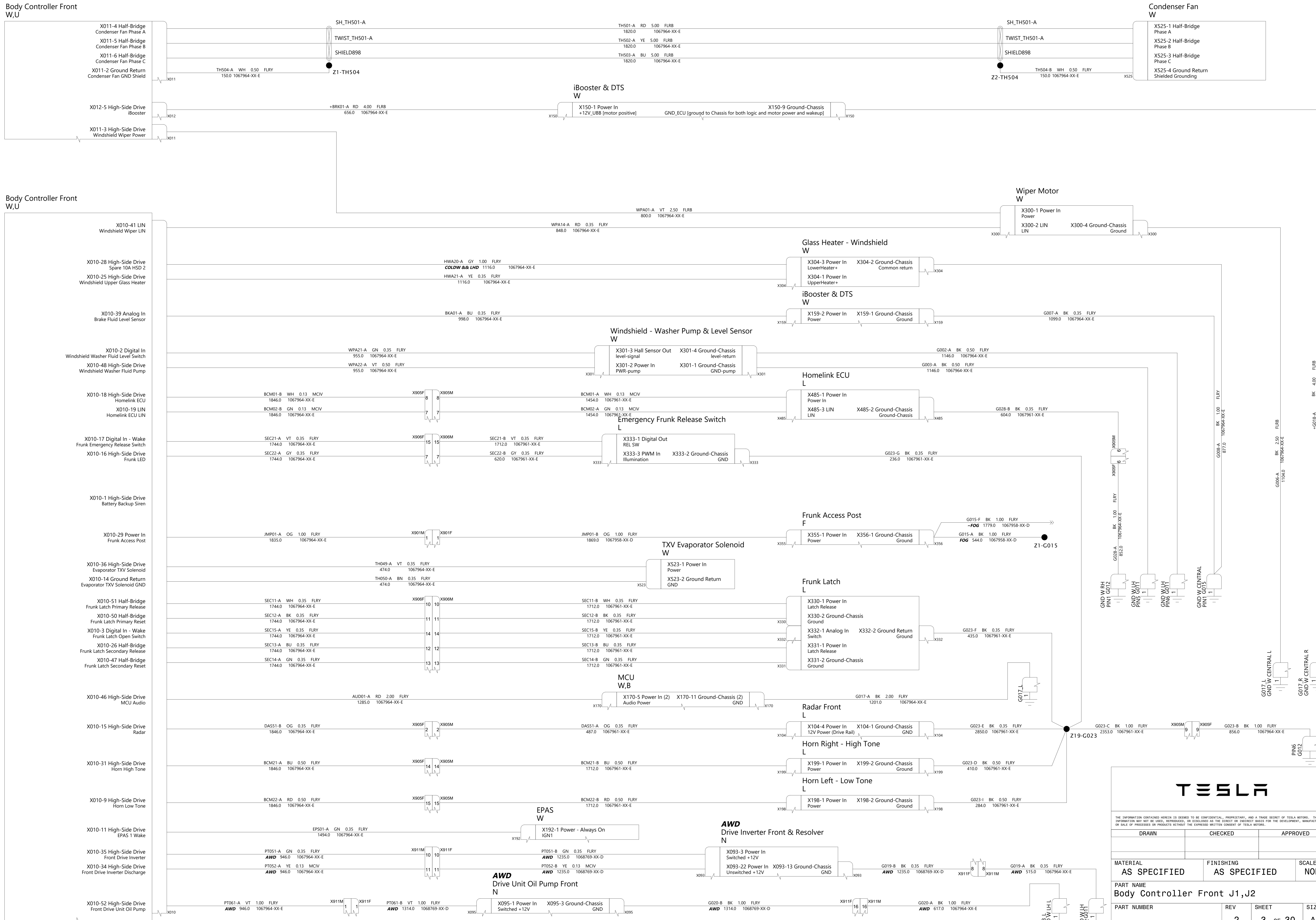

THE INFORMATION CONTAINED HEREIN IS DEEMED TO BE CONFIDENTIAL, PROPRIETARY, AND A TRADE SECRET OF TESLA MOTORS. THIS INFORMATION MAY NOT BE USED, REPRODUCED, OR DISCLOSED AS THE DIRECT OR INDIRECT BASIS FOR THE DEVELOPMENT, MANUFACTURE, OR SALE OF PROCESSES OR PRODUCTS WITHOUT THE EXPRESSED WRITTEN CONSENT OF TESLA MOTORS.

DRAWN	CHECKED	APPROVED
MATERIAL AS SPECIFIED	FINISHING AS SPECIFIED	SCALE NONE
PART NAME Body Controller Front J1,J2		
PART NUMBER	REV	SHEET
	2	3 OF 30
		SIZE A0

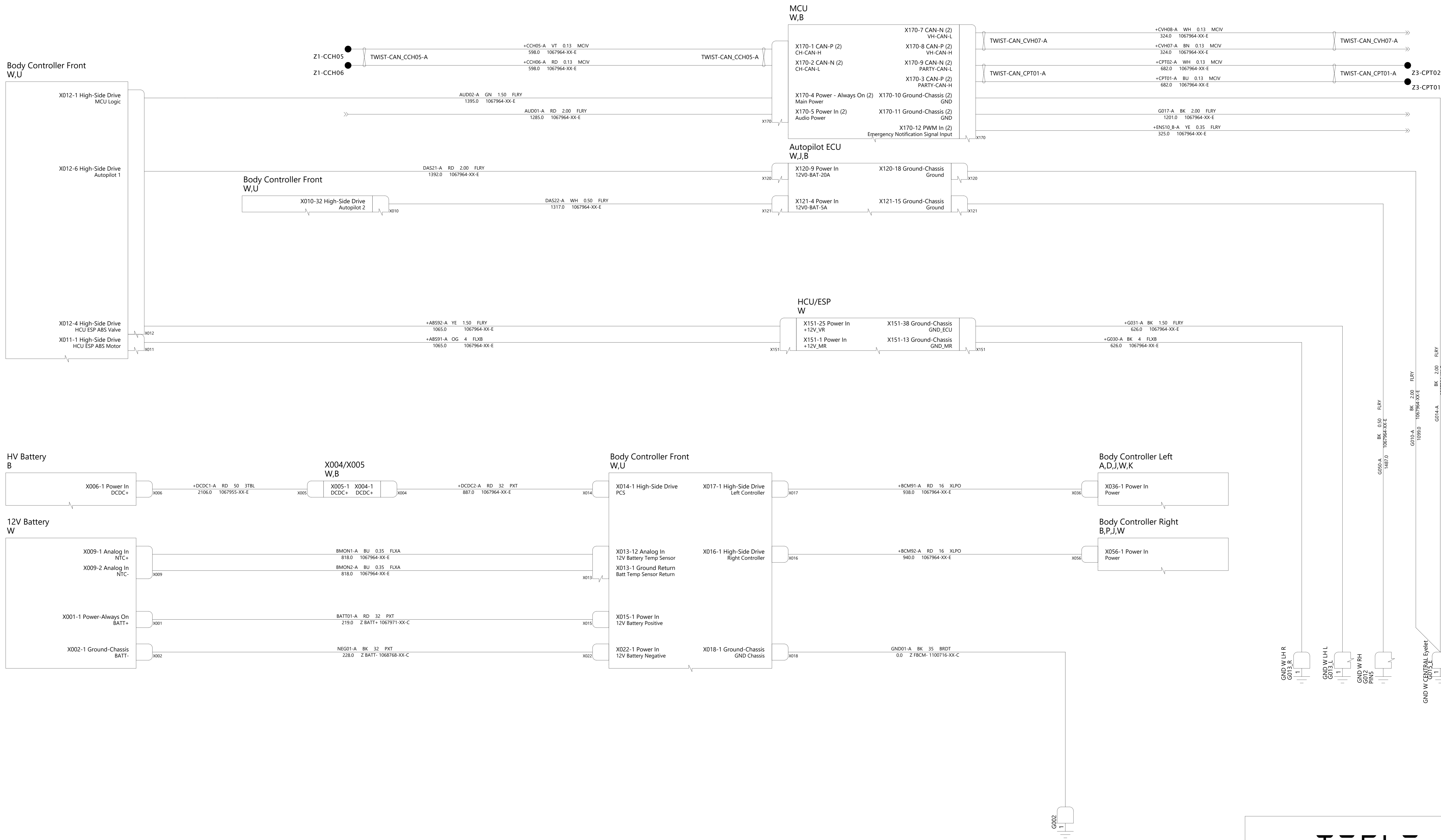

TESLA

THE INFORMATION CONTAINED HEREIN IS DEEMED TO BE CONFIDENTIAL, PROPRIETARY, AND A TRADE SECRET OF TESLA MOTORS. THIS INFORMATION MAY NOT BE USED, REPRODUCED, OR DISCLOSED AS THE DIRECT OR INDIRECT BASIS FOR THE DEVELOPMENT, MANUFACTURE, OR SALE OF PROCESSES OR PRODUCTS WITHOUT THE EXPRESSED WRITTEN CONSENT OF TESLA MOTORS.

DRAWN	CHECKED	APPROVED
MATERIAL AS SPECIFIED	FINISHING AS SPECIFIED	SCALE NONE
PART NAME Body Controller Front J3, Cables		
PART NUMBER	REV	SHEET
	2	4 OF 30
		SIZE A0

Body Controller Front
W,U

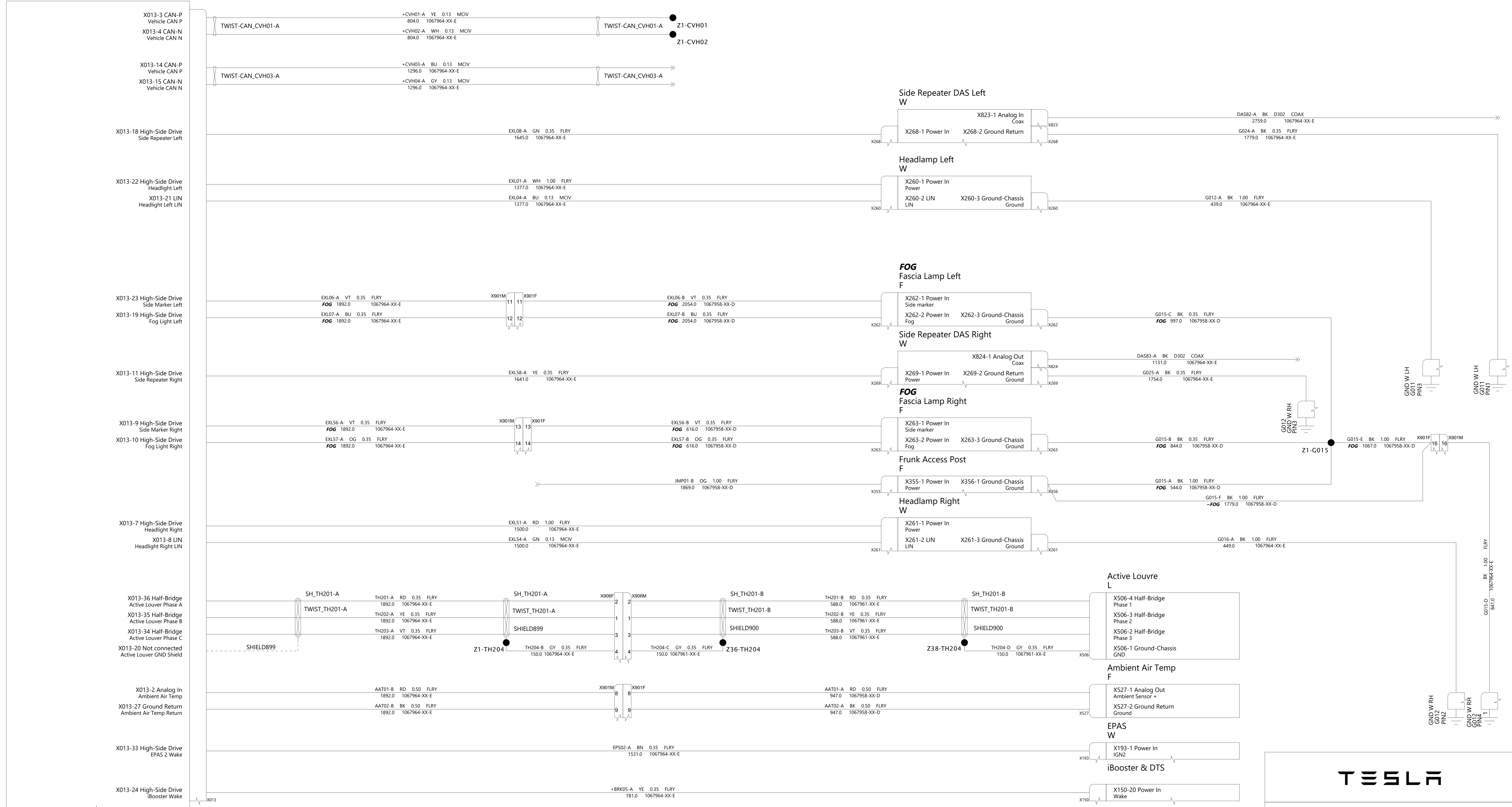

THE INFORMATION CONTAINED HEREIN IS DEEMED TO BE CONFIDENTIAL, PROPRIETARY, AND A TRADE SECRET OF TESLA MOTORS. THIS INFORMATION MAY NOT BE USED, REPRODUCED, OR DISCLOSED AS THE DIRECT OR INDIRECT BASIS FOR THE DEVELOPMENT, MANUFACTURE, OR SALE OF PROCESSES OR PRODUCTS WITHOUT THE EXPRESSED WRITTEN CONSENT OF TESLA MOTORS.

DRAWN	CHECKED	APPROVED

MATERIAL	FINISHING	SCALE
AS SPECIFIED	AS SPECIFIED	NONE

PART NAME
Body Controller Front J4

PART NUMBER	REV	SHEET	SIZE
	2	5 OF 30	A0

Body Controller Left
A,D,J,W,K

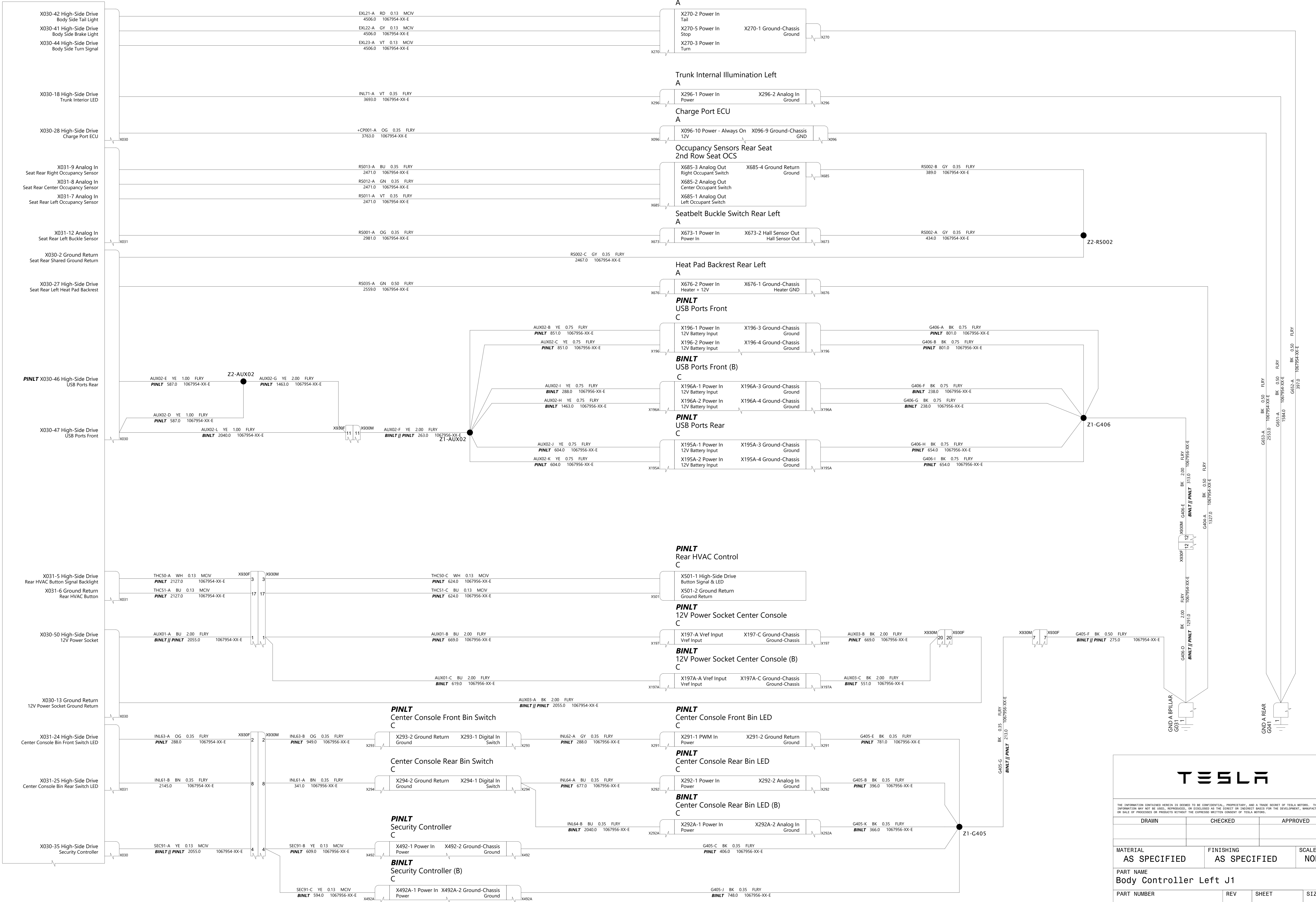

TESLA			
THE INFORMATION CONTAINED HEREIN IS DEEMED TO BE CONFIDENTIAL, PROPRIETARY, AND A TRADE SECRET OF TESLA MOTORS. THIS INFORMATION MAY NOT BE USED, REPRODUCED, OR DISCLOSED AS THE DIRECT OR INDIRECT BASIS FOR THE DEVELOPMENT, MANUFACTURE, OR SALE OF PROCESSES OR PRODUCTS WITHOUT THE EXPRESS WRITTEN CONSENT OF TESLA MOTORS.			
DRAWN	CHECKED	APPROVED	
MATERIAL AS SPECIFIED	FINISHING AS SPECIFIED	SCALE NONE	
PART NAME Body Controller Left J1			
PART NUMBER	REV	SHEET	SIZE
	2	6 OF 30	A0

Body Controller Left
A,D,J,W,K

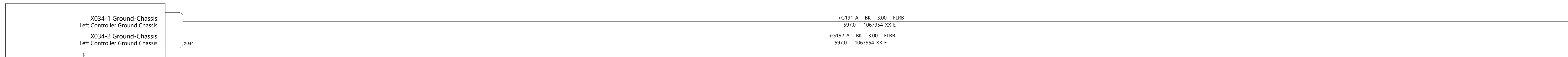

Body Controller Left
A,D,J,W,K

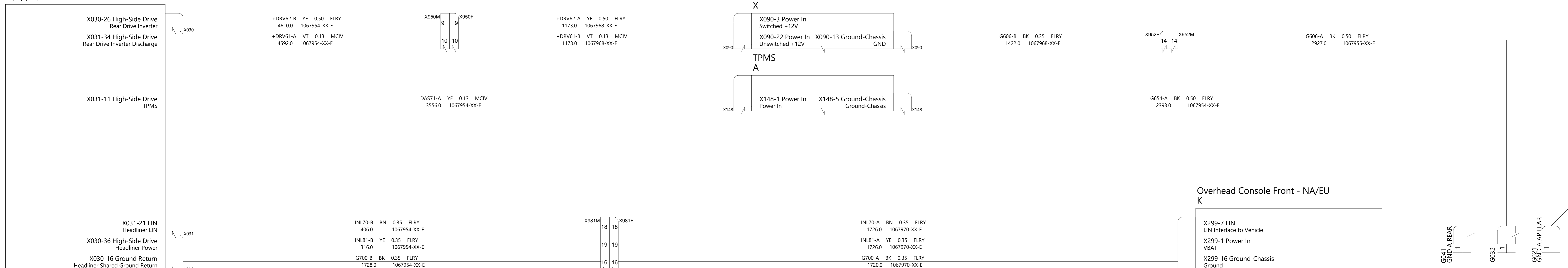

Vanity LED Right
K

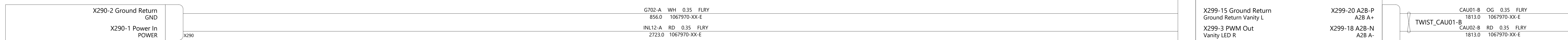

Vanity LED Left
K

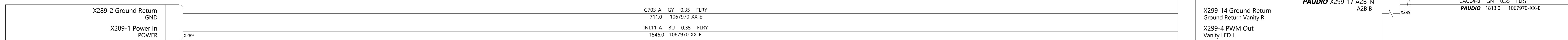

Overhead Console Rear - NA/EU
K

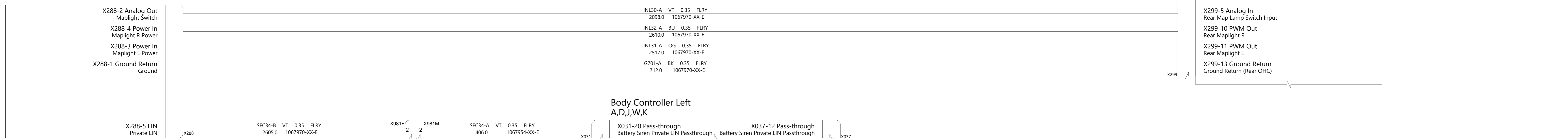

Overhead Console Front - NA/EU
K

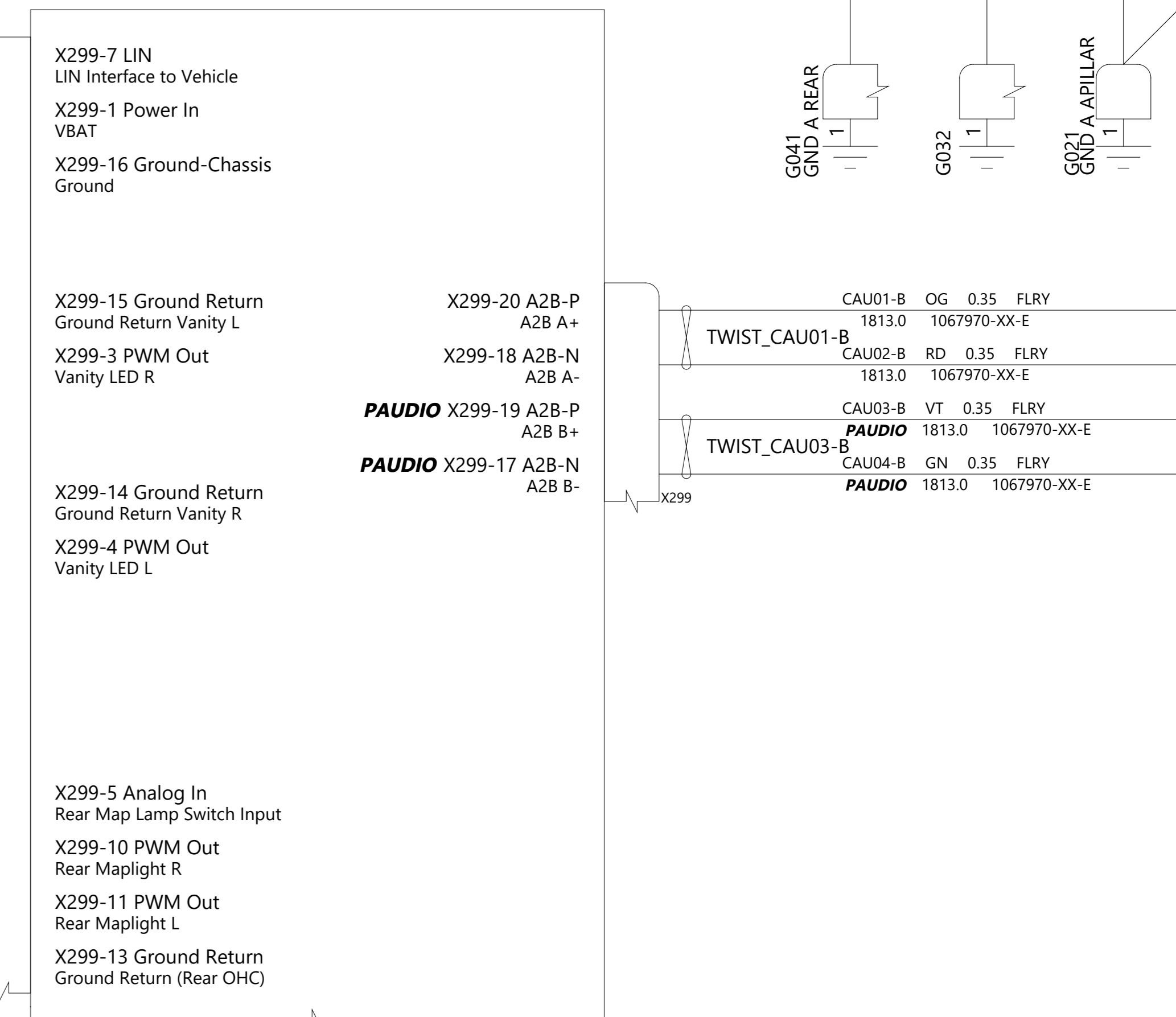

Body Controller Left
A,D,J,W,K

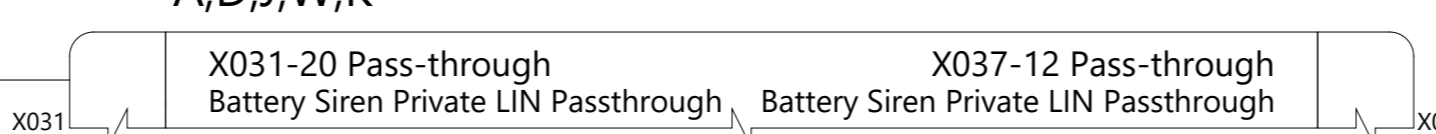

TESLA

THE INFORMATION CONTAINED HEREIN IS DEEMED TO BE CONFIDENTIAL, PROPRIETARY, AND A TRADE SECRET OF TESLA MOTORS. THIS INFORMATION MAY NOT BE USED, REPRODUCED, OR DISCLOSED AS THE DIRECT OR INDIRECT BASIS FOR THE DEVELOPMENT, MANUFACTURE, OR SALE OF PROCESSES OR PRODUCTS WITHOUT THE EXPRESSED WRITTEN CONSENT OF TESLA MOTORS.

DRAWN	CHECKED	APPROVED
-------	---------	----------

MATERIAL AS SPECIFIED	FINISHING AS SPECIFIED	SCALE NONE
--------------------------	---------------------------	---------------

PART NAME
Body Controller Left J2, OHC

PART NUMBER	REV	SHEET	SIZE
	2	7 OF 30	A0

Body Controller Right
B,P,J,W

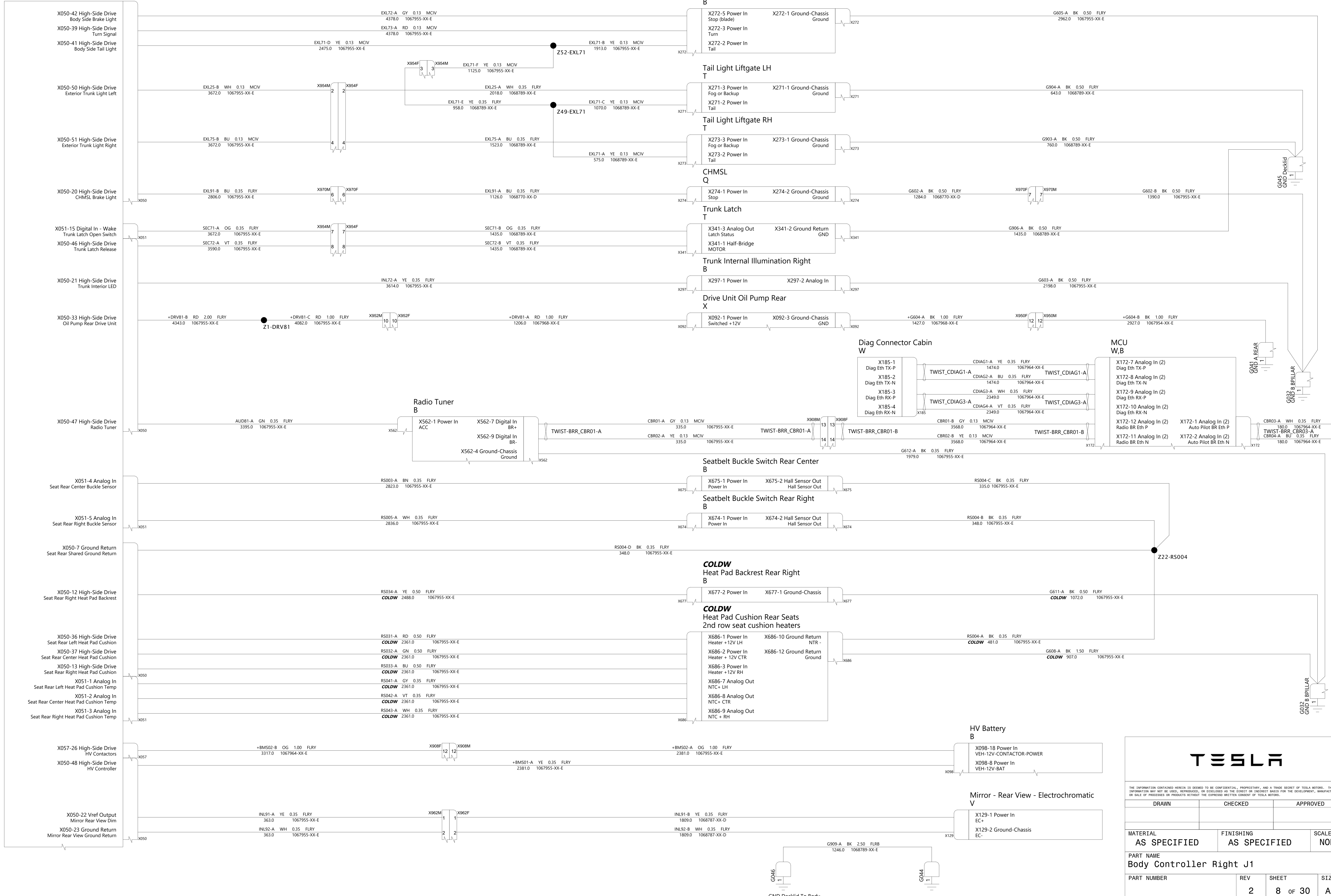

THE INFORMATION CONTAINED HEREIN IS DEEMED TO BE CONFIDENTIAL, PROPRIETARY, AND A TRADE SECRET OF TESLA MOTORS. THIS INFORMATION MAY NOT BE USED, REPRODUCED, OR DISCLOSED AS THE DIRECT OR INDIRECT BASIS FOR THE DEVELOPMENT, MANUFACTURE, OR SALE OF PROCESSES OR PRODUCTS WITHOUT THE EXPRESS WRITTEN CONSENT OF TESLA MOTORS.

DRAWN	CHECKED	APPROVED
MATERIAL AS SPECIFIED	FINISHING AS SPECIFIED	SCALE NONE
PART NAME Body Controller Right J1		
PART NUMBER	REV	SHEET
	2	8 OF 30
		SIZE A0

Body Controller Right
B,P,J,W

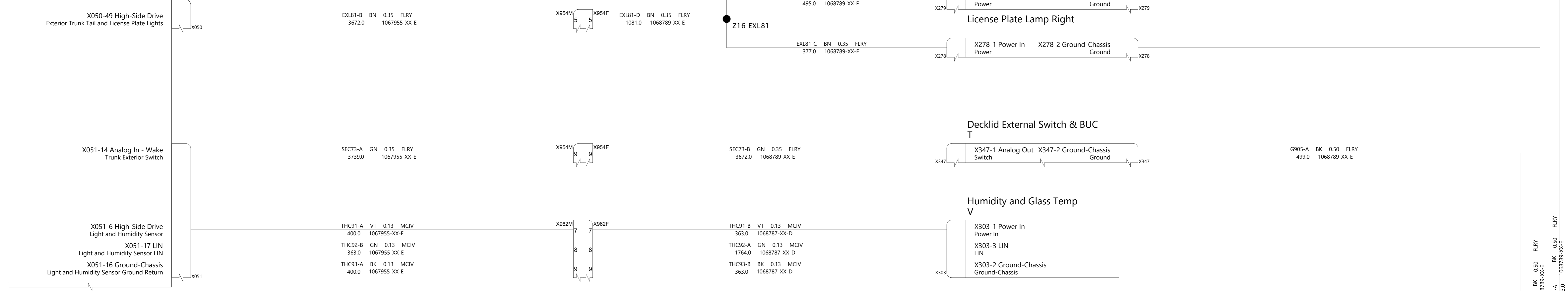

Body Controller Right
B,P,J,W

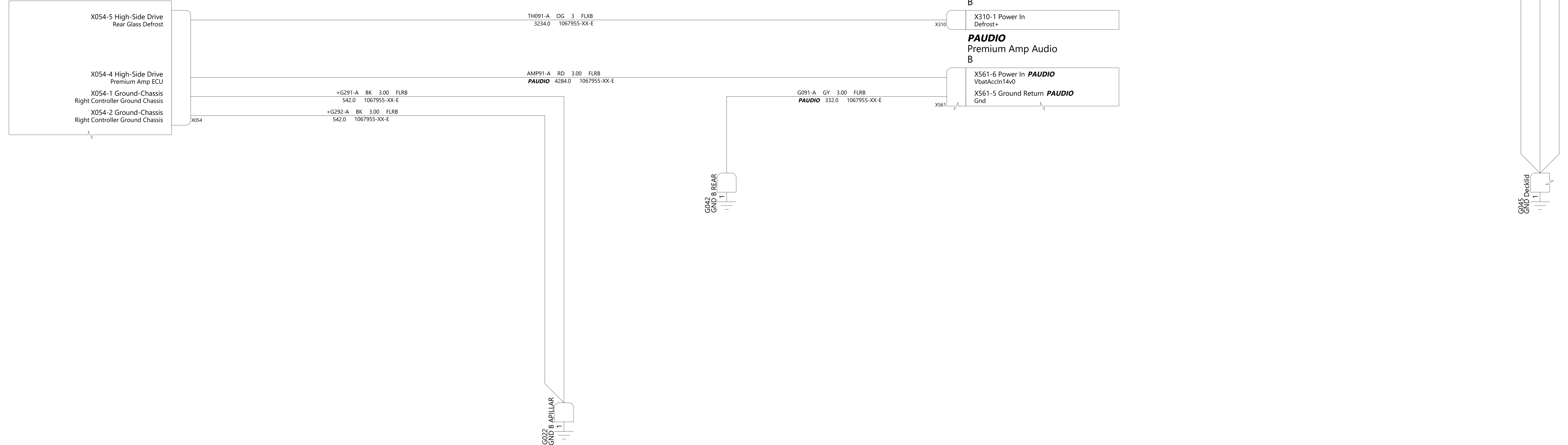

TESLA

THE INFORMATION CONTAINED HEREIN IS DEEMED TO BE CONFIDENTIAL, PROPRIETARY, AND A TRADE SECRET OF TESLA MOTORS. THIS INFORMATION MAY NOT BE USED, REPRODUCED, OR DISCLOSED AS THE DIRECT OR INDIRECT BASIS FOR THE DEVELOPMENT, MANUFACTURE, OR SALE OF PROCESSES OR PRODUCTS WITHOUT THE EXPRESS WRITTEN CONSENT OF TESLA MOTORS.

DRAWN	CHECKED	APPROVED

MATERIAL	FINISHING	SCALE
AS SPECIFIED	AS SPECIFIED	NONE

PART NAME
Body Controller Right J2, J5

PART NUMBER	REV	SHEET	SIZE
	2	9 OF 30	A0

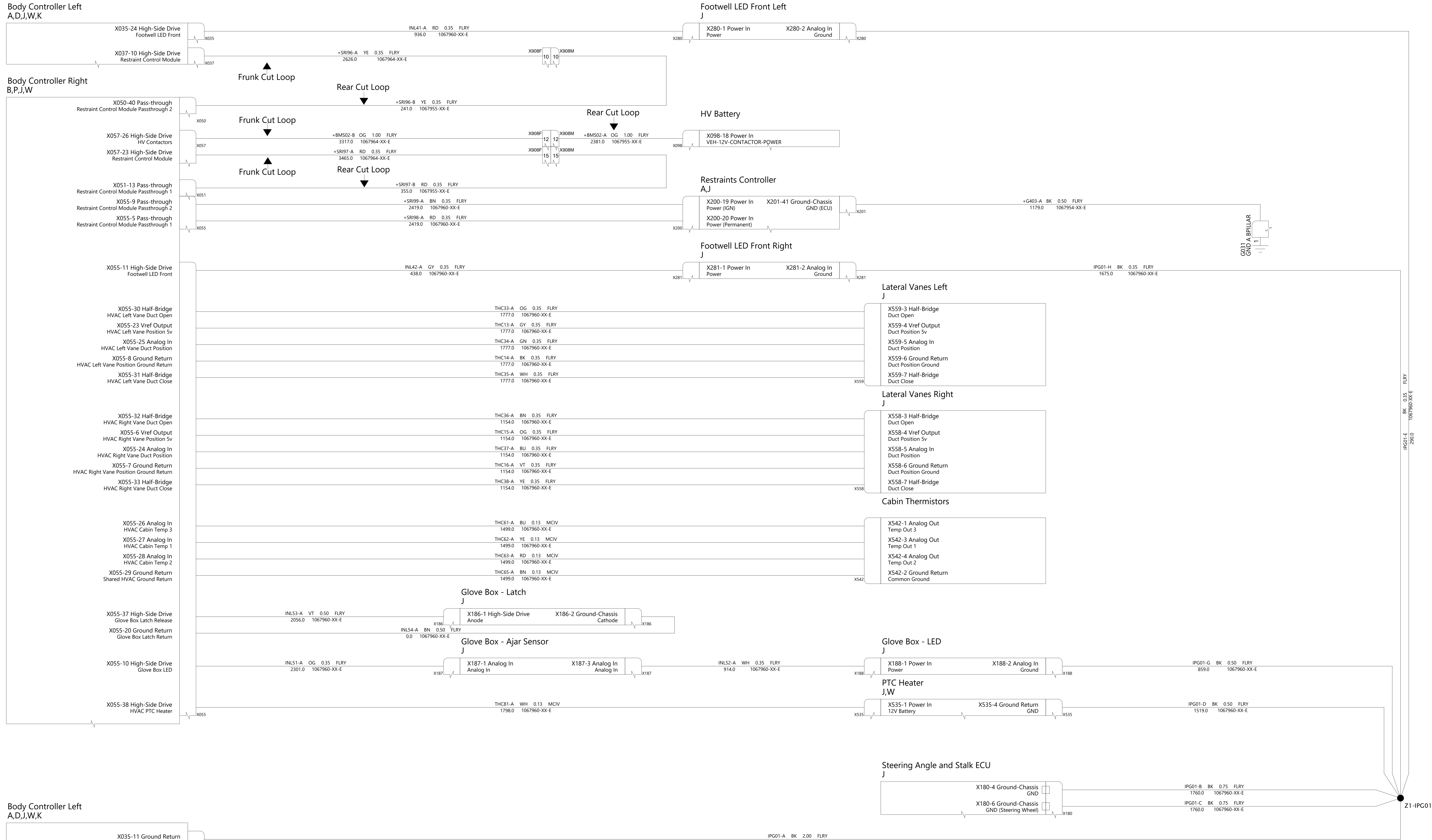

THE INFORMATION CONTAINED HEREIN IS DEEMED TO BE CONFIDENTIAL, PROPRIETARY, AND A TRADE SECRET OF TESLA MOTORS. THIS INFORMATION MAY NOT BE USED, REPRODUCED, OR DISCLOSED AS THE DIRECT OR INDIRECT BASIS FOR THE DEVELOPMENT, MANUFACTURE, OR SALE OF PROCESSES OR PRODUCTS WITHOUT THE EXPRESSED WRITTEN CONSENT OF TESLA MOTORS.

DRAWN	CHECKED	APPROVED
MATERIAL AS SPECIFIED	FINISHING AS SPECIFIED	SCALE NONE
PART NAME Body Controllers Dashboard		
PART NUMBER	REV	SHEET
	2	10 of 30
		SIZE A0

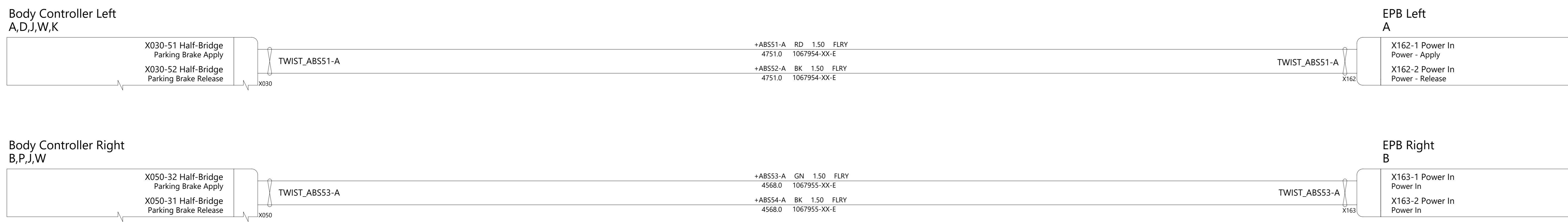
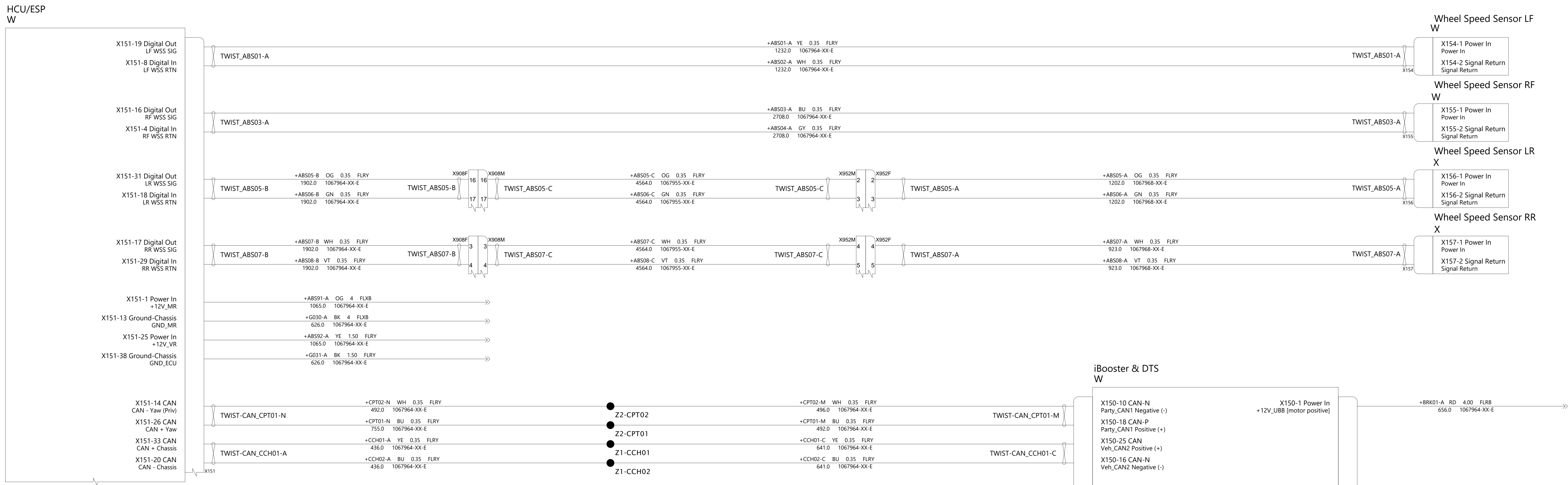

THE INFORMATION CONTAINED HEREIN IS DEEMED TO BE CONFIDENTIAL, PROPRIETARY, AND A TRADE SECRET OF TESLA MOTORS. THIS INFORMATION MAY NOT BE USED, REPRODUCED, OR DISCLOSED AS THE DIRECT OR INDIRECT BASIS FOR THE DEVELOPMENT, MANUFACTURE, OR SALE OF PROCESSES OR PRODUCTS WITHOUT THE EXPRESSED WRITTEN CONSENT OF TESLA MOTORS.

DRAWN	CHECKED	APPROVED
MATERIAL AS SPECIFIED	FINISHING AS SPECIFIED	SCALE NONE
PART NAME Brake Controls		
PART NUMBER	REV	SHEET
	2	11 OF 30
		SIZE A0

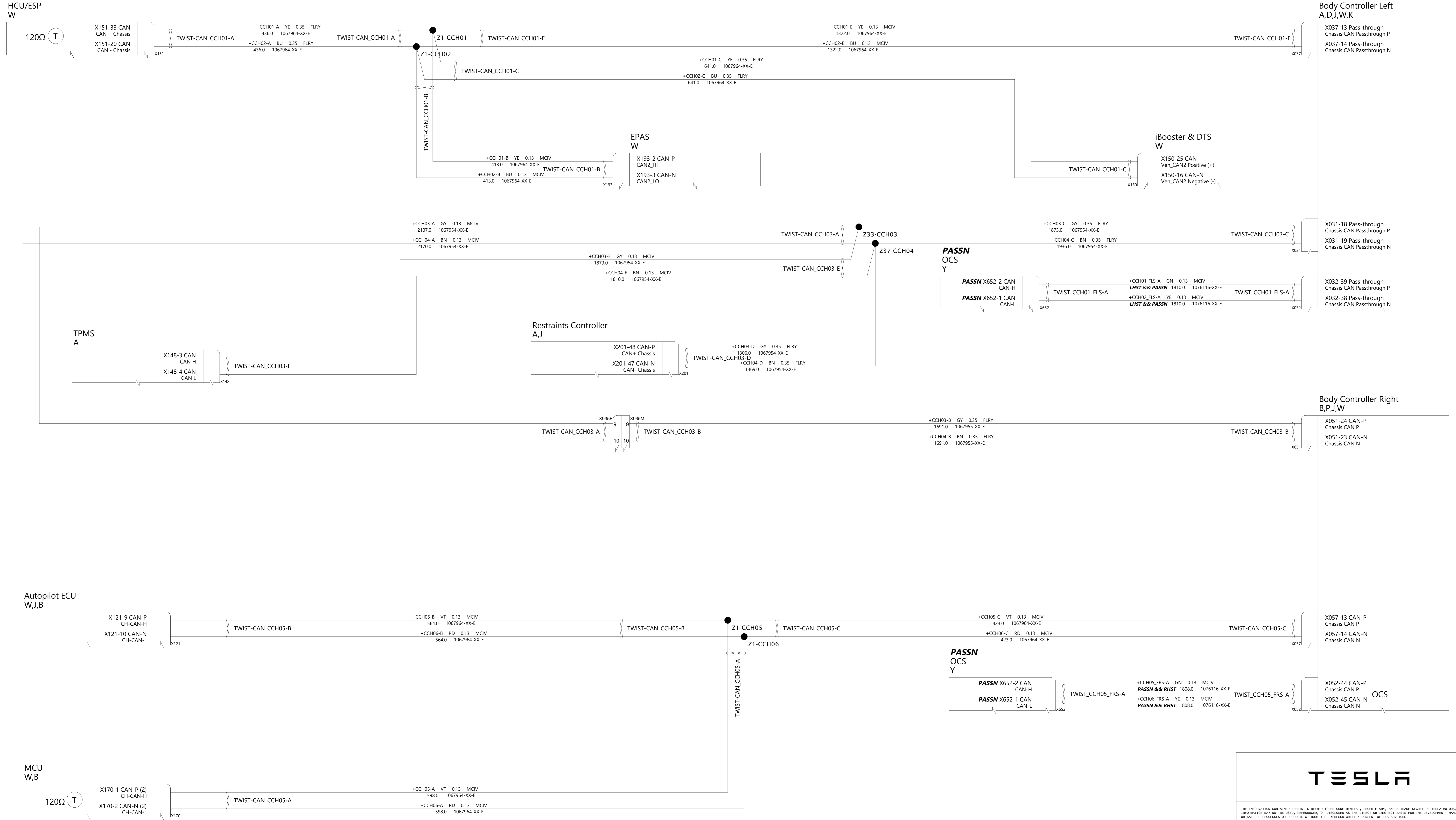

TESLA

THE INFORMATION CONTAINED HEREIN IS DEEMED TO BE CONFIDENTIAL, PROPRIETARY, AND A TRADE SECRET OF TESLA MOTORS. THIS INFORMATION MAY NOT BE USED, REPRODUCED, OR DISCLOSED AS THE OBJECT OR INDIRECT BASIS FOR THE DEVELOPMENT, MANUFACTURE, OR SALE OF PROCESSES OR PRODUCTS WITHOUT THE EXPRESSED WRITTEN CONSENT OF TESLA MOTORS.

DRAWN	CHECKED	APPROVED
MATERIAL AS SPECIFIED	FINISHING AS SPECIFIED	SCALE NONE
PART NAME CAN Chassis		
PART NUMBER	REV	SHEET
	2	12 of 30
		SCALE A0

AWD
Drive Inverter Front & Resolver
N

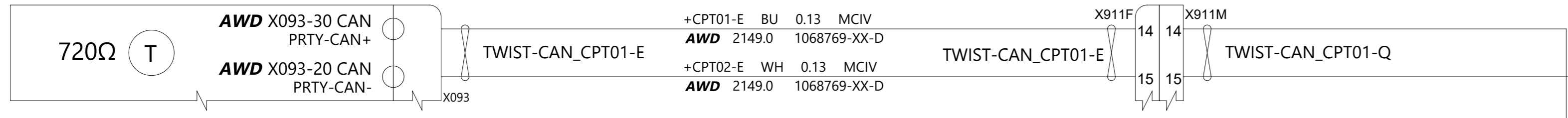

Body Controller Front
W,U

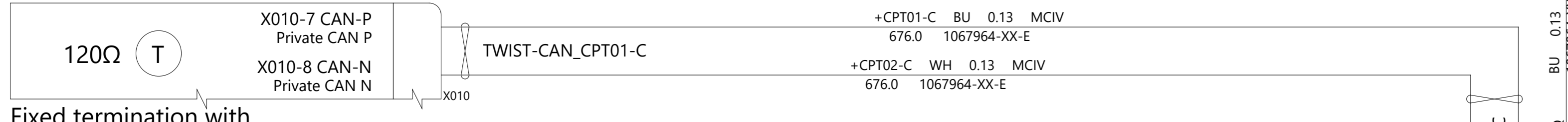

Fixed termination with part number ending in -00-G or newer

Autopilot ECU
W,J,B

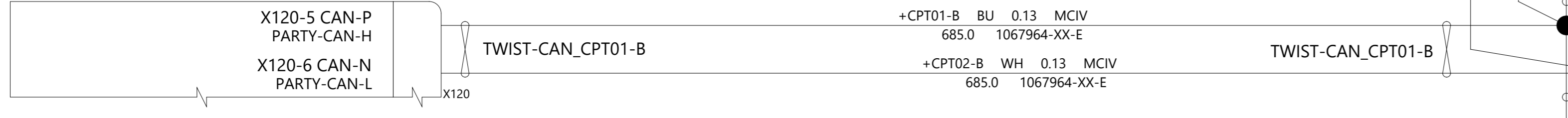

MCU
W,B

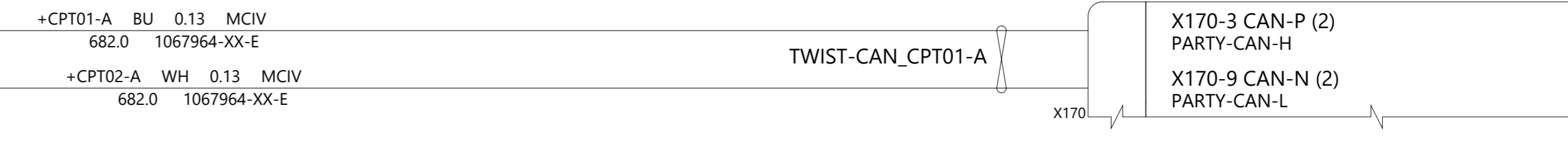

HCU/ESP
W

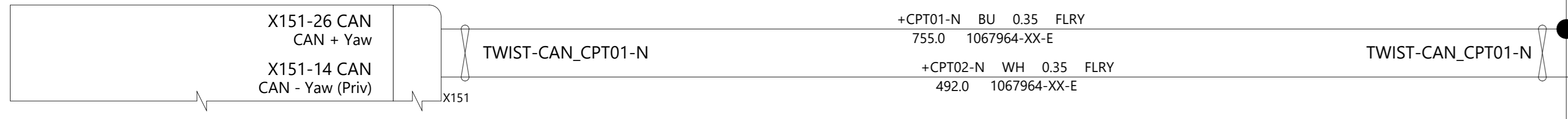

EPAS
W

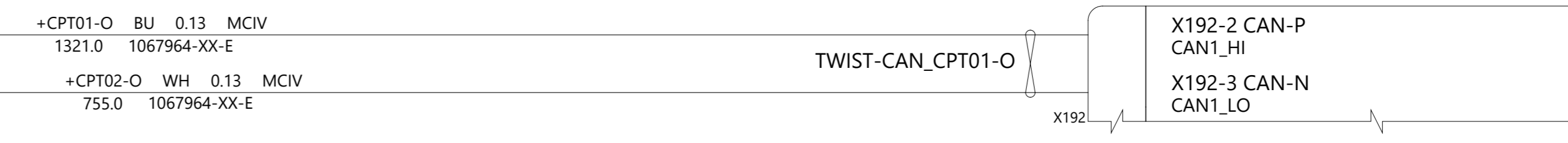

iBooster & DTS
W

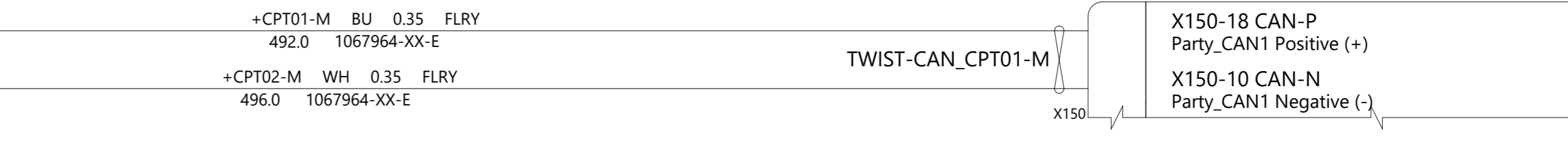

Body Controller Left
A,D,J,W,K

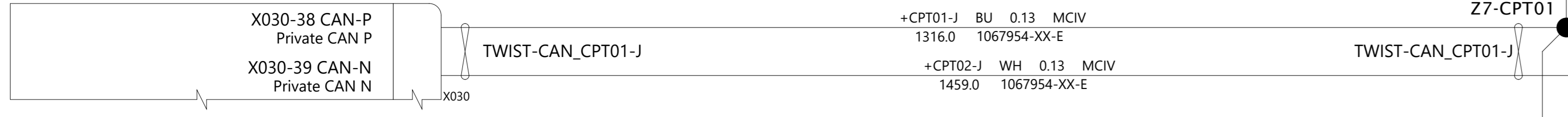

Body Controller Right
B,P,J,W

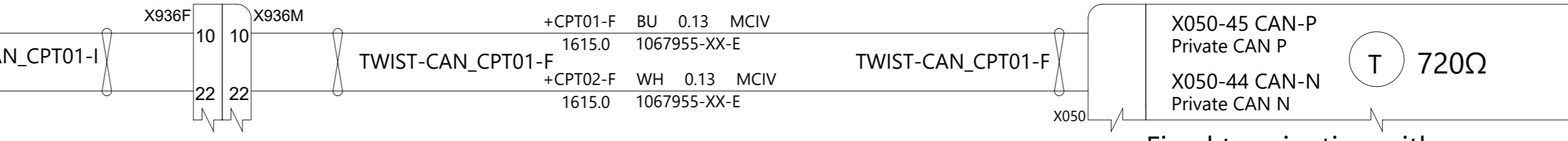

Fixed termination with part number ending in -00-G or newer

Drive Inverter Rear & Resolver
X

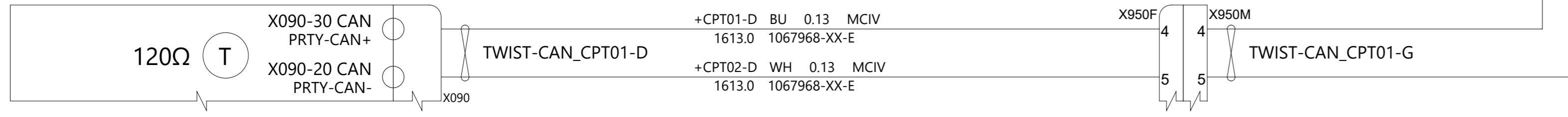

Restraints Controller
A,J

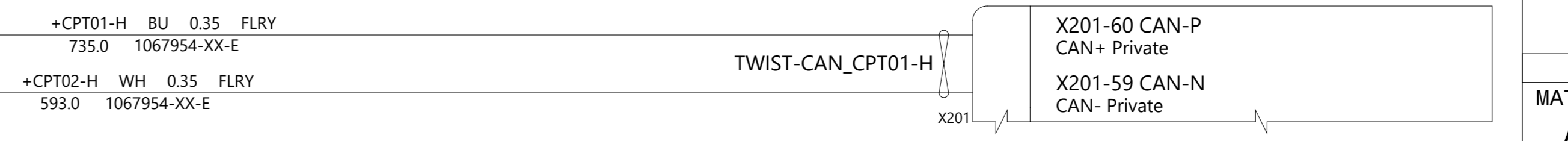

TESLA

THE INFORMATION CONTAINED HEREIN IS DEEMED TO BE CONFIDENTIAL, PROPRIETARY, AND A TRADE SECRET OF TESLA MOTORS. THIS INFORMATION MAY NOT BE USED, REPRODUCED, OR DISCLOSED AS THE DIRECT OR INDIRECT BASIS FOR THE DEVELOPMENT, MANUFACTURE, OR SALE OF PROCESSES OR PRODUCTS WITHOUT THE EXPRESS WRITTEN CONSENT OF TESLA MOTORS.

DRAWN	CHECKED	APPROVED
-------	---------	----------

MATERIAL AS SPECIFIED	FINISHING AS SPECIFIED	SCALE NONE
--------------------------	---------------------------	---------------

PART NAME CAN Party			
------------------------	--	--	--

PART NUMBER	REV	SHEET	SIZE
	2	13 OF 30	A0

AWD
Drive Inverter Front & Resolver
N

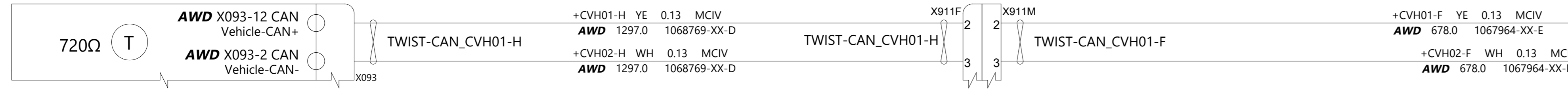

BINLT
Security Controller (B)
C

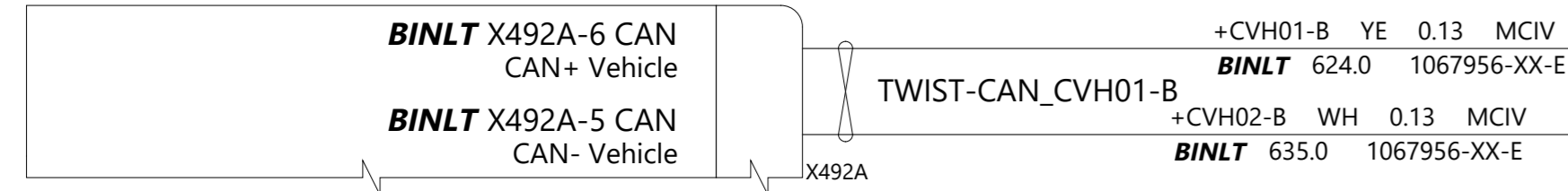

PINLT
Security Controller
C

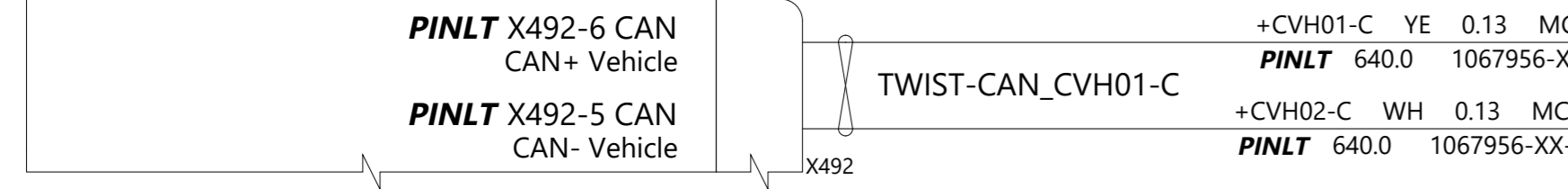

Body Controller Left
A,D,J,W,K

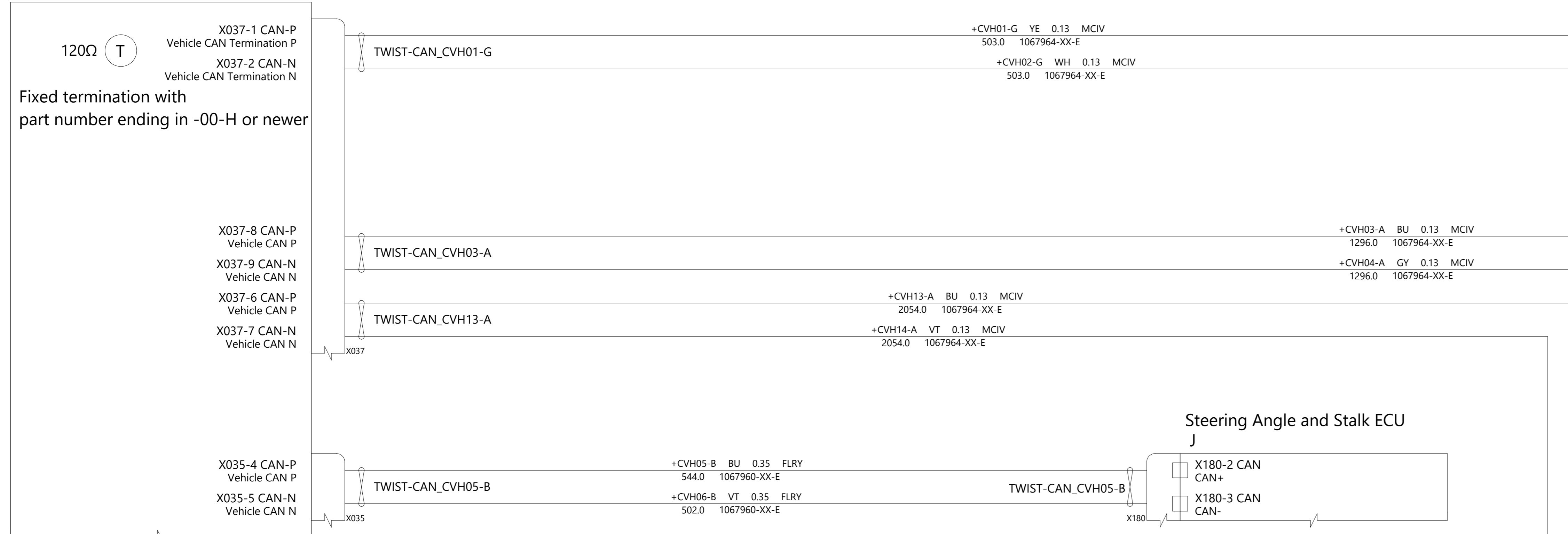

HV Compressor
U,W

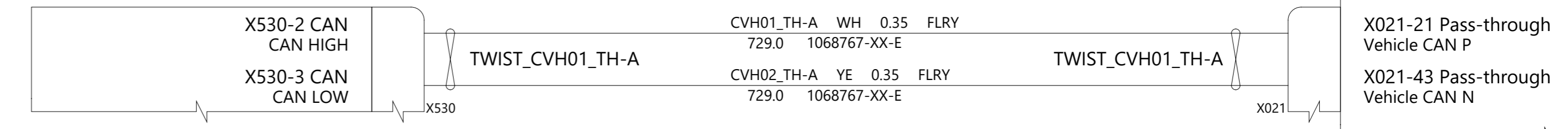

Body Controller Front
W,U

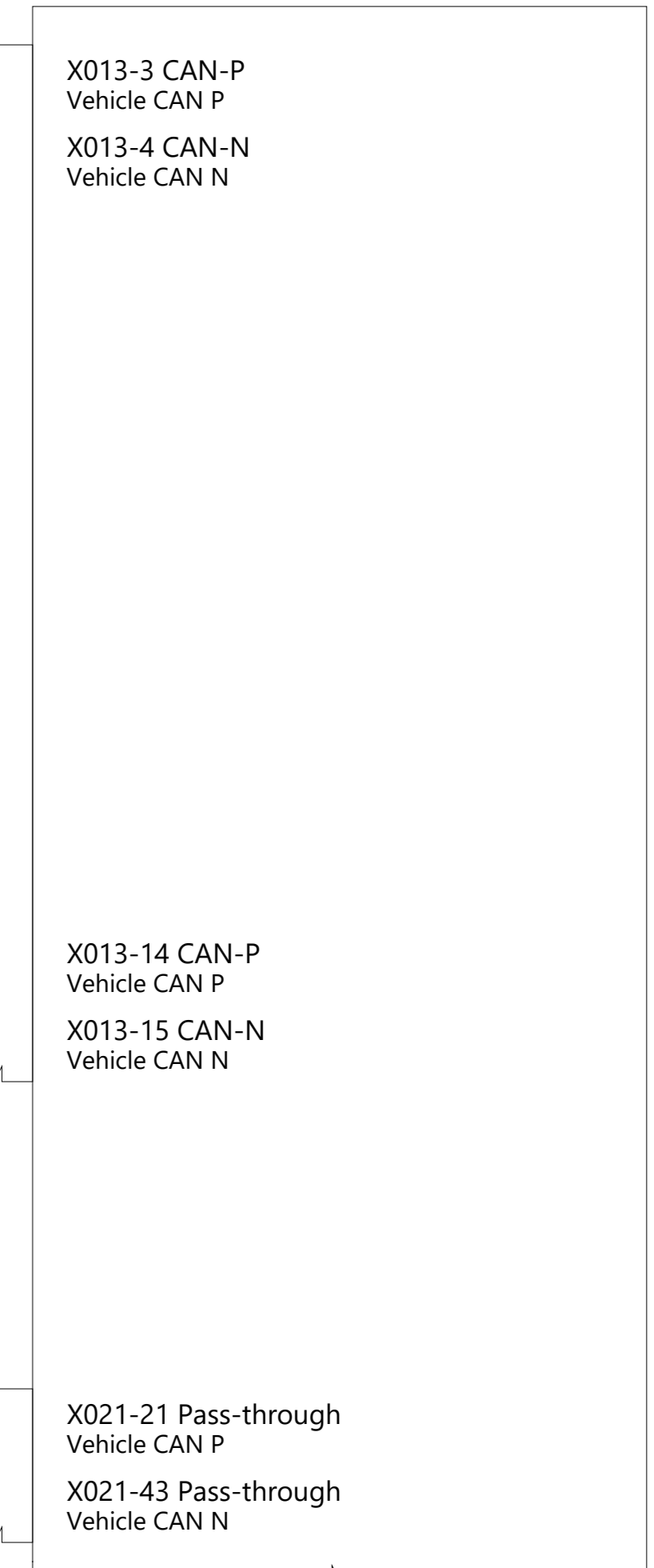

MCU
W,B

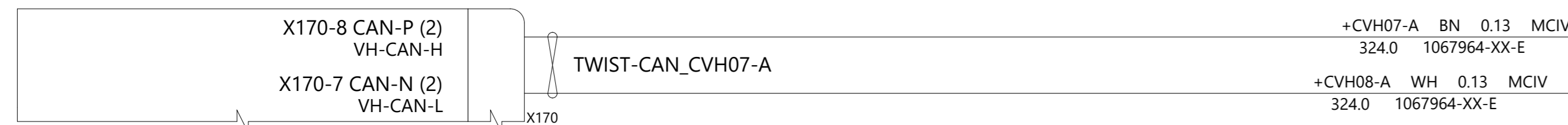

Autopilot ECU
W,J,B

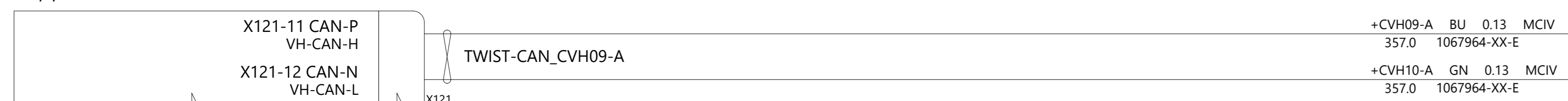

PTC Heater
J,W

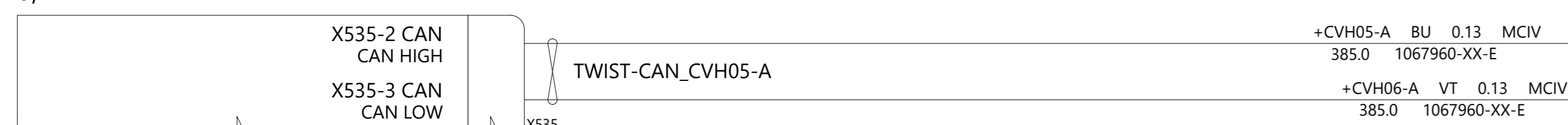

Body Controller Right
B,P,J,W

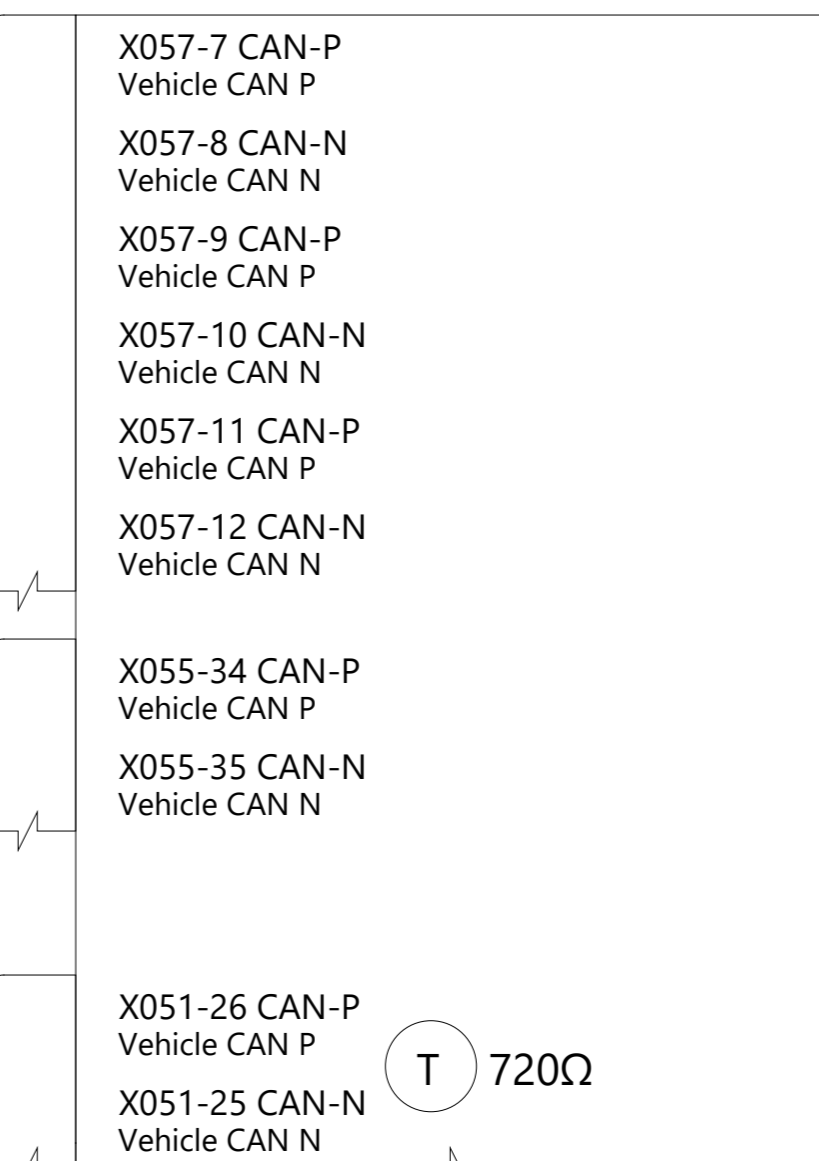

Fixed termination with part number ending in -00-G or newer

Drive Inverter Rear & Resolver
X

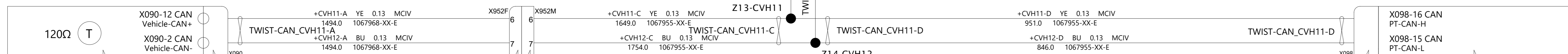

HV Battery
B



THE INFORMATION CONTAINED HEREIN IS DEEMED TO BE CONFIDENTIAL, PROPRIETARY, AND A TRADE SECRET OF TESLA MOTORS. THIS INFORMATION MAY NOT BE USED, REPRODUCED, OR DISCLOSED AS THE DIRECT OR INDIRECT BASIS FOR THE DEVELOPMENT, MANUFACTURE, OR SALE OF PROCESSES OR PRODUCTS WITHOUT THE EXPRESS WRITTEN CONSENT OF TESLA MOTORS.

DRAWN		CHECKED		APPROVED	
MATERIAL AS SPECIFIED		FINISHING AS SPECIFIED		SCALE NONE	
PART NAME CAN Vehicle					
PART NUMBER		REV	SHEET	SIZE	
		2	14 of 30	A0	

Body Controller Left
A,D,J,W,K

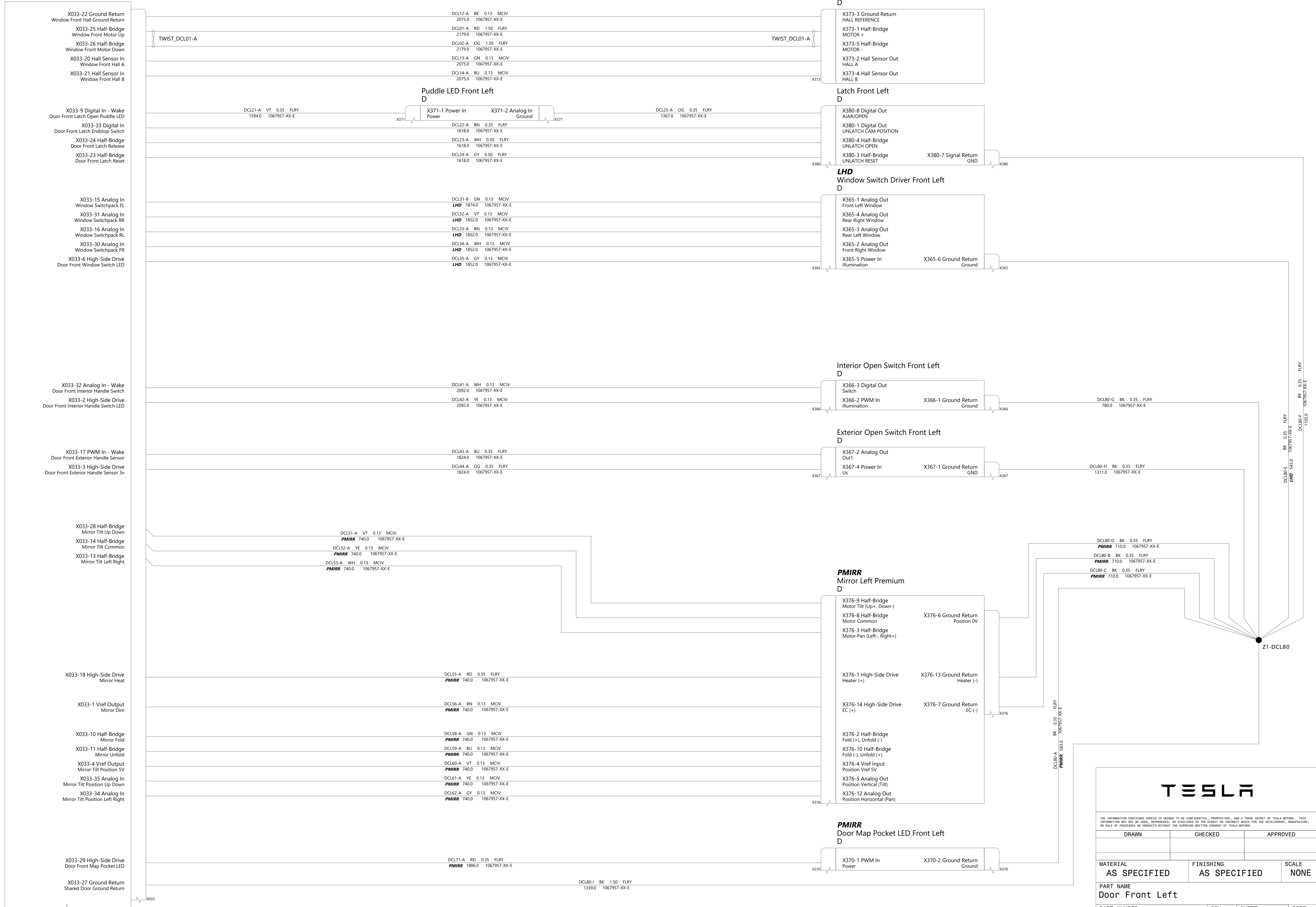

THE INFORMATION CONTAINED HEREIN IS DEEMED TO BE CONFIDENTIAL, PROPRIETARY, AND A TRADE SECRET OF TESLA MOTORS. THIS INFORMATION MAY NOT BE USED, REPRODUCED, OR DISCLOSED AS THE OBJECT OR INSTRUMENT BASIS FOR THE DEVELOPMENT, MANUFACTURE, OR SALE OF PROCESSES OR PRODUCTS WITHOUT THE EXPRESS WRITTEN CONSENT OF TESLA MOTORS.

DRAWN		CHECKED		APPROVED	
MATERIAL AS SPECIFIED		FINISHING AS SPECIFIED		SCALE NONE	
PART NAME Door Front Left					
PART NUMBER		REV	SHEET	SIZE	
		2	15 of 30	A0	

Body Controller Right
B,P,J,W

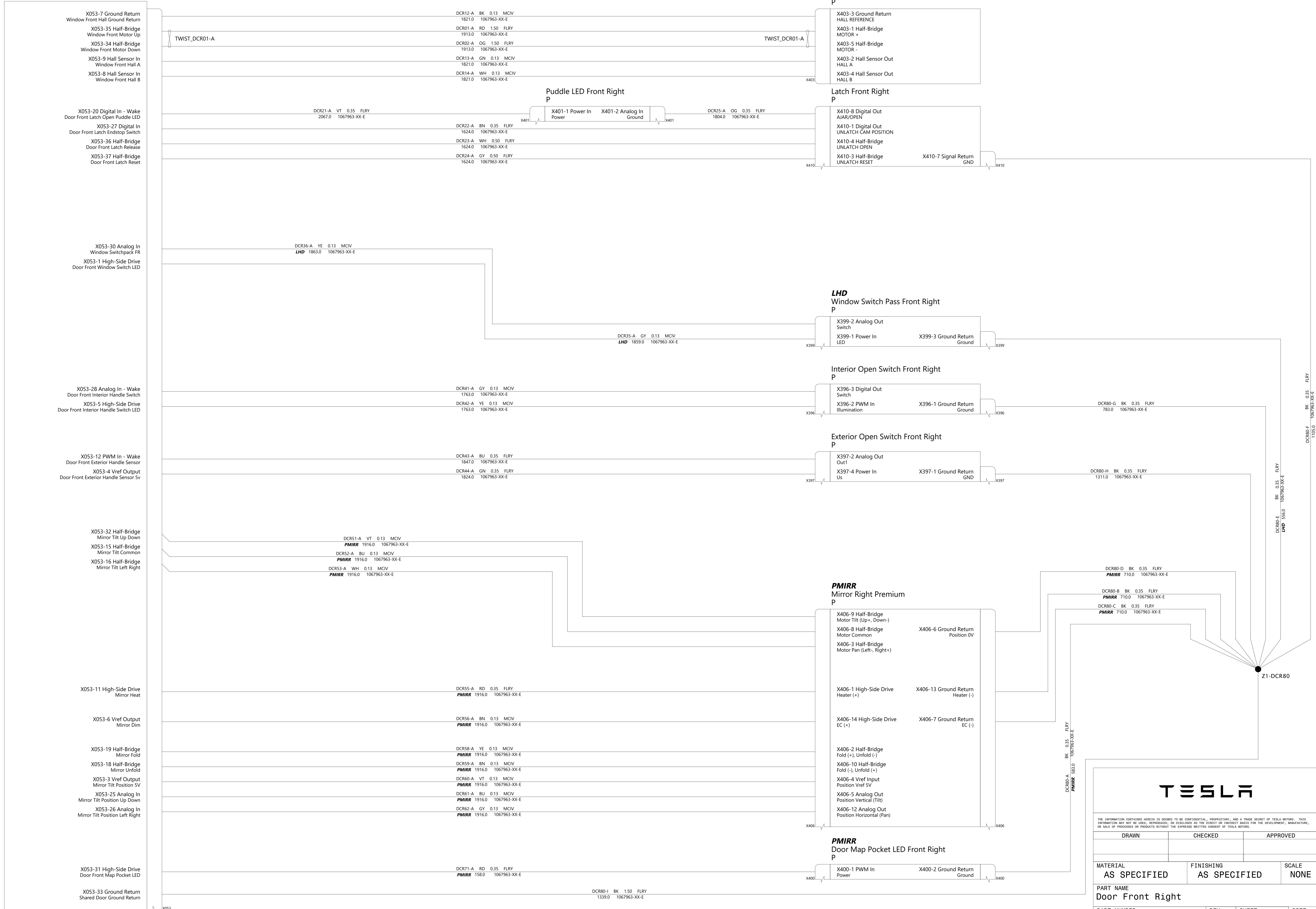

THE INFORMATION CONTAINED HEREIN IS DEEMED TO BE CONFIDENTIAL, PROPRIETARY, AND A TRADE SECRET OF TESLA MOTORS. THIS INFORMATION MAY NOT BE USED, REPRODUCED, OR DISCLOSED AS THE DIRECT OR INDIRECT BASIS FOR THE DEVELOPMENT, MANUFACTURE, OR SALE OF PROCESSES OR PRODUCTS WITHOUT THE EXPRESSED WRITTEN CONSENT OF TESLA MOTORS.

DRAWN	CHECKED	APPROVED
MATERIAL AS SPECIFIED	FINISHING AS SPECIFIED	SCALE NONE
PART NAME Door Front Right		
PART NUMBER	REV	SHEET
	2	16 of 30
		SIZE A0

Body Controller Left
A,D,J,W,K

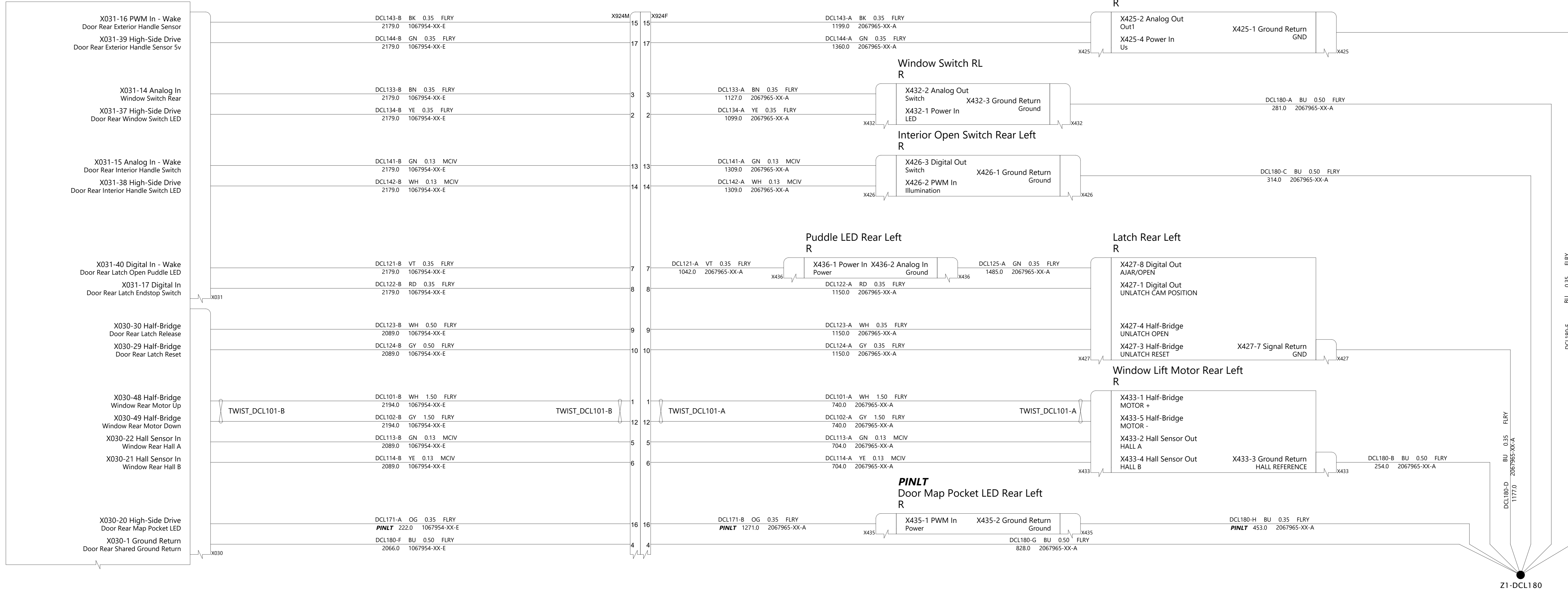

Body Controller Right
B,P,J,W

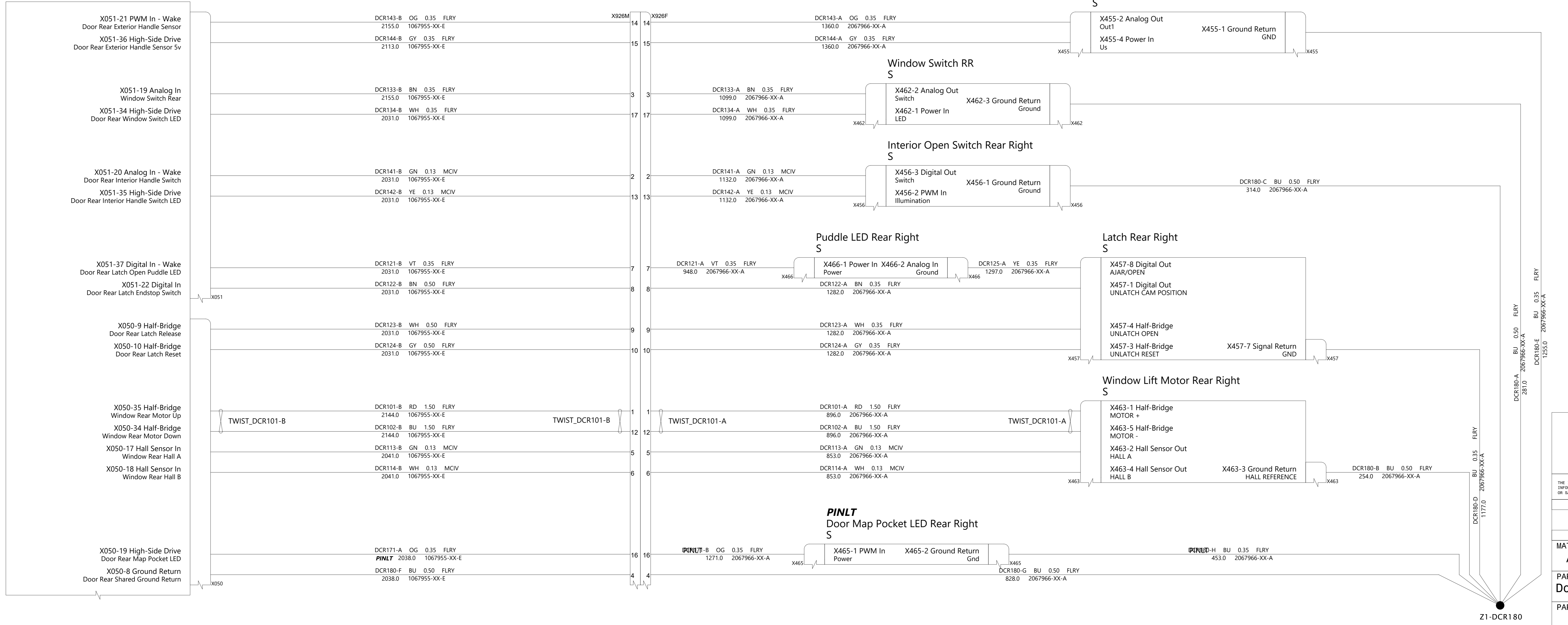

THE INFORMATION CONTAINED HEREIN IS DEEMED TO BE CONFIDENTIAL, PROPRIETARY, AND A TRADE SECRET OF TESLA MOTORS. THIS INFORMATION MAY NOT BE USED, REPRODUCED, OR DISCLOSED AS THE DIRECT OR INDIRECT BASIS FOR THE DEVELOPMENT, MANUFACTURE, OR SALE OF PROCESSES OR PRODUCTS WITHOUT THE EXPRESSED WRITTEN CONSENT OF TESLA MOTORS.

DRAWN	CHECKED	APPROVED
MATERIAL AS SPECIFIED	FINISHING AS SPECIFIED	SCALE NONE
PART NAME Doors Rear		
PART NUMBER	REV	SHEET
	2	17 OF 30
		SIZE A0

AWD
Drive Inverter Front & Resolver
N

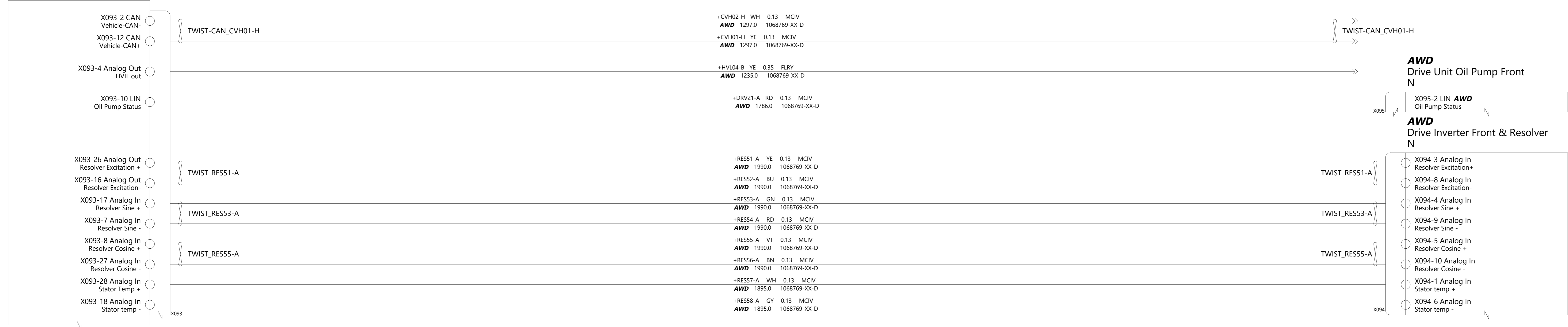

AWD
Drive Unit Oil Pump Front
N



AWD
Drive Inverter Front & Resolver
N

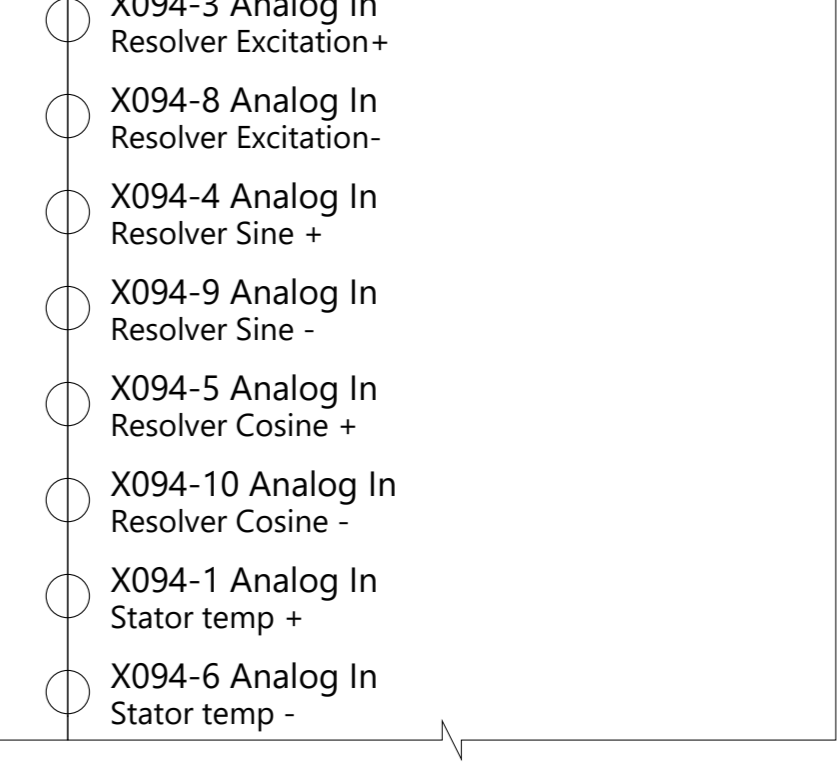

Drive Inverter Rear & Resolver
X



Accel Pedal Sensor
A

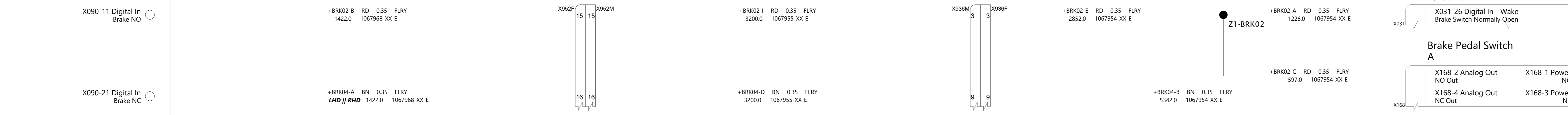
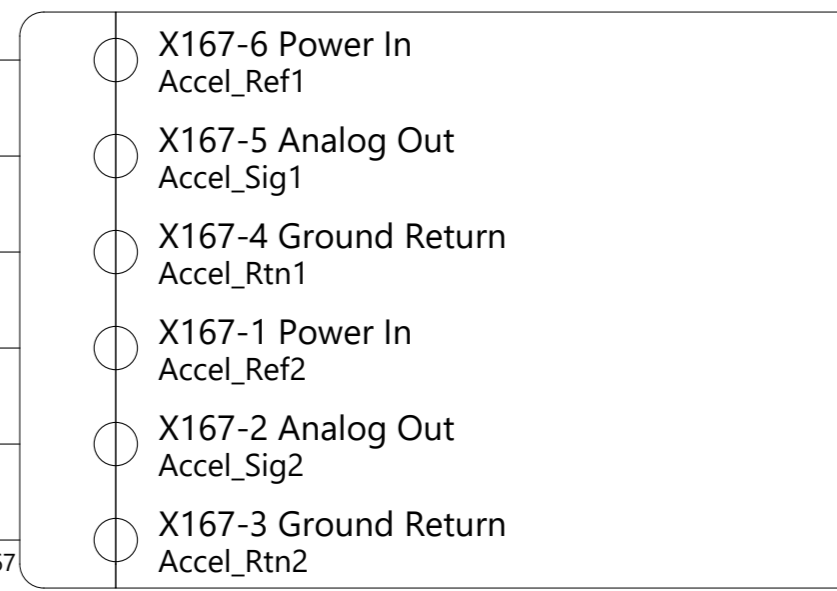

Body Controller Left
A,D,J,W,K



Brake Pedal Switch
A

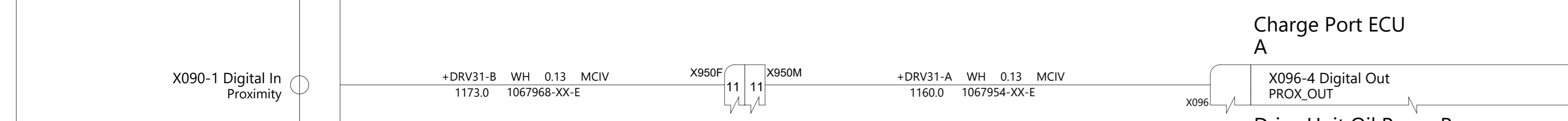
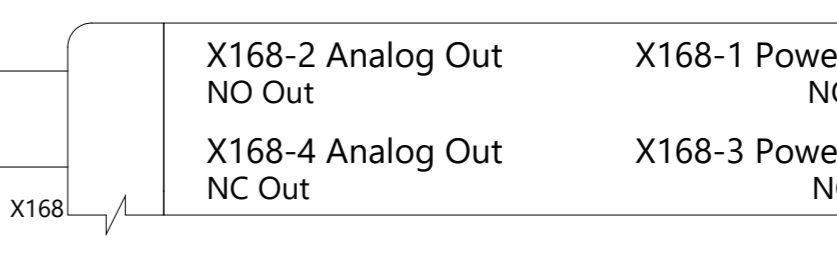

Charge Port ECU
A

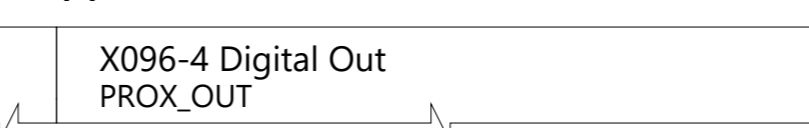

Drive Unit Oil Pump Rear
X

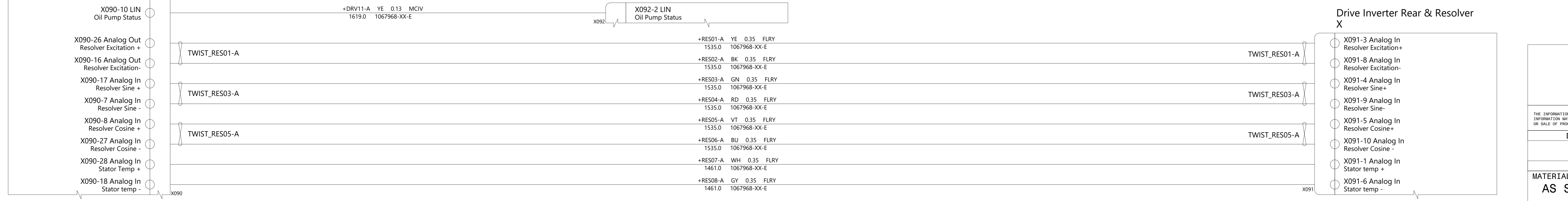

Drive Inverter Rear & Resolver
X

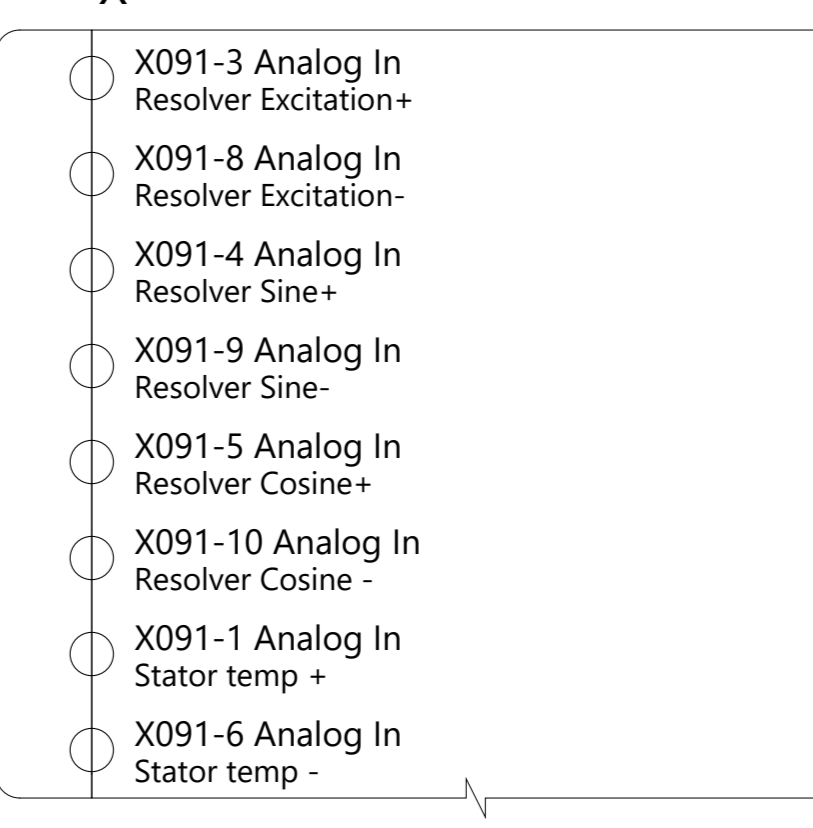

THE INFORMATION CONTAINED HEREIN IS DEEMED TO BE CONFIDENTIAL, PROPRIETARY, AND A TRADE SECRET OF TESLA MOTORS. THIS INFORMATION MAY NOT BE USED, REPRODUCED, OR DISCLOSED AS THE DIRECT OR INDIRECT BASIS FOR THE DEVELOPMENT, MANUFACTURE, OR SALE OF PROCESSES OR PRODUCTS WITHOUT THE EXPRESS WRITTEN CONSENT OF TESLA MOTORS.

DRAWN	CHECKED	APPROVED
MATERIAL AS SPECIFIED	FINISHING AS SPECIFIED	SCALE NONE
PART NAME Drive Inverters		
PART NUMBER	REV	SHEET
	2	18 of 30
		SIZE A0

A B C D E F G H I J K

A B C D E F G H I J K

B C D E F G H I J K

C D E F G H I J K

D E F G H I J K

E F G H I J K

F G H I J K

A B C D E F G H I J K

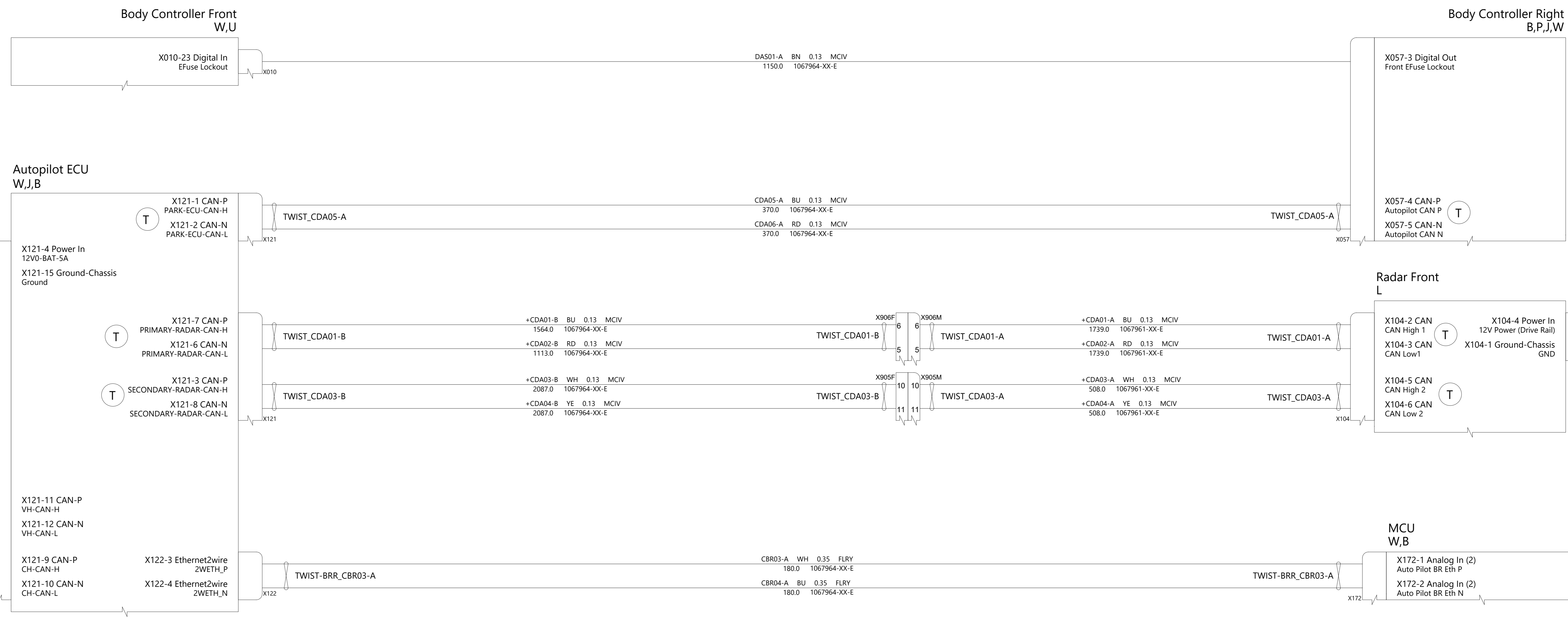

TESLA

THE INFORMATION CONTAINED HEREIN IS DEEMED TO BE CONFIDENTIAL, PROPRIETARY, AND A TRADE SECRET OF TESLA MOTORS. THIS INFORMATION MAY NOT BE USED, REPRODUCED, OR DISCLOSED AS THE DIRECT OR INDIRECT BASIS FOR THE DEVELOPMENT, MANUFACTURE, OR SALE OF PROCESSES OR PRODUCTS WITHOUT THE EXPRESSED WRITTEN CONSENT OF TESLA MOTORS.

DRAWN	CHECKED	APPROVED
-------	---------	----------

MATERIAL AS SPECIFIED	FINISHING AS SPECIFIED	SCALE NONE
--------------------------	---------------------------	---------------

PART NAME
Driver Assistance

PART NUMBER	REV	SHEET	SIZE
	2	19 of 30	A0

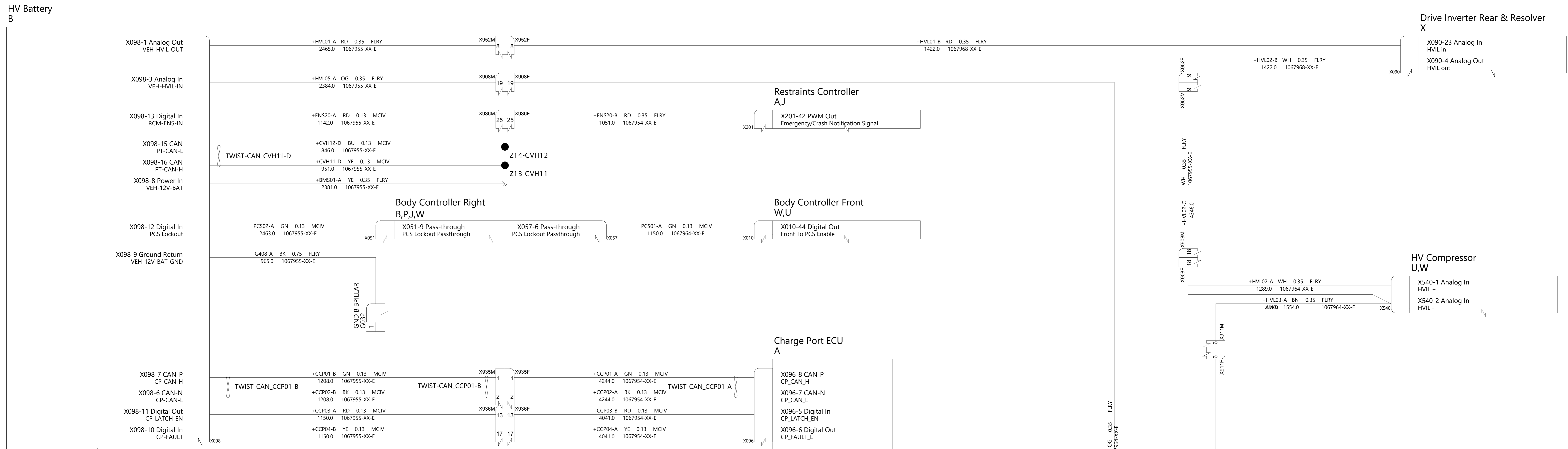

Charge Port Inlet, SAE E

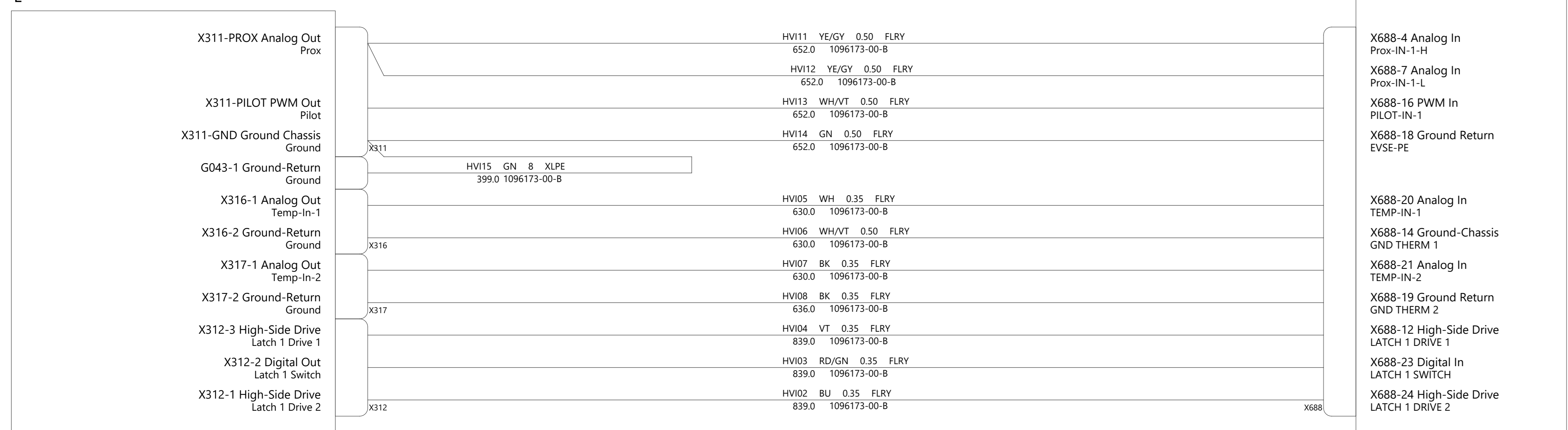

Charge Port Door



THE INFORMATION CONTAINED HEREIN IS DEEMED TO BE CONFIDENTIAL, PROPRIETARY, AND A TRADE SECRET OF TESLA MOTORS. THIS INFORMATION MAY NOT BE USED, REPRODUCED, OR DISCLOSED AS THE DIRECT OR INDIRECT BASIS FOR THE DEVELOPMENT, MANUFACTURE, OR SALE OF PROCESSES OR PRODUCTS WITHOUT THE EXPRESSED WRITTEN CONSENT OF TESLA MOTORS.

DRAWN	CHECKED	APPROVED
MATERIAL AS SPECIFIED	FINISHING AS SPECIFIED	SCALE NONE
PART NAME HV Battery and HVIL		
PART NUMBER	REV	SHEET
	2	20 OF 30
		SCALE A0

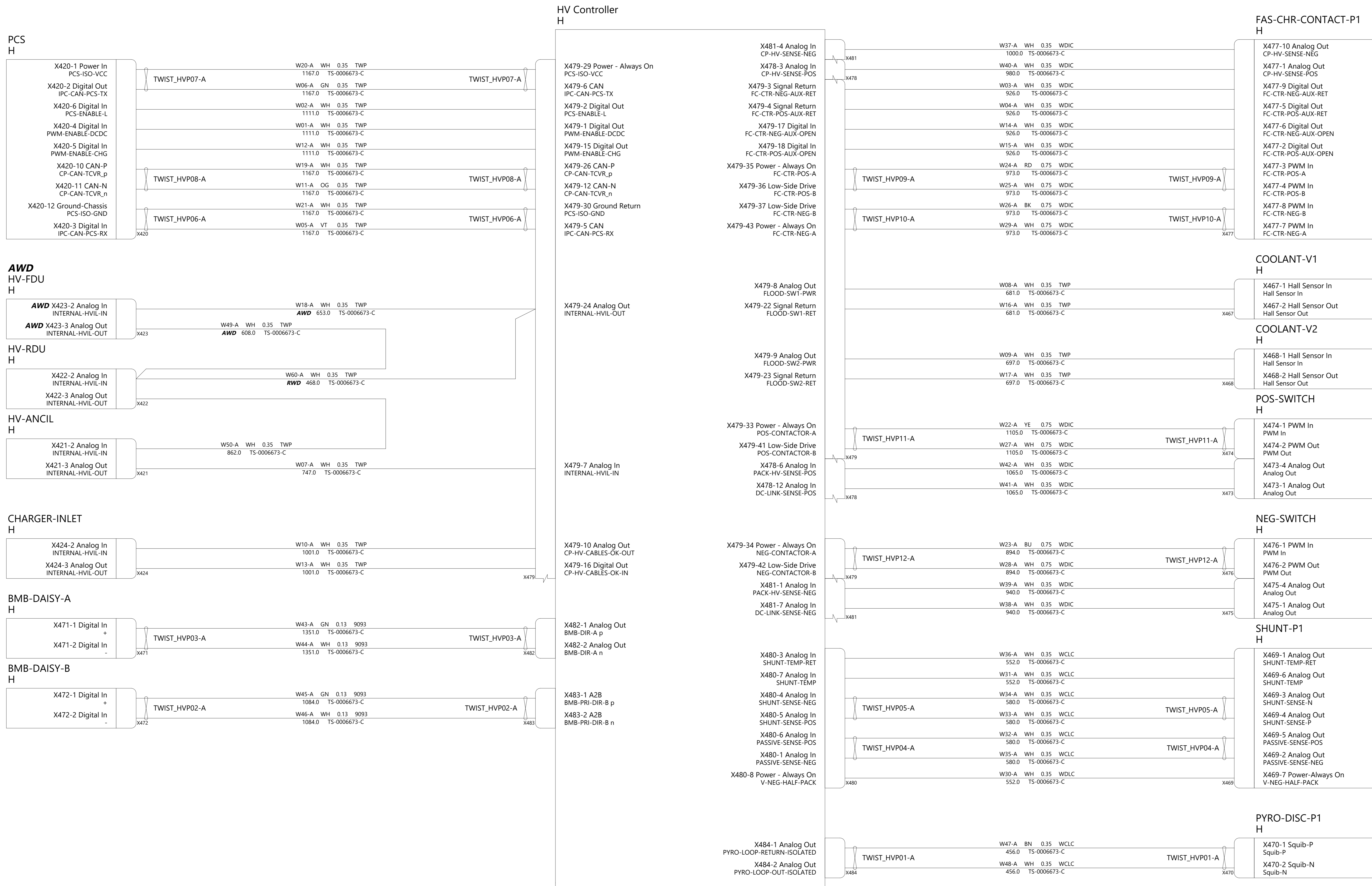

THE INFORMATION CONTAINED HEREIN IS DEEMED TO BE CONFIDENTIAL, PROPRIETARY, AND A TRADE SECRET OF TESLA MOTORS. THIS INFORMATION MAY NOT BE USED, REPRODUCED, OR DISCLOSED AS THE DIRECT OR INDIRECT BASIS FOR THE DEVELOPMENT, MANUFACTURE, OR SALE OF PROCESSES OR PRODUCTS WITHOUT THE EXPRESSED WRITTEN CONSENT OF TESLA MOTORS.

DRAWN	CHECKED	APPROVED
MATERIAL AS SPECIFIED	FINISHING AS SPECIFIED	SCALE NONE
PART NAME HV Penthouse		
PART NUMBER	REV	SHEET
	2	21 of 30
		SIZE A0

Body Controller Right
B,P,J,W

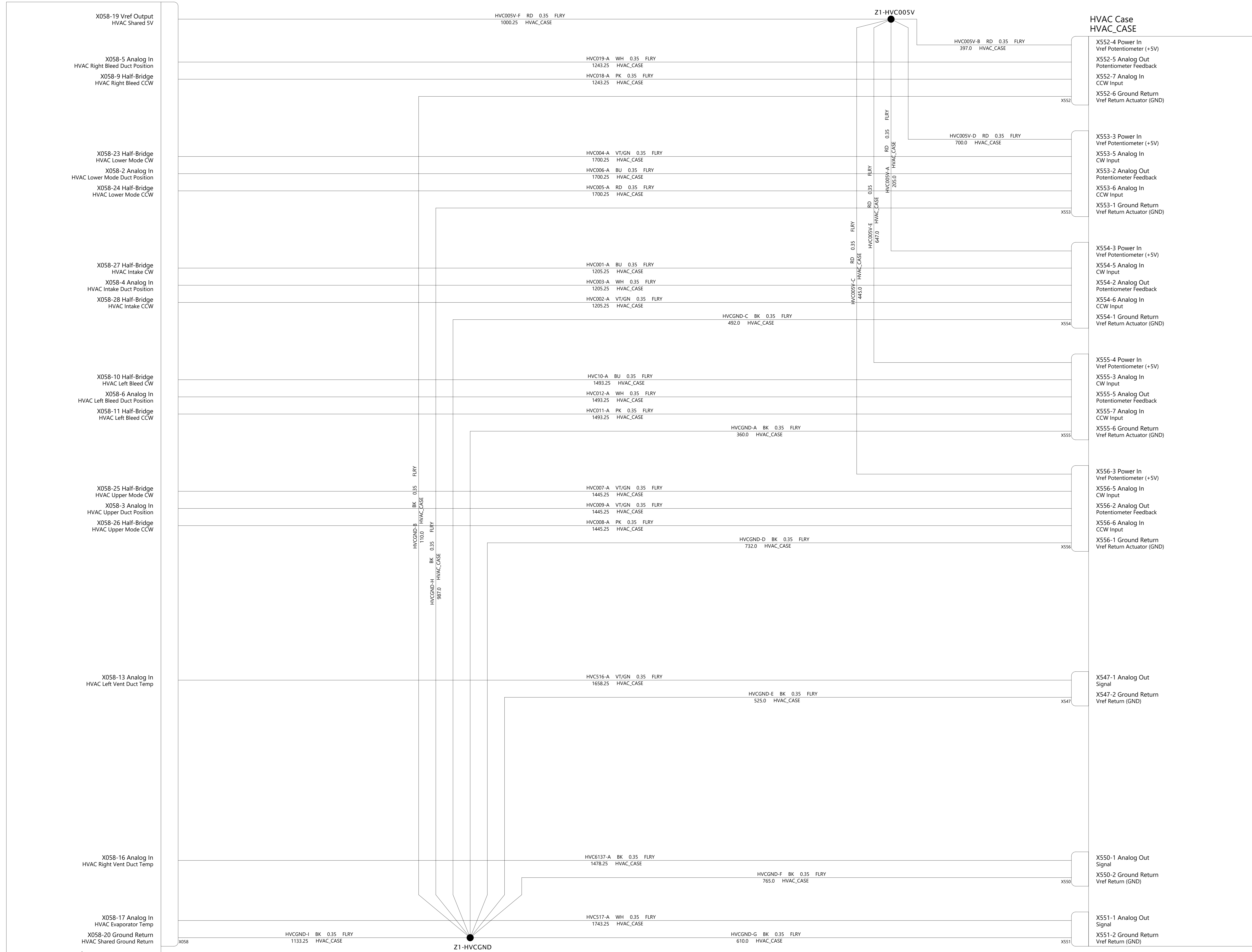

HVAC Case
HVAC_CASE

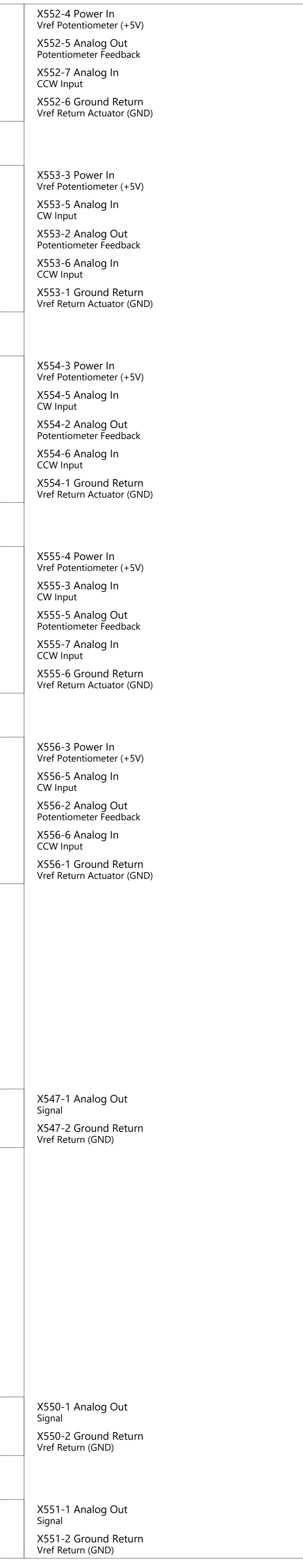

Body Controller Left
A,D,J,W,K

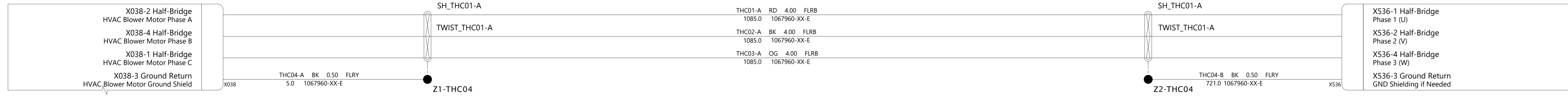

Blower Motor
J

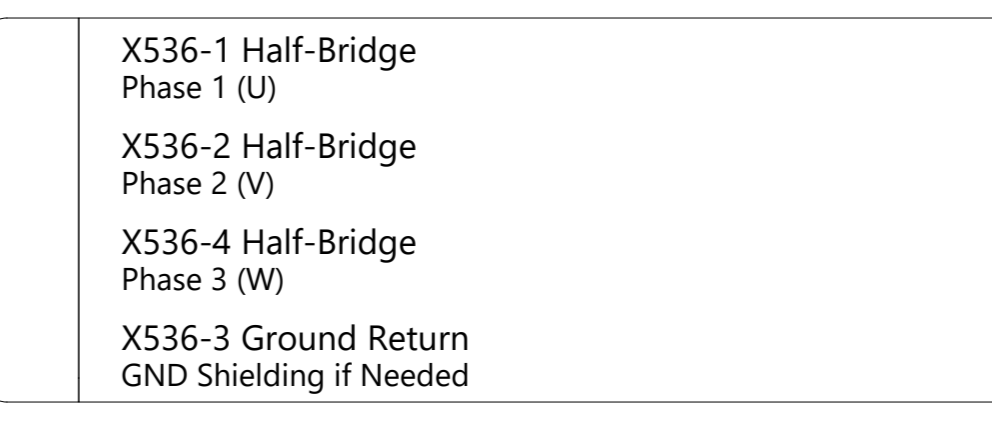

THE INFORMATION CONTAINED HEREIN IS DEEMED TO BE CONFIDENTIAL, PROPRIETARY, AND A TRADE SECRET OF TESLA MOTORS. THIS INFORMATION MAY NOT BE USED, REPRODUCED, OR DISCLOSED AS THE DIRECT OR INDIRECT BASIS FOR THE DEVELOPMENT, MANUFACTURE, OR SALE OF PROCESSES OR PRODUCTS WITHOUT THE EXPRESS WRITTEN CONSENT OF TESLA MOTORS.

DRAWN	CHECKED	APPROVED
MATERIAL AS SPECIFIED	FINISHING AS SPECIFIED	SCALE NONE
PART NAME HVAC Case Subassembly		
PART NUMBER	REV	SHEET
	2	22 of 30
		SCALE A0

Body Controller Front
W,U

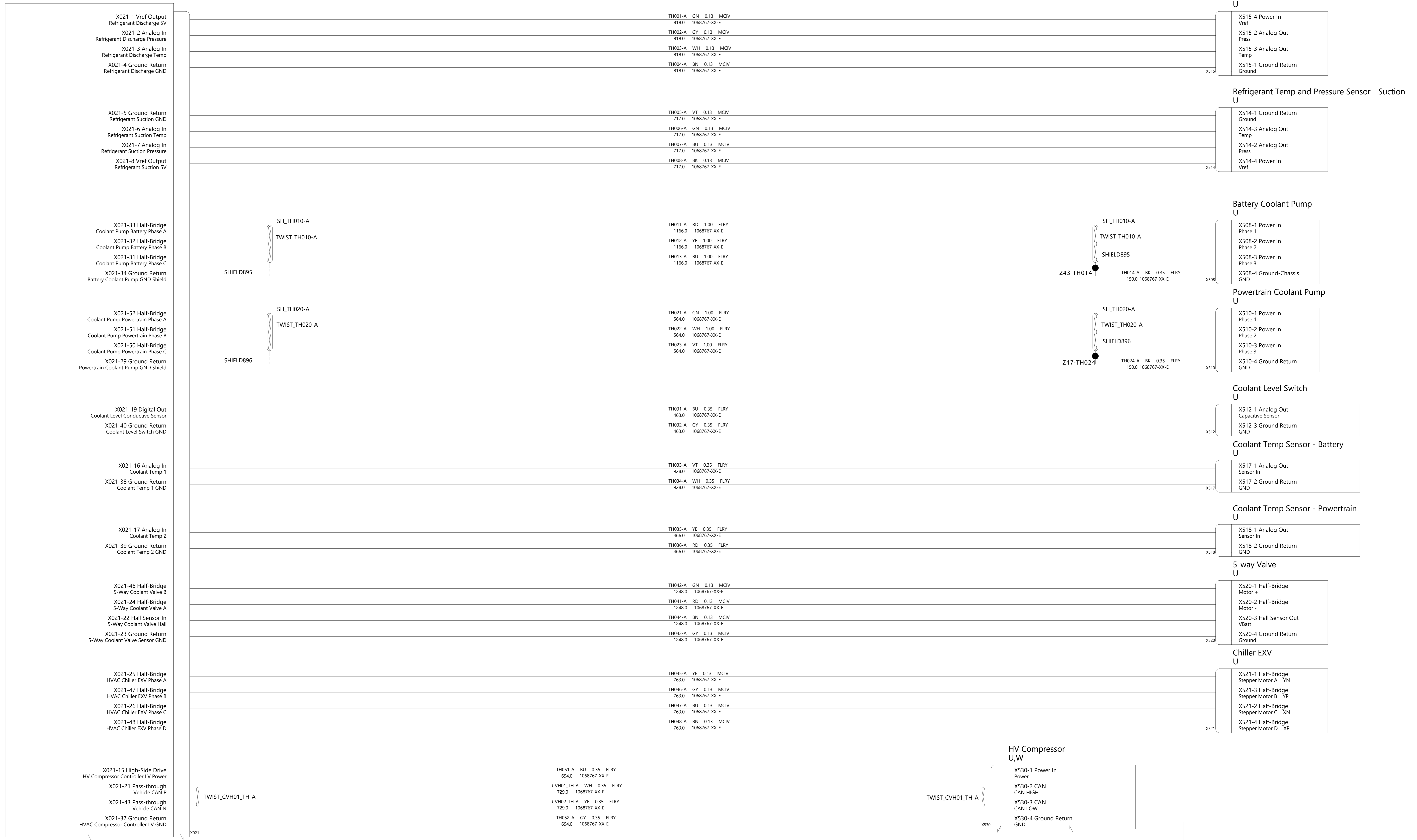

Refrigerant Temp and Pressure Sensor - Discharge U

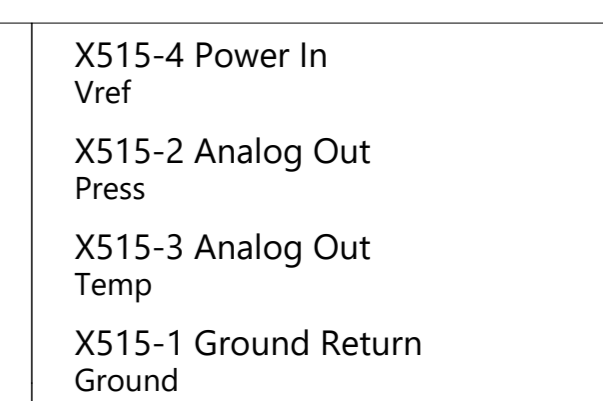

Refrigerant Temp and Pressure Sensor - Suction U

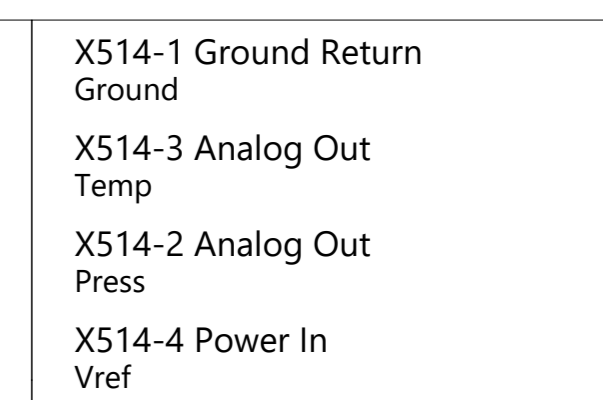

Battery Coolant Pump U

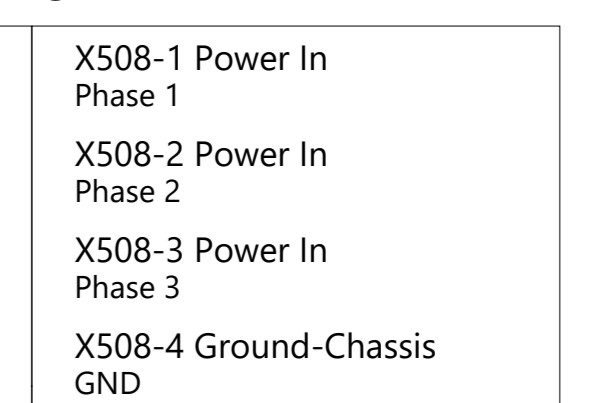

Powertrain Coolant Pump U

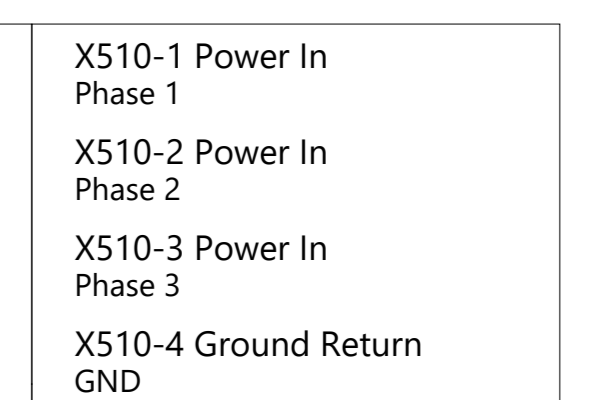

Coolant Level Switch U

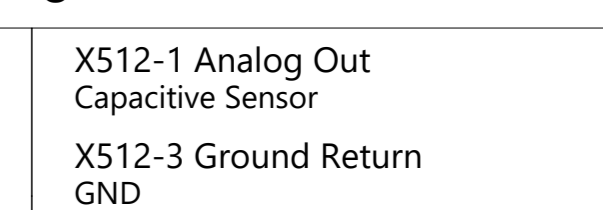

Coolant Temp Sensor - Battery U

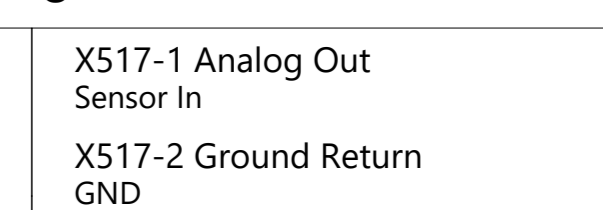

Coolant Temp Sensor - Powertrain U

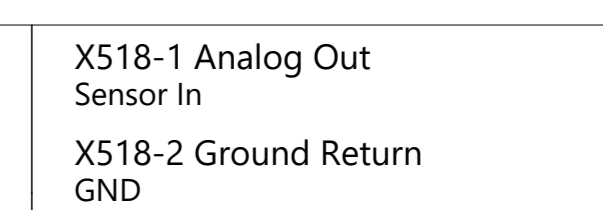

5-way Valve U

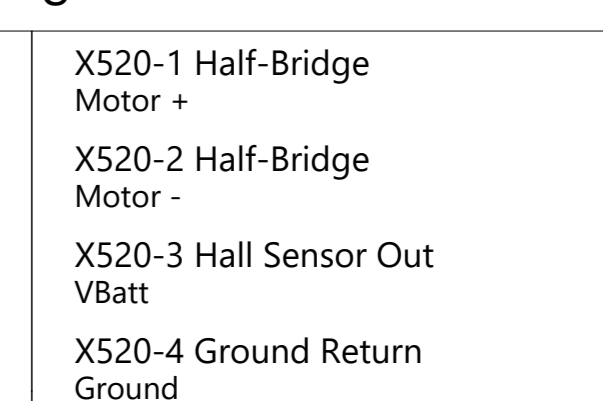

Chiller EXV U

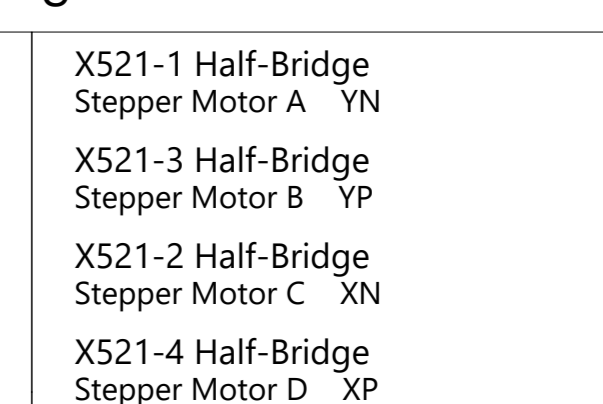

HV Compressor U,W

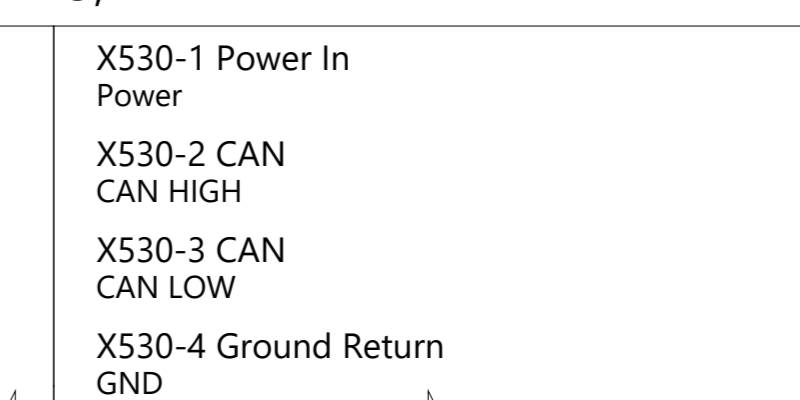

HV Compressor U,W



THE INFORMATION CONTAINED HEREIN IS DEEMED TO BE CONFIDENTIAL, PROPRIETARY, AND A TRADE SECRET OF TESLA MOTORS. THIS INFORMATION MAY NOT BE USED, REPRODUCED, OR DISCLOSED AS THE DIRECT OR INDIRECT BASIS FOR THE DEVELOPMENT, MANUFACTURE, OR SALE OF PROCESSES OR PRODUCTS WITHOUT THE EXPRESSED WRITTEN CONSENT OF TESLA MOTORS.

DRAWN	CHECKED	APPROVED
-------	---------	----------

MATERIAL AS SPECIFIED	FINISHING AS SPECIFIED	SCALE NONE
--------------------------	---------------------------	---------------

PART NAME HVAC Thermal Subassembly			
---------------------------------------	--	--	--

PART NUMBER	REV 2	SHEET 23 OF 30	SIZE A0
-------------	----------	-------------------	------------

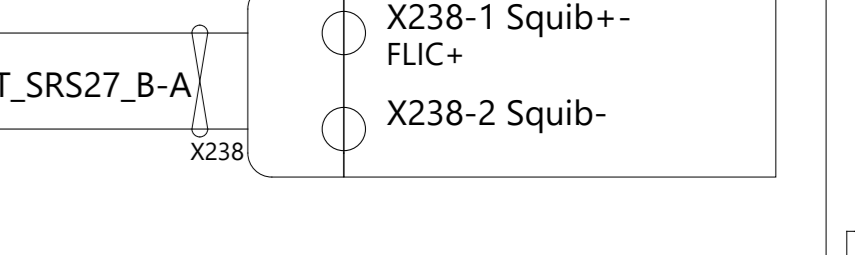
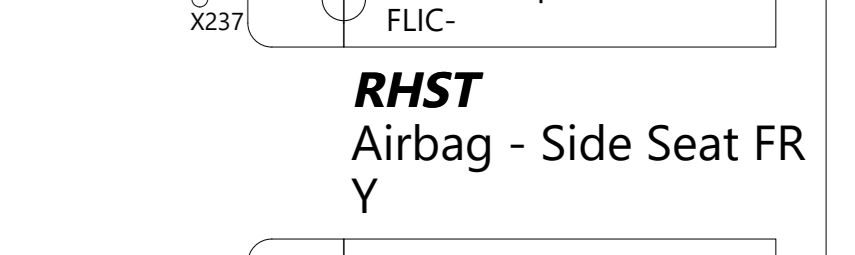
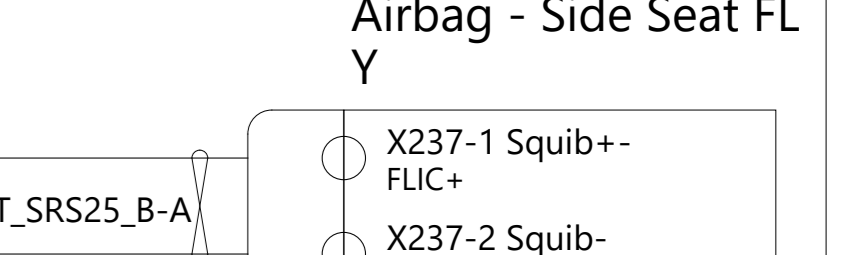
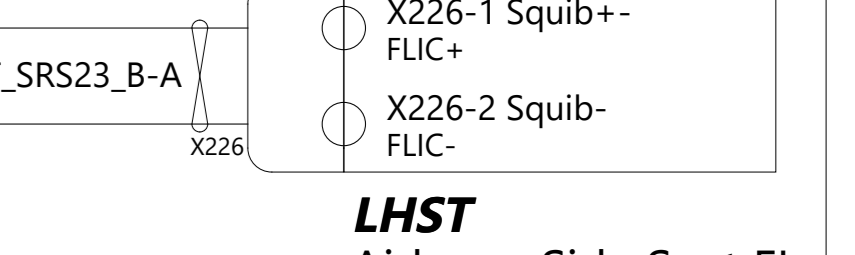
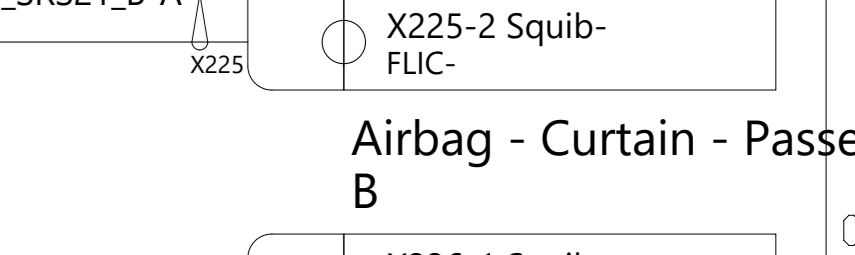
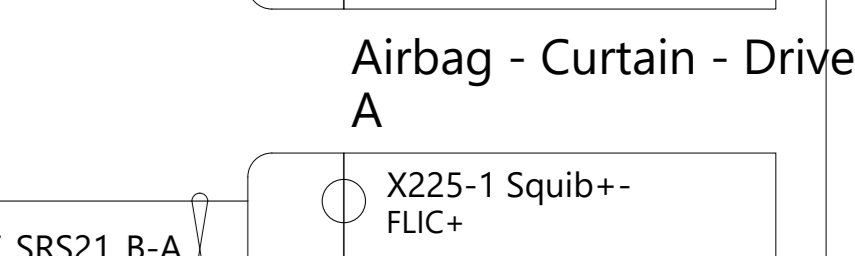
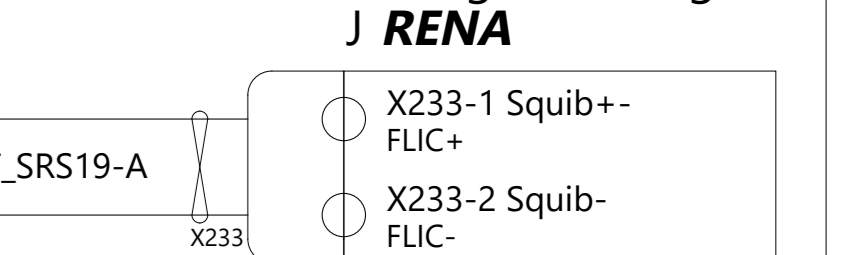
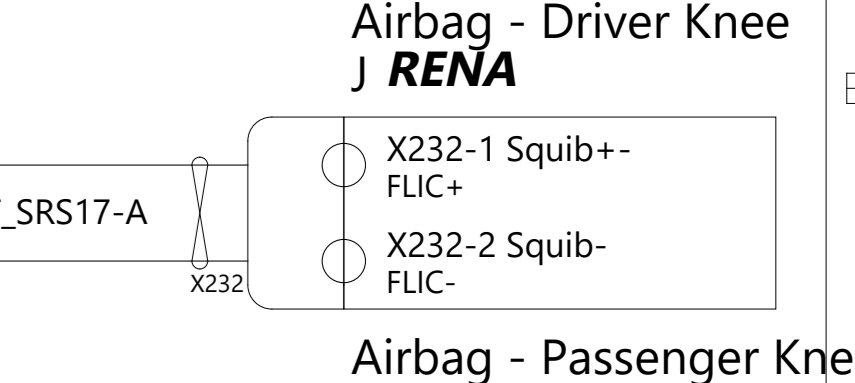
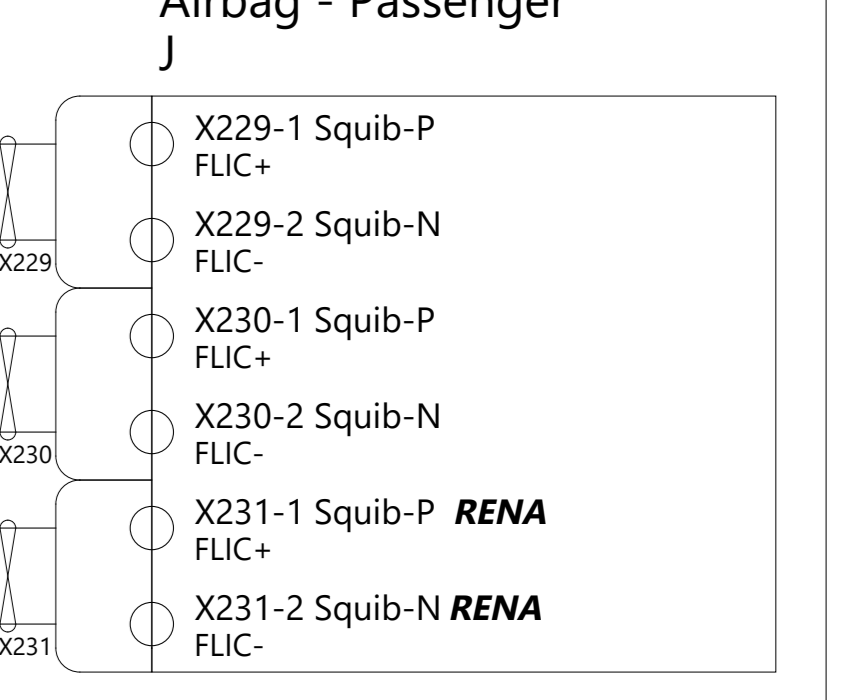
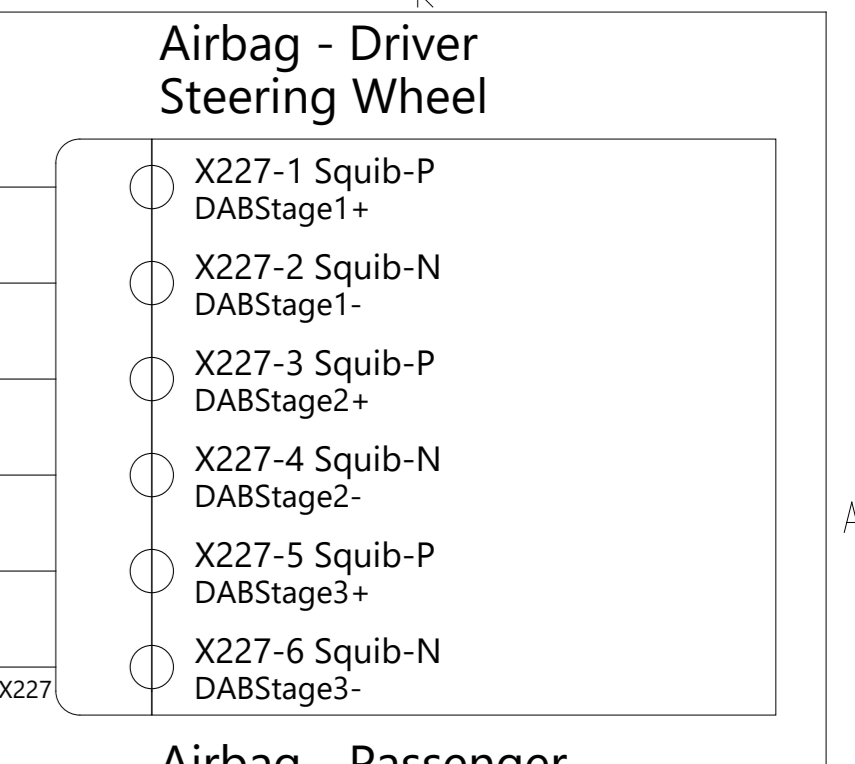
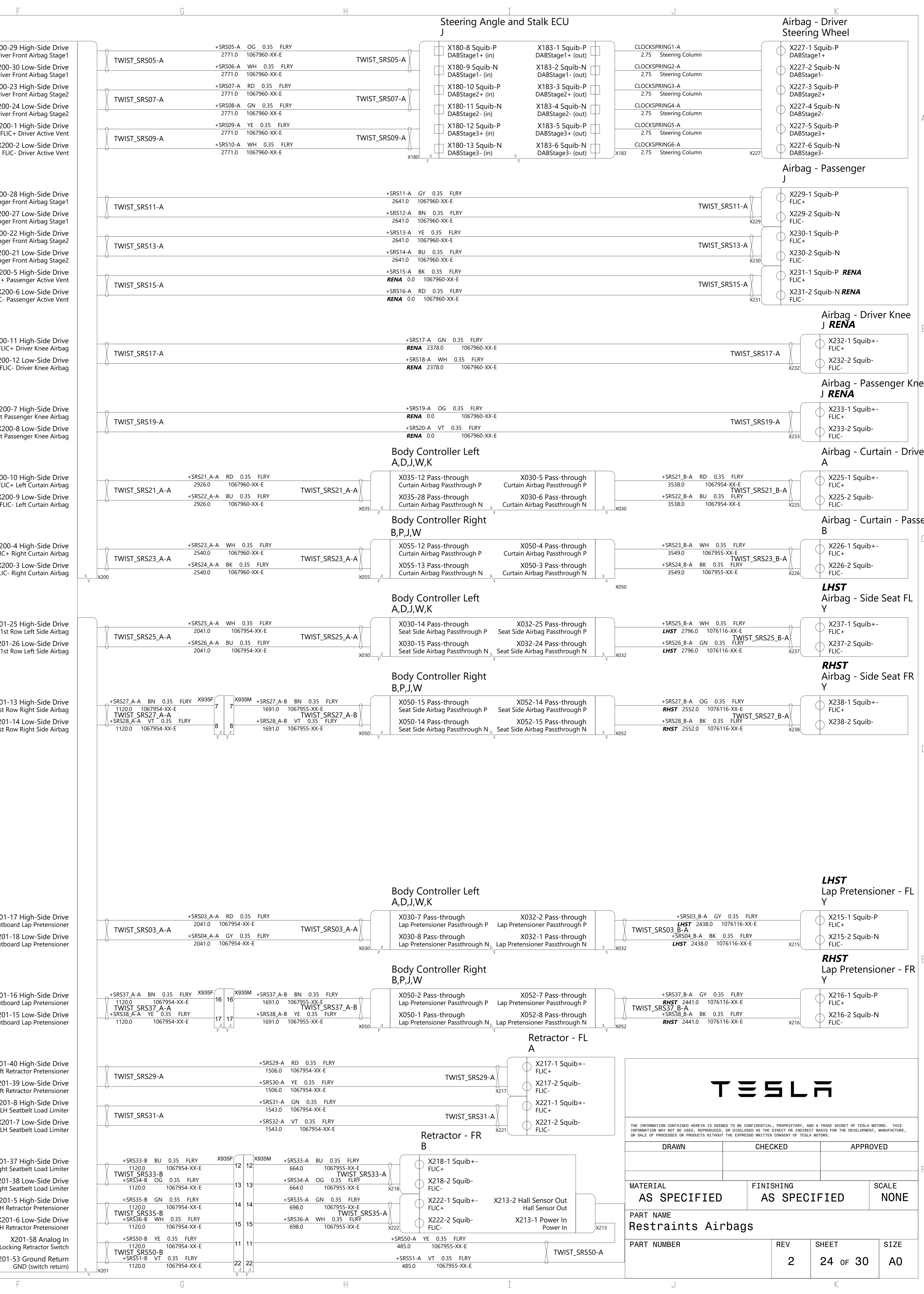
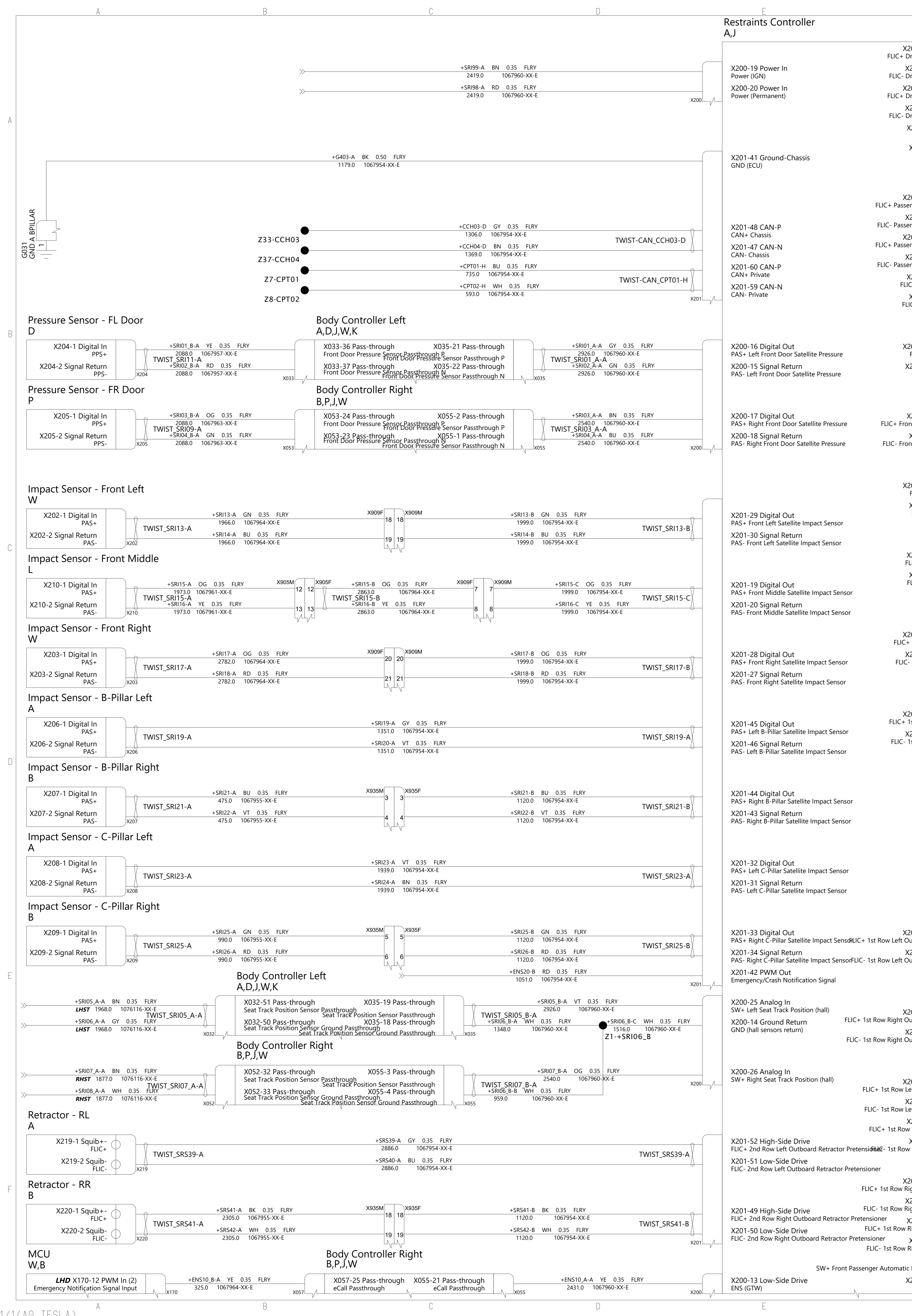

TESLA

THE INFORMATION CONTAINED HEREIN IS DEEMED TO BE CONFIDENTIAL, PROPRIETARY, AND A TRADE SECRET OF TESLA MOTORS. THIS INFORMATION MAY NOT BE USED, REPRODUCED, OR DISCLOSED AS THE DIRECT OR INDIRECT BASIS FOR THE DEVELOPMENT, MANUFACTURE, OR SALE OF PRODUCTS OR SERVICES WITHOUT THE EXPRESS WRITTEN CONSENT OF TESLA MOTORS.

DRAWN	CHECKED	APPROVED
MATERIAL AS SPECIFIED		FINISHING AS SPECIFIED
PART NAME		SCALE
Restraints Airbags		NONE
PART NUMBER	REV	SHEET
	2	24 OF 30
		SIZE
		A0

MCU
W,B

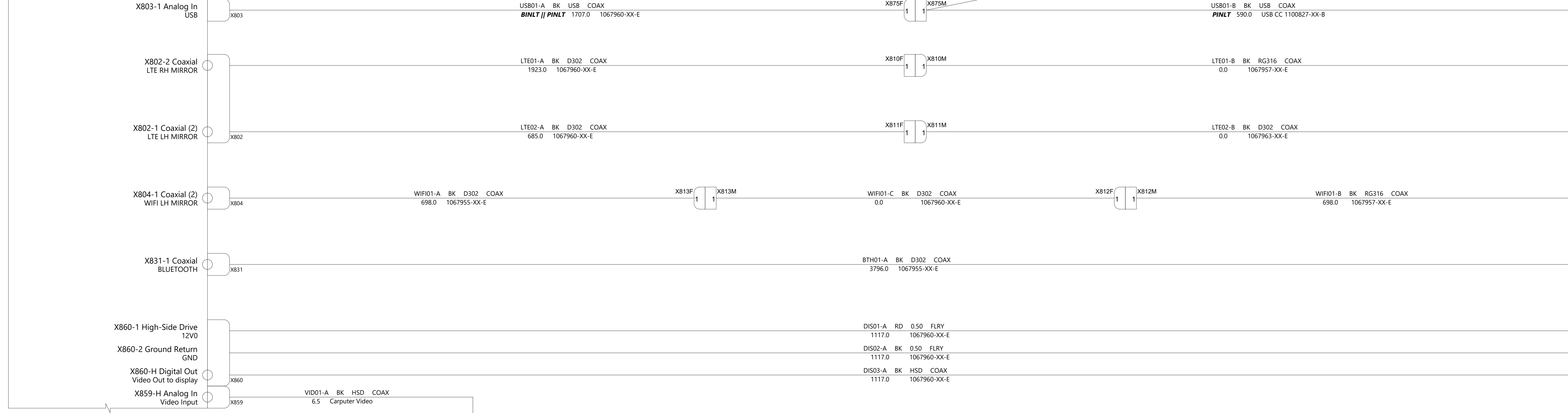

Autopilot ECU
W,J,B

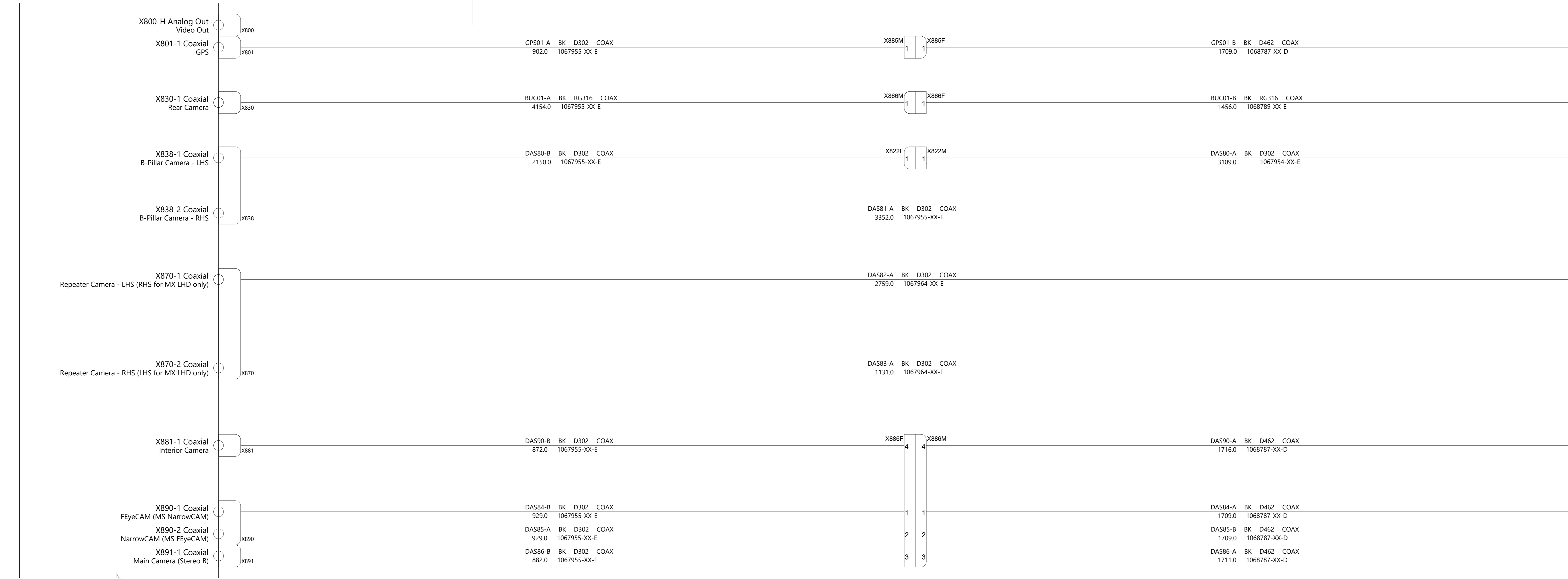

Radio Tuner
B

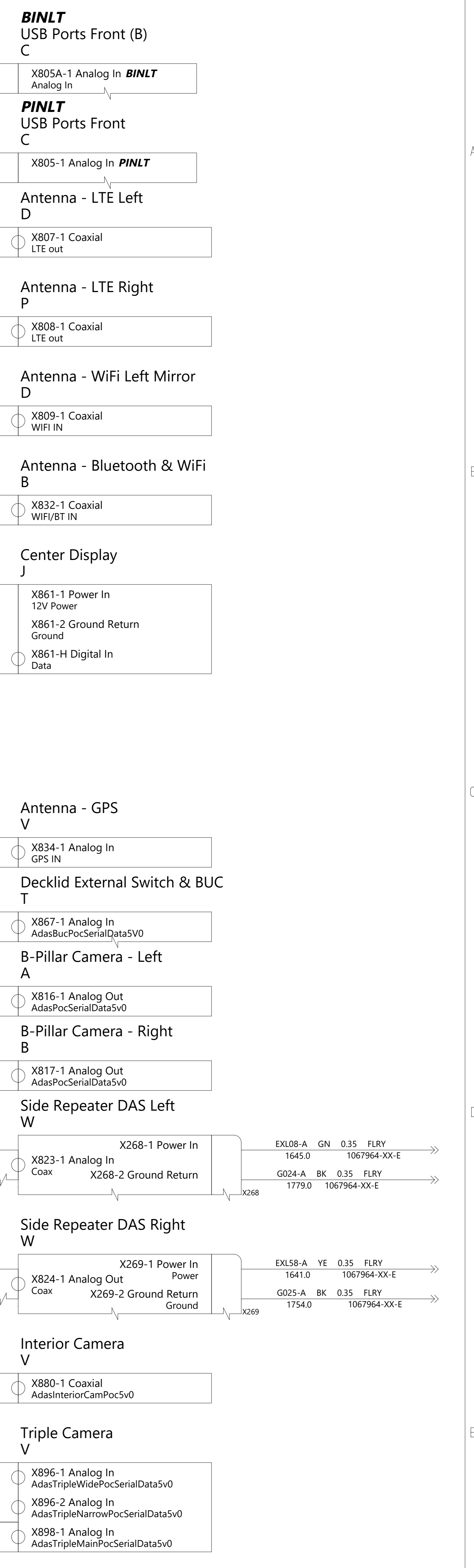
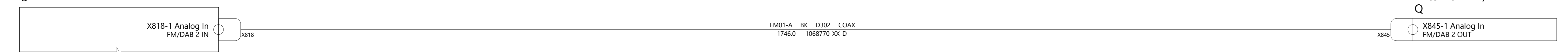

THE INFORMATION CONTAINED HEREIN IS DEEMED TO BE CONFIDENTIAL, PROPRIETARY, AND A TRADE SECRET OF TESLA MOTORS. THIS INFORMATION MAY NOT BE USED, REPRODUCED, OR DISCLOSED AS THE DIRECT OR INDIRECT BASIS FOR THE DEVELOPMENT, MANUFACTURE, OR SALE OF PROCESSES OR PRODUCTS WITHOUT THE EXPRESSED WRITTEN CONSENT OF TESLA MOTORS.

DRAWN	CHECKED	APPROVED
MATERIAL AS SPECIFIED	FINISHING AS SPECIFIED	SCALE NONE
PART NAME RF/Special Cables		
PART NUMBER	REV	SHEET
	2	25 of 30
		SIZE A0

Body Controller Left
A,D,J,W,K

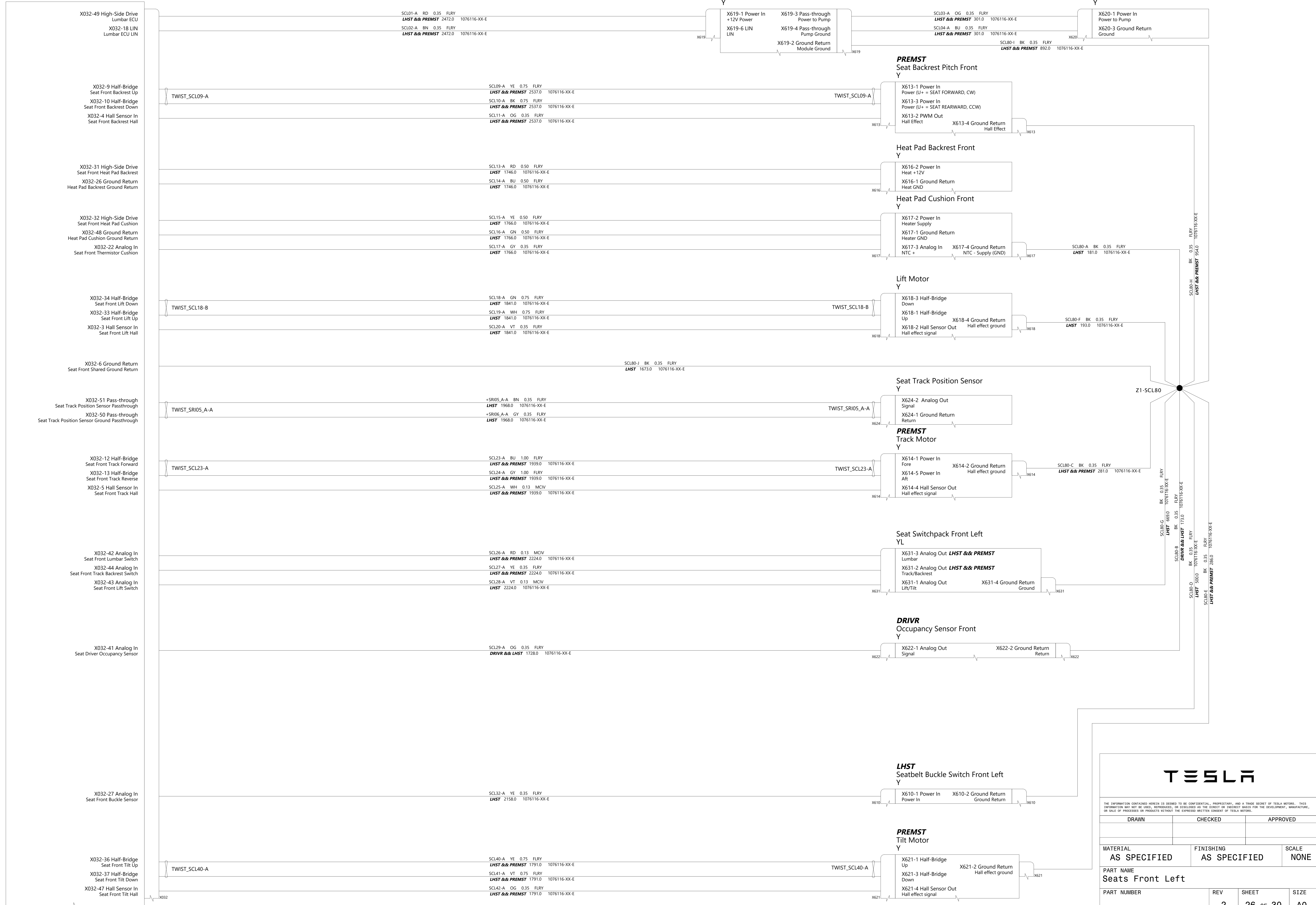

THE INFORMATION CONTAINED HEREIN IS DEEMED TO BE CONFIDENTIAL, PROPRIETARY, AND A TRADE SECRET OF TESLA MOTORS. THIS INFORMATION MAY NOT BE USED, REPRODUCED, OR DISCLOSED AS THE DIRECT OR INDIRECT BASIS FOR THE DEVELOPMENT, MANUFACTURE, OR SALE OF PROCESSES OR PRODUCTS WITHOUT THE EXPRESSED WRITTEN CONSENT OF TESLA MOTORS.

DRAWN	CHECKED	APPROVED
MATERIAL AS SPECIFIED	FINISHING AS SPECIFIED	SCALE NONE
PART NAME Seats Front Left		
PART NUMBER	REV 2	SHEET 26 OF 30
		SIZE A0

Body Controller Right
B,P,J,W

- X052-34 High-Side Drive Lumbar ECU
- X052-21 LIN Lumbar ECU LIN
- X052-30 Half-Bridge Seat Front Backrest Up
- X052-29 Half-Bridge Seat Front Backrest Down
- X052-5 Hall Sensor In Seat Front Backrest Hall
- X052-52 High-Side Drive Seat Front Heat Pad Backrest
- X052-13 Ground Return Heat Pad Backrest Ground Return
- X052-51 High-Side Drive Seat Front Heat Pad Cushion
- X052-35 Ground Return Heat Pad Cushion Ground Return
- X052-17 Analog In Seat Front Thermistor Cushion
- X052-49 Half-Bridge Seat Front Lift Down
- X052-50 Half-Bridge Seat Front Lift Up
- X052-6 Hall Sensor In Seat Front Lift Hall
- X052-3 Ground Return Seat Front Shared Ground Return
- X052-32 Pass-through Seat Track Position Sensor Passthrough
- X052-33 Pass-through Seat Track Position Sensor Ground Passthrough
- X052-27 Half-Bridge Seat Front Track Forward
- X052-26 Half-Bridge Seat Front Track Reverse
- X052-4 Hall Sensor In Seat Front Track Hall
- X052-41 Analog In Seat Front Lumbar Switch
- X052-39 Analog In Seat Front Track Backrest Switch
- X052-40 Analog In Seat Front Lift Switch
- X052-42 Analog In Seat Driver Occupancy Sensor
- X052-20 High-Side Drive Occupant Classification ECU
- X052-44 CAN-P Chassis CAN P
- X052-45 CAN-N Chassis CAN N
- X052-22 Ground Return Occupant Classification ECU Ground Return
- X052-12 Analog In Seat Front Buckle Sensor
- X052-47 Half-Bridge Seat Front Tilt Up
- X052-46 Half-Bridge Seat Front Tilt Down
- X052-36 Hall Sensor In Seat Front Tilt Hall



TESLA

THE INFORMATION CONTAINED HEREIN IS DEEMED TO BE CONFIDENTIAL, PROPRIETARY, AND A TRADE SECRET OF TESLA MOTORS. THIS INFORMATION MAY NOT BE USED, REPRODUCED, OR DISCLOSED AS THE DIRECT OR INDIRECT BASIS FOR THE DEVELOPMENT, MANUFACTURE, OR SALE OF PROCESSES OR PRODUCTS WITHOUT THE EXPRESSED WRITTEN CONSENT OF TESLA MOTORS.

DRAWN	CHECKED	APPROVED
MATERIAL AS SPECIFIED	FINISHING AS SPECIFIED	SCALE NONE
PART NAME Seats Front Right		
PART NUMBER	REV 2	SHEET 27 of 30
		SIZE A0

PINLT
Security Controller
C

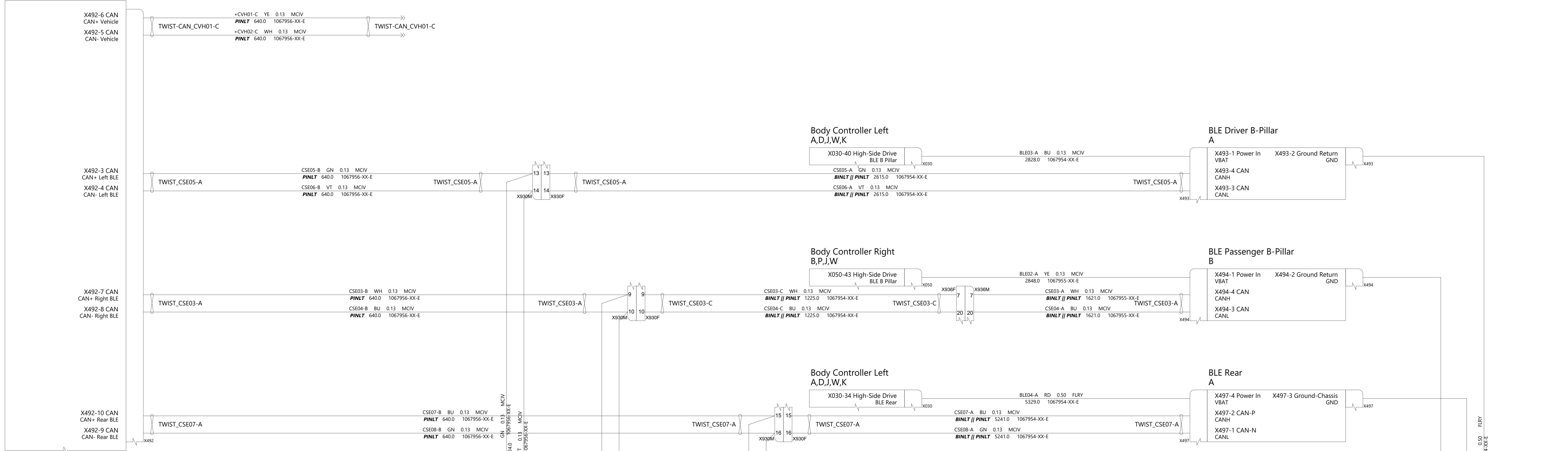

BINLT
Security Controller (B)
C



THE INFORMATION CONTAINED HEREIN IS DEEMED TO BE CONFIDENTIAL, PROPRIETARY, AND A TRADE SECRET OF TESLA MOTORS. THIS INFORMATION MAY NOT BE USED, REPRODUCED, OR DISCLOSED AS THE DIRECT OR INDIRECT BASIS FOR THE DEVELOPMENT, MANUFACTURE, OR SALE OF PROCESSES OR PRODUCTS WITHOUT THE EXPRESSED WRITTEN CONSENT OF TESLA MOTORS.

DRAWN	CHECKED	APPROVED
MATERIAL AS SPECIFIED	FINISHING AS SPECIFIED	SCALE NONE
PART NAME Security Controls		
PART NUMBER	REV 2	SHEET 28 OF 30
		SIZE A0

Body Controller Front
W,U

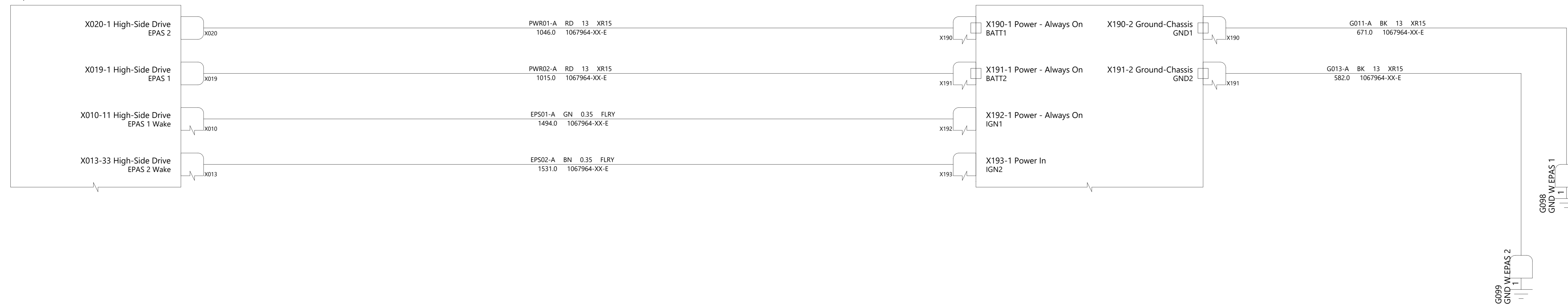

Body Controller Left
A,D,J,W,K

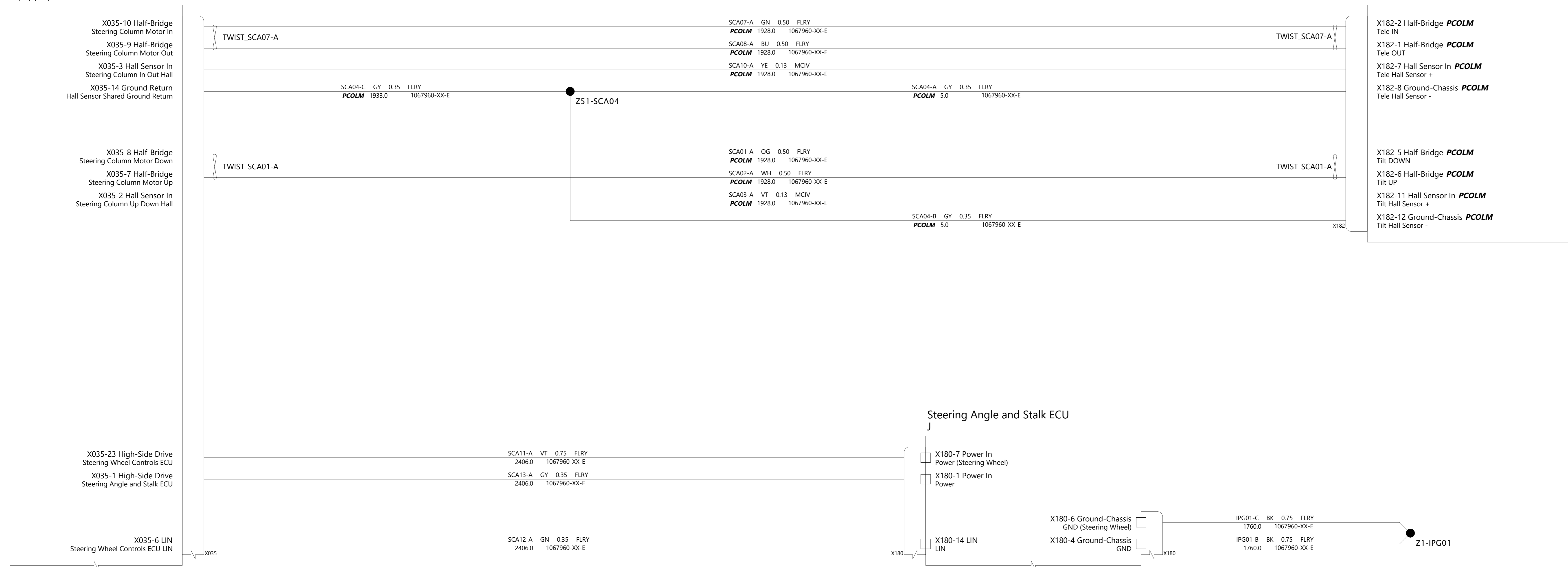

THE INFORMATION CONTAINED HEREIN IS DEEMED TO BE CONFIDENTIAL, PROPRIETARY, AND A TRADE SECRET OF TESLA MOTORS. THIS INFORMATION MAY NOT BE USED, REPRODUCED, OR DISCLOSED AS THE DIRECT OR INDIRECT BASIS FOR THE DEVELOPMENT, MANUFACTURE, OR SALE OF PROCESSES OR PRODUCTS WITHOUT THE EXPRESSED WRITTEN CONSENT OF TESLA MOTORS.

DRAWN	CHECKED	APPROVED
MATERIAL AS SPECIFIED		SCALE NONE
PART NAME Steering		
PART NUMBER	REV	SHEET
	2	29 of 30
		SIZE A0

Body Controller Right
B,P,J,W

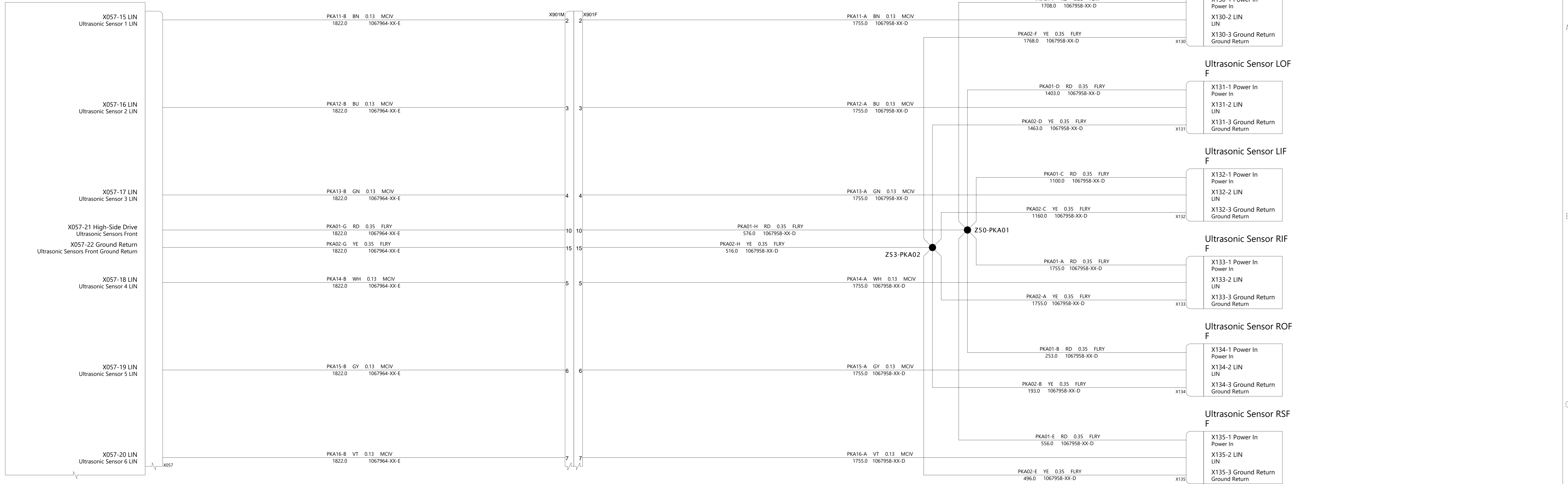

Body Controller Right
B,P,J,W

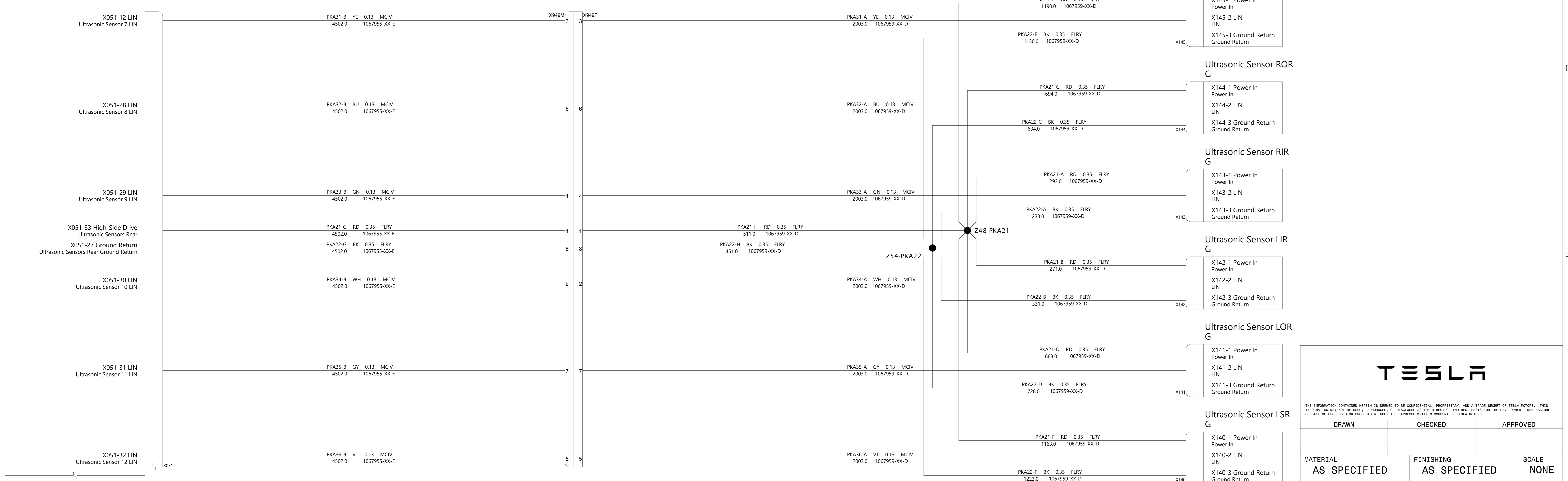

THE INFORMATION CONTAINED HEREIN IS DEEMED TO BE CONFIDENTIAL, PROPRIETARY, AND A TRADE SECRET OF TESLA MOTORS. THIS INFORMATION MAY NOT BE USED, REPRODUCED, OR DISCLOSED AS THE DIRECT OR INDIRECT BASIS FOR THE DEVELOPMENT, MANUFACTURE, OR SALE OF PROCESSES OR PRODUCTS WITHOUT THE EXPRESSED WRITTEN CONSENT OF TESLA MOTORS.

DRAWN	CHECKED	APPROVED

MATERIAL	FINISHING	SCALE
AS SPECIFIED	AS SPECIFIED	NONE

PART NAME
Ultrasonics

PART NUMBER	REV	SHEET	SIZE
	2	30 OF 30	A0

Body Controller Front W,U

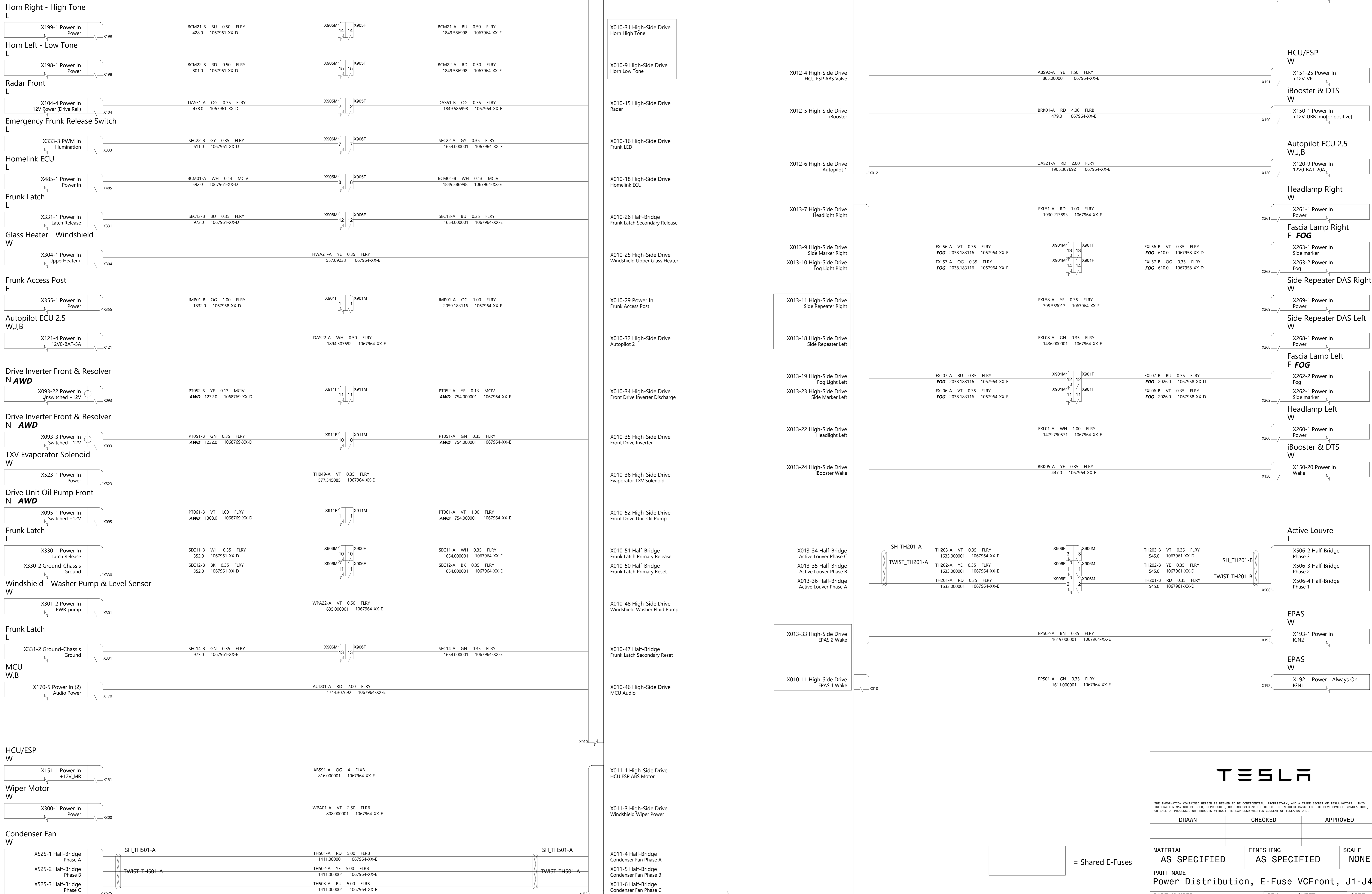

[] = Shared E-Fuses



THE INFORMATION CONTAINED HEREIN IS DEEMED TO BE CONFIDENTIAL, PROPRIETARY, AND A TRADE SECRET OF TESLA MOTORS. THIS INFORMATION MAY NOT BE USED, REPRODUCED, OR DISCLOSED AS THE DIRECT OR INDIRECT BASIS FOR THE DEVELOPMENT, MANUFACTURE, OR SALE OF PROCESSES OR PRODUCTS WITHOUT THE EXPRESSED WRITTEN CONSENT OF TESLA MOTORS.

DRAWN	CHECKED	APPROVED
MATERIAL AS SPECIFIED	FINISHING AS SPECIFIED	SCALE NONE
PART NAME Power Distribution, E-Fuse VCFront, J1-J4		
PART NUMBER	REV	SHEET
	2	1 OF 9
		SIZE A0

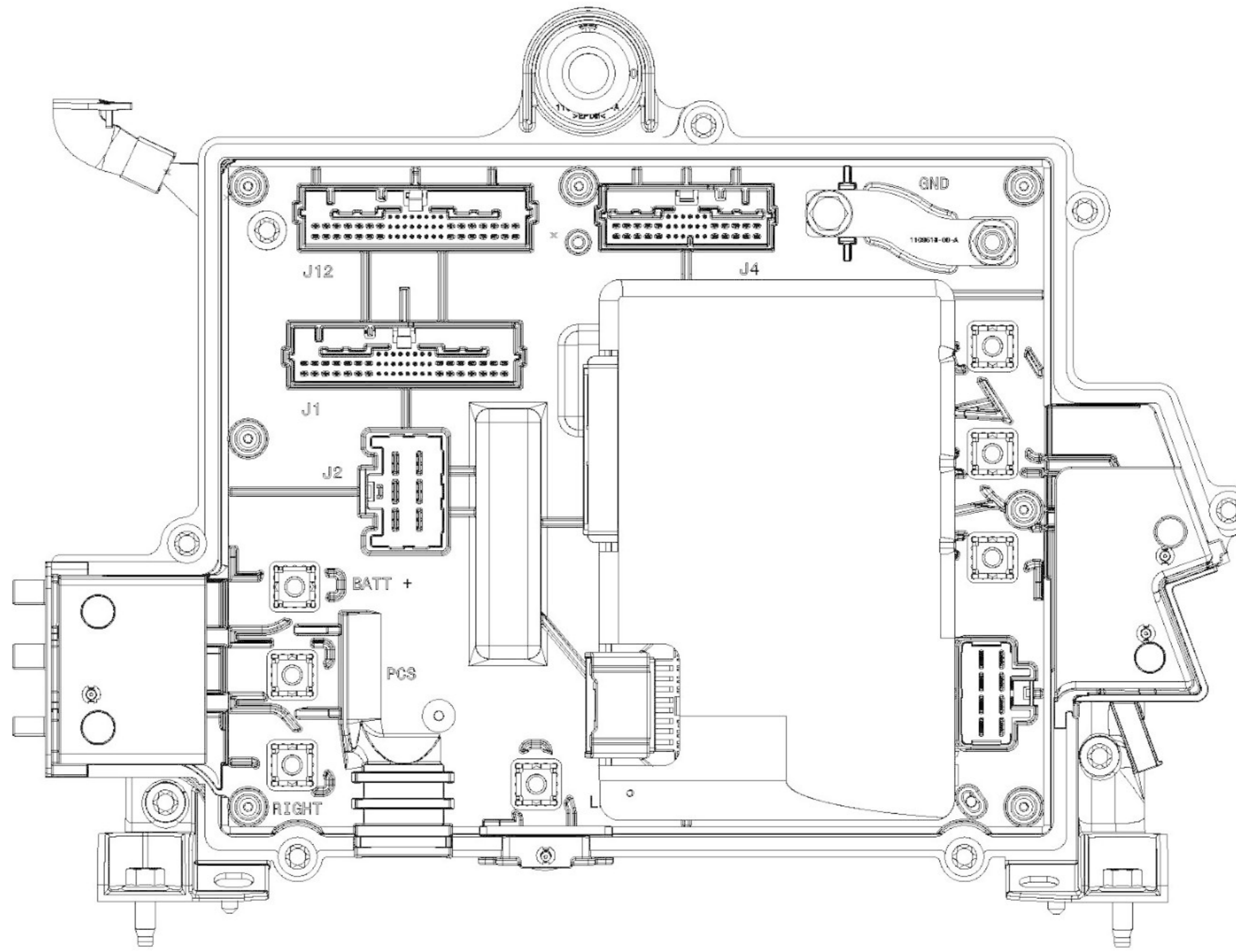
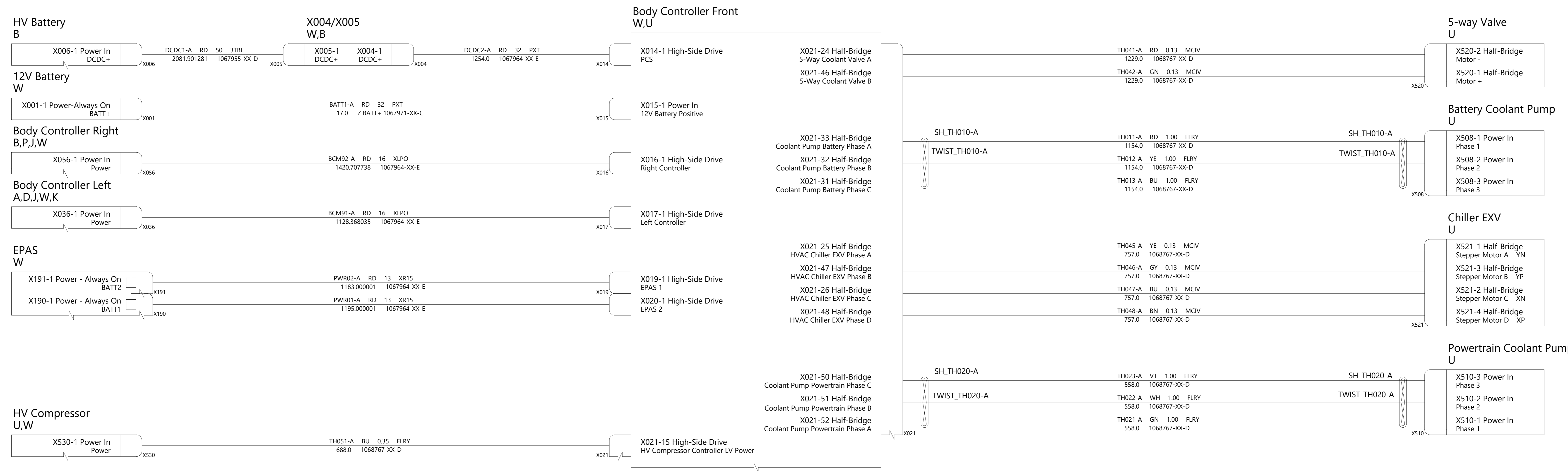

TESLA

THE INFORMATION CONTAINED HEREIN IS DEEMED TO BE CONFIDENTIAL, PROPRIETARY, AND A TRADE SECRET OF TESLA MOTORS. THIS INFORMATION MAY NOT BE USED, REPRODUCED, OR DISCLOSED AS THE DIRECT OR INDIRECT BASIS FOR THE DEVELOPMENT, MANUFACTURE, OR SALE OF PROCESSES OR PRODUCTS WITHOUT THE EXPRESS WRITTEN CONSENT OF TESLA MOTORS.

DRAWN	CHECKED	APPROVED
-------	---------	----------

MATERIAL AS SPECIFIED	FINISHING AS SPECIFIED	SCALE NONE
--------------------------	---------------------------	---------------

PART NAME
Power Distribution, E-Fuse VCFront, J5-J11

PART NUMBER	REV	SHEET	SIZE
	2	2 OF 9	A0

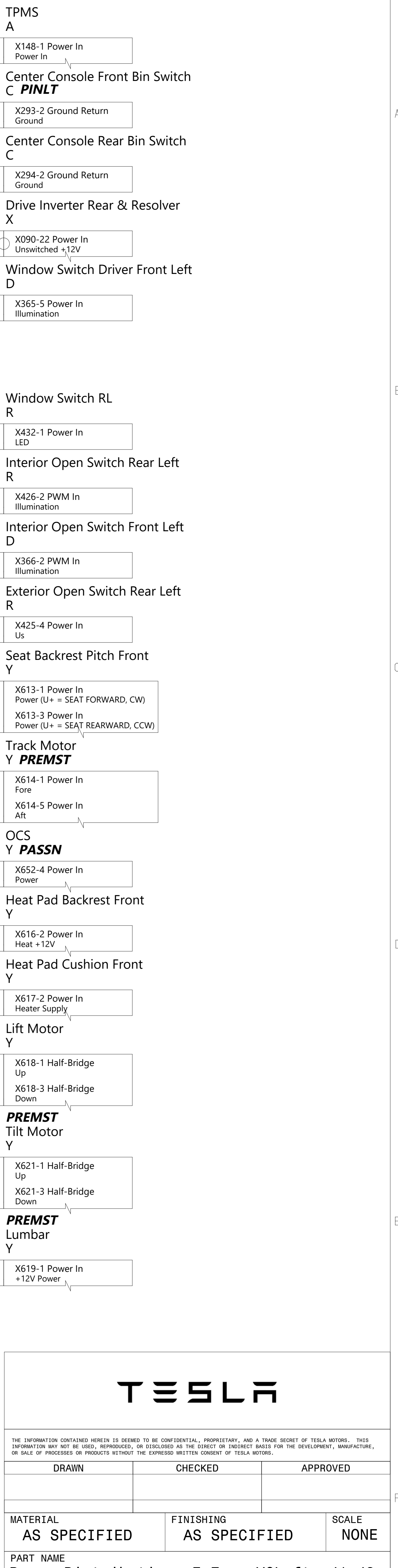
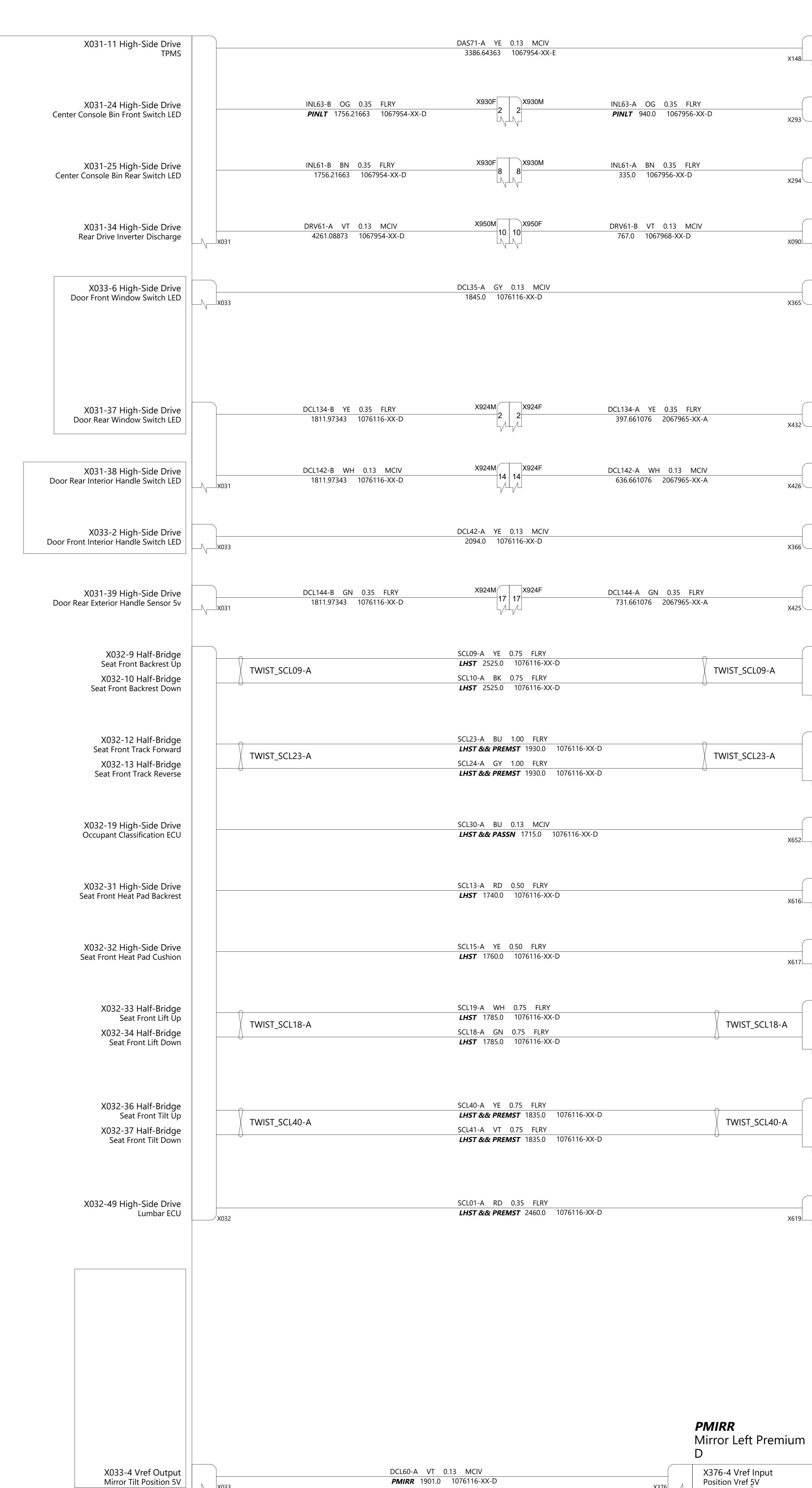
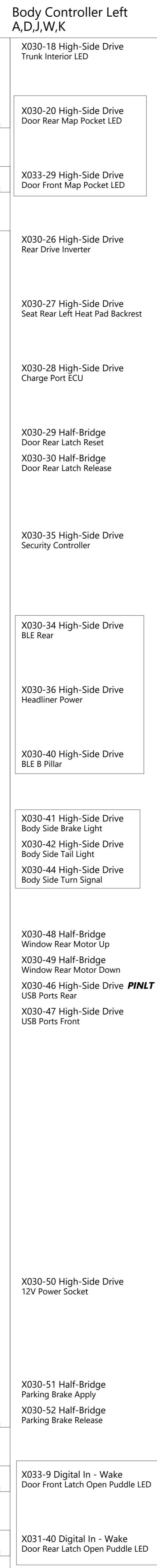
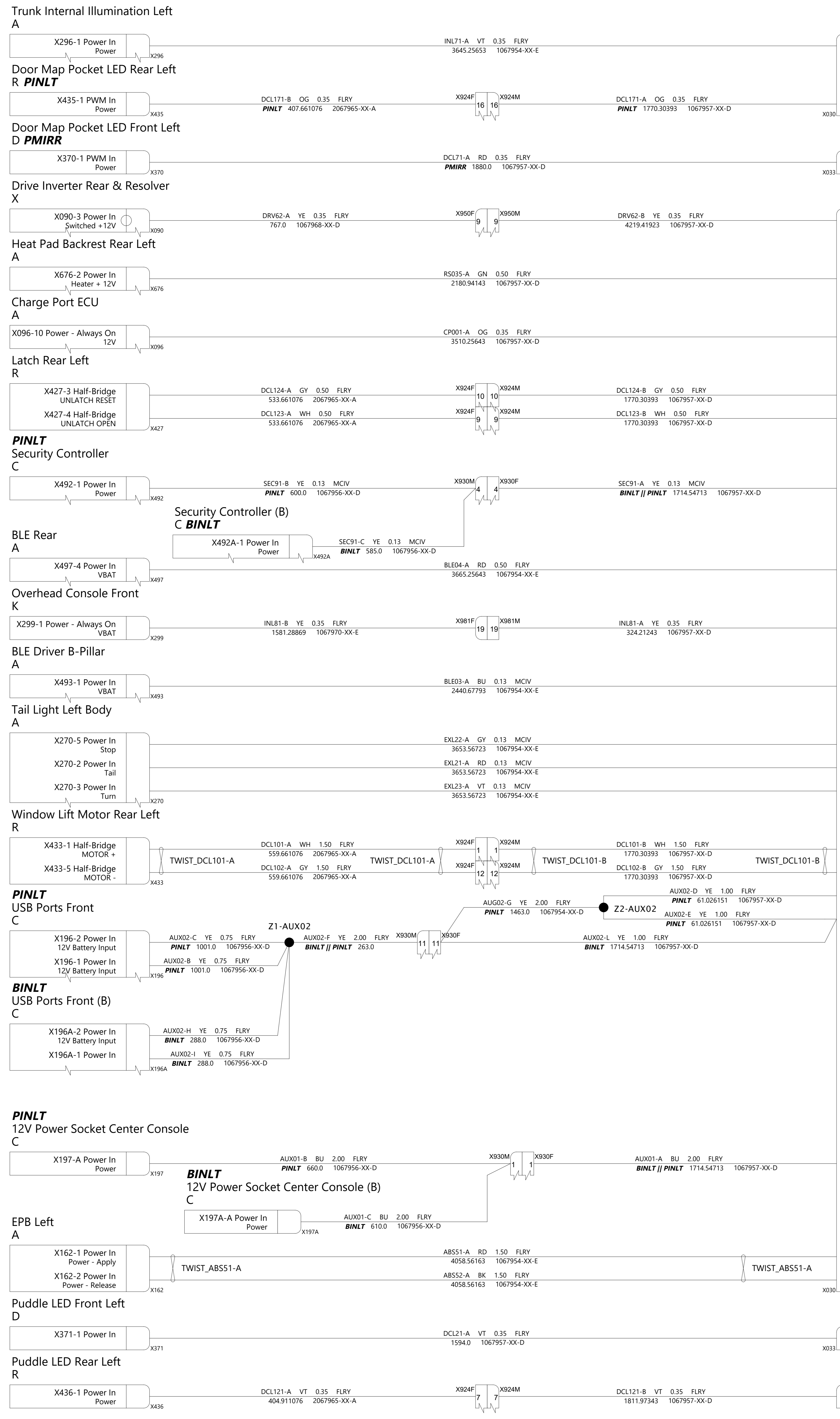

TESLA

THE INFORMATION CONTAINED HEREIN IS DEEMED TO BE CONFIDENTIAL, PROPRIETARY, AND A TRADE SECRET OF TESLA MOTORS. THIS INFORMATION MAY NOT BE USED, REPRODUCED, OR DISCLOSED AS THE DIRECT OR INDIRECT BASIS FOR THE DEVELOPMENT, MANUFACTURE, OR SALE OF PROCESSES OR PRODUCTS WITHOUT THE EXPRESS WRITTEN CONSENT OF TESLA MOTORS.

DRAWN	CHECKED	APPROVED
MATERIAL AS SPECIFIED	FINISHING AS SPECIFIED	SCALE NONE
PART NAME Power Distribution, E-Fuse VLeft, J1-J3		
PART NUMBER	REV	SHEET
	2	3 OF 9
		A0

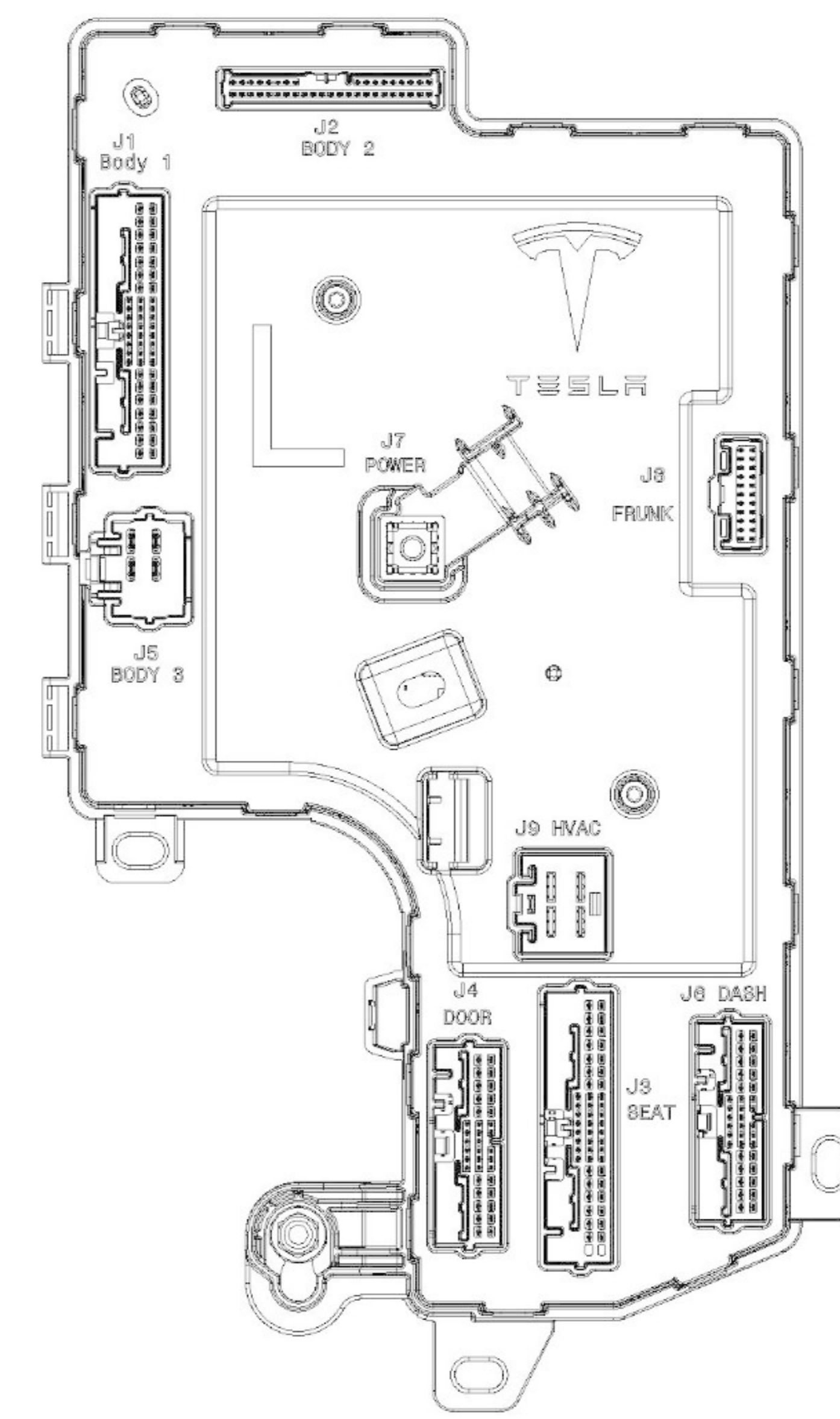
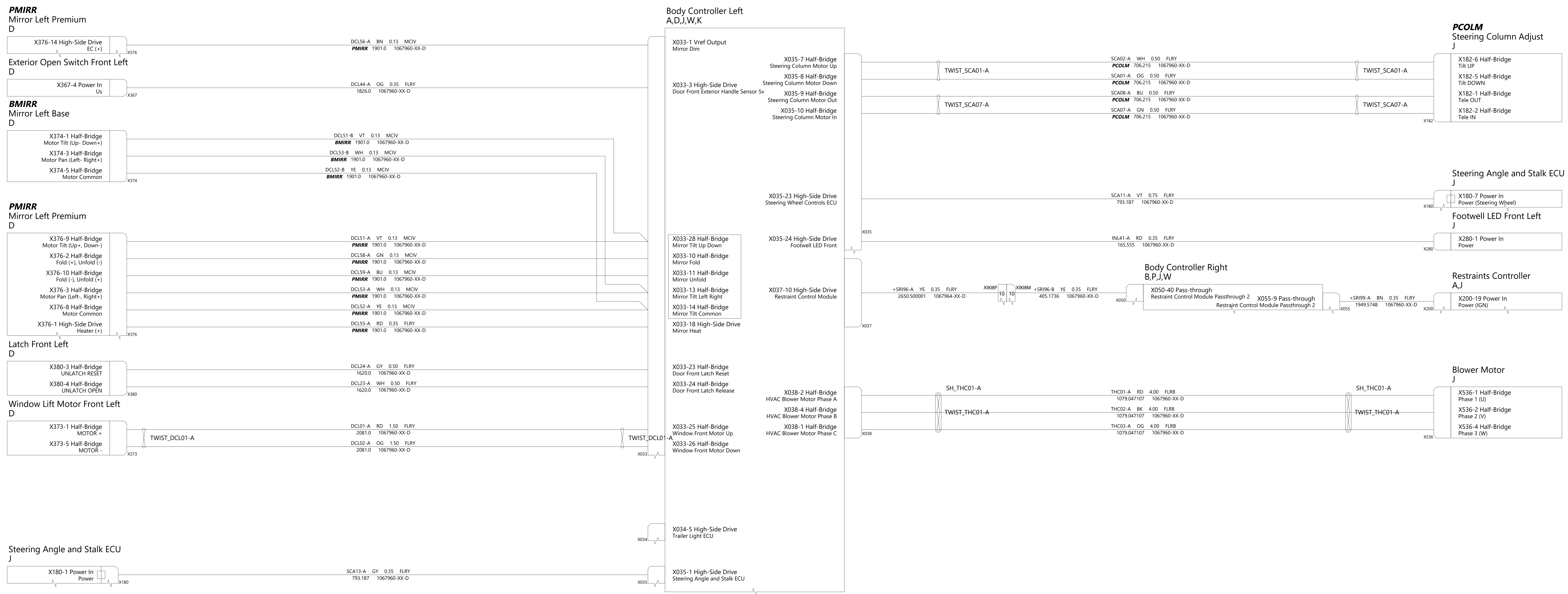

TESLA			
THE INFORMATION CONTAINED HEREIN IS DEEMED TO BE CONFIDENTIAL, PROPRIETARY, AND A TRADE SECRET OF TESLA MOTORS. THIS INFORMATION MAY NOT BE USED, REPRODUCED, OR DISCLOSED AS THE DIRECT OR INDIRECT BASIS FOR THE DEVELOPMENT, MANUFACTURE, OR SALE OF PROCESSES OR PRODUCTS WITHOUT THE EXPRESSED WRITTEN CONSENT OF TESLA MOTORS.			
DRAWN	CHECKED	APPROVED	
MATERIAL AS SPECIFIED	FINISHING AS SPECIFIED	SCALE NONE	
PART NAME Power Distribution, E-Fuse VLeft, J4-J9			
PART NUMBER	REV	SHEET	SIZE
	2	4 OF 9	A0

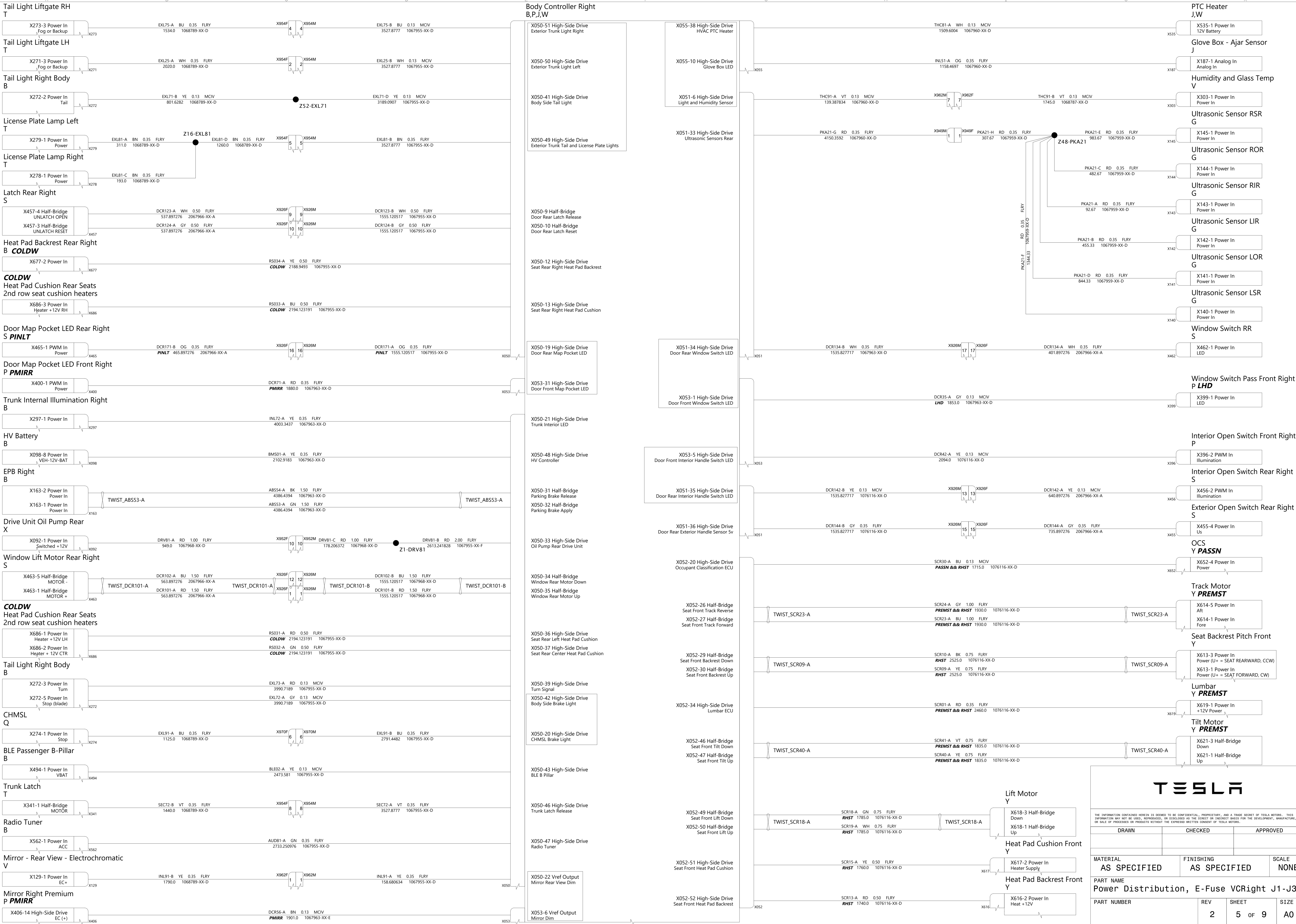

TESLA

THE INFORMATION CONTAINED HEREIN IS DEEMED TO BE CONFIDENTIAL, PROPRIETARY, AND A TRADE SECRET OF TESLA MOTORS. THIS INFORMATION MAY NOT BE USED, REPRODUCED, OR DISCLOSED AS THE DIRECT OR INDIRECT BASIS FOR THE DEVELOPMENT, MANUFACTURE, OR SALE OF PROCESSES OR PRODUCTS WITHOUT THE EXPRESS WRITTEN CONSENT OF TESLA MOTORS.

DRAWN	CHECKED	APPROVED
MATERIAL AS SPECIFIED	FINISHING AS SPECIFIED	SCALE NONE
PART NAME Power Distribution, E-Fuse VCRight J1-J3		
PART NUMBER	REV	SHEET
	2	5 OF 9
		SIZE
		A0

Exterior Open Switch Front Right
P



PMIRR
Mirror Right Premium
P

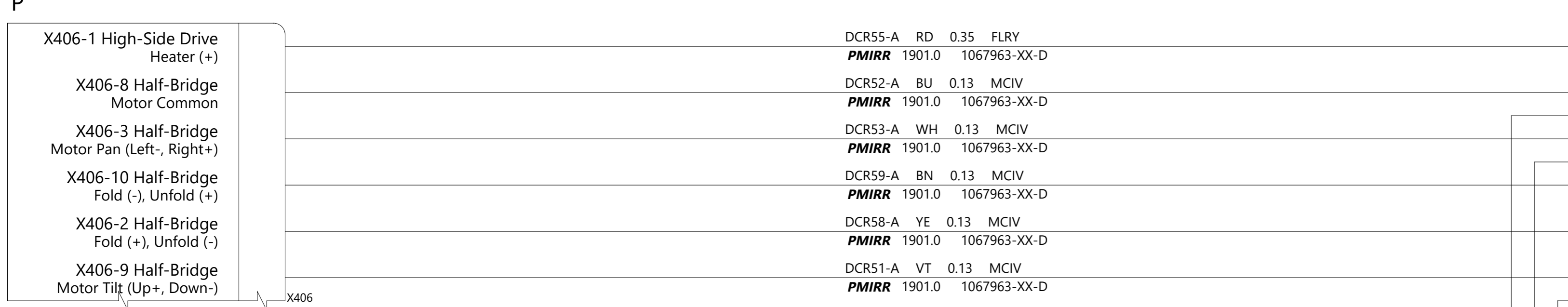

BMIRR
Mirror Right Base
P

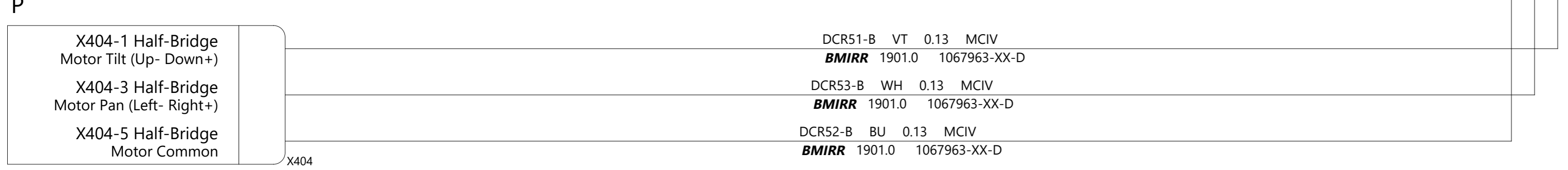

Window Lift Motor Front Right
P

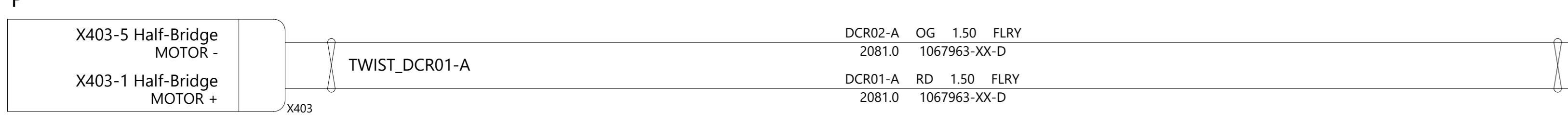

Latch Front Right
P

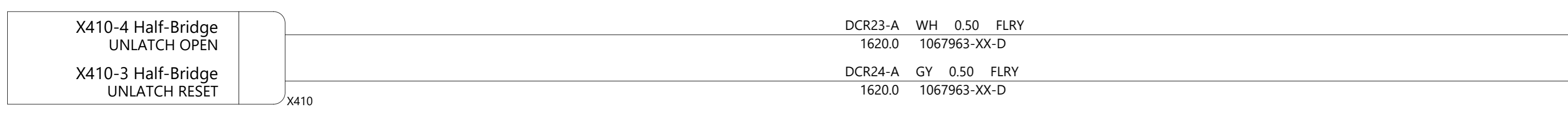

PMIRR
Mirror Right Premium
P



Puddle LED Front Right
P



Puddle LED Rear Right
S



Body Controller Right
B,P,J,W

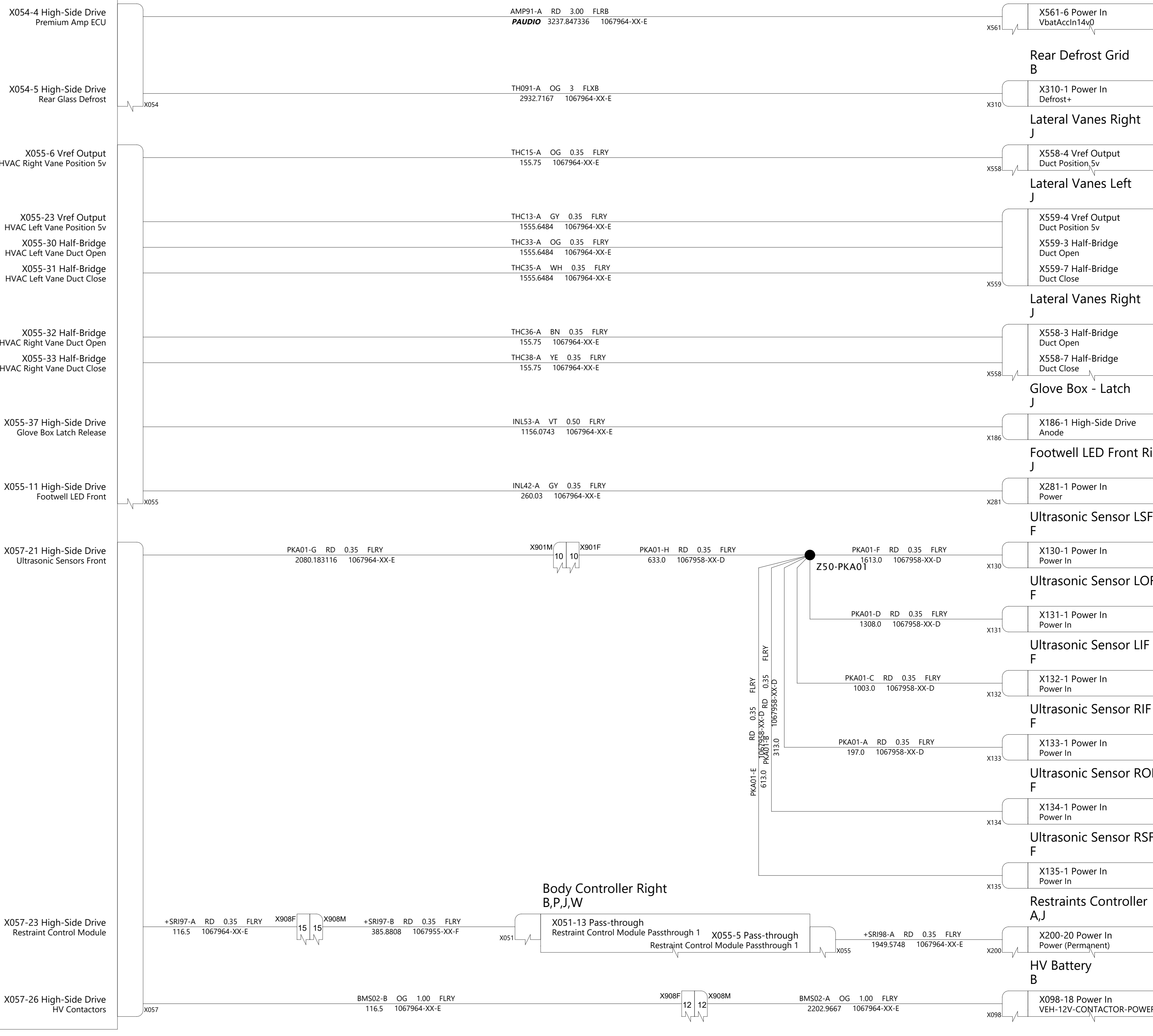
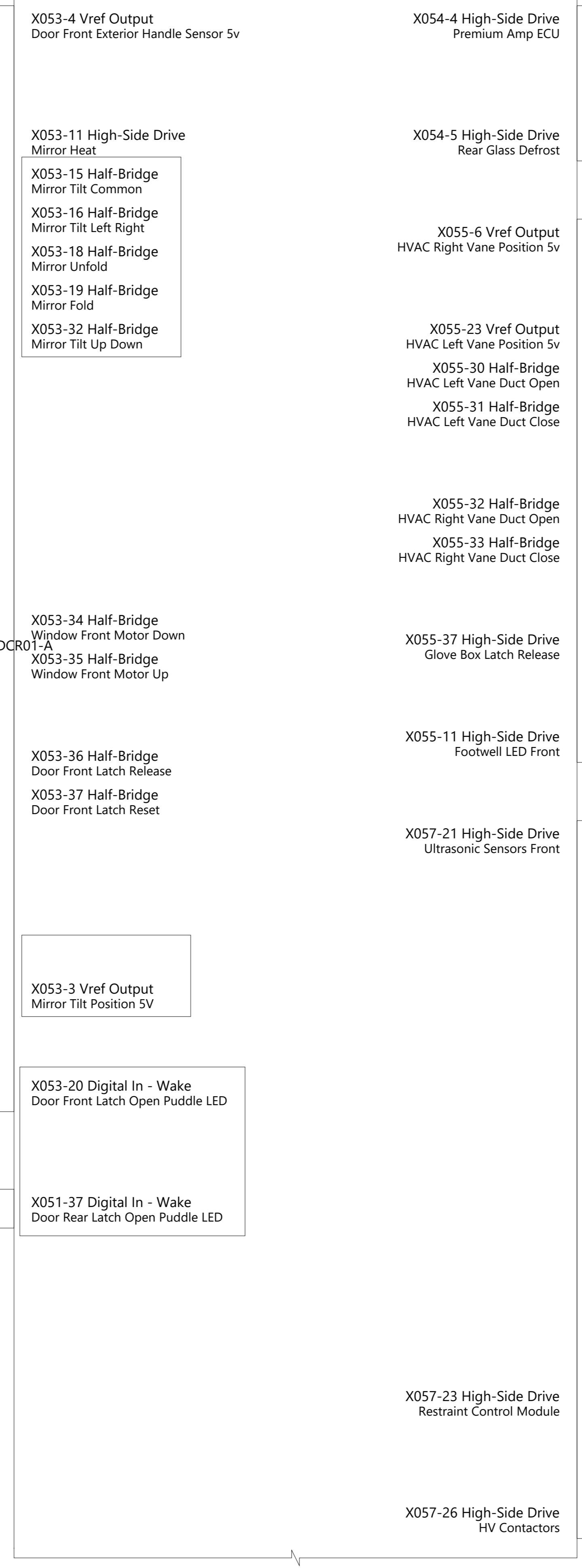

PAUDIO
Premium Amp Audio
B

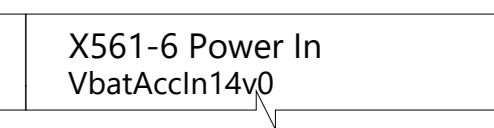

Rear Defrost Grid
B

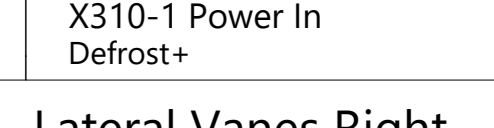

Lateral Vanes Right
J

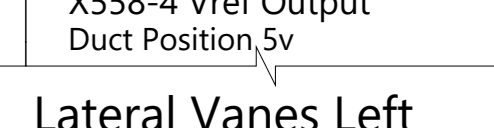

Lateral Vanes Left
J



Lateral Vanes Right
J

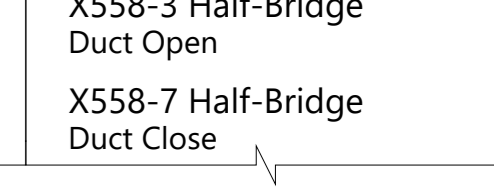

Glove Box - Latch
J

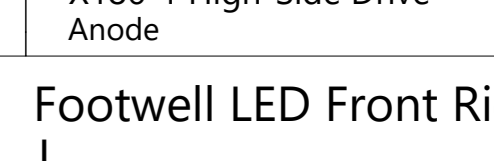

Footwell LED Front Right
J

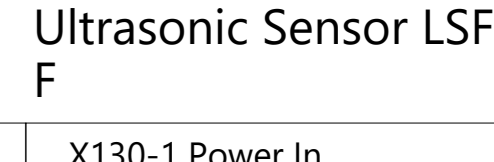

Ultrasonic Sensor LSF
F

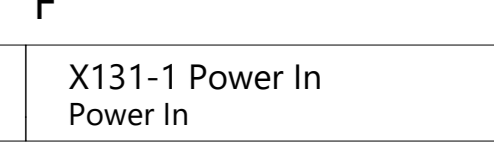

Ultrasonic Sensor LOF
F

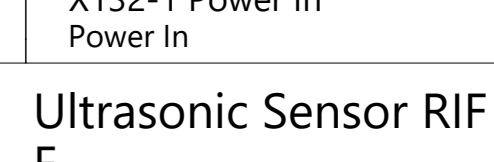

Ultrasonic Sensor LIF
F

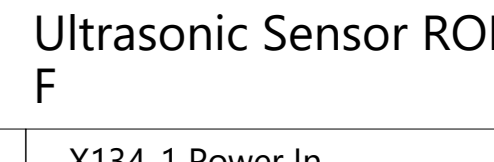

Ultrasonic Sensor RIF
F

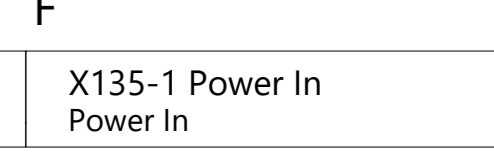

Ultrasonic Sensor ROF
F

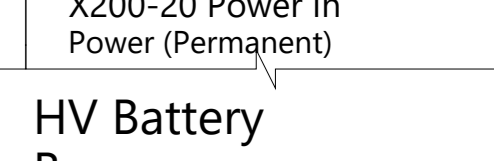

Ultrasonic Sensor RSF
F

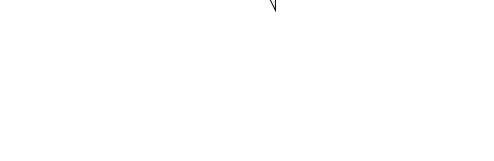

Restraints Controller
A,J



HV Battery
B

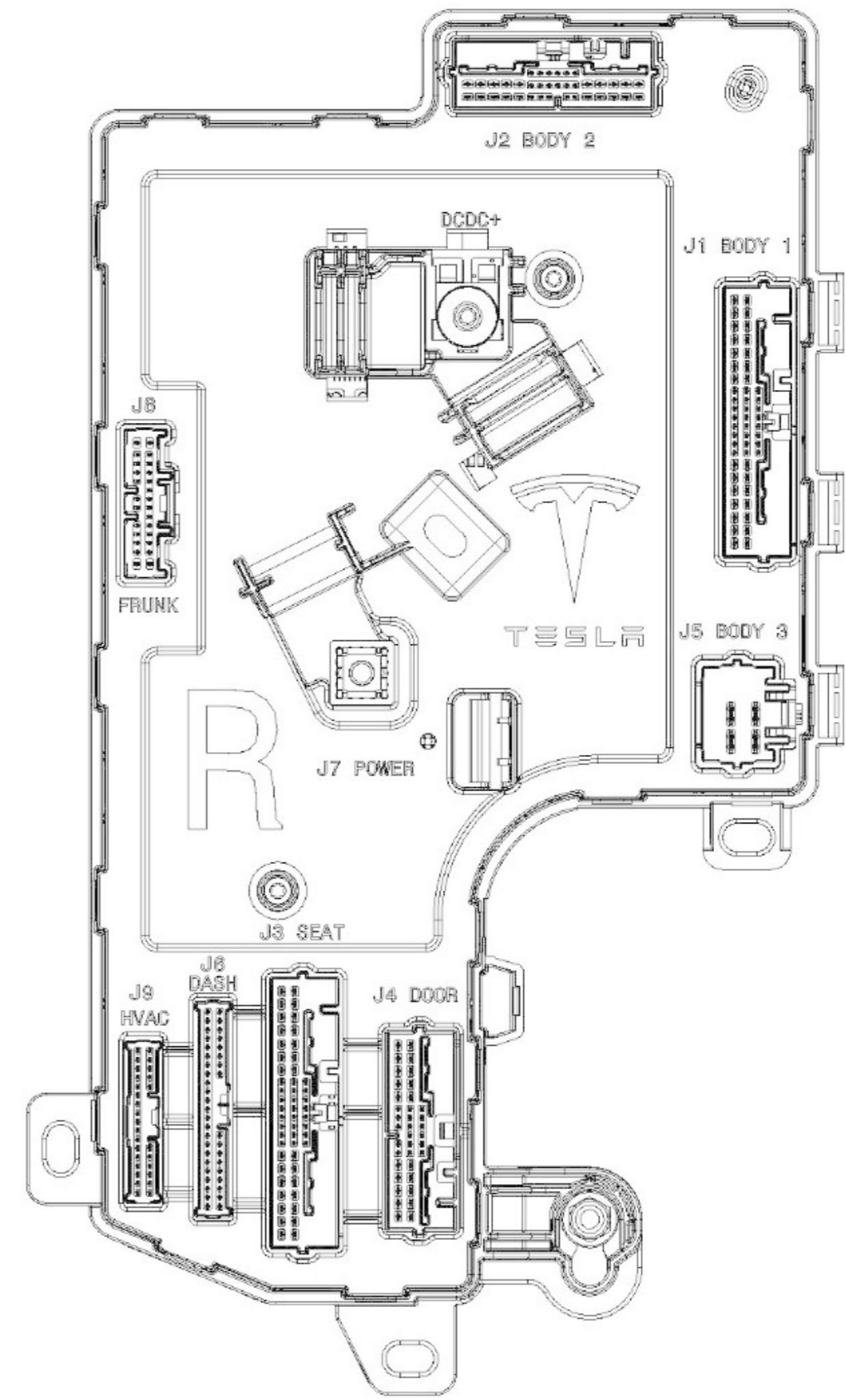

[Symbol] = Shared E-Fuses

TESLA			
THE INFORMATION CONTAINED HEREIN IS DEEMED TO BE CONFIDENTIAL, PROPRIETARY, AND A TRADE SECRET OF TESLA MOTORS. THIS INFORMATION MAY NOT BE USED, REPRODUCED, OR DISCLOSED AS THE DIRECT OR INDIRECT BASIS FOR THE DEVELOPMENT, MANUFACTURE, OR SALE OF PROCESSES OR PRODUCTS WITHOUT THE EXPRESSED WRITTEN CONSENT OF TESLA MOTORS.			
DRAWN	CHECKED	APPROVED	
MATERIAL AS SPECIFIED	FINISHING AS SPECIFIED	SCALE NONE	
PART NAME Power Distribution, E-Fuse VCRight J4-J9			
PART NUMBER	REV	SHEET	SIZE
	2	6 OF 9	A0

Windshield - Washer Pump & Level Sensor
W

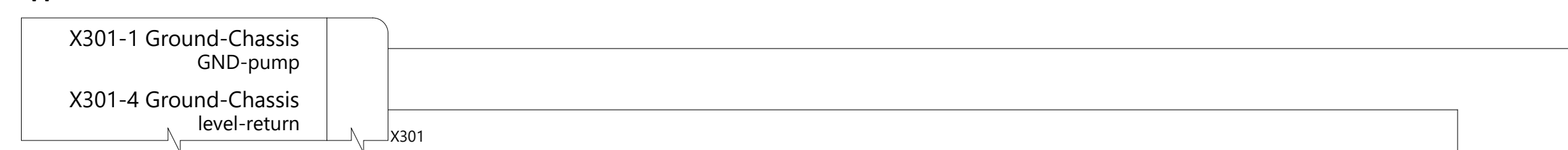

Headlamp Left
W



AWD Drive Inverter Front & Resolver
N

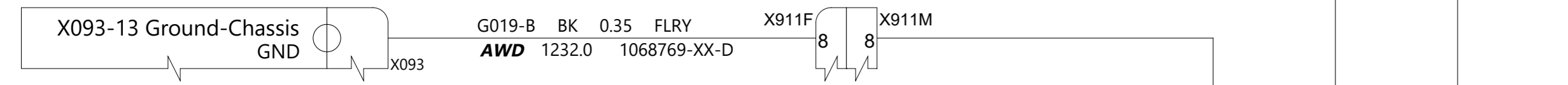

Side Repeater DAS Left
W



EPAS
W



AWD Drive Unit Oil Pump Front
N

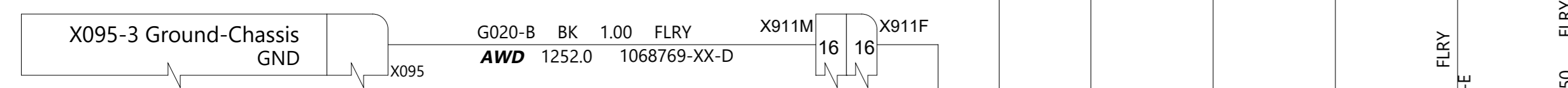

HCU/ESP
W



EPAS
W

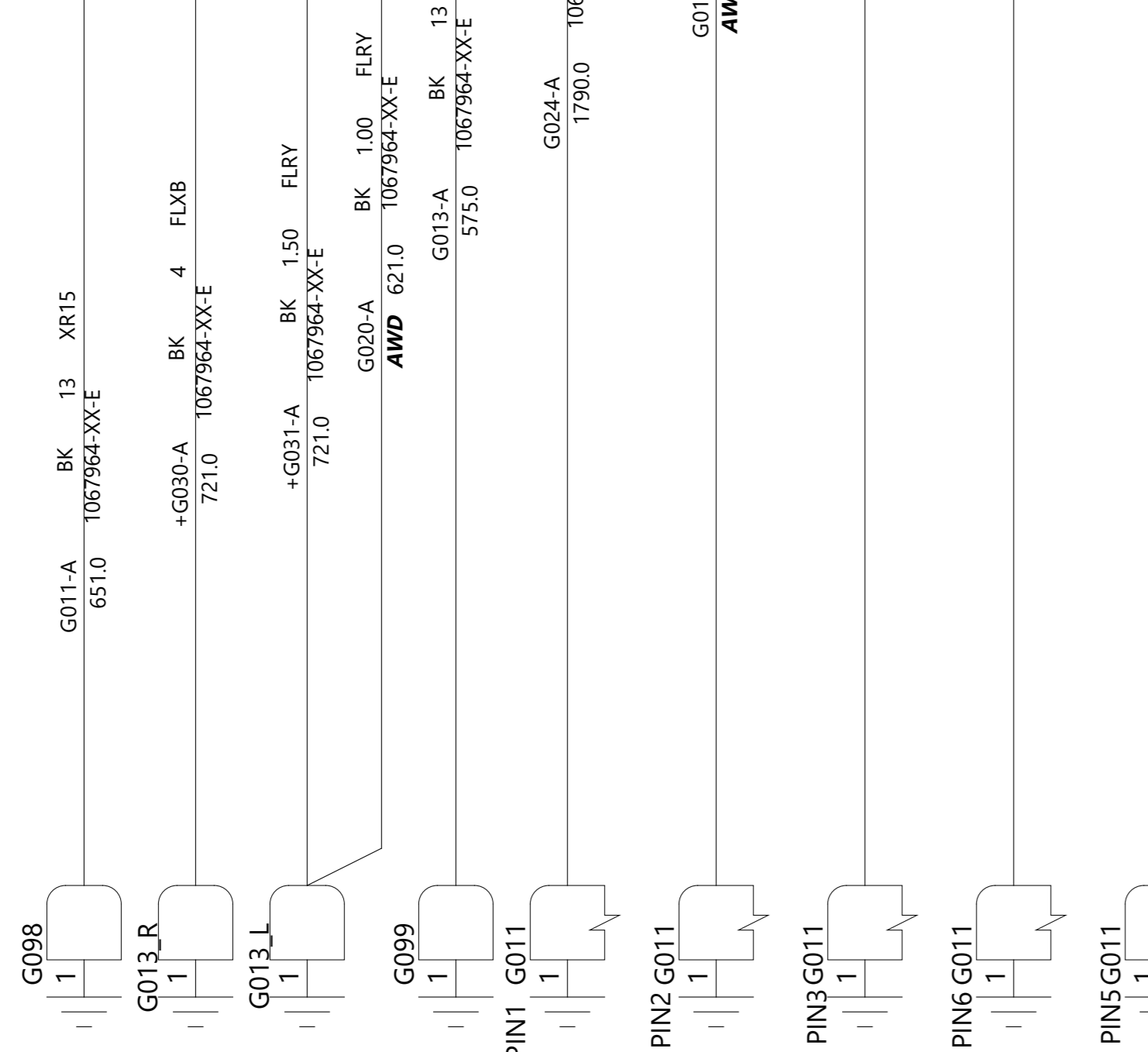
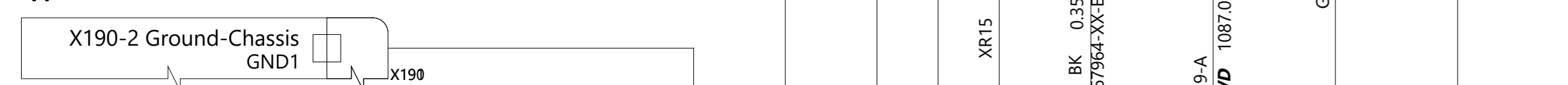

iBooster & DTS
W



Glass Heater - Windshield
W

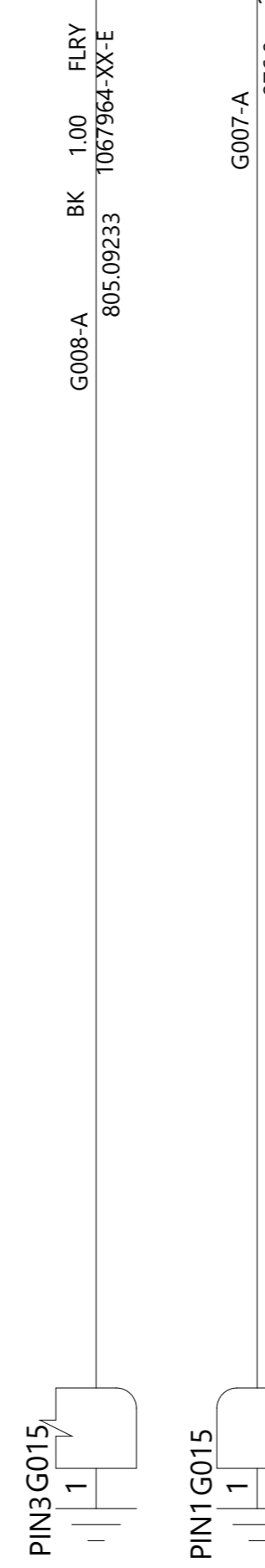

Wiper Motor
W

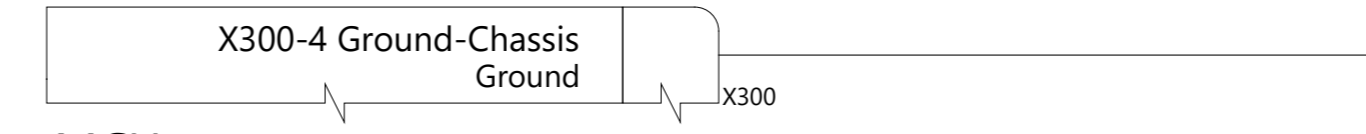

MCU
W,B



Autopilot ECU 2.5
W,J,B

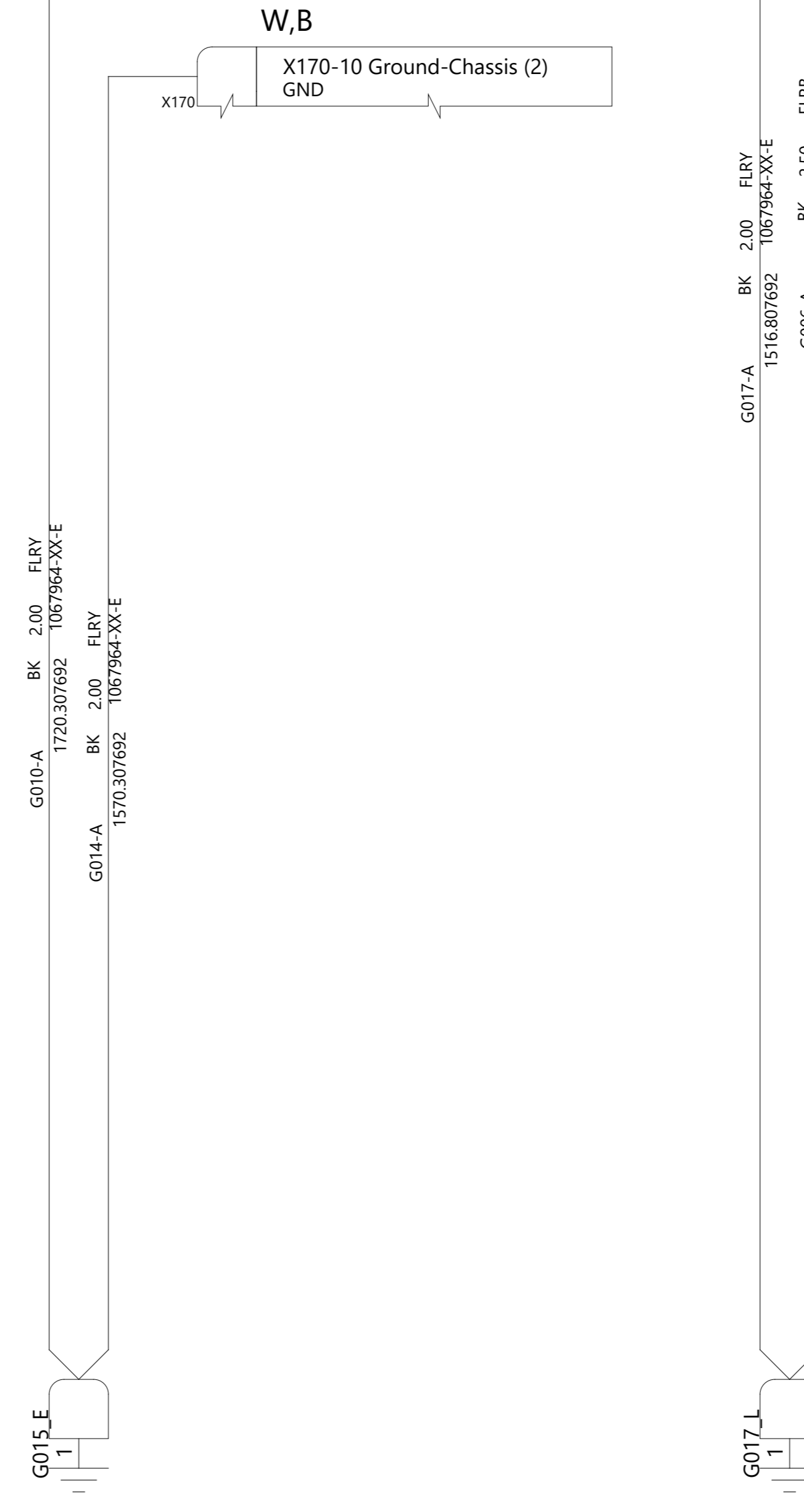
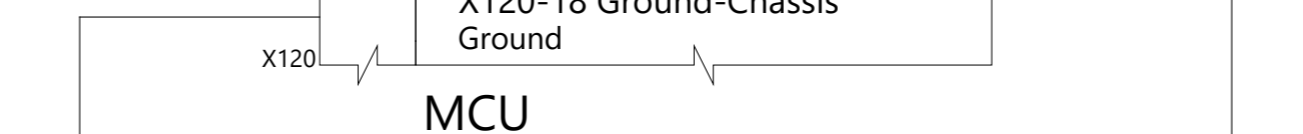

iBooster & DTS
W

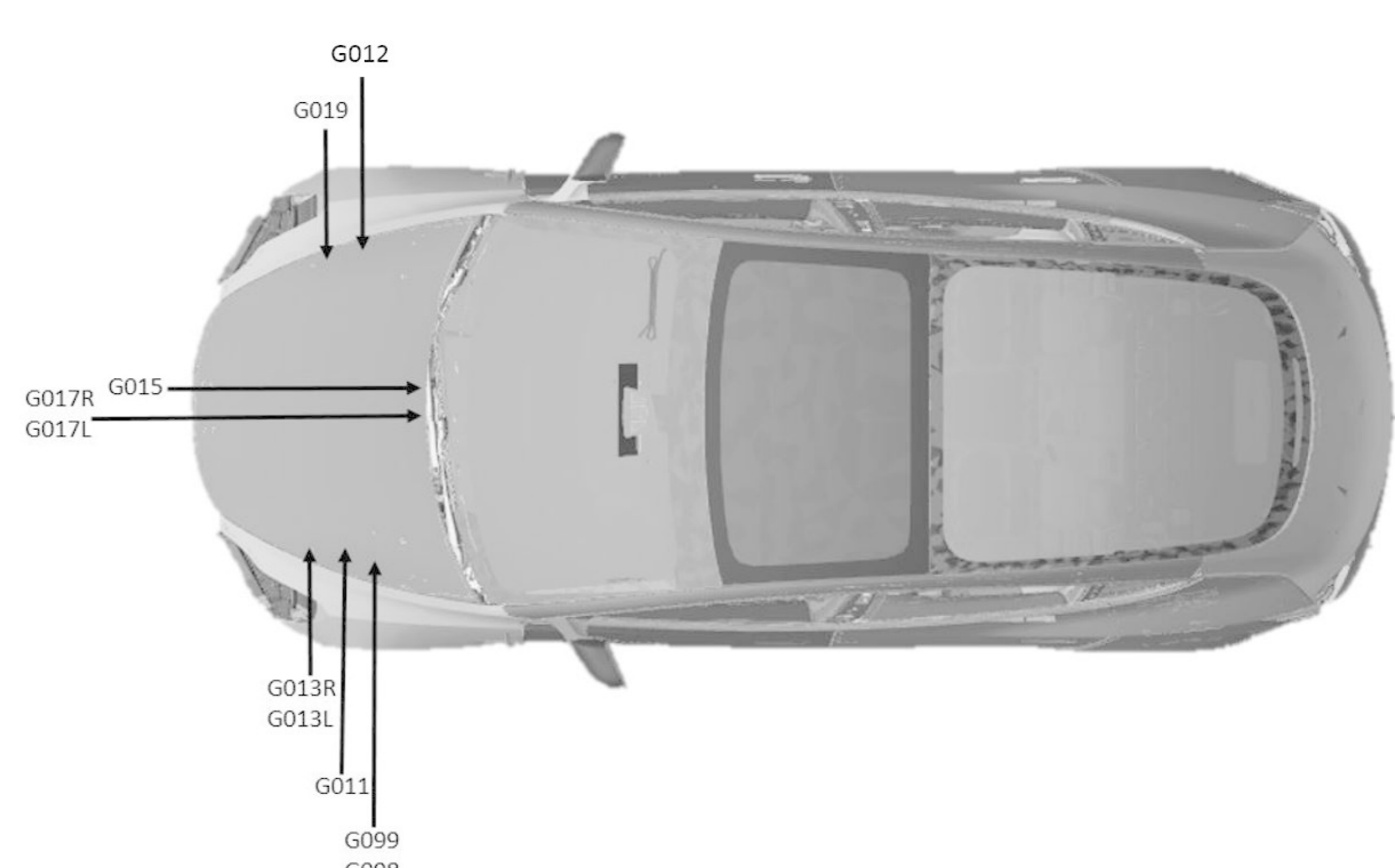
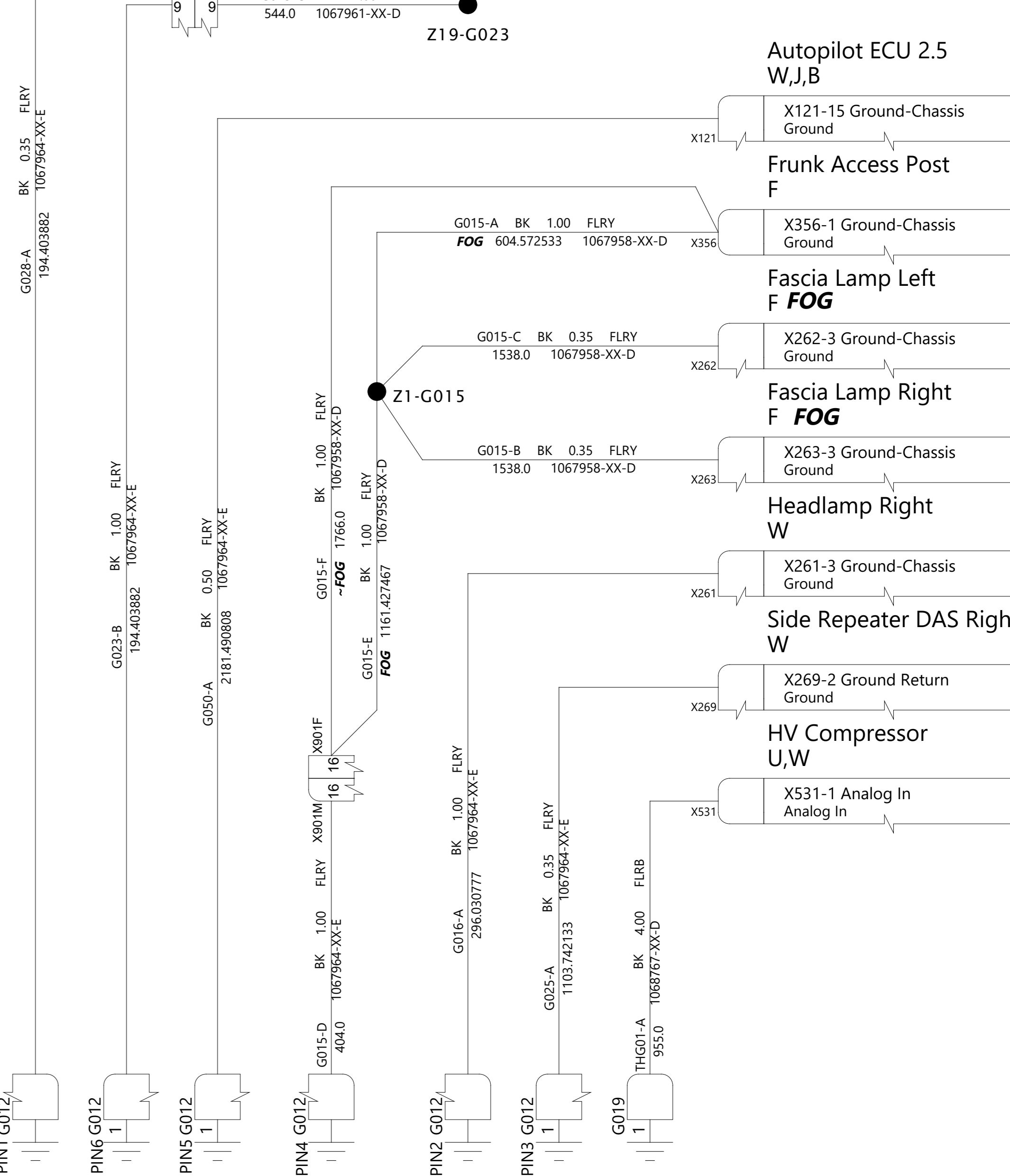
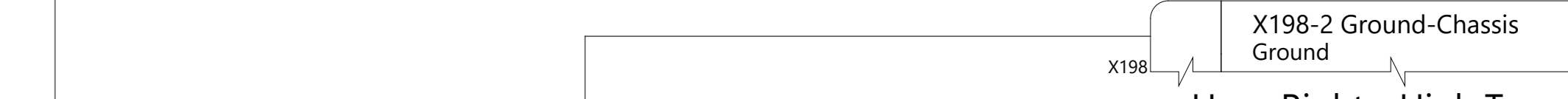
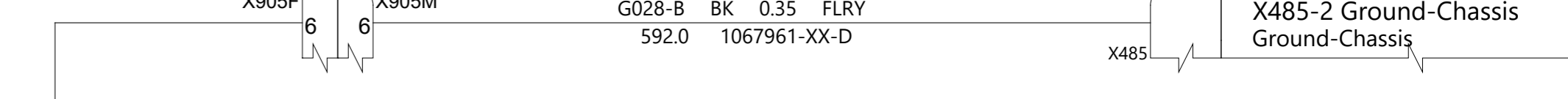
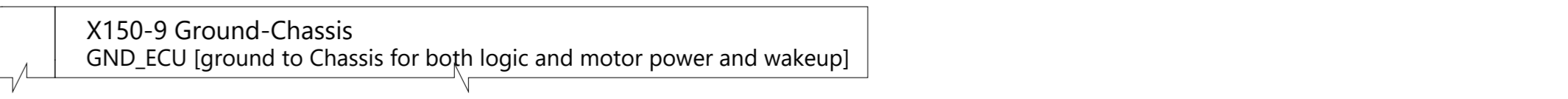

TESLA			
THE INFORMATION CONTAINED HEREIN IS DEEMED TO BE CONFIDENTIAL, PROPRIETARY, AND A TRADE SECRET OF TESLA MOTORS. THIS INFORMATION MAY NOT BE USED, REPRODUCED, OR DISCLOSED AS DIRECT OR INDIRECT BASIS FOR THE DEVELOPMENT, MANUFACTURE, OR SALE OF PROCESSES OR PRODUCTS WITHOUT THE EXPRESSED WRITTEN CONSENT OF TESLA MOTORS.			
DRAWN	CHECKED	APPROVED	
MATERIAL AS SPECIFIED	FINISHING AS SPECIFIED	SCALE NONE	
PART NAME Power Distribution, Grounding Frunk			
PART NUMBER	REV	SHEET	SIZE
	2	7 OF 9	A0

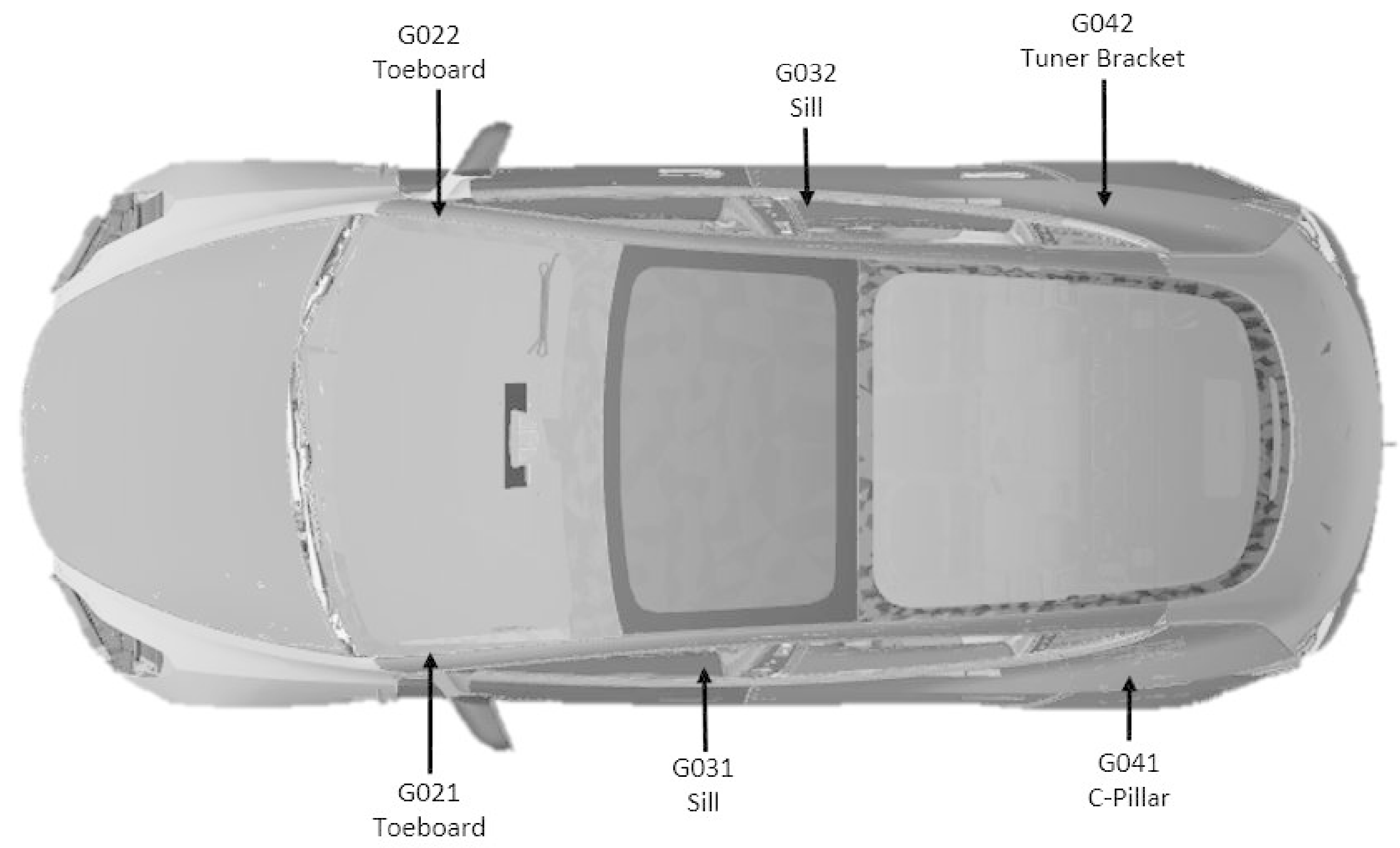
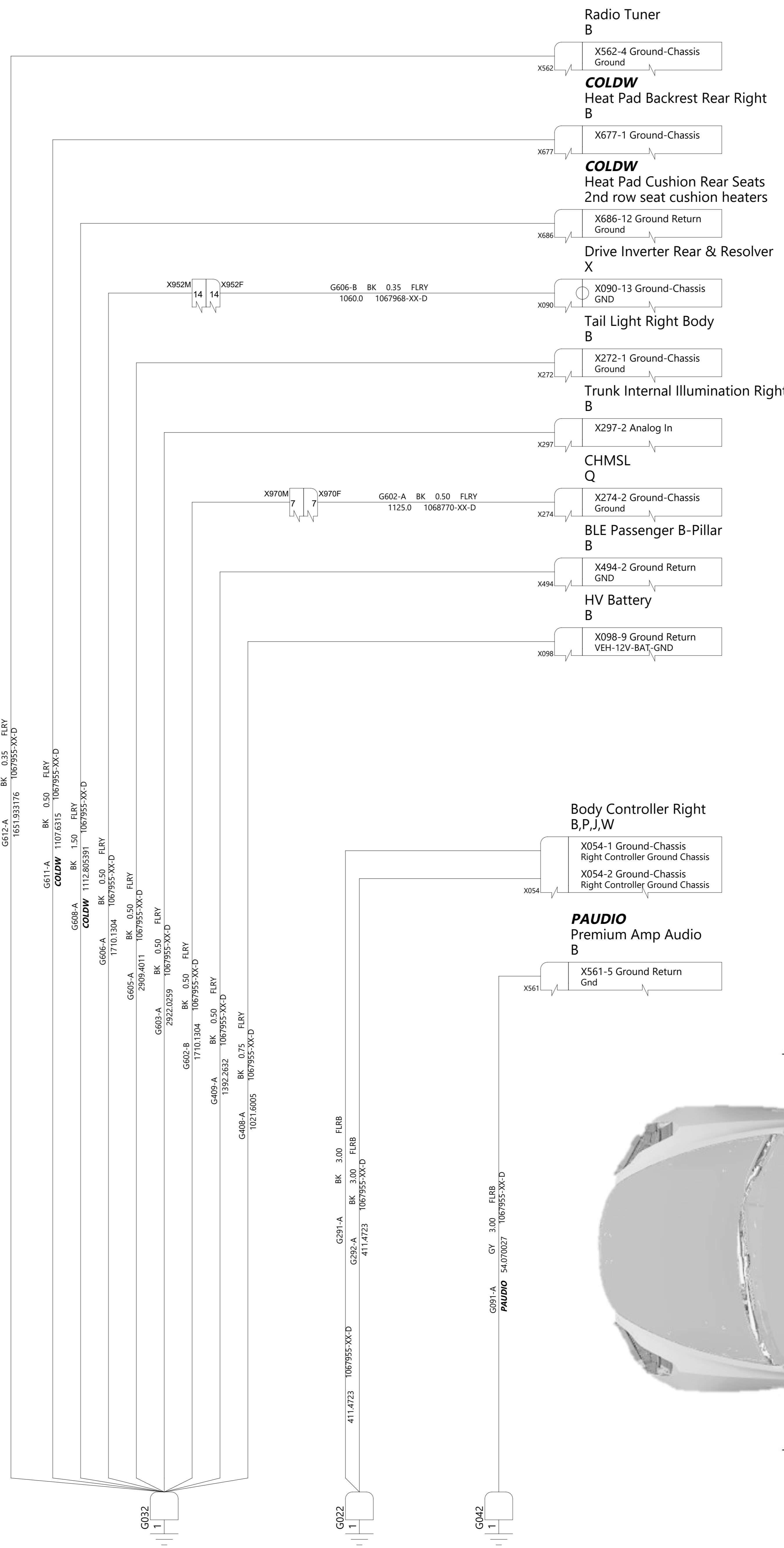
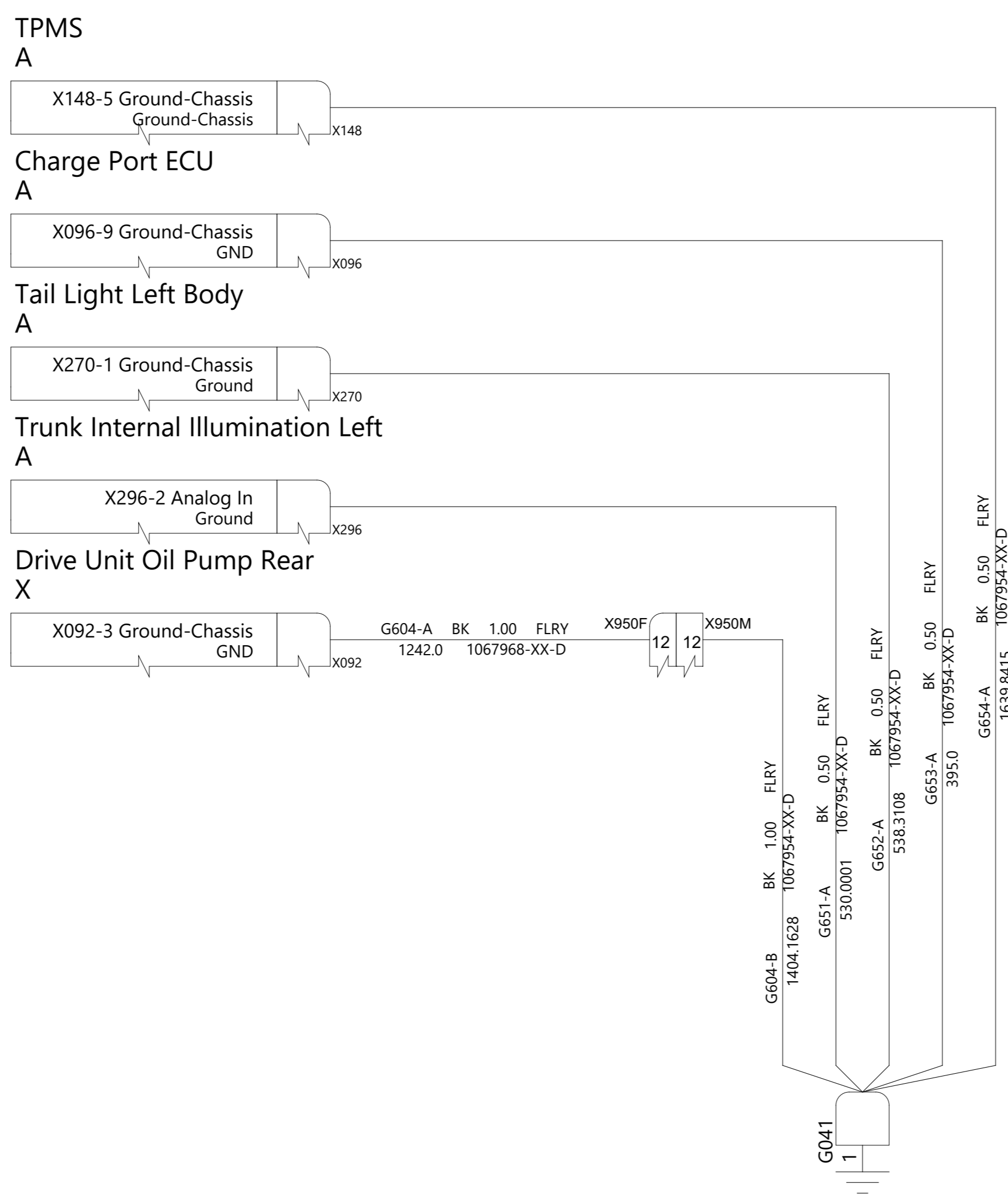
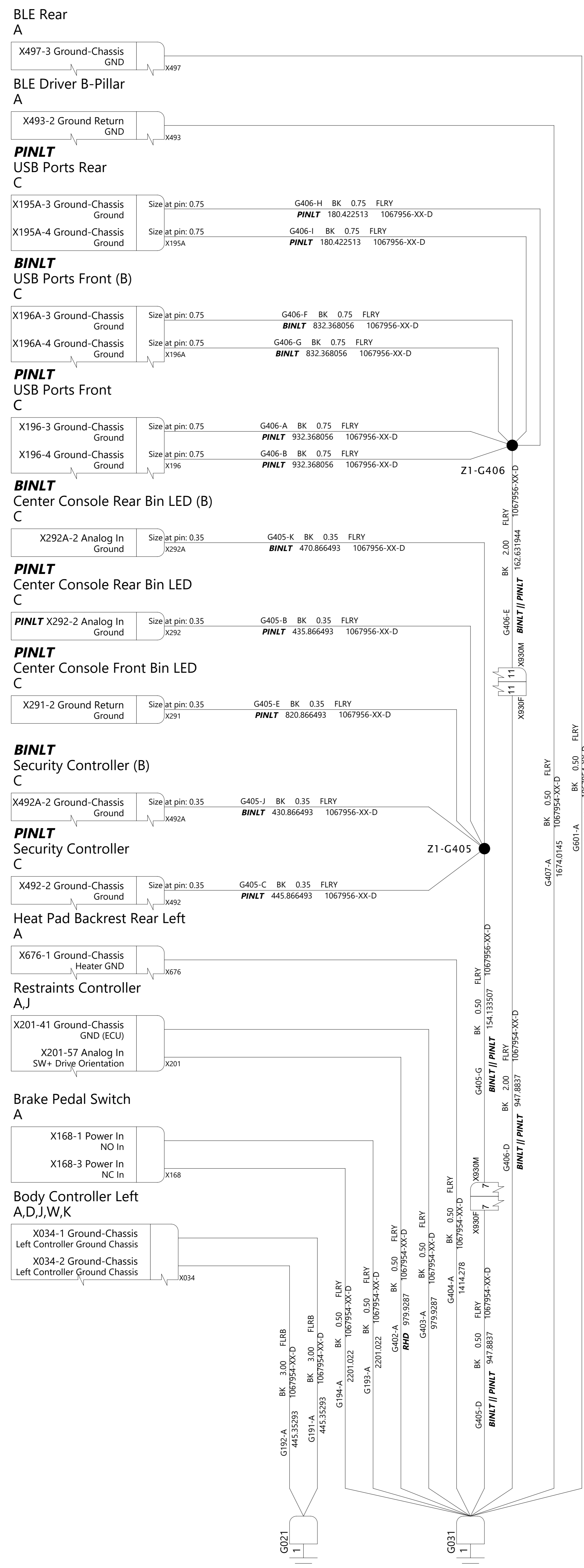

TESLA

THE INFORMATION CONTAINED HEREIN IS DEEMED TO BE CONFIDENTIAL, PROPRIETARY, AND A TRADE SECRET OF TESLA MOTORS. THIS INFORMATION MAY NOT BE USED, REPRODUCED, OR DISCLOSED AS THE DIRECT OR INDIRECT BASIS FOR THE DEVELOPMENT, MANUFACTURE, OR SALE OF PROCESSES OR PRODUCTS WITHOUT THE EXPRESS WRITTEN CONSENT OF TESLA MOTORS.

DRAWN	CHECKED	APPROVED
MATERIAL AS SPECIFIED	FINISHING AS SPECIFIED	SCALE NONE
PART NAME Power Distribution, Grounding Pillars		
PART NUMBER	REV	SHEET
	2	8 OF 9
		SIZE A0

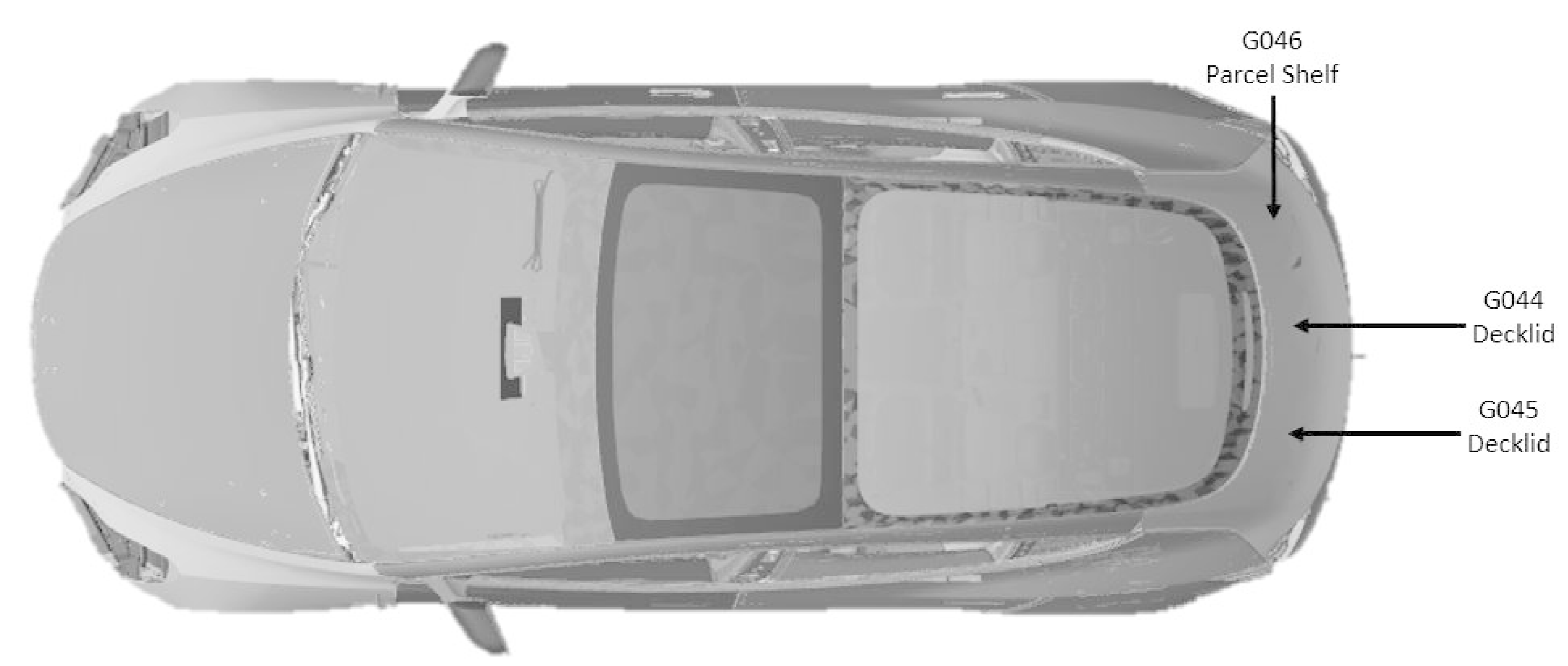
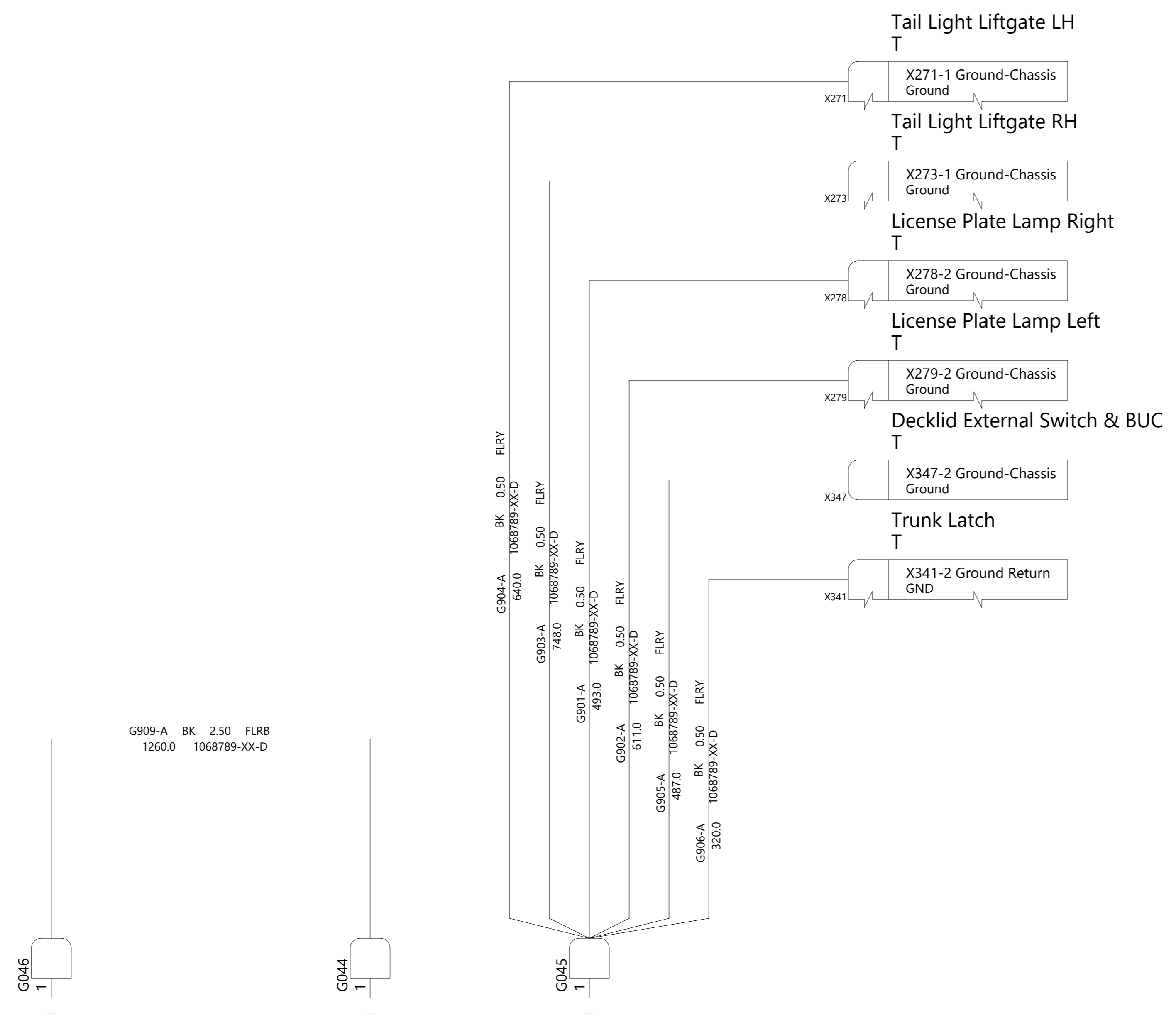

TESLA

THE INFORMATION CONTAINED HEREIN IS DEEMED TO BE CONFIDENTIAL, PROPRIETARY, AND A TRADE SECRET OF TESLA MOTORS. THIS INFORMATION MAY NOT BE USED, REPRODUCED, OR DISCLOSED AS THE DIRECT OR INDIRECT BASIS FOR THE DEVELOPMENT, MANUFACTURE, OR SALE OF PROCESSES OR PRODUCTS WITHOUT THE EXPRESSED WRITTEN CONSENT OF TESLA MOTORS.

DRAWN	CHECKED	APPROVED
MATERIAL AS SPECIFIED	FINISHING AS SPECIFIED	SCALE NONE
PART NAME Power Distribution, Grounding Trunk		
PART NUMBER	REV	SHEET
	2	9 OF 9
		SIZE A0