



Model S EDR Data Retrieval Guide For Vehicles Built After 2/25/2019

Introduction

The Tesla Model S is equipped with an event data recorder (EDR). The EDR records data related to vehicle dynamics and safety systems when the system senses a crash or a crash-like situation, such as hitting a road obstacle. This data is stored in the vehicle’s Restraints Control Module (RCM).

This guide describes how to retrieve EDR data from the RCM of a Tesla Model S built after February 25, 2019. For Model S vehicles built up to or on February 25, 2019 refer to “Model S EDR Data Retrieval Guide – Vehicles Built Through 2/25/2019” (Tesla part number CD-18-20-001).

Contents

- Introduction..... 1
- Tools Required 2
- Establish an In-Vehicle Connection..... 4
- Establish a Direct-to-Module Connection 7
 - RCM Direct Connection (RCM In Model S)..... 8
 - RCM Direct Connection (RCM Removed From Model S) 13
- Using External Power for the RCM..... 19
- Retrieve Data 22
- For Further Assistance 23

This guide and other Tesla EDR information can be found at <https://edr.tesla.com>.

There are two methods for connecting to the RCM:

1. In-vehicle connection, which allows you to connect to the RCM without removing it from the vehicle. An in-vehicle connection may not be possible if the vehicle has extensive damage. If an in-vehicle connection can be established, data is retrieved with less vehicle disassembly than when using a direct-to-module connection. For more information about in-vehicle retrieval, refer to “Establish an In-Vehicle Connection,” on page 4.
2. Direct-to-module connection, which requires that you physically remove the RCM from the vehicle, then connect to it and retrieve the data. For more information about direct-to-module retrieval, refer to “Establish a Direct-to-Module Connection,” on page 7.

NOTE: The RCM in vehicles built after February 25, 2019 uses different connectors than RCM in vehicles built through February 25, 2019. When making a direct-to-module connection to the RCM, make sure to have the correct cable. Refer to the “Direct-to-module connection” section of Table 1. EDR Data Retrieval Cable requirements for more information.

Tools Required

To retrieve the data from the RCM, you will need the following special tools:

- PCAN-USB Adapter
- A Windows computer running the Tesla EDR Retrieval Program, which you can download at <https://edr.tesla.com/download>
- An appropriate data retrieval cable:

Retrieval Method	Model S Build Date	Required Cable
In-vehicle connection	After September 14, 2016	Tesla In-Vehicle EDR Retrieval Cable. Tesla part number 1131144.
Direct-to-module connection	After February 25, 2019	Tesla Model S Direct-To-Module EDR Retrieval Cable. Tesla part number 1492139.

Table 1. EDR Data Retrieval Cable requirements



Vehicle RCM	Description and information
	<p>In vehicles built after February 25, 2019, this version of the RCM has black connectors and uses retention latches to secure the RCM connectors to the vehicle wiring harness.</p> <p>NOTE: There are no retention latches to secure the connectors to the Direct-To-Module EDR Retrieval Cable.</p> <p>Cable Required: Tesla Model S Direct-To-Module EDR Retrieval Cable. Tesla part number 1492139.</p>
	<p>In vehicles built through February 25, 2019, this version of the RCM has red connectors and uses retention latches on the cable to secure the RCM connectors to the vehicle wiring harness and to the Direct-To-Module EDR Retrieval Cable.</p> <p>NOTE: Refer to the Model S EDR Data Retrieval Guide – Vehicles Built Through 2/25/2019 (Tesla part number CD-18-20-001) for information about making a direct connection to the RCM in these vehicles.</p>

Table 2. RCM version and required EDR Data Retrieval Cable

NOTE: The vehicle manufacture month and year can be found on the label attached to the B-pillar. If necessary, contact Tesla customer support to obtain the actual vehicle build date.

Required cables and software are available at <https://edr.tesla.com>.

Establish an In-Vehicle Connection

1. Locate the storage pocket under the touchscreen.



Figure 1. Locating the storage pocket

2. Push down on inside bottom corners of the storage pocket until the clips securing it release.

NOTE: It may be necessary to remove an after-market center console to allow the removal of the storage pocket.



Figure 2. Releasing the storage pocket

CAUTION: The storage pocket clips might require a large amount of force to release and they might release suddenly. Do not place fingers between the bottom of the pocket and the top of the center console.

3. Remove the storage pocket by pulling it towards the rear of the vehicle.



Figure 3. Removing the storage pocket

4. Locate the rectangular vehicle communication harness under the touchscreen, gently pull it toward you.

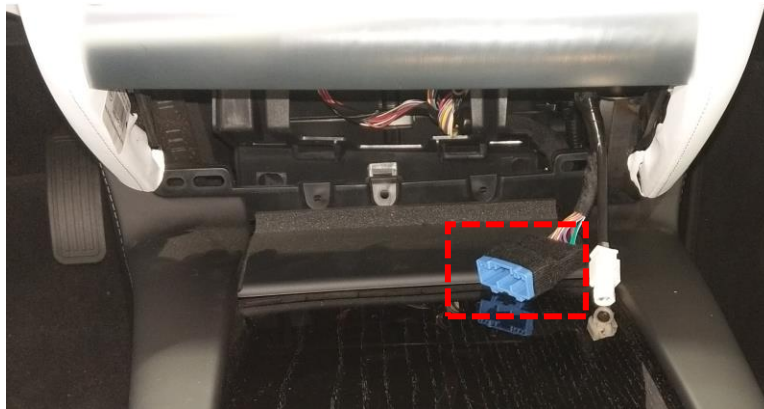

Figure 4. Moving the vehicle communication harness into position

NOTE: Depending on vehicle build date, this connector may be blue or white.

5. Connect the appropriate In-Vehicle EDR Retrieval Cable (refer to “Table 1. EDR Data Retrieval Cable requirements,” on page 2 to find the required cable for your vehicle).



Figure 5. Moving the vehicle communication harness into position

6. Connect the other end of the In-Vehicle EDR Retrieval Cable to the PCAN-USB adapter.
7. Connect the PCAN-USB adapter to the computer used for retrieval.

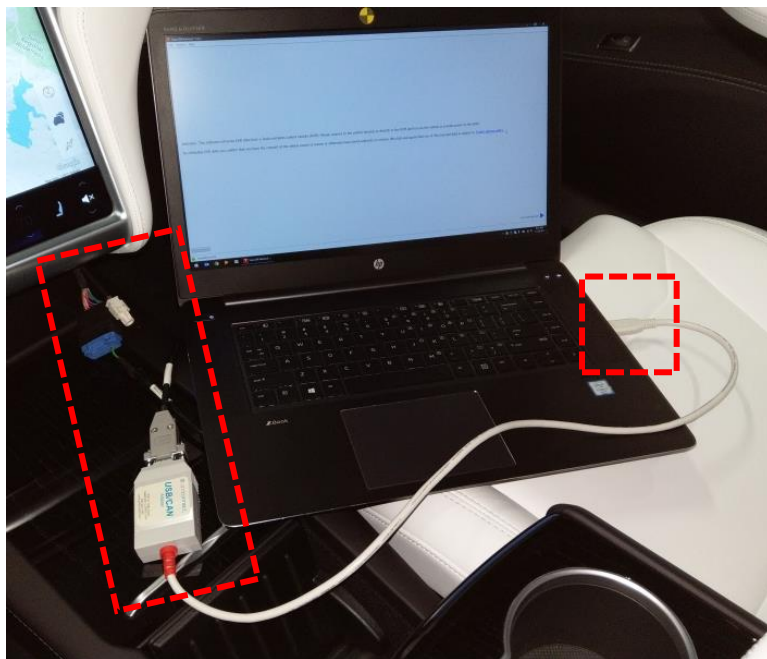

Figure 6. Computer connected to the in-vehicle EDR retrieval cable to the PCAN-USB adapter

8. Place the key-fob inside of the vehicle and press the brake pedal, which should result in the instrument cluster turning on.
 - If successful, proceed to “Retrieve Data” on page 22.
 - If the instrument cluster does not turn on, perform the procedure described in “Using External Power for the RCM” on page 19.

Establish a Direct-to-Module Connection

If the In-Vehicle Connection procedure is unsuccessful, you might be able to connect to the RCM directly, and establish a direct-to-module connection. The RCM is located forward of the center console, below the instrument panel and center screen.

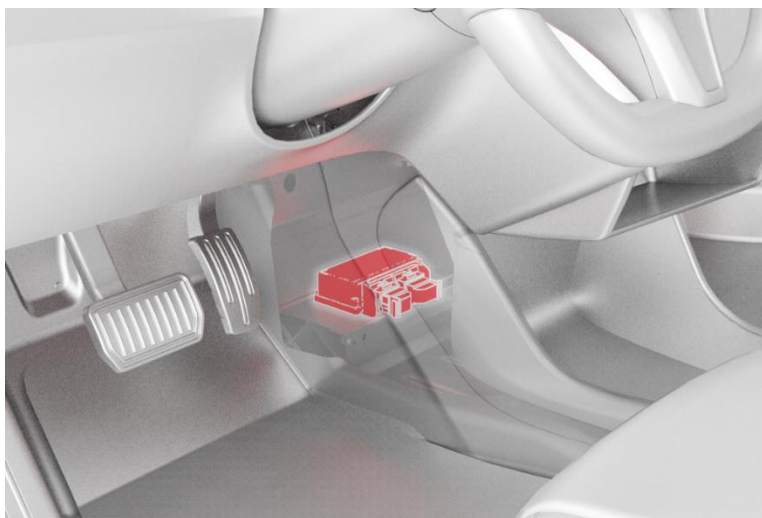

Figure 7. Model S RCM location

The RCM can be left in the vehicle, but if necessary it can be removed from the vehicle:

- For information on making a direct connection with the RCM while it is still in the Model S, see “RCM Direct Connection (RCM In Model S),” on page 8.
- For information on making a direct connection with the RCM after it has been removed from the Model S, see “RCM Direct Connection (RCM Removed From Model S),” on page 13.

RCM Direct Connection (RCM In Model S)

To connect to the RCM while it is still in the Model S:

1. Remove the LH wrapped panel trim.

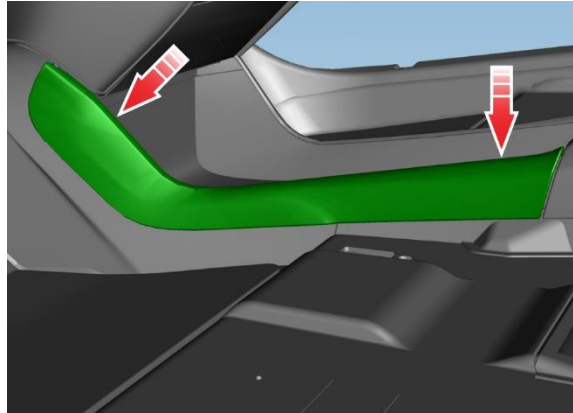

Figure 8. Wrapped panel trim location

2. Release the clips (10) that secure the wrapped panel trim.

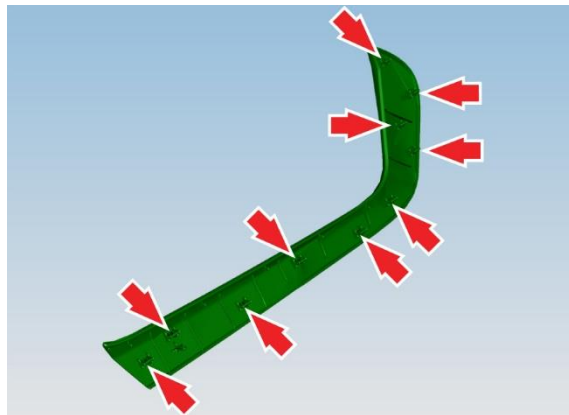

Figure 9. Wrapped panel trim clips (inside view)

3. Remove floor mat from footwell.

4. Remove the LH side panel from the center console.

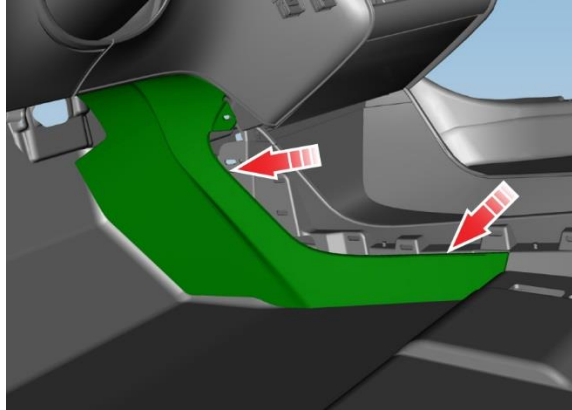

Figure 10. Center console side panel location

5. Release clips (8) and adhesive pad (1) securing the side panel to the console.

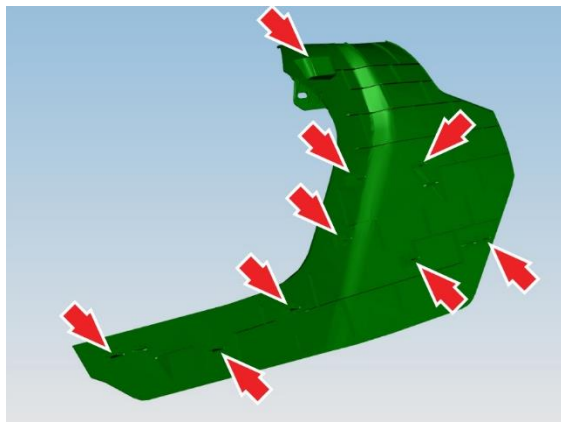

Figure 11. Center console side panel clips (inside view)

CAUTION: Take care not to damage components.

6. Remove the center console side panel.

7. Remove the bolts (3) that secure the air suspension mounting bracket to the body.

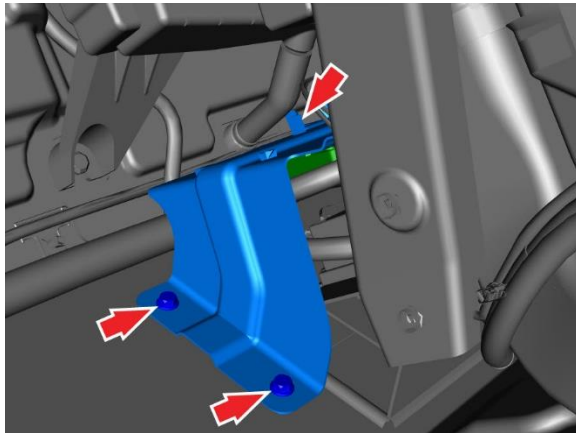

Figure 12. Air suspension mounting bracket location

NOTE: The horizontal bolt might be obscured by an acoustic pad. If it is, carefully move the acoustic pad aside for access.

8. From the LH footwell, disconnect the HVAC drain hose from the HVAC nipple.



- A HVAC nipple
- B HVAC drain hose

Figure 13. HVAC drain hose location

9. Gently lift up on the bracket and disconnect the harness connectors (2) at the rear of the air suspension ECU.

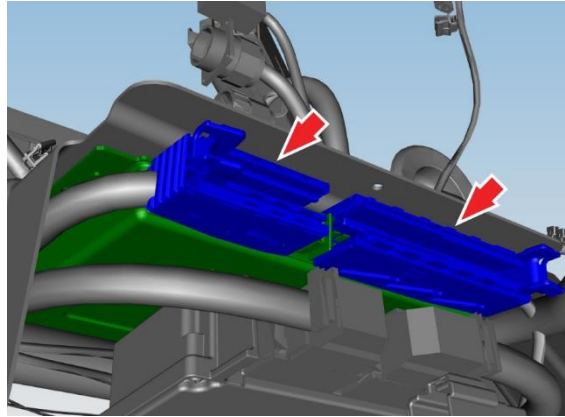

Figure 14. Air suspension ECU location

NOTE: Carefully place the bracket between the bulkhead and the HVAC drain hose.

NOTE: The bracket rests on the HVAC drain hose.

10. Disconnect the RCM harness connectors (x2).

NOTE: The RCM for vehicles built through February 25, 2019 uses a different retention latch mechanism to secure harness connectors than the RCM for vehicles built after February 26, 2019.

- a. Move the connector retention latches toward the outboard side of the vehicle.

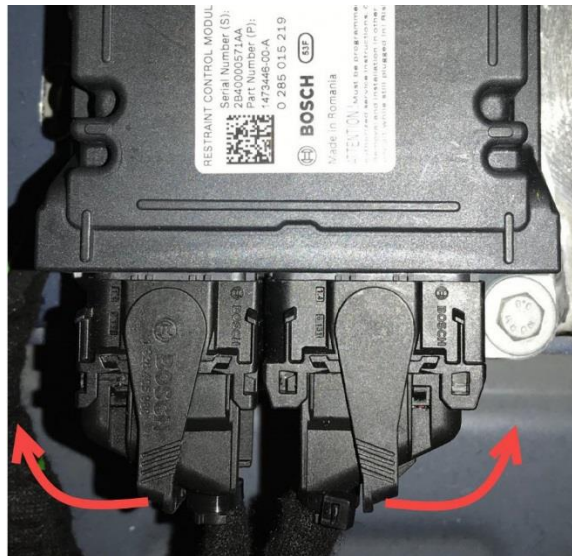

Figure 15. Disconnect the RCM connectors

- b. Carefully grasp the larger connector and pull it straight away from the RCM.
- c. Carefully grasp the smaller connector and pull it straight away from the RCM.

11. Connect the Tesla Model S Direct-To-Module EDR Retrieval Cable to the RCM.

RCM in vehicle	Connection information
	<p>Connect the data retrieval cable to both connectors.</p> <p>NOTE: This version of the RCM does not have retention latches. Make sure the data retrieval cable is firmly seated.</p> <p>Cable Required: Tesla Model S Direct-To-Module EDR Retrieval Cable. Tesla part number 1492139.</p>

Table 3. Connecting the EDR Data Retrieval Cable to the RCM

12. Connect the Tesla Model S Direct-To-Module EDR Retrieval Cable to the PCAN-USB adapter.

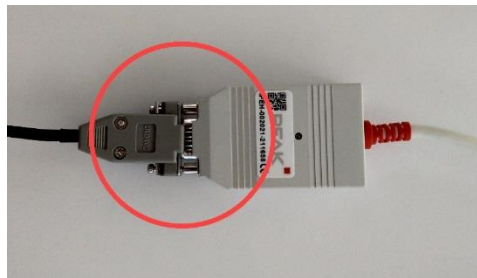

Figure 16. Connecting the EDR retrieval cable to the PCAN

13. Connect the PCAN-USB adapter to the computer used for data retrieval.



Figure 17. Connecting the PCAN to the computer

14. Connect 12V power to the Tesla Model S Direct-To-Module EDR Retrieval Cable.

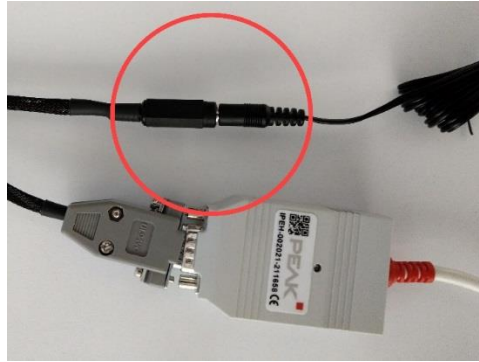

Figure 18. Connecting 12V power to the EDR retrieval cable

15. Proceed to “Retrieve Data” on page 22 to complete the data retrieval procedure.

RCM Direct Connection (RCM Removed From Model S)

To remove the RCM from the Model S, and make a direct connection, complete the following steps:

1. Remove the LH wrapped panel trim.

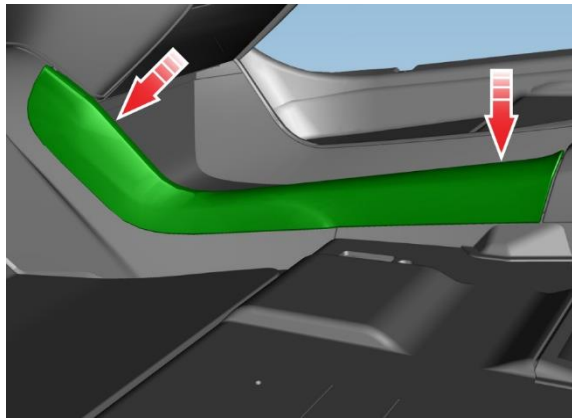

Figure 19. Wrapped panel trim location

2. Release the clips (10) that secure the wrapped panel trim.

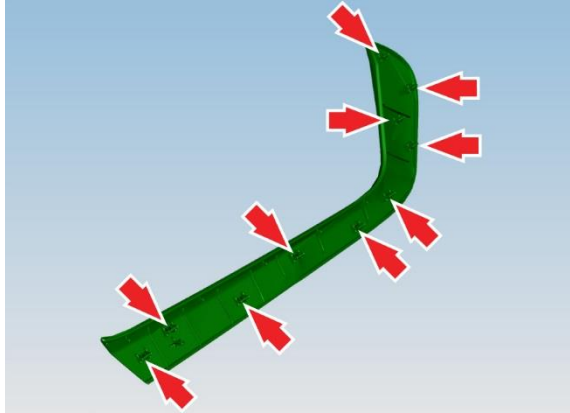

Figure 20. Wrapped panel trim clips (inside view)

3. Remove floor mat from footwell.
4. Remove the LH side panel from the center console.

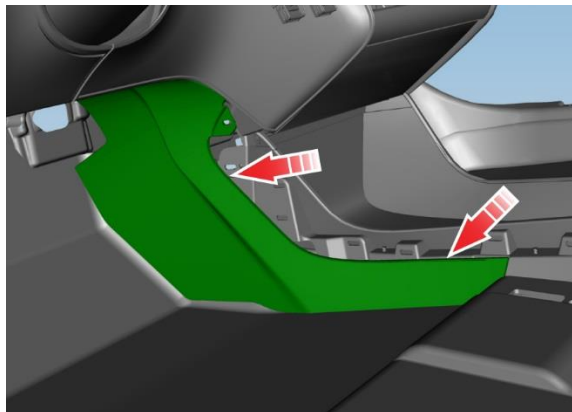

Figure 21. Center console side panel location

5. Release clips (8) and adhesive pad (1) securing the side panel to the console.

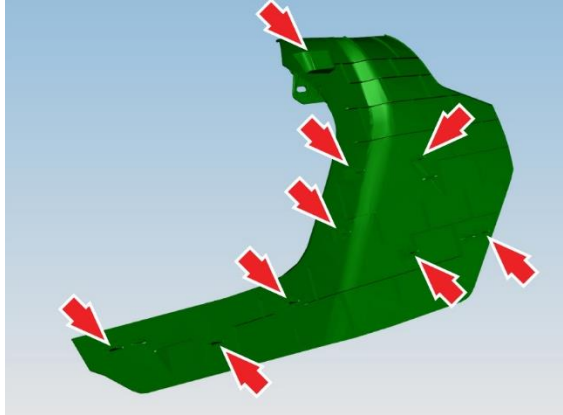

Figure 22. Center console side panel clips (inside view)

CAUTION: Take care not to damage components.

6. Remove the center console side panel.
7. Remove the bolts (3) that secure the air suspension mounting bracket to the body.

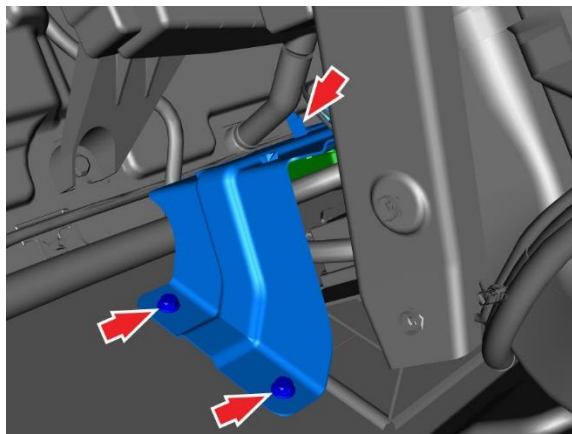

Figure 23. Air suspension mounting bracket location

NOTE: The horizontal bolt might be obscured by an acoustic pad. If it is, carefully move the acoustic pad aside for access.

- From the LH footwell, disconnect the HVAC drain hose from the HVAC nipple.

CAUTION: When disconnecting the HVAC drain hose, residual water may drain from the hose, so make sure not to allow any water to drain onto the vehicle electronics.



- A HVAC nipple
- B HVAC drain hose

Figure 24. HVAC drain hose location

- Gently lift up on the bracket and disconnect the harness connectors (2) at the rear of the air suspension ECU.

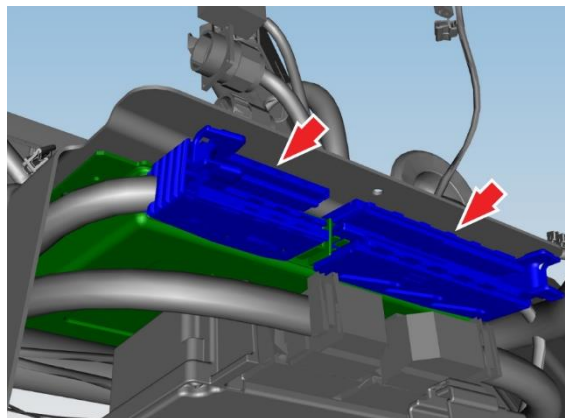

Figure 25. Air suspension ECU location

NOTE: Carefully place the bracket between the bulkhead and the HVAC drain hose.

NOTE: The bracket rests on the HVAC drain hose.

10. Disconnect the RCM harness connectors (x2).

- a. Move the connector retention latches toward the outboard side of the vehicle.

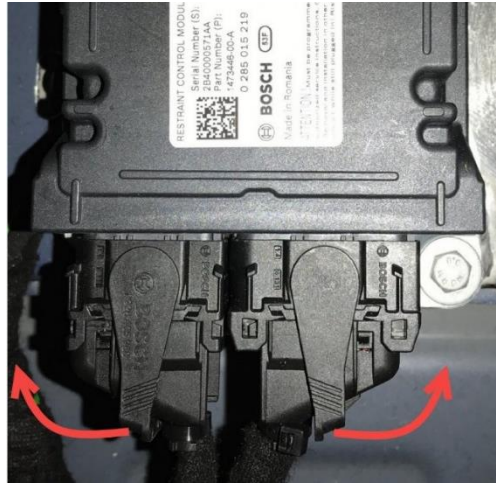

Figure 26. Disconnect the RCM connectors

- b. Carefully grasp the larger connector and pull it straight away from the RCM.
 - c. Carefully grasp the smaller connector and pull it straight away from the RCM.
11. Remove the T30 Torx bolts (3) that secure the passive safety restraint control module (RCM) to the body.

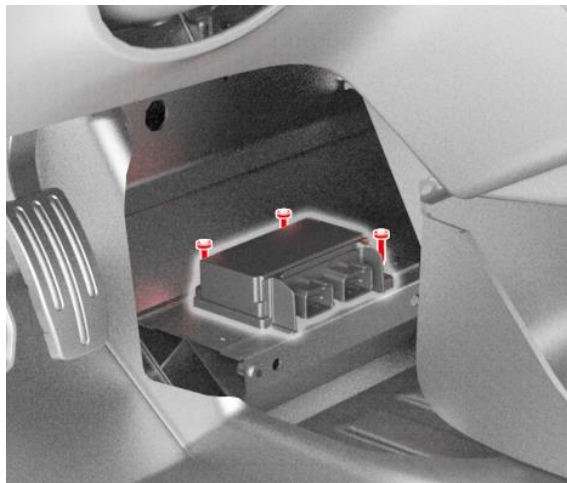

Figure 27. RCM mounting bolts

12. Remove the RCM from the Model S and place it on a stable surface.

13. Connect the Tesla Model S Direct-To-Module EDR Retrieval Cable to the RCM.

Attach both EDR Retrieval Cable connectors to the RCM (Figure 28). Make sure both connectors are fully seated.

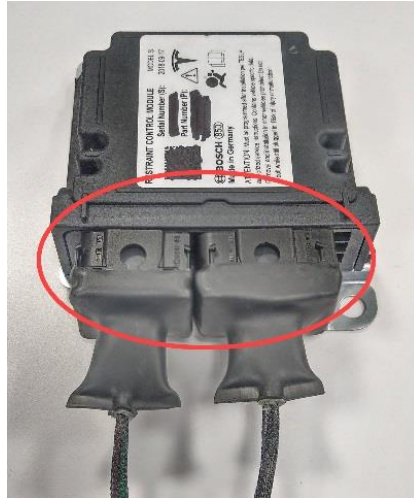

Figure 28. Connecting the EDR retrieval cable to the RCM

14. Connect the Tesla Model S Direct-To-Module EDR Retrieval Cable to the PCAN-USB adapter.

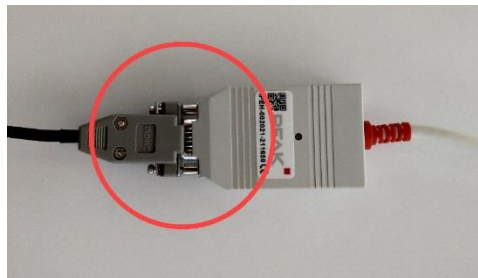

Figure 29. Connecting the EDR retrieval cable to the PCAN

15. Connect the PCAN-USB adapter to the computer used for data retrieval.

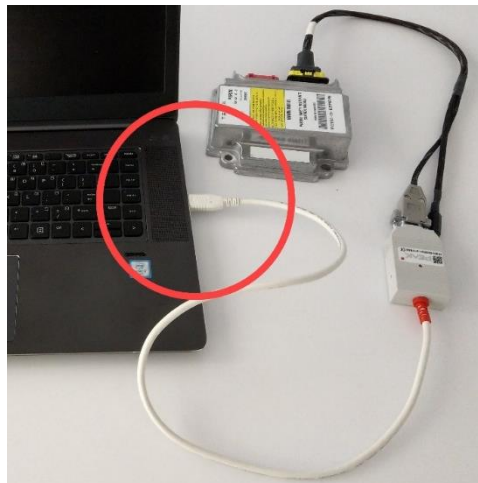

Figure 30. Connecting the PCAN to the computer

16. Connect 12V power to the Tesla Model S Direct-To-Module EDR Retrieval Cable.

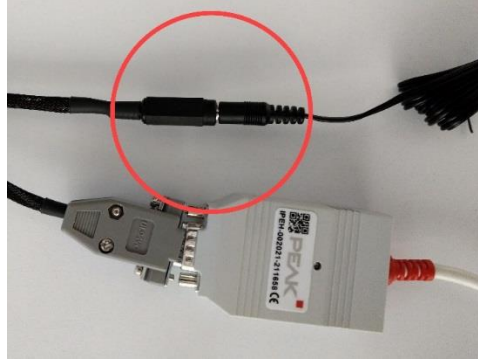

Figure 31. Connecting 12V power to the EDR retrieval cable

17. Proceed to “Retrieve Data” on page 22 to complete the data retrieval procedure.

Using External Power for the RCM

Externally powering the RCM refers to applying power to the RCM via the vehicle’s “first responder’s loop,” located in the front trunk. This procedure can be used if a key-fob is not available, 12V DC power is not available to the vehicle system, or the vehicle is otherwise unable to turn on.

NOTE: This procedure requires an external source of 12V power.

WARNING: Follow all manufacturer’s instructions for safe use of the external 12V power source.

1. Open the front hood by using one of the following methods:
 - The touchscreen: touch **Controls > Front Trunk**.



Figure 32. Opening the frunk using the touchscreen

- The key fob: double click the front trunk button on the key fob.

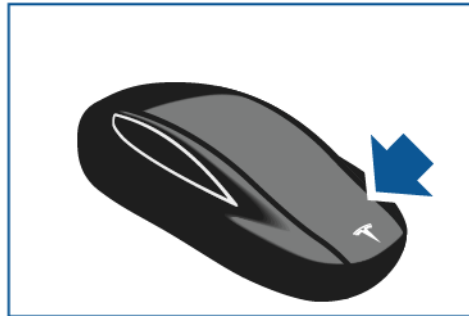

Figure 33. Opening the frunk using the key fob

2. Remove the first responder loop access panel by pulling its rear edge upward to release the five clips that hold it in place. Maneuver the access panel toward the windshield to remove it from the vehicle.



Figure 34. Opening the first responder access panel

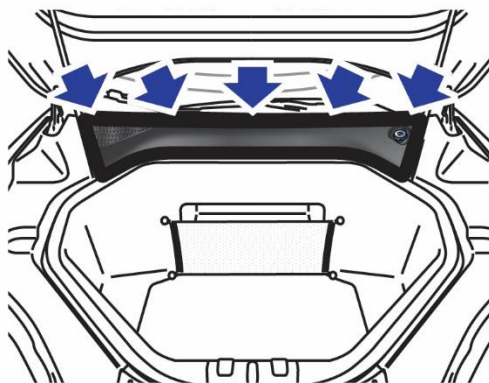

Figure 35. Removing the first responder access panel

3. Disconnect the first responder loop harness.

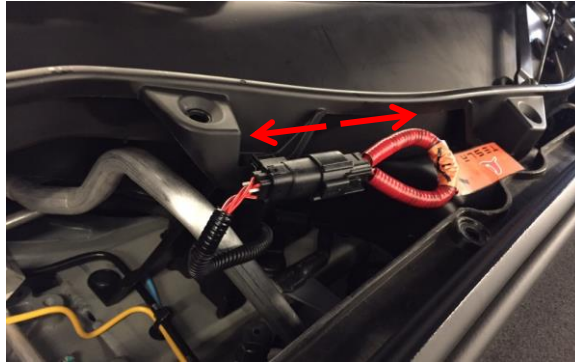

Figure 36. Disconnecting the first responder loop harness

WARNING: Wait at least 2 minutes for all electrical circuits to fully discharge.

4. Connect the negative terminal of the external 12V power source to the vehicle chassis.
5. Connect the positive terminal of the 12V source to pin 3 of the first responder harness.



Figure 37. Connector pin layout

6. Proceed to the “Retrieve Data” section of this document to complete data retrieval.

Retrieve Data

1. Open the Tesla EDR Retrieval Program. The program automatically attempts to connect to the RCM.
 - When connected properly, a green circle and the message “Connected to RCM” displays on the bottom left corner of the window (see Figure 38. EDR program successful connection).

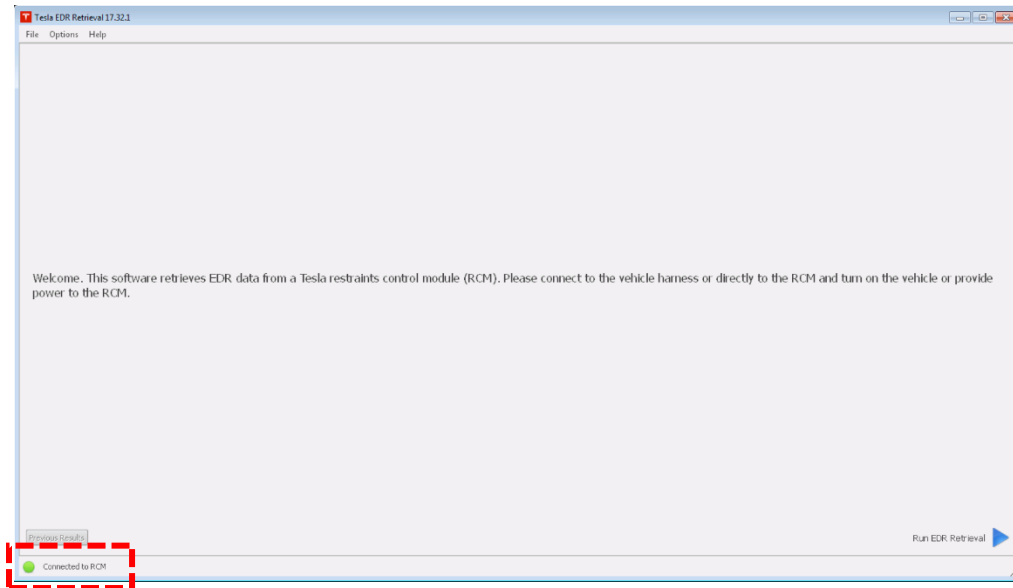

Figure 38. EDR program successful connection

- If the Tesla EDR Retrieval Program is not communicating with the PCAN-USB adapter, a message displays “Not Connected to PCAN.”
Check the connection to the PCAN-USB adapter.
- If the Tesla EDR Retrieval Program is communicating with the PCAN-USB adapter, but is not communicating with the RCM, a message displays “Not Connected to RCM.”

Check the connection to the vehicle harness and the vehicle power. If a successful connection through the vehicle communication system cannot be achieved, connect to the RCM using the procedure described in “Establish a Direct-to-Module Connection” on page 7.

2. Once connected to the EDR, click “Run EDR Retrieval” and follow the on-screen prompts to retrieve and save EDR data.



Figure 39. Retrieving data using the Tesla EDR retrieval program

The retrieved *.edr data file can be used to generate a Tesla EDR Report at <https://edr.tesla.com>.

For Further Assistance

For technical support, please contact the exclusive Tesla EDR hardware distributor, Crash Data Group:

Email: crash@crashdatagroup.com

Phone: (951) 252-9254

Toll Free: (800) 280-7940