



MODEL X

2015-2020

OWNER'S MANUAL



Software version: 2022.12
North America

YOUR OWNER'S MANUAL

For the latest and greatest information that is customized to your vehicle, view the Owner's Manual on your vehicle's touchscreen by touching **Controls > Service > Owner's Manual**. The information is specific to your vehicle depending on the features you purchased, vehicle configuration, market region and software version. In contrast, owner information that is provided by Tesla elsewhere is updated as necessary and may not contain information unique to your vehicle.

RELEASE NOTES

Information about new features is displayed on the touchscreen after a software update, and can be viewed at any time by touching **Controls > Software > Release Notes**. If the content in the Owner's Manual on how to use your vehicle conflicts with information in the Release Notes, the Release Notes take precedence.

ILLUSTRATIONS AND PRODUCT SPECIFICATIONS

The illustrations provided in this document are for demonstration purposes only. Depending on vehicle options, software version and market region, the information displayed on the touchscreen in your vehicle may appear slightly different.

All specifications and descriptions contained in this document are verified to be accurate at the time of printing. However, because continuous improvement is a goal at Tesla, we reserve the right to make product modifications at any time. To communicate any inaccuracies or omissions in this document, please send an email to: ownersmanualfeedback@tesla.com.

SAFETY INFORMATION

You can find safety information in your Model X Owner's Manual on the touchscreen.

For detailed information about your Model X, go to the Tesla website for your region, log on to your Tesla account, or sign up to get an account.

If you have any questions or concerns about your Model X, call 1-877-79TESLA (1-877-798-3752).

© 2012-2022 TESLA, INC.

All information in this document and all vehicle software is subject to copyright and other intellectual property rights of Tesla, Inc. and its licensors. This material may not be modified, reproduced or copied, in whole or in part, without the prior written permission of Tesla, Inc. and its licensors. Additional information is available upon request. Shown here are trademarks or registered trademarks of Tesla, Inc. in the United States and other countries:

MODEL 3 MODEL S TESLA TESLA ROADSTER

MODEL Y MODEL X TESLA MOTORS T E S L A



Overview	2	Collision Avoidance Assist.....	127
Exterior Overview.....	2	Speed Assist.....	130
Interior Overview.....	3		
Touchscreen Overview.....	5	Using the Touchscreen	132
		Controls.....	132
Opening and Closing	8	Climate Controls.....	138
Keys and Doors.....	8	Maps and Navigation.....	143
Windows.....	16	Media.....	148
Rear Trunk.....	17	Entertainment.....	151
Front Trunk.....	19	Phone and Calendar.....	154
Interior Storage and Electronics.....	21	Air Suspension.....	157
Sun Visors.....	25	Voice Commands.....	159
		Security Settings.....	161
Seating and Safety Restraints	26	Dashcam and Sentry Mode.....	162
Front and Rear Seats.....	26	HomeLink Universal Transceiver.....	165
Seat Belts.....	31	Connecting to Wi-Fi.....	168
Child Safety Seats.....	34	Software Updates.....	169
Airbags.....	42	Mobile App.....	171
		Charging	173
Driving	48	Electric Vehicle Components.....	173
Driver Profiles.....	48	High Voltage Battery Information.....	175
Steering Wheel.....	50	Charging Instructions.....	176
Mirrors.....	53		
Starting and Powering Off.....	54	Maintenance	182
Shifting.....	56	Maintenance Schedule.....	182
Lights.....	57	Tire Care and Maintenance.....	184
Instrument Panel.....	60	Cleaning.....	190
Wipers and Washers.....	66	Wiper Blades and Washer Jets.....	193
Braking and Stopping.....	67	Fluid Reservoirs.....	195
Traction Control.....	70	Jacking and Lifting.....	197
Park Assist.....	71	Parts and Accessories.....	198
Vehicle Hold.....	73		
Acceleration Modes.....	74	Specifications	199
Trip Information.....	76	Identification Labels.....	199
Getting Maximum Range.....	77	Vehicle Loading.....	200
Rear Facing Camera(s).....	79	Dimensions and Weights.....	203
Pedestrian Warning System.....	80	Subsystems.....	205
Active Spoiler.....	81	Wheels and Tires.....	207
Towing and Accessories.....	82		
Cold Weather Best Practices.....	91	Roadside Assistance	214
		Contacting Tesla Roadside Assistance.....	214
Autopilot	93	Instructions for Transporters.....	215
About Autopilot.....	93		
Traffic-Aware Cruise Control.....	96	Consumer Information	218
Autosteer.....	101	About this Owner Information.....	218
Navigate on Autopilot.....	106	Disclaimers.....	220
Traffic Light and Stop Sign Control.....	109	Reporting Safety Defects.....	222
Autopark.....	116	Radio Regulatory Compliance.....	223
Summon.....	118	Troubleshooting Alerts.....	226
Smart Summon.....	121		
		Active Safety Features	124
Active Safety Features	124	Lane Assist.....	124
Lane Assist.....	124	Index	263



Exterior Overview

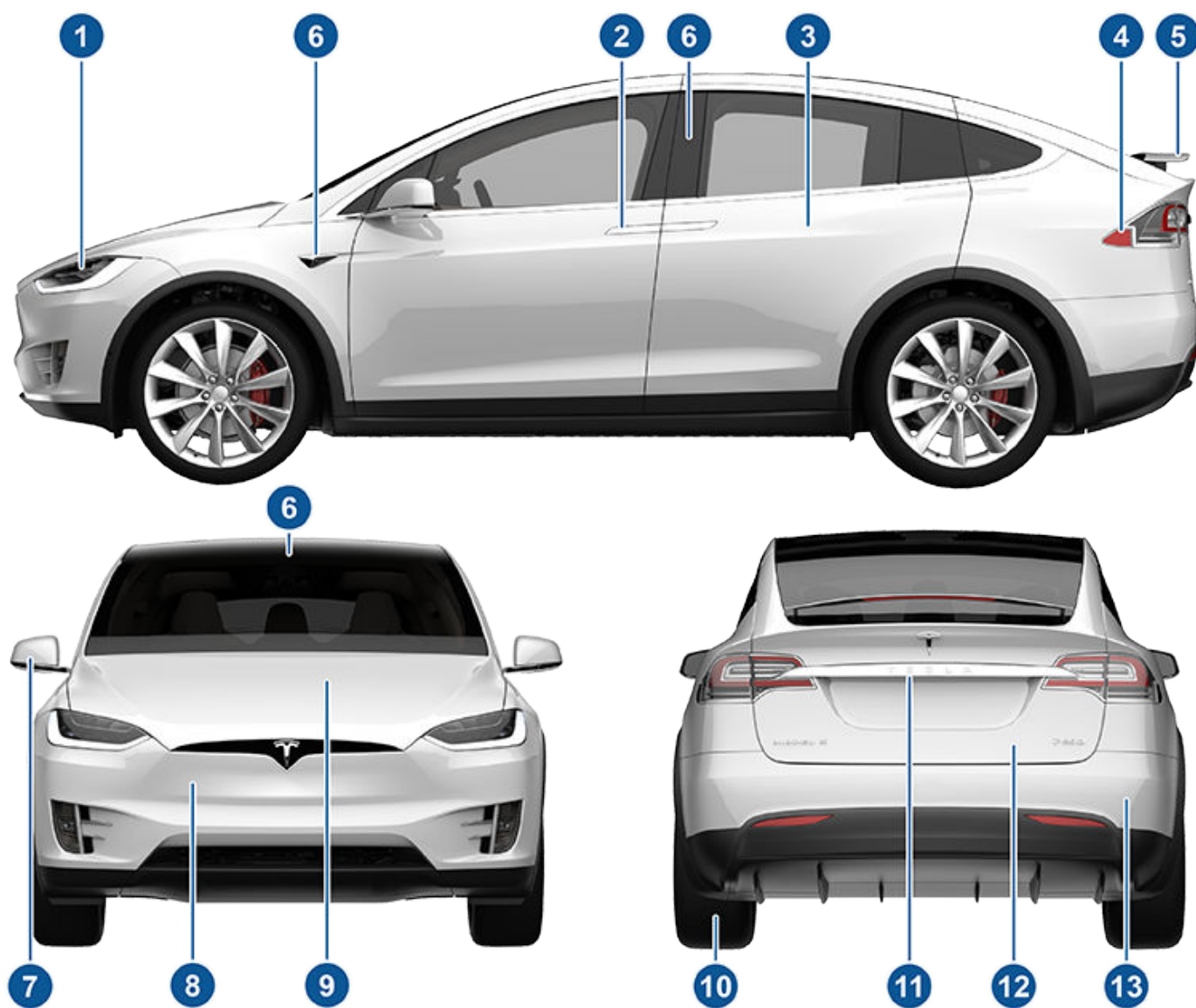

1. Exterior lights ([Lights on page 57](#))
2. Front doors ([Keys and Doors on page 8](#))
3. Falcon wing doors ([Keys and Doors on page 8](#))
4. Charge port ([Charging Instructions on page 176](#))
5. Active spoiler (optional) ([Active Spoiler on page 81](#))
6. Autopilot cameras ([About Autopilot on page 93](#))
7. Exterior mirrors ([Mirrors on page 53](#))
8. Radar sensor (hidden from view in the above image) ([About Autopilot on page 93](#))
9. Hood/Front trunk ([Front Trunk on page 19](#))
10. Wheels and tires ([Wheels and Tires on page 207](#))
11. Rear view camera ([Rear Facing Camera\(s\) on page 79](#) and [About Autopilot on page 93](#))
12. Rear trunk/liftgate ([Rear Trunk on page 17](#))
13. Ultrasonic sensors ([Park Assist on page 71](#) and [About Autopilot on page 93](#))

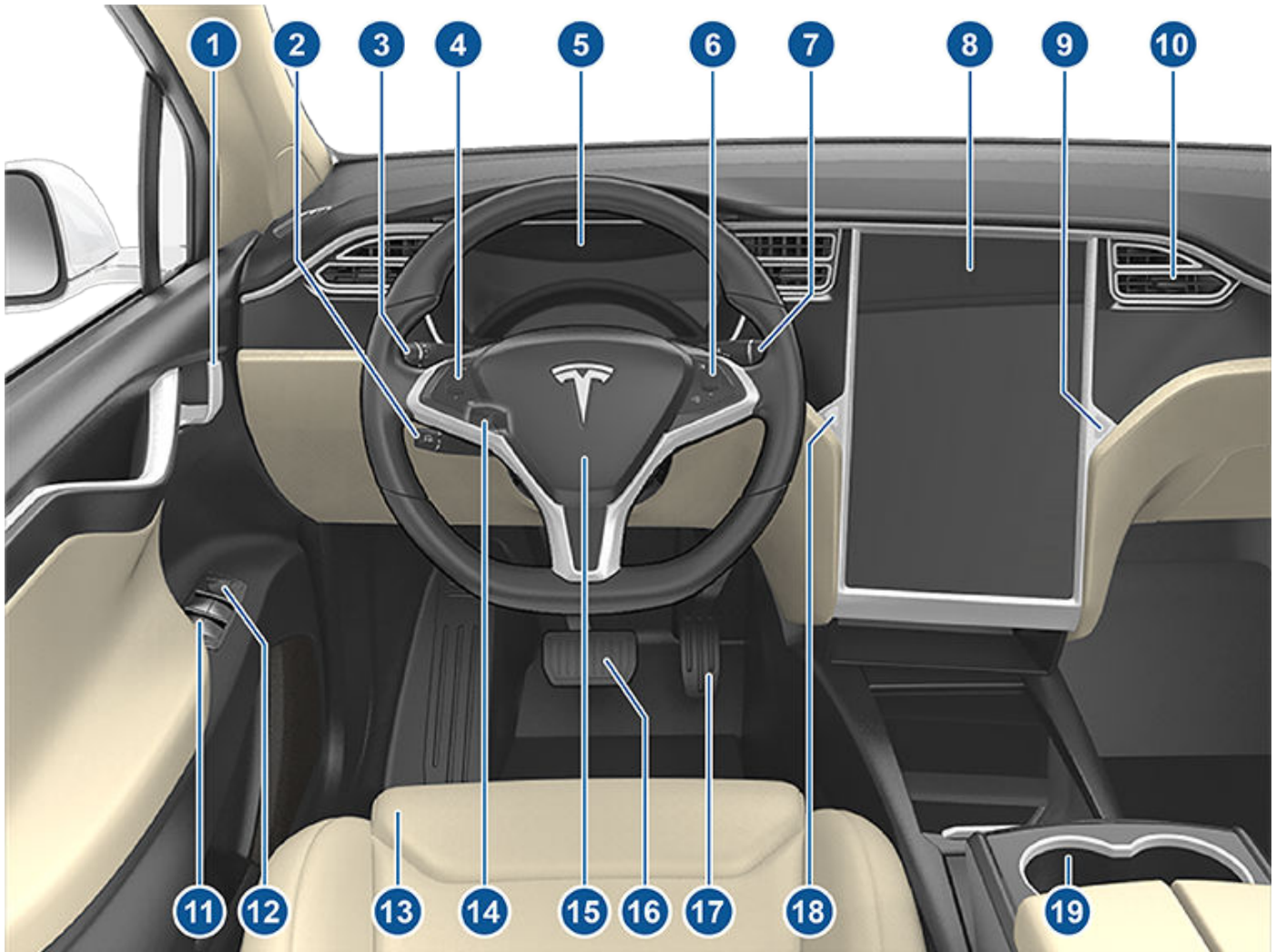

1. Interior door handles ([Opening Doors from the Interior](#) on page 10)
2. Autopilot stalk ([Traffic-Aware Cruise Control](#) on page 96 and [Autosteer](#) on page 101)
3. Turn signal stalk ([High Beam Headlights](#) on page 57, [Turn Signals](#) on page 58, [Wipers and Washers](#) on page 66)
4. Steering wheel buttons - left ([Using Left Steering Wheel Buttons](#) on page 50)
5. Instrument panel ([Instrument Panel](#) on page 60)
6. Steering wheel buttons - right ([Using Right Steering Wheel Buttons](#) on page 51)
7. Drive stalk ([How to Shift](#) on page 56)
8. Touchscreen ([Touchscreen Overview](#) on page 5)
9. Glovebox button ([Glovebox](#) on page 21)
10. Cabin climate control ([Climate Controls](#) on page 138)
11. Power window switches ([Opening and Closing](#) on page 16)
12. Exterior mirror adjustment switches ([Mirrors](#) on page 53)
13. Seats ([Front and Rear Seats](#) on page 26)
14. Steering column adjuster (hidden from view in the above image) ([Steering Wheel](#) on page 50)
15. Horn ([Horn](#) on page 51)
16. Brake pedal ([Braking and Stopping](#) on page 67)
17. Accelerator pedal ([Acceleration Modes](#) on page 74)



Interior Overview

- 18. Hazard warning lights ([Hazard Warning Flashers on page 59](#))
- 19. Cup holders ([Cup Holders on page 24](#))



WARNING: Always pay attention to road and traffic conditions when driving. To minimize driver distraction and ensure the safety of vehicle occupants as well as other road users, avoid using the touchscreen to adjust settings while the vehicle is in motion.

Use the touchscreen to control many features that, in traditional cars, are controlled using physical buttons (for example, adjusting the cabin heating and air conditioning, headlights, etc.). You also use the touchscreen to control media, navigate, use entertainment features, and customize Model X to suit your preferences. The main component of the touchscreen is the map area. Other main components are shown here:

NOTE: Illustrations are provided to improve conceptual understanding only. Depending on vehicle options, software version, market region and regional and language settings, the details displayed on the screen will differ.

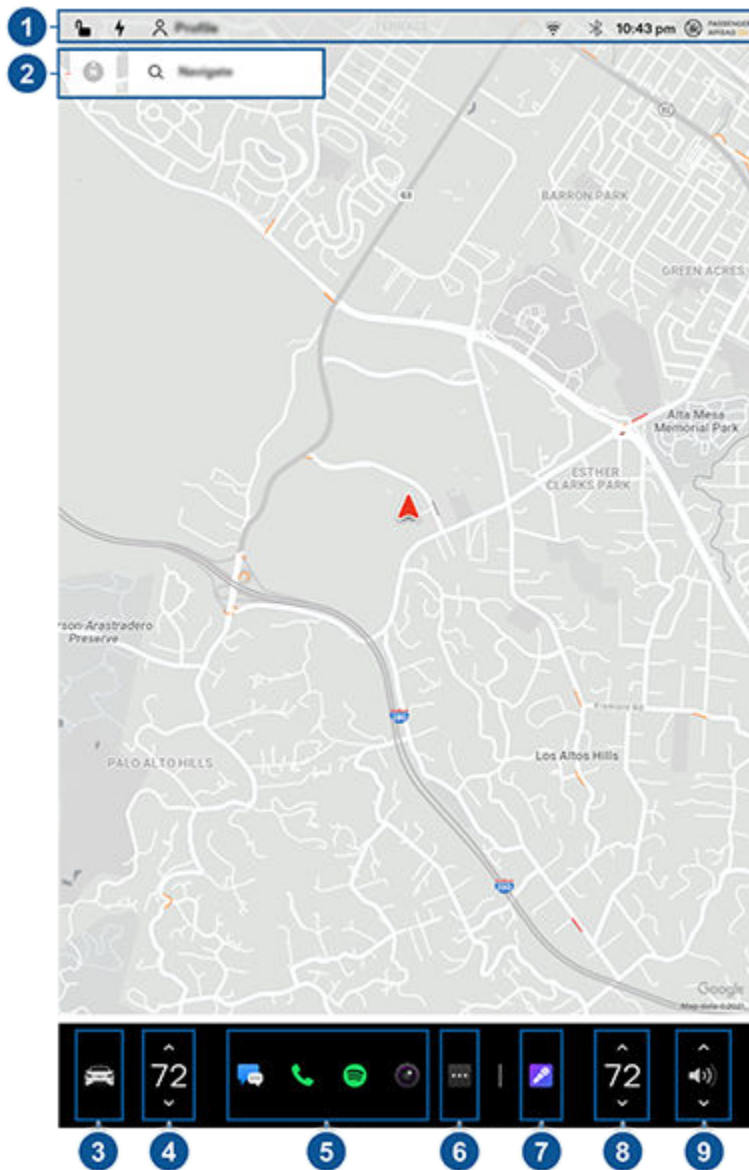

1. **Status bar:** This area on the top of the touchscreen displays the time of day, the outside temperature, and the following icons:



Touch to lock/unlock all doors and trunks.



Touchscreen Overview



Status of the front passenger airbag (see [Airbags on page 42](#)).



Displays when a software update is available (see [Software Updates on page 169](#)).



Add, configure, or quickly switch driver profiles (including Valet Mode and Easy Entry). See [Driver Profiles on page 48](#).



Control or program HomeLink devices (if equipped) (see [HomeLink Universal Transceiver on page 165](#)).



Displays when a notification is in effect. Touch to display information about the notification. To display a list of the most recent notifications, with the most recent listed first, you can also touch **Service > Notifications**.



Connected to a Wi-Fi network.



Connected to cellular network. Touch to connect to Wi-Fi (see [Connecting to Wi-Fi on page 168](#)).



Connect to a Bluetooth device (see [Pairing a Bluetooth Phone on page 154](#)).

2. **Navigation:** Change the orientation of the map, find or navigate to a destination, and change navigation settings (see [Maps and Navigation on page 143](#)).
3. **Controls:** Control various features and adjust settings to customize your Model X (see [Controls on page 132](#)).
4. **Climate controls (driver):** Use the left and right arrows to decrease/increase cabin temperature. Touch **Split** on the popup to display separate controls for the driver and passenger. Touch the temperature icon to customize climate control settings (see [Climate Controls on page 138](#)).
5. **My Apps:** For one-touch access to frequently used apps and controls, you can choose what displays here. See [Customizing My Apps on page 7](#).
6. **App Launcher:** Touch the app launcher to open the app tray. Then touch any app to open it. The app you choose displays on top of the map. To close an app, drag it downward.
7. **Recent App(s):** Displays the most recently used app(s). The number of recent apps displayed here depends on how many apps have been added to **My Apps**. If you add the maximum number of apps to **My Apps**, only the most recent app displays.
8. **Climate controls (passenger):** Displays when temperature controls have been **Split** to provide separate controls for the driver and passenger.



9. **Volume Control:** Controls the volume of media player and phone calls (see [Volume Controls on page 148](#)). The volume of navigation instructions is controlled separately (see [Maps and Navigation on page 143](#)).

Popup messages appear at the bottom of the touchscreen. For example, a seat belt reminder appears if a seat belt is unfastened in an occupied seat, an alert appears to notify you of an incoming phone call, a text message appears (when applicable), and voice commands appear when in use. If applicable, touch options from these popup messages (for example, accept/decline a phone call, choose an option from the headlight menu, etc.). To dismiss a popup message, swipe it downward.

Customizing My Apps

For one-touch access to commonly used apps and controls, you can customize what displays in the **My Apps** area on the touchscreen's bottom bar:

1. Enter customization mode by touching and holding any app or control in the **My Apps** area. If this area is empty, touch the App Launcher.
2. Simply drag any app or control from the app tray onto the **My Apps** area in the bottom bar.

NOTE: Seat heaters selected from the app tray appear next to the temperature, instead of in the My Apps area.

NOTE: Controls (for example, defrosters and seat heaters) appear in the app tray only when you enter customization mode by touching and holding an app.

NOTE: When you've added the maximum number of apps or controls to **My Apps**, adding an additional app removes the rightmost app.

NOTE: Remove an app or control from the **My Apps** area by touching and holding, then touching its associated "X".



Keyless Locking and Unlocking

Locking and unlocking Model X is convenient. Although you must be carrying a valid key fob, there is no need to use it. Model X has sensors around the driver's door that can recognize the presence of a key fob within a range of approximately three feet (one meter). So, you can keep your key fob in your pocket or purse and Model X detects it as you approach.

When you walk up to Model X carrying your key fob, the doors automatically unlock if Passive Entry is on (**Controls > Safety > Passive Entry**). To open the rear trunk, press the switch located under the powered liftgate's exterior handle.

NOTE: Model X must detect your key fob near the driver's door before the doors or powered liftgate unlock.

NOTE: If Passive Entry is off, you must use the key fob to unlock Model X. See [Using the Key Fob on page 8](#).

If equipped with the premium upgrade package, and the **Automatic Doors** setting is turned on, when you walk up to Model X carrying your key fob, doors automatically unlock and the driver's door partially opens. If not equipped, or if this setting is turned off, doors automatically unlock and a door opens when you press its handle.

NOTE: You can choose whether you want all doors, or just the driver's door, to unlock when you approach Model X carrying your key fob (see [Door Unlock Mode on page 14](#)).

When carrying your key fob with you, you can also open the rear trunk without having to use the key fob. Simply press the switch located under the powered liftgate's exterior handle. Driver Door Unlock Mode (see [Door Unlock Mode on page 14](#)) must be off and the vehicle must detect the key fob near the driver's door before opening the rear trunk.

Model X also locks automatically. If you enable **Walk Away Door Lock**, Model X locks when you walk away carrying your key fob with you (see [Walk-Away Door Lock on page 14](#)).

In addition, you can set Model X to sound a soft horn whenever you car locks or unlocks (if equipped). To set up, touch **Controls > Vehicle > Lock Confirmation Sound**.

While sitting inside Model X, you can also lock and unlock the vehicle by touching the icon on the touchscreen's status bar or by touching **Controls**.

Using the Key Fob

To quickly familiarize yourself with the key fob, think of the key fob as a miniature version of Model X, with the Tesla badge representing the front. The key fob has three buttons on the top that feel like softer areas on the surface, and a metal button on each side representing the falcon wing doors.

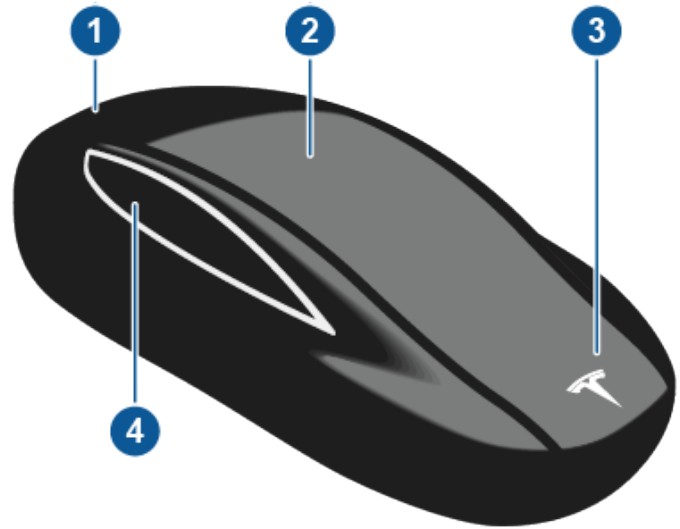

1. Trunk
 - Double-click to open the rear trunk.
 - If equipped with a powered liftgate, double-click to close the rear trunk. You can also single-click to stop the liftgate when it is moving.
 - Hold the button down for one to two seconds to open the charge port door.
2. Lock/Unlock All
 - Single-click to lock all doors and rear trunk. Hazard warning lights flash once.
NOTE: If a door or the rear trunk is open, hazard warning lights flash three times and doors do not lock. But you can enable a single-click to both close all doors (and rear trunk) and lock them, by turning on the **Close All with Key Fob** setting (touch **Controls > Vehicle > Close All with Key Fob**). By default, this setting is turned off and you must triple-click the button to close and lock all doors.
 - Double-click to unlock. Hazard warning lights flash twice.
NOTE: If Model X is equipped with the premium upgrades package and Automatic Doors is enabled (touch **Controls > Vehicle > Automatic Doors**), doors unlock and the driver's door opens as you approach Model X. A subsequent double-click opens the passenger front door.
3. Front trunk



- Double-click to open the front trunk.

4. Falcon wing doors

- Double-click to open/close the associated falcon wing door.
- Single-click to stop movement of the associated falcon wing door. Subsequently double-clicking reverses movement of the falcon wing door. For example if the door was opening, it closes, and vice versa.

NOTE: Falcon wing doors are designed to proactively detect obstacles that prevent the doors from moving when an obstacle is detected.

⚠ WARNING: Model X falcon wing doors have several sensors to detect the presence of an object in the door's path. In most cases, when an object is detected, the door stops moving. However, the sensors are unable to detect all areas under all circumstances, particularly when closing. Therefore, you must monitor the movement of falcon wing doors to ensure the door's path of movement is free of obstacles, staying prepared at all times to proactively intervene to stop the door from contacting an object (including a person). Failure to do so can cause serious damage or bodily injury.

You do not need to point the key fob at Model X, but you must be within operating range (which varies depending on the strength of the key fob's battery).

If Model X is unable to detect the key fob, the touchscreen displays a message indicating that a key fob is not inside. Place the key fob where Model X can best detect it, which is below the low voltage power socket (see [Key Fob Not Inside on page 54](#)).

Radio equipment on a similar frequency can affect the key fob. If this happens, move the key fob at least one foot (30 cm) away from other electronic devices (phone, laptop, etc). If the key fob does not work, you may need to change its battery. If the key fob's battery is discharged, you can open Model X by following the unlocking procedure (see [Unlocking When the Key Fob Doesn't Work on page 14](#)).

⚠ CAUTION: Remember to bring the key fob with you when you drive. Although you can drive Model X away from its key fob, you will be unable to power it back on after it powers off.

⚠ CAUTION: Protect the key fob from impact, high temperatures, and damage from liquids. Avoid contact with solvents, waxes and abrasive cleaners.

Replacing the Key Fob Battery

The key fob's battery lasts for approximately a year with normal use. When the battery is low, a message displays on the instrument panel. Follow these steps to replace it:

NOTE: Tesla recommends replacing the battery in all key fobs at the same time.

1. With the key fob placed button-side down on a soft surface, use a small flat-bladed tool or fingernail to release the bottom cover.



NOTE: If a lanyard is attached to the key fob, you can release the bottom cover by placing your thumb against the "X" on the bottom cover, then firmly pulling the lanyard toward you (hence pushing the key fob off of its cover). You can also pry the cover off by placing a small flat-bladed tool, a fingernail, or the Tesla-provided tool against the lanyard cord.

2. Remove the battery by carefully releasing it from the retaining clips at an angle.



3. Insert the new battery (type CR2354) with the '+' side facing up. The battery fits snugly so you must slide it into position at an angle toward the Positive contact (the contact located near the center of the key fob), then press down firmly on the other side, ensuring it is held firmly in its intended position.



Keys and Doors

NOTE: Tesla recommends using Panasonic CR2354 batteries. These can be purchased through online retailers, local supermarkets, and drug stores.

CAUTION: The battery should press against the spring on the positive contact. Do not place the battery on top of the contact and force it down vertically. Doing so may damage the contact.

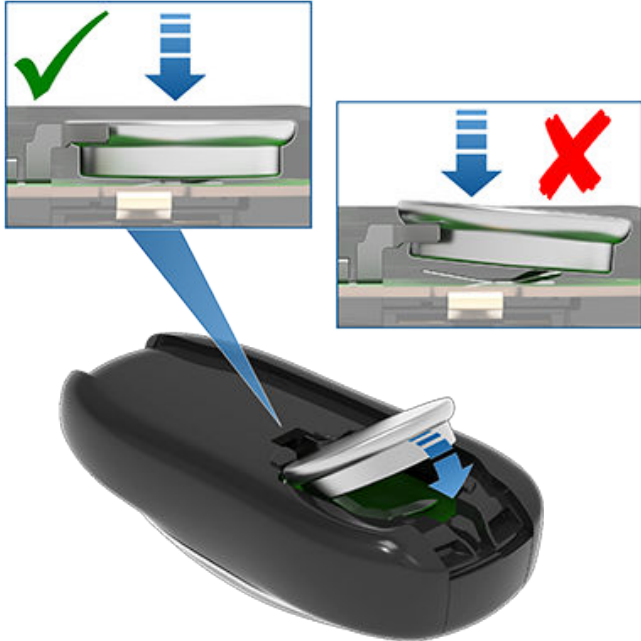

NOTE: Wipe the battery clean before fitting and avoid touching the battery's flat surfaces. Finger marks on the flat surfaces of the battery can reduce battery life.

4. Holding the cover at an angle, align the tabs on the widest side of the cover with the corresponding slots on the key fob, then press the cover firmly onto the key fob until it snaps into place.
5. Test that the key fob works by unlocking and locking your vehicle.

Attaching a Lanyard

The Model X key fob supports the use of a small lanyard. To attach a lanyard, release the bottom cover as described above. Place the lanyard over the pin on the back side of the key fob. Re-align the cover and snap into place.

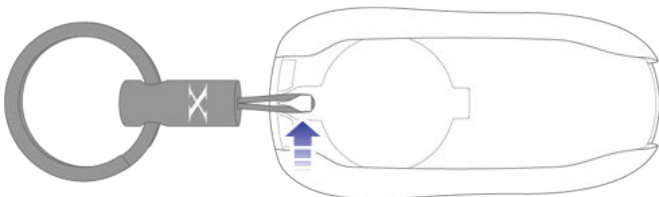

Getting More Key Fobs

If you lose a key fob or require an additional one, contact Tesla. Model X can recognize up to eight key fobs.

When ordering a new key fob for Model X, take all available key fobs with you for reprogramming.

Opening Doors from the Interior

To open a front door, pull the interior door handle toward you.



You can also use the touchscreen to open and close doors when inside Model X. Touch **Controls**, then choose the door you want to open or close. In addition, if Model X is equipped with the premium upgrades package, when you press the brake pedal, the driver's door automatically closes.

NOTE: To prevent children from opening falcon wing doors using the interior handles, use the touchscreen, **Controls > Vehicle > Child-Protection Lock**, to turn on the child-protection locks (see [Child-Protection Lock on page 14](#)).

Opening and Closing Front Doors from Outside

Model X doors are electrically powered. When you approach Model X carrying a key, the doors automatically unlock. The front doors open when you press the door handle.

You can also set the driver's door to open automatically upon your approach (if equipped). The door partially opens (between 20° and 45° depending on obstacles detected by sensors). Touch **Controls > Vehicle > Automatic Doors**. If this setting is on, you can also open



the driver's door by double-clicking the key fob's lock/unlock button. A subsequent double-click opens the front passenger door.

You can also specify that you want to unlock only the driver's door when you shift into Park by touching **Controls > Vehicle > Driver Door Unlock Mode**.

NOTE: See [Cold Weather Best Practices on page 91](#) for information on opening the doors in cold weather.

CAUTION: The front doors may not fully open or close automatically when parked on a very steep hill. Never rely on Model X to fully open or close the doors for you when parked on a steep hill.

NOTE: Depending on date of manufacture and options chosen at time of purchase, your Model X may not be equipped with automatic doors.



Whenever a door is open, the Door Open indicator displays on the instrument panel. Also, the image of the Model X on the touchscreen's **Controls** window also provides a visual representation of an open door or trunk.

To close doors from the outside, you can:

- Manually push them shut.
- Single-click or triple-click the key fob's lock/unlock button (if the **Close All with Key Fob** setting is on, only a single click is needed to close all doors and trunks—a triple-click is needed if the setting is off).

Once inside you can close the doors by touching **Controls**.

NOTE: Powered doors stop moving if an obstacle is detected.

WARNING: Before allowing an automated feature to open or close a front door (rather than doing so manually), it is important to check that the area around the door is free of obstacles (such as people and objects). You must proactively monitor the door's movement to ensure that it does not contact a person or object. Failure to do so can result in damage or serious injury.

Front Door Reset

Since your Model X does not have traditional door handles that you can pull from the outside, it is equipped with pop actuators (sometimes referred to as "ice breakers") that are used to assist in opening the front doors in cases where resistance is detected, such as ice buildup in cold weather. The pop actuator is located just above the front door latch and extends as necessary to open the front door. Once the front door opens slightly, the pop actuator gently retracts back into the door.



If the pop actuator is unable to retract because it is stuck to or caught on something, the pop actuator can be extended manually to extract the object by performing the following:

1. Carefully close the door latch using a pen, screwdriver, or comparable tool (never use a finger or body part and avoid damaging the paint); Model X will detect this as though the door is closed.



2. Make sure Model X is unlocked, then press the exterior door handle or pull the interior door handle to reset the latch and extend the pop actuator.
3. As the pop actuator extends out from the door, quickly extract the object.

WARNING: The pop actuator will attempt to retract back into the door almost immediately after the door handle is pressed or pulled. The pop actuator retracts gently, but will not release automatically if something gets caught.

WARNING: As with all mechanical and moving parts on the vehicle, never put body parts in, or near, moving components. Make sure children are monitored when opening and closing doors. Interacting with moving components, including the pop actuator, can cause serious damage or bodily injury.

Opening and Closing Falcon Wing Doors

Model X has falcon wing doors that easily open and close by pressing a button, using a key fob, or touching the associated icon on the touchscreen. The falcon wing doors are equipped with several sensors that detect the presence of people and objects and, if an object is detected, the door stops moving. Based on detected objects, the doors may adjust their outward and upward movement in an attempt to avoid contacting the object. For example, if an object is detected above Model X, the door's movement may extend further outward but lower, whereas if an object is detected beside the door, the door may extend outward much less.

⚠ WARNING: It is important to keep your hands clear of the falcon wing door frames at all times. Proactively check the door frame area prior to closing, and monitor the movement of the door during closing to ensure that it does not come into contact with a person or object. Failure to do so can result in damage or serious injury.

⚠ WARNING: Before opening or closing a falcon wing door, it is important to check that the area around the door is free of obstacles (people and objects). Although the doors have many sensors, it can not detect all objects at all times, particularly when moving. At any given moment, there may be areas near the door that are not in the detection zone. Therefore, when opening or closing a falcon wing door, you and your passengers must stand away from the door as it is moving, while proactively monitoring the door's movement and being prepared to take corrective action at any time. To stop a door from moving, single-click the falcon wing door button on the key fob, press the switch on the door or door pillar, or touch the button on the touchscreen.

To open a falcon wing door from outside Model X, press the door handle or press the falcon wing door button on the key fob (see [Using the Key Fob on page 8](#)).

To open a falcon wing door from inside Model X, press the switch located on the door pillar, or touch the associated door icon on the touchscreen (**Controls**):

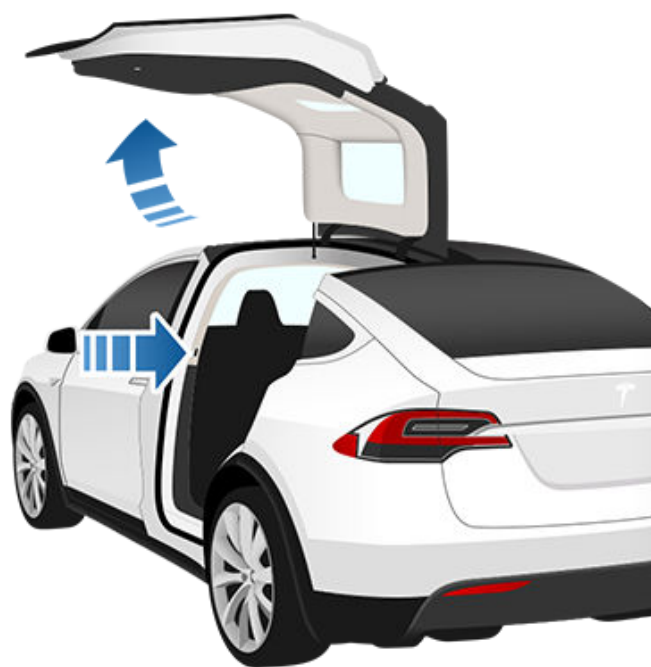

NOTE: If Model X is locked, using the switch (illustrated above) the first time unlocks the associated door. Pulling it a second time opens it.

To close a falcon wing door, press the button located on the inside of the door. You can also use the key fob (see [Using the Key Fob on page 8](#)), use the switch on the door pillar (illustrated above), or touch the associated door icon on the touchscreen (**Controls**).

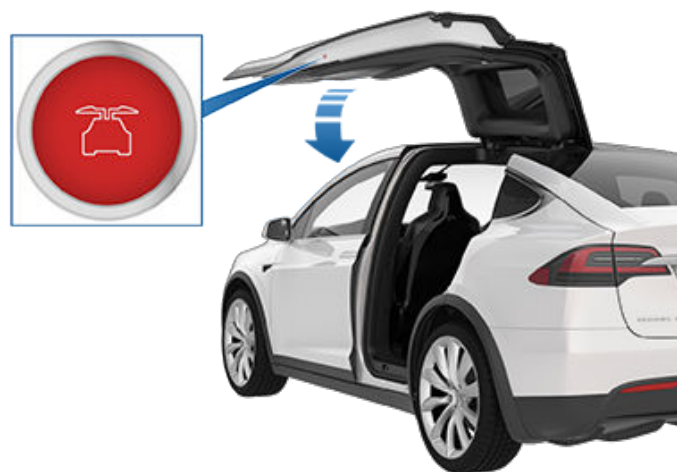

If a falcon wing door is left open when you attempt to shift out of Park, a notification requiring you to confirm your intent to drive appears on the touchscreen. The falcon wing doors may automatically close once you begin to accelerate. It is your responsibility to ensure doors and trunks are properly closed before driving.

NOTE: To prevent children from opening falcon wing doors using the interior switch, turn on child-protection locks using the touchscreen (**Controls > Vehicle > Child Protection Lock**). See [Child-Protection Lock on page 14](#).



NOTE: You can configure Model X to open the falcon wing doors to a lower height setting by using the touchscreen (**Controls** > **Vehicle** > **Falcon Door Height**).

NOTE: If a falcon wing door detects an obstacle while closing, it reverses a few inches before it stops moving.

WARNING: Whenever a front door is partially open (approximately 20°) as you are opening or closing the associated falcon wing door, you **MUST** keep your hands (or any object) away from the opening edge of the front door. When a falcon wing door passes by a partially opened front door, the distance between the two doors is very narrow. Objects, such as hands or fingers, placed in this area, are not detected by sensors and can therefore become pinched between the doors. To avoid bodily injury, it is a good practice to keep your hands away from the front door whenever you are opening or closing a falcon wing door.

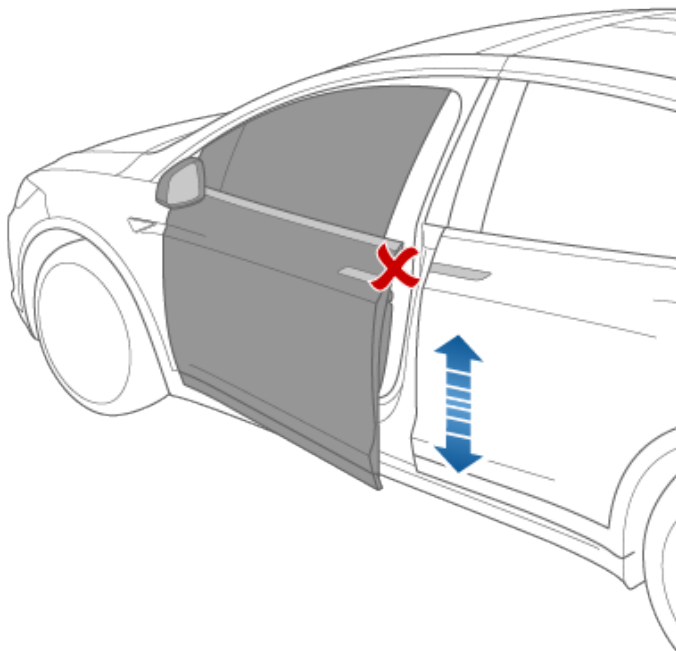

CAUTION: Remove accumulation of snow or ice before opening a falcon wing door. Snow can get inside Model X and ice can prevent the door from opening.

CAUTION: In rainy weather, leaving a falcon wing open while opening the liftgate can result in rain water falling from the liftgate into the rear seating area.

NOTE: Falcon wing doors open only when Model X is stationary.

WARNING: When opening or closing a falcon wing door, it is important to proactively monitor the movement of the door to ensure that it does not come into contact with a person or object. Failure to do so can cause serious damage or injury.

Obstacle Detection

A falcon wing door stops moving when one of its many sensors detects an obstacle, or when the door senses resistance because it has made contact with an object. The touchscreen displays a warning. In these cases, provided it is appropriate to continue opening or closing the falcon wing door, you can override obstacle detection by pressing and holding the switch located on the door pillar, or touching and holding the associated door icon on the touchscreen.

When Model X detects a low ceiling (for example, in a garage), it opens the falcon wing doors (and trunk) to a lower height, even if no obstacle is detected. You can override this height and open the doors higher by touching the associated door icon on the touchscreen (**Controls**). The touchscreen displays a message asking you if you always want to open the doors to the higher height at this location, and saves your choice. The next time you open the falcon wing doors at this location, Model X opens them to the height you saved.

WARNING: Before overriding a falcon wing door's default opening height, visually inspect the area to ensure adequate clearance between the door and the detected object.

WARNING: Applying adhesive products such as wraps, stickers, rubber coating, etc. on the outside of the falcon wing doors can affect the sensors' ability to detect obstacles properly.

Calibration

If the falcon wing doors lose calibration, a message displays on the touchscreen. To calibrate the doors, first ensure that both doors have plenty of space to open and close and are clear of passengers, objects, etc. Then press and hold the **Calibrate** button until calibration is complete. During calibration, the lower door opens all the way out (requiring extra space on the side of Model X), the upper door moves all the way down, and then the lower door closes.

Interior Locking and Unlocking

From inside Model X, you can use the touchscreen to lock or unlock doors and trunks, provided a valid key is inside the vehicle. Touch the lock icon on the touchscreen's status bar.

When you stop Model X and engage Park, you can choose whether you want doors to unlock or remain locked. To do so, touch **Controls** > **Vehicle** > **Unlock on Park**. When enabled, doors automatically unlock when you engage Park.

You can also unlock doors by pressing the Park button on the end of the drive stalk a second time (for example, after pressing it one time to engage Park).



NOTE: If a door or trunk is still open when you lock Model X, it locks when you close it.

Door Unlock Mode

You can choose to unlock only the driver's door when you approach your vehicle carrying your key fob. To do so, touch **Controls > Vehicle > Driver Door Unlock Mode**.

Child-Protection Lock

Model X has child-protection locks on the falcon wing doors and liftgate to prevent them from being opened using interior handles. Use the touchscreen to turn child-protection locks on or off. Touch **Controls > Vehicle > Child- Protection Lock**.

NOTE: It is recommended that you turn child-protection locks on whenever children are seated in the rear seats.

Drive Away Locking

Model X automatically locks all doors (including the trunks) whenever your driving speed exceeds 5 mph (8 km/h).

Walk-Away Door Lock

Doors and trunks automatically lock whenever you walk away carrying the key fob or if the key fob is otherwise not detected by your vehicle (not present, dead battery, etc.).

To turn this feature on or off, touch **Controls > Vehicle > Walk-Away Door Lock**.

Check the **Exclude Home** checkbox to prevent doors from locking when you walk away carrying the key fob when Model X is parked at the location you have designated as Home. For details on how to designate a location as Home, see [Home, Work, and Favorite Destinations](#) on page 145.

NOTE: If Model X detects an authenticated key fob for five minutes after you exit the vehicle and close all doors, Walk-Away Door Lock disables and doors do not lock when you leave with the key fob. You will need to manually lock Model X until after your next drive.

NOTE: If all doors are closed and you use the key fob to unlock Model X, walk away locking is temporarily suspended for one minute. If you open a door within this minute, it does not re-lock until after all the doors are closed and you have walked away with the key fob.

NOTE: If you unlock Model X using the mobile app, it automatically locks after a short period of time if all doors remain closed. If parked in an area without cellular service (such as an indoor parking garage), ensure that you have a functional key fob available to unlock Model X.

Unlocking When the Key Fob Doesn't Work

If Model X does not unlock when you walk up to it, or when you double-click the unlock button on the top of your key fob, the key fob's battery may be dead. Even if this is the case, you can still use the key fob to unlock and drive Model X.

NOTE: Although you can still use your key fob, you should consider using the mobile app to remotely unlock and start the vehicle. Then, replace your key fob's battery when convenient.

To unlock Model X (and disable the security alarm) using the key fob, first position the key fob at the base of the door pillar between the front door and the falcon wing door, on the driver's side of the vehicle. Then press the driver's door handle. If Model X doesn't unlock, try adjusting the position of the key fob and try again. The key fob must be in the correct position for the vehicle to unlock. If Model X still doesn't unlock, remove the key fob's battery and try again. See [Replacing the Key Fob Battery](#) on page 9.

NOTE: The following illustration assumes a left hand drive (LHD) vehicle. On a right hand drive (RHD) vehicle, the locations are mirrored.



To drive Model X after gaining access to the cabin, place the bottom of the key fob against the center console, immediately below the low voltage power outlet, then press and hold the brake pedal to start Model X.

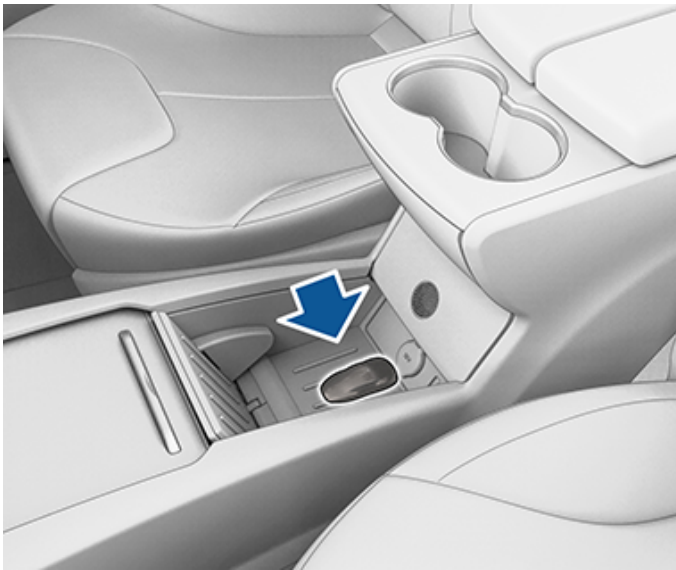

NOTE: Unlocking Model X using this method disables walk away locking. You must manually re-enable walk away locking after replacing the key fob's battery.

Opening Interior Doors with No Power

If Model X has no electrical power, the front doors open as usual using the interior door handles. To open the falcon wing doors, carefully remove the speaker grille from the door and pull the mechanical release cable down and towards the front of the vehicle. After the latch is released, manually lift up the door.





Opening and Closing

Press down on a switch to lower the associated window. Window switches operate at two levels:

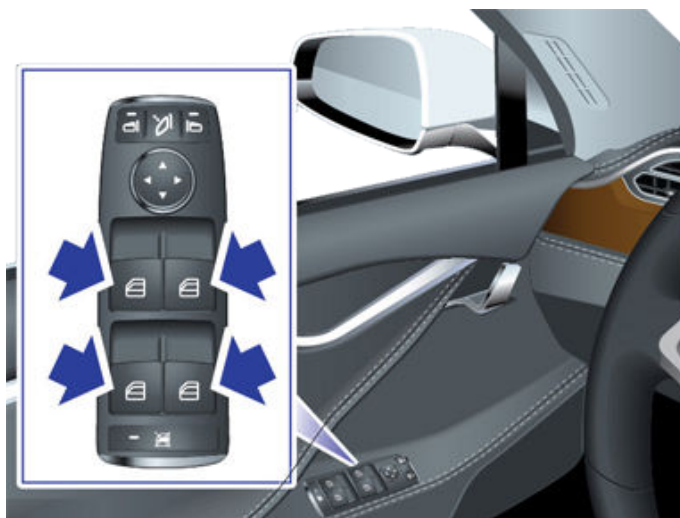
- To lower a window fully, press the switch all the way down and immediately release.
- To lower a window partially, press the switch gently and release when the window is where you want it.



 **WARNING:** To ensure safety, it is recommended that you lock the rear window switches whenever children are seated in the rear seats.

 **WARNING:** Never leave children unattended in Model X.

Similarly, pull a switch to raise the associated window:

- To raise a window fully, pull the switch all the way up and immediately release.
- To raise a window partially, pull the switch gently and release when the window is where you want it.

If a window is left open unintentionally, Model X can send a notification to the mobile app (touch **Controls** > **Vehicle** > **Car Left Open Notification**, then choose **Doors & Windows**).

NOTE: See [Cold Weather Best Practices on page 91](#) for information on preparing windows for cold weather.

 **CAUTION:** To avoid damage, windows automatically lower slightly when you open or close a door. If you manually raise a window when the door is open, ensure it is slightly lowered before closing the door.

 **WARNING:** Before closing a window, it is the driver's responsibility to ensure that all occupants, especially children, do not have any body parts extended through the window's opening. Failure to do so can cause serious injury.

Locking Rear Windows

To prevent passengers from using the rear window switches, press the rear window lock switch. The switch light turns on. To unlock rear windows, press the switch again.

Opening

To open the rear trunk, ensure Model X is in Park, then do one of the following:

- Touch **Controls** > **Trunk** on the touchscreen.
- Double-click the rear trunk button on the key fob.
- Touch the rear trunk button on the mobile app.
- Press the switch located under the liftgate's exterior handle (a valid key must be detected).

NOTE: If **Passive Entry** is off, you must use a key fob to unlock Model X before you can use the switch to open the liftgate. See [Using the Key Fob on page 8](#).

Model X must be unlocked or detect a key before you can use the switch to open the liftgate.

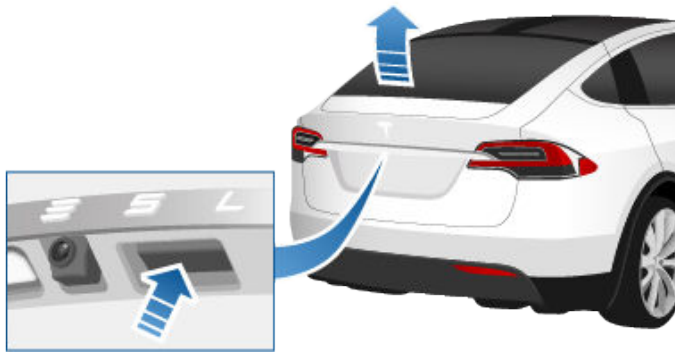

When a door, trunk or liftgate is open, the instrument panel displays the Door Open indicator light. The image of your Model X on the touchscreen also displays the open trunk.

To stop a liftgate while it is moving, single-click the rear trunk button on the key fob. Then, when you double-click the rear trunk button, it moves again, but in the opposite direction (provided it was not almost entirely open or closed when you stopped it). For example, if you single-click to stop the liftgate while opening, when you double-click, it closes.

NOTE: In emergency situations, you can override an open or close command by grasping the liftgate to stop it in place.

To open the liftgate from inside the vehicle in the unlikely situation that Model X has no power, see [Interior Emergency Trunk Release on page 18](#).

If Model X detects a low ceiling (for example, in a garage), it opens the liftgate (and falcon wing doors) to a lower height, even if no obstacle is detected. You can override this height by manually lifting it higher. When doing so, the touchscreen prompts you to choose if you always want the trunk to open to this higher position at this location, and saves your choice. If you choose to do so, the next time you open the liftgate at this location, Model X opens it to the saved height.

⚠ WARNING: Before opening or closing the liftgate, check the surrounding area (for people and objects). Although the liftgate can detect obstacles, it cannot detect all objects at all times. Do not rely on the liftgate to sense an obstruction when opening or closing. You must proactively monitor the liftgate to ensure that it does not come into contact with a person or object. Failure to do so may result in damage or injury.

Closing

To close the liftgate, do one of the following:

- Touch **Controls** > **Trunk**.
- Double-click the rear trunk button on the key fob.
- Press the switch located on the underside of the liftgate (see [Adjusting Liftgate Opening Height on page 17](#)).

If the liftgate senses an obstruction when closing, it stops moving and chimes two times. Remove the obstruction and try closing it again.

Adjusting Liftgate Opening Height

You can adjust the opening height of the liftgate to make it easier to reach or to avoid low-hanging ceilings or objects (for example, a garage door or light):

1. Open the trunk, then manually lower or raise the liftgate to the desired opening height.
2. Press and hold the button on the underside of the liftgate for three seconds until you hear a confirmation chime.



Rear Trunk

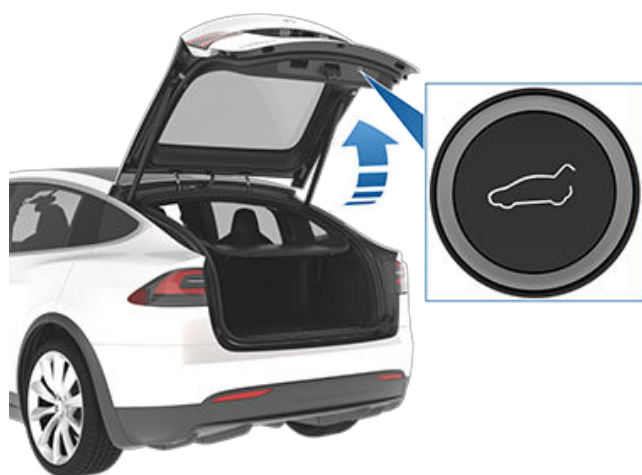

3. Confirm that you have set it to the desired height by closing the liftgate, then reopening it.

Accessing the Cargo Area

Secure all cargo before moving Model X, and place heavy cargo in the lower trunk compartment.

To access the cargo area inside the rear trunk, push down on the ridged portion of the handle of the cargo cover and then pull up. You can then adjust the position of the cargo cover or completely remove it.



Distribute cargo weight between the front and rear trunks.

- CAUTION:** Never load more than 175 lbs (80 kg) in the upper compartment of the rear trunk or more than 285 lbs (130 kg) in the lower compartment. Doing so can cause damage.

Interior Emergency Trunk Release

An illuminated mechanical release located inside the rear trunk allows you to open the rear trunk from the inside if Model X has no electrical power. This mechanical release also allows a person locked inside to get out.

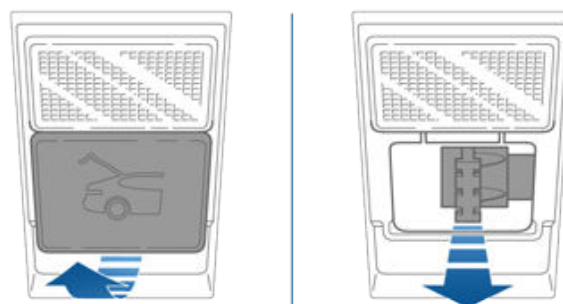

1. Remove the cover by pulling its lower edge very firmly toward you.
2. Pull the cable to release the latch.
3. Push the rear trunk open.

NOTE: The button glows for several hours after a brief exposure to ambient light.

- WARNING:** Do not allow children to play inside the trunk or become locked inside. An unrestrained child could suffer serious injury or death in a crash. A child could suffer heat exhaustion if trapped in the vehicle, especially without climate control on.

Opening

To open the front trunk, ensure Model X is in Park, and then do one of the following before pulling the hood open:

- Touch **Controls** > **Front Trunk** on the touchscreen.
- Double-click the front trunk button on the key fob.
- Touch the front trunk button in the mobile app.



When a door or trunk/liftgate is open, the instrument panel displays the Door Open indicator light. The image of your Model X on the touchscreen also displays the open front trunk.

WARNING: Before opening or closing the hood, it is important to check that the area around the hood is free of obstacles (people and objects). Failure to do so may result in damage or serious injury.

The cargo weight should be distributed between the front and rear trunks.

CAUTION: Never load more than 300 lbs (136 kg) in the front trunk. Doing so can cause damage.

Closing

The Model X hood is not heavy enough to latch under its own weight and applying pressure on the front edge or center of the hood can cause damage.

To properly close the hood:

1. Lower the hood until the striker touches the latches.
2. Place both hands on the front of the hood in the areas shown (in green), then press down firmly to engage the latches.
3. Carefully try to lift the front edge of the hood to ensure that it is fully closed.

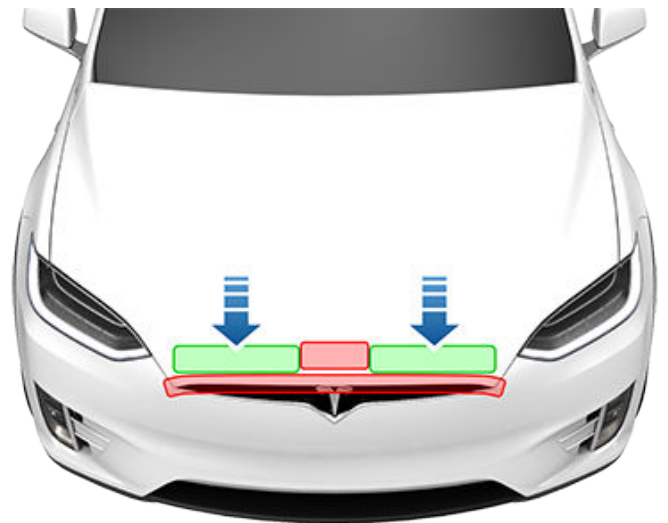

CAUTION: To prevent damage:

- Apply pressure only to the green areas shown. Applying pressure to the red areas can cause damage.
- Do not close the hood with one hand. Doing so applies concentrated force in one area and can result in a dent or crease.
- Do not apply pressure to the front edge of the hood. Doing so can crease the edge.
- Do not slam or drop the hood.
- To avoid scratches, don't have anything in your hands (keys). Jewelry can also cause scratches.

WARNING: Before driving, you must ensure that the hood is securely latched in the fully closed position by carefully trying to lift the front edge of the hood upward and confirming there is no movement.

The front trunk locks when:

- You lock Model X using the touchscreen, key or mobile app.
- You leave Model X carrying your key (if [Walk-Away Door Lock on page 14](#) is turned on).
- Valet mode is active (see [Valet Mode on page 48](#)).

Interior Emergency Release

An illuminated interior release button inside the front trunk allows a person locked inside to get out.



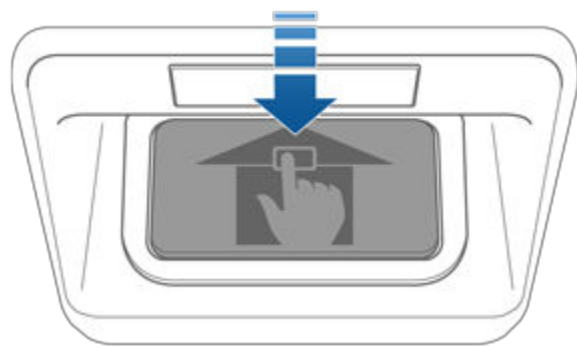

Front Trunk



Press the interior release button to open the front trunk, then push up on the hood.

NOTE: The interior release button glows following a brief exposure to ambient light.

-  **WARNING:** People should never climb inside the front trunk. Never shut the front trunk when a person is inside.
-  **WARNING:** Care should be taken to ensure that objects inside the front trunk do not bump against the release button, causing the hood to accidentally open.

Opening Hood with No Power

If Model X has no electrical power, or if you are unable to open the front trunk using the touchscreen or key, follow these steps to open it:

1. Remove the tow eye cover (see [Instructions for Transporters on page 215](#)).
2. Locate the two straps. One of these straps is labeled 'A' and the other is labeled 'B'.
3. Pull strap 'A' to release the primary latch.
4. Pull strap 'B' to release the secondary latch.
5. Lift the hood. You may need to push the hood down slightly to release the pressure against the secondary latch.

NOTE: It is important to pull the straps in the correct sequence or the appropriate latch does not release and the front trunk can not open.

When opening the front trunk using this method, the latches remain in the open position and you can not close it again without electrical power. To close a front trunk that has been opened by pulling the manual straps:

1. Charge the low voltage battery (for instructions, contact Tesla).
2. Press the **Front Trunk** button on the touchscreen to reset the primary and secondary latches.



Glovebox

To open the glovebox, press the switch located on the side of the touchscreen. The glovebox locks whenever Model X is locked externally, using the key or walk-away locking. It also locks when Model X is in Valet mode (see [Valet Mode on page 48](#)). It does not lock when you lock Model X using the lock icon on the touchscreen's status bar.

For additional glovebox security, touch **Controls** > **Safety** > **Glovebox PIN** to set a 4-digit PIN (see [Glovebox PIN on page 161](#)).

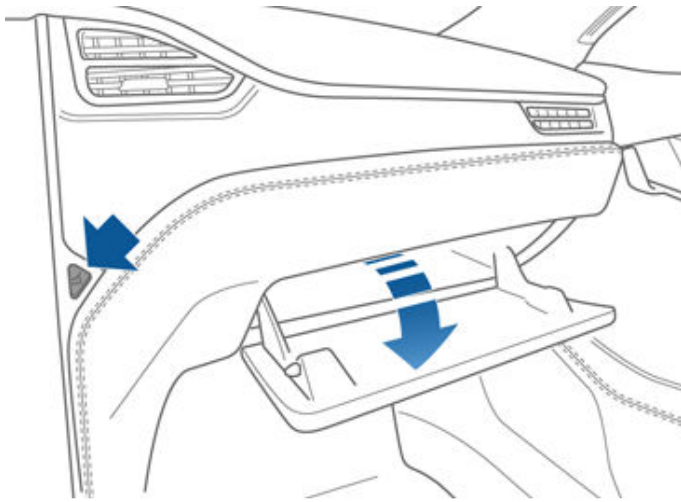

NOTE: If you leave the glovebox open, its light eventually turns off.

⚠ WARNING: When driving, keep the glovebox closed to prevent injury to a passenger if a collision or sudden stop occurs.

USB Ports

Your Model X has two USB ports located on the front of the center console that you can use to connect USB devices. To play audio files stored on a USB drive connected to these ports, see [Playing Media from Devices on page 149](#). You can also use these ports to charge USB devices.

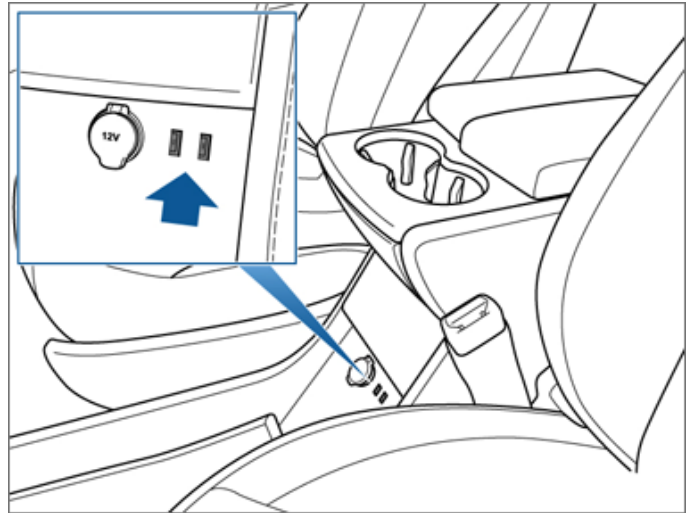

In addition, Model X has two charge-only USB ports located at the rear of the center console, and another charge-only connection located between the third row seats.

NOTE: You can charge four devices simultaneously using the two ports at the front of the center console and the two at the rear of the console.

NOTE: Power is available whenever the vehicle is considered "awake." The vehicle may be awake for many reasons. For example, when using features such as Summon, or when features such as Preconditioning, Cabin Overheat Protection, Keep Climate On, Dog Mode, Camp Mode, Sentry Mode, etc. are enabled. The vehicle is also awake whenever the low voltage battery is being charged or is in use, during HV charging, when the vehicle is communicating with the mobile app, etc. Leaving an accessory plugged in does not deplete the low voltage battery.

USB Drive Requirements for Recording Videos

One or more features on your Model X requires the use of a flash drive (for example, Dashcam, Sentry Mode that meets these requirements:

- Minimum storage capacity of 64 GB. Use a flash drive with as much available storage as possible. Video footage can occupy a large amount of space.
- A **sustained** write speed of at least 4 MB/s. Note that *sustained* write speed differs from *peak* write speed.
- USB 2.0 compatible. If using a USB 3.0 flash drive, it must support USB 2.0.
- Properly formatted (described below).

NOTE: In some market regions you can purchase recommended USB drives on <http://www.tesla.com>.



Formatting a USB Flash Drive

To save and retrieve video footage, Model X requires a USB flash drive formatted as exFAT, MS-DOS FAT (for Mac), ext3, or ext4 (NTFS is currently not supported). For use with Dashcam and Sentry Mode, the flash drive must contain a base-level folder called **TeslaCam**.

Model X can format a USB flash drive for you. Insert the flash drive into a front USB port, and touch **Controls** > **Safety** > **Format USB Drive**. Doing so automatically formats the drive as exFAT and creates a folder for TeslaCam. The USB flash drive is now ready to record and save video footage. **Format USB Drive** is available only when a USB flash drive (with one or fewer partitions) is inserted into a front USB port. Choosing **Format USB Drive** erases any existing content on the flash drive—before using this feature, you must move any content you want to keep to a different device.

If Model X is unable to format the flash drive, you must format it using a computer. Remember to manually create the **TeslaCam** folder (if equipped).

You can also format the USB flash drive with a computer to use a single flash drive for Dashcam, Sentry Mode, Track Mode (if equipped), and audio files. Create separate partitions on the drive formatted as exFAT; for example, one for Dashcam and Sentry Mode (you must create the **TeslaCam** folder), one for Track Mode (create the **TeslaTrackMode** folder), and an audio partition.

Once the USB flash drive is formatted and contains the necessary folder(s), insert it into a front (or glovebox, if equipped) USB port. Do not use a rear USB port—these are used only to charge USB devices. Once inserted, it can take up to 15 seconds for Model X to recognize the flash drive. When recognized, icons for Dashcam and Sentry Mode appear at the top of your touchscreen and your vehicle is ready to record videos. You may need to first enable Sentry Mode (if equipped) by touching **Controls** > **Safety** > **Sentry Mode**.

Viewing Video Recordings

You can view recorded footage on the touchscreen when Model X is in Park. Touch the Dashcam icon located in the app launcher or the Dashcam icon at the top of the touchscreen. Touch the menu icon in the top corner of the screen. The tabs display a list of all video clips, organized by location and timestamp. Pause, rewind, fast forward, and delete video recordings as needed. You can also navigate to **Controls** > **Safety** > **Delete Dashcam Clips** to delete all dashcam and Sentry Mode footage, including recent and saved clips.

NOTE: Dashcam recording pauses when you launch the Viewer.

You can also view video footage by removing and inserting the USB flash drive into a computer and navigating to the TeslaCam (if equipped) folder.

The TeslaCam folder contains three sub-folders:

- **Recent Clips:** When recording, Dashcam continuously saves footage to Recent Clips in 60-minute cycles. Footage is overwritten every hour unless you manually save it. Four videos are recorded for each clip, one from each camera (front, rear, left, and right).
- **NOTE:** Rear camera recordings are available only on vehicles manufactured after approximately February 2018.
- **Saved Clips:** Contains all recordings that are saved using Dashcam.
- **Sentry Clips:** Contains the last 10 minutes of footage from all Sentry Mode events that triggered an Alert or Alarm state. If storage space on the USB flash drive becomes limited, the oldest Sentry Clips are deleted to provide space for new ones. Once deleted, you cannot retrieve them.

When the USB flash drive runs out of storage space, video footage can no longer be saved. To prevent the flash drive from getting full, regularly move saved videos to another device and delete them from the flash drive.

Wireless Phone Charger

If equipped, the Model X wireless phone charger provides up to 6.5W to charge a Qi-enabled phone. Simply open the center console and place your phone in the charger, located on the back of the bin cover. The wireless phone charger uses a front USB port. Your device may feel warm while charging, but this is a normal effect of inductive charging.

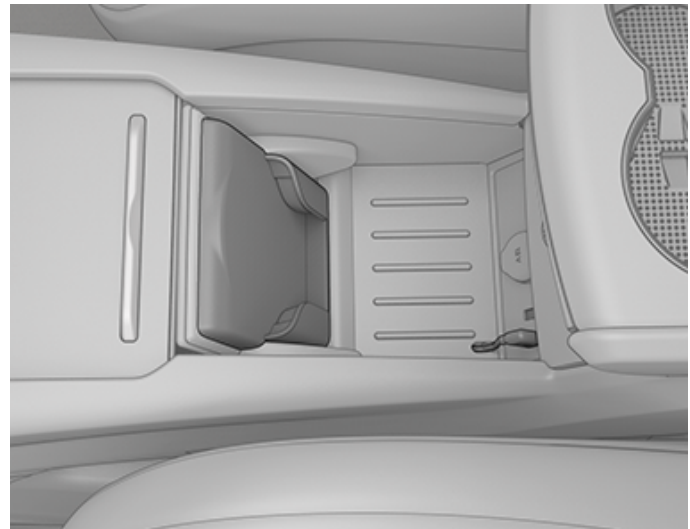

Model X will charge your phone only when the vehicle is powered on (the touchscreen is on and you are in the vehicle). Your phone will not charge after exiting the vehicle. Model X will also not charge if the vehicle's Battery is discharged.

NOTE: Ensure your phone supports inductive charging.



NOTE: The wireless phone charger may not work if your phone case is too large or is made of metal. Try removing the phone from its case before placing in the charger.

Low Voltage Power Socket

Your Model X has a power socket located on the front of the center console. An additional low voltage power socket is located in the rear trunk. Power is available whenever the instrument panel and touchscreen are on.

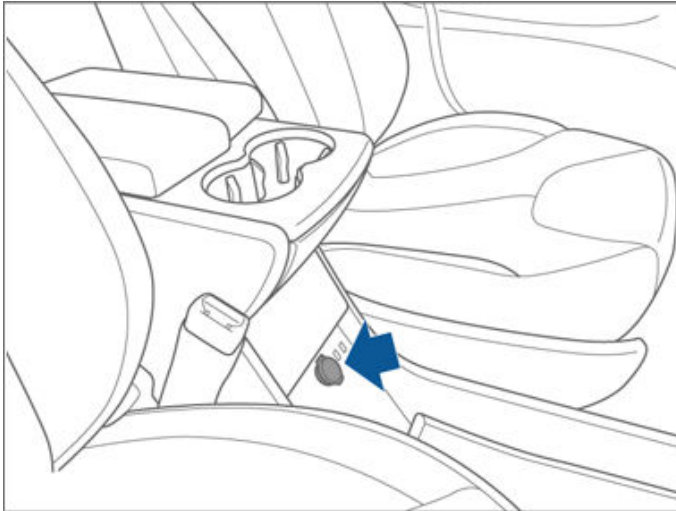

The low voltage power sockets are suitable for accessories requiring up to 11A continuous draw (15A peak) or a maximum of 150 continuous watts (180 watts peak).

NOTE: Power is available whenever the vehicle is considered "awake" The vehicle may be awake for many reasons. For example, when using features such as Summon, or when features such as Preconditioning, Cabin Overheat Protection, Keep Climate On, Dog Mode, Camp Mode, Sentry Mode, etc. are enabled. The vehicle is also awake whenever the low voltage battery is being charged or is in use, during HV charging, when the vehicle is communicating with the mobile app, etc. Leaving an accessory plugged in does not deplete the low voltage battery.

NOTE: In situations where Model X is unable to detect the key fob (low battery, interference, etc.), place it immediately below the low voltage power socket in the center console where Model X can best detect it.



WARNING: The power socket and an accessory's connector can become hot.



Cup Holders

To expose a front cup holder, slide back the armrest.

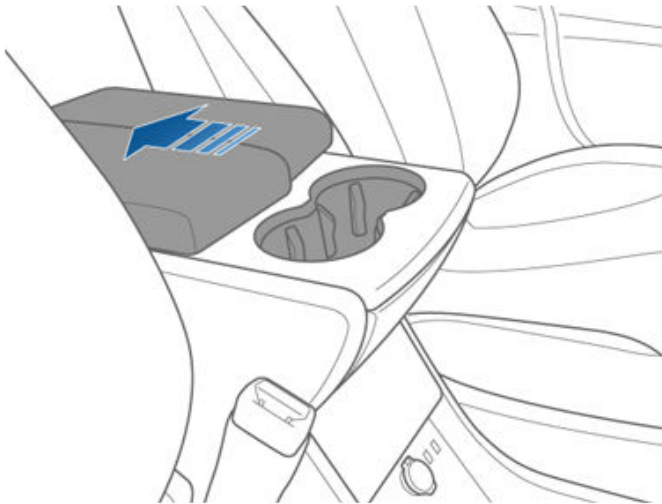

To expose rear cup holders (if equipped), press and release the cup holder face plate located at the back of the center console.

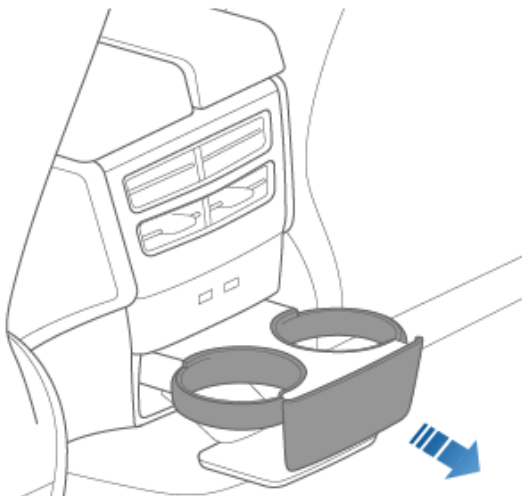



The sun visors in Model X are held in place by magnets. To protect occupants from sunlight coming through the windshield, release the sun visor from the pillar and pivot it toward the rear view mirror until the magnet snaps into place. While held in place by the magnet, you can adjust the sun visor and lower the extender to provide maximum shade.

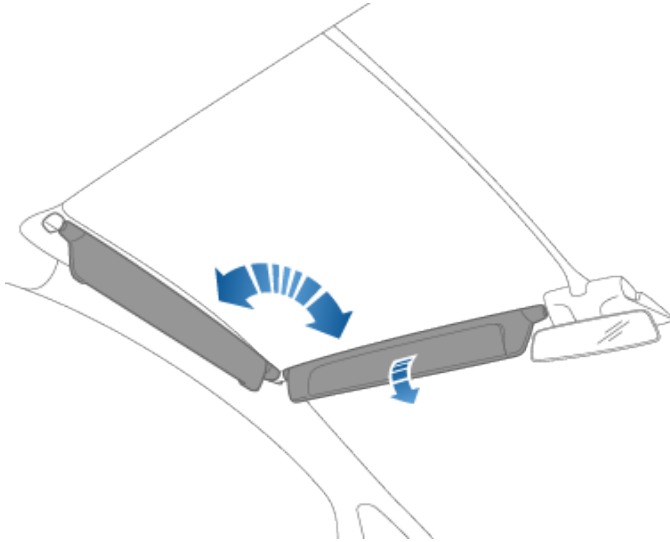

To expose the vanity mirror, lower the visor extender then lower the mirror cover. While the cover is lowered, the mirror is exposed and lights are illuminated.

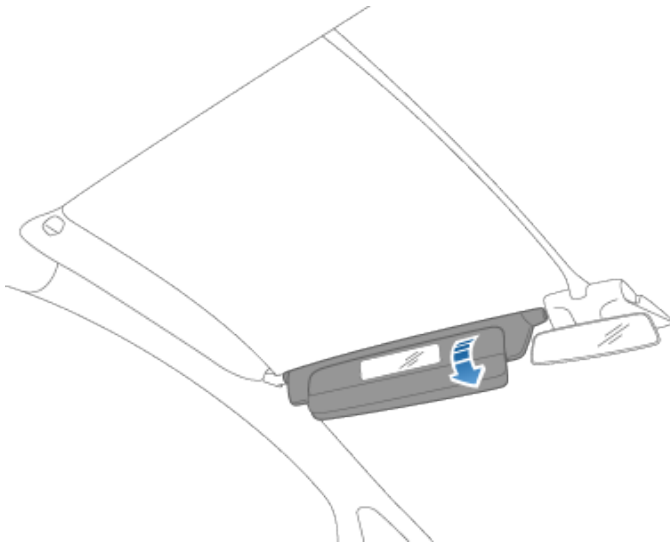

To protect front seat occupants from sunlight coming through the side window, lower the sun visor from the pillar then lower the visor extender.



Front and Rear Seats

Correct Driving Position

The seat, head support, seat belt and airbags work together to maximize your safety. Using these correctly ensures greater protection.



Position the seat so you can wear the seat belt correctly, while being as far away from the front airbag as possible:

1. Sit upright with both feet on the floor and the seat back reclined no more than 30 degrees.
2. Make sure you can easily reach the pedals and that your arms are slightly bent when holding the steering wheel. Your chest should be at least 10 inches (25 cm) from the center of the airbag cover.
3. Place the shoulder section of the seat belt mid-way between your neck and your shoulder. Fit the lap section of the belt tightly across your hips, not across your stomach.

Model X seats include integrated head supports that cannot be adjusted or removed.

Adjusting the Front Seats

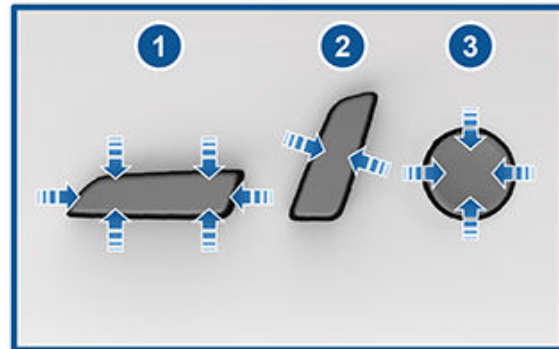

1. Move seat forward/backward and adjust the seat's height and tilt angle up/down.
2. Adjust backrest.
3. Adjust lumbar support.

⚠ WARNING: Before adjusting a front seat, check that the area around the seat is free of obstacles (people and objects).

⚠ WARNING: Do not adjust seats while driving. Doing so increases the risk of a collision.



⚠ WARNING: Riding in a moving vehicle with the seat back reclined can result in serious injuries in a collision, as you could slide under the lap belt or be propelled into the seat belt. Ensure your seat back is reclined no more than 30 degrees when the vehicle is moving.

Adjusting Second Row Monopost Seats

A Model X equipped with monopost seats can accommodate two or three passengers in the second row, depending on the option chosen at time of purchase. There are two ways to adjust the position of these seats:

- Touch **Controls > Seats** on the touchscreen. Press and hold the icon associated with the seat you want to adjust. White icons indicate that the seat can be moved in that direction; gray icons indicate that the seat cannot be moved any farther in that direction.

NOTE: The front seats may move forward slightly to accommodate the forward movement of the second row seats.

- Use the manual adjustments illustrated below. In addition to moving a seat forward/rearward, the manual seat adjustments allow you to adjust the backrest. Although the control on the outboard seats is L-shaped, and the control on the middle seat is circular, they both provide the same functions.

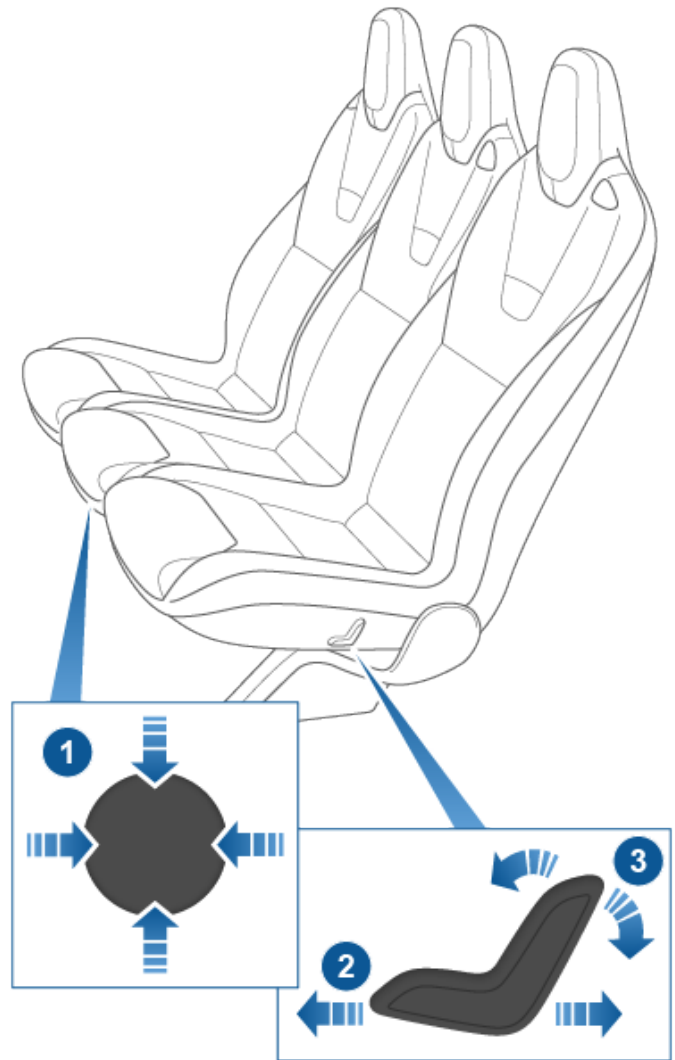

1. Move seat forward/backward (up/down on the control) and adjust the backrest (left/right on the control).
2. Move seat forward/backward.
3. Adjust backrest.

NOTE: The backrest locks into position when you release the lever. If a backrest is not locked into position when a driving gear is engaged, the instrument panel displays an alert for the unlocked backrest. Adjust the backrest again, ensuring it locks into position.

⚠ WARNING: Before driving, ensure the seat is locked in position. You may need to pull the seat forward or backward until it clicks into place.



Front and Rear Seats

Adjusting Second Row Seat Backs (Bench Seats)

If your Model X is equipped with two seating rows, the second row bench seats can accommodate up to three passengers. Use the mechanical adjustment lever located at the side of each outboard seating position to adjust the seat backs. A bench seat is split 60/40 so the adjustment lever on the left side moves the seat backs for both the left and center seats, whereas the lever on the right side moves the rightmost seat back only. While pulling and holding the lever, move the seat back to the desired position, and then release the lever. When returning a seat back to its upright position, try moving it forward or back to ensure it is securely latched into position.



⚠ WARNING: Riding in a moving vehicle with the seat back reclined can result in serious injuries in a collision, as you could slide under the lap belt or be propelled into the seat belt. Ensure the backs of occupied seats are reclined no more than 30 degrees when the vehicle is moving.

Folding Second Row Seat Backs (Bench Seats)

The second row seat backs on bench seats can be folded fully forward so they lay flat and maximize cargo space. Pull up the mechanical lever located on the side of each outboard seat (the same lever you use to recline the seats, as described above), then push the seat back fully forward. The bench seats have a 60/40 split—therefore, the adjustment lever on the left side folds the seat backs for both the left and center seats, whereas the lever on the right folds the rightmost seat back only.

NOTE: Before folding seats fully forward, remove any items from the seats and the rear footwell. To allow the seat backs to fold completely flat, you may need to move the front seats forward.

Moving Second Row Bench Seats

NOTE: Only bench seats in seven-seat vehicles can be moved forward and rearward. The bench seats in five-seat vehicles are stationary.

Use the mechanical lever located beneath each outboard seating position to move the second row seats forward or rearward. The bench seats have a 60/40 split—therefore, the lever on the left side moves the seat for the left and center seats, whereas the lever on the right side moves only the rightmost seat. Pull and hold the lever while moving the seat forward or rearward. Release the lever when the seat is at the desired location.



NOTE: You can adjust the position of bench seats using the mechanical levers only. You cannot use the touchscreen to adjust bench seats.

Accessing Third Row Seats (if equipped) - Monopost Seating

A button is located on the backrest of each outboard monopost seat in the second row. This button makes it easy for passengers to enter and exit the third row seating positions. Touch **Controls > Seats > Easy Entry** and choose how you want this button to work:

- **ON** - Allows you to tilt and move the associated outboard seat fully forward, and the center seat partially forward, with a **single-press** of the button.
- **OFF** - When off, which is recommended if a child seat is installed in the second row, you must **hold** the button to move the second row seats forward.

After using the third row ingress button to access third row seats, simply press the button again to return the seats to their normal position.



Accessing Third Row Seats (if equipped) - Bench Seating



A button is located on the backrest of each outboard bench seat in the second row. This button makes it easy for passengers to enter and exit the third row seating positions. Press and release the button on the left outboard seat to tilt and move the combined left and center seats forward. Press and release the button on the right outboard seat to tilt and move the right seat forward.

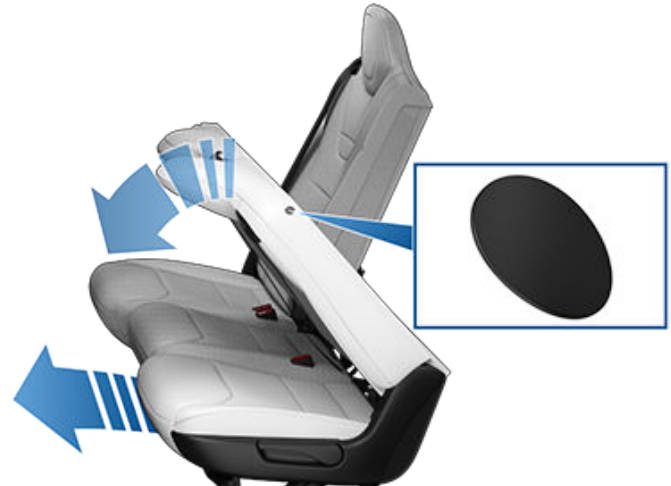

WARNING: For vehicles with third row seats, do not use the third row ingress button located on the backrest of a second row outboard seat when a child is seated in the second row. Using the button tilts and moves the seats forward and can squeeze the occupant. Do not rely on Model X to recognize or accommodate occupants seated in the vehicle while using this button. Use this button only when the second row seats are unoccupied.

WARNING: For vehicles with third row seats, do not use the third row ingress button located on the backrest of a second row outboard bench seat when a child is seated in the second row. Using the button allows the combined left and center seats to be moved forward and can squeeze the occupant. Use this button only when the second row seats are unoccupied. Before driving, ensure the seat and the seat back are securely latched into position.

Guidelines for using the third row ingress button:

- If a front row seat is positioned such that the second row seat will collide with it during an easy entry operation, it automatically moves forward just enough to accommodate the forward position of the second row monopost seat.
- Forward movement of second row monopost seats cancels if an occupant adjusts a second row seat while it is moving.
- When an outboard seat tilts forward after pressing the button, its backrest resets to the forward position and may need to be re-adjusted for comfort.

In some situations, such as when you are parked on an incline or when the seat's trim affects the movement of the bench seats after you press the button, the bench seats might not move forward completely, and you may need to push the seats forward gently until they reach the end of the track.

WARNING: Use the third row ingress button to access the third row ONLY when the second row seats are unoccupied. Do not rely on Model X to recognize or accommodate occupants seated in the vehicle while using the button.

WARNING: After you use the third row ingress button to access the third row seats, push the bench seats back to their seating position, ensuring the seats are securely latched into position by trying to move them forward and rearward. Failure to do so increases the risk of injury.

WARNING: Always ensure that the seat is locked in position before traveling. Failure to do so increases the risk of injury.

WARNING: The seat must be fully latched into position before driving. Push or pull the seat until you hear the seat "click" into place.



Front and Rear Seats

Folding Third Row Seat Backs (if equipped)

To fold a third row seat, press the button located in the top outside corner of the seat. The button has two detents.



1. Fold head restraint forward.
2. Fold seat back forward.

NOTE: Before folding third row seat backs, remove any items from the seats and the footwell. To allow the seat backs to fold completely flat, you may need to move the second row seats forward.

NOTE: Driving with the third row seats backs folded forward might result in increased perceivable noise and/or vibration coming from the rear of the vehicle (trunk, suspension, etc.).

NOTE: To raise the seats, hold the button on the top outside corner of the seat then pull the seat back upward until it latches into place. Try pulling the seat back forward to confirm that it is locked in the upright position.

WARNING: Always ensure the seats and seat backs are locked in their upright position before travel. Failure to do so increases the risk of injury.

Seat Heaters

The front seats contain heating pads that operate at three levels from 3 (highest) to 1 (lowest). To operate the seat heaters, see [Climate Controls on page 138](#).

If Model X is equipped with the cold weather package, you can also control seat heaters in all rear seating positions, as well as wiper defrosters and washer nozzles by touching the climate controls on the touchscreen (see [Climate Controls on page 138](#)).

WARNING: To avoid burns resulting from prolonged use, individuals who have peripheral neuropathy, or whose capacity to feel pain is limited because of diabetes, age, neurological injury, or some other condition, should exercise caution when using the climate control system and seat heaters.

Seat Covers

WARNING: Do not use seat covers in Model X. Doing so could restrict deployment of the seat-mounted side air bags if a collision occurs. Also, if the vehicle is equipped with an occupant detection system that is used to determine the status of the passenger front airbag, seat covers may interfere with this system.

Wearing Seat Belts

Using seat belts and child safety seats is the most effective way to protect occupants if a collision occurs. Therefore, wearing a seat belt is required by law in most jurisdictions.

Both the driver and passenger seats are equipped with three-point inertia reel seat belts. Inertia reel belts are automatically tensioned to allow occupants to move comfortably during normal driving conditions. To securely hold child safety seats, all passenger seating positions are equipped with an automatic locking retractor (ALR) feature that, by fully extracting the seat belt (beyond the length needed for a typical adult occupant), locks the belt into place until the seat belt is unbuckled.

The seat belt reel automatically locks to prevent movement of occupants if Model X experiences a force associated with hard acceleration, braking, cornering, or an impact in a collision.

Seat Belt Reminders



The seat belt reminder on the instrument panel alerts you if a seat belt for an occupied driver or passenger seat is unbuckled. If the belt remains unbuckled, the reminder flashes and an intermittent chime sounds. If all occupants are buckled up and the reminder stays on, re-buckle seat belts to ensure they are correctly latched. Also remove any heavy objects (such as a briefcase) from an unoccupied seat. If the reminder light continues to stay on, contact Tesla.

WARNING: Seat belts must be worn by passengers in all seating positions.

To Fasten a Belt

1. Ensure correct positioning of the seat (see [Correct Driving Position on page 26](#)).
2. Draw the belt out smoothly, ensuring the belt lays flat across the pelvis, chest and mid-point of your collar bone, between the neck and shoulder.
3. Insert the latch plate into the buckle and press together until you hear a click indicating it is locked in place.

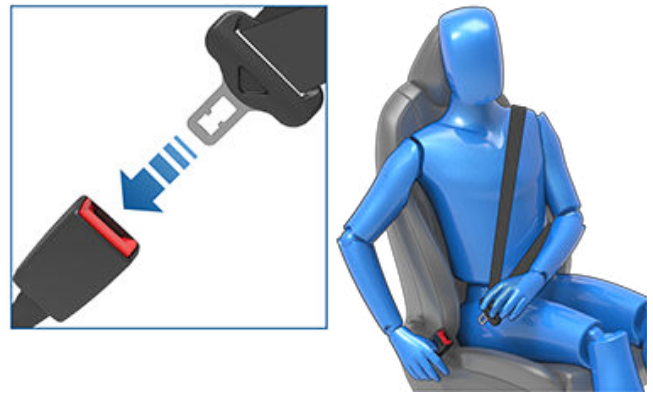

4. Pull the belt to check that it is securely fastened.
5. Pull the diagonal part of the belt toward the reel to remove excess slack.

To Adjust the Shoulder Anchor Height

Model X is equipped with an adjustable shoulder anchor for each front seat to ensure that the seat belt is positioned correctly. The seat belt should lay flat across the mid-point of your collar bone while in the correct driving position (see [Correct Driving Position on page 26](#)). Adjust the height of the shoulder anchor if the seat belt is not positioned correctly:

1. Press and hold the button on the shoulder anchor to release the locking mechanism.
2. While holding the button, move the shoulder anchor up or down as necessary so that the seat belt is positioned correctly.

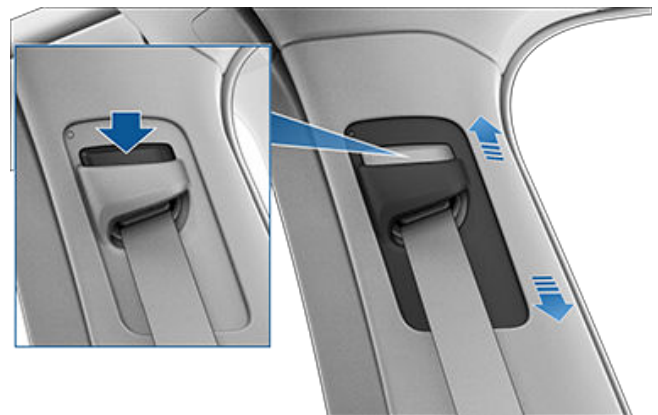

3. Release the button on the shoulder anchor so that it locks into position.
4. Without pressing the button, pull on the seat belt webbing and attempt to move the shoulder anchor downwards to check that it is locked into position.



Seat Belts

⚠ WARNING: Ensure that the seat belt is positioned correctly and that the shoulder anchor is locked into position before driving. Riding in a moving vehicle with the seat belt positioned incorrectly or with the shoulder anchor not locked into position can reduce the effectiveness of the seat belt in a collision.

To Release a Belt

Hold the belt near the buckle to prevent the belt from retracting too quickly, then press the button on the buckle. The belt retracts automatically. Ensure there is no obstruction that prevents the belt from fully retracting. The belt should not hang loose. If a seat belt does not fully retract, contact Tesla.

Wearing Seat Belts When Pregnant

Do not put the lap or shoulder sections of the seat belt over the abdominal area. Wear the lap section of the belt as low as possible across the hips, not the waist. Position the shoulder portion of the belt between the breasts and to the side of the abdomen. Consult your doctor for specific guidance.



⚠ WARNING: Never place anything between you and the seat belt to cushion the impact in the event of a collision.

Seat Belt Pre-tensioners

The front seat belts are equipped with pre-tensioners that work in conjunction with the airbags in a severe frontal collision. The pre-tensioners automatically retract both the seat belt anchor and the seat belt webbing, reducing slack in both the lap and diagonal portions of the belts, resulting in reduced forward movement of the occupant.

The second row outboard seats are equipped with shoulder pre-tensioners to retract the seat belt webbing to reduce forward movement of the occupant.



If the pre-tensioners and airbags did not activate in an impact, this does not mean they malfunctioned. It usually means that the strength or type of force needed to activate them was not present.

⚠ WARNING: Once the seat belt pre-tensioners have been activated, they must be replaced. After any collision, have the airbags, seat belt pre-tensioners and any associated components checked and, if necessary, replaced.

Testing Seat Belts

To confirm that seat belts are operating correctly, perform these three simple checks on each seat belt.



1. With the seat belt fastened, give the webbing nearest the buckle a quick pull. The buckle should remain securely locked.













2. With the belt unfastened, unreel the webbing to its limit. Check that unreeling is free from snags, and visually check the webbing for wear. Allow the webbing to retract, checking that retraction is smooth and complete.
3. With the webbing half unreeled, hold the tongue plate and pull forward quickly. The mechanism should lock automatically and prevent further unreeling.

If a seat belt fails any of these tests, contact Tesla immediately.

For information about cleaning seat belts, see [Seat Belts on page 191](#).

-  **WARNING:** Do not use after market comfort and convenience products that attach to the seat belts.
-  **WARNING:** When seat belts are not in use, they should be fully retracted and not hanging loose. If a seat belt does not fully retract, contact Tesla.
-  **WARNING:** The seat belt system has no user serviceable parts and may contain pyrotechnics. Do not disassemble, remove, or replace components.



Seat Belt Warnings

-  **WARNING:** Seat belts should be worn by all occupants at all times, even if driving for a very short distance. Failure to do so increases the risk of injury or death if a collision occurs.
-  **WARNING:** Secure small children in a suitable child safety seat as described in the Child Safety Seat topic. Always follow the child safety seat manufacturer's instructions when installing.
-  **WARNING:** Ensure that all seat belts are worn correctly. An improperly worn seat belt increases the risk of injury or death if a collision occurs.
-  **WARNING:** Do not wear seat belts over hard, fragile or sharp items in clothing, such as pens, keys, eyeglasses, etc. The pressure from the seat belt on such items can cause injury.
-  **WARNING:** Seat belts should not be worn with any part of the strap twisted.
-  **WARNING:** Each seat belt assembly must be used by one occupant only. It is dangerous to put a seat belt around a child being carried on an occupant's lap.
-  **WARNING:** Seat belts that have been worn in a collision must be inspected or replaced by Tesla, even if damage to the assembly is not obvious.
-  **WARNING:** Seat belts that show signs of wear (such as fraying), or have been cut or damaged in any way, must be replaced by Tesla.
-  **WARNING:** Avoid contaminating a seat belt's components with any chemicals, liquids, grit, dirt or cleaning products. If a seat belt fails to retract or latch into the buckle, it must be replaced immediately. Contact Tesla.
-  **WARNING:** Do not make modifications or additions that can prevent a seat belt mechanism from taking up slack, or that can prevent a seat belt from being adjusted to remove slack. A slack belt greatly reduces occupant protection.
-  **WARNING:** Do not make modifications that can interfere with the operation of a seat belt, or that can cause a seat belt to become inoperable.

Guidelines for Seating Children

Your Model X seat belts are designed for adults and larger children. You must restrain infants and small children in rear seats only, and you must use a suitable child safety seat appropriate for the child's age, weight, and size.

Never use child safety seats in the front passenger seat.

-  **WARNING:** Never seat a child in the front passenger seat, even if using a child safety seat.
-  **WARNING:** Never seat a child on a seat with an ACTIVE AIRBAG in front of it. DEATH or SERIOUS INJURY to the child can occur.
-  **WARNING:** For vehicles with third row seats, when a child is seated in a second row monopost seat, the setting for the button that moves a second row outboard seat forward for easy access into the third row should be **OFF** (touch **Controls** > **Seats** > **Easy Entry**). This ensures that you need to manually hold the button to move the seat, preventing a child seated in the second row from being pushed against the corresponding front seat. See [Adjusting Second Row Monopost Seats on page 27](#).

Refer to the following label located on the sun visors.

NOTE: The image(s) shown below are representative only and may not be identical to the labels in your vehicle.





Model X has an occupancy sensor in the front passenger seat that controls the passenger front airbag (see [Airbags on page 42](#)).



The Passenger Airbag Off indicator displays in the top corner of the touchscreen when the passenger front airbag is OFF. When the passenger front airbag is OFF, it does not inflate when a collision occurs. This indicator does not display when the seat is unoccupied.



To protect an adult occupying the front passenger seat, always double-check the passenger front airbag to confirm that it is ON.

-  **WARNING:** Always ensure that all Model X seats are locked in position before traveling. Failure to do so increases the risk of injury. Pay attention to all warnings displayed on the touchscreen.
-  **WARNING:** Do not associate the **Easy Entry** setting with the driver's profile when a child is seated in a second row seat. Doing so can cause the driver's seat to push against the child, especially when a child is seated in a forward-facing child seat or booster seat. Do not rely on Model X to recognize or accommodate a child seated in the second row seats while using this setting (see [Driver Profiles on page 48](#)).



Choosing a Child Safety Seat

All children age 12 and under should ride in the second and third row seats. Always use a child safety seat suitable for a young child's age and weight. The following table is based on child safety seat recommendations determined by the National Highway Traffic Safety Administration (NHTSA) in the United States (for more information, go to www.nhtsa.gov/equipment/car-seats-and-booster-seats).

	Infants	Toddlers	Young children
Age	Birth to 1 year*	Over 1 year*	4 years and older, and less than 57 in. (145 cm) tall
Weight	Up to at least 20 lbs (9 kg)**	Over 20 lbs (9 kg) (minimum) and up to 40 lbs (18 kg)*	Over 40 lbs (18 kg)
Type of child safety seat	Rear-facing (or convertible)	Forward-facing (or convertible)*	Seat belt retained booster seat
Seat position	Rear-facing only*	Forward-facing*	Forward-facing
Recommended attachment method	If combined weight of child and safety seat is up to 65 lbs (29.5 kg), attach using either LATCH** (lower anchor only) or the seat belt only.*** If combined weight of child and safety seat is over 65 lbs (29.5 kg), attach using the seat belt only.***	If combined weight of child and safety seat is up to 65 lbs (29.5 kg), attach using either LATCH** (both lower anchors and top tether anchor), or the seat belt and upper tether strap.*** If combined weight of child and safety seat is over 65 lbs (29.5 kg), attach using the seat belt and upper tether strap.***	Attach booster seats using the seat belt only.

* Many child safety seats currently available allow children to ride rear-facing using the child safety seat's integrated 5-point harness for a longer period of time **BASED UPON SPECIFIC HEIGHT AND WEIGHT LIMITS. Keep your child in a rear-facing seat for as long as possible. CHECK THE CHILD SAFETY SEAT MANUFACTURER'S INSTRUCTIONS AND CAREFULLY FOLLOW ALL INSTRUCTIONS.**

** **LATCH** ("Lower Anchors and Tethers for Children") and **ISOFIX** are international standards for attachment points for [child safety seats](#) in passenger cars that enable compliant child safety seats to be quickly and safely secured. The system has other regional names including **LUAS** ("Lower Universal Anchorage System") or **Canfix** in Canada. It has also been called the "Universal Child Safety Seat System" or **UCSSS**.

*** Subject to instructions provided by the child safety seat manufacturer.

 **WARNING:** Laws that govern how and where children should be carried when traveling in a vehicle are subject to change. It is the driver's responsibility to keep up to date on, and comply with, all current regulations in the region(s) where Model X is driven. To check the child passenger safety laws for states in the U.S., go to: http://www.ghsa.org/html/stateinfo/laws/childsafety_laws.html.

 **WARNING:** Do not use LATCH anchors with child safety seats or booster seats that have an integral safety belt where the combined weight of the child plus the child safety seat exceeds 65 lbs (29.5 kg).

Seating Larger Children

If a child is too large to fit into a child safety seat, but too small to safely fit into the standard seat belts, use a booster seat appropriate for the child's age and size. Carefully follow the manufacturer's instructions to secure the booster seat.

- Seat belt retained - these seats are secured using the vehicle's seat belts.
- LATCH retained - these seats attach to anchor bars built into the vehicle's second row outboard seats.

Check the child safety seat manufacturer's instructions and the table in this manual to determine which installation method to use. Some child safety seats can be installed using either method. Always follow the child safety seat manufacturer's instructions.

Installing Child Safety Seats

There are two general methods used to install child safety seats:



Child Safety Seats

Installing Seat Belt Retained Child Seats

First, make sure that the child safety seat is appropriate for the weight, height, and age of the child.

Avoid dressing the child in bulky clothing and do not place any objects between the child and the restraint system.

Adjust harnesses for every child, every trip.

To securely hold child safety seats, all passenger seating positions are equipped with an automatic locking retractor (ALR) feature that, by fully extracting the seat belt (beyond the length needed for a typical adult occupant), locks the belt into place until the seat belt is unbuckled and the webbing is fully retracted. The ALR mechanism operates as a ratchet, winding in slack and preventing the seat belt from extending any further until it has been completely rewound. When installing a child safety seat with integrated restraints, engage the belt's automatic locking retractor by pulling the seat belt webbing until it is **fully** extended. The ALR system engages only when the seat belt is at its maximum extension point.

The automatic locking retractor (ALR) feature is not used for booster seats in which a large child is restrained by the vehicle's seat belts directly, and therefore not using a child safety seat's integrated restraints.

NOTE: An automatic locking retractor disengages only when the seat belt is unbuckled and fully retracted. The belt can then be worn as a normal belt, sliding freely in and out and locking tight only in an emergency. Once disengaged, the belt must be fully extended to re-engage the locking mechanism whenever you install a child safety seat.

Always follow the detailed instructions provided by the child safety seat manufacturer. General guidelines are provided below.

1. Place the child safety seat in Model X, and fully extend the seat belt. Route and buckle the seat belt in accordance with the child safety seat manufacturer's instructions.



2. Allow the seat belt to retract, and remove all slack in the seat belt while firmly pushing the child safety seat into the Model X seat.
3. If the seat belt retained child safety seat has an upper tether, attach it to the back of the seat (see [Attaching Upper Tether Straps on page 39](#)).

Installing LATCH (ISOFIX) Child Seats

Lower LATCH anchors are provided in the second row outboard seats. The anchors are located between the seat's back rest and rear cushion. The exact location of each anchor is identified by a child safety seat identification button, illustrated below. The button is located on the seat back, directly above its associated anchor.

Bench Seats

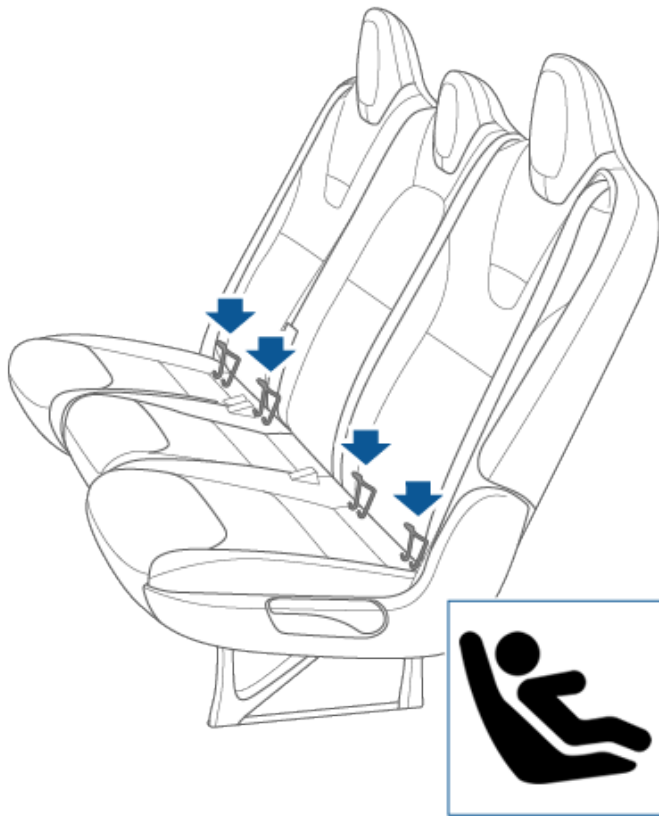

In the second row, install LATCH child safety seats in the outboard seating positions only. Use only a seat belt retained seat in the center position.

NOTE: If Model X is equipped with two seats in the second row, both seats support the use of LATCH child safety seats.

NOTE: Second row outboard seats support the use of upper tether straps (see [Attaching Upper Tether Straps on page 39](#)).

⚠ WARNING: Before driving after installing a child seat in the second row, ensure that a "seat unlocked" warning does NOT display on the touchscreen or instrument panel. This warning indicates that the seat is unsafe for an occupant because it was not returned to its safe, locked position. If the touchscreen or instrument panel displays the warning message, move the seat or backrest slightly forward or backward until it locks firmly into position and the message no longer displays.

Bench Seats



Monopost Seats

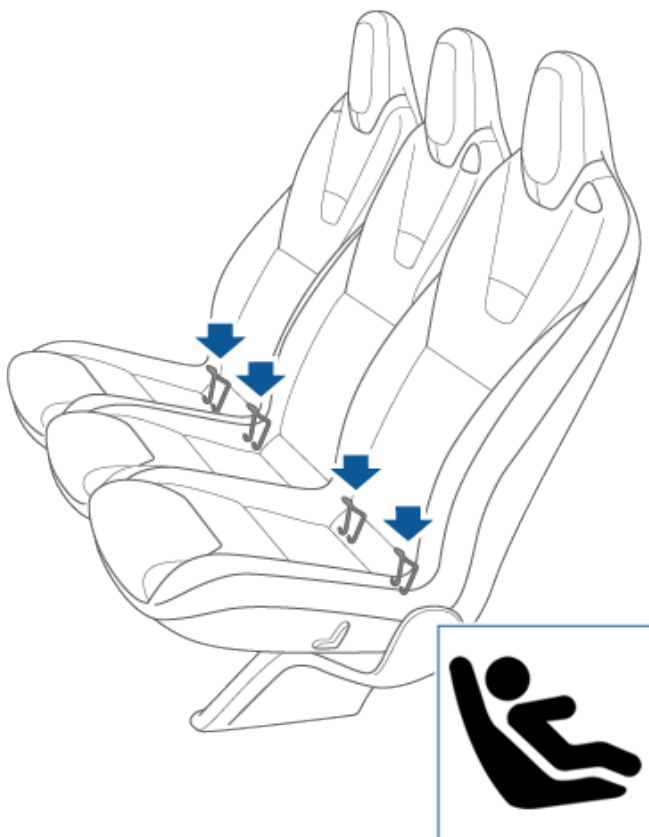

NOTE: To accommodate large rear-facing LATCH child safety seats, you may need to move the seat in the full rearward position, and move the corresponding front seat forward to the mid-track position (up to 13 cm forward of the rear-most position), raise the seat upward (3 cm from its lowest position), and angle the seat back to 15 degrees (or 10 degrees rearward from its forward-most position).

⚠ WARNING: Do not associate the **Easy Entry** setting with the driver's profile when a child is seated in the second row. Doing so can cause the driver's seat to push against the child, especially when a child is seated in a forward-facing child seat or booster seat. Do not rely on Model X to recognize or accommodate a child seated in the second row while using this setting (see [Driver Profiles on page 48](#)).

Monopost Seats



Child Safety Seats

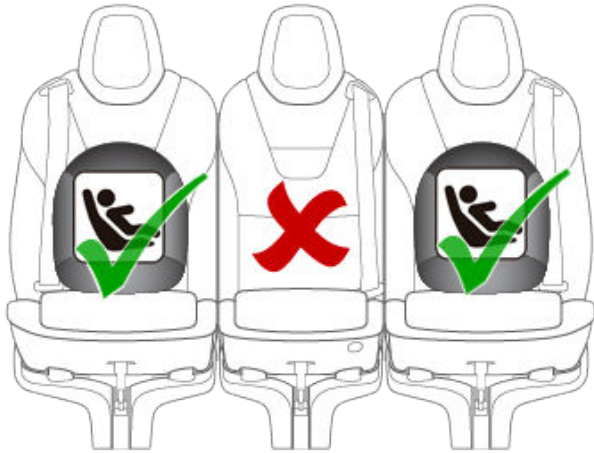

NOTE: To accommodate large rear-facing LATCH child safety seats, you may need to move the seat in the full rearward position, and move the corresponding front seat forward to the mid-track position (up to 13 cm forward of the rearmost position), raise the seat upward (3 cm from its lowest position), and angle the seat back to 15 degrees (or 10 degrees rearward from its forward-most position).

⚠ WARNING: For vehicles with third row seats, when a child is seated in a second row monopost seat, the setting for the button that moves a second row outboard seat forward for easy access into the third row should be **OFF** (touch **Controls > Seats > Easy Entry**). This ensures that you need to manually hold the button to move the seat, preventing a child seated in the second row from being pushed against the corresponding front seat. See [Accessing Third Row Seats \(if equipped\) - Monopost Seating](#) on page 28.

To install a LATCH child safety seat, slide the safety seat latches onto the anchor bars until they click into place. Carefully read and follow the instructions provided by the child safety seat manufacturer.

Bench Seats

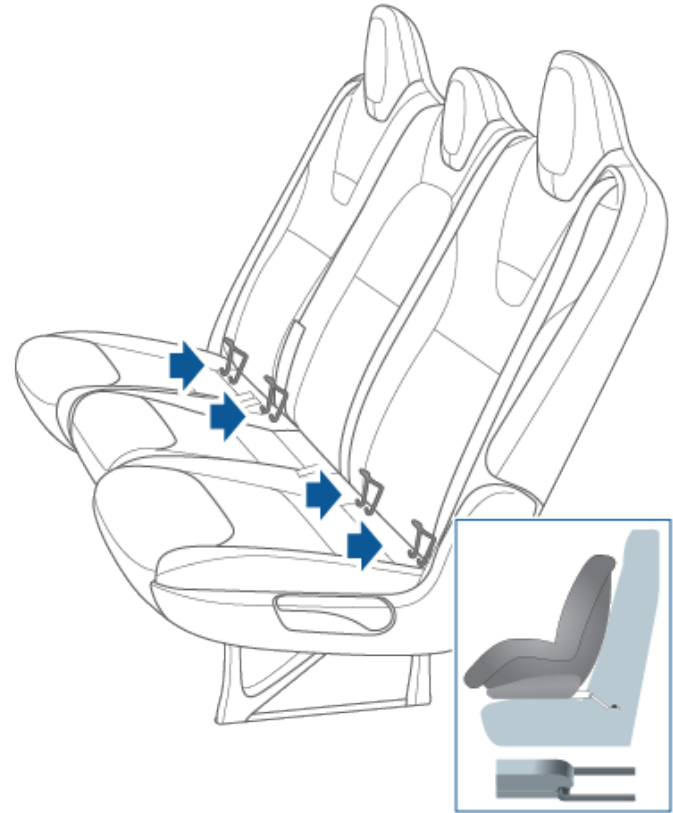

Monopost Seats

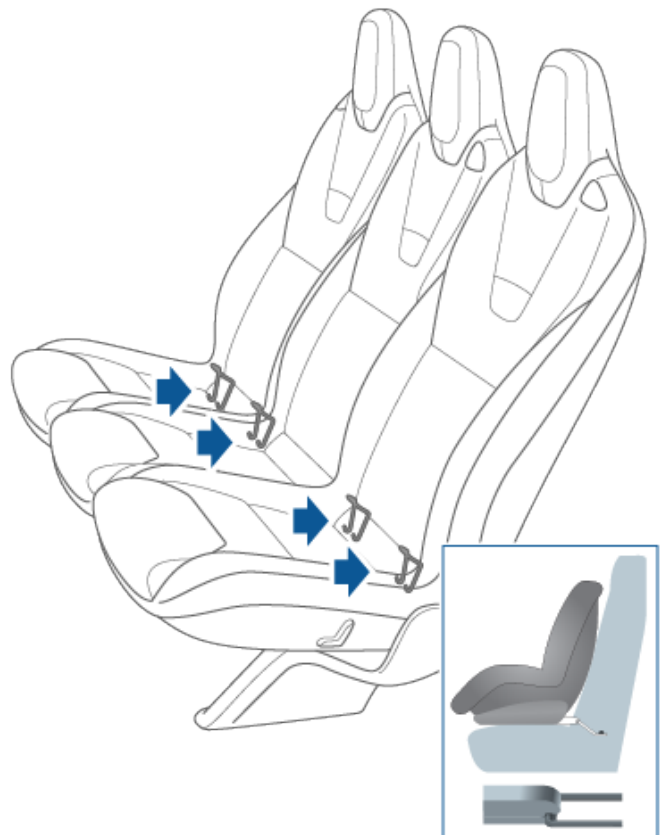



Once installed, test the security of the installation before seating a child. Attempt to twist the child safety seat from side to side and try to pull it away from the seat, then check to ensure the anchors remain securely in place.

NOTE: Lower LATCH anchors should not be used with child seats or booster seats that have an integrated safety belt in situations where the combined weight of the child plus the child safety seat is more than 65 lbs (29.5 kg). In these situations, use the seat belt instead.

Attaching Upper Tether Straps

If an upper tether strap is provided, attach its hook to the anchor point located on the back of the second and third row (if equipped) seats.

NOTE: The location of anchor points may not be readily visible but can be found by identifying a slice in the seat's material.

- ⚠ WARNING:** Tighten upper tether straps according to the instructions provided by the manufacturer of the child safety seat.
- ⚠ WARNING:** USE ONLY SEAT BELT RETAINED CHILD SAFETY SEATS IN THE CENTER SEATING POSITION.

For dual-strap tethers, position a strap on each side of the head restraint.

NOTE: If Model X is equipped with the optional six seat interior, a center seating position is not available in the second row.

- ⚠ WARNING:** When routing tether straps, keep the strap close to the headrest as illustrated below. On a Model X equipped with third row seats, do not allow a tether strap to cover the third row access button on the rear shoulder of the seat.

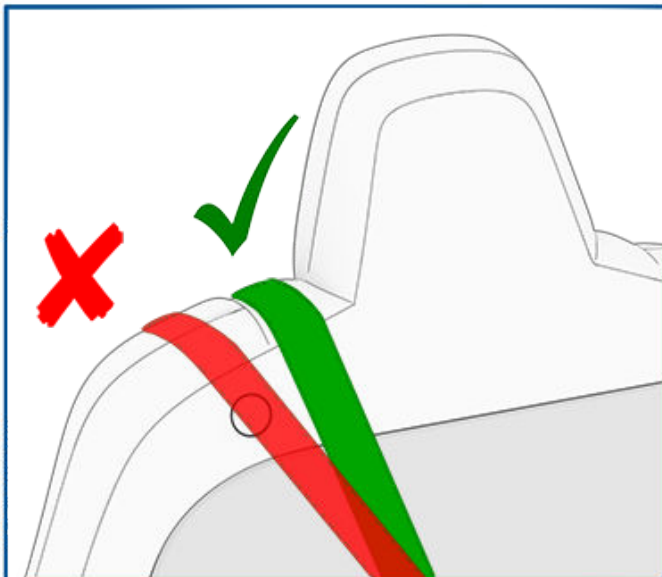

Dual Straps - Second Row Monopost Seats

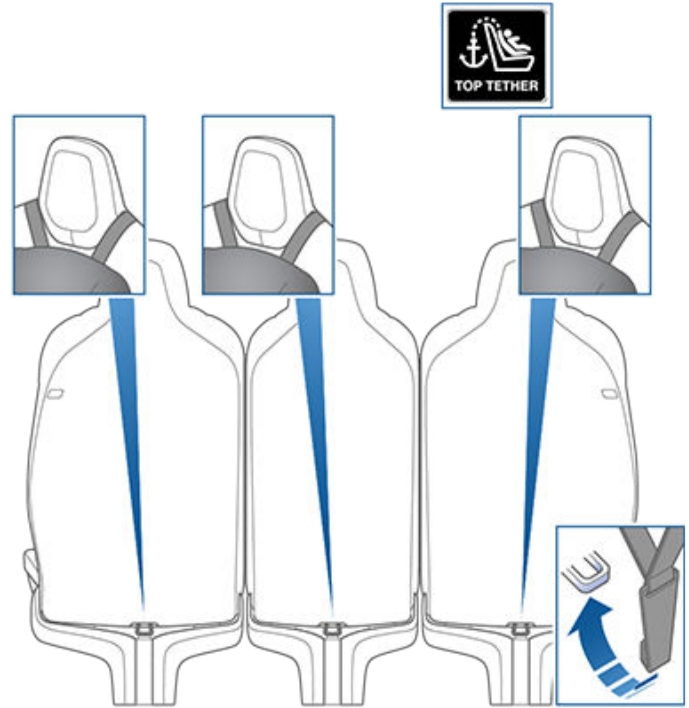

Dual Straps - Second Row Bench Seats

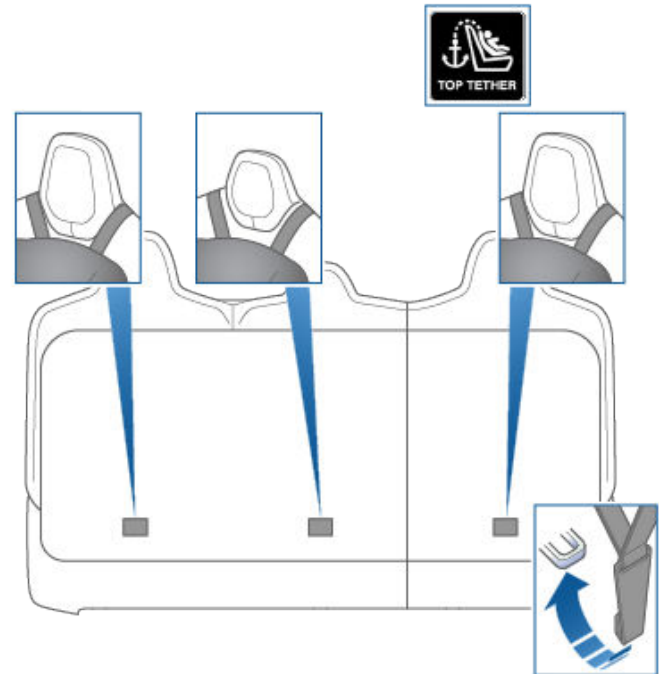

Dual Straps - Third Row Seats:



Child Safety Seats

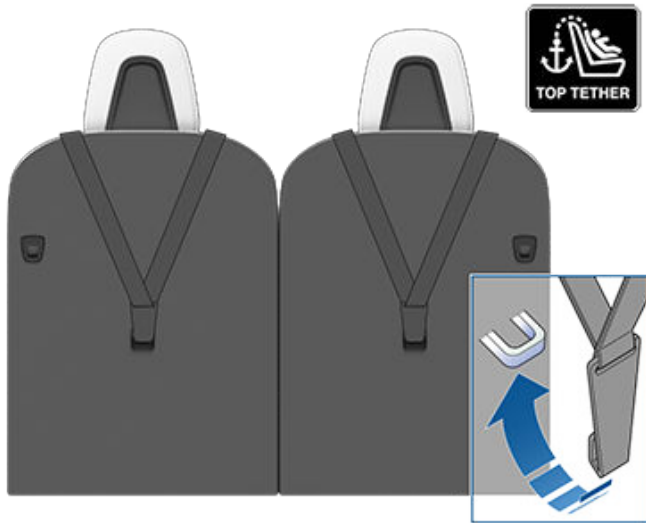

For single-strap tethers, position the strap in the outboard seating positions over the outside-facing side of the head restraint (the same side of the head restraint as the seat belt retraction mechanism). In the center seating position (if equipped), center and position the strap over the top of the head restraint.

Single Strap - Second Row Monopost Seats

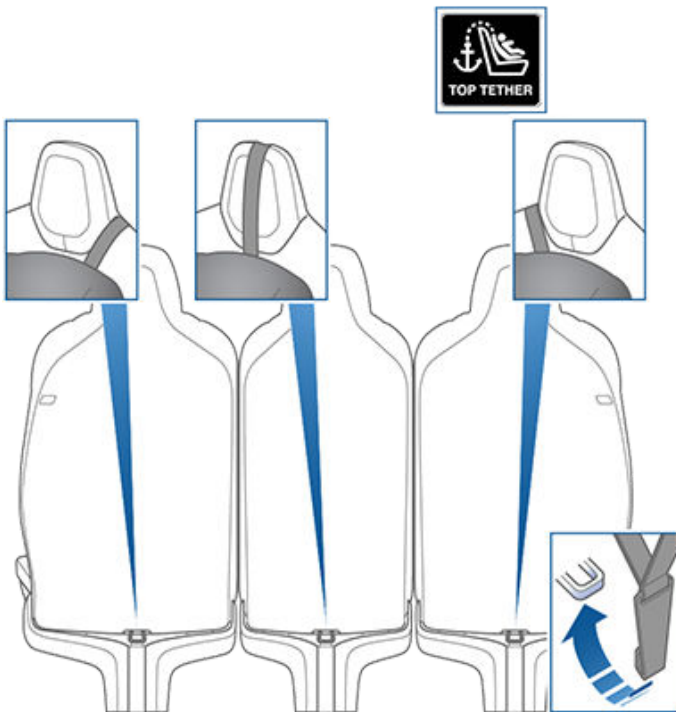

Single Strap - Second Row Bench Seats

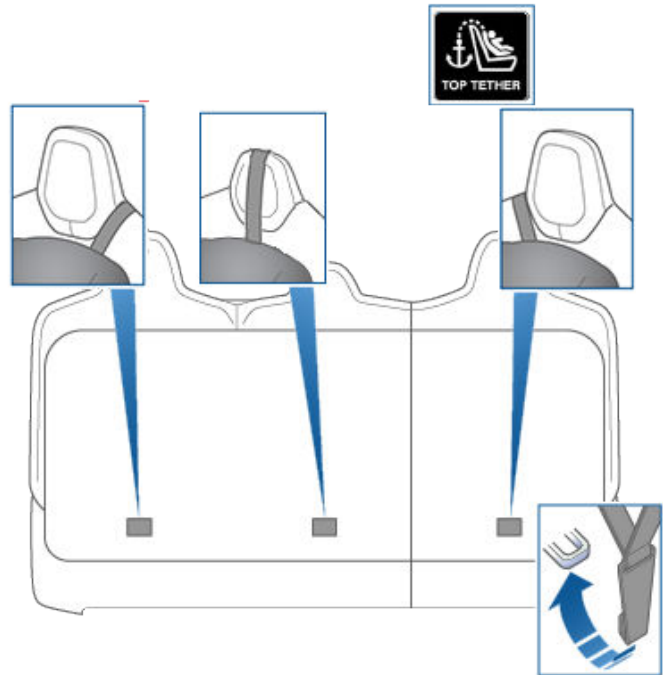

Single Strap - Third Row Seats

















Testing a Child Safety Seat

Before seating a child, always make sure the child safety seat is not loose:

1. Hold the child safety seat by the belt path and try to slide the safety seat from side to side and front to back.
2. If the seat moves more than one inch (2.5 cm), it is too loose. Tighten the belt or reconnect the LATCH retained child safety seat.
3. If you are unable to reduce slack, try a different seat location or try another child safety seat.



Child Safety Seat Warnings

-  **WARNING:** Extreme hazard! Do not seat a child on the front passenger seat even if you are using a child safety seat. This seat has an airbag in front of it. Although this airbag is disabled when Model X detects a lightweight passenger, do not rely on technology to protect your child.
-  **WARNING:** Child safety seats are designed to be secured in vehicle seats by lap belts or the lap belt portion of a lap-shoulder belt. A child could be endangered in a crash if a child safety seat is not properly secured in the vehicle.
-  **WARNING:** According to collision statistics, children are safer when properly restrained in a rear seating position than in the front passenger seat.
-  **WARNING:** Do not use a forward-facing child safety seat until your child weighs over 20 lbs (9 kg) and can sit independently. Up to the age of two, a child's spine and neck are not sufficiently developed to avoid injury in a frontal impact.
-  **WARNING:** Do not allow a baby or infant to be held on a lap. All children should be restrained in an appropriate child safety seat at all times.
-  **WARNING:** To ensure children are safely seated, follow all instructions provided in this document and by the manufacturer of the child safety seat.
-  **WARNING:** Children should ride in a rear-facing child safety seat using the seat's integrated 5-point harness for as long as possible.
-  **WARNING:** Do not use seat belt extenders on a seat belt that is being used to install a child safety seat or booster seat.
-  **WARNING:** When seating larger children, make sure the child's head is supported and the child's seat belt is properly adjusted and fastened. The shoulder portion of the belt must be away from the face and neck, and the lap portion must not be over the stomach.
-  **WARNING:** Never attach two child safety seats to one anchor point. In a collision, one anchor point may be incapable of securing both seats.
-  **WARNING:** Child safety seat anchors are designed to withstand only those loads imposed by a correctly fitted child safety seat. Under no circumstances are they to be used for adult seat belts, harnesses, or for attaching other items or equipment to the vehicle.
-  **WARNING:** Always check harnesses and tether straps for damage and wear.
-  **WARNING:** Never leave a child unattended, even if the child is secured in a child safety seat.
-  **WARNING:** Never use a child safety seat that has been involved in a collision. Have the seat inspected or replaced as described in the child safety seat manufacturer's instructions.



Location of Airbags

Airbags are located in the approximate areas shown below. Airbag warning information is printed on the sun visors.

Model X is equipped with an airbag and lap/shoulder belt at both front seating positions. The airbag is a supplemental restraint at those seating positions. All occupants, including the driver, should always wear their seat belts whether or not an airbag is also provided at their seating position to minimize the risk of severe injury or death in the event of a crash.

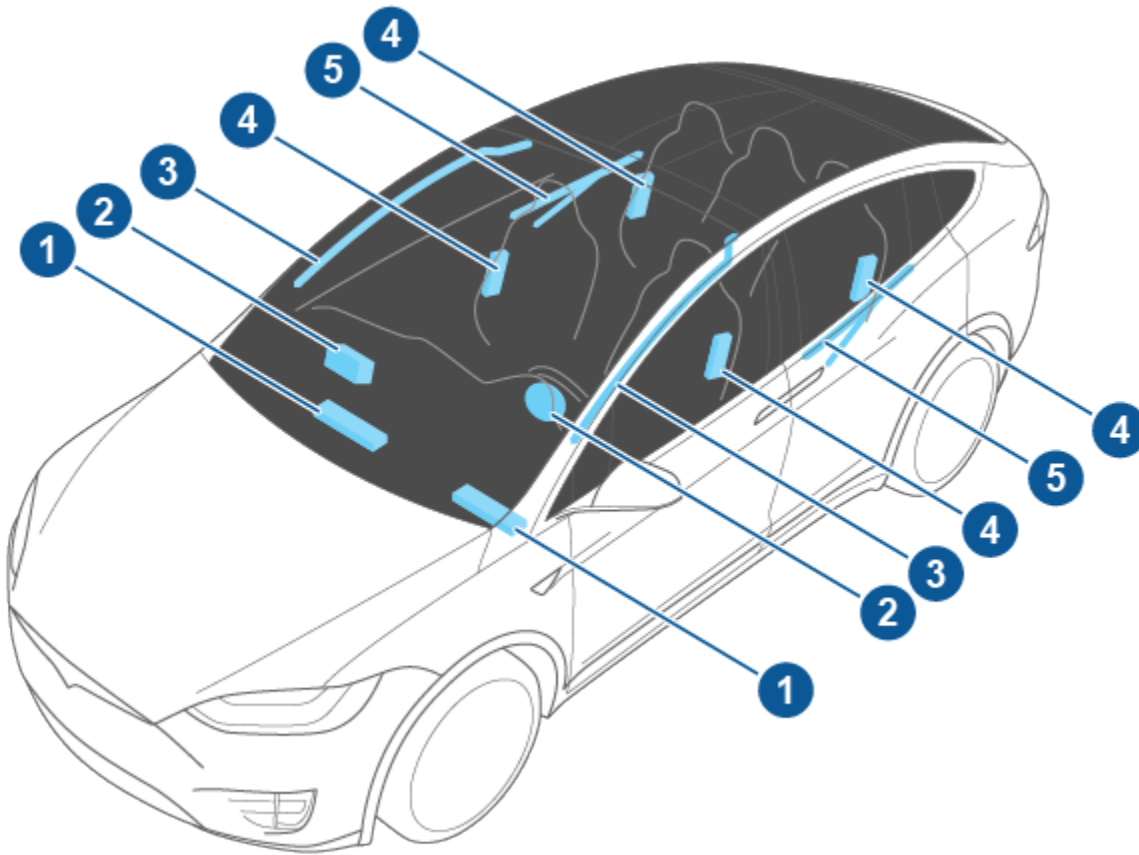

1. Knee airbags
2. Front airbags
3. Curtain airbags
4. Seat-mounted side airbags
5. Door-mounted airbags

How Airbags Work

Airbags inflate when sensors detect an impact that exceeds deployment thresholds. These thresholds are designed to predict the severity of a crash in time for the airbags to help protect the vehicle's occupants. Airbags inflate instantly with considerable force accompanied by a loud noise. The inflated bag, together with the seat belts, limits movement of occupants to reduce the risk of injury.

Front airbags are not ordinarily designed to inflate in rear collisions, rollovers, side collisions and when braking heavily or driving over bumps and potholes. Likewise, front airbags may not inflate in all frontal collisions, such as minor front collisions, underride collisions, or minor impacts with narrow objects (such as posts or poles). Significant superficial damage can occur to the vehicle without the airbags inflating and, conversely, a relatively small amount of structural damage can cause airbags to inflate. Therefore, the external appearance of the vehicle after a collision does not represent whether or not the front airbags should have inflated.

 **WARNING:** Before modifying your vehicle to accommodate a person with disabilities in a way that may affect the airbag system, contact Tesla.

Types of Airbags

Model X has the following types of airbags:

- **Front airbags:** The front airbags are designed to reduce injuries if larger children or adults are riding in the front seats. Follow all warnings and instructions related to seating a child on the front passenger seat (if permitted in your market region).
- **Knee airbags:** Knee airbags and the front airbags work together. The knee airbags limit the forward motion of the front seat occupants by restricting leg movement, thereby positioning the occupants so that the front airbags work more effectively. Whether or not knee airbags deploy in a collision is partially dependent on the track position of the associated seat.
- **Seat-mounted side airbags:** A seat-mounted side airbag in the front driver, front passenger and second row outboard seats help protect the pelvis and the thorax region of the torso. The seat-mounted side airbags on both the impacted and non-impacted side of the vehicle will inflate in the event of severe side impact or severe offset frontal impact.
- **Curtain airbags:** A curtain airbag on each side of Model X in the front roof-rail help protect the head. Curtain airbags on both the impacted and non-impacted side of the vehicle will inflate if a severe side impact occurs, a severe offset frontal impact occurs, or if the vehicle rolls over.

- **Door-mounted airbags:** There is an airbag on each side of Model X mounted in the trim on the falcon wing doors. These are the same as the curtain airbags in that they help protect the head and typically inflate in the event of a severe side impact, a severe offset frontal impact, or if the vehicle rolls over. The door-mounted airbags on both the impacted and non-impacted side of the vehicle will inflate.

Passenger Front Airbag Status

The status of the passenger front airbag displays on the touchscreen:



The Passenger Airbag Off indicator displays only when the passenger front airbag is OFF. When the passenger front airbag is OFF, it does not inflate when a collision occurs. This indicator does not display when the airbag is ON or when the seat is unoccupied.



To protect an adult occupying the front passenger seat, ensure the passenger front airbag is ON. When the passenger airbag is ON, it may inflate when a collision occurs.

Controlling the Passenger Front Airbag

Model X has an occupancy classification system (OCS) that controls the status of the passenger front airbag.

NOTE: The occupancy classification system (OCS) meets the regulatory requirement of FMVSS 208 and automatically detects when inflating the passenger front airbag would be unnecessary or potentially harmful.

WARNING: Seating an infant in a rear facing child safety seat on a seat equipped with an operational airbag can cause serious injury or death.

Object Classification	OCS Passenger Airbag Status*	Indicator status	Notes
Empty	OFF	PASSENGER AIRBAG OFF	
Object	OFF or ON	PASSENGER AIRBAG OFF or PASSENGER AIRBAG ON	Depends on material/contents
Rear facing child seat designed for children up to a year old	OFF	PASSENGER AIRBAG OFF	20 lbs (9 kg) or less
Forward facing child seat	OFF	PASSENGER AIRBAG OFF	35 lbs (16 kg) or less
Child in a booster seat	OFF or ON	PASSENGER AIRBAG OFF or PASSENGER AIRBAG ON	20-100 lbs (9-45 kg)*
Large child	OFF or ON	PASSENGER AIRBAG OFF or PASSENGER AIRBAG ON	
5th percentile female or larger (by weight)	ON	PASSENGER AIRBAG ON	Over approximately 100 lbs (45 kg)

*If the passenger airbag status indicator does not match the situation, do not use the seat. The passenger must ride in a different seat. Contact Tesla Service.

NOTE: It takes approximately six seconds after you power on Model X for the occupant classification system (OCS) to report accurate status of the front passenger airbag. As a result, when you first power on Model X, even in situations when it should be OFF because the seat is occupied by a weight of 20 lbs (9 kg) or less, it will take the touchscreen approximately six seconds to display the status, PASS AIRBAG OFF. If it fails to do so, contact Tesla Service and do not seat a child in the front passenger seating position.

To make sure the sensing system can correctly detect occupancy status, eliminate the following:

- Objects lodged under the seat.
- Heavy objects sitting on the seat (briefcase, large purse).
- Objects wedged between the seat back and seat cushion.
- Cargo interfering with the seat.
- Aftermarket items attached to, or sitting on or between, the seat and occupant including but not limited to covers, mats, blankets, etc.

These conditions can interfere with the occupancy sensor. If you have eliminated the above possibilities, and the airbag status is still incorrect, ask passengers to ride in the rear seats and contact Tesla to have the airbag system checked.

NOTE: The front passenger occupancy sensor affects the operation of the passenger front airbags only. The side airbags are not affected.

WARNING: If the front passenger airbag is not turning on or off as expected based on the weight thresholds previously described, contact Tesla immediately.

WARNING: Never seat a child in the front passenger seat. DEATH or SERIOUS INJURY to the child can occur. Per recommendations by the National Highway Traffic Safety Administration, all occupants age 12 and under must ride in the rear seats.

WARNING: To ensure accuracy of the occupant detection system, do not make any modifications to the front passenger seat.

⚠ WARNING: Do not use seat covers on Model X. Doing so could restrict deployment of the seat-mounted side air bags if a collision occurs. It can also reduce the accuracy of the occupant detection system, if equipped.

Ensuring Accurate Occupant Classification

To help ensure an occupant in the front passenger seat can be accurately classified, the passenger must:

- Wear a seat belt.
- Sit upright on the center of the seat cushion, with shoulders resting against the seat back and legs extended comfortably in front with feet on the floor. See [Examples of Correct and Incorrect Seating Positions on page 45](#).
- Remain positioned on the seat cushion and not lift their weight off the seat (for example, by pushing their feet against the floor or pressing on the center console or armrest to lift up).
- Never wear thick, wet, or bulky clothing (such as ski wear or padded clothing).

In addition to the items listed above, the following situations can interfere with the accuracy of the occupant classification system:

- Placing a radio transmitter (for example, a hunting radio or walkie-talkie) on the front passenger seat.
- Placing an AC/DC inverter, or a device that is being powered by the inverter (for example, a cell phone, tablet, or computer) on the front passenger seat cushion.
- Placing liquid (such as a bottled drink) or food containers on a car seat when a child seat is present.
- Incorrectly placing a child safety seat so that the entire lower section is not positioned against the seat cushion.
- Objects lodged under the seat or wedged between the seat back and cushion.
- Heavy objects sitting on the seat (briefcase, large purse).
- Cargo interfering with the seat.
- Aftermarket items attached to or placed between the seat and the occupant, such as covers, mats, blankets, etc.

These conditions can interfere with the occupancy sensor. If you have eliminated the above possibilities, and the airbag status is still incorrect, instruct passengers to ride in the rear seats and contact Tesla to have the airbag system checked.

NOTE: Tesla follows NHTSA (National Highway Traffic Safety Administration) recommendations that all occupants age 12 and under must ride in the rear seating positions.

NOTE: The front passenger occupancy sensor affects the operation of the passenger front airbags only. The side airbags are not affected.

- ⚠ WARNING:** Failure to follow the above instructions can adversely affect the Occupant Classification System (OCS) which can cause serious injury or death.
- ⚠ WARNING:** If the front passenger airbag is not turning on or off as expected, do not seat a passenger in the front passenger seat. Contact Tesla Service.
- ⚠ WARNING:** To ensure accuracy of the occupant detection system, do not make any modifications to the front passenger seat.
- ⚠ WARNING:** Do not use seat covers on Model X. Doing so could restrict deployment of the seat-mounted side air bags if a collision occurs. It can also reduce the accuracy of the occupant classification system.

Examples of Correct and Incorrect Seating Positions

Correct seating position:



Incorrect seating position - the passenger's feet must be on the floor:



Airbags

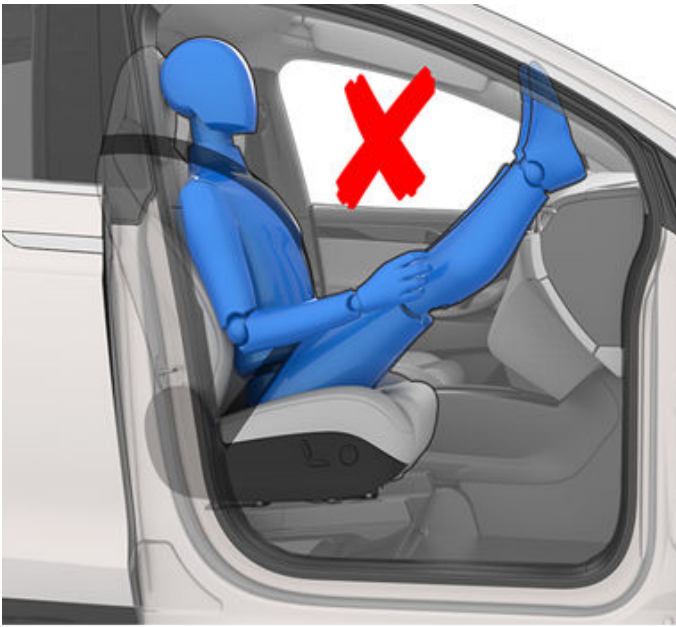

Incorrect seating position - the passenger must not slide forward on the seat cushion:

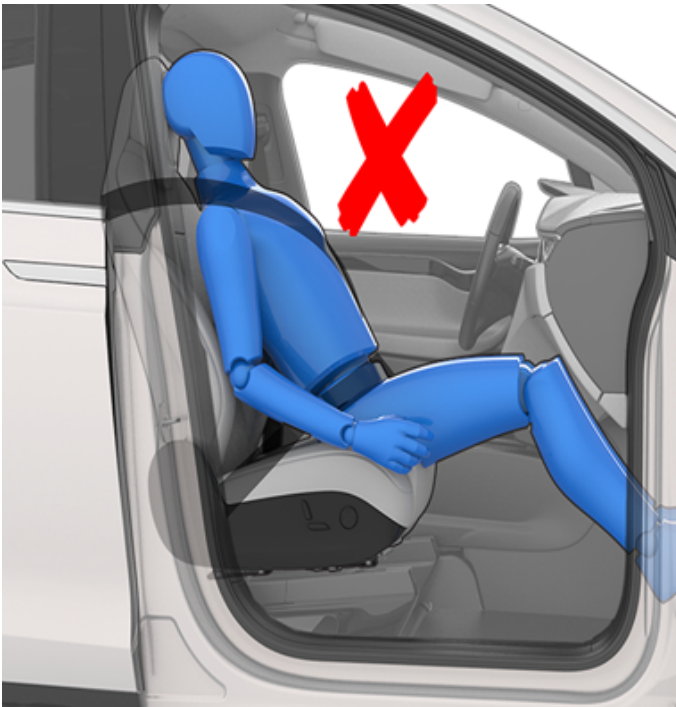

Incorrect seating position - the passenger must not recline the backrest to a laying down position when the vehicle is moving:

Inflation Effects

⚠ WARNING: When airbags inflate, a fine powder is released. This powder can irritate the skin and should be thoroughly flushed from the eyes and from any cuts or abrasions.

After inflation, the airbags deflate to provide a gradual cushioning effect for the occupants and to ensure the driver's forward vision is not obscured.

If airbags have inflated, or if your vehicle has been in a collision, always have the airbags, seat belt pre-tensioners and any associated components checked and, if necessary, replaced by Tesla.

In a collision, in addition to the airbags inflating:

- Doors and liftgate unlock.
- Hazard warning lights turn on.
- Interior lights turn on.
- High voltage is disabled.

To restore high voltage power, use the touchscreen to manually power off Model X (see [Powering Off](#) on page 54), then press the brake to power it back on again.

Airbag Warning Indicator





The airbag indicator on the touchscreen remains lit if the airbag system is malfunctioning. The only time this indicator should light up is briefly when Model X first powers up, in which case it turns off within a few seconds. If it remains lit, contact Tesla immediately and do not drive.

 **WARNING:** Do not attach or place objects on or near the front airbags, the side of the front seats, the headliner at the side of the vehicle, or any other airbag cover that could interfere with inflation of an airbag. Objects can cause serious injury if the vehicle is in a collision severe enough to cause the airbag to inflate.

 **WARNING:** Following inflation, some airbag components are hot. Do not touch until they have cooled.

Airbag Warnings

 **WARNING:** All occupants, including the driver, should always wear their seat belts, whether or not an airbag is also provided at their seating position, to minimize the risk of severe injury or death in the event of a collision.

 **WARNING:** Front seat occupants should not place their arms over the airbag module, as an inflating airbag can cause fractures or other injuries.

 **WARNING:** Do not use seat covers on Model X. Doing so could restrict deployment of the seat-mounted side air bags if a collision occurs. It can also reduce the accuracy of the occupant detection system, if equipped.

 **WARNING:** Airbags inflate with considerable speed and force, which can cause injury. To limit injuries, ensure that occupants are wearing seat belts and are correctly seated, with the seat positioned as far back as possible. The National Highway Traffic Safety Administration (NHTSA) recommends a minimum distance of 10" (25 cm) between an occupant's chest and an airbag.

 **WARNING:** Children should not be seated on the front passenger seat. Follow all regulations in your region for the appropriate way to seat a child based on the child's weight, size, and age. The safest place to seat infants and young children is in a rear seating position. Seating an infant or child on a seat equipped with an operational front airbag can cause serious injury or death.

 **WARNING:** Do not use a rear-facing child safety seat on a seat with an operational airbag in front of it. Doing so can cause injury or death if the airbag inflates.

 **WARNING:** To ensure correct inflation of the side airbags, maintain an unobstructed gap between an occupant's torso and the side of Model X.

 **WARNING:** Passengers shouldn't lean their heads against doors. Doing so can cause injury if a curtain airbag inflates.

 **WARNING:** Do not allow passengers to obstruct the operation of an airbag by placing feet, knees or any other part of the body on or near an airbag.

Creating a Driver Profile

When you first adjust the driver's seat, steering wheel position, or exterior side mirrors, the touchscreen prompts you to create a driver profile to save these adjustments. Your profile also saves various preferences you make while customizing Model X.



To add a new driver profile, touch the driver profile icon at the top of the touchscreen. Then touch **Driver Profile Settings** > **Add New Driver**, type the driver's name and touch **Create Profile**. Follow the onscreen instructions. Check the **Use Easy Entry** checkbox if you want to save (or use existing) **Easy Entry** settings in which the driver's seat and the steering wheel are automatically adjusted to make it easy to enter and exit Model X.

If you change the position of the driver's seat, steering wheel, or exterior side mirrors after you have saved or chosen a driver profile, the touchscreen prompts you to **Save** the new position or **Restore** the previously saved position (other settings are automatically saved). To change a setting without saving or restoring, just ignore the prompt.

NOTE: Valet mode is a built-in driver profile that limits speed and restricts access to some Model X features (see [Valet Mode on page 48](#)).

NOTE: To stop automatic adjustments that are in process based on a driver's profile, touch **Stop** on the Driver Profile dropdown menu. Automatic adjustments also stop if you manually adjust a seat, mirror, or the steering wheel.

Easy Entry

You can define an Easy Entry setting that moves the steering wheel and driver's seat to make it easy to enter and exit Model X. Any driver can use the Easy Entry setting by associating it with their driver's profile. When the Easy Entry setting is associated with a driver's profile, the steering wheel and driver's seat automatically adjust when in Park and the driver's seat belt is unbuckled, allowing an easy exit from Model X. When returning to the vehicle and stepping on the brake pedal, settings automatically adjust back to the settings used by the most recent driver profile (or based on the key if it's linked to a driver profile).

To use **Easy Entry** with a driver profile, ensure the **Use Easy Entry** box is checked.

 **WARNING:** Never use Easy Entry to move the driver's seat to the full rearward position when a child safety seat is installed on a rear seat located behind the driver's seat. With reduced clearance, the movement of the seat may impact a child's legs, cause injury, or dislodge the seat.

Selecting Between Driver Profiles



To adjust Model X based on a driver's profile, touch the driver profile icon at the top of the touchscreen. Then choose the driver, and Model X is adjusted based on the settings that have been saved to the chosen driver profile.

Saved Settings

A subset of the settings that you choose to customize your Model X are automatically saved to your driver's profile. Once saved, a green check mark appears next to the driver profile icon on the touchscreen. Examples of automatically saved driver profile settings are:

- Navigation, temperature, lights and display settings.
- Autopilot and driving preferences.

Linking a Driver Profile to a Key Fob

You can link a driver profile to a specific key fob to allow Model X to automatically select the correct driver profile when the linked key fob is detected as you approach the vehicle and open the driver's door. To link a driver profile to a key fob, enter Model X with the key fob and touch the driver profile icon at the top of the touchscreen. Select the driver profile you would like to link to the key fob, then touch **Link to Key Fob**.

NOTE: Model X detects only one key fob at a time. The driver profile is linked to the key fob that is detected by the vehicle at that time. Therefore, if you want to link driver profiles to multiple key fobs, ensure that only the key fob that you would like to link the driver profile to is within detection range while performing the linking procedure. Move all other key fobs outside of the detection range (at least three feet (one meter) away from Model X).

NOTE: Model X can support up to eight linked key fobs. However, a driver profile can only be linked to one key fob.

To remove the link between a driver profile and key fob, touch the driver profile icon at the top of the touchscreen. Select the driver profile, then touch the X next to **Linked to Key Fob**.

Valet Mode

When Model X is in Valet mode, the following restrictions apply:

- Speed is limited to 70 mph (113 km/h).
- Maximum acceleration and power are limited.



- Front trunk and glovebox are locked.
- Home and Work locations are not available in the navigation system.
- Voice commands are disabled.
- Autopilot convenience features are disabled.
- The Allow Mobile Access setting cannot be changed
- HomeLink (if available in your market region) is not accessible.
- Driver Profiles are not accessible.
- Wi-Fi and Bluetooth are disabled. When Model X is in Valet mode, you cannot pair new Bluetooth devices or view or delete existing paired devices. However, if a Bluetooth-paired device or a known Wi-Fi network is within range, Model X connects to it.

When you cancel Valet mode, all settings associated with the most recently used driver profile and climate control settings are restored, and all features are available.

NOTE: You do not need to enter a PIN to cancel Valet mode from the mobile app.

Starting Valet Mode

With Model X in Park, touch the driver profile icon at the top of the touchscreen, then touch **Valet Mode**.

The first time you enter Valet mode, the touchscreen prompts you to create a 4-digit PIN you will use to cancel Valet mode.

When Valet mode is active, the instrument panel displays the word **Valet** and the Valet mode driver profile displays on the touchscreen.

You can also use the mobile app to start and cancel Valet mode (provided Model X is in Park). When using the mobile app, you do not need to enter a PIN because you are already required to log into the app using your Tesla Account credentials.

NOTE: If the **PIN to Drive** setting is enabled (see [PIN to Drive on page 161](#)), you must enter the driving PIN before you can define or enter a Valet PIN. Once in Valet mode, Model X can be driven without the valet needing to enter the driving PIN.

NOTE: The **PIN to Drive** setting is not available when Valet mode is active.

If you forget your valet PIN, reset it from inside Model X by entering your Tesla Account credentials (which also cancels Valet mode). You can also reset your PIN using the mobile app.



WARNING: Do not use Valet mode when towing a trailer. The torque limitations of Valet mode can make it difficult for Model X to pull a trailer up a hill.

Canceling Valet Mode

With Model X in Park, touch the **Valet Mode** driver profile icon at the top of the touchscreen, and enter your 4-digit PIN.

Adjusting Steering Wheel Position

Adjust the steering wheel to the desired driving position by moving the control on the left side of the steering column. Using this control, you can move the steering wheel forward and backward and up and down.

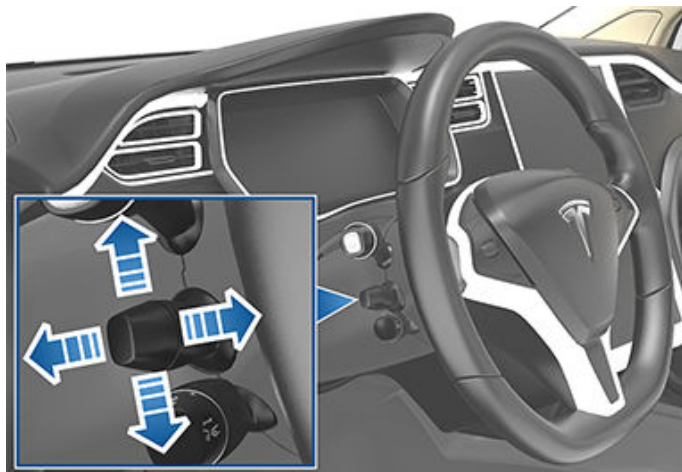

WARNING: Do not make adjustments while driving.

Adjusting Steering Effort

You can adjust the feel and sensitivity of the steering system to suit your personal preference:

1. On the touchscreen, touch **Controls > Pedals & Steering > Steering Mode**.
2. Choose a steering option:
 - **Comfort** - Reduces the effort required to turn the steering wheel. In town, Model X feels easier to drive and park.
 - **Standard** - Tesla believes that this setting offers the best handling and response in most conditions.
 - **Sport** - Increases the effort required to turn the steering wheel. When driving at higher speeds, Model X feels more responsive.

Using Left Steering Wheel Buttons

Use the buttons on the left side of the steering wheel to change radio stations, control media player volume, and to choose what displays on the left side of the instrument panel (whenever the Navigation app is not displaying instructions).

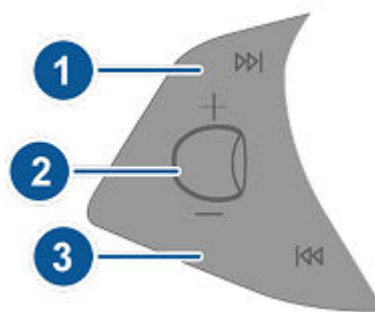

1. Next

If you are listening to local or satellite radio and you have defined more than one radio preset, press to play the next preset in the radio band that is currently playing. If you have not defined more than one preset, press to go to the next available frequency.

If you are listening to Internet radio, or to an audio file on a connected Bluetooth or USB device, press to skip to the next song or station.

If you have more than one favorite defined, press and hold to cycle through favorites.

2. Scroll Button

- To adjust the media volume, roll up or down.

NOTE: The scroll button adjusts the volume for media, navigation instructions and phone calls based on what is currently in use. As you adjust volume, the instrument panel displays the volume level and whether you are adjusting volume for media, navigation or phone.

- To mute the media volume, or to pause/play an audio file, tap the scroll button.
- To choose what displays on the left side of the instrument panel, hold the scroll button briefly until the available options are displayed. Roll the scroll button to choose **Empty, Car Status, Clock, Media, Energy, Trips, Suspension**, etc. When the option you want is highlighted, tap the scroll button.

NOTE: The option you choose to display using the left scroll button is retained until you manually change it.

NOTE: Car status displays information such as status of doors and trunks, and on newer model vehicles, the tire pressure measurements.

3. Previous

Same as described above for Next, except it skips to the previous song or station. If you have more than one favorite defined, press and hold to cycle through favorites.

NOTE: Regardless of how you customize the left side of the instrument panel, it automatically changes to display navigation instructions (if applicable), or to let you know if a door or trunk is open when Model X is in Drive or Reverse.

Using Right Steering Wheel Buttons

Use the buttons on the right side of the steering wheel to access call options while on a phone call, to choose what displays on the right side of the instrument panel, to adjust Model X features, and to use voice commands.

NOTE: Whenever you receive or make a phone call, the right side of the instrument panel automatically displays call options to help you easily handle phone calls on your Bluetooth-connected phone.

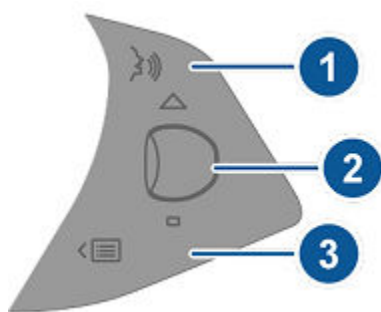

1. Press to use a voice command to call a contact, navigate, or listen to Internet music. When you hear the tone, speak your command. For details, see [Voice Commands on page 159](#).
2. Scroll Button
 - During a phone call, touch the scroll button to display call options that allow you to perform an action on the call.
 - Roll the scroll button to adjust the most recently used feature from the feature list (see Menu button).
 - To choose what displays on the right side of the instrument panel, hold the scroll button briefly until the available options are displayed. Roll the scroll button to choose **Empty**, **Car Status**, **Clock**, **Media**, **Energy**, **Trips**, **Suspension**, etc. When the option you want is highlighted, tap the scroll button.

NOTE: Car status displays information such as status of doors and trunks, and on newer model vehicles, the tire pressure measurements.

NOTE: The option you choose to display using the right scroll button is retained until you manually change it.

- To restart the touchscreen, hold down both scroll buttons for approximately five seconds. See [Restarting the Touchscreen on page 54](#).

- **Suspension.** Display a real-time visualization of how the suspension system is dynamically adjusting each wheel's damping to account for changing road conditions. Roll the scroll button to choose Suspension and then press the scroll button. See [Air Suspension on page 157](#).

3. Menu button

Press to display a menu that allows you to control the following Model X:

- **Temperature.** Roll the scroll button to change the driver side temperature, or press the wheel to turn the climate control system on and off.
- **Fan Speed.** Roll the scroll button to adjust the speed of the fan used to cool or heat the cabin.
- **Display Brightness.** Roll the scroll button to change the brightness level of the displays, or press the wheel to restore default settings.
- **Recent Calls.** If your phone is paired to Model X, roll the scroll button to view your recent calls. Press the scroll button to call the contact that's displayed. To pair your phone, see [Pairing a Bluetooth Phone on page 154](#).
- **Contacts.** If your phone is paired to Model X, roll the scroll button to navigate to contacts in your phone. Your contacts are listed alphabetically by their last name. To pair your phone, see [Pairing a Bluetooth Phone on page 154](#).

Press the menu button again to close the feature list.

Heated Steering Wheel

If Model X is equipped with the cold weather package, you can warm up the steering wheel by touching climate controls on the touchscreen (see [Climate Controls on page 138](#)). When turned on, radiant heat keeps the steering wheel at a comfortable temperature.

Horn

To sound the horn, press and hold the center pad on the steering wheel.



Steering Wheel



Adjusting Exterior Mirrors

Press the button associated with the mirror you want to adjust (left or right). The button's light turns on and you can then press the dial to move the mirror to the desired position. Repeat for the other side mirror. If prompted, touch **Save** on the touchscreen to save the mirror adjustment in your driver profile.



To fold and unfold exterior mirrors, press the center button. You can set the mirrors to fold automatically whenever Model X is locked by touching **Controls > Vehicle > Mirror Auto-Fold**. The mirrors unfold automatically whenever you unlock Model X.

When you use the center button to fold the mirrors in for parking in a tight space, the mirrors remain folded in until your driving speed reaches 31 mph (50 km/h), or until you use the center button to unfold the mirrors.

NOTE: You can override the automatic folding/unfolding of mirrors at any time (for example, Model X has no power) by pushing the mirror assembly away from you to unfold, or pulling it toward you to fold.

NOTE: You cannot fold a mirror if driving above 31 mph (50 km/h).



The driver's side mirror automatically dims at night, in proportion to the level of glare from the headlights of a vehicle behind you (except when in Reverse). Also, both exterior side mirrors have heaters that turn on and off with the rear window defroster.

NOTE: See [Cold Weather Best Practices on page 91](#) for information to ensure your mirrors function properly in cold weather.

Auto-Fold Mirrors Based on Location

Model X can automatically fold and unfold the side mirrors based on location, which saves you from having to manually position them each time you need to fold or unfold the mirrors when at a frequented place (such as narrow garages, tight parking spaces, etc.).

To set up, Model X must be driving at a low speed (less than 3 mph/5 kph) or stopped at the location you want your vehicle to remember. Go to **Controls > Vehicle > Always Fold Mirrors at this Location**. Next time you approach the saved location, your mirrors fold and unfold within 25 feet (7.5 meters) of the specified location.

You can also integrate auto-folding mirrors with HomeLink (see [HomeLink Universal Transceiver on page 165](#)). To enable, go to **HomeLink > Auto-Fold Mirrors when Nearby**.

 **CAUTION:** Mirrors may not automatically fold or unfold if you return to a saved location and are driving faster than 3 mph/5 kph.

Mirror Auto-tilt When Reversing

Both exterior mirrors can automatically tilt downward when backing up. To adjust the auto-tilt position, shift into Reverse, then adjust the mirrors (press the button associated with the mirror you want to adjust, then press the dial to move the mirror to the desired position).

When you shift into another drive mode, the mirrors tilt back to their normal (upward) position. But now that you have adjusted them for backing up, they automatically tilt to the selected downward position whenever you shift into Reverse.

You can turn the auto-tilt feature on or off using the touchscreen, Touch **Controls > Vehicle > Mirror Auto-Tilt**.

Rear View Mirror

The rear view mirror is adjusted manually. When in Drive or Neutral, the rear view mirror automatically dims in low lighting conditions based on the time of day (for example, when driving at night).

Starting and Powering Off

Starting

When you open a door to enter Model X, the instrument panel and touchscreen power on and you can operate all controls. To drive Model X:

1. **Press the brake pedal** - Model X powers on and is ready to drive.
2. **Select a drive mode** - move the drive stalk down for Drive or up for Reverse (see [Shifting on page 56](#)).

NOTE: If the **PIN to Drive** feature is enabled (see [PIN to Drive on page 161](#)), you must also enter a valid PIN on the touchscreen before you can drive Model X.

Everything you need to know when driving Model X displays on the instrument panel.

Key Fob Not Inside

If Model X does not detect a key fob when you press the brake, the instrument panel displays a message telling you that a key fob is not inside.

If you receive this message, press the brake and place the key fob in the center console cup holder where Model X can best detect it.

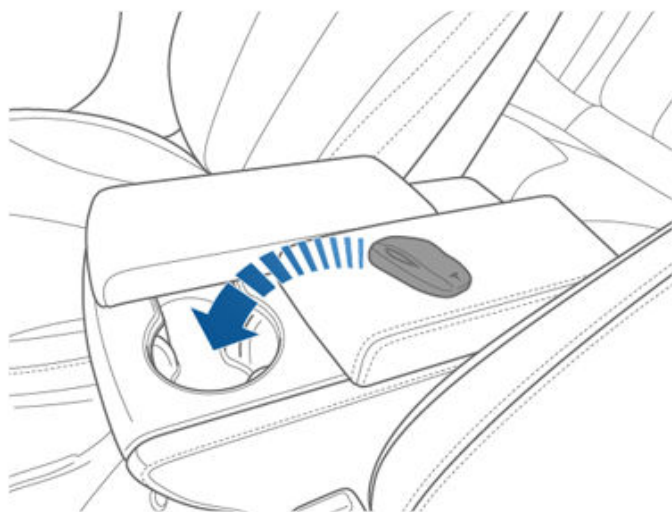

If Model X still does not detect the key fob, try holding it against the center console, immediately below the low voltage power socket (see [Low Voltage Power Socket on page 23](#)). If the key fob is still not detected, remove the key fob's battery and try again. See [Replacing the Key Fob Battery on page 9](#). Or try using another key fob. If another key fob does not work, contact Tesla.

A number of factors can affect whether Model X can detect the key fob. These include a low battery in the key fob, interference from other devices using radio signals, and objects between the key fob and receiver.

Always keep the key fob with you. After driving, the key fob is needed to restart Model X after it powers off. And when you leave Model X, you must bring the key fob with you to lock Model X, either manually or automatically.

Powering Off

When you finish driving, shift into Park by pressing the button on the end of the drive stalk. When you leave Model X with the key fob, it powers off automatically, turning off the instrument panel and touchscreen.

Model X also powers off automatically after being in Park for 15 minutes, even if you are sitting in the driver's seat.

Although usually not needed, you can power off Model X while sitting in the driver's seat, provided the vehicle is not moving. Touch **Controls** > **Safety** > **Power Off**. Model X automatically powers back on again if you press the brake pedal or touch the touchscreen.

NOTE: Model X automatically shifts into Park whenever it determines that you are exiting the vehicle (for example, the driver's seat belt is unbuckled and the vehicle is almost at a standstill). If you shift into Neutral, Model X shifts into Park when you open the door to exit. To keep Model X in Neutral, see [Instructions for Transporters on page 215](#).

Restarting the Touchscreen

You can restart your touchscreen if it is unresponsive or demonstrates unusual behavior.

NOTE: To ensure the safety of occupants as well as other road users, restart the touchscreen only when the vehicle is in Park.

1. Shift into Park.
2. Hold down both scroll buttons on the steering wheel until the touchscreen turns black.





3. After a few seconds, the Tesla logo appears. Wait approximately 30 seconds for the touchscreen to restart. If the touchscreen is still unresponsive or demonstrating unusual behavior after a few minutes, try power cycling the vehicle. See [Power Cycling the Vehicle on page 55](#).

NOTE: Restarting the touchscreen using the scroll buttons does not power Model X off and on.

Power Cycling the Vehicle

You can power cycle Model X if it demonstrates unusual behavior or displays a nondescript alert.

1. Shift into Park.
2. On the touchscreen, touch **Controls > Safety > Power Off**.
3. Wait for at least two minutes without interacting with the vehicle. Do not open the doors, touch the brake pedal, touch the touchscreen, etc.
4. After two minutes, press the brake pedal or open the door to wake the vehicle.

How to Shift

When Model X is in Park, you must press the brake pedal to shift.

Move the drive stalk up or down to shift into different drive modes.

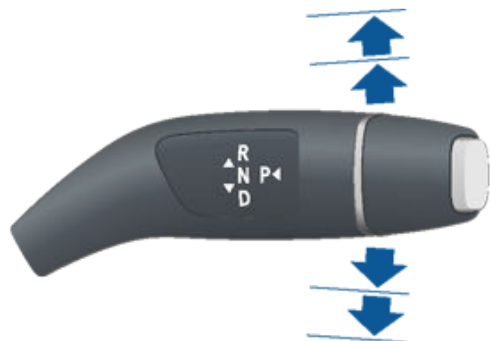

If you try to shift when it is prohibited by the current driving speed, a chime sounds and the drive mode does not change.

Reverse

Push the drive stalk all the way up and release. You can only shift into Reverse when Model X is stopped or moving less than 5 mph (8 km/h).

Neutral

Push the drive stalk up or down to the first position and release to shift into Neutral. Neutral allows Model X to roll freely when you are not pressing the brake pedal.

NOTE: If Autosteer or Traffic-Aware Cruise Control (if equipped) is active, you must push the drive stalk up or down to the first position and hold it there for more than 1 second to shift into Neutral. In doing so, Autosteer or Traffic-Aware Cruise Control is disabled.

NOTE: You must press the brake pedal to shift out of Neutral if driving slower than approximately 5 mph (8 km/h).

If Model X is in Park and you use the touchscreen to release the parking brake (**Controls > Safety > Parking Brake**), Model X shifts into Neutral (see [Parking Brake on page 69](#)).

Drive

Push the drive stalk all the way down and release. You can shift into Drive when Model X is stopped or moving less than 5 mph (8 km/h) in Reverse.

Park

Press the end of the drive stalk while Model X is stopped.



Model X automatically shifts into Park whenever you connect a charge cable or if two or more of the following conditions are met simultaneously while traveling slower than approximately 1.5 mph (2 km/h):

- The driver's seat belt is unbuckled.
- The occupancy sensor in the driver's seat does not detect an occupant.
- The driver's door is opened.

To make it convenient to pick up passengers, you can also unlock all doors at any time by shifting into Park then pressing the Park button a second time.

NOTE: You must press the brake pedal to shift *out of* Park.

NOTE: The above conditions do not reflect a comprehensive list of reasons why Model X may or may not automatically shift into Park and, in certain scenarios, it is possible for your vehicle to shift into Park when only one of the above conditions is true.



WARNING: In emergency situations, if the brakes are not functioning properly, press and hold the Park button on the drive stalk to bring the vehicle to a stop. Do not use this method to stop the vehicle unless absolutely necessary.



WARNING: It is the driver's responsibility to always ensure the vehicle is in Park before exiting. Never rely on Model X to automatically shift into Park for you; it might not work in all circumstances (for example, if Creep or a slope causes the vehicle to travel greater than approximately 1.5 mph (2 km/h)).

Controlling Lights

Touch **Controls** > **Lights** to control the lights.

In addition to the lights that you can control from the touchscreen, Model X has convenience lights that turn on and off automatically based on what you are doing. For example, interior lights, marker lights, tail lights, and puddle lights turn on when you unlock Model X, when you open a door, and when you shift into Park. They turn off automatically after a minute or two or when you shift or lock Model X. Use these settings to control exterior and interior lights:

Exterior Lights

Exterior lights (headlights, tail lights, side marker lights, parking lights, and license plate lights) are set to **AUTO** each time you start Model X. When set to **AUTO**, exterior lights automatically turn on when driving in low lighting conditions. If you change to a different setting, lights always revert to **AUTO** on your next drive.

Touch one of these options to change the exterior light setting:

- **OFF:** Exterior lights turn off until you manually turn them back on or until the next time you drive. If daytime running lights are required in your region, the exterior lights used for this purpose are always on when Drive is engaged.

- **PARKING:** Only the side marker lights, parking lights, tail lights and license plate lights turn on.

NOTE: If daytime running lights are required in your region, the exterior lights used for this purpose are always on whenever Drive or Reverse is engaged.

- **ON:** Exterior lights turn on.

 **CAUTION:** Ensure the headlights and rear lights are on during low visibility conditions (for example, when it is dark, foggy, snowy, or the road is wet, etc.). The rear tail lights are off while daytime running lights are on. Failure to do so can cause damage or serious injury.

NOTE: To comply with local traffic regulations when crossing from a left-hand traffic region to a right-hand traffic region, and vice versa, headlights should be adjusted. If you plan to drive to a region that requires headlights to be adjusted, schedule a service appointment using the mobile app.

Fog Lights

If equipped, touch to turn the fog lights on or off. Fog lights operate only when low beam headlights are on. When headlights are turned off, fog lights also turn off.



The front fog indicator displays on the instrument panel whenever the optional front fog lights are on.

NOTE: Depending on the market region and vehicle options, your vehicle may not be equipped with front and/or rear fog lights.

NOTE: In some regions, there is no control for the front fog lights. They operate in conjunction with the headlights and turn on only in situations where low beam headlights are on.

Interior Lights

Turn the interior dome (map) lights on or off. If set to **AUTO**, all interior dome lights turn on when you unlock Model X, open a door upon exiting, or shift into Park.

NOTE: You can also manually turn an individual dome light on or off by pressing its lens. If you turn a dome light on, it turns off when Model X powers off. If Model X was already powered off when you manually turned the light on, it turns off after 60 minutes.

Ambient Lights

When enabled, interior ambient lights turn on whenever the headlights are on.

Auto High Beam

If you turn on **Auto High Beam**, headlights automatically switch from high beam headlights to low beam headlights when light is detected in front of Model X. See [High Beam Headlights on page 57](#).

Headlights after Exit

If you turn on **Headlights after Exit**, the exterior lights remain on for one minute after you stop driving and park Model X in low lighting conditions. See [Headlights After Exit on page 58](#).

High Beam Headlights

Push the turn signal stalk away from you to turn the high beam headlights on continuously. To cancel, pull the stalk towards you.

To briefly flash the high beam headlights, pull the stalk towards you.



Lights



The high beam headlights can automatically switch to low beam when there is light detected in front of Model X (for example, from an oncoming vehicle). To turn this feature on or off, touch **Controls > Lights > Auto High Beam** or **Controls > Lights > Auto High Beam**.

NOTE: Your chosen setting is retained until you manually change it.

NOTE: Auto High Beam is available only on vehicles equipped with Autopilot components.

In situations where high beams are turned off because **Auto High Beam** is turned on and light is detected in front of Model X, you can temporarily turn on high beams by pulling the stalk all the way toward you.

The following indicator lights are visible on the instrument panel to show the status of the headlights:

Low beam headlights are on.



High beam headlights are on. Illuminates when high beams are on but the **Auto High Beam** setting is turned off or if the **Auto High Beam** setting is turned on but is temporarily unavailable.



High beams are currently turned on, and **Auto High Beam** is ready to turn off the high beams if light is detected in front of Model X.



High beams are temporarily turned off because **Auto High Beam** is operating and light is detected in front of Model X. When light is no longer detected, high beam headlights automatically turn back on.



WARNING: **Auto High Beam** is a convenience only and is subject to limitations. It is the driver's responsibility to make sure that headlights are always appropriately adjusted for weather conditions and driving circumstances.

Headlights After Exit

When you stop driving and park Model X in low lighting conditions, exterior lights temporarily remain illuminated. They automatically turn off after one minute or when you lock Model X whichever comes first.

To turn this feature on and off, touch **Controls > Lights > Headlights After Exit**. When **Headlights After Exit** is off, the headlights turn off immediately when you engage Park and open a door.

Adaptive Front Lighting System (AFS)

If equipped, the Adaptive Front Lighting System (AFS) automatically adjusts the beam of the headlights to improve your driving view. Electric sensors measure driving speed, steering angle and yaw (the rotation of the car around the vertical axis) to determine the optimum position of the headlights based on current driving conditions. For example, to improve visibility while driving on winding roads at night, the AFS casts the beam in the direction of the curve. When low beam headlights are turned on and when driving at lower speeds, AFS improves lateral illumination to increase the visibility of pedestrians and curbs, and to improve visibility when turning at a dark intersection, into a driveway, or when making a u-turn.

The Adaptive Front Lighting System (AFS) operates whenever headlights are on. If Model X isn't moving, or is moving in reverse, the adaptive headlights do not activate. This prevents the headlights from inadvertently blinding other drivers.



If the AFS fails, the instrument panel displays an alert. Contact Tesla Service.

Turn Signals

Move the turn signal stalk up (before turning right) or down (before turning left). The turn signals flash three times or continuously, depending on how far up or down you move the stalk. Lightly push the stalk up or down for a three-flash sequence. For a continuous signal, push the stalk fully up or down.

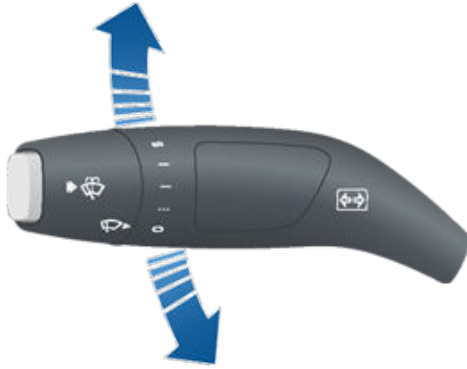

The turn signals stop operating when canceled by the steering wheel, or when you return the stalk to the central position.



When a turn signal is operating, the corresponding turn signal indicator lights up on the instrument panel and a clicking sound can be heard.



⚠ WARNING: When actively using Traffic-Aware Cruise Control (if equipped), engaging a turn signal can cause Model X to accelerate in specific situations (see [Overtake Acceleration on page 99](#)).

⚠ WARNING: When actively using Autosteer (if equipped), engaging a turn signal can cause Model X to change lanes (see [Auto Lane Change on page 103](#)).

Hazard Warning Flashers

To turn on the hazard warning flashers, press the button located on the side of the touchscreen closest to the steering wheel. All turn signals flash. Press again to turn off.

NOTE: Hazard warning flashers operate even without a key nearby.



Instrument Panel Overview

The instrument panel changes depending on whether Model X is:

- Off (shown below).
- Driving (see [Instrument Panel - Driving on page 64](#)).
- Charging (see [Charging Status on page 177](#)).

When Model X is off, the instrument panel shows remaining estimated range, status of doors, and outside temperature. When you press the brake, indicator lights flash on briefly along the top. Unless an indicator light applies to a current situation, it should turn off. If an indicator light fails to turn on or off, contact Tesla.

NOTE: The following illustration is provided for demonstration purposes only. Depending on vehicle options, software version, and market region, the information displayed may be slightly different.



The following indicators illuminate on the instrument panel to advise you or alert you of a specific condition.



A brake system fault is detected or the brake fluid level is low. See [Braking and Stopping on page 67](#). Contact Tesla immediately.



A brake booster fault has been detected. See [Braking and Stopping on page 67](#).



An ABS (Anti-lock Braking System) fault is detected. See [Braking and Stopping on page 67](#). Contact Tesla immediately.



The parking brake is manually applied. See [Parking Brake on page 69](#).



A parking brake fault is detected. Contact Tesla. See [Parking Brake on page 69](#).



Low beam headlights are on.



High beam headlights are on. Illuminates when high beams are on but the Auto High Beam setting if equipped is turned off or if the Auto High Beam setting is turned on but is temporarily unavailable. See [High Beam Headlights on page 57](#).



High beam headlights are currently turned on, and Auto High Beam if equipped is ready to turn off the high beams if light is detected in front of Model X. See [High Beam Headlights on page 57](#).



High beam headlights are temporarily turned off because Auto High Beam if equipped is on and is detecting light in front of Model X. When light is no longer detected, the high beams automatically turn back on. See [High Beam Headlights on page 57](#).



Parking lights (side marker lights, tail lights, and license plate lights) are on. See [Lights on page 57](#).



Front fog lights, if equipped. See [Lights on page 57](#).



Adaptive Front Lighting, if equipped. See [Adaptive Front Lighting System \(AFS\) on page 58](#).



Electronic stability control systems are actively minimizing wheel spin by controlling brake pressure and motor power (indicator flashes amber). See [Traction Control on page 70](#). If this indicator remains on, a fault is detected and you should immediately contact Tesla.



If a fault is detected that reduces the performance of the air suspension system, this amber indicator light displays (see [Air Suspension on page 157](#)). If the problem persists, contact Tesla.



If a fault is detected that disables the air suspension system, a red indicator lights up on the instrument panel (see [Air Suspension on page 157](#)). Contact Tesla.



Instrument Panel



Airbag safety. If this red indicator does not flash on briefly when Model X prepares to drive, or if it remains on, contact Tesla immediately. See [Airbags on page 42](#).



Vehicle Hold is actively applying the brakes. See [Vehicle Hold on page 73](#).



Tire pressure warning. The pressure of a tire is out of range. If a fault with the Tire Pressure Monitoring System (TPMS) is detected, the indicator flashes. For a TPMS fault, contact Tesla. See [Tire Care and Maintenance on page 184](#).



A door or trunk is open. See [Keys and Doors on page 8](#), [Rear Trunk on page 17](#), or [Front Trunk on page 19](#).



A seat belt for an occupied seat is not fastened. See [Seat Belts on page 31](#).



Electronic stability control systems are no longer minimizing wheel spin. On a Rear Wheel Drive vehicle, the traction control system has been turned off, or on an All-Wheel Drive vehicle, Slip Start has been enabled. See [Traction Control on page 70](#).



Model X is in Transport mode and can roll freely. It does not automatically shift into Park when you exit. See [Instructions for Transporters on page 215](#).



Trailer mode (if equipped) is active. See [Towing and Accessories on page 82](#).



Appears when some of the energy stored in the Battery may not be available due to cold weather conditions. During these cold weather conditions, charging rates may also be limited. If Model X is plugged in, you can heat your Battery by turning on climate control with the mobile app. The snowflake icon disappears when the Battery is sufficiently warm.



Vehicle power is currently being limited because the energy remaining in the Battery is low or the vehicle's systems are being heated or cooled.



Flashes green when the left turn signal is operating. Both turn signal indicators flash green when the hazard warning flashers are operating.



Flashes green when the right turn signal is operating. Both turn signal indicators flash green when the hazard warning flashers are operating.



Instrument Panel

Instrument Panel - Driving

When Model X is driving (or ready to drive), the instrument panel shows your current driving status and a real-time visualization of the road as detected by the Autopilot components (see [About Autopilot on page 93](#)). The visualization automatically zooms in and out as needed to inform you when a vehicle is detected in your blind spot.

NOTE: The following illustration is provided for demonstration purposes only. Depending on vehicle options, software version, and market region, the information displayed may be slightly different.

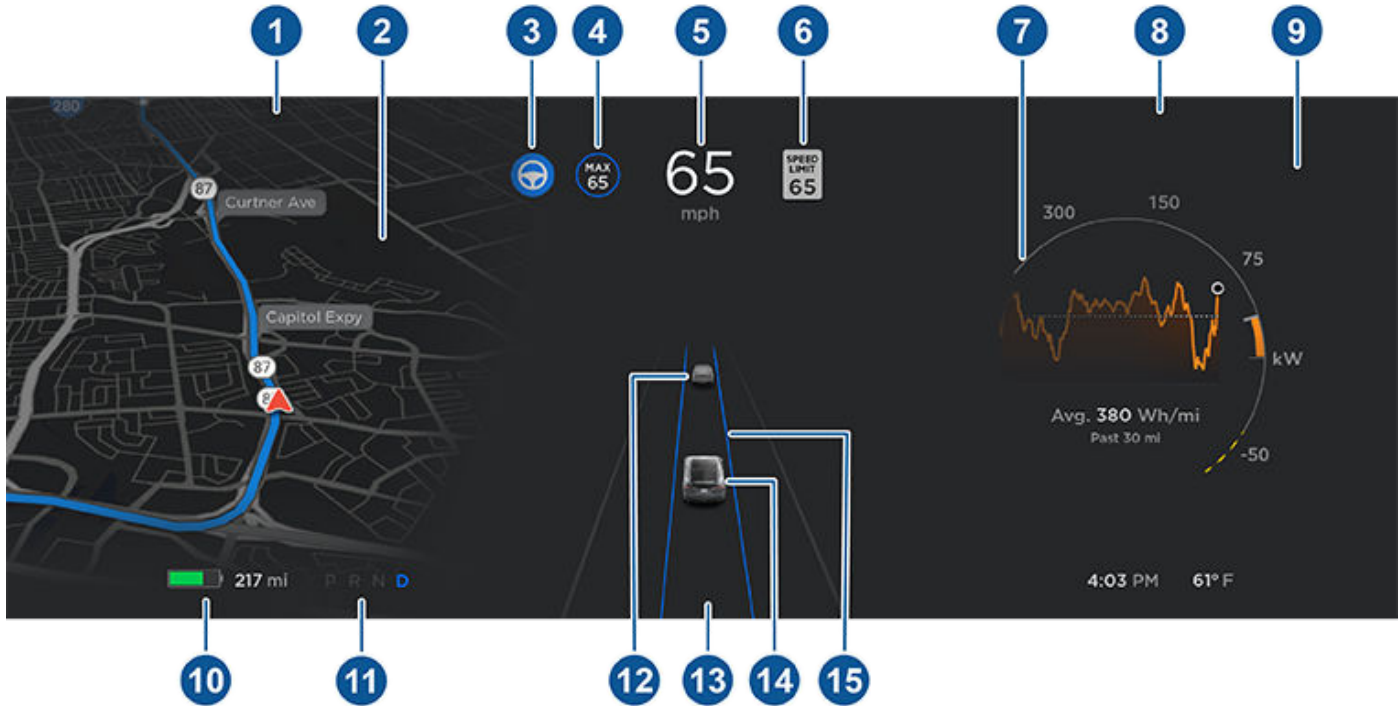

NOTE: Touch **Controls > Autopilot > Full Self-Driving Visualization Preview** (if equipped) to display more details about the roadway and its surroundings, such as road markings, stop lights, objects (such as trash cans and poles), etc.

1. Indicator lights display along the top to provide status (see [Instrument Panel Overview on page 60](#)).
2. When you are actively navigating to a destination, navigation instructions display here. Use the left steering wheel buttons to change what displays on the left side of the instrument panel whenever navigation instructions are not displayed (see [Using Left Steering Wheel Buttons on page 50](#)).
3. Autosteer is actively steering Model X. When Autosteer is available but you haven't activated it, the icon is gray (see [Autosteer on page 101](#)).
4. Traffic-Aware Cruise Control is cruising at a set speed. When Traffic-Aware Cruise Control is available but you haven't set a cruising speed, the icon is gray and the speed is not shown (see [Traffic-Aware Cruise Control on page 96](#)).
5. Driving speed.
6. The speed limit (if available) that is currently being detected by Speed Assist (see [Speed Assist on page 130](#)).
7. On the Energy graph, dashed lines appear on the power meter if Model X is limiting power. The dashed lines appear on the top portion (energy being used) when power available for acceleration is being limited, and on the bottom portion (energy being gained) when power that can be gained by regenerative braking is limited. Model X limits power for many reasons. Here are just a few examples:
 - Acceleration may be limited when the Battery is reaching a low state of charge or if the powertrain is hot.
 - Both acceleration and regenerative braking may be limited when the ambient temperature is either very high or very low.
 - Regenerative braking may be limited when the Battery is fully charged.



NOTE: Use the right steering wheel buttons to control what displays on the right side of the instrument panel (see [Using Right Steering Wheel Buttons on page 51](#)).

8. Pay attention to important alert messages that display here. If any alerts are in effect, you can view information about them by touching the alert icon (exclamation mark) on the touchscreen's status bar (the topmost area of the touchscreen).
9. Use the right steering wheel buttons to change what displays on the right side of the instrument panel whenever a phone call is not active (see [Using Right Steering Wheel Buttons on page 51](#)).
10. Total estimated driving distance (or energy) available. Instead of driving distance, you can display the percentage of battery energy remaining. To do so, touch **Controls** > **Display** > **Energy Display**.

NOTE: When anticipating when you need to charge, use range estimates as a general guideline only.

11. Currently selected drive mode: Park, Reverse, Neutral, or Drive.
12. The car in front of you (if applicable).
13. Pay attention to important driving-related messages that appear at the bottom center of the instrument panel.
14. Your Model X.
15. When Autosteer is active and detects the driving lane, it is highlighted in blue (see [Autosteer on page 101](#)). Depending on the current driving scenario, you may see neighboring lanes.

NOTE: If Navigate on Autopilot is active, the driving lane displays as a single blue line in front of Model X (see [Navigate on Autopilot on page 106](#)).



WARNING: Although the instrument panel shows surrounding traffic, some vehicles may not be displayed. Never rely on the instrument panel to determine if a vehicle is present (for example, in your blind spot). Always use your mirrors and perform shoulder checks.

Wipers

To wipe the windshield, rotate the end of the turn signal stalk away from you. You can rotate to five positions:

- 1st: Off.
- 2nd: Auto with low rain sensitivity.*
- 3rd: Auto with high rain sensitivity.*
- 4th: Continuous, slow.
- 5th: Continuous, fast.



For a single wipe, press and release the end of the stalk.

If the wipers are set to Auto and Model X detects no liquid on the windshield, the wipers do not wipe.

*To enable the **Auto** settings, touch **Controls > Vehicle > Autowipers (Beta)**. When wipers are set to Auto, Model X detects whether or not it is raining. The frequency at which they wipe depends on how much rain is detected on the windshield. When wipers are set to high rain sensitivity, the wipers turn on when Model X detects a light mist.

NOTE: The Auto setting is currently in BETA. If uncertain about using the Auto setting while in the BETA phase, Tesla recommends operating the wipers manually, as necessary.

NOTE: You can also adjust the windshield wiper speed and frequency using voice commands (see [Voice Commands on page 159](#)).

CAUTION: Ensure the wipers are in the Off position before washing Model X to avoid the risk of damaging the wipers.

To extend the life of wiper blades, remove ice from the windshield before turning wipers on. Ice has sharp edges that can damage the rubber on the wiper blades.

Periodically check and clean the edge of the wiper blade. If damaged, replace the wiper blade immediately. For details on checking and replacing wiper blades, see [Wiper Blades and Washer Jets on page 193](#).

CAUTION: In harsh climates, ensure that the wiper blades are not frozen or adhered to the windshield.

Defrosting Wipers

To make wiper blades easy to access so you can remove any ice and snow, shift Model X into Park, turn the wipers off, then use the touchscreen to move them to the service position. Touch **Controls > Service > Wiper Service Mode**. When parking in cold outdoor climates, it is helpful to leave Model X with the wipers in the service position. In this position, they are closer to the defrost vent, allowing you to thaw them by directing air from the climate control system towards the windshield.

If Model X is equipped with the optional cold weather package, you can defrost wipers by touching the climate control on the touchscreen (see [Climate Controls on page 138](#)). Wiper defrosters automatically turn off after 15 minutes.

NOTE: Wipers automatically return to their normal position when you shift Model X out of Park.

Washers

Press the button on the end of the turn signal stalk to spray washer fluid onto the windshield. You can press this button at two levels. Press partially for a single wipe, without any washer fluid. Press fully for both wipe and wash. When washing the windshield, the wipers turn on. After releasing the button, the wipers perform two additional wipes then, depending on vehicle and environmental conditions, a third wipe a few seconds later.



Periodically top up washer fluid (see [Topping Up Windshield Washer Fluid on page 195](#)).



Braking Systems

WARNING: Properly functioning braking systems are critical to ensure safety. If you experience a problem with the brake pedal, brake calipers, or any component of a Model X braking system, contact Tesla immediately.

Model X has an anti-lock braking system (ABS) that prevents the wheels from locking when you apply maximum brake pressure. This improves steering control during heavy braking in most road conditions.

During emergency braking conditions, the ABS constantly monitors the speed of each wheel and varies the brake pressure according to the grip available.

The alteration of brake pressure can be felt as a pulsing sensation through the brake pedal. This demonstrates that the ABS is operating and is not a cause for concern. Keep firm and steady pressure on the brake pedal while experiencing the pulsing.



The ABS indicator briefly flashes yellow on the instrument panel when you first start Model X. If this indicator lights up at any other time, an ABS fault has occurred and the ABS is not operating. Contact Tesla. The braking system remains fully operational and is not affected by an ABS failure. However, braking distances may increase. Drive cautiously and avoid heavy braking.



If the instrument panel displays this red brake indicator at any time other than briefly when you first start Model X, a brake system fault is detected, or the level of the brake fluid is low. Contact Tesla immediately. Apply steady pressure and keep the brakes firm to bring the vehicle to a stop when safe to do so.



The instrument panel displays this yellow brake indicator if a brake booster fault is detected. Apply steady pressure and keep the brakes firm to stop the vehicle when safety permits. Hydraulic Boost Compensation will be active (see [Hydraulic Boost Compensation](#) on page 68).

Emergency Braking

In an emergency, fully press the brake pedal and maintain firm pressure, even on low traction surfaces. The ABS varies the braking pressure to each wheel according to the amount of traction available. This prevents wheels from locking and ensures that you stop as safely as possible.

WARNING: Do not pump the brake pedal. Doing so interrupts operation of the ABS and can increase braking distance.

WARNING: Always maintain a safe distance from the vehicle in front of you and be aware of hazardous driving conditions. While the ABS can improve stopping distance, it cannot overcome the laws of physics. It also does not prevent the danger of hydroplaning (where a layer of water prevents direct contact between the tires and the road).

CAUTION: Automatic Emergency Braking (see [Automatic Emergency Braking](#) on page 128) may intervene to automatically brake in situations where a collision is considered imminent. Automatic Emergency Braking is not designed to prevent a collision. At best, it can minimize the impact of a frontal collision by attempting to reduce your driving speed. Depending on Automatic Emergency Braking to avoid a collision can result in serious injury or death.

CAUTION: In emergency situations, if the brakes are not functioning properly, press and hold the Park button on the drive stalk to bring the vehicle to a stop. Do not use this method to stop the vehicle unless absolutely necessary.

Dynamic Brake Lights (if equipped)

If you are driving over 30 mph (50 km/h) and brake forcefully (or if Automatic Emergency Braking engages), the brake lights flash quickly to warn other drivers that Model X is rapidly slowing down. If Model X stops completely, the hazard warning lights flash. Flashing continues until you press the accelerator or manually press the hazard lights button to turn them off (see [Hazard Warning Flashers](#) on page 59).

NOTE: When towing a trailer (if applicable), the brake lights on the trailer also operate as described above, even when the trailer is not equipped with a separate braking system.

WARNING: When towing a trailer (if applicable), always increase your following distance. Sudden braking may result in skidding, jack-knifing, and loss of control.

Brake Disc Wiping

To ensure brakes remain responsive in cold and wet weather, Model X is equipped with brake disc wiping. When cold and wet weather is detected, this feature repeatedly applies an imperceptible amount of brake force to remove water from the surface of the brake discs.



Braking and Stopping

Hydraulic Fade Compensation

Model X is equipped with hydraulic fade compensation. This assists in monitoring brake system pressure and ABS activity for instances of reduced brake performance. If reduced brake performance is detected (for example, as a result of brake fade, or cold or wet conditions), you may hear a sound, feel the brake pedal pull away from your foot, and notice a strong increase in braking. Brake as you normally would and continue to press the brake pedal without releasing or pumping the brakes.

CAUTION: If brakes are not functioning properly, stop the vehicle when safety permits and contact Tesla Service. See [Park on page 56](#) for information on using the Park button to stop the vehicle in case of emergency.

WARNING: Always maintain a safe driving distance from the vehicle in front of you and exercise caution when driving conditions are hazardous. Brake disc wiping and hydraulic fade compensation is not a substitute for adequately applying the brakes.

Hydraulic Boost Compensation

Model X is equipped with a brake booster that activates the brakes when the brake pedal is pressed. Hydraulic boost compensation provides mechanical assistance if the brake booster fails. If a brake booster failure is detected, the brake pedal feels stiffer to press and you may hear a sound when you press the brake pedal. To stop Model X, apply steady force to the brake pedal without releasing or pumping. Drive cautiously and maintain a safe distance from other road users—brake pedal responsiveness and braking performance may be degraded.

Regenerative Braking

Whenever Model X is moving and your foot is off the accelerator, regenerative braking slows down Model X and feeds any surplus energy back to the Battery.

By anticipating your stops and reducing or removing pressure from the accelerator pedal to slow down, you can take advantage of regenerative braking to increase driving range. Of course, this is no substitute for regular braking when needed for safety.

WARNING: In snowy or icy conditions Model X may experience traction loss during regenerative braking, particularly when in the **Standard** setting and/or not using winter tires. Tesla recommends using the **Low** setting (see [To Set the Regenerative Braking Level on page 68](#)) in snowy or icy conditions to help maintain vehicle stability.

The Energy app displays real-time feedback on the amount of energy being gained by regenerative braking. You can also display the power meter on either side of the instrument panel by choosing **Energy** using the scroll button on the steering wheel (see [Steering Wheel on page 50](#)).

The amount of energy fed back to the Battery using regenerative braking can depend on the current state of the Battery. For example, regenerative braking may be limited if the Battery is already fully charged or if the ambient temperature is too cold.

NOTE: If regenerative braking is limited, a dashed yellow line displays on the power meter.



To Set the Regenerative Braking Level

NOTE: The regenerative braking setting is not available on all vehicles.

You can use the touchscreen to change the level of regenerative braking:

1. Touch **Controls > Pedals & Steering > Regenerative Braking**.
2. Choose from two levels:
 - **Standard:** Provides the maximum amount of regenerative braking. When you release the accelerator, Model X slows down, reducing the need to use the brakes.
 - **Low:** Limits regenerative braking. When you release the accelerator, Model X takes longer to slow down and coasts further than if set to "Standard".



Parking Brake

To engage the parking brake, touch **Controls > Safety > Parking Brake**. Follow the onscreen instructions. You can also engage the parking brake by pressing and holding the button on the end of the drive stalk while in Park.



Use the touchscreen to manually release the parking brake (which also shifts Model X into Neutral):

1. Touch **Controls > Safety**.
2. Press the brake pedal, then touch **Parking Brake**. If Model X was previously in Park, it shifts into Neutral.





When you manually apply the parking brake using the touchscreen, or by pressing and holding the button on the end of the drive stalk when in Park, the red parking brake indicator lights up on the instrument panel.



If the parking brake experiences an electrical issue, the amber parking brake indicator lights up and a fault message displays on the instrument panel.

NOTE: The parking brake operates on the rear wheels only, and is independent of the pedal-operated brake system.

-  **CAUTION:** In the unlikely event that Model X loses electrical power, you cannot access the touchscreen and are therefore unable to release the parking brake. Contact Tesla.
-  **WARNING:** In snowy or icy conditions the rear wheels may not have sufficient traction to prevent Model X from sliding down a slope, particularly if not using winter tires. Avoid parking on hills in snowy or icy conditions. You are always responsible for parking safely.
-  **WARNING:** Your Model X may display an alert if the road is too steep to safely park on, or if the parking brakes are not properly engaged. These alerts are for guidance purposes only and are not a substitute for the driver's judgment of safe parking conditions, including specific road or weather conditions. Do not depend on these alerts to determine whether or not it is safe to park at any location. You are always responsible for parking safely.

Brake Wear

Model X brake pads are equipped with wear indicators. A wear indicator is a thin metal strip attached to the brake pad that squeals as it rubs against the rotor when the pad wears down. This squealing sound indicates that the brake pads have reached the end of their service life and require replacement. To replace the brake pads, contact Tesla Service.

Brakes must be periodically inspected visually by removing the tire and wheel. For detailed specifications and service limits for rotors and brake pads, see [Subsystems on page 205](#). Additionally, Tesla recommends cleaning and lubricating the brake calipers every year or 12,500 miles (20,000 km) if in an area where roads are salted during winter months.

 **WARNING:** Neglecting to replace worn brake pads damages the braking system and can result in a braking hazard.



Traction Control

How It Works

The traction control system constantly monitors the speed of the front and rear wheels. If Model X experiences a loss of traction, the system minimizes wheel spin by controlling brake pressure and motor power. By default, the traction control system is on. Under normal conditions, it should remain on to ensure maximum safety.



This yellow indicator flashes on the instrument panel whenever the traction control system is actively controlling brake pressure and motor power to minimize wheel spin. If the indicator stays on, a fault is detected with the traction control system. Contact Tesla Service.

⚠ WARNING: Traction control cannot prevent collisions caused by driving dangerously or turning too sharply at high speeds.

Allowing Wheel Slip

To allow the wheels to spin at a limited speed, you can enable Slip Start. Slip Start can be enabled only when Model X is moving 30 mph (48 km/h) or slower. Slip Start automatically disables when the speed exceeds 50 mph (80 km/h).

Under normal conditions, Slip Start should not be enabled. Enable it only in circumstances where you deliberately want the wheels to spin, such as:

- Starting on a loose surface, such as gravel or snow.
- Driving in deep snow, sand or mud.
- Rocking out of a hole or deep rut.

To allow the wheels to spin, touch **Controls > Pedals & Steering > Slip Start**.



The instrument panel displays an alert message when Slip Start is enabled.

Although Slip Start is automatically disabled the next time you start Model X, it is strongly recommended that you disable it immediately after the circumstances that required you to enable it have passed.

NOTE: Slip Start can not be enabled when you are actively using cruise control.

How Park Assist Works

Model X has several sensors designed to detect the presence of objects. When driving slowly in Drive or Reverse (for example, when parking), the vehicle alerts you if an object is detected in close proximity of your Model X. Objects are only detected in your chosen direction; front objects in Drive, rear objects in Reverse.

⚠ WARNING: You may not be alerted if Model X rolls freely in the opposite direction (for example, Park Assist does not display an alert if Model X rolls backwards down a hill while in Drive).

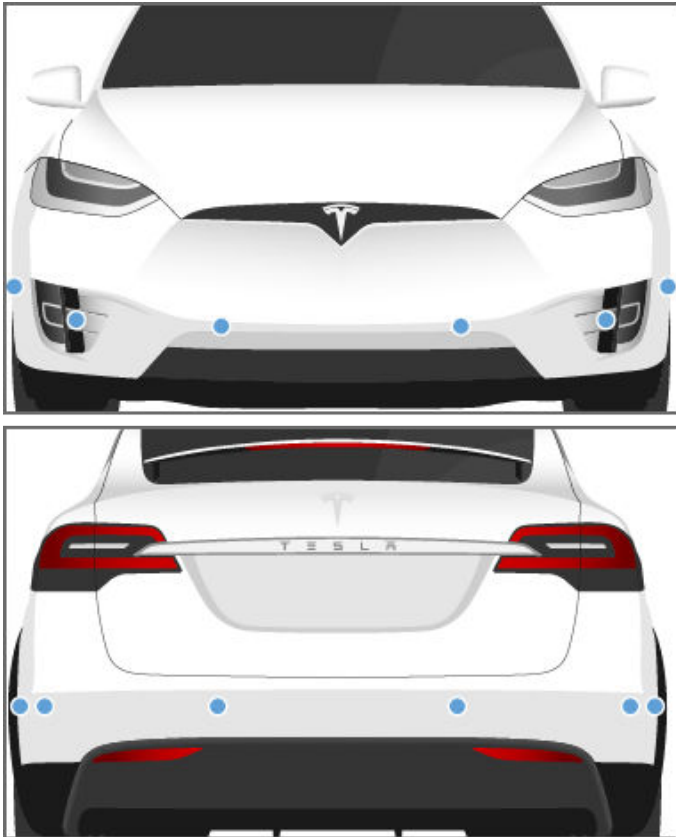

The sensors are activated when driving slower than 5 mph (8 km/h).

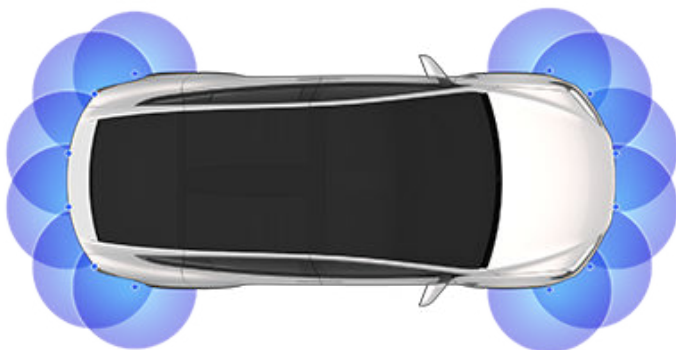

NOTE: Rear sensors are disabled when a bicycle is detected or Model X is in trailer mode.

⚠ WARNING: Never depend on Park Assist to inform you if an area you are approaching is free of objects and/or people. Several external factors can reduce the performance of Park Assist, causing either no readings or false readings (see [Limitations and False Warnings on page 72](#)). Therefore, depending on Park Assist to determine if Model X is approaching an obstruction can result in damage to the vehicle and/or objects, and can potentially cause serious injury. Always inspect the area with your own eyes. When reversing, perform shoulder checks and use all mirrors. Park assist does not detect children, pedestrians, bicyclists, animals, or objects that are moving, protruding, located too far above or below the sensors, or too close or too far from the sensors. Park Assist is for guidance purposes only and is not intended to replace your own direct visual checks. It is not a substitute for careful driving.

Visual and Audio Feedback

When you shift to Reverse, the Park Assist view displays on the left side of the instrument panel, showing objects that are in close proximity to the front and rear of Model X. This view closes when you shift into Drive unless an object is detected close to the front of Model X, in which case the Park Assist view closes automatically when your driving speed exceeds 5 mph (8 km/h). When reversing, visual feedback also displays on the touchscreen (see [Rear Facing Camera\(s\) on page 79](#)). You can manually close the park assist view on the touchscreen by touching the **X**.

When driving with the Camera app displayed on the touchscreen, you can switch to the Park Assist view when driving at speeds below 5 mph (8 km/h). Touch the button located in the upper left corner of the Camera app screen. This is useful if you need assistance with parallel parking.

If chimes are turned on (see [Controlling Audible Feedback on page 71](#)), an audible beep sounds as you approach an object. You can temporarily mute the chime by touching the speaker icon on the bottom corner of the Park Assist view.

NOTE: If a sensor is unable to provide feedback, the instrument panel displays an alert message.

⚠ CAUTION: Keep sensors clean from dirt, debris, snow, and ice. Avoid using a high pressure power washer on the sensors and do not clean a sensor with a sharp or abrasive object that can scratch or damage its surface.

⚠ CAUTION: Do not install accessories or stickers on or near the parking sensors.

Controlling Audible Feedback

You can use Park Assist with or without audible feedback. To turn chimes on or off, touch **Controls > Safety > Park Assist Chimes**.

To mute the chimes temporarily, touch the speaker icon in the bottom corner of the Park Assist view. The chimes are muted until you shift or drive over 5 mph (8 km/h).

Limitations and False Warnings

The parking sensors may not function correctly in these situations:

- One or more of the ultrasonic sensors is damaged, dirty, or obstructed (such as by mud, ice, or snow, or by a vehicle bra, excessive paint, or adhesive products such as wraps, stickers, rubber coating, etc.).
- The object is located below approximately 8 inches (20 cm) (such as a curb or low barrier).



CAUTION: Shorter objects that are detected (such as curbs or low barriers) can move into the blind spot of the sensors. Model X cannot alert you about an object while it is in the blind spot of the sensors.

- Weather conditions (heavy rain, snow, or fog) are interfering with sensor operation.
- The object is thin (such as a sign post).
- A sensor's operating range has been exceeded.
- The object is sound-absorbing or soft (such as powder snow).
- The object is sloped (such as a sloped embankment).
- Model X has been parked in, or being driven in, extremely hot or cold temperatures.
- The sensors are affected by other electrical equipment or devices that generate ultrasonic waves.
- You are driving in a location where the sensors' ultrasonic waves are deflected away from the vehicle (such as driving next to a wall or pillar).
- The object is located too close to the bumper.
- A bumper is misaligned or damaged.
- An object that is mounted to Model X is interfering with and/or obstructing the sensor (such as a bike rack or bumper sticker).
- Model X rolls freely in the opposite direction you selected (for example, Park Assist does not display an alert if Model X rolls backwards down a hill while in Drive).

Other Parking Aids

In addition to Park Assist, when shifted into Reverse, the backup camera displays a view of the area behind Model X (see [Rear Facing Camera\(s\) on page 79](#)).



When Model X is stopped, Vehicle Hold can continue to apply the brakes even after you remove your foot from the brake pedal. When driving on a hill or on a flat surface, brake as you normally would. After coming to a complete stop, simply press the brake pedal again (until the instrument panel displays the Vehicle Hold indicator light) to enable Vehicle Hold. You can then release the brake pedal and remain stopped, even on a hill.



This indicator displays on the instrument panel whenever Vehicle Hold is actively braking Model X.

To disengage Vehicle Hold, press the accelerator pedal or press and release the brake pedal.

NOTE: Shifting into Neutral also disengages Vehicle Hold.

NOTE: After actively braking Model X for approximately ten minutes, Model X shifts into Park and Vehicle Hold cancels. Model X also shifts into Park if it detects that the driver has left the vehicle.

NOTE: When Stopping Mode is set to Hold, Vehicle Hold engages automatically whenever Model X stops while in Drive or Reverse. There is no need to press the brake to engage it.



Acceleration Modes

The acceleration settings available on your Model X vary depending on options chosen at time of purchase:

- **Chill:** limits acceleration for a smooth and gentle ride (available on all vehicles equipped with Autopilot hardware).
- **Standard:** provides the normal level of acceleration (available on non-Performance All-Wheel Drive vehicles).
- **Sport:** provides the normal level of acceleration (available on Performance All-Wheel Drive vehicles).
- **Insane:** increases peak torque by approximately 30 percent (available on Performance All-Wheel Drive vehicles not equipped with the Ludicrous upgrade).
- **Ludicrous:** increases peak torque by approximately 60 percent (available on Performance All-Wheel Drive vehicles equipped with the Ludicrous upgrade).
- **Insane+:** increases peak torque by approximately 30 percent (available on Performance All-Wheel Drive vehicles not equipped with the Ludicrous upgrade) while also heating up the Battery to its ideal operating temperature to ensure access to 100% of available power. Before choosing this setting, read about [Using Insane+ or Ludicrous+ on page 74](#).
- **Ludicrous+:** increases peak torque by approximately 60 percent (available on Performance All-Wheel Drive vehicles equipped with the Ludicrous upgrade) while also immediately heating up the Battery to its ideal operating temperature to ensure access to 100% of available power. Before choosing this setting, read about [Using Insane+ or Ludicrous+ on page 74](#).

NOTE: Although Chill does not directly improve driving range, using the increased torque and power available in Insane or Ludicrous mode can reduce range and efficiency.

NOTE: When Chill is selected, Chill displays on the instrument panel above the driving speed.

In addition, a Performance All-Wheel Drive Model X also features Launch Mode to provide optimum acceleration on surfaces with good traction. For the specific driving instructions required to use Launch Mode, see [Launch Mode on page 74](#).

To choose an acceleration mode, touch **Controls** > **Driving** > **Acceleration**.

Using Insane+ or Ludicrous+

If you choose Insane or Ludicrous, additional power is available immediately. However, to achieve the absolute maximum power (designed for short term use), you can choose **Insane+** or **Ludicrous+** to heat the Battery to its ideal operating temperature. This ensure access to 100% of available power.

While the battery is being heated, the touchscreen displays a status message providing you with an approximate wait time, and letting you know when the additional power is available. In addition to heating the Battery, **Insane+** and **Ludicrous+** modes strive to keep the Battery within an optimal temperature range. Therefore, under aggressive driving scenarios, you may also see the “Cooling” status for several minutes until temperatures fall. Model X stays in the chosen mode for three hours, even if you leave the vehicle. After three hours, the feature times out.

NOTE: Insane+ and Ludicrous+ are designed to achieve maximum performance for short term acceleration. These settings are not intended for daily driving. The tradeoff for the additional power boost is extra energy consumption and earlier power fade on long drives. The Insane or Ludicrous acceleration settings provide a significant increase in performance even without choosing the Insane+ or Ludicrous+ setting to achieve maximum Battery power. In fact, in normal driving situations, the additional power that can be achieved using Insane+ and Ludicrous+ may be unnoticeable.

NOTE: To support Insane+ or Ludicrous+, the charge level must be 20% or higher. You cannot initiate these settings if the charge level is less than 20%. In addition, these settings immediately cancel if at any time during use, the charge level drops below 20%.

When using Insane+ or Ludicrous+, Model X consumes more energy to keep the Battery within an optimal temperature range.

To cancel Insane+ or Ludicrous+ at any time, change the acceleration level to another setting. To prevent excess and potentially unnecessary energy consumption (for example, you leave the vehicle and forget to cancel Insane+ or Ludicrous+), these settings cancel automatically in three hours, regardless of whether you are still driving or have left the vehicle.

NOTE: Insane+ or Ludicrous+ strives to keep the Battery within an optimal temperature range. In addition to heating the Battery, these settings also cool the battery when necessary (for example, while driving at high speeds, during rapid acceleration, driving for long periods, etc.).

Launch Mode

Launch Mode, available on Performance All-Wheel Drive vehicles only, provides optimum acceleration on surfaces with good traction.

NOTE: Hard acceleration including, but not limited to, using launch mode, increases stress on the vehicle’s powertrain, and can cause premature wear and aging of various components. Model X constantly monitors powertrain fatigue and damage, and notifies you if vehicle components need to be serviced.



⚠ WARNING: Use Launch Mode only in appropriate locations where there is no cross traffic or pedestrians present. Launch Mode is designed for use on closed circuit driving courses. It is the driver's responsibility to ensure that driving style and acceleration do not endanger or inconvenience other road users.

To Activate Launch Mode

1. Ensure the brakes are slightly warm by driving for a few minutes and using the brakes a few times.
2. Set the air suspension to Low or Very Low (see [Air Suspension on page 157](#)).
3. Set the acceleration level to **Insane+** or **Ludicrous+** (if equipped).

NOTE: If equipped with the **Ludicrous+** setting, you can achieve optimum performance by pressing and holding this setting for three seconds.

4. With Model X shifted into Drive and at a complete stop with the steering wheel straight, firmly hold the brake pedal with your left foot, then fully press the accelerator pedal. Within one second, the instrument panel displays a message indicating that Launch Mode is enabled.
5. Within twelve seconds of Launch Mode being enabled, release the brake pedal to launch the vehicle.

When you release the brake, Model X launches forward.

NOTE: Launch Mode is not available if Slip Start has been enabled (which allows the wheels to spin). See [Traction Control on page 70](#).

NOTE: Launch Mode is available only if the ambient temperature is 37° F (3° C) or warmer.



Displaying Trip Information

Trip information displays on the touchscreen when you touch **Controls** > **Trips**. For the current trip, you can display distance, duration and average energy usage. You can also show distance and total and average energy used since your last charge and for additional trips.

To name or rename a trip, touch the trip's name, enter a new name for the trip, then press **Save**. To reset a particular trip meter, touch its associated **Reset** button.

You can display information for up to three trips on the instrument panel. Use the checkboxes to specify the trip(s) you want to display. Then use the scroll bar on the steering wheel to display the chosen trip(s) (see [Using Left Steering Wheel Buttons on page 50](#) or [Using Right Steering Wheel Buttons on page 51](#)).

Odometer

To display the odometer, touch **Controls** > **Software** or open the mobile app.



Factors Affecting Energy Consumption

While driving:

- Elevated driving speed.
- Environmental conditions such as cold or hot weather and wind.
- Using climate controls to heat or cool the cabin.
- Uphill travel: Driving uphill requires more energy and depletes range at a faster rate. However, driving downhill allows your vehicle to regain a portion of its expended energy through regenerative braking (see [Regenerative Braking on page 68](#)).
- Short trips or stop-and-go traffic: It takes energy to bring the cabin and Battery to a specified temperature when starting the vehicle. You may see a higher average consumption when the vehicle is used for very short trips or in heavy traffic.
- Heavy cargo load.
- Windows rolled down.
- Wheels and tires not maintained.
- Customized settings or third-party accessories (roof or trunk racks, third-party wheels).

While parked and not plugged in to a charger:

- Preconditioning the cabin or using climate controls.
- Summon.
- Vehicle infotainment and climate controls system.
- Sentry mode.
- Tesla or third-party mobile app requests.

Tips to Maximize Range

You can maximize your driving range using the same driving habits you use to conserve fuel in a gasoline-powered vehicle. To achieve maximum range:

- Slow down your driving and avoid frequent and rapid acceleration. Consider using Chill Mode (touch **Controls > Pedals & Steering > Acceleration**) and Speed Assist (see [Speed Assist on page 130](#)) to assist in controlling your acceleration and speed.
- If safe to do so, modulate the accelerator pedal instead of using the brake pedal when gradually slowing down. Whenever Model X is moving and you are not pressing the accelerator pedal, regenerative braking slows down the vehicle and feeds surplus energy back to the Battery (see [Regenerative Braking on page 68](#)).

- Limit the use of resources such as heating and air conditioning. Using seat and steering wheel heaters (if equipped) to keep warm is more efficient than heating the cabin using climate controls.
- With your vehicle plugged in, use the mobile app to precondition your vehicle to ensure the cabin is at a comfortable temperature and windows are defrosted (if needed) before your drive by touching **Climate > On** and customizing your preferences (see [Mobile App on page 171](#)).
- Touch **Schedule**, available on both the charging and climate control screens, to set a time when you want your vehicle to be ready to drive (see [Scheduled Charging and Scheduled Departure on page 179](#)).
- Set Stopping Mode to **Hold** to gain the benefit of regenerative braking at low driving speeds.
- Ensure the wheels are aligned to specification, the tires are kept at the recommended inflation pressures (see [Tire Care and Maintenance on page 184](#)), and are rotated when needed (see [Maintenance Schedule on page 182](#)).
- Lighten your load by removing any unnecessary cargo.
- Fully raise all windows.
- Turn on Range Mode, if equipped (see [Range Mode on page 78](#)).
- Features such as Sentry Mode and Cabin Overheat Protection can impact range. Disable features when not needed.
- To prevent an excessive amount of energy consumption while the vehicle is idle, keep the vehicle plugged in when not in use.
- Minimize the use of DC chargers (such as Superchargers) for optimal Battery health.

It is normal for estimated range to decrease slightly over the first few months before leveling off. Over time, you may see a gradual, but natural, decrease in range at full charge - this depends on factors such as Supercharging regularly or the mileage and age of the Battery. Your Model X will inform you in the unlikely event a hardware issue is causing excessive Battery or range degradation.

The power meter on the instrument panel provides feedback on energy usage.

You can also display the Energy app to view real-time and projected energy usage (see [Energy App on page 78](#)). With this feedback, you can become familiar with how driving habits and environmental conditions impact how much energy Model X is using.



Getting Maximum Range

Range Assurance

The driving range displayed in Model X is based on estimated remaining battery energy and EPA-rated consumption. It does not account for your personal driving patterns or external conditions. The displayed range on the instrument panel may decrease faster than the actual distance driven. To view estimated range based on your recent energy consumption, open the Energy app to display the graph.

Model X helps protect you against running out of energy. Your vehicle continuously monitors its energy level and proximity to known charging locations.



Touch **Chargers** in the Navigation search bar to toggle between types of chargers, including Superchargers and destination charging sites.

When you are at risk of driving beyond the range of known charging locations, the touchscreen displays a message giving you the opportunity to display a list of charging locations that are within range. When you select a charging location from the list, Model X provides navigation instructions and the turn-by-turn direction list displays the predicted amount of energy that will remain when you arrive at the charging destination.

Trip Planner routes you through Supercharger locations to minimize the amount of time you spend charging and driving. To enable, touch **Controls > Navigation > Trip Planner** (see [Trip Planner on page 147](#)).

Energy App

The Energy app provides a visual representation of your vehicle's real-time and projected energy usage. To use the Energy app, navigate to **Application Launcher > Energy** on the touchscreen. Choose from two types of charts:

- **Consumption:** Display how much energy Model X has consumed over the past 5, 15 or 30 miles (10, 25 or 50 km).

Touch **Instant Range** or **Average Range** to adjust the projected range estimation. Instant Range uses only the latest few data points to estimate the projected range, whereas Average Range uses the past 5, 15 or 30 miles (10, 25 or 50 km) of energy consumption to provide a more accurate projected range.

- **Trip:** You can monitor the amount of energy being used while navigating to a destination. You can track actual usage against the initial prediction. The green line represents the actual usage whereas the gray line represents predicted usage. To change the zoom level, touch the zoom icon located in the top right corner of the chart.

NOTE: The Trip chart displays energy usage only if you are currently navigating to a destination.

Range Mode

Range Mode (if equipped) conserves energy by limiting the power of the climate control system and turns off the signature lights. Turn Range Mode on by touching **Controls > Driving > Range Mode**. When turned on in an All-Wheel Drive vehicle, Range Mode also optimizes torque distribution between the motors to maximize range.

Saving Energy

Model X has an energy-saving feature that reduces the amount of energy being consumed when Model X is not in use. On newer vehicles, this feature is automated to provide an optimal level of energy saving. However, on older vehicles, you can touch **Controls > Display > Energy Saving** and choose from the following options:

- **OFF** - Model X automatically shifts to the energy-saving mode only at night (10 pm to 5 am). Idle energy consumption may increase.
- **ON** - Significantly less energy is consumed whenever Model X is not in use. The start-up time of the instrument panel and Bluetooth could be slower.
- **Always Connected** - Preserves cellular connectivity when energy saving is active. This allows the mobile app to connect to Model X quicker, and provides immediate internet access when entering the car. Slightly more energy is consumed.



Camera Location

Model X is equipped with a rear view camera located above the rear license plate.

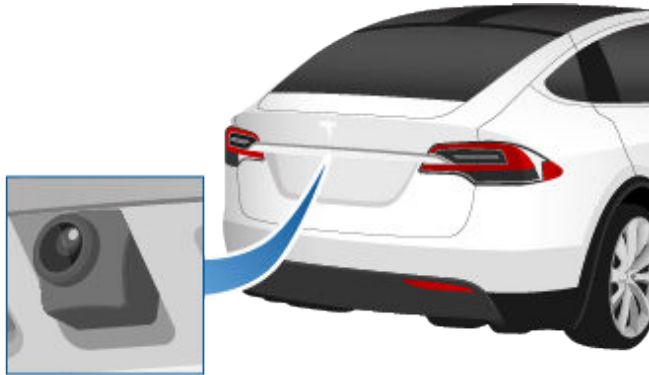

Whenever you shift into Reverse, the touchscreen displays the view from the camera. Lines show your driving path based on the position of the steering wheel. These lines adjust as you move the steering wheel.

Model X also displays images from the side cameras. Simply swipe up or down to hide or show the side camera views.

NOTE: You may need to expand the camera window to see the images from the side cameras.

NOTE: Visual feedback from the parking sensors also appear on the instrument panel (see [Park Assist on page 71](#)).



To display the view from the rear view cameras at any time, open the app launcher and touch the Camera app.

WARNING: Never depend on the cameras to inform you if the area behind you is free of objects and/or people. The cameras may not detect objects or barriers that can potentially cause damage or injury. In addition, several external factors can reduce the performance of the cameras, including a dirty or obstructed lens. Therefore, depending on the cameras to determine if Model X is approaching an obstruction can result in damage to the vehicle and/or objects and can potentially cause serious injury. Always inspect the area with your own eyes. When reversing, perform shoulder checks and use all mirrors. Use the cameras for guidance purposes only. It is not intended to replace your own direct visual checks and is not a substitute for careful driving.

Cleaning a Camera

To ensure a clear picture, the camera lens must be clean and free of obstructions. Remove any build-up of dirt or debris by spraying water onto the camera lens with a spray bottle or pressure washer.



CAUTION: Do not attempt to remove dirt or debris by wiping an exposed lens with your hands or a cloth. This debris can damage the surface of the lens when rubbed against it during wiping.



CAUTION: Do not use chemical-based or abrasive cleaners. Doing so can damage the surface of the lens.



Pedestrian Warning System

The Pedestrian Warning System (if equipped) causes Model X to emit sound when driving below 19 mph (32 km/h) or while driving in reverse. Electric vehicles operate quietly and this sound helps to alert pedestrians of your oncoming vehicle. The sound, which activates whenever Model X is shifted out of Park, gets louder as speed increases.

NOTE: The Pedestrian Warning System is not available in vehicles manufactured prior to September 1, 2020.

 **WARNING:** If sound cannot be heard, pedestrians may not be aware of your oncoming vehicle, which may increase the likelihood of a collision resulting in serious injury or death. If the Pedestrian Warning System is not operating, immediately contact Tesla.

Model X has a rear spoiler designed to improve aerodynamics. If Model X is equipped with the active spoiler, the position of the spoiler can vary depending on the status and speed of Model X:

- When Model X is in Reverse or when driving speed is below 10 mph (16 km/h), the spoiler provides maximum visibility behind Model X.
- When driving speed exceeds 45 mph (72 km/h), the spoiler lowers to the position that provides the most effective aerodynamics.
- When Model X is powered off and locked, the spoiler retracts.

To allow the spoiler to automatically move as described above, touch **Controls > Service > Spoiler Mode > Automatic**. To disable automatic movement of the spoiler and keep it in its extended position, choose the **Extended** setting.

NOTE: If the spoiler can not automatically lower or raise, the instrument panel displays an alert. Contact Tesla Service.



Towing and Accessories

The towing package allows you to tow a trailer with your Model X. It also allows you to carry skis, snowboards, bicycles, etc. by attaching an accessory carrier to the hitch.

Carrying Accessories

The Model X towing package has a 2" hitch receiver that can support an accessory carrier.

The hitch receiver is designed to support vertical loads of up to 120 lbs (54 kg). When carrying bicycles or other items on the Model X hitch, always check to ensure that the maximum weight is not exceeded. When calculating weight, remember to include the weight of the accessory carrier. For example, assuming the carrier weighs 40 lbs, the weight threshold is sufficient for carrying two bicycles weighing approximately 40 lbs each, or four bicycles weighing approximately 20 lbs each.

 **CAUTION:** The Model X hitch is designed to support up to 120 lbs (54 kg). Exceeding this maximum weight can cause significant damage.

 **CAUTION:** Do not attempt to install a carrier on a Model X that is not equipped with the towing package. Doing so can cause significant damage.

To install and use an accessory carrier, the tow hitch must be connected (see [Connecting the Tow Hitch on page 87](#)). Then follow the instructions provided with your accessory carrier. Observe all regulations and legal requirements in your state/region that apply to carrying accessories.

The Model X towing package includes the wiring necessary for using an accessory carrier equipped with lights (see [Electrical Connections on page 89](#)). The package also includes Trailer Mode software (see [Trailer Mode on page 84](#)).





When you connect an accessory carrier's wiring harness, Model X detects a connection for trailer lights and this indicator illuminates on the instrument panel. Trailer Mode is disabled.

When carrying accessories, periodically confirm that the accessory carrier and its cargo remain secure at all times, and if applicable, that the lights on the accessory carrier are working.

NOTE: Go to www.tesla.com to purchase accessories for your Model X. Although third-party products are available, Tesla recommends and supports only Tesla-approved products (see [Parts and Accessories on page 198](#)). The accessory products available for your Model X vary based on market region. Before attempting to install a non-Tesla carrier, review the product information to ensure compatibility.

NOTE: When not in use, the hitch receiver should be removed and stored in a dry location to prevent rust and corrosion. Keep the dust cover over the hitch housing to prevent dirt and debris from entering (see [Disconnecting the Tow Hitch on page 88](#)).

 **CAUTION:** A carrier may obscure your view from the rear view mirror, the rear camera(s), and/or the rear ultrasonic sensors. In addition, some Autopilot features may not function as expected.

 **WARNING:** Tesla assumes no responsibility for damage or injuries resulting from installing and using an accessory carrier, for any omissions in the instructions accompanying an accessory carrier, or for your failure to follow the instructions. Damage caused by using an accessory carrier is not covered by the warranty.



Towing Capacity

The total trailer weight (including all cargo and additional equipment), and the trailer tongue weight, must never exceed the following:

Tires	Maximum Towing Capacity*	Maximum Tongue Weight**
245/45R19 110 V / Y	SAE Class III - 4960 lb (2250 kg)	SAE Class III - 500 lb (225 kg)
275/45R20 110 V / Y	SAE Class III - 5000 lb (2300 kg)	SAE Class III - 500 lb (230 kg)
285/35R22 106 W	SAE Class II - 3500 lb (1588 kg)	SAE Class II - 350 lb (158 kg)

*Tesla recommends a separate braking system on trailers with a loaded weight of over 1000 lbs (450 kg). The braking system must be appropriate for the weight of the trailer. Follow the instructions provided by the trailer brake manufacturer to ensure that trailer brakes are properly installed, adjusted, and maintained.

**The tongue weight is the downward force that the weight of the trailer exerts on the hitch. It must not be less than 10% of the trailer load. Carrying a significant amount of equipment, passengers, or cargo in the tow vehicle can reduce the tongue weight it can handle, which also reduces the maximum towing capacity. Maximum towing capacity is calculated assuming the GVWR (Gross Vehicle Weight Rating) is not exceeded. The GVWR is printed on the Vehicle Certification Label (see [Vehicle Certification Label on page 201](#)).

NOTE: If the towing capacity on the hitch label conflicts with the information provided in this owner's manual, this owner's manual takes precedence.



WARNING: Do not overload the vehicle or trailer. Doing so can cause poor performance, vehicle damage and loss of vehicle control, resulting in serious injury.



WARNING: Do not use the trailer hitch to tow/transport Model X.





CAUTION: Tesla assumes no responsibility for damage or injuries resulting from towing a trailer, for any errors or omissions in the instructions accompanying towing equipment, or for your failure to follow the proper instructions. Damage caused by towing a trailer is not covered by the warranty.

Tire Pressures when Towing

When towing a trailer, tire pressures must be adjusted to accommodate the additional load. Keep tires inflated to the pressures shown below (these pressures override the pressures that are provided on the Tire and Loading information label):

Front Tires	Rear Tires	Cold Tire Inflation Pressure
245/45R19	245/45R19	45 psi (310 kPa)
255/45R20 265/45R20	275/45R20	46 psi (320 kPa)
265/35ZR22	285/35ZR22	50 psi (345 kPa)

 **WARNING:** Check tire pressures using an accurate pressure gauge when tires are cold. Driving one mile (1.6 km) warms the tires sufficiently to affect tire pressures. Parking the vehicle in direct sunlight or in hot weather can also affect tire pressures. If you must check warm tires, expect increased pressures. Do not let air out of warm tires in an attempt to match recommended cold tire pressures. A hot tire at or below the recommended cold tire inflation pressure is dangerously under-inflated.

 **WARNING:** Never attempt to tow a trailer when a Model X tire is faulty or has been inflated using a tire repair kit. A temporarily repaired tire is not designed to sustain the towing load. Towing using a faulty or temporarily repaired tire can result in tire failure and loss of vehicle stability.

Before Towing a Trailer

Before towing a trailer, you must do the following:

- Inflate tires to the cold tire inflation pressure specified in Tire Pressures when Towing.
- Set Suspension to **Standard** height (touch **Controls > Suspension > Standard**).
- Observe all regulations and legal requirements in your state/region that apply to trailer towing. Failure to comply with regulations can compromise your safety.
- Adjust side mirrors to provide a clear rearward view without a significant blind spot.
- Engage **Trailer Mode** (see [Trailer Mode on page 84](#)).

Confirm the following:

- Model X rests horizontally with the trailer attached. If the vehicle is tipped up at the front, and down at the rear, check that you are not exceeding the maximum towing capacity and tongue loads provided in Carrying Capacity.
- All trailer hitch parts and attachments, safety chains, and electrical connectors are in good condition and are properly connected. If any problems are apparent, do not tow the trailer.
- Trailer lights (brake lights, turn signal lights, and marker lights) are working properly.
- The trailer tongue is securely connected to the hitch ball.
- Safety chains are properly connected between the trailer and the tow vehicle. Cross the safety chains under the tongue of the trailer to help prevent the tongue from contacting the road if it separates from the hitch. Leave enough slack in the safety chains to allow for turns and ensure that the chains can never drag on the ground.
- All cargo is secured.
- Wheel chocks are available.
- The trailer load is evenly distributed such that the trailer tongue weight is approximately 10% of the total trailer weight, without exceeding the maximum tongue weights provided in Carrying Capacity.
- If the trailer is equipped with a separate braking system, check that the brakes work and are properly adjusted. To provide safe stopping ability, you must balance the trailer brakes with the vehicle brakes.

NOTE: For general information about trailer safety provided by the National Highway Traffic Safety Administration, go to: <http://www.nhtsa.gov/cars/problems/Equipment/towing/Towing.pdf>.

 **WARNING:** The trailer tongue weight must be approximately 10% of the total trailer weight without exceeding the maximum tongue weights provided in Carrying Capacity. Loads that are balanced over the wheels or heavier in the rear can cause trailer sway, resulting in loss of vehicle control.

 **WARNING:** Always ensure that cargo is secured in the trailer and will not shift. Dynamic load shifts can cause loss of vehicle control, resulting in serious injury or death.

Trailer Mode

Trailer Mode must always be active when towing a trailer. When you connect a trailer's electrical connection, Model X automatically engages Trailer Mode. When you disconnect the trailer's electrical connection, Trailer Mode disengages. To engage or exit Trailer Mode manually, touch **Controls > Pedals & Steering > Trailer Mode** on the touchscreen. One of the following indicators display on the instrument panel:



Trailer Mode is active.



Model X detects a connection for trailer lights but Trailer Mode is disabled. It is likely that a carrying accessory has been connected.



Model X detects a faulty electrical connection for the trailer lights. Some, or all, trailer lights may not be functioning. Pull over as soon as safety permits and inspect the trailer lights for faulty cabling or connections. If the issues are resolved and the red icon still persists, turn Trailer Mode off and on again.

NOTE: In situations where Model X detects a heavy load, it assumes that a trailer is connected and automatically engages Trailer Mode. A message displays on the instrument panel informing you that Trailer Mode has been engaged. When Trailer Mode is entered automatically due to detection of a heavy load, you can change the Trailer Mode setting only by stopping Model X, engaging Park or Neutral, then manually applying the parking brake using the touchscreen (**Controls** > **Safety** > **Parking Brake**).

Some Autopilot features (Autosteer, Summon, Lane Assist, etc.), as well as rear parking sensor functionality, may not be available when Trailer Mode is enabled. In addition, some features may operate differently. For example:

- Traffic-Aware Cruise Control increases the following distance from the car in front of you.
- The air suspension system will not make speed-based adjustments from **STANDARD** to **LOW**.
- The air suspension system does not automatically raise ride height based on saved locations.
- Side collision warnings are active but automatic steering interventions are disabled.
- The braking force provided by Automatic Emergency Braking (see [Collision Avoidance Assist on page 127](#)) is significantly limited.

⚠ WARNING: Do not rely on Model X to detect the trailer and automatically engage Trailer Mode. Always check that Trailer Mode is engaged before towing a trailer.

⚠ WARNING: Under no circumstances should you exit Trailer Mode when towing a trailer. Doing so can cause serious injury and/or death.

⚠ WARNING: Do not use the suspension setting to appropriately match the height of the hitch with the height of the trailer. You must choose a trailer hitch and trailer that have the appropriate height for suitable axle loading and trailer balance.

Trailer Brakes

When towing a loaded trailer that weighs more than 1000 lbs (450 kg), Tesla recommends that the trailer be equipped with its own brake system adequate for the weight of the trailer. Ensure compliance with local regulations. A brake controller must be purchased separately, and the required 4-pin pigtail connector can be ordered from Tesla Service.

Follow these steps to connect a brake controller:

1. Connect the wiring on the brake controller to the appropriate locations on the 4-pin pigtail connector.

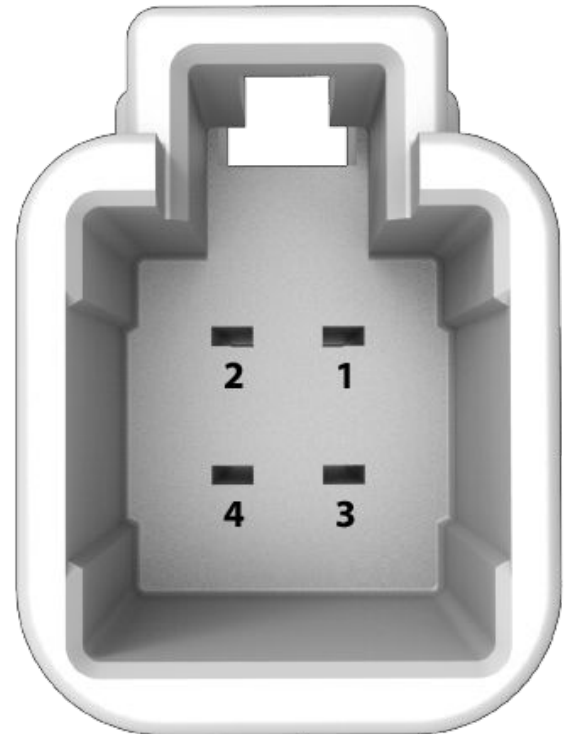

1 - Brake control output to trailer

2 - Ground

3 - Brake On Signal

4 - Low Voltage Power (20A)

2. Remove the cover located under the dashboard in the driver's side foot well.

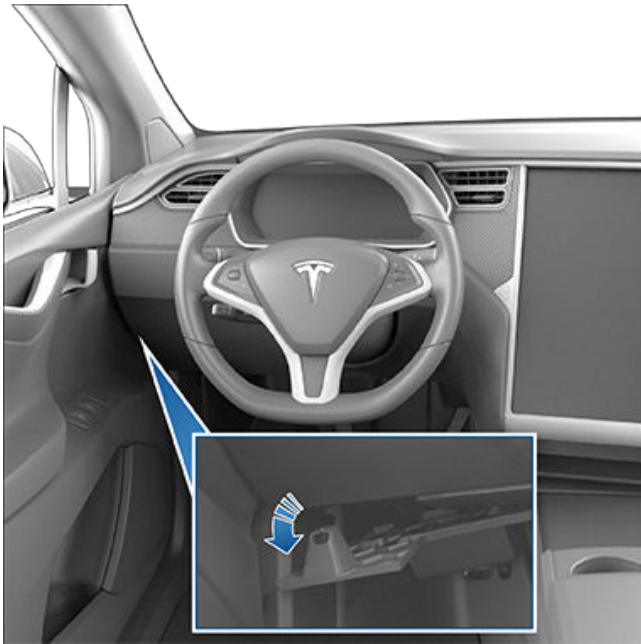

3. Peel back the carpet to expose Model X's 4-pin connector on the wiring harness.



4. Connect the pigtail connector to the vehicle wiring connector.

WARNING: Towing increases your stopping distance, even when the trailer is equipped with its own braking system. When towing, increase your following distance and avoid situations that could potentially cause heavy braking. Failure to do so can result in a collision.

- WARNING:** Observe all regulations and legal requirements in your regional and national jurisdictions that apply specifically to trailer towing and brake requirements. Many regions require a breakaway switch, located on the tongue of the trailer, to activate the trailer brakes in the event that the trailer separates from the vehicle. Failure to comply with regulations can compromise your safety.
- WARNING:** Follow the instructions provided by the trailer brake manufacturer to ensure that trailer brakes are properly installed, adjusted, and maintained. Tesla is not responsible for damages caused by incorrect installation of trailer braking systems.
- WARNING:** Never attempt to connect trailer brakes directly to the vehicle braking system. Doing so can cause damage to the vehicle and the trailer, and can cause the braking system to malfunction, resulting in serious injury or death.

Towing Guidelines

Model X is designed primarily as a passenger-carrying vehicle. Towing a trailer puts additional load on the motor(s), drive train, brakes, tires, and suspension and significantly decreases range. If you decide to tow a trailer, proceed with caution and follow these general guidelines:

- Reduce your driving speed and avoid sudden maneuvers. Keep in mind that when towing a trailer, steering, stability, turning radius, stopping distance and braking performance are different when compared to driving without a trailer.
- Increase your following distance by maintaining at least twice the distance from a vehicle ahead. This helps to avoid situations that require heavy braking. Sudden braking may result in skidding or jack-knifing, and loss of control.
- Avoid sharp turns. Sharp turns can cause the trailer to contact the vehicle and cause damage. Keep in mind that the trailer wheels are closer to the inside of the turn than the vehicle's wheels. Therefore, make wider turns to prevent the trailer from hitting curbs, road signs, trees or other objects.
- Periodically check the trailer lights and turn signals to confirm that bulbs are still working. When towing a trailer, the turn signal arrows on the vehicle instrument cluster flash as normal, even if the bulbs on the trailer are burned out.
- Periodically confirm the cargo is secure.
- Periodically confirm the trailer brakes are working.
- Avoid parking on a grade (see [Parking with a Trailer on page 87](#)).
- Regularly confirm that all towing components are securely tightened.



Parking with a Trailer

Whenever possible, avoid parking on a grade. However, if parking on a grade is absolutely necessary, place wheel chocks under the trailer wheels:

- One person presses and holds the brake pedal.
- A second person places the wheel chocks under the wheels on the downgrade side of the vehicle's tires.
- When the chocks are in place, release the brake pedal and ensure the chocks hold the weight of the vehicle and trailer.

NOTE: When testing chocks, ensure that Vehicle Hold (see [Vehicle Hold](#) on page 73) is not engaged. If Vehicle Hold is braking Model X, the Vehicle Hold indicator light displays on the instrument panel. To disengage Vehicle Hold, press and release the brake pedal.

- Place the vehicle in Park.

⚠ WARNING: If parking on a grade is necessary, always ensure that all trailer wheels have been securely chocked. Failure to do so can result in serious damage, injury, or death.

Trailer Sway Mitigation

When trailer sway is detected, the Model X electronic stability control system attempts to apply the appropriate amount of braking to minimize trailer sway. The instrument panel briefly displays the traction control system indicator. Pressing the brake pedal when the system is actively braking to mitigate trailer sway does not cancel this automatic braking.

Connecting the Tow Hitch

The Model X towing package includes a weight-carrying hitch with a 2" x 2" removable hitch receiver. When not in use, the hitch receiver should be removed and stored in a dry location to prevent rust and corrosion. Keep the dust cover over the hitch housing to prevent dirt and debris from entering.

⚠ CAUTION: Always remove the ball mount before installing or removing the hitch receiver from the vehicle (see [Attaching and Removing the Ball Mount](#) on page 88).

⚠ WARNING: You must use the Model X trailer hitch when towing a trailer. Never attempt to attach a different type of trailer hitch.

NOTE: Always attach safety chains when towing. Cross the chains under the trailer tongue and attach to the trailer eyelets to ensure the security of the trailer load.

NOTE: The maximum permissible rear overhang for the coupling point is 47 inches (1186 mm).

NOTE: The trailer hitch assembly is attached to the body of the vehicle with 8 nuts.



To install the trailer hitch receiver:

1. Remove the dust cover from the hitch housing.



2. Insert the key into the locking cylinder on the hitch, and turn the cylinder so the top of the key is aligned with the "unlocked" position.
3. Pull the locking cylinder out of the adapter approximately 1/8" (0.5 cm), and turn clockwise until the red marking on the cylinder aligns with the white dot.



Towing and Accessories



WARNING: Be careful when turning the locking cylinder. If it does not lock into the “Open Position”, it automatically retracts into its original “Closed Position” and can pinch your fingers.

4. Firmly grasp the hitch from the bottom and align the triangular-shaped guides at the sides of the hitch with the corresponding cutouts in the hitch housing.

NOTE: Do not grasp the locking cylinder because it needs to rotate freely.

5. Push the hitch into the hitch housing until the locking cylinder rotates approximately 120° counter-clockwise and automatically locks into the “Closed Position”. The green area on the locking cylinder (above the white arrow) aligns with the white dot on the housing.
6. Visually check to confirm that the hitch is fully inserted into the housing. Try pulling down on the hitch. The hitch should not drop when you pull down.

NOTE: If the hitch does not lock into the housing, it falls out when you pull down on it.

7. Turn the key so the arrows align with the “locked” marking on the locking cylinder.
8. Remove the key and store it in a safe place (preferably inside the vehicle).

NOTE: The key can be removed only if the hitch is locked. This indicates a proper connection. Do not use the hitch if the key is not removed.

NOTE: Tesla recommends making a note of the key code. You need this code if you lose the keys and need to order a replacement.

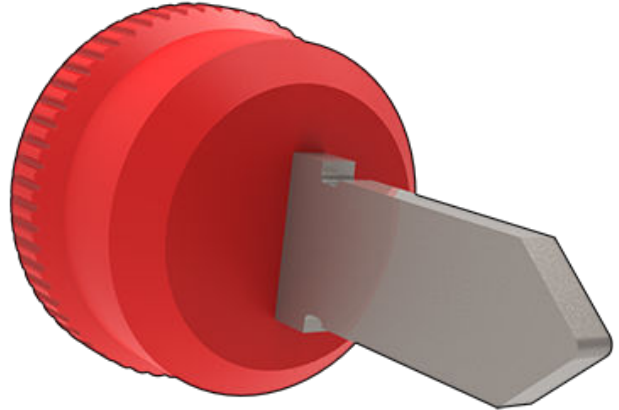

9. Close the dust cover to prevent dirt and debris from entering the lock. For newer version with push clips, reattach the dust cover, snap it in place and open the push clips before pushing them in.

NOTE: To maintain the hitch, regularly grease its surfaces with non-resinous grease.

Disconnecting the Tow Hitch

After towing, remove the hitch:

1. Insert the key and turn to align the top of the key with the “unlocked” position.
2. While firmly holding the bottom of the hitch (to prevent it from dropping to the ground), pull the locking cylinder out approximately 1/8” (0.5 cm), and turn it clockwise until the red marking on the locking cylinder aligns with the white dot. At this point, the locking cylinder is locked in the “open” and the hitch drops out of the housing.

WARNING: Be careful when turning the locking cylinder. If it does not lock into the “Open Position”, it automatically retracts into its original “closed” position and can pinch your fingers.

3. Reinstall the dust cover on the hitch housing to prevent dirt from accumulating inside the housing.
4. Close the dust cover on the hitch’s locking cylinder and store the hitch in a secure location.

Attaching and Removing the Ball Mount

The Model X towing package does not include a ball mount. You must purchase a ball mount suitable for the type of trailer you are towing. The Model X hitch receiver supports a ball mount up to 8” with a rise of up to 0.75”. Do not use any type of drop ball mount.

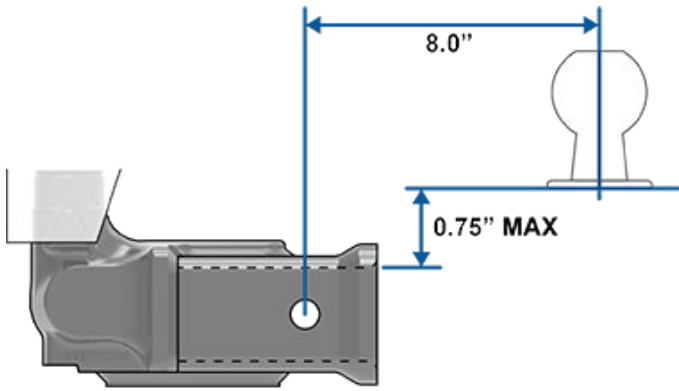

To attach a ball mount:

1. If necessary, remove the cotter pin from the locking bolt and slide the locking bolt out of the hitch assembly.
2. Slide the ball holder into the hitch assembly.
3. Align the hole in the ball holder with the one in the hitch assembly.
4. Slide the locking bolt through the hitch assembly/ball holder.
5. Insert the cotter pin in the hole at the end of the locking bolt.

To remove a ball mount:

1. Remove the cotter pin from the locking bolt and slide the locking bolt out of the ball holder/hitch assembly.
2. Pull the ball holder out of the hitch assembly.

Electrical Connections

Regulations require all trailers to be equipped with tail lights, brake lights, side marker lights, and turn signals. To provide power for trailer lighting, a built-in seven-way wiring connector (SAE J560) is attached near the tow hitch. Most trailer wiring plugs can be attached to this connector.

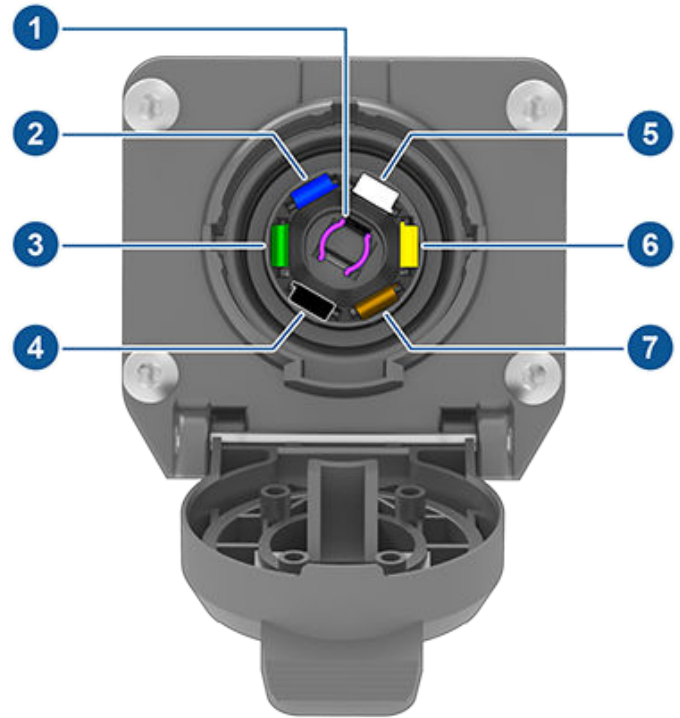

1. Reverse Lights (Purple)
2. Low Voltage Power (Red or Black)
3. Right Turn Signal and Brake Light (Green)
4. Brake Controller Output (Blue)
5. Tail Lights and Running Lights (Brown)
6. Left Turn Signal and Brake Light (Yellow)
7. Ground (White)

NOTE: It is the driver's responsibility to ensure that all electrical connections are working, and all trailer lights are operating before and during towing. Model X does not detect faulty trailer lights. You must perform manual checks.

NOTE: Loss of trailer lights when towing may be the result of a fault in the trailer wiring or excessive power consumption by the lights connected to the trailer output(s). When this occurs, a red Trailer Mode icon appears on the touchscreen. Fix any issues with the wiring and/or reduce the number of lights connected to the trailer output(s), then toggle Trailer Mode off and on again.

Plugging trailer wiring into the Model X electrical connector automatically engages Trailer Mode (see [Trailer Mode on page 84](#)).

⚠ WARNING: The brake controller output operates only when a brake controller is installed (see [Trailer Brakes on page 85](#)).



Towing and Accessories

 **WARNING:** Use only the electrical connection designed by Tesla. Do not attempt to directly splice or attempt to connect trailer electrical wiring using any other method. Doing so can damage the vehicle electrical system and cause malfunctions.

 **CAUTION:** Always ensure that the trailer electrical cable does not contact or drag on the ground and there is enough slack in the cable to allow for turns.

Impact on Range

Towing a trailer and carrying accessories increases vehicle weight and drag. As a result, driving range can decrease significantly. Although Trip Planner attempts to adjust estimates based on Trailer Mode, actual energy consumption may vary. Plan trip length and charging destinations accordingly.



To ensure that Model X provides you with the best ownership experience possible in harsh cold weather conditions, follow these best practices.

Before Driving

When snow and ice accumulate on your vehicle, moving parts, such as the door handles, windows, mirrors, and wipers can freeze in place. To achieve maximum range and performance, it is helpful to warm the cabin and Battery before you leave. There are several ways to do so:

- Touch **Schedule**, available on both the charging and climate control screens, to set a time when you want your vehicle to be ready to drive (see [Scheduled Charging and Scheduled Departure on page 179](#)).
- On the mobile app, navigate to **Climate** to customize the temperature at which you want to heat the cabin. This also warms the high voltage Battery as needed.
- On the mobile app, navigate to **Climate > Defrost** to melt snow, ice, and frost on the windshield, windows, and mirrors. This also warms the high voltage Battery as needed.

NOTE: Tesla recommends activating climate settings at least 30-45 minutes before departure (see [Climate Controls on page 138](#)). Preconditioning times depend on outside temperature and other factors. The Mobile App will notify you once your vehicle has reached the desired preconditioning temperature.

- In extremely cold weather or icy conditions, it is possible that your charge port latch may freeze in place. In cases where you cannot remove or insert the charge cable, or the vehicle is not Supercharging due to the latch being frozen in place, use your Tesla mobile app to precondition on **HI** for approximately 30-45 minutes (you must use your mobile app to precondition; setting your climate to **HI** using the touchscreen is not effective). This can help thaw ice on the charge port latch so the charge cable can be removed or inserted.
- Warming the Battery using Scheduled Departure or the mobile app before driving can also reduce charging time at a Supercharger or third party fast charger, especially if the Supercharger or third party fast charger is close enough that Trip Planner does not have sufficient time to precondition the Battery (see [Warming the Battery Before Supercharging on page 92](#)).

Windows

- On the mobile app, navigate to **Climate > Defrost** as mentioned previously.
- Use the mobile app to schedule a service appointment for Tesla to provide hydrophobic coating to your windows for a nominal fee.

Mirrors

If ice buildup is expected when parking, turn off **Auto-Fold Mirrors**. Touch **Controls > Vehicle > Auto-Fold**. Ice can prevent exterior side mirrors from folding or unfolding.

NOTE: Side mirrors automatically heat as needed during preconditioning, or when the rear defroster is turned on.

Wipers

If you expect snow or ice to build up when parked, touch **Controls > Service > Wiper Service Mode**. This raises wipers against the windshield so they can defrost when the windshield defrosts (see [Wipers and Washers on page 66](#)). You can also turn on wiper defrosters (if equipped). See [Climate Controls on page 138](#).

Tires and Tire Chains

- Use winter tires to increase traction in snowy or icy conditions. You can purchase winter tires on <http://www.tesla.com> (see [Seasonal Tire Types on page 188](#)).
- Tire chains provide additional traction when driving in snowy or icy conditions. Check local regulations to determine if tire chains are recommended or required during winter months. See [Using Tire Chains on page 188](#) for more information.

Your vehicle's tire pressures will drop in cold ambient temperatures. If the TPMS indicator light appears, inflate the tires before driving. The tires will lose one PSI for every 10° F (6° C) drop in outside temperature (see [Tire Care and Maintenance on page 184](#)). Proper tire pressures help protect tires from potholes and improve range when properly inflated.

While Driving

Cold weather can increase energy consumption because more power is required for driving, cabin and Battery heating. Follow these suggestions to reduce energy consumption:

- Use seat heaters to keep warm. Seat heaters use less energy than the cabin heater. Lowering the cabin temperature and using seat heaters reduces energy consumption (see [Climate Controls on page 138](#)).
- Slow down your driving and avoid frequent and rapid acceleration.
- Turn on Range Mode (if equipped) to automatically limit the power that the climate control system uses to maintain the temperature of the Battery and the cabin area. Range Mode also turns off signature lights (if equipped) and adjusts the front and rear motor torque split to maximize range (see [Getting Maximum Range on page 77](#)).



Cold Weather Best Practices

Regenerative Braking

Regenerative braking can be limited if the Battery is too cold. As you continue to drive, the Battery warms up and regenerative power increases (see [Regenerative Braking on page 68](#)).

NOTE: Limited regenerative braking can be avoided if you allow enough time to precondition your vehicle or if you use **Schedule** to precondition Model X before your departure time (see [Scheduled Charging and Scheduled Departure on page 179](#)).

Blue Snowflake Icon



A blue snowflake icon appears on your instrument panel when some of the stored energy in the Battery is unavailable because the Battery is cold. This portion of unavailable energy displays in blue on the Battery meter. Regenerative braking, acceleration, and charging rates may be limited. The snowflake icon no longer displays when the Battery is sufficiently warm.

Warming the Battery Before Supercharging

By using Trip Planner (see [Trip Planner on page 147](#)) to navigate to a Supercharger, Model X pre-heats the Battery to ensure when you arrive at the Supercharger, the Battery temperature is optimal and ready to charge. This reduces the amount of time it takes to charge.

NOTE: Tesla recommends using Trip Planner to navigate to a Supercharger for at least 30-45 minutes before arrival to ensure optimal Battery temperature and charging conditions. If the drive to the Supercharger is less than 30-45 minutes, consider preconditioning the Battery prior to driving (see [Before Driving on page 91](#)).

Autopilot

To ensure optimal Autopilot performance, keep the sensors free of snow, ice, mud, and dirt (see [About Autopilot on page 93](#)).

After Driving

Leave Model X plugged in when not in use. This uses the charging system, rather than the Battery itself, to keep the Battery warm (see [High Voltage Battery Information on page 175](#)).

Scheduled Departure

When parked, plug in Model X and use the **Schedule** settings, available on both the charging and climate control screens, to set a time when you want to precondition Model X (see [Scheduled Charging and Scheduled Departure on page 179](#)). Your vehicle determines the appropriate time to begin charging so it is complete during off-peak hours and the cabin and Battery are warm by your set departure time. For more information, see [Scheduled Charging and Scheduled Departure on page 179](#).

Charge Port

- If your charge port latch freezes in place and a charging cable becomes stuck in the charge port, try manually releasing the charge cable. See [Manually Releasing Charge Cable on page 180](#).
- Use the mobile app to precondition your vehicle to help thaw ice on the charge port latch so that the charge cable can be removed or inserted (see [Mobile App on page 171](#)).

NOTE: You can also prevent the occurrence of a charge port latch freezing in place by using the **Schedule** settings (see [Scheduled Charging and Scheduled Departure on page 179](#)).

NOTE: If your charge port latch is frozen in place, it may not lock the charging cable in place when inserted, but it can still charge at a slow AC rate even if the latch is not engaged.

Storage

If you leave Model X parked for an extended period of time, plug the vehicle into a charger to prevent normal range loss and to keep the Battery at an optimal temperature. Your vehicle is safe to stay plugged in for any length of time.

When not in use, Model X enters a sleep mode to conserve energy. Reduce the number of times you check your vehicle's status on the mobile app, as this automatically wakes up your vehicle and starts normal energy consumption.



How It Works

Your Model X includes the following components that actively monitor the surrounding area:

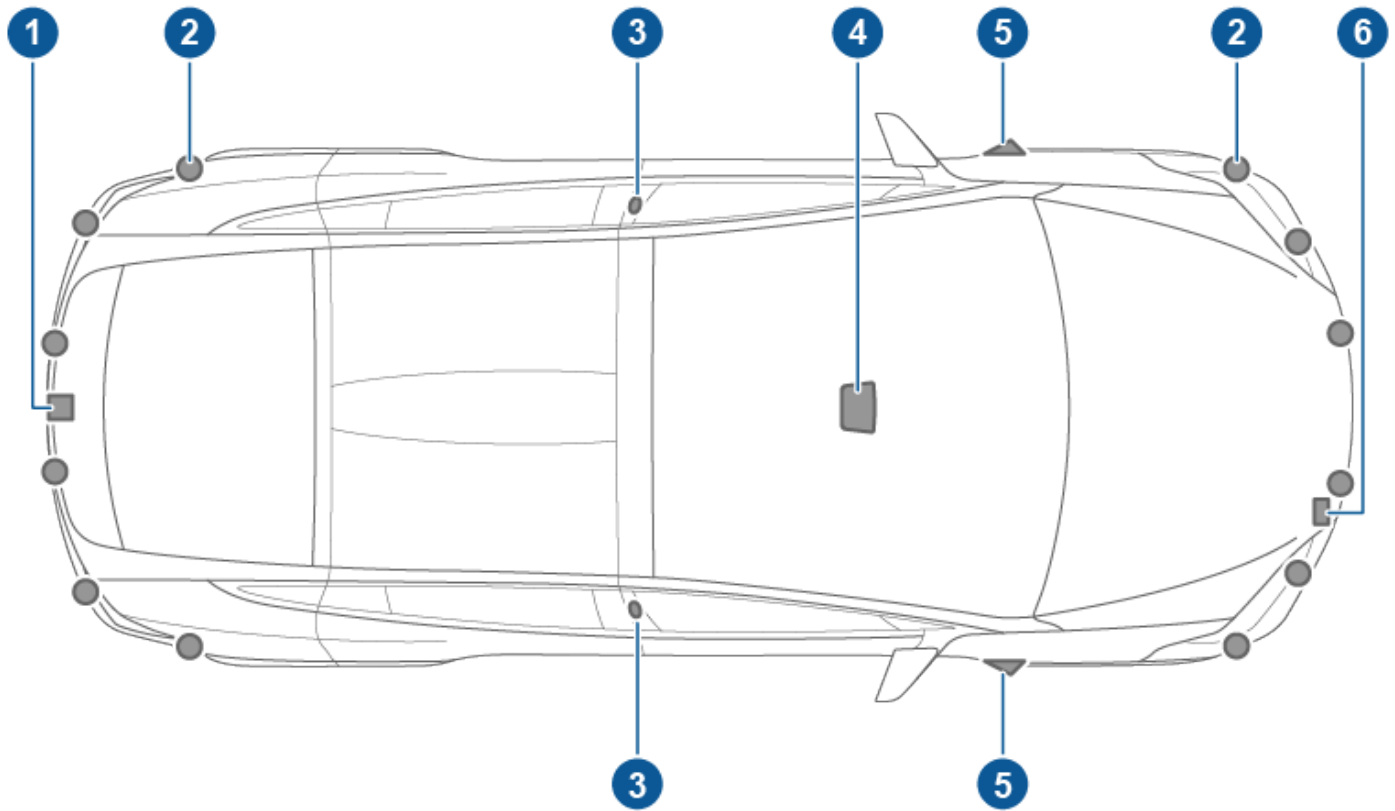

1. A camera is mounted above the rear license plate.
2. Ultrasonic sensors are located in the front and rear bumpers.
3. A camera is mounted in each door pillar.
4. Three cameras are mounted to the windshield above the rear view mirror.
5. A camera is mounted to each front fender.
6. Radar is mounted behind the front bumper.

Model X is also equipped with high precision electronically-assisted braking and steering systems.

NOTE: Ensure all cameras and sensors are clean before each drive. See [Cleaning Cameras and Sensors on page 95](#) for more information. Dirty cameras and sensors, as well as environmental conditions such as rain and faded lane markings, can affect Autopilot performance.



Active Safety Features

These Active Safety features are designed to increase your safety:

- Lane Assist (see [Lane Assist on page 124](#))
- Collision Avoidance Assist (see [Collision Avoidance Assist on page 127](#))
- Speed Assist (see [Speed Assist on page 130](#))

You can enable/disable some of these features and in some cases, control how they work. To access settings for these features, touch **Controls** > **Autopilot**.

Autopilot Features

NOTE: Depending on market region, vehicle configuration, options purchased, and software version, your vehicle may not be equipped with all features listed below, or a feature may not operate exactly as described.

These Autopilot convenience features are designed to reduce driver workload:

- Traffic-Aware Cruise Control (see [Traffic-Aware Cruise Control on page 96](#))
- Autosteer (see [Autosteer on page 101](#))
- Auto Lane Change (see [Auto Lane Change on page 103](#))
- Autopark (see [Autopark on page 116](#))
- Summon (see [Summon on page 118](#))
- Smart Summon (see [Smart Summon on page 121](#))
- Stop Light and Stop Sign Warning (see [Stop Light and Stop Sign Warning on page 104](#))
- Navigate on Autopilot (see [Navigate on Autopilot on page 106](#))
- Traffic Light and Stop Sign Control (see [Traffic Light and Stop Sign Control on page 109](#))

You can enable/disable some of these features and in some cases, control how they work. To access settings associated with these features, touch **Controls** > **Autopilot**.

Drive to Calibrate Cameras

Model X must maneuver with precision when Autopilot features are being used. Therefore, before some features can be used for the first time or after some types of service repairs, cameras must complete a self-calibration process. For your convenience, the instrument panel displays a progress indicator.

When calibration is complete, Autopilot features are available for use. Calibration typically completes after driving 20-25 miles (32-40 km), but the distance varies depending on road and environmental conditions. For example, calibration completes quicker when driving on a straight road with multiple lanes (such as a controlled-access highway), with highly-visible lane markings (in the driving lane as well as the adjacent lanes). Contact Tesla only if your Model X has not completed the calibration process after driving 100 miles (160 km) in the described conditions.

If a camera has shifted from its calibrated position (for example, the camera or windshield was replaced), you must clear the calibration. To do so, touch **Controls** > **Service** > **Camera Calibration** > **Clear Calibration**. When the calibration is cleared, Model X repeats the calibration process. While this helps re-calibrate the cameras in many cases, **Clear Calibration** may not resolve all camera and sensor concerns.

NOTE: The self-calibration drive process is only applicable to Model X vehicles built after approximately October 12, 2016.

NOTE: To calibrate, cameras require highly-visible lane markings in both the driving lane and adjacent lanes (at least two lanes over on each side of the vehicle). For best results, drive in the middle lane of a multi-lane highway (ideally with at least five lanes) that has clear lane markings and minimal traffic.

NOTE: If you attempt to use a feature that is not available until the calibration process is complete, the feature is disabled and the instrument panel displays a message.

NOTE: Model X must repeat the calibration process if the cameras are serviced by Tesla, and in some cases, after a software update.

Limitations

Many factors can impact the performance of Autopilot components, causing them to be unable to function as intended. These include (but are not limited to):

- Poor visibility (due to heavy rain, snow, fog, etc.).
- Bright light (due to oncoming headlights, direct sunlight, etc.).
- Damage or obstructions caused by mud, ice, snow, etc.
- Interference or obstruction by object(s) mounted onto the vehicle (such as a bike rack).
- Obstruction caused by applying excessive paint or adhesive products (such as wraps, stickers, rubber coating, etc.) onto the vehicle.
- Narrow or winding roads.
- A damaged or misaligned body panel.
- Use of gray or aftermarket glass.



- Interference from other equipment that generates ultrasonic waves.
- Extremely hot or cold temperatures.

 **CAUTION:** If a windshield replacement is needed, take your vehicle to Tesla Service. This ensures appropriate handling and mounting of the camera(s). Failure to do so can cause one or more Autopilot features to malfunction.

 **WARNING:** The list above does not represent an exhaustive list of situations that may interfere with proper operation of Autopilot components. Never depend on these components to keep you safe. It is the driver's responsibility to stay alert, drive safely, and be in control of the vehicle at all times.

 **WARNING:** Advanced safety features may not be available during the calibration period.

 **WARNING:** Re-calibrating the cameras or sensors on the touchscreen is not a substitute for checking the physical positioning and condition of these components. Walk around your vehicle and inspect the cameras and sensors for physical damage. Incorrectly calibrated or positioned cameras and sensors may limit or disable the use of safety features. Contact Tesla if you suspect lingering issues.

Cleaning Cameras and Sensors

To ensure the various Autopilot components can provide information that is as accurate as possible, keep them clean and free of obstructions, condensation, or damage (see [Cleaning on page 190](#)).

Condensation can form inside the camera enclosures, especially if you park your vehicle outside in cold or wet conditions. The instrument cluster may display an alert stating that a camera is blocked and that some or all Autopilot features may be temporarily restricted until the camera vision is clear. To proactively dry the condensation, precondition the cabin by setting it to a warm temperature, turning the windshield defroster on, and directing the front air vents toward the door pillars (see [Mobile App on page 171](#)).

 **CAUTION:** Do not wipe an exposed lens with your hands or a cloth in an attempt to remove dirt or debris. The debris can damage the surface of the lens when wiped.

 **CAUTION:** Do not use chemical-based or abrasive cleaners. Doing so can damage surfaces.

 **CAUTION:** Do not clean an ultrasonic sensor or camera lens with a sharp or abrasive object that can scratch or damage its surface.



Traffic-Aware Cruise Control

NOTE: Depending on market region, vehicle configuration, options purchased, and software version, your vehicle may not be equipped with Traffic-Aware Cruise Control, or the feature may not operate exactly as described. If your vehicle is not equipped, refer to the owner's manual on your vehicle's touchscreen for instructions on how to use Cruise Control.

NOTE: Traffic-Aware Cruise Control is a BETA feature.

Traffic-Aware Cruise Control determines when there is a vehicle in front of you in the same lane. If the area in front of Model X is clear, Traffic-Aware Cruise Control maintains a set driving speed. When a vehicle is detected, Traffic-Aware Cruise Control is designed to slow down Model X as needed to maintain a selected time-based distance from the vehicle in front, up to the set speed. Traffic-Aware Cruise Control does not eliminate the need to watch the road in front of you and to manually apply the brakes when needed.

Traffic-Aware Cruise Control is primarily intended for driving on dry, straight roads, such as highways.

CAUTION: Ensure all cameras and sensors are clean before each drive. Dirty cameras and sensors, as well as environmental conditions such as rain and faded lane markings, can affect Autopilot performance.

WARNING: Traffic-Aware Cruise Control is designed for your driving comfort and convenience and is not a collision warning or avoidance system. It is your responsibility to stay alert, drive safely, and be in control of the vehicle at all times. Never depend on Traffic-Aware Cruise Control to adequately slow down Model X. Always watch the road in front of you and be prepared to take corrective action at all times. Failure to do so can result in serious injury or death.

WARNING: Although Traffic-Aware Cruise Control is capable of detecting pedestrians and cyclists, never depend on Traffic-Aware Cruise Control to adequately slow Model X down for them. Always watch the road in front of you and be prepared to take corrective action at all times. Failure to do so can result in serious injury or death.

WARNING: Do not use Traffic-Aware Cruise Control on winding roads with sharp curves, on icy or slippery road surfaces, or when weather conditions (such as heavy rain, snow, fog, etc.) make it inappropriate to drive at a consistent speed. Traffic-Aware Cruise Control does not adapt driving speed based on road and driving conditions.

To Use Traffic-Aware Cruise Control

To initiate Traffic-Aware Cruise Control when no vehicle is detected ahead of you, you must be driving at least 18 mph (30 km/h), unless certain vehicle and environmental conditions are met, in which case, you may be able to initiate it at lower speeds. If a vehicle is

detected ahead of you, you can initiate Traffic-Aware Cruise Control at any speed, even when stationary, provided Model X is at least 5 feet (150 cm) behind the detected vehicle and certain vehicle and environmental conditions are met.

NOTE: The maximum cruising speed is 90 mph (150 km/h). It is the driver's responsibility to cruise at a safe speed based on road conditions and speed limits.



When Traffic-Aware Cruise Control is available but not engaged, the instrument panel displays a gray cruising speed icon. The number shown in gray represents the cruising speed that will be set when you engage Traffic-Aware Cruise Control.



When Traffic-Aware Cruise Control is actively cruising at a set cruising speed, the icon turns blue and displays the set cruising speed.

- When available, you can engage Traffic-Aware Cruise Control to match the speed limit or your current speed. Choose:
 - To engage Traffic-Aware Cruise Control *at your current driving speed*, move the Autopilot stalk up or down once and release the accelerator pedal to allow Traffic-Aware Cruise Control to maintain the cruising speed.
 - To engage Traffic-Aware Cruise Control *at the currently detected speed limit*, pull the Autopilot stalk toward you once and release the accelerator pedal to allow Traffic-Aware Cruise Control to maintain the cruising speed.

NOTE: Double-pulling the Autopilot stalk toward you engages Autosteer (assuming it has been enabled as described in [Autosteer on page 101](#)) in addition to setting the cruising speed.

NOTE: If you choose to engage Traffic-Aware Cruise Control at the currently detected speed limit, you can specify an offset. Touch **Controls** > **Autopilot** > **Set Speed Offset**. You can choose a **Fixed** offset, in which the cruising speed adjusts by a specific number of mph (km/h) on all roads, or a **Percentage** offset, in which the cruising speed is adjusted as a percentage of the road's detected speed limit. If you pull the Autopilot stalk toward you when you are already driving faster than the speed limit, the set speed adjusts to your current driving speed instead of the speed limit. If you move the Autopilot stalk up or down when cruising at the speed limit, your set speed changes to your current driving speed.

WARNING: When you adjust the cruising speed based on the speed limit, the set cruising speed may not change when the speed limit changes.



⚠ WARNING: Do not rely on Traffic-Aware Cruise Control or Speed Assist to determine an accurate or appropriate cruising speed. It is the driver's responsibility to cruise at a safe speed based on road conditions and applicable speed limits.

2. To change your speed while using Traffic-Aware Cruise Control, you can use the right scroll wheel or the Autopilot stalk. For details, see [Changing the Cruising Speed on page 97](#).
3. To cancel Traffic-Aware Cruise Control, push the stalk away from you once or press the brake pedal. See [Canceling and Resuming on page 99](#) for more information.

Set Traffic-Aware Cruise Control Chime

If you want a chime to sound when you engage or cancel Traffic-Aware Cruise Control, touch **Controls** > **Autopilot** > **Traffic-Aware Cruise Control Chime**.

NOTE: Model X must be in Park.

Changing the Cruising Speed

To change the set cruising speed while using Traffic-Aware Cruise Control, move the Autopilot stalk up (increase) or down (decrease) until the instrument panel icon displays your desired cruising speed.

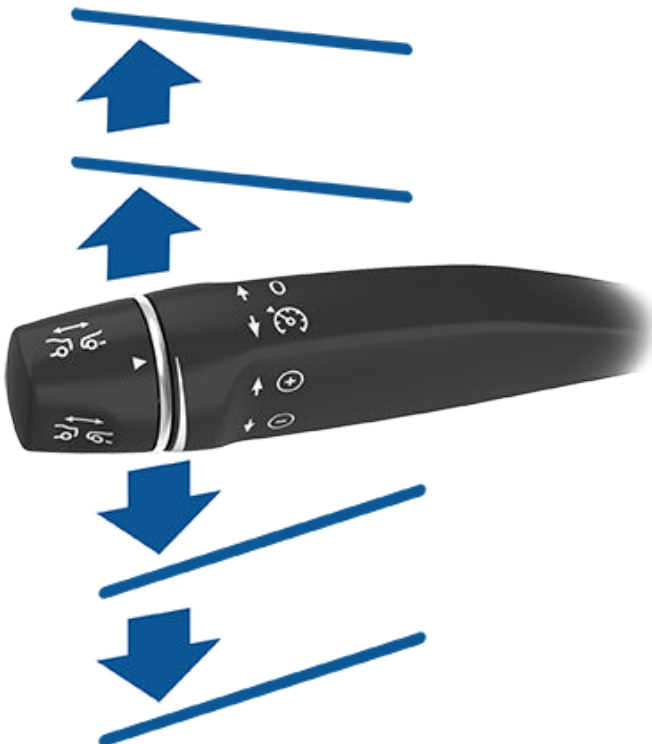

To increase/decrease speed by 1 mph (1 km/h), move the stalk up or down to the first position and release. To increase/decrease speed to the closest 5 mph (5 km/h) increment, move the stalk up/down to the second position and release. For example, if you are traveling at 57 mph and you move the stalk up to the second position and release, the speed increases to 60 mph. You can also increase/decrease speed by holding the stalk in the full up/down position and releasing when the icon on the instrument panel displays your desired cruising speed.

You can also pull and hold the Autopilot stalk towards you for approximately half a second to cruise at the detected speed limit.

NOTE: It may take a few seconds for Model X to reach the new cruising speed, assuming Model X is not cruising behind a vehicle that is driving slower than your set speed.

Cruising at the Set Speed

Traffic-Aware Cruise Control maintains your set cruising speed whenever a vehicle is not detected in front of Model X. When cruising behind a detected vehicle, Traffic-Aware Cruise Control accelerates and decelerates Model X as needed to maintain a chosen following distance (see [Adjust the Following Distance on page 98](#)), up to the set speed.

Traffic-Aware Cruise Control also adjusts the cruising speed when entering and exiting curves.

You can manually accelerate at any time when cruising at a set speed, but when you release the accelerator, Traffic-Aware Cruise Control resumes cruising at the set speed.

NOTE: When Traffic-Aware Cruise Control is actively slowing down Model X to maintain the selected distance from the vehicle ahead, brake lights turn on to alert other road users that you are slowing down. You may notice slight movement of the brake pedal. However, when Traffic-Aware Cruise Control is accelerating Model X, the accelerator pedal does not move.

⚠ WARNING: Traffic-Aware Cruise Control may occasionally cause Model X to brake when not required or when you are not expecting it. This can be caused by closely following a vehicle ahead, detecting vehicles or objects in adjacent lanes (especially on curves), etc.

⚠ WARNING: Due to limitations inherent in the onboard GPS (Global Positioning System), you may experience situations in which Model X slows down, especially near exits or off-ramps where a curve is detected and/or you are navigating to a destination and not following the route.



Traffic-Aware Cruise Control

⚠ WARNING: Traffic-Aware Cruise Control may not detect all objects and, especially when cruising over 50 mph (80 km/h), may not brake/decelerate when a vehicle or object is only partially in the driving lane or when a vehicle you are following moves out of your driving path and a stationary or slow-moving vehicle or object is in front of you. Always pay attention to the road ahead and stay prepared to take immediate corrective action. Depending on Traffic-Aware Cruise Control to avoid a collision can result in serious injury or death. In addition, Traffic-Aware Cruise Control may react to vehicles or objects that either do not exist, or are not in your lane of travel, causing Model X to slow down unnecessarily or inappropriately.

⚠ WARNING: Traffic-Aware Cruise Control may be unable to provide adequate speed control because of limited braking capability and hills. It can also misjudge the distance from a vehicle ahead. Driving downhill can increase driving speed, causing Model X to exceed your set speed (and potentially the road's speed limit). Never depend on Traffic-Aware Cruise Control to slow down Model X enough to prevent a collision. Always keep your eyes on the road when driving and be prepared to take corrective action as needed. Depending on Traffic-Aware Cruise Control to reduce your driving speed enough to prevent a collision can result in serious injury or death.

HOLD State

When following a vehicle, Traffic-Aware Cruise Control remains active at low speeds, even when Model X comes to a full stop. When the vehicle is moving again, Traffic-Aware Cruise Control resumes operating at the set speed. However, under the following circumstances, Traffic-Aware Cruise Control goes into a **HOLD** state, in which case, you need to briefly press the accelerator pedal or pull the Autopilot stalk toward you (see [Canceling and Resuming on page 99](#)) to resume cruising. When the **HOLD** status is active, the instrument panel displays the **HOLD** icon and a message that indicates that you need to resume cruise control. The following circumstances can cause Traffic-Aware Cruise Control to go into the **HOLD** state:

- Model X has been at a standstill for 5 minutes.
- Model X detects a pedestrian (the **HOLD** state may clear when the pedestrian is no longer detected).
- Model X suddenly loses visibility of the vehicle in front of you.
- An obstacle is detected in front of Model X.

Cruising Near or On Exits

When cruising near an exit on a controlled-access highway and engaging the turn signal toward the off-ramp, Traffic-Aware Cruise Control assumes you are exiting and begins to slow down Model X. If you do not drive onto the off-ramp, Traffic-Aware Cruise Control resumes cruising at the set speed. In a region with right hand traffic, this occurs only when you engage the right turn signal when driving in the right-most lane within 164 feet (50 meters) of an exit. Likewise in regions with left hand traffic; when engaging the left turn signal when driving in the left-most lane within 164 feet (50 meters) of an exit.

When cruising onto an on-ramp to a controlled-access highway, Traffic-Aware Cruise Control automatically adjusts the set cruising speed to the speed limit of the highway, plus any offset you have specified.

NOTE: The on-board Global Positioning System (GPS) determines if you are driving in a region with right or left hand traffic. In situations where GPS data is unavailable (for example, if there is inadequate signal), engaging the turn signal near an exit does not cause Traffic-Aware Cruise Control to slow down Model X.

When enabled while on a highway interchange or off-ramp, Traffic-Aware Cruise Control may reduce your set speed in 5 mph (5 km/h) increments - to as slow as 25 mph (40 km/h) - to better match the reported speeds of other Tesla vehicles that have driven at that specific location. To override this and continue cruising at your set speed, tap the accelerator pedal or move the Autopilot stalk. The new set speed is maintained for the duration of the interchange or off-ramp (unless you override it or cancel Traffic-Aware Cruise Control). After the interchange or off-ramp, the set speed may revert or change as necessary based on the new location. For example, if you merged onto a different highway, the set cruising speed reverts back to what it was before driving on the interchange.

⚠ WARNING: In some cases (such as having insufficient data), Traffic-Aware Cruise Control may not automatically reduce the set speed on the highway interchange or off-ramp. Do not rely on Traffic-Aware Cruise Control to determine an appropriate driving speed. Tesla recommends driving at a speed that is safe for road conditions and within posted speed limits.

Adjust the Following Distance

To adjust the following distance you want to maintain between Model X and a vehicle traveling ahead of you, rotate the Autopilot stalk. Choose a setting from 1 (the closest following distance) to 7 (the longest following distance). Each setting corresponds to a time-based distance that represents how long it takes for Model X, from its current location, to reach the location of the rear bumper of the vehicle ahead of you.



As you rotate the Autopilot stalk, the instrument panel displays the current setting. Release the stalk when the desired setting is displayed.



NOTE: Your setting is retained until you manually change it.

- ⚠ WARNING:** It is the driver's responsibility to determine and maintain a safe following distance at all times. Do not rely on Traffic-Aware Cruise Control to maintain an accurate or appropriate following distance.
- ⚠ WARNING:** Never depend on Traffic-Aware Cruise Control to adequately slow down Model X to avoid a collision. Always watch the road in front of you and stay prepared to take immediate corrective action.

Overtake Acceleration

When following a vehicle with Traffic-Aware Cruise Control active, engaging the turn signal (to indicate a move into the passing lane) accelerates Model X towards the vehicle ahead. By momentarily holding the turn signal stalk up or down, you can quickly accelerate up to your set speed without having to press the accelerator pedal. The turn signal causes acceleration only when all of the following conditions are met:

- Traffic-Aware Cruise Control is operating and detects a vehicle in front of you.
- No obstacles or vehicles are detected in the target lane.
- Model X is traveling below the set speed, but over 45 mph (72 km/h).

Overtake Acceleration is intended as an aid when passing a vehicle ahead of you. When the turn signal is engaged, Traffic-Aware Cruise Control continues to maintain distance from the vehicle ahead, but allows you to drive slightly closer than your selected distance.

Acceleration cancels when one of the conditions happen:

- You reach your set cruising speed.
 - Changing lanes takes too long.
 - Model X gets too close to the vehicle ahead.
- OR
- You disengage the turn signal.

NOTE: Overtake Acceleration occurs when you fully engage the turn signal, or you . When you release the turn signal, Model X stops accelerating (in the same way as when you release the accelerator pedal) and resumes the set speed.

- ⚠ WARNING:** Overtake Acceleration can cancel for many unforeseen reasons in addition to those listed above (for example, lack of GPS data). Stay alert and never depend on Overtake Acceleration to increase your driving speed.
- ⚠ WARNING:** Overtake Acceleration increases your driving speed whenever the appropriate turn signal is engaged, and accelerates Model X closer to the vehicle ahead. Although Traffic-Aware Cruise Control continues to maintain distance from the vehicle ahead, it is important to be aware that your selected following distance is reduced when Overtake Acceleration is active, particularly in cases where it may not be your intention to overtake the vehicle you are following.

Canceling and Resuming

To manually cancel Traffic-Aware Cruise Control, press the brake pedal or briefly push the Autopilot stalk away from you. The cruising speed icon on the instrument panel turns gray to indicate that Traffic-Aware Cruise Control is no longer active.



To resume cruising at the previously set speed, briefly pull the Autopilot stalk toward you.



Traffic-Aware Cruise Control

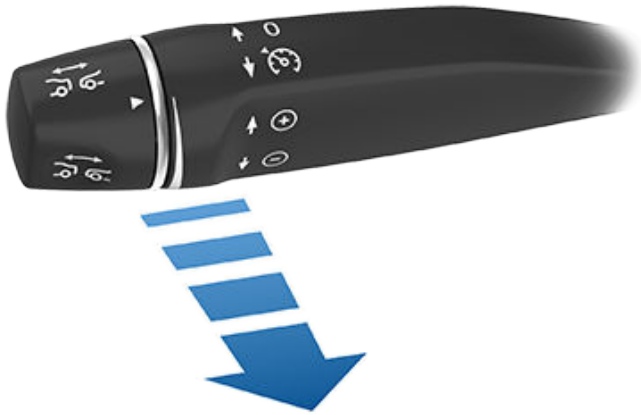

To resume cruising at the current driving speed, move the Autopilot stalk up or down, then release.

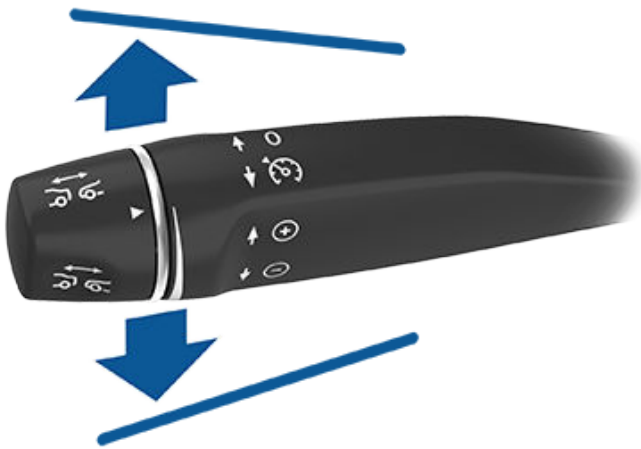

NOTE: When Traffic-Aware Cruise Control cancels, Model X does not coast. Instead, regenerative braking slows down Model X in the same way as when you move your foot off the accelerator when driving without Traffic-Aware Cruise Control (see [Regenerative Braking on page 68](#)).

WARNING: Traffic-Aware Cruise Control cancels, or may not be available, in the following situations:

- You press the brake pedal.
- Your driving speed exceeds the maximum cruising speed of 90 mph (150 km/h).
- You shift Model X.
- A door is opened.
- A camera or sensor is obstructed. This could be caused by dirt, mud, ice, snow, fog, etc.
- The traction control setting is manually disabled or is repeatedly engaging to prevent wheels from slipping.
- The wheels are spinning while at a standstill.
- The Traffic-Aware Cruise Control system is failing or requires service.

When Traffic-Aware Cruise Control is unavailable or cancels, Model X no longer drives consistently at a set speed and no longer maintains a specified distance from the vehicle ahead.

WARNING: Traffic-Aware Cruise Control can cancel unexpectedly at any time for unforeseen reasons. Always watch the road in front of you and stay prepared to take appropriate action. It is the driver's responsibility to be in control of Model X at all times.

Summary of Cruise Indicators



Traffic-Aware Cruise Control is available but is not actively controlling your speed until you activate it. The number shown in gray is the cruising speed that will be set when you engage Traffic-Aware Cruise Control.



Traffic-Aware Cruise Control is actively cruising and is either maintaining the set speed (no vehicle in front) or is maintaining a chosen following distance from a vehicle ahead (up to the set speed).



Model X has fully stopped but is in a **HOLD** state. If safe, press the accelerator pedal to resume cruising at the set speed.

Limitations

Traffic-Aware Cruise Control is particularly unlikely to operate as intended in the following types of situations:

- The road has sharp curves.
- Visibility is poor (due to heavy rain, snow, fog, etc.).
- Bright light (such as from oncoming headlights or direct sunlight) is interfering with the view of the camera(s).
- A camera or sensor is obstructed (fogged over, dirty, covered by a sticker, etc.).

WARNING: The list above does not represent an exhaustive list of situations that may interfere with proper operation of Traffic-Aware Cruise Control.

NOTE: Depending on market region, vehicle configuration, options purchased, and software version, your vehicle may not be equipped with Autosteer, or the feature may not operate exactly as described.

NOTE: Autosteer is a BETA feature.

Autosteer builds upon Traffic-Aware Cruise Control (see [Traffic-Aware Cruise Control on page 96](#)), intelligently keeping Model X in its driving lane when cruising at a set speed. Autosteer also allows you to use the turn signals to move Model X into an adjacent lane (see [Auto Lane Change on page 103](#)). Autosteer detects lane markings and the presence of vehicles and objects to steer Model X.

NOTE: To display more details about the roadway and its surroundings, such as road markings, stop lights, objects (such as trash cans and poles), etc., touch **Controls** > **Autopilot** > **Full Self-Driving Visualization Preview** (if equipped).

 **CAUTION:** Ensure all cameras and sensors are clean. Dirty cameras and sensors, as well as environmental conditions such as rain and faded lane markings, affect performance.

 **WARNING:** Autosteer is a hands-on feature. You must keep your hands on the steering wheel at all times.

 **WARNING:** Autosteer is intended for use on controlled-access highways with a fully attentive driver. When using Autosteer, hold the steering wheel and be mindful of road conditions and surrounding traffic. Do not use Autosteer in construction zones, or in areas where bicyclists or pedestrians may be present. Never depend on Autosteer to determine an appropriate driving path. Always be prepared to take immediate action. Failure to follow these instructions could cause damage, serious injury or death.

Operating Autosteer

Before you can operate Autosteer, you must enable it by touching **Controls** > **Autopilot** > **Autosteer (Beta)**.



To indicate that Autosteer is available (but not actively steering Model X), the instrument panel displays a gray Autosteer icon.

To initiate Autosteer, pull the Autopilot stalk toward you twice in quick succession.

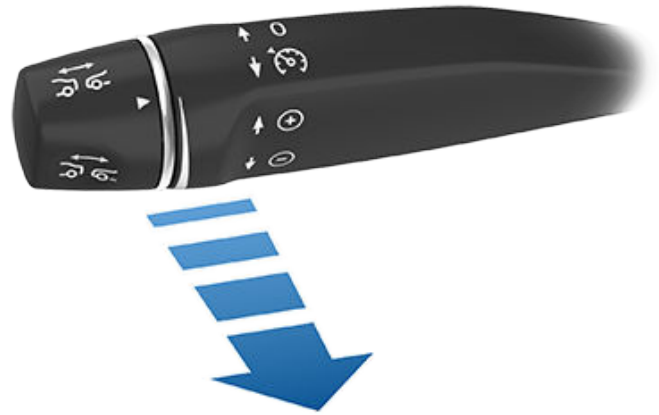



To indicate that Autosteer is now actively steering Model X, the instrument panel displays the Autosteer icon in blue. When Autosteer is able to detect lane markings, it also displays the driving lane in blue.

Autosteer briefly displays a message on the instrument panel reminding you to pay attention to the road and be ready to take over at any time.

The speed at which you can initiate Autosteer can vary depending on various conditions and whether or not a vehicle is detected ahead of you. When no vehicle is detected ahead of you, you must be driving at least 18 mph (30 km/h), unless certain vehicle and environmental conditions are met, in which case, you may be able to initiate it at lower speeds. When a vehicle is detected ahead of you, you can initiate Autosteer at any speed, even when stationary, provided Model X is at least 5 feet (150 cm) behind the detected vehicle.

NOTE: The maximum cruising speed is 90 mph (150 km/h). It is the driver's responsibility to cruise at a safe speed based on road conditions and speed limits.

 **CAUTION:** If available in your market region, Model X detects lights from an emergency vehicle when using Autosteer at night on a high speed road, the driving speed is automatically reduced and the instrument panel displays a message informing you of the slowdown. You will also hear a chime and see a reminder to keep your hands on the steering wheel. When the light detections pass by or cease to appear, Autopilot resumes your cruising speed. Alternatively, you may tap the accelerator to resume your cruising speed.

 **WARNING:** Never depend on Autopilot features to determine the presence of emergency vehicles. Model X may not detect lights from emergency vehicles in all situations. Keep your eyes on your driving path and always be prepared to take immediate action.

In situations where Autosteer is temporarily unavailable, the Autosteer icon disappears. For example, your driving speed is not within the speed required for Autosteer to operate. Autosteer may also be unavailable if it is not receiving adequate data from the camera(s).

If unable to detect lane markings, Autosteer may determine the driving lane based on a vehicle you are following.

In most cases, Autosteer attempts to center Model X in the driving lane. However, there may be situations in which Autosteer may steer Model X in a driving path that is offset from the center of the lane (for example, detection of guard rails).

 **WARNING:** Autosteer is not designed to, and will not, steer Model X around objects partially in a driving lane and in some cases, may not stop for objects that are completely blocking the driving lane. Always watch the road in front of you and stay prepared to take immediate action. It is the driver's responsibility to be in control of Model X at all times.

Restricted Speed

On a controlled-access highway, the cruising speed reflects the speed limit, taking into consideration any offset you've specified using Speed Assist. However, if you choose to use Autosteer on residential roads, a road without a center divider, or a road where access is not limited, Autosteer may limit the maximum allowed cruising speed and the instrument panel displays a message indicating that speed is restricted. The restricted speed will be the speed limit of the road plus 5 mph (10 km/h).

In situations where the speed limit cannot be detected when Autosteer is engaged, Autosteer reduces your driving speed and limits the set cruising speed to 45 mph (70 km/h). Although you can manually accelerate to exceed the limited speed, Model X may not brake for detected obstacles. Autosteer slows down to the limited speed when you release the accelerator pedal. When you leave the road, or disengage Autosteer by using the steering wheel, you can increase your set speed again, if desired.

Hold Steering Wheel

Autosteer determines how best to steer Model X. When active, Autosteer requires you to hold the steering wheel. If it does not detect your hands on the steering wheel for a period of time, a flashing light appears along the top of the instrument panel and the following message displays:



Apply slight turning force to steering wheel

Autosteer detects your hands by recognizing slight resistance as the steering wheel turns, or from you manually turning the steering wheel very lightly (without enough force to take over steering). Autosteer also qualifies your hands as being detected if you engage a turn signal use the Autopilot stalk, or use a button or scroll wheel on the steering wheel.

NOTE: When your hands are detected, the message disappears and Autosteer resumes normal operation.

Autosteer requires that you pay attention to your surroundings and remain prepared to take control at any time. If Autosteer still does not detect your hands on the steering wheel, the flashing light on the instrument panel increases in frequency and a chime sounds.

If you repeatedly ignore Autosteer's prompts to apply slight force to the steering wheel, Autosteer disables for the rest of the drive and displays the following message requesting you to drive manually. If you don't resume manual steering, Autosteer sounds a continuous chime, turns on the warning flashers, and slows the vehicle to a complete stop.



Autosteer unavailable for the rest of this drive. Hold steering wheel to drive manually.

For the rest of the drive, you must steer manually. Autosteer is available again on your next drive (after you stop and shift Model X into Park).

Take Over Immediately

In situations where Autosteer is unable to steer Model X, Autosteer sounds a warning chime and displays the following message on the instrument panel:



Take over immediately

When you see this message, **TAKE OVER STEERING IMMEDIATELY.**

Canceling Autosteer

Autosteer cancels when:

- You press the brake pedal.
- You start steering manually.
- You push the Autopilot stalk away from you.
- You exceed the maximum speed at which Autosteer operates – 90 mph (150 km/h).
- You shift.
- A door is opened.
- An Automatic Emergency Braking event occurs (see [Collision Avoidance Assist on page 127](#)).

When Autosteer cancels, it sounds a chime and the Autosteer icon either turns gray to indicate that Autosteer is no longer active, or disappears to indicate that it is not currently available.





NOTE: If Autosteer cancels because you started steering manually, Traffic-Aware Cruise Control remains active. Disengage Traffic-Aware Cruise Control as you normally would, by pressing the brake pedal or briefly pushing the Autopilot stalk away from you or.

To disable Autosteer so it is no longer available, touch **Controls > Autopilot > Autosteer (Beta)**.

Auto Lane Change

NOTE: Depending on market region, vehicle configuration, options purchased, and software version, your vehicle may not be equipped with Auto Lane Change, or the feature may not operate exactly as described.

When Autosteer is active, engage a turn signal to move Model X into an adjacent lane (moving the steering wheel would cancel Autosteer).

-  **WARNING:** It is the driver's responsibility to determine whether a lane change is safe and appropriate. Therefore, before initiating a lane change, always check blind spots, lane markings, and the surrounding roadway to confirm it is safe and appropriate to move into the target lane.
-  **WARNING:** Never depend on Auto Lane Change to determine an appropriate driving path. Drive attentively by watching the road and traffic ahead of you, checking the surrounding area, and monitoring the instrument panel for warnings. Always be prepared to take immediate action.
-  **WARNING:** Do not use Auto Lane Change on roads where traffic conditions are constantly changing and where bicycles and pedestrians are present.
-  **WARNING:** The performance of Auto Lane Change depends on the ability of the camera(s) to recognize lane markings.

 **WARNING:** Do not use Auto Lane Change on winding roads with sharp curves, on icy or slippery roads, or when weather conditions (such as heavy rain, snow, fog, etc.) may be obstructing the view from the camera(s) or sensors.

 **WARNING:** Failure to follow all warnings and instructions can result in property damage, serious injury or death.

Operating Auto Lane Change

Auto Lane Change is available whenever Autosteer is active. To change lanes using Auto Lane Change:

1. Perform visual checks to make sure it is safe and appropriate to move into the target lane.
2. Engage the appropriate turn signal, keeping your hands on the steering wheel.
3. If needed, cancel the turn signal once you are in the target lane.

NOTE: The minimum speed at which Auto Lane Change operates may vary depending on region, adjacent lane speeds, and other factors. Always be ready to manually steer and change lanes as necessary.

Auto Lane Change moves Model X into the adjacent lane in the direction indicated by the turn signal, provided the following conditions are met:

- The turn signal is engaged.
- Model X does not detect a vehicle in its blind spot, or a vehicle or obstacle up to the center of the target lane.
- Lane markings indicate that a lane change is permitted.
- Midway through the lane change, Model X must detect the target lane's outside lane marking. If this lane marking is not detected, the lane change is aborted and Model X returns to its original driving lane.
- The view of the camera(s) is not obstructed.

When an automatic lane change is in progress, Overtake Acceleration is activated, allowing Model X to accelerate closer to a vehicle in front (see [Overtake Acceleration on page 99](#)).

NOTE: Auto Lane Change moves Model X one lane at a time. Moving into an additional lane requires you to engage the turn signal a second time after the first lane change is complete.

When using Auto Lane Change, it is important to monitor its performance by watching the driving path in front of you and the surrounding area. Stay prepared to take over steering at any time. As you are crossing over into the adjacent lane, the instrument panel displays the location in the lane that Model X is moving into.

In situations where Auto Lane Change is unable to operate at optimal performance, or cannot operate due to inadequate data, the instrument panel displays a series of warnings. Therefore, when using Auto Lane Change, always pay attention to the instrument panel and be prepared to manually steer Model X.

Adjacent Lane Speed

NOTE: Depending on market region, vehicle configuration, options purchased, and software version, your vehicle may not be equipped with Adjacent Lane Speed, or the feature may not operate exactly as described.

When moving significantly faster than vehicles in adjacent lanes, Model X automatically reduces the driving speed. This is especially helpful in heavy traffic situations or when vehicles are constantly merging into different lanes. When Model X detects other vehicles driving significantly slower, the instrument panel highlights the adjacent lanes with arrows and detected vehicles in gray, and Model X reduces the driving speed as appropriate. To temporarily override this feature, press the accelerator pedal.

 **WARNING:** Never depend on Autopilot to determine a safe driving speed; you are responsible for driving safely and according to traffic laws in your market region.

Stop Light and Stop Sign Warning

NOTE: Depending on market region, vehicle configuration, options purchased, and software version, your vehicle may not be equipped with Stop Light and Stop Sign Warning, or the feature may not operate exactly as described.

While Autosteer is in use, Model X displays a warning on the instrument panel and sounds a chime if it detects that you are likely to run through a red stop light or stop sign. If this happens, **TAKE IMMEDIATE CORRECTIVE ACTION!**

The visual and audible warnings cancel after a few seconds, or when you press the brake pedal, whichever comes first.

Stop Light and Stop Sign Warning provides warnings only. It does not slow down or stop Model X at red traffic lights, stop signs, road markings, etc. If equipped with Traffic Light and Stop Sign Control, you can enable this feature to automatically stop Model X at traffic lights and stop signs (see [Traffic Light and Stop Sign Control on page 109](#)).

NOTE: Touch **Controls > Autopilot > Full Self-Driving Visualization Preview** (if equipped) to display more details about the roadway and its surroundings, such as road markings, stop lights, objects (such as trash cans and poles), etc.

 **CAUTION:** Stop Light and Stop Sign Warning requires on-board maps to know that a particular stop light or stop sign exists at a location. In some cases, map data is inaccurate or outdated and may not include all stop lights or stop signs. Therefore, Stop Light and Stop Sign Warning may not detect all stop lights and stop signs.

 **WARNING:** The Stop Light and Stop Sign Warning feature does not apply the brakes or decelerate Model X and may not detect all stop lights and stop signs. Stop Light and Stop Sign Warning is designed for guidance purposes only and is not a substitute for attentive driving and sound judgment. Keep your eyes on the road when driving and never depend on Stop Light and Stop Sign Warning to warn you of a stop light or stop sign.

 **WARNING:** Stop Light and Stop Sign Warning is designed to warn you only when approaching a visible red stop sign, solid red or later portion of a yellow traffic light. It may not warn you of intersections with flashing lights and it does not warn you of yield signs or temporary stop and yield signs (such as those used in construction areas). Additionally, Stop Light and Stop Sign Warning does not warn you of approaching stop lights or stop signs when you are pressing the accelerator pedal or brake pedal (which disables Autosteer).

Limitations

Autosteer and its associated functions are particularly unlikely to operate as intended when:

- Autosteer is unable to accurately determine lane markings. For example, lane markings are excessively worn, have visible previous markings, have been adjusted due to road construction, are changing quickly (lanes branching off, crossing over, or merging), objects or landscape features are casting strong shadows on the lane markings, or the road surface contains pavement seams or other high-contrast lines.
- Visibility is poor (heavy rain, snow, fog, etc.) or weather conditions are interfering with sensor operation.
- A camera(s) or sensor(s) is obstructed, covered, or damaged.
- Driving on hills.
- Approaching a toll booth.
- Driving on a road that has sharp curves or is excessively rough.
- Bright light (such as direct sunlight) is interfering with the view of the camera(s).
- The sensors are affected by other electrical equipment or devices that generate ultrasonic waves.

- A vehicle is detected in your blind spot when you engage the turn signal.
- Model X is being driven very close to a vehicle in front of it, which is blocking the view of the camera(s).

 **WARNING:** Many unforeseen circumstances can impair the operation of Autosteer. Always keep this in mind and remember that as a result, Autosteer may not steer Model X appropriately. Always drive attentively and be prepared to take immediate action.



Navigate on Autopilot

NOTE: Depending on market region, vehicle configuration, options purchased, and software version, your vehicle may not be equipped with Navigate on Autopilot, or the feature may not operate exactly as described.

NOTE: Navigate on Autopilot is a BETA feature.

When using Autosteer on a controlled-access highway (a main highway on which road users enter and exit using on-ramps and off-ramps). Navigate on Autopilot guides Model X to off-ramps and interchanges based on your navigation route. Along the highway portion of a navigation route, Navigate on Autopilot also changes lanes to prepare for exits (route-based lane changes) and to minimize the driving time to your destination (speed-based lane changes).

⚠ WARNING: Navigate on Autopilot does not make driving autonomous. You must pay attention to the road, keep your hands on the steering wheel at all times, and remain aware of your navigation route.

⚠ WARNING: As is the case with normal driving, be extra careful around blind corners, interchanges, and on-ramps and off-ramps - obstacles can appear quickly and at any time.

⚠ WARNING: Navigate on Autopilot may not recognize or detect oncoming vehicles, stationary objects, and special-use lanes such as those used exclusively for bikes, carpools, emergency vehicles, etc. Remain alert at all times and be prepared to take immediate action. Failure to do so can cause damage, injury or death.

Enabling and Customizing Navigate on Autopilot

To enable Navigate on Autopilot, touch **Controls > Autopilot > Navigate on Autopilot (Beta)**. Then, to customize how you want Navigate on Autopilot to operate, touch **Customize Navigate on Autopilot**:

- **Enable At Start Of Every Trip:** Choose whether or not you want to automatically enable Navigate on Autopilot for every navigation route. When enabled, the Navigate on Autopilot button on the turn-by-turn direction list is already enabled at the start of every trip.
- **Speed Based Lane Changes:** Navigate on Autopilot is designed to perform both route-based and speed-based lane changes. Route-based lane changes are designed to keep you on your navigation route (for example, moving you into an adjacent lane to prepare for an upcoming off-ramp) whereas speed-based lane changes are designed to maintain a driving speed (not to exceed your cruising speed) that allows you to minimize the time it takes to reach your destination (for example, moving into an adjacent lane to pass a vehicle in front of you). Speed-based lanes changes are optional. You can use this setting to disable speed-based lane changes or to specify how aggressively you want Navigate on Autopilot to

change lanes to achieve the set cruising speed. The **Mild** setting is more conservative about lane changes and may result in a slightly longer driving time whereas **Mad Max** is designed to allow you to reach your destination in the shortest driving time possible, but changes lanes only when safe to do so.

- **Exit Passing Lane:** Choose whether you want Navigate on Autopilot to maneuver out of a passing lane when navigating to a destination.

NOTE: In addition to route-based and speed-based lane changes, Navigate on Autopilot requests a lane change out of a passing lane as a reminder to stay in a slower lane when you are not passing other vehicles. Choose **NO** to disable this and keep Model X in a passing lane except when needed to stay on the navigation route.

- **Require Lane Change Confirmation** (if equipped): By default, Navigate on Autopilot requires your confirmation before proceeding with a lane change by pulling the Autopilot stalk toward you or engaging the appropriate turn signal. However, if you want Navigate on Autopilot to change lanes without requiring this confirmation, turn this setting off. When you turn the setting off, you can specify if or how you want to be notified of lane changes (**Off**, **Chime**, **Vibrate**, or **Both**).

⚠ WARNING: If you turn off **Require Lane Change Confirmation**, Navigate on Autopilot notifies you of upcoming lane changes and off-ramps, but it remains your responsibility to monitor the environment and maintain control of Model X at all times. Lane changes can occur quickly and suddenly. Always keep your hands on the wheel and your eyes on the driving path in front of you.

NOTE: The touchscreen displays route-based lane changes at the top of the map's turn-by-turn direction list to notify you that an upcoming lane change is needed to stay on the navigation route.

Operating Navigate on Autopilot

Once enabled, the Navigate on Autopilot button appears on the map's turn-by-turn direction list whenever a navigation route is active and the route includes at least one controlled-access highway. When enabled, the Navigate on Autopilot button is blue and the turn-by-turn direction displays the Autosteer icon next to the maneuvers (such as off-ramps) that Navigate on Autopilot will handle.

NOTE: If **Enable At Start Of Every Trip** is turned off, you must touch the **Navigate on Autopilot** button to enable it for each navigation route.



Navigate on Autopilot activates and deactivates as appropriate, based on the type of road you are driving on. For example, if Autosteer is active and Navigate on Autopilot is enabled, Navigate on Autopilot automatically becomes active when you reach a controlled-access highway on your navigation route.

Whenever Navigate on Autopilot is active, the instrument panel displays the driving lane as a single blue line in front of Model X:

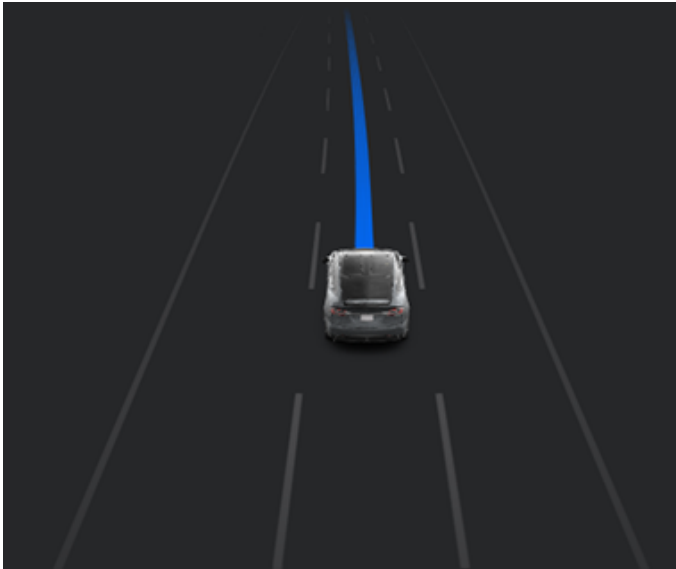

When Navigate on Autopilot is active and you approach an off-ramp or interchange along your navigation route, the appropriate turn signal engages and Autosteer maneuvers Model X onto the off-ramp or interchange.

WARNING: Never depend on Navigate on Autopilot to determine an appropriate lane at an off-ramp. Stay alert and perform visual checks to ensure that the driving lane is safe and appropriate.

When you leave a controlled-access highway (for example, you take an exit or you enter a section of the navigation route that is no longer supported), Navigate on Autopilot reverts back to Autosteer— a chime sounds and the instrument panel displays the driving lane lines in blue (instead of the single blue in front of Model X).

NOTE: When determining navigation routes, and maneuvers at interchanges, Navigate on Autopilot considers whether or not you want to use High Occupancy Vehicle (HOV) lanes. Therefore, ensure the **Use HOV Lanes** setting is appropriate for your circumstances (see [Maps and Navigation on page 143](#)). If the setting is off, Navigate on Autopilot never uses a HOV lane, regardless of time of day. If the setting is on, Navigate on Autopilot uses HOV lanes, whenever applicable.

WARNING: When Navigate on Autopilot deactivates, Autosteer remains active. Always be prepared to take appropriate action.

WARNING: Navigate on Autopilot may not always attempt to exit at an off-ramp or change lanes, even when an exit or lane change is determined by the navigation route. Always remain alert and be prepared to manually steer onto an off-ramp, or make a lane change to prepare for, or to exit at, an off-ramp or interchange.

You can cancel Navigate on Autopilot at any time by touching **Navigate on Autopilot** on the map's turn-by-turn direction list (Model X reverts back to Autosteer), or by canceling Autosteer entirely (see [Canceling Autosteer on page 102](#)).

Lane Changes

Navigate on Autopilot changes lanes to either prepare Model X for an upcoming off-ramp, to increase your driving speed (not to exceed your set cruising speed), or to move Model X out of a passing lane when you are not actively passing other road users. A message displays at the top of the map's turn-by-turn direction list to notify you when an upcoming lane change is required to stay on your navigation route. The instrument panel displays the upcoming driving path:



If **Require Lane Change Confirmation** is turned off, Navigate on Autopilot engages the appropriate turn signal, checks for vehicles and objects, and when appropriate, maneuvers Model X into the adjacent lane.

If **Require Lane Change Confirmation** is turned on, you must engage the appropriate turn signal or pull the Autopilot stalk toward you to confirm that you want Navigate on Autopilot to proceed with the lane change. If you do not confirm the lane change within three seconds, a chime sounds to remind you that Navigate on Autopilot requires your confirmation to change lanes.

NOTE: If you ignore a route-based lane change suggestion (for example, you are driving in the left lane while approaching an off-ramp on the right side of the highway), Navigate on Autopilot is unable to maneuver onto the off-ramp and as a result, you are re-routed to your destination.



Navigate on Autopilot

⚠ WARNING: Navigate on Autopilot may not always attempt to exit at an off-ramp or change lanes, even when an exit or lane change is determined by the navigation route. Always remain alert and be prepared to manually steer onto an off-ramp, or make a lane change to prepare for, or to exit at, an off-ramp or interchange.

Be Ready to Assist

When attempting to change lanes or maneuver Model X, or when approaching construction zones, Navigate on Autopilot may be unable to determine the appropriate driving lane (for example, complex clover leafs and multi-lane off-ramps) and the instrument panel displays an alert indicating that Navigate on Autopilot is trying to maneuver and may require assistance. When you see the message, be prepared to take immediate action to ensure that it is safe and appropriate to complete the lane change or maneuver.



NOTE: Depending on market region, vehicle configuration, options purchased, and software version, your vehicle may not be equipped with Traffic Light and Stop Sign Control, or the feature may not operate exactly as described.

NOTE: Traffic Light and Stop Sign Control is a BETA feature and works best on roads that are frequently driven by Tesla vehicles. Traffic Light and Stop Sign Control attempts to stop at all traffic lights and may also stop at green lights.

Traffic Light and Stop Sign Control is designed to recognize and respond to traffic lights and stop signs, slowing Model X to a stop when using Traffic-Aware cruise control or Autosteer. This feature uses the vehicle's forward-facing cameras, in addition to GPS data, and slows the car for all detected traffic lights, including green, blinking yellow, and off lights in addition to stop signs and some road markings. As Model X approaches an intersection, the instrument panel displays a notification indicating the intention to slow down. You must confirm that you want to continue or Model X stops at the red line displayed on the instrument panel's driving visualization.

 **WARNING: NEVER** make assumptions and predict when and where Traffic Light and Stop Sign Control will stop or continue through an intersection or road marking. From a driver's perspective, the behavior of Traffic Light and Stop Sign Control may appear inconsistent. Always pay attention to the roadway and be prepared to take immediate action. It is the driver's responsibility to determine whether to stop or continue through an intersection. Never depend on Traffic Light and Stop Sign Control to determine when it is safe and/or appropriate to stop or continue through an intersection.

Before Using

Before using Traffic Light and Stop Sign Control, you must:

- Ensure that forward-facing cameras are unobstructed (see [Cleaning Cameras and Sensors on page 95](#)) and calibrated (see [Drive to Calibrate Cameras on page 94](#)). Traffic Light and Stop Sign Control depends on the ability of the cameras to detect traffic lights, stop signs, and road markings.
- Ensure that the latest version of maps has been downloaded to Model X. Although Traffic Light and Stop Sign Control primarily uses visual data received from the vehicle's cameras, greater accuracy is achieved when using the most recent map data. To check which version of maps is currently downloaded, touch **Controls > Software > Additional vehicle information**. You must connect to a Wi-Fi network to receive updated maps (see [Map Updates on page 147](#)).

- Enable the feature. With the vehicle in Park, touch **Controls > Autopilot > Traffic Light and Stop Sign Control**. Once enabled, Traffic Light and Stop Sign Control operates whenever Traffic-Aware Cruise Control or Autosteer is active.

How it Works

When Traffic Light and Stop Sign Control is enabled and you are using Autosteer or Traffic-Aware Cruise Control, the instrument panel displays a popup message to inform you that an upcoming traffic light, stop sign, or road marking has been detected. As it approaches the stop location, **even at an intersection where the traffic light is green**, Model X slows down and displays a red line to indicate where Model X will stop. To continue through the intersection—even if the traffic light is green—you must pull the Autopilot stalk toward you or briefly press the accelerator pedal to give the vehicle permission to proceed. When you've confirmed that you want to proceed, the red stop line turns gray and Model X continues through the intersection and resumes your set cruising speed.

NOTE: If Model X is approaching a green light and detects that a vehicle in front of you is continuing through the intersection, Model X continues through the intersection without requiring your confirmation, provided you are not in a turning lane and your hands are detected on the steering wheel.

NOTE: If, after you pull the Autopilot stalk toward you or briefly press the accelerator pedal to confirm that you want to continue through the intersection, the traffic signal changes before you enter the intersection (for example, the light changes from green to yellow or from yellow to red), Model X may determine that it is not appropriate to proceed. Therefore, Model X stops and you must press the accelerator to proceed. At all times, it is your responsibility to ensure the vehicle stops or accelerates appropriately and safely.

 **WARNING:** Traffic Light and Stop Sign Control DOES NOT turn Model X through an intersection. When in a turning lane, Model X stops at the red stop line. To proceed, pull the Autopilot stalk toward you or briefly press the accelerator pedal—Model X continues *straight* through the intersection (even when in a turning lane), so you MUST manually steer Model X through the intersection (which cancels Autosteer).

Traffic Light and Stop Sign Control is designed to operate as described only when the following conditions are met:

- Autosteer or Traffic-Aware Cruise Control is engaged.
- The cameras can detect an upcoming traffic light, stop sign or road marking (for example, cameras are unobstructed and have a clear line-of-sight to the traffic light, stop sign, or road marking).



Traffic Light and Stop Sign Control

- The instrument panel on Model X is displaying an upcoming traffic light in "bold" format. Model X does not acknowledge traffic lights that the instrument panel shows as faded. If a traffic light is not directly ahead of the camera (for example, it is located at an angle of the camera's view, or located in an adjacent lane) the instrument panel displays it as faded and Model X does not slow down and stop for it.



WARNING: Traffic Light and Stop Sign Control is not a substitute for attentive driving and sound judgment.



WARNING: If the instrument panel is not displaying a red stop line at an upcoming intersection, Model X does not slow down or stop. It is the driver's responsibility to pay attention to upcoming intersections and monitor traffic conditions to determine when and if the vehicle should stop and then to take appropriate action as needed.



WARNING: Never depend on Traffic Light and Stop Sign Control to determine whether to stop at, or proceed through, an intersection. Drive attentively by watching the road and paying attention to the roadway, upcoming intersections, traffic conditions, crosswalks, and other road users. It is always the driver's responsibility to determine whether to stop or proceed. Be prepared to take immediate action. Failure to do so can result in injury or death.



WARNING: In some situations, Traffic Light and Stop Sign Control may inaccurately detect a traffic light or stop sign, causing Model X to slow down unexpectedly. Be prepared to take immediate action at all times.



WARNING: You must pull the Autopilot stalk toward you or briefly press the accelerator pedal to confirm that you want to proceed through an intersection, regardless of the status of the traffic light. If you do not confirm, Model X stops at the red stop line displayed on the instrument panel, even if stopping may be inappropriate. Stopping at a green light may confuse other drivers and may result in a collision, injury or death. Therefore, always pay attention to upcoming intersections and be prepared to manually brake or accelerate in response to surroundings.



WARNING: Never assume that your ability to see a traffic light, stop sign, or road marking (especially at a complex intersection, or an intersection in which a traffic light or sign is partially obstructed, etc.) means that Model X can also see it and respond appropriately.







WARNING: Even the most recent map data does not include all traffic lights and stop signs. Therefore, Traffic Light and Stop Sign Control relies heavily on the ability of the cameras to detect traffic lights, stop signs, road markings, etc. As a result, Model X may ignore an intersection that is blocked from the camera's view (for example, obstructed by a tree or a large vehicle or object, or located near a steep hill or sharp curve).



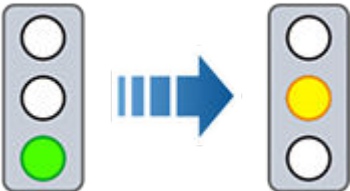

Traffic Lights

When driving with Autosteer or Traffic-Aware Cruise Control engaged, and Traffic Light and Stop Sign Control enabled, Model X is designed to respond as follows when approaching intersections controlled by a traffic light:

Type of Traffic Light	Vehicle Intended Response
 	<p>At a solid green traffic light, or at a traffic light that is currently off (not illuminated), Model X slows down.</p> <p>If you are following a car in front of you that continues through the intersection, the instrument panel displays a green stop line and provided your hands are detected on the steering wheel, Model X also continues. If a car is not in front of you, the instrument panel displays a red stop line and you must confirm that you want to continue through the intersection by pulling the Autopilot stalk toward you or briefly pressing the accelerator pedal. If you don't confirm, Model X stops at the red stop line.</p> <p>NOTE: Model X resumes the set cruising speed when it continues through the intersection, taking into consideration the speed of a vehicle in front of you.</p>
 	<p>Model X slows down and comes to a complete stop at the red stop line displayed on the instrument panel. When you want to continue through the intersection (for example, the light turns green again, or once Model X has come to a complete stop), you must pull the Autopilot stalk toward you or briefly press the accelerator pedal.</p>
	<p>Model X slows down and comes to a complete stop at the red stop line displayed on the instrument panel. When you want to proceed through the intersection (for example, the light turns green again), you must pull the Autopilot stalk toward you or briefly press the accelerator pedal.</p> <p>NOTE: If the traffic light changes <i>after</i> you've confirmed that you want to proceed (for example, a green traffic light turns yellow), Model X may stop instead of continuing, especially if Model X determines that it can safely stop before entering the intersection.</p> <p>NOTE: Model X is not designed to proceed through an intersection when the traffic light is red or if the light turns yellow in situations when there is adequate distance to safely stop before entering the intersection.</p> <p>NOTE: You can take over driving at any time by manually braking to cancel Autosteer or Traffic-aware Cruise Control.</p>



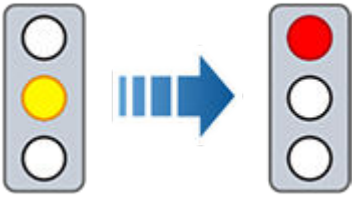
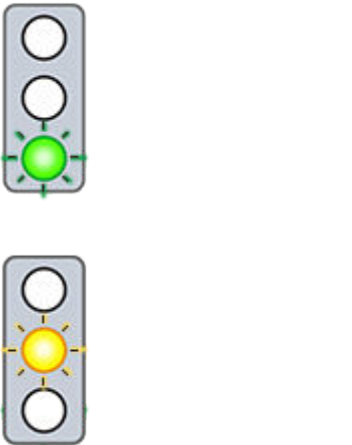

Traffic Light and Stop Sign Control

Type of Traffic Light	Vehicle Intended Response
	
	<p>Model X slows down. To proceed, you must pull the Autopilot stalk toward you or briefly press the accelerator pedal. If you don't, Model X stops at the red stop line displayed on the instrument panel.</p> <p>NOTE: To prevent Model X from stopping, and to minimize how much it slows down as it approaches, you can confirm that you want to proceed by pulling the Autopilot stalk toward you or briefly pressing the accelerator pedal at any time after the instrument panel displays the red stop line. Model X resumes your set cruising speed immediately after you confirm (taking into consideration the speed of a vehicle in front of you).</p> <p>⚠ WARNING: Approach attentively and be prepared to press the brake pedal to slow down or stop.</p>
	<p>Model X slows down and comes to a complete stop at the red stop line displayed on the instrument panel. When you want to proceed through the intersection (for example, traffic laws and conditions indicate it is safe and legal to proceed), you must pull the Autopilot stalk toward you or briefly press the accelerator pedal.</p>



Stop Signs and Road Markings

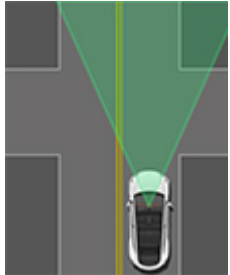
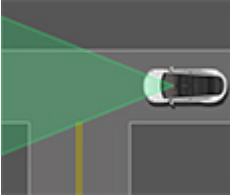
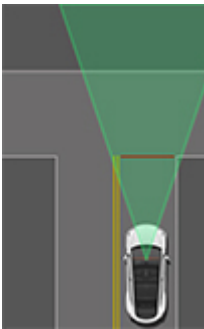

When driving with Autosteer or Traffic-aware Cruise Control engaged, and Traffic Light and Stop Sign Control enabled, Model X is designed to respond as follows when approaching intersections controlled by stop signs, stop lines, or road markings:

Type of Intersection	Vehicle Intended Response
 <p data-bbox="212 747 430 779">No Traffic Control</p>  <p data-bbox="212 1031 430 1062">Arm of T-junction</p>	<p data-bbox="505 443 1485 506">Model X assumes the right of way and continues straight without slowing down or stopping.</p>
 <p data-bbox="217 1461 425 1493">End of T-junction</p>	<p data-bbox="505 1104 1466 1192">If Model X detects a T-junction based on the map data, Model X slows down and comes to a complete stop at the red stop line displayed on the instrument panel. When you want to proceed, you must take over steering and acceleration.</p> <p data-bbox="505 1203 1466 1291">⚠ WARNING: Model X may not stop at a T-junction that does not have a stop sign or stop line, or if the T-junction is not included in the map data. Drive attentively and be prepared to stop (when necessary and/or appropriate).</p>
 <p data-bbox="261 1892 381 1923">Stop Sign</p>	<p data-bbox="505 1535 1511 1623">Model X slows down and comes to a complete stop at the red stop line displayed on the instrument panel. When you want to proceed through the intersection, you must pull the Autopilot stalk toward you or briefly press the accelerator pedal.</p> <p data-bbox="505 1633 1518 1751">NOTE: If you confirm that you want to proceed through an intersection controlled by a stop sign by pulling the Autopilot stalk toward you or briefly pressing the accelerator pedal before Model X has stopped, your confirmation is ignored. Model X is not designed to proceed through a stop sign without stopping.</p> <p data-bbox="505 1761 1498 1850">NOTE: Even when using Autosteer, and even if you have engaged a turn signal, you must turn the steering wheel yourself (which cancels Autosteer) to complete a turn at an intersection.</p>

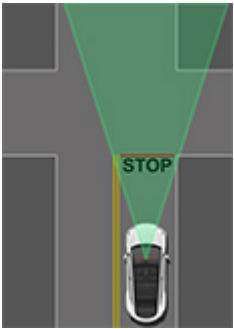

Traffic Light and Stop Sign Control

Type of Intersection	Vehicle Intended Response
 <p data-bbox="103 569 443 596">Stop Sign and Road Marking</p>	
 <p data-bbox="191 978 358 1005">Road Marking</p>	

-  **WARNING:** Model X also slows down and stops at a roundabout. You must take over steering (which cancels Autosteer) and pull the Autopilot stalk toward you or briefly press the accelerator pedal to confirm that you want to continue through the roundabout.
-  **WARNING:** At crosswalks, Model X may slow down and may stop, depending on whether the crosswalk is controlled by a traffic light and whether the cameras detect pedestrians, bicyclists, etc. in the crosswalk. Pay particular attention at crosswalks and be prepared to take over at any time. Failure to do so can result in injury or death.

Limitations

Depending on many different circumstances and environmental conditions, Traffic Light and Stop Sign Control *may* or *may not* stop at:

- Railroad crossings.
- Keep-out zones.
- Toll booths.
- Crosswalk systems.
- Yield signs or temporary traffic lights and stop signs (such as at construction areas).
- Miscellaneous traffic U-turn lights, bicycle and pedestrian crossing lights, lane availability lights, etc.

In addition, Traffic Light and Stop Sign Control is particularly unlikely to operate as intended, can disengage, or may not operate, when one or more of the following conditions are present:

- Driving through consecutive light-controlled intersections that are very close to each other.
- Visibility is poor (heavy rain, snow, fog, etc.) or weather conditions are interfering with camera or sensor operation.





- Bright light (such as direct sunlight) is interfering with the view of the camera(s).
- A camera is obstructed, covered, damaged, or not properly calibrated.
- Driving on a hill or on a road that has sharp curves on which the cameras are unable to see upcoming traffic lights or stop signs.
- A traffic light, stop sign, or road marking is obstructed (for example, a tree, a large vehicle, etc.).
- Model X is being driven very close to a vehicle in front of it, which is blocking the view of a camera.

 **WARNING:** The limitations listed above are not an exhaustive list of reasons why Model X may not operate as expected. Many unforeseen circumstances can adversely impact the accurate operation of Traffic Light and Stop Sign Control. Using this feature does not reduce or eliminate the need to drive attentively and responsibly. You must be prepared to take appropriate and immediate action at all times.

NOTE: Depending on market region, vehicle configuration, options purchased, and software version, your vehicle may not be equipped with Autopark.

Autopark uses data from the cameras and ultrasonic sensors and GPS to simplify parking on public roads by maneuvering Model X into parallel and perpendicular parking spaces.

-  **CAUTION:** Ensure all cameras and sensors are clean. Dirty cameras and sensors, as well as environmental conditions such as rain and faded lane markings, can affect Autopilot performance.
-  **WARNING:** Autopark's performance depends on the ability of the cameras and ultrasonic sensors to determine the vehicle's proximity to curbs, objects, and other vehicles.
-  **WARNING:** Do not use Autopark if anything, such as a ball hitch, bike rack, or trailer, is attached to the tow hitch. Autopark may not stop for hitches when parking between or in front of other vehicles.

Parameters

Autopark detects potential parking spaces based on the following parameters:

Perpendicular Parking

- Your driving speed must be below 8 mph (13 km/h). If driving too fast, Autopark may not be able to accurately detect your desired parking space.
- The parking space must be at least 7.2 feet (2.2 meters) wide.
- The parking space must have at least three visible lines for the vehicle to park into, such as parking lines, road markings, or distinct curbs. Autopark may not work in a garage, for example, without three visible parking lines.
- Autopark may not work with textured road surfaces such as cobblestone or brick.

Parallel Parking

- Your driving speed must be below 13 mph (21 km/h). If driving too fast, Autopark may not be able to accurately detect your desired parking space.
- There must be a vehicle in front of the space you want to park in.
- A distinct curb or edge must be visible. Autopark may not correctly identify the parking space if the curb is not distinct, such as grass or dirt.

NOTE: Autopark does not operate on angled parking spaces.

To Use Autopark

When driving, follow these steps to allow Autopark to maneuver Model X into a parking space:





1. While driving slowly on a public road, monitor the instrument panel to determine when Autopark has detected a parking space. The instrument panel will display a parking icon if the vehicle detects a potential parking spot.



NOTE: The parking icon appears only if the vehicle's position and/or the circumstances of the surrounding area are such that Autopark can determine an appropriate driving path. If Autopark cannot determine an appropriate path (for example, when driving on a narrow street where moving into the parking space causes the front of the vehicle to extend into the adjacent lane), you can either reposition the vehicle, find a different parking space, or park manually.

2. Check to determine if the detected parking space is appropriate and safe. If so, pull forward and stop approximately one car length ahead of the parking space (as you normally would when parallel parking or when backing into a perpendicular parking space).
3. Autopark displays a message when parking is complete.

NOTE: If you press the brake pedal when Autopark is actively parking Model X, the parking process pauses until you touch **Resume** on the touchscreen.

-  **WARNING:** Never depend on Autopark to find a parking space that is legal, suitable, and safe. Autopark may not always detect objects in the parking space. Always perform visual checks to confirm that a parking space is appropriate and safe.
-  **WARNING:** When Autopark is actively steering Model X, the steering wheel moves in accordance with Autopark's adjustments. Do not interfere with the movement of the steering wheel. Doing so cancels Autopark.
-  **WARNING:** During the parking sequence, continually check your surroundings. Be prepared to apply the brakes to avoid vehicles, pedestrians, or objects.
-  **WARNING:** When Autopark is active, monitor the touchscreen and instrument panel to ensure that you are aware of the instructions that Autopark is providing.

To Pause Parking

To pause Autopark, press the brake pedal once. Model X stops and remains stopped until you touch **Resume** on the touchscreen.

To Cancel Parking

Autopark cancels the parking sequence when you manually move the steering wheel, shift, or touch **Cancel** on the touchscreen. Autopark also cancels parking when:

- The parking sequence exceeds seven moves.
- Model X detects that the driver is exiting the vehicle.
- A door is opened.
- You press the accelerator pedal.
- You press the brake pedal while Autopark is paused.
- An Automatic Emergency Braking event occurs (see [Collision Avoidance Assist on page 127](#)).

Limitations

Autopark is particularly unlikely to operate as intended in these situations:

- The road is sloped. Autopark is designed to operate on flat roads only.
- Visibility is poor (due to heavy rain, snow, fog, etc.).
- The curb is constructed of material other than stone, or the curb cannot be detected.
- The target parking space is directly adjacent to a wall or pillar (for example, the last parking space of a row in an underground parking structure).
- One or more of the ultrasonic sensors is damaged, dirty, or obstructed (such as by mud, ice, or snow, or by a vehicle bra, excessive paint, or adhesive products such as wraps, stickers, rubber coating, etc.).
- Weather conditions (heavy rain, snow, fog, or extremely hot or cold temperatures) are interfering with sensor operation.
- The sensors are affected by other electrical equipment or devices that generate ultrasonic waves.







WARNING: Many unforeseen circumstances can impair Autopark's ability to park Model X. Keep this in mind and remember that as a result, Autopark may not steer Model X appropriately. Pay attention when parking Model X and stay prepared to immediately take control.

NOTE: Depending on market region, vehicle configuration, options purchased, and software version, your vehicle may not be equipped with Summon, or the feature may not operate exactly as described.

Summon allows you to automatically park and retrieve Model X while you are standing outside the vehicle. Summon uses data from the ultrasonic sensors to move Model X forward and reverse up to 39 feet (12 meters) in, or out of, a parking space.

To move Model X a longer distance while steering around objects, you can use Smart Summon (if equipped) and your mobile phone. Smart Summon allows your vehicle to find you (or you can send your vehicle to a chosen location). See [Smart Summon on page 121](#).

-  **CAUTION:** Ensure all cameras and sensors are clean. Dirty cameras and sensors, as well as environmental conditions such as rain and faded lane markings, can affect Autopilot performance.
-  **WARNING:** Summon is designed and intended for use only on parking lots and driveways on private property where the surrounding area is familiar and predictable.
-  **WARNING:** Summon is a BETA feature. You must continually monitor the vehicle and its surroundings and stay prepared to take immediate action at any time. It is the driver's responsibility to use Summon safely, responsibly, and as intended.
-  **WARNING:** Summon's performance depends on the ability of the ultrasonic sensors to determine the vehicle's proximity to objects, people, animals, and other vehicles.

Before Using Summon

Before operating Summon, use the touchscreen to enable it and customize how you want it to work. Touch **Controls > Autopilot > Customize Summon** and adjust the following settings to suit your preferences:

- **Bumper Clearance:** Set the distance that you want Summon to stop from a detected object (for example, you may want Summon to stop within just a few inches of a garage wall). Note that this distance applies only to objects that Summon detects directly in front of Model X when moving forward, or directly behind Model X when reversing.
- **Summon Distance:** Set a maximum distance that Model X can travel when entering or exiting a parking space.
- **Side Clearance:** Choose an option to specify how much side clearance you want to allow. **Tight** allows Model X to enter and exit very narrow parking spaces.

 **WARNING:** Parking in a narrow space limits the ability of the sensors to accurately detect the location of obstacles, increasing the risk of damage to Model X and/or surrounding objects.

- **Require Continuous Press:** By default, Summon requires that you press and hold a button on the mobile app to move Model X during the parking process. When **Require Continuous Press** is set to **No**, you can press and release the button—you don't need to hold it down to keep the vehicle moving. Also, when **Require Continuous Press** is set to **No**, you can operate Summon using the key fob instead of the mobile app (see [Operating Summon with the Key Fob on page 119](#)) and you can start a parking sequence from inside the vehicle (see [Starting Summon Before Exiting the Vehicle on page 119](#)).
- **Use Auto HomeLink** (if equipped): Set to **ON** if you want to activate HomeLink to open/close a programmed HomeLink device (such as a gate or a garage door) during the parking process when using Summon. If enabled, the device automatically opens and closes when Model X enters or exits during a Summon session. In a Smart Summon session (if equipped), the device automatically opens when, at the beginning of a session, Smart Summon detects that Model X is parked in a garage.

 **WARNING:** Always ensure that Model X is fully in or out of a garage before HomeLink lowers the garage door. Summon and Smart Summon (if equipped) cannot detect where an overhead door will lower.

NOTE: When enabled, the HomeLink device automatically opens and closes when using Summon, and automatically opens as needed when using Smart Summon (if equipped). To automate HomeLink in other situations (such as normal driving), you must adjust the HomeLink device's main settings by touching the HomeLink icon at the top of the touchscreen (see [HomeLink Universal Transceiver on page 165](#)).

NOTE: The above settings, with the exception of HomeLink, apply only to Summon—not Smart Summon (if equipped) (see [Before Using Smart Summon on page 121](#)). You cannot customize Smart Summon's bumper clearance, distance, and side clearance. And when using Smart Summon, you must always hold down the button on the mobile app to keep Model X moving. Also, Smart Summon operates with the mobile app only—not the key fob.

NOTE: All settings are retained until you manually change them.

Using Summon to Park and Retrieve your Vehicle

Follow these steps to use Summon to park your Model X:

- Align Model X within 39 feet (12 meters) of the parking space so Model X can follow a straight path into or out of the space in either Drive or Reverse.
- From outside the vehicle, initiate the parking maneuver by touching **Summon** on the mobile app, then holding down the **Forward** or **Reverse** button.

NOTE: If the **Require Continuous Press** setting is **No**, you do not need to hold down the button, just press and release.

NOTE: You can also initiate the parking maneuver from inside the vehicle (see [Starting Summon Before Exiting the Vehicle on page 119](#)).

Summon shifts Model X into Drive or Reverse (based on the direction you specified) and drives into or out of the parking space. When parking is complete, or if an obstacle is detected, Summon shifts Model X into Park. Summon shifts Model X into Park when:

- Model X detects an obstacle in its driving path (within the **Bumper Clearance** setting that you specified).
- Summon has moved Model X the maximum distance of 39 feet (12 meters).
- You release the **Forward** or **Reverse** button (when **Require Continuous Press** is turned on).
- You press any button to manually stop Summon.

If you used Summon to park Model X, you can then use Summon to return Model X back to its original position (provided Model X has remained in Park), or to the maximum **Summon Distance** that you have specified (whichever comes first). Simply specify the opposite direction on the mobile app and Summon moves Model X along the original path, provided no obstructions have been introduced. If the ultrasonic sensors detect an obstacle, Model X attempts to avoid the obstacle while staying very close to its original path (Summon does not steer around obstacles).

NOTE: To use Summon to move Model X multiple times in the same direction (not to exceed the maximum of 39 feet (12 meters), cancel Summon and then restart the parking process using the same direction.

NOTE: Although Summon can move Model X a short distance laterally to avoid an obstacle, it does not attempt to steer around an obstacle to return Model X to its original driving path. Only Smart Summon (if equipped) can steer Model X around objects.

NOTE: Summon requires that Model X can detect a valid key nearby.

 **WARNING:** Model X cannot detect obstacles that are located lower than the bumper, are very narrow, or are hanging from a ceiling (for example, bicycles). In addition, many unforeseen circumstances can impair Summon's ability to move in or out of a parking space and, as a result, Summon may not move Model X appropriately. Therefore, you must continually monitor the vehicle's movement and its surroundings and remain prepared to stop Model X at any time.

Operating Summon with the Key Fob

NOTE: Summon may not operate if the battery is low on the key fob.

Follow these steps to park Model X from outside the vehicle using the key fob:

1. On the touchscreen, ensure that **Require Continuous Press** is disabled (touch **Controls > Autopilot > Customize Summon > Require Continuous Press**).
2. With Model X in Park, stand within 10 feet (three meters) and press and hold the top center button on the key fob (Lock/Unlock All button) until the hazard lights blink continuously.

NOTE: The hazard lights flash once as Model X locks, then within five seconds, Model X powers on and the hazard lights flash continuously. Do not proceed to the next step until the hazard lights are flashing. If, after five seconds, the hazard lights are not flashing, release the button on the key fob, move closer to Model X, and try again. If Summon receives no further input within ten seconds, Summon cancels.
3. Press the Front Trunk button on the key fob to move Model X forward into the parking space, or press the Rear Trunk button to reverse Model X into the parking space.

Starting Summon Before Exiting the Vehicle

To start a Summon parking sequence before exiting Model X:

1. On the touchscreen, ensure that **Require Continuous Press** is disabled (touch **Controls > Autopilot > Customize Summon > Require Continuous Press**).
2. Close all doors and trunks.
3. With Model X powered on and Park engaged, double press the Park button on the drive stalk. The touchscreen displays a pop-up screen.
4. On the touchscreen, choose the direction of travel.
5. Exit Model X and close the driver's door.

Summon now moves Model X according to the direction you specified on the touchscreen.

NOTE: To cancel the parking maneuver before exiting the vehicle, touch **Cancel** on the popup screen.

NOTE: If you do not choose a direction of travel on the touchscreen, Summon does not start a parking maneuver when you exit.

Stopping or Canceling Summon

Stop Model X at any time while Summon is active by using the mobile app or by pressing any button on the key fob. Summon also cancels when:

- A door handle is engaged or a door is opened.
- You interact with the steering wheel, brake pedal, accelerator pedal, or shift.
- Model X detects an obstacle.
- Summon has moved Model X the maximum distance of approximately 39 feet (12 meters).
- Your phone enters sleep mode or loses connectivity to Model X.

Limitations

Summon is unlikely to operate as intended in the following types of situations:

- The driving path is sloped. Summon is designed to operate on flat roads only (up to 10% grade).
- A raised concrete edge is detected. Summon does not move Model X over an edge that is higher than approximately 1 in (2.5 cm).
- One or more of the ultrasonic sensors is damaged, dirty, or obstructed (such as by mud, ice, or snow, or by a vehicle bra, excessive paint, or adhesive products such as wraps, stickers, rubber coating, etc.).
- Weather conditions (heavy rain, snow, fog, or extremely hot or cold temperatures) are interfering with sensor operation.
- The sensors are affected by other electrical equipment or devices that generate ultrasonic waves.
- Model X is in Trailer Mode or an accessory is attached.







NOTE: Summon is disabled if Model X is in Valet mode (see [Valet Mode on page 48](#)).

 **WARNING:** The list above does not represent an exhaustive list of situations that may interfere with proper operation of Summon. It is the driver's responsibility to remain in control of Model X at all times. Pay close attention whenever Summon is actively moving Model X and stay prepared to take immediate action. Failure to do so can result in serious property damage, injury or death.



NOTE: Depending on market region, vehicle configuration, options purchased, and software version, your vehicle may not be equipped with Smart Summon, or the feature may not operate exactly as described.

Smart Summon is designed to allow you to move Model X to your location (using your phone's GPS as a target destination) or to a location of your choice, maneuvering around and stopping for objects as necessary. Smart Summon works with the Tesla mobile app when your phone is located within approximately 213 feet (65 meters) of Model X. Smart Summon maneuvers Model X out of parking spaces and around corners. This is useful for moving Model X out of a tight parking spot, through puddles, or helping you retrieve your car while carrying packages. You must maintain a clear line of sight between you and Model X and closely monitor the vehicle and its surroundings at all times.

-  **CAUTION:** Ensure all cameras and sensors are clean. Dirty cameras and sensors, as well as environmental conditions such as rain and faded lane markings, can affect Autopilot performance.
-  **WARNING:** Smart Summon is designed and intended for use only on parking lots and driveways located on private property where the surrounding area is familiar and predictable. Do not use Smart Summon on public roads.
-  **WARNING:** Smart Summon must only be used on paved surfaces.
-  **WARNING:** Smart Summon is a BETA feature. You must continually monitor the vehicle and its surroundings and stay prepared to take immediate action at any time. It is the driver's responsibility to use Smart Summon safely, responsibly, and as intended.
-  **WARNING:** Smart Summon may not stop for all objects (especially very low objects such as some curbs, or very high objects such as a shelf) and may not react to all traffic. Smart Summon does not recognize the direction of traffic, does not navigate around empty parking spaces, and may not anticipate crossing traffic.
-  **WARNING:** Smart Summon's performance depends on the ultrasonic sensors, the visibility of the cameras, and the availability of an adequate cellular signal and GPS data.
-  **WARNING:** When using Smart Summon, you must maintain a clear line of sight between you and Model X and stay prepared to stop the vehicle at any time by releasing the button on the mobile app.

Before Using Smart Summon

- Download the latest version of the Tesla mobile app to your phone, and ensure your phone has cellular service and GPS enabled.

- Your phone must be connected to Model X and located within approximately 213 feet (65 meters).
- The vehicle's cameras must be fully calibrated (see [Drive to Calibrate Cameras on page 94](#)).
- You must have a clear line of sight to Model X.
- Model X must be in Park, not charging, and all doors and trunks must be closed.

Using Smart Summon

1. Open the Tesla mobile app, and press **Summon**.
2. Press the **Smart Summon** icon located in the center of the image of your Model X. It may take several seconds for Smart Summon to start up.

NOTE: You can use Standby Mode to eliminate the delay that occurs when Smart Summon is starting up (see [Standby Mode on page 122](#)).

The mobile app displays a map with a blue circle, which represents the maximum proximity of 213 feet (65 meters) that you must maintain between your phone and Model X. The blue dot on the map represents your location, and the red arrow represents the location of Model X.

3. Position yourself anywhere within the blue circle where you have a clear line of sight to Model X.
4. You can now operate Smart Summon using either of these modes:
 - **Come to Me** mode: Press and hold the **Come to Me** button. Model X moves to your GPS location. As you move, Model X follows you. When Model X reaches you, it stops and shifts into park.
 - **Go to Target** mode: Touch the crosshair icon then drag the map to position the pin on a chosen destination. Press and hold the **Go to Target** button. Model X moves to the destination. When reaching the location, Model X stops and shifts into Park and the mobile app displays a message indicating that Summon has completed.

NOTE: To subsequently change the location, lift your finger, reposition the map, then press and hold **Go to Target** again.

To stop Model X at any time, simply release the **Come to Me** or **Go to Target** button.



The map's crosshair icon toggles between **Go to Target** and **Come to Me** modes. When **Come to Me** mode is selected, the icon is blue.

NOTE: The map also has an icon that allows you to display/hide satellite imagery.

Immediately after initiating Smart Summon in either mode, hazard lights briefly flash, mirrors fold, and Model X shifts into Drive or Reverse. Model X then slowly moves to within 3 feet (1 meter) of you (COME TO ME) or your chosen destination (GO TO TARGET), navigating obstacles as needed. As Model X moves, the corresponding red arrow on the map also moves to show the vehicle's location. As you move, the corresponding blue dot also moves to show your location.



In either mode, Model X stops moving and shifts into park when:

- You release the button on the mobile app.
- The maximum proximity of 213 feet (65 meters) between your phone and Model X is exceeded (if moving Model X to a destination away from you, you may need to follow the car to maintain this distance).
- The driving path is blocked.
- Model X has moved the maximum distance of 475 feet (145 meters) since the start of the Smart Summon session, or has moved 492 feet (150 meters) away from the location from which the vehicle was last driven manually.

NOTE: If Smart Summon moves Model X forward three feet and then backwards two feet, this is considered five feet of travel.

NOTE: There is no need to look at the mobile app—just hold down the button while keeping your eye on Model X and its driving path at all times, remaining ready to release the button to stop the vehicle if needed.

If equipped and Auto HomeLink is enabled for Summon (touch **Controls** > **Autopilot** > **Customize Summon** > **Use Auto HomeLink**), Smart Summon automatically opens a HomeLink device if you start the Smart Summon maneuver when Model X is located inside a garage. The mobile app informs you that the door has opened.

-  **WARNING:** When you release the button to stop Model X, a slight delay occurs before the vehicle stops. Therefore, it is critical that you pay close attention to the vehicle's driving path at all times and proactively anticipate obstacles that the vehicle may be unable to detect.
-  **WARNING:** Use extreme caution when using Smart Summon in environments where movement of obstacles can be unpredictable. For example, where people, children or animals are present.
-  **WARNING:** Smart Summon may not stop for all objects (especially very low objects such as some curbs, or very high objects such as a shelf) and may not react to all oncoming or side traffic. Pay attention and be ready to stop Model X at all times by releasing the button on the mobile app.

Standby Mode

To keep Model X ready to Summon and reduce the time it takes to warm up, turn on Standby Mode. Touch **Controls** > **Autopilot** > **Standby Mode**. When Standby Mode is turned on, you can conserve Battery energy by disabling Standby Mode at these locations:

- **Exclude Home** - Disables Standby Mode at the location you set as Home in your Favorites list.
- **Exclude Work** - Disables Standby Mode at the location you set as Work in your Favorites list.
- **Exclude Favorites** - Disables Standby Mode at any location in your Favorites list.

NOTE: To conserve energy, Smart Summon automatically exits Standby mode from midnight to 6:00 am. During these hours, a delay occurs as Smart Summon starts up.

NOTE: Additional battery power may be consumed while Standby Mode is active.

NOTE: For details on how to designate a location as Home, Work, or Favorites, see [Home, Work, and Favorite Destinations on page 145](#).

Stopping or Canceling Smart Summon

Smart Summon stops Model X whenever you release the button on the mobile app. To resume the Smart Summon session, simply press the **Come to Me** or **Go to Target** button again.

 **WARNING:** Always anticipate when you need to stop Model X. Depending on the quality of the connectivity between the phone and Model X, there may be a slight delay between when you release the button and when the car stops.

Smart Summon cancels, and requires you to restart it, when:

- You press any button on the key fob.
- A door handle is engaged or a door is opened.
- You interact with the steering wheel, brake pedal, accelerator pedal, or shift.
- Model X is blocked by an obstacle.
- Smart Summon has moved Model X the maximum distance of approximately 475 feet (145 meters) within a 213 foot (65 meter) radius of the phone's location. To move further than this distance, you must shift Model X into Drive or Reverse and then re-initiate an Smart Summon session.
- Your phone enters sleep mode or loses connectivity to Model X.



Limitations

Smart Summon is unlikely to operate as intended in the following types of situations:

- GPS data is unavailable due to poor cellular coverage.
- The driving path is sloped. Smart Summon is designed to operate on flat roads only (up to 10% grade).
- A raised concrete edge is detected. Depending on the height of the concrete edge, Smart Summon may not move Model X over it.
- One or more of the ultrasonic sensors or cameras is damaged, dirty, or obstructed (such as by mud, ice, or snow, or by a vehicle bra, excessive paint, or adhesive products such as wraps, stickers, rubber coating, etc.).
- Weather conditions (heavy rain, snow, fog, or extremely hot or cold temperatures) are interfering with sensor or camera operation.
- The sensors are affected by other electrical equipment or devices that generate ultrasonic waves.
- Model X is in Trailer Mode or an accessory is attached.

NOTE: Smart Summon is disabled if Model X is in Valet mode (see [Valet Mode on page 48](#)).

 **WARNING:** The list above does not represent an exhaustive list of situations that may interfere with proper operation of Smart Summon. It is the driver's responsibility to remain in control of Model X at all times. Pay close attention whenever Smart Summon is actively moving Model X and stay prepared to take immediate action. Failure to do so can result in serious property damage, injury or death.



Lane Assist

Model X monitors the markers on the lane you are driving in as well as the surrounding areas for the presence of vehicles or other objects.

When an object is detected in your blind spot or near the side of Model X (such as a vehicle, guard rail, etc.), the instrument panel displays colored lines radiating from the image of your vehicle. The location of the lines correspond to the location of the detected object. The color of the lines (white, yellow, orange, or red) represent the object's proximity to Model X, with white being the farthest and red being the closest and requiring your immediate attention. These colored lines only display when driving between approximately 7 and 85 mph (12 and 140 km/h). When Autosteer is active, these colored lines also display if driving slower than 7 mph (12 km/h). However, the colored lines do not display if Model X is at a standstill (for example, in heavy traffic).



- CAUTION:** Ensure all cameras and sensors are clean. Dirty cameras and sensors, as well as environmental conditions such as rain and faded lane markings, can affect Autopilot performance.
- WARNING:** Lane Assist features are for guidance purposes only and is not intended to replace your own direct visual checks. Before changing lanes, always use side mirrors and perform the appropriate shoulder checks to visually determine if it is safe and appropriate to change lanes.
- WARNING:** Never depend on Lane Assist to inform you if you unintentionally drive outside of the driving lane, or to inform you that there is a vehicle beside you or in your blind spot. Several external factors can reduce the performance of Lane Assist (see [Limitations and Inaccuracies on page 125](#)). It is the driver's responsibility to stay alert and pay attention to the driving lane and other road users. Failure to do so can result in serious injury or death.

Steering Interventions

Lane Assist provides steering interventions if Model X drifts into (or close to) an adjacent lane in which an object, such as a vehicle, is detected. In these situations, Model X automatically steers to a safer position in the driving lane. This steering is applied only when Model X is traveling between 30 and 85 mph (48 and 140 km/h) on major roads with clearly visible lane markings. When a steering intervention is applied, the instrument panel briefly displays a warning message.

Lane Departure Avoidance

Lane Departure Avoidance is designed to warn you if Model X is drifting out of, or nears the edge of, your driving lane.

Lane Departure Avoidance operates when driving between 40 and 90 mph (64 and 145 km/h) on roads with clearly visible lane markings. You can choose if and how you want Lane Departure Warning to operate by touching **Controls > Autopilot > Lane Departure Avoidance** and selecting between these options:

- Off:** You are not warned of lane departures or potential collisions with a vehicle in an adjacent lane.
- Warning:** If a front wheel passes over a lane marking, the steering wheel vibrates.
- Assist:** Corrective steering is applied to keep Model X in a safe position if Model X drifts into an adjacent lane or near the edge of the road.

When Lane Departure Avoidance is enabled and Traffic-Aware Cruise Control is active, if Model X drifts out of the driving lane when the associated turn signal is off, Lane Assist also checks to see whether your hands are on the steering wheel. If hands are not detected, the instrument panel displays a series of alerts, similar to those that are used when driving with Autosteer. If hands are repeatedly not detected Model X gradually slows down to 15 mph (25 km/h) below the detected speed limit, or below the set cruising speed, and the hazard lights start flashing.

NOTE: Lane Departure Avoidance does not warn you of lane departures, or provide steering interventions, if the associated turn signal is on, which indicates an intentional lane change.

- WARNING:** Lane Departure Avoidance is intended to help keep you safe, but it does not work in every situation and does not replace the need to remain attentive and in control.
- WARNING:** Keep your hands on the steering wheel and drive attentively at all times.
- WARNING:** Steering interventions are minimal and are not designed to move Model X out of its driving lane. Do not rely on steering interventions to avoid side collisions.

Emergency Lane Departure Avoidance

Emergency Lane Departure Avoidance automatically applies steering to avoid a potential collision in situations where:

- Model X is departing a lane and may collide with a vehicle traveling in the same direction in the adjacent lane (regardless of the status of the turn signal).
- Model X is departing a lane into an oncoming lane, the turn signal is off, and an oncoming vehicle is detected.
- Model X is departing the road and the turn signal is off (for example, very close to the edge of the road and a collision may occur).

To turn this feature on or off, touch **Controls > Autopilot > Emergency Lane Departure Avoidance**.

When Emergency Lane Departure Avoidance applies steering, a chime sounds and the instrument panel displays a warning and highlights the lane marking in red.

Emergency Lane Departure Avoidance operates when Model X is traveling between 40 and 90 mph (64 and 145 km/h) on a road with clearly visible lane markings, curbs, etc.



WARNING: Emergency Lane Departure Avoidance is not a substitute for attentive driving and sound judgment. Keep your eyes on the road when driving and never depend on Emergency Lane Departure Avoidance to prevent a collision. Several factors can reduce or impair performance. Depending on Emergency Lane Departure Avoidance to prevent a potential collision can result in serious injury or death.

Limitations and Inaccuracies

Lane Assist features cannot always detect lane markings and you may experience unnecessary or invalid warnings in these situations:

- Visibility is poor and lane markings are not clearly visible (due to heavy rain, snow, fog, etc.). The exact detection zone of the ultrasonic sensors varies depending on environmental conditions.
- Bright light (such as from oncoming headlights or direct sunlight) is interfering with the view of the camera(s).
- A vehicle in front of Model X is blocking the view of the camera(s).
- The windshield is obstructing the view of the camera(s) (fogged over, dirty, covered by a sticker, etc.).

- Lane markings are excessively worn, have visible previous markings, have been adjusted due to road construction, or are changing quickly (for example, lanes branching off, crossing over, or merging).
- The road is narrow or winding.
- Objects or landscape features are casting strong shadows on lane markers.

Lane Assist may not provide warnings, or may apply inappropriate warnings, in these situations:

- One or more of the ultrasonic sensors is damaged, dirty, or obstructed (by mud, ice, or snow, or by a vehicle bra, excessive paint, or adhesive products such as wraps, stickers, rubber coatings, etc.).
- Weather conditions (heavy rain, snow, fog, or extremely hot or cold temperatures) are interfering with sensor operation.
- The sensors are affected by other electrical equipment or devices that generate ultrasonic waves.
- An object that is mounted to Model X is interfering with and/or obstructing a sensor (such as a bike rack or a bumper sticker).

In addition, Lane Assist may not steer Model X away from an adjacent vehicle, or may apply unnecessary or inappropriate steering, in these situations:

- You are driving Model X on sharp corners or on a curve at a relatively high speed.
- Bright light (such as from oncoming headlights or direct sunlight) is interfering with the view of the camera(s).
- You are drifting into another lane but an object (such as a vehicle) is not present.
- A vehicle in another lane cuts in front of you or drifts into your driving lane.
- Model X is not traveling within the speeds at which the Lane Assist feature is designed to operate.
- One or more of the ultrasonic sensors is damaged, dirty, or obstructed (such as by mud, ice, or snow, or by a vehicle bra, excessive paint, or adhesive products such as wraps, stickers, rubber coating, etc.).
- Weather conditions (heavy rain, snow, fog, or extremely hot or cold temperatures) are interfering with sensor operation.
- The sensors are affected by other electrical equipment or devices that generate ultrasonic waves.
- An object mounted to Model X (such as a bike rack or a bumper sticker) is interfering with or obstructing a sensor.
- Visibility is poor and lane markings are not clearly visible (due to heavy rain, snow, fog, etc.).



Lane Assist

- Lane markings are excessively worn, have visible previous markings, have been adjusted due to road construction or are changing quickly (for example, lanes branching off, crossing over, or merging).

 **WARNING:** The lists above do not represent every possible situation that may interfere with Lane Assist features. There are many reasons why Lane Assist may not operate as intended. To avoid a collision, stay alert and always pay attention to the road so you can anticipate the need to take corrective action as early as possible.



The following collision avoidance features are designed to increase the safety of you and your passengers:

- **Forward Collision Warning** - provides visual and audible warnings in situations when Model X detects that there is a high risk of a frontal collision (see [Forward Collision Warning on page 127](#)).
- **Automatic Emergency Braking** - automatically applies braking to reduce the impact of a frontal collision (see [Automatic Emergency Braking on page 128](#)).
- **Obstacle-Aware Acceleration** - reduces acceleration if Model X detects an object in its immediate driving path (see [Obstacle-Aware Acceleration on page 128](#)).

CAUTION: Ensure all cameras and sensors are clean. Dirty cameras and sensors, as well as environmental conditions such as rain and faded lane markings, can affect performance.

WARNING: Forward Collision Warning is for guidance purposes only and is not a substitute for attentive driving and sound judgment. Keep your eyes on the road when driving and never depend on Forward Collision Warning to warn you of a potential collision. Several factors can reduce or impair performance, causing either unnecessary, invalid, inaccurate, or missed warnings. Depending on Forward Collision Warning to warn you of a potential collision can result in serious injury or death.

WARNING: Automatic Emergency Braking is not designed to prevent all collisions. In certain situations, it can minimize the impact of a frontal collision by attempting to reduce your driving speed. Depending on Automatic Emergency Braking to avoid a collision can result in serious injury or death.

WARNING: Obstacle-Aware Acceleration is not designed to prevent a collision. In certain situations, it can minimize the impact of a collision. Depending on Obstacle-Aware Acceleration to avoid a collision can result in serious injury or death.

Forward Collision Warning

Model X monitors the area in front of it for the presence of an object such as a vehicle, motorcycle, bicycle, or pedestrian. If a collision is considered likely unless you take immediate corrective action, Forward Collision Warning is designed to sound a chime and highlight the vehicle in front of you in red on the instrument panel. If this happens, **TAKE IMMEDIATE CORRECTIVE ACTION!**



Warnings cancel automatically when the risk of a collision has been reduced (for example, you have decelerated or stopped Model X, or the object in front of your vehicle has moved out of your driving path).

If immediate action is not taken when Model X issues a Forward Collision Warning, Automatic Emergency Braking (if enabled) may automatically apply the brakes if a collision is considered imminent (see [Automatic Emergency Braking on page 128](#)).

By default, Forward Collision Warning is turned on. To turn it off or adjust its sensitivity, touch **Controls** > **Autopilot** > **Forward Collision Warning**. Instead of the default warning level of **Medium**, you can turn the warning **Off**, or you can choose to be warned **Late** or **Early**.

NOTE: Your chosen setting for Forward Collision Warning is retained until you manually change it.

WARNING: The camera(s) and sensors associated with Forward Collision Warning are designed to monitor an approximate area of up to 525 feet (160 meters) in your driving path. The area being monitored by Forward Collision Warning can be adversely affected by road and weather conditions. Use appropriate caution when driving.

WARNING: Forward Collision Warning is designed only to provide visual and audible alerts. It does not attempt to apply the brakes or decelerate Model X. When seeing and/or hearing a warning, it is the driver's responsibility to take immediate corrective action.

WARNING: Forward Collision Warning may provide a warning in situations where the likelihood of collision may not exist. Stay alert and always pay attention to the area in front of Model X so you can anticipate whether any action is required.

Forward Collision Warning operates only when driving between approximately 3 mph (5 km/h) and 90 mph (150 km/h).

WARNING: Forward Collision Warning does not provide a warning when the driver is already applying the brake.



Automatic Emergency Braking

Model X is designed to determine the distance from a detected object traveling in front of it. When a frontal collision is considered unavoidable, Automatic Emergency Braking is designed to apply the brakes to reduce the vehicle's speed and therefore, the severity of the impact. The amount of speed that is reduced depends on many factors, including driving speed and environment.

When Automatic Emergency Braking applies the brakes, the instrument panel displays a visual warning and sounds a chime. You may also notice abrupt downward movement of the brake pedal. The brake lights turn on to alert other road users that you are slowing down.



Emergency braking in progress

Automatic Emergency Braking operates only when driving between approximately 3 mph (5 km/h) and 90 mph (150 km/h).

Automatic Emergency Braking does not apply the brakes, or stops applying the brakes, when:

- You turn the steering wheel sharply.
- You press and release the brake pedal while Automatic Emergency Braking is applying the brakes.
- You accelerate hard while Automatic Emergency Braking is applying the brakes.
- The vehicle, motorcycle, bicycle, or pedestrian is no longer detected ahead.

Automatic Emergency Braking is always enabled when you start Model X. To disable it for your current drive, touch **Controls** > **Autopilot** > **Automatic Emergency Braking**.

 **WARNING:** It is strongly recommended that you do not disable Automatic Emergency Braking. If you disable it, Model X does not automatically apply the brakes in situations where a collision is considered likely.

 **WARNING:** Automatic Emergency Braking is designed to reduce the severity of an impact. It is not designed to avoid a collision.

 **WARNING:** Several factors can affect the performance of Automatic Emergency Braking, causing either no braking or inappropriate or untimely braking, such as when a vehicle is partially in the path of travel or there is road debris. It is the driver's responsibility to drive safely and remain in control of the vehicle at all times. Never depend on Automatic Emergency Braking to avoid or reduce the impact of a collision.

 **WARNING:** Automatic Emergency Braking is designed to reduce the impact of frontal collisions only and does not function when Model X is in Reverse.

 **WARNING:** Automatic Emergency Braking is not a substitute for maintaining a safe traveling distance between you and the vehicle in front of you.

 **WARNING:** The brake pedal moves downward abruptly during automatic braking events. Always ensure that the brake pedal can move freely. Do not place material under or on top of the driver's floor mat (including an additional mat) and always ensure that the driver's floor mat is properly secured. Failure to do so can impede the ability of the brake pedal to move freely.

Obstacle-Aware Acceleration

Obstacle-Aware Acceleration is designed to reduce the impact of a collision by reducing motor torque and in some cases applying the brakes, if Model X detects an object in its driving path. The instrument panel displays a visual warning and sounds a chime when the brakes are automatically applied. For example, Model X, while parked in front of a closed garage door with Drive engaged, detects that you have pressed hard on the accelerator pedal. Although Model X still accelerates and hits the garage door, the reduced torque may result in less damage.





Obstacle-Aware Acceleration is designed to operate only when all of these conditions are simultaneously met:

- Drive or Reverse is engaged.
- Model X is stopped or traveling less than 10 mph (16 km/h).
- Model X detects an object in its immediate driving path.

To disable Obstacle-Aware Acceleration, touch **Controls** > **Autopilot** > **Obstacle-Aware Acceleration**.

 **WARNING:** Obstacle-Aware Acceleration is designed to reduce the severity of an impact. It is not designed to avoid a collision.





-  **WARNING:** Obstacle-Aware Acceleration may not limit torque in all situations. Several factors, including environmental conditions, distance from an obstacle, and a driver's actions, can limit, delay, or inhibit Obstacle-Aware Acceleration.
-  **WARNING:** Obstacle-Aware Acceleration may not limit torque when performing a sharp turn, such as into a parking space.
-  **WARNING:** Do not rely on Obstacle-Aware Acceleration to control acceleration or to avoid, or limit, the severity of a collision, and do not attempt to test Obstacle-Aware Acceleration. Doing so can result in serious property damage, injury, or death.
-  **WARNING:** Several factors can affect the performance of Obstacle-Aware Acceleration, causing an inappropriate or untimely reduction in motor torque and/or undesired braking. It is the driver's responsibility to drive safely and remain in control of Model X at all times.

Limitations and Inaccuracies

Collision Avoidance features cannot always detect all objects, vehicles, bikes, or pedestrians, and you may experience unnecessary, inaccurate, invalid, or missed warnings for many reasons, particularly if:

- The road has sharp curves.
- Visibility is poor (due to heavy rain, snow, fog, etc.).
- Bright light (such as from oncoming headlights or direct sunlight) is interfering with the view of the camera(s).
- A camera or sensor is obstructed (dirty, covered, fogged over, covered by a sticker, etc.).
- One or more of the ultrasonic sensors is damaged, dirty, or obstructed (such as by mud, ice, or snow, or by a vehicle bra, excessive paint, or adhesive products such as wraps, stickers, rubber coating, etc.).
- Weather conditions (heavy rain, snow, fog, or extremely hot or cold temperatures) are interfering with sensor operation.
- The sensors are affected by other electrical equipment or devices that generate ultrasonic waves.

 **WARNING:** The limitations previously described do not represent an exhaustive list of situations that may interfere with proper operation of Collision Avoidance Assist features. These features may fail to provide their intended function for many other reasons. It is the driver's responsibility to avoid collisions by staying alert, paying attention, and taking corrective action as early as possible.

 **CAUTION:** If a fault occurs with a Collision Avoidance Assist feature, Model X displays an alert. Contact Tesla Service.

How Speed Assist Works

Model X displays a speed limit on the instrument panel and you can choose if and how you are warned when you exceed the speed limit. Also, instead of using the detected speed limit, you can base warnings on an arbitrary speed limit that you enter manually.

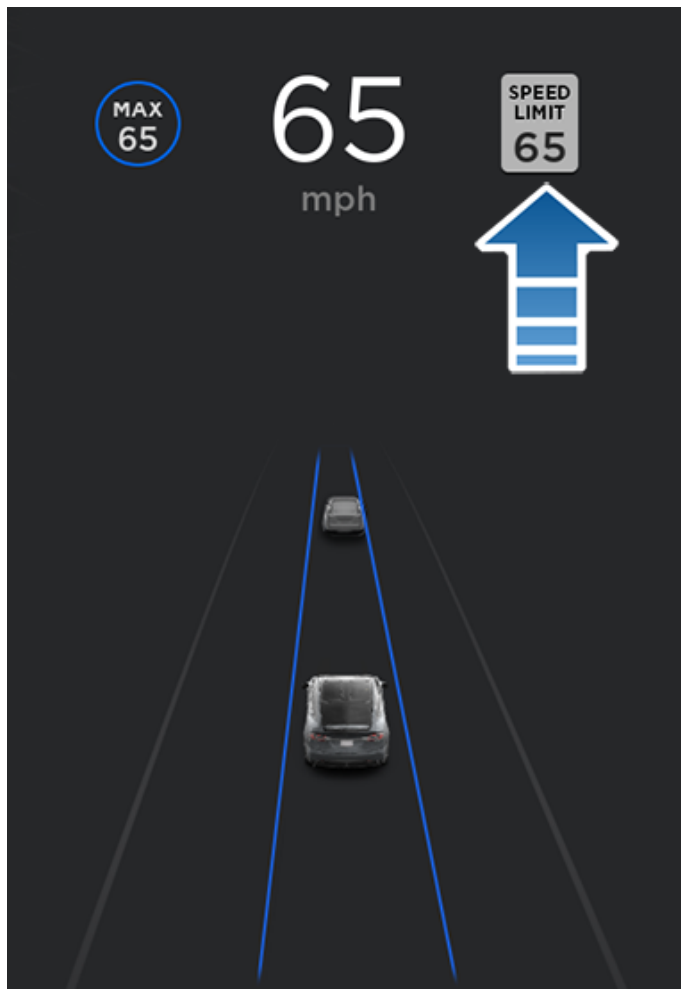

In situations where Model X is unable to determine a speed limit, or if Speed Assist is uncertain that an acquired speed limit is accurate, the instrument panel may not display a speed limit sign and warnings do not take effect.

NOTE: Speed limit warnings go away after ten seconds, or when Model X slows down below the specified limit.

 **WARNING:** Do not rely on Speed Assist to determine the appropriate speed limit or driving speed. Always drive at a safe speed based on traffic and road conditions.

Controlling Speed Assist

To adjust the Speed Limit Warning setting, touch **Controls > Autopilot > Speed Limit Warning**, then choose one of these options:

- **Off** - Speed limit warnings do not display and chimes are not sounded.
- **Display** - Speed limit signs display on the instrument panel and the sign increases in size when you exceed the determined limit.
- **Chime** - In addition to the visual display, a chime is sounded when you exceed the determined speed limit.

You can also specify how the speed limit is determined:

- **Relative** - You can set a speed limit offset (+ or -) if you want to be alerted only when you exceed the offset speed limit by a specified amount. For example, you can increase the offset to +10 mph (10 km/h) if you only want to be warned when you exceed the speed limit by 10 mph (10 km/h).
NOTE: The offset from speed limit also affects the number shown in the gray speed icon on the instrument panel.
- **Absolute** - Manually specify any speed limit between 20 and 140 mph (30 and 240 km/h).

NOTE: Speed Assist is not always accurate. In some situations, the location of a road can be miscalculated and Speed Assist can display a speed for a directly adjacent road that may have a different speed limit. For example, Speed Assist can assume Model X is on a controlled-access highway when it is actually on a nearby surface street, and vice versa.

NOTE: Your chosen setting is retained until you manually change it.

Limitations and Inaccuracies

Speed Assist may not be fully functional or may provide inaccurate information in these situations:

- Visibility is poor and speed limit signs are not clearly visible (due to heavy rain, snow, fog, etc.).
- Bright light (such as from oncoming headlights or direct sunlight) is interfering with the view of the camera(s).
- Model X is being driven very close to a vehicle in front of it which is blocking the view of the camera(s).
- The windshield is obstructing the view of the camera(s) (fogged over, dirty, covered by a sticker, etc.).
- Speed limit signs are concealed by objects.
- The speed limits stored in the map database are incorrect or outdated.
- Model X is being driven in an area where GPS or map data is not available or where speed limit signs can not be detected.

- Traffic signs do not conform to standard recognizable formats.
- A road or a speed limit has recently changed.

 **WARNING:** The list above does not represent an exhaustive list of situations that may interfere with proper operation of Speed Assist. Speed Assist may fail to provide warnings for many other reasons.

Controls - Overview

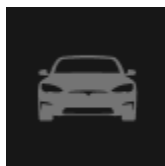

Touch **Controls** on the bottom corner of the touchscreen to control features and customize Model X to suit your preferences. The Controls screen appears over the map. Touch an option on the Controls screen to display the various settings and options associated with the chosen option. Swipe to close.



When an information icon displays beside a specific setting, touch it to display a popup that provides helpful details about the associated setting.

NOTE: Many vehicle controls, settings, and preferences (such as climate, media, and navigation) can be adjusted hands-free using voice commands (see [Voice Commands on page 159](#)).

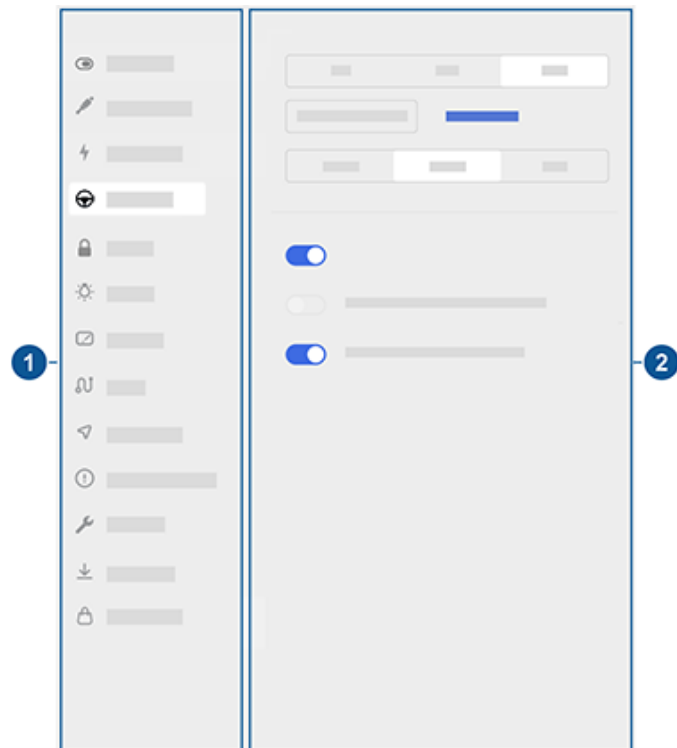

1. List of available settings. When you select an item from this list, its associated settings display on the right side of the screen.
2. Settings area. The options available for the chosen settings display here, and are described next.

Pedals & Steering

Acceleration: Adjust the amount of acceleration. (See [Acceleration Modes on page 74](#)).

Steering Mode: Adjust the amount of effort required to turn the steering wheel (see [Adjusting Steering Effort on page 50](#)).

Regenerative Braking: When you release the accelerator when driving, regenerative braking slows Model X and feeds any surplus energy back to the Battery. If set to **LOW**, Model X does not slow down as quickly, but also feeds less energy back to the Battery (see [Regenerative Braking on page 68](#)).

NOTE: Regardless of the setting selected, the energy gained by regenerative braking is reduced if the Battery is full, or is extremely cold or hot (in which case, surplus energy is used to heat or cool it).

NOTE: The regenerative braking setting is not available on all vehicles.

Stopping Mode: Choose how you want Model X to behave once regenerative braking has reduced the driving speed to a very low speed, a drive mode is still engaged, and both the accelerator and brake pedals are released. You can adjust this setting only when Model X is in Park.

Slip Start: Turn on to allow wheels to spin (see [Traction Control on page 70](#)).

Range Mode (if equipped): If on, Model X conserves energy by automatically limiting the amount of power that the climate control system uses to maintain the temperature of the cabin area and limits the amount of energy being used to heat or cool the Battery. In addition, Range Mode turns off signature lights (only in market regions where daytime running lights are not required).

Trailer Mode: Enable Trailer Mode before towing a trailer (see [Towing and Accessories on page 82](#)).

Seats

Adjust the seats: Adjust the second row seats by touching the forward and backward buttons.

Easy Entry (if equipped): When enabled, you can move a second row monopost seat all the way forward or backward by touching the forward/backward button once. When off, you must hold the button to move the second row seats fully forward/backward (see [Accessing Third Row Seats \(if equipped\) - Monopost Seating on page 28](#)).

Suspension

Adjust the settings associated with the air suspension system. You can adjust the **Ride Height** (helpful for increasing ground clearance on steep driveways, etc.) and you can optimize ride and handling by adjusting settings for **Adaptive Suspension Damping**. See [Air Suspension on page 157](#).

Charging

View charging status and adjust settings related to charging Model X (see [Charging Instructions on page 176](#)).

Autopilot

NOTE: Depending on market region, vehicle configuration, options purchased, and software version, your vehicle may not be equipped with all Autopilot features described below.

Customize how some of the Autopilot features operate to provide a safer and more convenient driving experience. See [About Autopilot on page 93](#) for an overview of Autopilot components and features.

- **Autosteer (Beta):** Turn on the feature that provides automatic steering in addition to Traffic-Aware Cruise Control (see [Autosteer on page 101](#)).
- **Navigate on Autopilot (Beta):** Navigate on Autopilot automatically exits at off-ramps and interchanges based on your navigation route and can also make lane changes designed to prepare for exits and minimize the driving time to your destination (available only if your vehicle is equipped with the Full Self-Driving option). Touch **Customize Navigate on Autopilot** to specify how you want Navigate on Autopilot to operate, such as whether you want it to automatically enable at the start of every trip, how you want it to perform lane changes, etc. (see [Navigate on Autopilot on page 106](#)).

NOTE: Navigate on Autopilot is not available in all market regions.

- **Traffic Light and Stop Sign Control (Beta):** Turn on if you want Model X to automatically stop at traffic lights and stop signs when using Traffic-Aware Cruise Control or Autosteer (see [Traffic Light and Stop Sign Control on page 109](#)) (available only if your vehicle is equipped with the Full Self-Driving option).
- **Full Self-Driving Visualization Preview** (if equipped): Display more details about the roadway and its surroundings, such as road markings, stop lights, objects (such as trash cans and poles), etc.
- **Summon (Beta):** Automatically park and retrieve Model X from outside the vehicle (see [Summon on page 118](#)) (available only if your vehicle is equipped with the Full Self-Driving option).

Customize Summon: Determine the bumper clearance, distance, amount of side clearance, and whether Summon requires continuous press to operate (the ability to disable continuous press is not available in all market regions).

Standby Mode: Use Standby Mode to eliminate the delay that occurs when Smart Summon (if equipped) is starting up.

- **Set Speed:** When you engage Traffic-Aware Cruise Control or Autosteer, choose whether you want the initial cruising speed set to the **Speed Limit** or your **Current Speed** (see [Traffic-Aware Cruise Control on page 96](#)).
- **Offset:** When set to cruise at the speed limit, you can choose a **Fixed** offset, in which the speed is adjusted by a specific number of mph (km/h) on all roads, or a **Percentage** offset, in which the speed adjustment varies depending on the detected speed limit of the road.
- **Blind Spot Camera:** When **ON**, the touchscreen displays the view from the corresponding side repeater camera whenever you engage a turn signal to change lanes. See [#unique_332 on page .](#)
- **Blind Spot Collision Warning Chime:** Choose if you want a chime to sound when a vehicle is in your blind spot and a possible collision is detected (see [#unique_332 on page .](#)).
- **Speed Limit Warning:** Choose the type of warnings, if any, you receive if driving speed exceeds the detected speed limit (see [Speed Assist on page 130](#)).
- **Speed Limit:** Choose if you want **Speed Limit Warning** to use a relative or an absolute speed limit (see [Speed Assist on page 130](#)). If you choose a relative speed limit, you can specify an **Offset** to be alerted only when you exceed the speed limit by the specified offset amount.
- **Lane Departure Avoidance:** Choose if and how you want the steering wheel to respond if a front wheel passes over a lane marking when the associated turn signal is off (see [Lane Assist on page 124](#)).
- **Forward Collision Warning:** Choose if and when Model X displays visual and audible warnings in situations when there is a high risk of a frontal collision (see [Collision Avoidance Assist on page 127](#)).
- **Emergency Lane Departure Avoidance** (if equipped): When enabled, Model X attempts to prevent a potential collision with an object in an adjacent lane by steering the vehicle back into your driving lane in emergency situations (see [Emergency Lane Departure Avoidance on page 125](#)).
- **Automatic Emergency Braking:** Choose if you want Model X to automatically apply braking when a frontal collision is imminent (see [Collision Avoidance Assist on page 127](#)).
- **Obstacle-Aware Acceleration:** Choose if you want acceleration to be automatically reduced in situations where Model X is stopped (or moving slowly) and you accelerate toward a detected obstacle (see [Obstacle-Aware Acceleration on page 128](#)).
- **Traffic-Aware Cruise Control Chime:** If on, a chime sounds when you engage or cancel Traffic-Aware Cruise Control.

- **Green Traffic Light Chime** (if equipped): If on, a chime sounds when you are waiting at a red traffic light and the light turns green. If you are not actively using Traffic-Aware Cruise Control and are waiting at a red light with a car in front of you, the chime sounds when the car advances ahead of you.

Vehicle

Keys: You can see all the keys used for Model X and their associated driver profiles. You can add, delete, and change the driver profile associated with each key (see [Driver Profiles on page 48](#)).

Window Lock: Locks the rear window switches.

Child Lock: If on, safety locks prevent the rear doors from being opened from inside the vehicle.

Walk-Away Door Lock: If on, doors automatically lock when you walk away from the vehicle carrying your key fob or phone key (see [Walk-Away Door Lock on page 14](#)).

Driver Door Unlock Mode: Driver Door Unlock Mode will only unlock the driver's door when first unlocking the vehicle.

Unlock on Park: If on, doors automatically unlock when you engage Park .

Car Left Open Notification: Choose whether you want Model X to send a notification to your Tesla mobile app if your car remains open for over approximately 10 minutes after you have left:

- **Off:** You are not notified if you leave Model X open.
- **Doors:** You are notified only if a door or trunk is left open.
- **Doors & Windows:** In addition to being notified if a door or trunk is left open, you are notified if Model X is locked and a window is left open.

Touch **Exclude Home** to disable the notification when Model X is parked at the location you set as Home in your Favorites list (see [Home, Work, and Favorite Destinations on page 145](#)).

NOTE: To use the **Car Left Open Notification**, the mobile access setting must be turned on (**Controls > Safety > Allow Mobile Access**).

NOTE: Notifications are not sent when Model X is in Camp Mode or if Tesla Theater (if equipped) is active.

Falcon Door Height: If set to **AUTO**, falcon wing doors open fully, taking into consideration any remembered location-based heights, and assuming an obstacle is not detected. If set to **LOW**, falcon wing doors open partially, further protecting occupants and the vehicle's interior from inclement weather conditions.

Automatic Doors: If on, the driver's door opens whenever you approach Model X and the key is detected. The driver's door also opens when you double-click the key and the passenger door opens with a subsequent double-click. If not enabled, the door (or doors) unlock, but you'll need to open the driver's door manually.

Close All With Key Fob: If on, a single-click of the key fob's lock/unlock button closes and locks all doors (and the rear trunk). If off, you must triple-click the button.

Lock Confirmation Sound: If on, a soft horn sounds whenever Model X locks or unlocks (see [Walk-Away Door Lock on page 14](#)).

Mirror Auto-Tilt: See [Mirrors on page 53](#).

Mirror Auto-Fold: See [Mirrors on page 53](#).

Lights

Control interior and exterior lights. See [Lights on page 57](#).

NOTE: You can also control the exterior headlights by touching the high beam headlights button on the left side of the steering wheel and then choosing an option using the touchscreen. See [High Beam Headlights on page 57](#).

Display

Customize characteristics of the touchscreen and instrument panel:

- **Appearance:** Customize the display to be **Dark** or **Light**. When set to **Auto**, the brightness changes automatically based on ambient lighting conditions.
- **Brightness:** Drag the slider to manually control the brightness level. If **Display Mode** is set to **Auto**, the touchscreen further adjusts based on both the ambient lighting conditions and your brightness preference. Model X remembers your chosen brightness preference and adjusts the touchscreen accordingly.

Energy Saving: When toggled on, Model X reduces the amount of energy being consumed when not in use (for newer vehicles, this is automated). See [Getting Maximum Range on page 77](#).

Screen Clean Mode: When enabled, your touchscreen darkens and temporarily disables to facilitate cleaning. Follow the onscreen instructions to exit Screen Clean Mode.

Touchscreen Language: Select the language that the touchscreen displays.

NOTE: Model X must be in Park to change the language. When you change the language, you experience a brief delay as Model X shuts down and restarts the touchscreen.

Voice Recognition Language: Choose the language to be used for voice commands.

Voice Navigation Language: Choose the language that the navigation system uses for spoken instructions.

Time: Choose to display time in either 12 or 24 hour format.

Energy Display: Choose to display remaining energy and charging units as either a percentage of battery energy remaining, or as an estimate of the distance you can drive.

Distance: Choose to display range using miles or kilometers.

Temperature: Choose to display temperature using Fahrenheit or Celsius.

Tire Pressure: Choose to display tire pressures using BAR or PSI.

Trips

View the odometer and view and reset up to two trip meters that summarize how far you have driven (see [Trip Information on page 76](#)).

Navigation

Customize how the navigation system works:

- **Navigation Volume:** Increase or decrease the volume of spoken navigation instructions by touching **-** or **+**, respectively. Fully decreasing the volume mutes the instructions. You can also mute navigation instructions when a navigation route is active by touching the volume icon on the turn-by-turn direction list.

NOTE: This volume setting applies only to the navigation system's spoken instructions. It does not change the volume of media player and phone calls.

- **Automatic Navigation:** If enabled and your phone's calendar is synced to Model X, you are automatically routed to an event if you get into Model X within two hours of the event's start time (assuming the event on your calendar includes a valid address). When this feature is turned on, Model X also automatically initiates a navigation route to your specified Home and Work locations on weekdays (see [Automatic Navigation on page 145](#)).

- **Trip Planner:** Use trip planner (if available in your market region) to plan your driving and add stops at superchargers if charging is needed to reach a destination to which you are navigating (see [Trip Planner on page 147](#)).
- **Online Routing:** When selected, Model X can automatically reroute you to a navigation destination to avoid delays (see [Online Routing on page 147](#)).
- **Avoid Ferries:** When on, navigation routes avoid the use of ferries.
- **Avoid Tolls:** When on, navigation routes avoid the use of tolls.
- **Use HOV Lanes:** When on, navigation routes include the use of High Occupancy Vehicle (HOV) lanes. This is particularly useful when using Navigate on Autopilot, if equipped (see [Navigate on Autopilot on page 106](#)). You are responsible for ensuring Model X is eligible to use HOV lanes.

NOTE: You can also display these navigation settings by touching the settings icon on the map (see [Maps and Navigation on page 143](#)).

Safety

Allow Mobile Access: Allow your Tesla mobile app to access your Model X (see [Mobile App on page 171](#)).

NOTE: To disable Allow Mobile Access, you must enter your Tesla account credentials.

Parking Brake: Manually apply and release the parking brake (see [Parking Brake on page 69](#)).

Power Off: Manually power off Model X (see [Powering Off on page 54](#)).

Speed Limit Mode: Speed Limit Mode allows you to limit acceleration and limit the maximum driving speed to a chosen value between 50 and 90 mph (80 and 145 km/h). The first time you use this feature, you must create a 4-digit PIN that you must use to enable and disable Speed Limit Mode. When enabled and the driving speed approaches within approximately 3 mph (5 km/h) of the maximum speed, a chime sounds, the instrument panel displays a message, and Model X sends a notification to the mobile app. To enable Speed Limit Mode:

1. Ensure Model X is in Park.
2. Touch **Controls** > **Safety** > **Speed Limit Mode** on the touchscreen, or touch **Controls** in your mobile app.
3. Select the maximum driving speed.
4. Drag the slider to the **On** position.
5. Enter the 4-digit PIN that you want to use to enable and disable Speed Limit Mode.

NOTE: If you forget the PIN, you can disable Speed Limit Mode by entering login credentials for your Tesla account.

NOTE: While Speed Limit Mode is enabled, the acceleration setting (**Controls > Pedals & Steering > Acceleration**) automatically sets to **Chill**.

 **WARNING:** Driving downhill can increase driving speed and cause Model X to exceed your chosen maximum speed.

 **WARNING:** Speed Limit Mode is not a replacement for good judgment, driver training, and the need to closely monitor speed limits and driving conditions. Accidents occur at any speed.

Sentry Mode: When enabled, cameras and sensors remain powered on and ready to record suspicious activity whenever Model X is locked and in Park. See ([Using Sentry Mode on page 162](#)).

Dashcam (if equipped): When enabled, cameras can record and save video footage of the surrounding roadway (see [Using Dashcam on page 162](#)). Customize Dashcam by selecting:

- **Auto:** Dashcam automatically saves a recording to the USB flash drive (if available and installed) in situations where Model X detects a safety event, such as a collision or airbag deployment.
- **Manual:** You must touch the Dashcam icon to save a recording of the most recent 10 minutes of driving to the USB flash drive.
- **Off:** Dashcam is disabled until you select **Auto** or **Manual**.
- **On Honk:** When you press the horn, Dashcam saves a recording of the most recent 10 minutes of driving to the USB flash drive.

Delete Dashcam Clips: Deletes all Dashcam and Sentry Mode footage, including recent and saved clips.

Format USB Drive (if equipped): If a USB flash drive is inserted into a front USB port, touch to format the flash drive to allow Model X to save video recordings using Dashcam, Sentry Mode, if equipped (see [USB Drive Requirements for Recording Videos on page 21](#)).

Park Assist Chimes: If on, a beep sounds when Model X approaches an object while parking (see [Park Assist on page 71](#)).

Joe Mode: If on, Joe Mode lowers the volume of your vehicle's chimes, except for turn signals.

NOTE: Joe Mode may not be available at delivery.

Security Alarm (if equipped): Enable the security alarm (see [Security Settings on page 161](#)).

Tilt/Intrusion: If your vehicle is equipped with the security package, a battery-backed siren sounds in situations where Model X detects motion inside the cabin, or is moved or tilted (for example, with a tow truck or jack). See [Tilt/Intrusion \(if equipped\) on page 161](#).

Passive Entry: If on, doors automatically unlock whenever you approach Model X carrying a key fob. If off, you must use the key fob to unlock Model X. See [Using the Key Fob on page 8](#).

NOTE: You must press the brake pedal to power Model X on before you can change the Passive Entry setting. See [Starting on page 54](#).

NOTE: If Passive Entry is off and you do not press the brake pedal to start Model X within approximately five minutes, a message displays on the instrument panel and you must use the key fob to lock, then unlock Model X again before starting the vehicle.

NOTE: When you enable passive entry, it is recommended that you also enable **PIN to Drive** to increase security (see [PIN to Drive on page 161](#)).

PIN to Drive: Increase security by preventing Model X from being driven until a 4-digit PIN (Personal Identification Number) is entered (see [PIN to Drive on page 161](#)).

Glovebox PIN: For additional security, protect glovebox contents using a 4-digit PIN (see [Glovebox PIN on page 161](#)).

Cabin Overheat Protection: Reduce the temperature of the cabin in extremely hot ambient conditions for a period of up to twelve hours after you exit Model X (see [Cabin Overheat Protection on page 141](#)). Cabin Overheat Protection stops operating after 12 hours, or when the energy remaining in the Battery drops to 20%, whichever occurs first.

Service

Owner's Manual: View the onscreen Owner's Manual. A new version of the onscreen owner's manual is typically provided with every software update and therefore contains more recent information than those provided by Tesla elsewhere (for example, via the web).

Towing: Prepare Model X to be transported by keeping it in Neutral (with the parking brake disengaged), when you exit. See [Instructions for Transporters on page 215](#).

Wheel Configuration: Update your vehicle's wheel configuration if you are installing new wheels or swapping them for different ones. This also displays the correct wheel on your vehicle's avatar on the touchscreen.



CAUTION: Changing your vehicle's wheel configuration can impact range estimates, tire pressure warnings, and vehicle visualization. See [Tire Care and Maintenance on page 184](#).

⚠ WARNING: Only use Tesla-approved wheels when installing or swapping wheels. Using non Tesla-approved wheels can cause serious damage. Tesla is not liable for damage caused by using wheels not approved by Tesla.

Notifications: Display a list of notifications that have recently appeared on your vehicle.

Spoiler Mode (if equipped): The spoiler can change position to provide maximum visibility and the most effective aerodynamics for Model X. To enable, choose **Automatic** (see [Active Spoiler on page 81](#)).

Reset Bluetooth Functionality: (For vehicles manufactured before approximately April 2018) If Bluetooth is taking an exceptionally long time to pair, reset Bluetooth functionality and pair your device again. See [Pairing a Bluetooth Phone on page 154](#).

Camera Calibration (if equipped): Clear the existing calibration of Autopilot cameras to reset the stored camera positions and angles. Once calibration is cleared, you must drive to calibrate the cameras. See [Drive to Calibrate Cameras on page 94](#) for more information.

Factory Reset: Erase all personal data (saved addresses, music favorites, HomeLink programming, etc.) and restore all settings to their factory defaults. This is useful when transferring ownership of Model X. Before erasing, you must enter the credentials for your Tesla account.

Jack Mode: Disables self-leveling of the air suspension system.

⚠ WARNING: The air suspension system causes Model X to self-level, even when powered off. Therefore, when transporting or lifting, you must engage **Jack Mode** to disable self-leveling (see [Instructions for Transporters on page 215](#) and [Jacking and Lifting on page 197](#)).

Wiper Service Mode: Turn on to provide easy access to wiper blades (see [Wiper Blades and Washer Jets on page 193](#)).

Software

Learn more about your Model X and the status of software updates:

- Get more information about your Model X such as the VIN, vehicle name, and odometer. Touch **Additional vehicle information** to display a list of the various options your vehicle is equipped with.
- View your current software version, map version, and release notes.
- View and install new software updates. Model X must be connected to Wi-Fi to update the software.
- Customize how often you want to receive software updates by touching **Software Update Preferences** (see [Software Update Preferences on page 169](#)).

To further personalize Model X, you can name it. Touch **Controls > Software > Name Your Vehicle** located on the right side of the screen below the image of your Model X. If your Model X has already been named, its name displays instead and you can simply touch the existing name to change it. Enter the new name in the popup, then touch **Save**. The name of your Model X also appears in your Tesla mobile app.

Erasing Personal Data

You can erase all personal data (saved addresses, music favorites, HomeLink programming, etc.) and restore all customized settings to their factory defaults. This is useful when transferring ownership of Model X. Touch **Controls > Service > Factory Reset**. Before erasing, Model X verifies your credentials by prompting you to enter the user name and password associated with your Tesla account.



Overview of Climate Controls

Climate controls are available at the bottom of the touchscreen. By default, climate control is set to Auto, which maintains optimum comfort in all but the most severe weather conditions. When you adjust the cabin temperature while in the Auto setting, the system automatically adjusts the heating, air conditioning, air distribution, and fan speed to maintain the cabin at your selected temperature. Touch the display temperature at the bottom of the touchscreen to access the main climate controls screen, where you can adjust your climate preferences. You can revert back to Auto at any time by touching **Auto**. Touch the power button on the main climate controls screen to toggle on or off. For quick access to common controls, touch < or > to display the climate popup.

NOTE: The climate control system is powered by the high voltage Battery. Therefore, prolonged use decreases driving range.

 **WARNING:** To avoid burns resulting from prolonged use, individuals who have peripheral neuropathy, or whose capacity to feel pain is limited because of diabetes, age, neurological injury, or some other condition, should exercise caution when using the climate control system and seat heaters.

Adjusting Climate Controls

NOTE: Easily adjust your climate preferences, such as turning on the seat heater or changing the cabin temperature, hands-free by using voice commands (see [Voice Commands](#) on page 159).

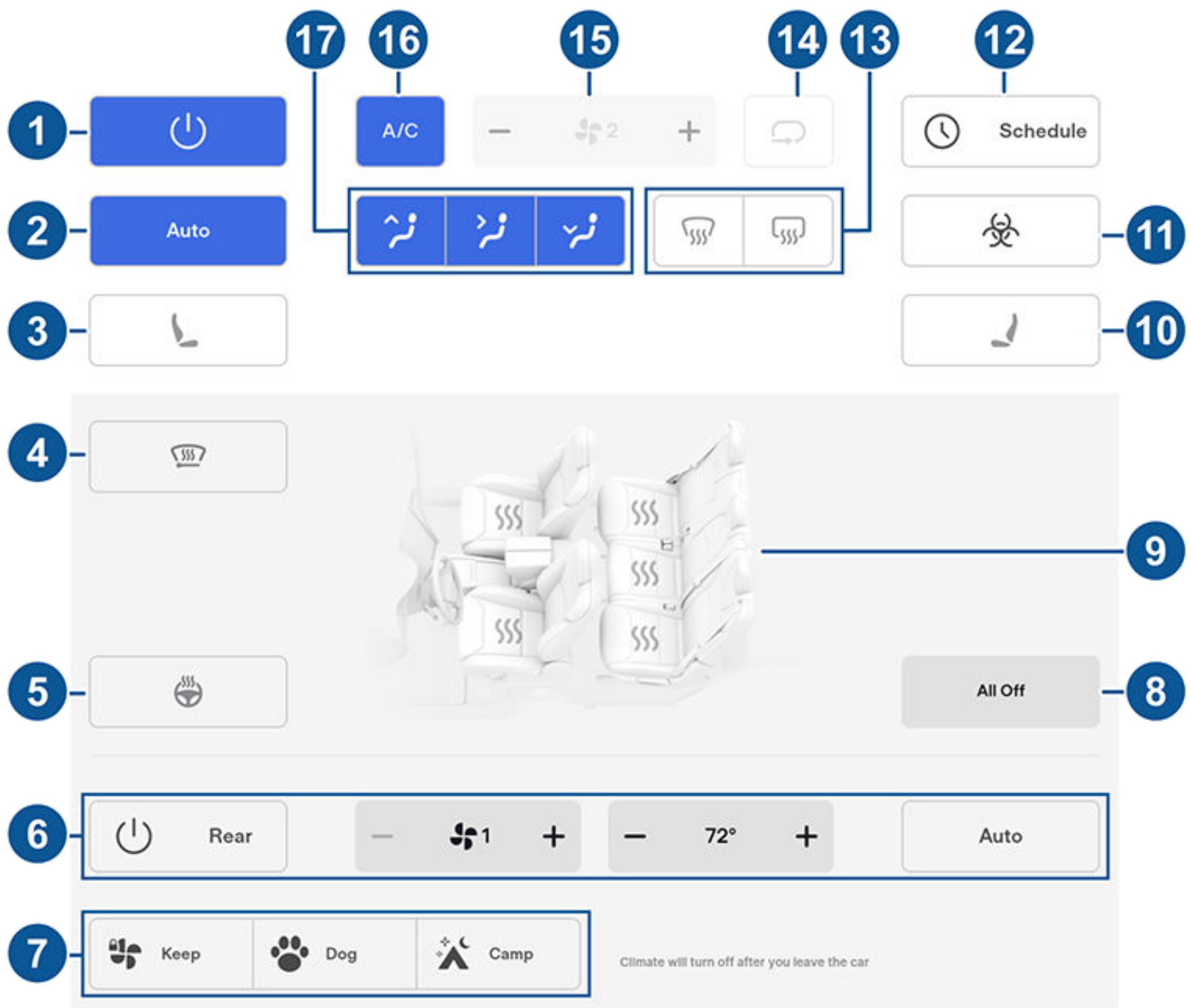

NOTE: For one-touch access to seat heaters and defrosters, you can add these controls to My Apps. See [Customizing My Apps on page 7](#).

1. Touch to turn the climate control system on or off.
2. Touch **Auto** to turn the Auto setting on or off.
3. Touch the driver's side seat icon to adjust seat heaters for the driver. The seat operates at three levels from 3 (highest) to 1 (lowest). For one-touch access to seat heaters, you can add them to the touchscreen's bottom bar (see [Customizing My Apps on page 7](#)).
4. Touch to turn on the wiper defrosters (if equipped). Wipers defrost for 15 minutes then turn off automatically.
5. Touch to turn the heater on or off for the steering wheel.
6. Touch to adjust the climate settings for the rear cabin. Passengers seated in the rear cabin can use the rear touchscreen to turn the rear fan on and off, adjust seat heaters, and control how air flows from the rear vents.
7. When in Park, these settings display to allow you to keep the climate control system operating, even when you leave Model X (see [Keep Climate On, Dog, and Camp on page 141](#)).
8. Touch to turn all seat heaters off.
9. Touch to adjust seat heaters for front and rear seats.

Climate Controls

10. Touch the passenger's side seat icon to adjust seat heaters for the front passenger. The seat operates at three levels from 3 (highest) to 1 (lowest). For one-touch access to seat heaters, you can add them to the touchscreen's bottom bar (see [Customizing My Apps on page 7](#)).
11. If your Model X is equipped with the medical-grade HEPA (High Efficiency Particulate Air) filter, this filter ensures the best quality air inside the cabin whenever the climate control system is on and outside air is entering the cabin (recirculate is off). The HEPA filter is extremely effective at removing particles, including pollution, allergens, bacteria, pollen, mold spores, and viruses. Both the HEPA filter and the secondary filtration system also contain activated carbon to remove a broad spectrum of odors and gases. When you engage Bioweapon Defense Mode, the positive pressure inside the cabin minimizes the amount of outside air that can enter the vehicle.
NOTE: Some gases, such as carbon monoxide, are not effectively removed by activated carbon.
12. When Model X is in Park, touch **Schedule** to set a recurring daily time when you want Model X to be ready to drive by preconditioning the Battery and cabin climate and/or charging during off-peak hours (see [Scheduled Charging and Scheduled Departure on page 179](#)).
13. Touch to turn on the front or rear window defrosters.
14. Touch to control the flow of air inside the cabin. Air can be drawn into Model X from outside or air can be recirculated inside the cabin.
15. Use the slider to adjust the fan speed.
NOTE: Adjusting the fan speed may change the selected setting for how air is drawn into Model X in order to increase or reduce air flow.
16. Touch to turn the air conditioning system on or off. Turning it off reduces cooling, but saves energy.
NOTE: Because Model X runs much quieter than a gasoline-powered vehicle, you may notice the sound of the air conditioning compressor as it is operating. To minimize noise, reduce the fan speed.
17. Choose where air flows into the front cabin (windshield, face-level, or foot-level vents). You can choose more than one location.
NOTE: When air is directed to the foot-level vents, air continues to flow to the windshield vents to assist in defogging. When air is directed to the face-level vents, air does not flow to the windshield.

Climate Popup

Touch the temperature arrows on the bottom of the touchscreen to display a popup for easy access to some of the most common climate controls:

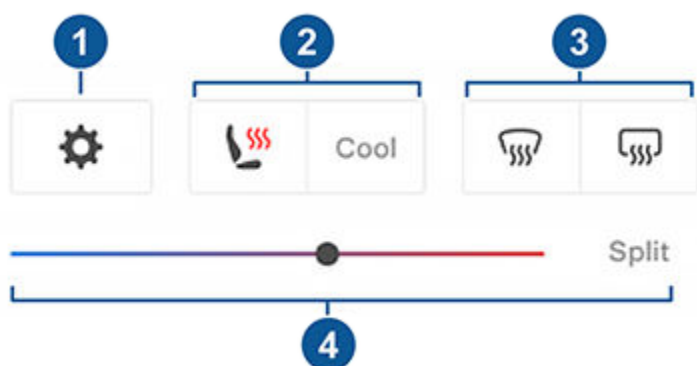

NOTE: For one-touch access to seat heaters and defrosters, you can add these controls to My Apps. See [Customizing My Apps on page 7](#).

1. Touch to access the main climate controls screen.
2. Enable or disable heated or cooling seats (if equipped).
3. Enable or disable the front or rear windshield defrosters.



4. Modify the cabin temperature by dragging along the slider. You can also enable temperature splitting which allows the driver and front passenger to customize their own climate preferences. The front passenger can touch the temperature icon on the bottom of the touchscreen or the main climate controls screen to adjust. Touch **Split** again to disable climate splitting.

Keep Climate On, Dog, and Camp

The **Keep Climate On**, **Dog**, and **Camp** settings allow you to keep the climate control system running when in Park, even after you've left Model X or choose to stay inside the vehicle. These settings are useful when it is important to maintain the cabin temperature in hot or cold weather conditions. For example, when leaving groceries in Model X on hot days, you may want to use Keep Climate On to prevent spoilage.

Dog is designed to maintain a comfortable cabin temperature for your pet while you actively and frequently monitor this temperature using the mobile app (which requires both your phone and the vehicle to have cellular connectivity). When in Dog, the touchscreen displays the current cabin temperature to inform people passing by that your pet is safe. This setting is not intended for people, and should only be used for short periods of time while you stay in close proximity should you need to return to the vehicle in situations where the temperature can no longer be maintained.

Camp allows you to power electronics through the USB ports and low voltage outlet in addition to maintaining the cabin temperature. The touchscreen remains on so you can play music, browse the internet, play games in the arcade, or watch shows in Tesla Theater. You can also control media and climate settings from a paired phone. Camp is ideal for remaining inside your vehicle, such as camping or staying with a child. While active, Sentry Mode and the vehicle alarm system are disabled.

To operate Keep Climate On, Dog, or Camp:

1. Make sure the Battery's charge level is at least 20%.
2. Engage Park. The **Keep Climate On**, **Dog**, and **Camp** settings are available only when Model X is in Park.
3. If necessary, adjust the climate settings.
4. On the climate controls screen, touch **Keep Climate On**, **Dog**, or **Camp**.

NOTE: You can also control **Dog** and **Camp** from the mobile app, by swiping up from the gray bar on the Climate screen.

The climate control system attempts to maintain your climate settings until you shift out of Park or manually turn it off. Avoid using Keep Climate On, Dog, or Camp when the battery charge is low. If the Battery's charge level drops below 20%, the Tesla mobile app attempts to repeatedly send you notifications reminding you to check on anything that you have left in Model X.

NOTE: Software updates cannot be performed when Keep Climate On, Dog, or Camp is active.

NOTE: The intrusion sensor (if equipped) automatically disables when Keep Climate On, Dog, or Camp is active. However, you can override this behavior and keep the intrusion sensor enabled. To do so, touch **Controls** > **Safety** > **Tilt/Intrusion** after enabling Keep Climate On, Dog, or Camp. However, note that keeping the intrusion sensor enabled while Keep Climate On, Dog, or Camp is active can trigger an alarm event as a result of air movement inside the cabin.



WARNING: Never leave a child unattended in your vehicle.



WARNING: Check local laws for any restrictions on leaving pets unattended in your vehicle.



WARNING: You are responsible for the safety of your dog or pet. Never leave them in Model X for long periods of time. Constantly monitor the vehicle temperature and their well-being. Make sure you have sufficient cellular coverage on your phone and time to return to the vehicle, if necessary.



WARNING: In the unlikely event that your climate control system needs service or is not working as expected, avoid using Keep Climate On, Dog, and Camp. Never rely on your vehicle to protect something irreplaceable.



WARNING: You can adjust and monitor the climate control system remotely using the mobile app. However, if you use the mobile app to turn off the climate control system, Keep Climate On, Dog, and Camp stop operating.

Cabin Air Filter(s)

Model X has one or more air filters to prevent pollen, industrial fallout, road dust and other particles from entering through the vents.

NOTE: Cabin air filter(s) require periodic replacement. See [Service Intervals on page 182](#).

Cabin Overheat Protection

The climate control system can reduce the temperature of the cabin in extremely hot ambient conditions for a period of up to twelve hours after you exit Model X. Touch **Controls** > **Safety** > **Cabin Overheat Protection** and choose:

- **Off:** Disable Cabin Overheat Protection.
- **On:** The air conditioning operates when the cabin temperature exceeds 105° F (40° C).



Climate Controls

NOTE: Cabin Overheat Protection operates until 12 hours has elapsed since you exited Model X, or until the Battery energy drops below 20%, whichever comes first.

⚠ WARNING: Never leave children or pets in the vehicle unattended. Due to automatic shut-off or extreme outside conditions, the inside of the vehicle can become dangerously hot, even when Cabin Overheat Protection is enabled.

Climate Control Operating Tips

- When you use the mobile app to turn on the climate control system, it automatically turns off after four hours or if the charge level drops to 20%. To cool or heat the cabin for a longer period, you must turn it on again.
- To conserve energy, turn on Range Mode (if equipped) to limit the power of the climate control system (touch **Controls** > **Pedals & Steering** > **Range Mode**). Cabin heating and cooling may be less effective, but you can use seat heaters to provide warmth in colder climates.
- If the climate control system is louder than you prefer, manually reduce the fan speed.
- In addition to cooling the interior, the air conditioning compressor also cools the Battery. Therefore, in hot weather, the air conditioning compressor can turn on even if you turned it off. This is normal because the system's priority is to cool the Battery to ensure it stays within an optimum temperature range to support longevity and optimum performance.
- Even when not in use, you may hear Model X emit a whining noise or the sound of water circulating. These sounds are normal and occur when the internal cooling systems turn on to support various vehicle functions, such as maintaining the low voltage battery and balancing the temperature of the high voltage Battery.
- To ensure the climate control system operates efficiently, close all windows and ensure that the exterior grille in front of the windshield is free of ice, snow, leaves, and other debris.
- In very humid conditions, it is normal for the windshield to fog slightly when you first turn on the air conditioning.
- It is normal for a small pool of water to form under Model X when parked. Extra water produced by the dehumidifying process is drained underneath.
- To reduce the temperature in the cabin in hot weather conditions, the fan may turn on to vent the cabin when the vehicle is parked. This occurs only if the battery's charge level is above 20%.



Map Overview

The touchscreen displays a map at all times (except when Model X is shifted into Reverse).

Use your finger(s) to interact with the map:

- To move the map in any direction, hold and drag a finger.
- To rotate the map in any direction, hold and turn two fingers.
- To zoom the map in or out, expand or pinch two fingers, respectively.

NOTE: When you rotate or move the map, your current location is no longer tracked. The message "Tracking Disabled" displays briefly next to the map orientation icon and the icon turns gray. To re-enable tracking, touch the map's orientation icon and choose North Up or Heading Up.

NOTE: The map zooms in and out automatically when a navigation route is active.

To change the orientation of the map, toggle between these options:



North Up - North is always at the top of the screen.



Heading Up - The direction you are driving is always at the top of the screen. The map rotates as you change direction. This icon has an integrated compass that indicates the direction you are driving.

NOTE: Touching this icon while navigating to a destination displays the route overview.



The route overview is available when you are navigating to a destination. The route overview also displays when you expand the turn-by-turn direction list (by swiping it downward). When you collapse the turn-by-turn direction list by swiping it upward, the map reverts back to displaying your previously chosen orientation.

Your current location is shown on the map. When you rotate or move the map, your current location is no longer tracked. To re-enable tracking, touch the map's orientation icon to choose North Up or Heading Up. When you touch the map while a navigation route is active, the turn-by-turn direction list displays the next set of directions and the orientation icon disappears. Touch anywhere on the map to re-display it.

Map Display

Touch these icons to customize what the map displays:



Display/hide satellite imagery (if equipped with premium connectivity).



Display/hide traffic conditions (if equipped with premium connectivity). Green lines indicate no traffic; orange lines indicate light traffic; red lines indicate moderate traffic; and pink lines indicate heavy traffic. To ensure traffic is easy to identify along a navigation route, green traffic lines display under the blue route line, whereas orange, red, and pink traffic lines display on top of the blue route line.



Display/hide map details (such as points of interest).

Drop a pin anywhere on the map by pressing and holding your finger on a desired location. When you drop a pin, or touch an existing pin, the chosen location is centered on the map, and a popup screen provides information about the location. From this popup, you can navigate to the location, call the location (if a phone number is available) and add or remove the location from your list of favorite destinations (see [Home, Work, and Favorite Destinations on page 145](#)).



Display/hide all charging locations and a popup list that includes the city and proximity of the corresponding stations on the map. Charging locations include Tesla Superchargers, destination charging sites, third-party fast chargers, and public chargers that you have used previously. See [Charging Locations on page 146](#).

Touch the lightning bolt icons in the popup list to filter by the types of chargers based on max power.

NOTE: In some market regions, third-party fast chargers are also included on the map as dark gray pins when you display chargers.



Navigation Settings



The navigation settings icon displays when you touch ... once you start navigating to a destination.

NOTE: You can also access navigation settings by touching **Controls** > **Navigation**.

Touch the navigation settings icon to customize the navigation system to suit your preferences: (the available settings vary depending on your market region and vehicle configuration):

- Touch **-** or **+** to increase or decrease the volume of spoken navigation instructions. Decreasing all the way to the left, or touching the speaker icon, mutes the instructions. You can also mute/unmute navigation instructions by touching the speaker icon. This volume setting applies only to the navigation system's spoken instructions. Volume for Media Player and Phone is not changed.
- Enable **Automatic Navigation** if you want Model X to automatically initiate a navigation destination when you get in your vehicle. Destinations are predicted based on commonly driven routes, time of day, and calendar entries (see [Automatic Navigation on page 145](#)).
- Enable **Trip Planner** to add supercharger stops as needed. Supercharging stops are added to navigation routes with the goal of minimizing the amount of time you spend driving and charging (see [Trip Planner on page 147](#)).
- Enable **Online Routing** to be automatically rerouted to avoid heavy traffic (see [Online Routing on page 147](#)).
- Touch **Avoid Ferries** to be automatically routed to avoid ferries.
- Touch **Avoid Tolls** to be automatically routed to avoid tolls.
- Touch **Use HOV Lanes** to include High Occupancy Vehicle (HOV) lanes on navigation routes. This is particularly useful when using Navigate on Autopilot (see [Navigate on Autopilot on page 106](#)).

NOTE: *The navigation settings available can vary depending on region and vehicle configuration.*

Navigating to a Destination

To navigate to a location, touch the search bar in the corner of the map and enter a destination, send the destination from your phone, or speak a voice command (see [Voice Commands on page 159](#)). You can enter or speak an address, landmark, business, etc. When you touch the search bar, you can also choose from the following types of locations:

- A saved **Home** or **Work** location (see [Home, Work, and Favorite Destinations on page 145](#)).
- A **Charging** destination (see [Charging Locations on page 146](#)).
- A **Recent** destination (the most recent destination is listed at the top).
- A destination you have marked as a **Favorite** (see [Home, Work, and Favorite Destinations on page 145](#)).
- A popular restaurant when you're feeling **Hungry** or a popular destination (such as museums and amusement parks) when you're feeling **Lucky** (see [I'm Feeling Lucky, Hungry on page 145](#)).

NOTE: If a data connection is not available, onboard maps allow you to navigate to any destination, but you must enter the exact and complete address.

NOTE: You can start navigation remotely from your IOS® or Android™ device using the "share" functionality on your device after allowing access to the Tesla mobile app.

When you specify a location, the touchscreen zooms out to provide an overview of the route you need to travel and displays a turn-by-turn direction list. Estimated arrival time, driving time, and mileage displays at the bottom of the direction list. Battery images at the bottom of the list provide a visual representation showing estimates of how much Battery energy will remain when you reach your destination, and how much will remain if you make a round trip back to your current location. Note the following about the turn-by-turn direction list:

- A battery image provides a visual representation of how much Battery energy will remain when you reach your destination. See [Predicting Energy Usage on page 147](#).
- If charging is needed to reach your destination and Trip Planner is enabled (and available in your market region), the navigation route automatically includes Supercharger stops (see [Trip Planner on page 147](#)).
- If you won't have enough energy to reach your destination and there is no Supercharger on the route, an alert tells you that charging is needed to reach your destination.
- Each turn is preceded by the distance to the maneuver.
- To see the bottom of the list, you may need to drag the list upward.
- Touch the top of the list to minimize it.

While navigating, the map tracks your location and displays the current leg of your trip. You can display the entire route at any time by swiping down to expand the turn-by-turn direction list or touching the route overview icon.



If **Navigate on Autopilot** (if available in your market region) is enabled, you can turn it on for the navigation route by touching **Navigate on Autopilot** in the turn-by-turn direction list. **Navigate on Autopilot** is a full self-driving (Beta) feature that automatically changes lanes and steers Model X along a navigation route, exiting controlled-access highways, etc. For details, see [Navigate on Autopilot on page 106](#).

To stop navigating, touch **END**, located in the bottom corner of the turn-by-turn direction list.

Adding Stops to a Route

After you have entered a destination, you can edit your route by adding, deleting or reordering stops. Touch the three dots at the bottom of the turn-by-turn direction list to view options to edit your route.



Add Stop allows you to add a stop by searching for a location or adding a Home, Recent or Favorite destination. You can also add a stop by touching any pin on the map and selecting **Add** from the popup.



Edit Stop allows you to set up a complex trip by adding or deleting stops on your route. Drag and drop stops by touching the equal sign to reorder your trip.

Automatic Navigation

NOTE: *Automatic Navigation may not be available in all market regions and on all vehicle configurations.*

Automatic Navigation can predict a destination when you get in your vehicle. When your phone's calendar is synced to Model X, and the calendar includes an event that takes place within two hours of when you get in your vehicle to drive, Automatic Navigation suggests the location of the event (assuming a valid address is associated with the event).

In addition, if you are Home and get in your vehicle on weekdays (Monday to Friday) from 5:00 AM to 11:00 AM, Automatic Navigation can automatically route you to your specified Work location (see [Home, Work, and Favorite Destinations on page 145](#)). Likewise, if you are at work on weekdays from 3:00 PM to 11:00 PM, Automatic Navigation can automatically route you to your specified Home location.

To enable Automatic Navigation, touch **Controls** > **Navigation** > **Automatic Navigation**. You must have your phone's calendar synced to Model X and the event must include a uniquely specified and valid address (see [Phone and Calendar on page 154](#)).

NOTE: Navigation instructions that you enter manually, or send to Model X, override routes suggested by Automatic Navigation.

I'm Feeling Lucky, Hungry

NOTE: *"I'm Feeling Lucky" and "I'm Feeling Hungry" may not be available in all market regions and on all vehicle configurations.*

In addition to navigating to a destination of your choice, Model X can also suggest nearby locations based on whether you are feeling **Hungry** or **Lucky**. In the navigation search bar, touch **Hungry** or **Lucky**. **Hungry** suggests popular restaurants, whereas **Lucky** suggests popular destinations (such as museums and amusement parks). For a new suggestion, go back and touch **Hungry** or **Lucky** again for different results. When you discover a destination that interests you, touch **Navigate** to proceed to the destination.

This feature requires the latest version of Navigation maps. To download, connect Model X to Wi-Fi and touch **Controls** > **Software** to check if an update is available (see [Map Updates on page 147](#)).

Home, Work, and Favorite Destinations

If you frequently drive to a destination, you may want to add it as a favorite to avoid having to enter the location's name or address each time. When you add a destination as a Favorite, you can easily navigate to it by touching the navigation search bar and then touching **Favorites** and choosing it from your list of favorite destinations.



To add a destination to your Favorites list touch its pin on the map, then touch the star icon on the popup screen that appears. Enter a name (or leave as-is to accept the default name), then touch **Add to Favorites**. The star becomes solid and the destination is included on your Favorites list.

To delete a Recent or Favorite destination, touch it on the destination list and hold it down briefly until the **X** appears. Then touch the **X** to delete it from the list.

Home and **Work** locations also display under the map's search bar. Touch to set an address to the corresponding location. After entering the address, touch **Save as Home** or **Save as Work**. Then simply touch these shortcuts whenever you want to navigate home or to work.

To change or delete the address associated with Home or Work, press and hold its icon and in the popup screen that displays, enter a new address and touch **Save as Home** or **Save as Work**, or touch **Clear Home** or **Clear Work**.

NOTE: Based on your usage patterns, Model X may prompt you to save a location as Home or Work.



Maps and Navigation

NOTE: Once a Home or Work location is saved, Model X may prompt you to navigate to your Work location in the mornings and to your Home location in the evenings and provide an estimated driving time based on current traffic conditions. See [Automatic Navigation on page 145](#).

For security reasons, if you sell Model X, it is recommended that you delete your Home and Work locations. You can delete these individually or you can perform a factory reset to erase all personal data (touch **Controls > Service > Factory Reset**).

Charging Locations

To display charging locations on the map, touch the map's search bar, then touch **Charging**. Charging locations are shown in a list (with the closest charging location at the top of the list) and represented by corresponding pins on the map. Touch a pin to display more information, navigate to it, or mark it as a favorite.

Touch the lightning bolt icons to specify the types of charging locations you want the map to include (by default, the map displays only superchargers):

 Touch to include destination chargers.

 Touch to include standard superchargers.

 Touch to include high-powered superchargers.

NOTE: In some market regions, third-party fast chargers are also included as dark gray pins when you choose to display all charging stations.

The appearance of a charging location's pin reveals status information about the location. Touch the pin to display details.



The Supercharger location is operational and the number displayed on the pin represents the number of available Supercharger stalls.

NOTE: A Supercharger located on your current navigation route is colored black (or white, if the touchscreen is in night mode).



The Supercharger location is experiencing a high volume of users and you may need to wait before charging.



The Supercharger location may be operating at a reduced capacity.



The Supercharger location may be closed.



The Supercharger location has no data available but should be operational.



The location is either a destination charging location, a third-party fast charger, or a public charging station that you have previously used. Touch to display more information such as usage restrictions and available charge current.

NOTE: When the map is zoomed out and more than one destination charging location is available in an area, the pin is round and displays the number of stations. Touch the pin to zoom in. Then you can touch an individual pin for details about a specific location.

Touch a charging location's pin to display a popup from which you can:

- Determine its exact location and approximate distance from your current location.
- View amenities that are available at the charging location, including restrooms, restaurants, lodging, shopping, and Wi-Fi. On a supercharger popup, touch an amenity icon to search the surrounding area for the associated amenity.
- Touch the navigation icon to navigate to the charging location.

NOTE: When navigating to a Supercharger (or third-party fast charger in some regions), Model X preconditions the Battery to prepare for charging. This ensures you arrive with an optimal Battery temperature, reducing the amount of time it takes to charge. In some circumstances (such as cold weather), it is normal for the motor(s) and components to make noise as it generates heat to warm the Battery (see [Warming the Battery Before Supercharging on page 92](#)).



Predicting Energy Usage

When navigating to a destination, Model X helps you anticipate your charging needs by calculating the amount of energy that remains when you reach your destination. The calculation is an estimate based on driving style (predicted speed, etc.) and environmental factors (elevation changes, temperature, etc.). When navigating, the map displays this calculation at the bottom of the expanded turn-by-turn direction list (see [Navigating to a Destination on page 144](#)). When the turn-by-turn direction list is compressed, touch the top of the list to expand it.

Throughout your route, Model X monitors energy usage and updates the calculation. A popup warning displays at the bottom of the turn-by-turn direction list in these situations:

- A yellow warning displays when you have very little energy remaining to reach your destination, requiring you to drive slowly to conserve energy. For tips on conserving energy, see [Getting Maximum Range on page 77](#).
- A red warning displays when you must charge to reach your destination.

To determine if you have enough energy for a round trip, touch the battery icon at the bottom of the turn-by-turn direction list to display an estimated calculation of your round trip energy usage.

Online Routing

Model X detects real-time traffic conditions and automatically adjusts the estimated driving and arrival times. In situations where traffic conditions will delay your estimated time of arrival and an alternate route is available, the navigation system can reroute you to your destination. You can also specify the minimum number of minutes that must be saved before you are rerouted. To turn this feature on or off, touch the map's settings icon (see [Navigation Settings on page 144](#)), then touch **Online Routing**.

Trip Planner

Trip Planner helps you take longer road trips with confidence. If reaching your destination requires charging, Trip Planner routes you through the appropriate Supercharger locations. Trip Planner selects a route and provides charging times to minimize the amount of time you spend driving and charging. To enable Trip Planner, touch the map's settings icon (see [Navigation Settings on page 144](#)), then touch **Trip Planner**.

When Trip Planner is enabled and charging is required to reach your destination, the turn-by-turn direction list includes Supercharger stops, recommended charging times at each Supercharger, and an estimate of how much energy will be available when you arrive at the Supercharger location.

NOTE: When navigating to a Supercharger or, in some regions, a third-party fast charger using Trip Planner, Model X may allocate some energy to pre-heat the Battery to arrive at the Supercharger or third-party fast charger with an optimal Battery temperature. This reduces charging time (see [Warming the Battery Before Supercharging on page 92](#)).

To remove Supercharger stops and display directions only, touch **Remove all charging stops** at the bottom of the turn-by-turn direction list. If you remove charging stops, the turn-by-turn direction list may display an alert indicating that charging is needed to reach your destination. To add Supercharger stops back to the turn-by-turn direction list, touch **Add charging stops**.

While charging at a Supercharger, the charging screen displays the remaining charging time needed to drive to your next Supercharger stop, or destination (if no further charging is needed). If you charge for a shorter or longer length of time, charging time at subsequent Supercharger stops is adjusted accordingly.

NOTE: You can also use the mobile app to monitor remaining charging time needed.

NOTE: If a Supercharger on your navigation route experiences an outage, Trip Planner displays a notification and attempts to reroute you to a different Supercharger location.

If Trip Planner estimates that you won't have enough energy for your round trip, and there are no Superchargers available on your route, Trip Planner displays an alert at the top of the turn-by-turn direction list notifying you that charging is needed to reach your destination.

Map Updates

As updated maps become available, they are automatically sent to Model X over Wi-Fi. To ensure you receive them, periodically connect Model X to a Wi-Fi network (see [Connecting to Wi-Fi on page 168](#)). The touchscreen displays a message informing you when new maps are installed.

Overview

The Media Player displays on the touchscreen and is used to play various types of media. You can drag Media Player upward to expand it (allowing you to browse), and downward to minimize it so that just the Miniplayer displays. The convenient Miniplayer, which occupies the least amount of space on the touchscreen, displays what's currently playing and provides only the basic functions associated with what's playing.

Media Player displays content and options associated with the app (or source) you choose from the app launcher, or from the dropdown list that displays when you maximize Media Player:

NOTE: *Media apps vary depending on market region. Some apps described may not be available in your market region, or may be replaced by different ones.*



Radio: Choose from a list of available radio stations or touch the numeric keypad to directly tune the radio to a specific frequency. Touch the next or previous arrows to move from one frequency to the next (or previous).



Bluetooth: Play audio from a bluetooth-connected phone or USB device (see [Playing Media from Devices on page 149](#)).



Streaming: Play the audio streaming service available in your market region (for example, Slacker Radio), if equipped.



Spotify: Play audio available on Spotify.

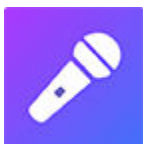

Karaoke: Sing along with various songs (see [Karaoke on page 149](#)).



Tuneln: Play audio available on Tuneln.

NOTE: You can show or hide any media app/source. See [Media Settings on page 148](#).

When listening to internet radio or a music streaming service, the options available on the Media Player screen vary depending on what you are listening to. Touch the next (or previous) arrows to play the next (and in some cases previous) available station, episode, or track. You can also play next/previous using the left scroll button on the steering wheel.

Streaming services are available only when a data connection is available (for example, Wi-Fi or Premium Connectivity). For some media services, you can use a default Tesla account. For others, you may need to enter account credentials the first time you use it.

NOTE: Instead of launching a different media app, you can change the source from within the Media Player screen by choosing a source from the dropdown list on the left side.

NOTE: You can use voice commands to adjust media settings and preferences, such as volume control, playing certain songs, or switching the media source (see [Voice Commands on page 159](#)).

Volume Controls

Roll the scroll button on the left side of the steering wheel up or down to increase or decrease volume respectively. The scroll button adjusts the volume for media, voice commands, and phone calls.

You can also adjust the volume by touching the arrows associated with the speaker icon on the bottom corner of the touchscreen.

To mute the volume, press the left scroll button. Press again to unmute.

NOTE: Pressing the left scroll button during a phone call mutes both the sound and your microphone.

NOTE: If you're playing media and you receive a phone call, or the navigation system is speaking directions, the volume of what you are listening to is temporarily muted.

Media Settings

NOTE: *The settings available vary depending on market region. Also, a setting may not be applicable to all audio sources.*



When displaying an audio source screen, press the settings icon located in the search bar to access audio settings.

You can adjust these settings:

- **Tone:** Drag the sliders to adjust the subwoofer and any of the five frequency bands (Bass, Bass/Mid, Mid, Mid/Treble, and Treble). If equipped with premium audio, you can adjust the level of sound immersion to make your music experience more engaging by dragging the immersive sound slider according to your preferences.
- **Balance:** Drag the center circle to the location in Model X where you want to focus the sound.
- **Options:** Set preferences for optional features. For example, you can turn **DJ Commentary**, **Explicit Content**, and **Allow Mobile Control** on or off.
- **Sources:** Displays all available media sources and allows you to choose whether you want to show or hide each source. You may want to hide media sources that you never use. Once hidden, the media source does not appear on the drop down list in Media Player, nor will it appear in the app tray when you touch the App Launcher. You can re-display a hidden media source at any time by returning to this settings screen.

Searching Audio Content



Touch Media Player's magnifying glass icon to search for a particular song, album, artist, podcast, or station. You can also use voice commands to search hands-free (see [Voice Commands on page 159](#)). If available, touch **HD**® to play high definition versions of the selected frequency.

Caraoke

In addition to various streaming services, your vehicle is equipped with Caraoke. To access Caraoke, navigate to Media Player and select the drop down menu to change the media source to Caraoke. Or add Caraoke as an app in the app launcher. You can browse through various songs and select the song you want to sing. Touch the microphone icon to enable or disable the song's main vocals. Disabling the microphone leaves only the song's instrumentals and background vocals. Touch the lyrics icon (located next to the microphone icon) to enable or disable the song's lyrics.

NOTE: Depending on vehicle configuration and market region, Caraoke may not be available on your vehicle.



WARNING: Never read Caraoke lyrics while driving. You must always pay attention to the road and traffic conditions. When driving, the Caraoke lyrics are intended only for use by a passenger.

Recents and Favorites

For most source content, recents and favorites display at the top for easy access.



To add a currently playing station, podcast, or audio file to your Favorites list, touch the **Favorites** icon on Media Player.



To remove an item as a favorite, touch the highlighted **Favorites** icon. You can also remove multiple favorites by expanding Media Player to show all favorites for the applicable type of source content. Then press and hold any favorite. An **X** appears on all favorites and you can then touch the **X** to remove them from your Favorites list.



Your recently played selections are updated continuously so you don't need to remove them.

NOTE: Selections you play on FM radio are not included in the Recents list.

Playing Media from Devices

You can play audio files from a Bluetooth-connected device (like a phone) or a USB-connected flash drive. When you connect a Bluetooth or USB device, Media Player includes the device as a media source.

USB Connected Flash Drives

Insert a flash drive into a front USB port (see [USB Ports on page 21](#)). Touch **Media Player** > **USB**, and then touch the name of the folder that contains the song you want to play. After you display the contents of a folder on the USB connected flash drive, you can touch any song in the list to play it. Or use the previous and next arrows in Media Player to scroll through your songs. You can also scroll to next/previous songs using the left scroll button on the steering wheel.

NOTE: To play media from a USB connection, Model X recognizes flash drives only. To play media from other types of devices (such as an iPod), you must connect the device using Bluetooth.

NOTE: Media Player supports USB flash drives with exFAT formatting (NTFS is not currently supported).

NOTE: Use a USB port located at the front of the center console. The USB connections at the rear of the console are for charging only.

Bluetooth Connected Devices

If you have a Bluetooth-capable device such as a phone that is paired and connected to Model X (see [Pairing a Bluetooth Phone on page 154](#)), you can play audio files stored on it. Choose Media Player's **Phone** source, touch the name of your Bluetooth-connected device, then touch **CONNECT**.



Media

Your Bluetooth device begins playing the audio file that is currently active on your device. If no audio file is playing, use your device to choose the audio file you want to listen to. When the chosen file begins to play, you can then use Media Player's next and previous icons (or use the left scroll button on the steering wheel) to play other tracks.

NOTE: To play media from a Bluetooth-connected device, ensure that access to the device's media is turned on (see [Pairing a Bluetooth Phone on page 154](#)).



Overview

NOTE: Entertainment options vary by market region.

The touchscreen displays the Entertainment screen when you choose any of the following apps:



Theater: Play various video streaming services (such as Netflix, YouTube, Hulu, etc.) while parked.



Arcade: Want to game? Depending on the game, you may need to use the steering wheel buttons or a USB controller to play arcade games.



Toybox: Play in the Toybox while parked.



Browser: Access the web browser.

WARNING: Use entertainment features only when Model X is parked. Always pay attention to road and traffic conditions when driving. Using these features while driving is illegal and very dangerous.

NOTE: Many entertainment features can be easily accessed hands-free using voice commands (see [Voice Commands on page 159](#)).

Toybox

Select This...	To Do This...
007	You are no longer a "Driver", you're a "Diver"! Touch Controls > Suspension to change your depth.
Boombox	Joy to the world! If Model X is equipped with a Pedestrian Warning System, delight pedestrians with a variety of sounds from your vehicle's external speaker while in Park. See Boombox on page 152 for more details. NOTE: Check local laws before use in public spaces.
Emissions Testing Mode	Holiday fun can come in surprising ways. Select your preferred fart style and target seat. For those lucky vehicles equipped with a Pedestrian Warning System, you can choose to broadcast externally when in Park. Use your turn signal or press the left scroll wheel when you're ready to "release" your prank.
Light Show	Park outside, turn the volume up, roll down your windows, then enjoy the show.
Ludicrous Speed (P100D vehicles only)	Press and hold the Ludicrous setting (touch Controls > Driving > Acceleration > Ludicrous) for approximately five seconds. Touch Yes, bring it on! if you want to go fast. To display power and acceleration readings on the instrument panel, press either scroll button briefly until the available options are displayed. Then, roll the scroll button to highlight Readout then press the scroll button again.
Mars	The map shows your Model X as a rover on the Martian landscape, and the About Your Tesla box displays SpaceX's interplanetary spaceship.



Rainbow Charge Port	When Model X is locked and charging, press the button on the mobile connector ten times in quick succession. Neat, huh?
Rainbow Road	Need more cowbell? Visit Rainbow Road by pulling the Autopilot stalk toward you four times in quick succession while Autosteer is enabled.
Romance Mode	You can't roast chestnuts by an open fire in your car, but you can still cozy up with your loved ones by this virtual fireplace. While in Park, access Romance Mode from your Toybox. Queue the music and get your romance on!
Sketchpad	Channel your inner Picasso. Show us what you got! Touch Publish to submit your artistic compositions to Tesla for critiquing.
TRAX	It's never too late to follow your dream of becoming a world-famous DJ. With TRAX, you can turn your vehicle into your own personal music studio. While in Park, choose from an array of instruments and unique sounds to create the next hit song. Access TRAX through your Toybox on the touchscreen and get jamming. Microphone and headset not included (depending on vehicle configuration and market region, this may not be available on your vehicle).
The Answer to the Ultimate Question of Life, The Universe, and Everything	Rename your car to 42 (touch Controls > Software and touch the vehicle's name). Notice the new name of your Model X.

Boombox

Boombox, an app in Toybox, uses the Pedestrian Warning System (PWS) speaker (if equipped) to play media externally when Model X is parked. When Boombox is enabled, you can control external volume only when playing current media. You can customize sounds by plugging in a specifically-formatted USB drive.

NOTE: Check local laws before using Boombox in public places.

1. Play current media

- Available in Park only.
- Internal and external volume control.
- If Camp Mode is enabled in Climate Controls, you can exit the car and control the volume with the mobile app.

2. Megaphone

When toggled on, you can project a modulated voice through the external speaker of Model X.

- Available in Park only.
- External volume control.

3. Horn sound

- Available in Park only.
- Settings can be adjusted only when in Park.
- Selecting from a USB drive plays the first five seconds.

Formatting a USB drive for Boombox

You can add up to five custom Boombox sounds.

1. Using a computer, format a USB drive to exFAT, MS-DOS FAT (for Mac), ext3, or ext4 (NTFS is currently not supported) and upload audio files to a folder named **Boombox**.
 - Supported file types: .wav and .mp3.
 - You can add as many files as you want to the folder, but you can only select from the first five, as listed alphabetically.
 - File names, of any length, can only contain these characters: a-z, A-Z, 0-9, (. - _).
 - The drive should only contain one folder; it cannot be shared with Dashcam.



2. Plug the USB drive into a front USB port.
3. Choose sounds from your USB drive by selecting them in the **Boombbox** dropdown menus.



Bluetooth® Compatibility



You can use your Bluetooth-capable phone hands-free in Model X provided your phone is within operating range. Although Bluetooth typically supports wireless communication over distances of up to approximately 30 feet (nine meters), performance can vary based on the phone you are using.

Before using your phone with Model X, you must pair it. Pairing sets up Model X to work with your Bluetooth-capable phone (see [Pairing a Bluetooth Phone on page 154](#)).

You can pair up to ten Bluetooth phones. Unless you've specified a specific phone as a **Priority Device** or if the phone specified as **Priority Device** is not within range, Model X always connects to the last phone that was used (provided it is within range). To connect to a different phone, see [Bluetooth® Compatibility on page 154](#).

NOTE: On many phones, Bluetooth turns off if the phone's battery is low.

NOTE: In addition to phones, you can pair other Bluetooth-enabled devices with Model X. For example, you can pair an iPod Touch, an iPad, an Android tablet, etc. from which you can play music.

Pairing a Bluetooth Phone

Pairing allows you to use your Bluetooth-capable phone hands-free to make and receive phone calls, access your contact list, recent calls, etc. It also allows you to play media files from your phone. Once a phone is paired, Model X can connect to it whenever the phone is within range.

To pair a phone, follow these steps while sitting inside Model X:

1. Ensure both the touchscreen and the phone are powered on.
2. On your phone, enable Bluetooth and ensure it is discoverable.
NOTE: On some phones, this may require you to go to Bluetooth Settings for the remainder of the procedure.
3. Touch the Bluetooth icon located at the top of the touchscreen.
4. On the touchscreen, touch **Add New Device > Start Search**. A list of all available Bluetooth devices within operating distance displays on the Bluetooth settings screen.

5. Choose the phone with which you want to pair. Within a few seconds, the Bluetooth settings screen displays a randomly generated number. Your phone also display a number.
6. Check that the number displayed on your phone matches the number on the Bluetooths settings screen. Then, on your phone, confirm that you want to pair.
7. If prompted on your phone, specify whether you want to allow Model X to access your personal information, such as calendar, contacts and media files.

When paired, Model X automatically connects to the phone, and the Bluetooth settings screen displays the Bluetooth symbol next to the phone's name to indicate that the connection is active.

You can display the Bluetooth settings screen at any time and change the settings associated with a connected device. For example, you can designate a connected phone as the **Priority Device**. This is useful in situations where you have connected more than one phone, and both phones are frequently used in Model X at the same time. Model X automatically attempts to connect to the priority device before others. If a priority device is not specified, or is not within range, Model X connects to the most recently used phone (if applicable).

For vehicles manufactured prior to approximately April 2018: If Bluetooth takes an exceptionally long time to pair, reset Bluetooth functionality by touching **Controls > Service > Reset Bluetooth**. You may need to wait a few minutes. Once reset, try pairing to Model X again. After you reset Bluetooth functionality, the vehicle may forget any previously paired devices.

Importing Contacts and Recent Calls

Once paired, use the Bluetooth settings screen to specify whether you want to allow access to your phone's calendar, contacts and recent calls. If you allow access, you can use the phone app to make calls and send messages to people in your list of contacts and on your recent calls list (see [Bluetooth® Compatibility on page 154](#)). Before contacts can be imported, you may need to either set your phone to allow syncing, or respond to a popup on your phone to confirm that you want to sync contacts. This varies depending on the type of phone you are using. For details, refer to the documentation provided with your phone.

NOTE: You can turn access to your contacts and recent calls on or off at any time by displaying the Bluetooth settings screen, choosing the phone, and then changing the associated access settings.



Unpairing a Bluetooth Phone

If you want to disconnect your phone and use it again later, simply touch **Disconnect** on the Bluetooth settings screen. If you no longer want to use your phone with Model X, touch **Forget This Device**. Once you forget a device, you must pair it again if you want to use it with Model X (see [Pairing a Bluetooth Phone on page 154](#)).

NOTE: Your phone automatically disconnects when you leave Model X.

NOTE: Unpairing the phone has no effect on using the phone as a key. To forget an authenticated phone, see [Keys and Doors on page 8](#).

Connecting to a Paired Phone

Model X automatically connects to a phone that you designated as **Priority Device** on the Bluetooth settings screen. If you have not set a phone as a priority, Model X connects to the last phone to which it was connected, provided it is within operating range and has Bluetooth turned on. If the last phone is not within range, it attempts to connect with the next phone that it has been paired with.

To connect to a different phone, touch the Bluetooth icon at the top of the touchscreen. The Bluetooth settings screen displays a list of paired phones. Choose the phone you want to connect to, then touch **Connect**. If the phone you want to connect to is not listed, you must pair the phone. See [Pairing a Bluetooth Phone on page 154](#).

When connected, the Bluetooth settings screen displays the Bluetooth symbol next to the phone's name to show that Model X is connected to the phone.

Using the Phone App



When your phone is connected to Model X using Bluetooth, and you have allowed access to information on your phone (see [Importing Contacts and Recent Calls on page 154](#)), you can use the phone app to display and make a hands-free call to anyone listed on your phone.

- **Calls**- Displays recent calls in chronological order with the most recent call listed first.
- **Messages**- Displays message in chronological order with the most recent message listed first. You can view, send, and receive text messages. Instead of typing a text message, touch the microphone button on the right side of the steering wheel to enter text using your voice.



WARNING: To minimize distraction and ensure the safety of vehicle occupants as well as other road users, do not view or send text messages when the vehicle is in motion. Pay attention to road and traffic conditions at all times when driving.

- **Contacts**- Contacts are listed in alphabetical order and can be sorted by first name or last name. You can also choose a letter on the right side of the list to quickly scroll to the names that begin with the selected character. When you touch a name on your contacts list, the contact's available number(s) displays on the right pane, along with other available information (such as address). Touch the contact's number to make a call.
- **Favorites**- Displays the contacts from your phone that you have identified as Favorites.
- **Calendar**- Displays calendar entries from your phone (see [Calendar on page 156](#)). If an entry includes a phone number or an address, you can make a phone call, or navigate to a destination, by touching the corresponding information in the calendar entry.

Making a Phone Call

You can make a phone call by:

- Speaking a voice command (see [Voice Commands on page 159](#)). Voice commands are a convenient, hands-free way to call or text your contacts.
- Selecting a contact or recent call from the menu on your right scroll button (see [Using Right Steering Wheel Buttons on page 51](#)).
- Touching a phone number shown in a list in the phone app - Contacts, Calls, or Calendar.
- Using the Model X on-screen dialer in the Phone app's Calls list.

NOTE: If it is safe and legal to do so, you can also initiate a call by dialing the number or selecting the contact directly from your phone.

NOTE: You can also make a phone call by touching a pin on the map and choosing the phone number (if available) on the popup screen.

Receiving a Phone Call

When your phone receives an incoming call, the instrument panel and touchscreen display the caller's number or name (if the caller is in your phone's contact list and Model X has access to your contacts).

Touch one of the options on the touchscreen to **Answer** or **Ignore** the call. Depending on the phone you are using and what speakers you used for your most recent call, your phone may prompt you to choose which speakers you want to use for the incoming call.



Phone and Calendar

WARNING: Stay focused on the road at all times while driving. Using or programming a phone while driving, even with Bluetooth enabled, can result in serious injury or death.

WARNING: Follow all applicable laws regarding the use of phones while driving, including, but not limited to, laws that prohibit texting and require hands-free operation at all times.

In Call Options

When a call is in progress, you can display the call menu on the instrument panel by pressing the top button on the right side of the steering wheel. Then roll the right scroll button and choose an option (see [Using Right Steering Wheel Buttons on page 51](#)). To adjust the call volume, roll the steering wheel's left scroll button during a call.

In Call Options

When a call is in progress, the call menu displays on the touchscreen. Then roll the right scroll button to choose an option. To adjust the call volume, roll the steering wheel's left scroll button during a call.

Calendar



The calendar displays scheduled events from your phone's (iPhone® or Android™) calendar for the current and next day. The calendar is conveniently integrated with the phone app so you can navigate to, or dial into, your next meeting.

Using the calendar requires that:

- The Tesla mobile app is running, you are logged in, and the mobile app's **Calendar Sync** setting is turned on. The mobile app can then periodically (and automatically) send calendar data from your phone to Model X.

NOTE: To ensure you have access to all of the calendar's features, it is recommended that you use the most recent version of the mobile app.

- Your phone is connected to Model X via Bluetooth (for privacy reasons, Model X displays calendar data only from a connected phone). In situations when your vehicle is not connected to a phone, touch **Connect Phone** on the calendar list.
- Mobile access is turned on (**Controls > Safety > Allow Mobile Access**).
- Both your phone and your vehicle have good connectivity.

If a calendar event includes an address, a navigation arrow displays to indicate that you can touch the address to navigate to the event's location. When an event on your calendar takes place within the next hour and has a uniquely specified address, the touchscreen notifies you if there is a better route due to traffic, even when you're not actively using navigation.

If an event has a uniquely specified address and takes place within two hours of you entering your vehicle and preparing to drive, Model X automatically routes you to the event's address (see [Automatic Navigation on page 145](#)).

Touch an event's information icon to display all notes associated with the event. If the notes include one or more phone numbers, the information icon shows a phone icon and the calendar displays the first phone number found. Touch to initiate a phone call. You can also initiate a phone call by touching any number in an event's notes popup screen (this is especially useful for conference calls). If notes include a web link, you can touch the link to open it in the Web browser.



NOTE: When Model X starts, you may hear the sound of the compressor as the air suspension system's reservoir fills with air.

Your Model X is equipped with Adaptive Air Suspension that offers superior ride quality and allows you to choose a softer or firmer ride based on your preference. When carrying loads, the system also maintains a level height between the front and rear. You can manually adjust the ride height to suit your circumstances (for example, you can raise Model X when you need extra ground clearance, such as when driving on a steep driveway or ramp, in deep snow, over large speed bumps, parking curbs, etc.).



If a fault is detected that reduces the performance of the adaptive air suspension system, a yellow indicator lights up on the instrument panel. If the problem persists, contact Tesla.



If a fault is detected that disables the adaptive air suspension system, a red indicator lights up on the instrument panel. Contact Tesla.

Adjusting Ride Height



CAUTION: Before adjusting the suspension height, ensure Model X is clear of all obstacles, above and below.

You can manually adjust the ride height by pressing the brake pedal touching **Controls > Suspension** on the touchscreen. The ride height settings that are available depend on your driving speed and other conditions (for example, the suspension does not lower if a door is open). The touchscreen also displays the approximate ground clearance for each setting. Drag the slider to choose from these options:

- **Very High** - When set to **Very High**, the suspension automatically lowers to the default ride height* (**Standard** or **Low**) after driving approximately 100 feet (30 meters) or when driving speed reaches 15 mph (24 km/h). To maintain the **Very High** setting for an unlimited distance until your driving speed reaches the speed threshold, touch **Keep until 15 mph**.
- **High** - When set to **High**, the suspension automatically lowers to the default ride height* (**Standard** or **Low**) after driving approximately 100 feet (30 meters) or when driving speed reaches 35 mph (56 km/h). To maintain the **High** setting for an unlimited distance until your driving speed reaches the speed threshold, touch **Keep until 35 mph**.
- **Standard** - The **Standard** setting ensures optimum comfort and handling under all loading conditions.

- **Low** - Lowering the height can improve aerodynamics, make it easier to load or unload cargo and passengers, and improve handling.
- **Very Low** - This setting takes effect only when you manually choose it. The suspension reverts to the default setting on your next drive.



CAUTION: Avoid driving aggressively (hard accelerations, sharp turns, etc.) when the suspension is set to **High** or **Very High**. Doing so can cause vibration and increase the possibility of damage.



CAUTION: Acceleration may be reduced when the suspension is set to **High** or **Very High**.

Adaptive Suspension Damping

The settings associated with **Adaptive Suspension Damping** provide real-time adjustments to the suspension system to optimize both ride and handling. Choose from:

- **Comfort** - Provides a gentler ride for a relaxed driving experience.
- **Auto** - Adjusts to a wide range of roads and driving styles, providing a fluid yet well controlled ride.
- **Sport** - Provides a firmer, more controlled ride that increases driver engagement and connection to the road.
- **Advanced** - Can be used to fine tune the suspension by dragging individual sliders that adjust **Ride Comfort** and **Handling**.

Touch **Show Suspension Data** to display detailed information about the dampers for each wheel, including ride height, compression and rebound values, and body accelerations.

Use Comfort Damping in Autopilot (if equipped) - By default, damping automatically sets to the **Comfort** setting when using Autopilot, and reverts back to your chosen setting when Autopilot is no longer in use. Turn this setting off to disable this feature.

Real-time Visualization

The image of your Model X on the Suspension screen provides a real-time visualization of the status of the air suspension system. In addition to visually showing changes to the ride height, it displays Compression and Rebound lines that reflect how the suspension system is controlling the dampers for each wheel based on your chosen settings and changing road conditions. Both are controlled simultaneously. Touch **Show Suspension Data** to display detailed information about the dampers for each wheel, including ride height, compression and rebound values, and body accelerations.



Air Suspension

NOTE: The instrument panel can also display a real-time visualization of how the suspension system is dynamically adjusting each wheel's damping to account for changing road conditions. To view, hold the respective steering wheel scroll button briefly until the available options are displayed. Roll the scroll button to highlight **Suspension**, then tap the scroll button.

Auto-Raising Locations

Whenever you raise the suspension to **High** or **Very High**, the location is automatically saved. By saving the location, you do not need to manually raise the suspension every time you arrive at a frequently-used location where you have previously raised the suspension. When you return to the saved location, Model X raises the suspension and the instrument panel displays a message indicating that the suspension is being raised.

When saving locations, Model X also saves the **Keep until XX mph** setting (if specified).

NOTE: When returning to a saved location and driving faster than the **High** and **Very High** suspension settings allow, the suspension does not raise until Model X slows down.

NOTE: After leaving a saved location, the suspension automatically lowers. However, it may not lower until Model X meets the speed and distance threshold at which the suspension lowers.

NOTE: If Model X reaches a saved location and the existing suspension setting is already higher than the level that has been saved for that location, the ride height is not adjusted.

To remove an auto-raising location

If you do not want the suspension to automatically raise at a location, touch to deselect **Always raise at this location** in the popup that appears when you arrive at a saved location.

Self-Leveling

Model X equipped with air suspension automatically self-levels, even when power is off. To prevent damage when jacking or lifting the vehicle, you must activate **Jack Mode** to disable self-leveling (press the brake pedal and touch **Controls > Service > Jack Mode**). For more details, see [Jack Mode on page 197](#).



Use voice commands to easily control settings and preferences without using the touchscreen. You can ask Model X to do just about anything, such as adjusting climate controls and media preferences. Available commands include most features that are managed by the touchscreen except driving-related commands, for example shifting drive modes.

Voice commands are designed to understand natural requests. You can use voice commands to:

- Adjust climate preferences.
- Tweak the windshield wiper speed and frequency.
- Control various aspects of your vehicle.
- Navigate to a location.
- Call a contact.
- Interact with apps and settings.

To initiate a voice command, touch the voice button on the right side of the steering wheel. When you hear a chime, make your request and the vehicle responds.



Examples of Voice Commands

Here is a list of example voice commands. This is not an exhaustive list. Tesla is constantly working to improve voice commands.

NOTE: To choose the language you want to use for voice commands, touch **Controls > Display > Voice Recognition Language**.

Climate Controls

Adjust your climate preferences using voice commands:

- "Make it cooler"

- "Make it warmer"
- "Turn on/off the driver's seat heater"
- "Cool down the passenger"
- "Direct airflow to my face"
- "Sync climate"
- "Increase/decrease the fan speed"
- "Turn on/off rear defroster"
- "Set the temperature/fan..."
- "Turn on recirculate"

Windshield Wipers

Update the windshield wiper speed and frequency based on changing road and weather conditions:

- "Speed up the wipers"
- "Increase/decrease windshield wiper speed by..."
- "Turn on/off the wipers"

Vehicle Controls

You can also modify various controls in your vehicle using voice commands:

NOTE: Your vehicle must be in Park to enable some voice commands (such as Sentry Mode, Dog Mode, etc.).

- "Sentry Mode on/off"
- "Keep my car safe"
- "Lock/unlock the doors"
- "Turn on Dog Mode"
- "Fold/unfold the mirrors"
- "Open/close charge port"
- "Start/stop charging"
- "Open service settings"
- "Open the glovebox"

Navigation

To search for, or navigate to, a location, say:

- "Where is [location]?"
- "Drive to [location]"
- "Navigate to [location]"
- "Show nearby Superchargers"
- "I'm feeling hungry/lucky" (see [I'm Feeling Lucky, Hungry on page 145](#)).
- "Stop navigation"
- "Mute voice guidance"



Voice Commands

If you have defined a navigation address for your home or work locations, you can use a voice command to navigate there by saying "Navigate home" or "Take me to work".

Contacts

To call or text a contact on your Bluetooth-connected phone (see [Phone and Calendar on page 154](#)), say:

- "Call [contact name/phone number]"
- "Text [contact name/phone number]"

Media

To listen to and adjust your media preferences, say:

- "Listen to [song name]"
- "Lower/raise the volume"
- "Skip to next"
- "Pause/play song"
- "Change the source to [media source]"

To improve voice command recognition accuracy, provide multiple cues in your command, such as artist and song.

Apps and Settings

Easily navigate through your apps and settings using voice commands:

- "Open [Toybox/browser/theater/phone]"
- "Search for..."
- "The screen is too bright"
- "Show me the Owner's Manual"

Some apps and settings are only accessible while in Park.

You can also file a bug report by saying "Report", "Feedback", or "Bug report".

For a complete list of voice commands, go to <https://www.tesla.com/support/voice-commands>.

NOTE: Tesla is continuously improving the ability of Model X to recognize voice commands. To support these ongoing quality improvements, Tesla captures short voice recordings anonymously. To protect your privacy, these short recordings are not associated with your personal information or with your vehicle's identification number. Tesla assures that it is not possible to search any system for a recording associated with a specific customer or vehicle.



About the Security System

If Model X does not detect a key nearby and a locked door or trunk is opened, an alarm sounds. The headlights and turn signals also flash. To deactivate the alarm, press any button on the key fob.

To manually enable or disable the alarm system, touch **Controls > Safety > Security Alarm**. When enabled, Model X activates its alarm one minute after you exit, the doors lock, and a recognized key is no longer detected.

A battery-backed siren (if equipped) sounds in situations where a locked door or trunk is opened and Model X does not detect a key nearby. If you also want this siren to sound in situations where the vehicle detects motion inside the cabin, enable **Tilt/Intrusion** (see [Tilt/Intrusion \(if equipped\) on page 161](#)).

NOTE: If Model X is in Sentry Mode (see [Using Sentry Mode on page 162](#)), you must disable Sentry Mode before you can disable the Security alarm or the Tilt/Intrusion alarm.

Tilt/Intrusion (if equipped)

The **Security Alarm** must be on to enable **Tilt/Intrusion**.

Tilt/Intrusion sounds the alarm in your vehicle if Model X detects motion inside the cabin, or is moved or tilted (for example, with a tow truck or jack). To enable, touch **Controls > Safety > Tilt/Intrusion**.

The intrusion sensor automatically disables in situations where the climate control system is operating when you leave your vehicle. To override, you can manually turn the Tilt/Intrusion Sensor on again after choosing Keep Climate On, Dog, or Camp Mode.

NOTE: If you plan to leave something that moves inside your locked vehicle, remember to turn off **Tilt/Intrusion**. If this setting is on, any motion detected inside Model X activates the intrusion alarm.

Enhanced Anti-Theft Upgrade (if equipped)

If your vehicle is equipped with the Enhanced Anti-Theft upgrade, the horn sounds in situations where a locked door or trunk is opened and Model X does not detect a key nearby. If **Tilt/Intrusion** is on, the horn also sounds if Model X detects motion inside the cabin or if the vehicle is moved or tilted (for example, with a tow truck or jack). To turn the Tilt/Intrusion detection system on or off, touch **Controls > Safety > Tilt/Intrusion**.

PIN to Drive

To increase security, you can prevent Model X from being driven until a 4-digit PIN (Personal Identification Number) is entered. To enable this setting, touch **Controls > Safety > PIN to Drive** and follow the on-screen prompts to create a driving PIN.

When enabled, in addition to entering the 4-digit driving PIN to drive, you must also use it to enter Valet mode for the first time and create the 4-digit valet PIN to enter and exit Valet mode. In Valet mode, Model X can be driven without the need for the valet to enter a driving PIN. The **PIN to Drive** setting is disabled whenever Valet mode is active.

If you forget your driving PIN, touch the link to enter your Tesla login credentials on the PIN to Drive popup, then follow the on-screen prompts.

NOTE: In the unlikely event that your touchscreen is unresponsive, you may be unable to enter the PIN. In this case, first try to restart the touchscreen (see [Restarting the Touchscreen on page 54](#)). If the touchscreen is still unresponsive, you can still bypass PIN to Drive by turning on Keyless Driving in the Tesla mobile app.

Glovebox PIN

For additional security, you can protect the contents in your glovebox with a 4-digit PIN. To enable this setting, touch **Controls > Safety > Glovebox PIN** and follow the on-screen prompts. When enabled, you are prompted to enter the PIN to open the glovebox. To disable this setting, select the toggle to disable and then enter the PIN.

If you forget your glovebox PIN, reset it by entering your Tesla login credentials, then follow the on-screen prompts.

NOTE: When you open the glovebox with **Glovebox PIN** while Valet mode is enabled, Valet mode disables after the glovebox opens.



Dashcam and Sentry Mode

NOTE: Depending on market region, vehicle configuration, options purchased, and software version, your vehicle may not be equipped with Dashcam or Sentry Mode or the features may not operate exactly as described. **Please note it is your sole responsibility to consult and comply with all local regulations and property restrictions regarding the use of cameras.**

In addition to supporting Autopilot, the exterior cameras can record and store video footage of the vehicle's surroundings on a USB flash drive. This can be convenient in situations where you want a video recording of a particular incident. If set to AUTO, Dashcam saves video recordings of collisions when driving. On the other hand, if enabled, Sentry Mode is the alarm system that monitors the environment around your vehicle when it is locked and in Park. After an incident is detected, Sentry Mode responds according to the level of threat detected.

NOTE: Dashcam and Sentry Mode will not record video when Dashcam is OFF.

NOTE: To protect your privacy, video recordings are saved locally to onboard memory or the USB flash drive. Recordings are not sent to Tesla.

Using Dashcam

Dashcam records footage of your vehicle's surroundings only when Model X is powered on (see [Starting and Powering Off on page 54](#)). Dashcam does not record video when your vehicle is powered off. Use Dashcam to record driving incidents, such as a collision.

Dashcam requires a properly formatted USB flash drive, inserted into a front USB port (preferably in the glovebox) in order to store and retrieve footage (see [USB Drive Requirements for Recording Videos on page 21](#)).

Enable Dashcam by going to **Controls > Safety > Dashcam** and choose:

- **Auto:** Dashcam automatically saves a recording to the USB flash drive in situations where Model X detects a safety event, such as a collision or airbag deployment. When **Auto** is selected, detection can vary and is subject to your vehicle's power, sleep, and Autopilot state.

NOTE: Several factors determine whether or not Dashcam automatically saves a recording of a safety event (for example, amount of force, whether or not airbags deployed, etc.). Do not rely on Dashcam to automatically record video of all safety events.

- **Manual:** You must touch the Dashcam icon to save a recording of the most recent 10 minutes of driving to the USB flash drive.
- **On Honk:** When you press the horn, Dashcam saves a recording of the most recent 10 minutes of driving to the USB flash drive.

Once enabled, you can manually save clips by touching:



The Dashcam icon in the app launcher while the vehicle is in Drive (you can add the Dashcam app to My Apps at the bottom of the touchscreen for easy access, see [Customizing My Apps on page 7](#)). The touchscreen displays a message confirming if the footage is saved. When Model X is in Park, touching the Dashcam icon brings up the Viewer.



The Dashcam icon at the top of the touchscreen.

The Dashcam controls are:



RECORDING: Shows that Dashcam is recording. To save video footage, touch the icon. To pause recording, press and hold the icon.



PAUSED: Shows that Dashcam is paused. To resume recording, touch the icon. To avoid losing video footage, pause Dashcam before removing the flash drive.



SAVED: Shows that footage is saved.

To view Dashcam footage, see [Viewing Video Recordings on page 163](#).

Using Sentry Mode

When Sentry Mode is turned on, the cameras and sensors remain powered on and ready to record suspicious activity around your vehicle when Model X is locked and in Park.

To store and retrieve Sentry Mode footage, ensure that Dashcam is on and a properly formatted USB flash drive is inserted into a front USB port (preferably in the glovebox) (see [Using Dashcam on page 162](#)).

If you want Sentry Mode to automatically turn on every time you leave your vehicle, touch **Controls > Sentry Mode > On**. There are three additional settings for customization:

- **Exclude Home:** Sentry Mode does not operate at the location you set as Home in your favorites list (see [Home, Work, and Favorite Destinations on page 145](#)), but operates at any other parking location.



NOTE: To set up your Home location, touch **Navigate** and hold down **Home**, then enter your address. Touch **Save as Home**.

- **Exclude Work:** Sentry Mode does not operate at the location you set as Work in your Favorites list, but operates at any other parking location. Set your Work location the same way you set your Home location.
- **Exclude Favorites:** Sentry Mode does not operate at any location in your Favorites list, but activates at any other parking location.

NOTE: To recognize a location listed as Home, Work, or a Favorite, Model X must be parked within 32 feet (10 meters) of the saved location.

NOTE: Sentry Mode will not record video when Dashcam is OFF.



To manually turn Sentry Mode on or off, touch the Sentry Mode icon at the top of your touchscreen.

Manually turning Sentry Mode on or off using the touchscreen or the mobile app overrides your Home, Work, or Favorite exclusion preferences until the next time you drive.

Alternatively, you can use voice commands or the Tesla mobile app. To enable Sentry Mode using voice commands, say "Keep Tesla safe," "Keep my car safe," "Sentry on," or "Enable Sentry" (see [Voice Commands on page 159](#)).

Sentry Mode requires your Battery to be at least 20% charged. If the Battery falls below 20%, Sentry Mode turns off and the mobile app sends you a notification. Power consumption may increase when Sentry Mode is active.

NOTE: Software updates cannot be installed when Sentry Mode is turned on.

 **CAUTION:** Do not rely on Sentry Mode to protect Model X from all possible security threats. While it may help deter some threats, no security system can prevent all attacks.

To view Sentry Mode footage, see [Viewing Video Recordings on page 163](#).

Standby, Alert, and Alarm States

While in Sentry Mode, Model X may shift through three states as a response to its surroundings—Standby, Alert, and Alarm:

- **Standby.** Model X is automatically "on standby" when you activate Sentry Mode. The cameras constantly monitor the surrounding area for possible security threats.

- **Alert.** If Sentry Mode detects a possible threat, such as someone very close to, or leaning on, Model X, Sentry Mode switches to the Alert state, where:
 - Headlights briefly flicker.
 - The touchscreen displays a message indicating that cameras are recording.
 - Sentry Mode saves the most recent 10 minutes of footage prior to the triggered event to the USB flash drive (if available and installed).
- **Alarm.** For major threats, Sentry Mode:
 - Activates the security alarm and the audio system generates a loud and unexpected sound.
 - Sends an alert to the mobile app on phones that are paired to Model X to inform you that the alarm state is triggered.
 - Saves the most recent 10 minutes of footage prior to the triggered event to the USB flash drive (if available and installed).
 - Returns to the Standby state after 30 seconds.
 - For vehicles manufactured after approximately April 2018: Saves up to two minutes of footage to the vehicle's internal storage for safekeeping which can be manually saved to a USB flash drive (if available and installed) using the Dashcam viewer.

 **CAUTION:** Sentry Mode may not activate the security alarm in all situations involving damage to the vehicle. Sentry Mode uses many factors to determine whether to activate the security alarm—all impacts may not be detected and the alarm may not activate in all situations.

NOTE: When the internal storage reaches full capacity, new recordings from Alert and Alarm events overwrite the older recordings.

Viewing Video Recordings

You can view recorded footage on the touchscreen when Model X is in Park. Touch the Dashcam icon located in the app launcher or the Dashcam icon at the top of the touchscreen. Touch the menu icon in the top corner of the screen. The tabs display a list of all video clips, organized by location and timestamp. Pause, rewind, fast forward, and delete video recordings as needed. You can also navigate to **Controls > Safety > Delete Dashcam Clips** to delete all dashcam and Sentry Mode footage, including recent and saved clips.

NOTE: Dashcam recording pauses when you launch the Viewer.

You can also view video footage by removing and inserting the USB flash drive into a computer and navigating to the TeslaCam (if equipped) folder.

The TeslaCam folder contains three sub-folders:



Dashcam and Sentry Mode

- **Recent Clips:** When recording, Dashcam continuously saves footage to Recent Clips in 60-minute cycles. Footage is overwritten every hour unless you manually save it. Four videos are recorded for each clip, one from each camera (front, rear, left, and right).

NOTE: Rear camera recordings are available only on vehicles manufactured after approximately February 2018.

- **Saved Clips:** Contains all recordings that are saved using Dashcam.
- **Sentry Clips:** Contains the last 10 minutes of footage from all Sentry Mode events that triggered an Alert or Alarm state. If storage space on the USB flash drive becomes limited, the oldest Sentry Clips are deleted to provide space for new ones. Once deleted, you cannot retrieve them.

When the USB flash drive runs out of storage space, video footage can no longer be saved. To prevent the flash drive from getting full, regularly move saved videos to another device and delete them from the flash drive.



About HomeLink



If your vehicle is equipped with the HomeLink® Universal Transceiver, you can operate up to three Radio Frequency (RF) devices, including garage doors, gates, lights, and security systems.

NOTE: Depending on date of manufacture, market region, and options selected at time of purchase, some vehicles are not equipped with a HomeLink Universal Transceiver.

WARNING: Do not use the HomeLink Universal Transceiver with a device that does not have safety stop and reverse features. Using a device without these safety features increases the risk of injury or death.

Supported Modes

HomeLink supports three different transmit modes, which is how your vehicle and the RF device communicate. Selecting a transmit mode is determined by your RF device's compatibility:

- **Standard Mode:** Use Standard Mode if your RF device is equipped with a remote control that must be used to operate the device (for example, a remote-controlled garage door). This mode is the most commonly used transmit mode for HomeLink devices.
- **D-Mode or UR-Mode:** Use D-Mode or UR-Mode if the RF device does not have a remote control, and the receiver has a "Learn" button (may also be called "Program" or "Smart"). D-Mode and UR-Mode function similarly in that Model X communicates directly with the device's receiver as opposed to the remote control.

NOTE: D-Mode is used primarily in North America whereas UR-Mode is popular in Europe, the Middle East, and Asia. To determine the mode your device is compatible with, contact HomeLink (www.homelink.com or call 1-800-355-3515).

Each of your devices can be set to a different mode. For example, your garage door can be set to Standard Mode, your front gate can be set to D-Mode, etc. To change a transmit mode, touch the HomeLink icon at the top of the touchscreen and select the device you want to change. Then, select **Program** and choose the desired mode for your device. Confirm by touching **Set Mode** and follow the onscreen instructions.

For older vehicles, changing the mode for one device changes the mode for all devices, so be careful when changing transmit modes. Devices not compatible with your selected mode may not work. Touch the HomeLink icon at the top of the touchscreen, then touch **Change Transmit Mode**.

NOTE: Check the product information for your HomeLink device to determine which mode is compatible with your device.

Programming HomeLink

To program HomeLink®:

1. Park Model X so that the front bumper is in front of the device you want to program.



CAUTION: Your device might open or close during programming. Therefore, before programming, make sure that the device is clear of any people or objects.

2. Check that the device's remote control has a healthy battery. Tesla recommends replacing the battery in the device's remote control before Programming HomeLink.
3. Touch the HomeLink icon at the top of the touchscreen.
4. Touch **Create HomeLink**.
5. Select the mode you wish to use: Standard, D-Mode, or UR-Mode (see [Supported Modes on page 165](#)).
6. On the touchscreen, enter a name for your device, then and touch **Enter** or **Create HomeLink**.
7. Touch **Start** and follow the onscreen instructions.

NOTE: If you see a screen called "Train the receiver" while programming the device, remember that this is a time-sensitive step. After pressing the Learn/Program/Smart button on the device's remote control, you have only approximately 30 seconds to return to your vehicle and press **Continue**, and then press the trained HomeLink device name twice. Consider having an assistant to ensure you can complete this step within 30 seconds.

8. Once your device is programmed, touch **Save** to complete the programming.
9. Ensure HomeLink works as expected. In some cases, you may need to repeat the programming process multiple times before succeeding.

Once programmed, you can operate the device by touching its corresponding HomeLink icon on the touchscreen. HomeLink remembers the location of your programmed devices. When you approach a known location, the HomeLink control on the touchscreen automatically appears. When you drive away, it disappears.

NOTE: For additional assistance or compatibility questions, contact HomeLink (www.homelink.com or call 1-800-355-3515).



Auto Opening and Closing

To operate a HomeLink device without using the touchscreen, you can automate the device to open as you approach, and close as you drive away:

1. Touch the HomeLink icon at the top of the touchscreen, then choose the device you want to automate.
2. Select the **Auto-open when arriving** checkbox if you want the device to open as you approach.
3. Touch the arrows to specify the distance you want Model X to be from the device before it opens.
4. Select the **Auto-close when leaving** checkbox if you want the device to close as you drive away.

As you approach (or drive away from) a device that is set to operate automatically, the HomeLink status icon displays a count-down message to let you know when the device automatically opens or closes. In situations where you don't want the device to automatically open or close, touch **Skip Auto-Open** or **Skip Auto-Close** at any time during the count-down message.

NOTE: Do not rely on HomeLink to ensure the device fully closes.

Resetting the Location of the HomeLink Device

If you experience situations in which you sometimes drive up to your HomeLink device and it doesn't open, or the touchscreen does not display a notification as you approach a programmed device, you may need to reset the device's location. To do so, park as close as possible to the HomeLink device (garage door, gate, etc.) and display the HomeLink settings page by touching the HomeLink icon at the top of the touchscreen. Touch the name of the device you want to reset, then touch **Reset Location**.

Deleting a Device

To delete a HomeLink device, touch the HomeLink icon at the top of the touchscreen. Touch the name of the device you want to delete, then touch **Delete**.

NOTE: You can also perform a factory reset to erase your HomeLink settings, along with all other personal data (saved addresses, music favorites, imported contacts, etc.). See [Erasing Personal Data on page 137](#).

NOTE: For security reasons, delete your HomeLink devices if you sell your Model X.

Troubleshooting HomeLink

Standard Mode

In Standard Mode, Model X records the RF signal from your HomeLink device's remote control. The touchscreen instructs you to stand in front of the vehicle, point the device's remote control at the front bumper, and press and hold the button until the headlights flash. When the headlights flash, Model X has learned the remote control and you can touch **Continue** on the touchscreen. If the headlights do not flash:

- Check the batteries in the remote control. It is a good idea to replace the batteries before you start programming.
- Ensure you are standing in front of Model X with the device's remote control positioned within two inches (five cm) of the Tesla emblem.
- Press and hold the button on your device's remote control until the headlights flash. In some cases you must hold the button on the remote control for up to three minutes.

NOTE: Some HomeLink remote controls require multiple short presses (approximately one second each press) instead of one long duration press. If you are unsuccessful after multiple attempts of using long presses, try repeated presses of one second each.

D-Mode and UR-Mode

In D Mode and UR-Mode, the device's receiver learns Model X. The touchscreen instructs you to press the "Learn" button (may also be called "Program" or "Smart") on the device's receiver. If this does not work, refer to the following guidelines:

- Park Model X with its bumper as close as possible to the garage door, gate, etc. that you are trying to program.
- Make sure you are pressing the receiver's Learn/Program/Smart button. For instructions on how to put the receiver into learning mode, refer to the product details provided with your RF device that you are trying to program.
- If you see a screen called "Train the receiver" while programming the device, remember that this is a time-sensitive step. After pressing the Learn/Program/Smart button on the device's remote control or receiver, you only have approximately 30 seconds to return to your vehicle, press **Continue**, then press the trained HomeLink device name twice. Consider having someone assist you with this step.
- Most devices stay in learning mode for only three to five minutes. Immediately after pressing the device's Learn/Program/Smart button, follow the instructions displayed on the vehicle's touchscreen.



For additional assistance or compatibility questions, contact HomeLink (www.homelink.com or call 1-800-355-3515).



Connecting to Wi-Fi

Wi-Fi is available as a data connection method and is often faster than cellular data networks. Connecting to Wi-Fi is especially useful in areas with limited or no cellular connectivity. To ensure fast, reliable delivery of software and map updates, Tesla recommends leaving Model X connected to a Wi-Fi network whenever possible (for example, when parked overnight).

To connect to a Wi-Fi network:

1. Touch **Controls** > **Wi-Fi icon** at the top of the touchscreen. Model X begins to scan and display detected Wi-Fi networks that are within range.
NOTE: If a known Wi-Fi network does not appear in the list, move Model X closer to the access point or consider using a range extender.
2. Select the Wi-Fi network you want to use, enter the password (if necessary), then touch **Confirm**.
3. Model X connects to the Wi-Fi network. Whenever the network is within range, Model X connects to it automatically.

You can also connect to a hidden network that isn't shown on the list of scanned networks. Just touch **Wi-Fi Settings**, enter the name of the network in the resulting dialog box, select the security setting, then touch **Add Network**.

NOTE: If more than one previously connected network is within range, Model X connects to the one most recently used.

NOTE: At Tesla Service Centers, Model X automatically connects to the Tesla Service Wi-Fi network.

Hotspots and Connectivity

You can also use a mobile hotspot or your phone's Internet connection via Wi-Fi tethering (subject to fees and restrictions of your mobile carrier) to access the internet. To remain connected to Wi-Fi when shifting into Drive or Reverse, choose the connection from the Wi-Fi settings screen, then touch **Remain connected in Drive**.



Loading New Software

Tesla updates your vehicle's software wirelessly, constantly providing new features. Tesla recommends you install software updates as soon as they are available on your vehicle. To ensure the fastest and most reliable delivery of software updates, leave Wi-Fi turned on and connected whenever possible. In most cases, your vehicle must be connected to Wi-Fi to start an update (see [Connecting to Wi-Fi on page 168](#)).

Software updates are not performed when the following features are active:

- Smart Preconditioning,
- Keep Climate On, Dog Mode, or Camp Mode
- Sentry Mode

NOTE: On an as-needed basis, Tesla also sends software updates using a cellular connection.

 **WARNING:** Do not attempt to use the vehicle while the software is being updated. Vehicle functions, including some safety systems, may be limited or disabled when a software update is in progress and you could damage the vehicle.

When a software update is available, a yellow clock icon appears at the top of the touchscreen. There are three ways you can install software updates:

- Touch the yellow clock icon to display the scheduling screen, which prompts you to select a time to install the update (**Set For This Time**) or install it now (**Install Now**). Once scheduled, the yellow clock icon changes to a white clock icon until the update begins. At any time before the update begins, you can touch this clock icon to reschedule the update.
- Touch **Controls > Software** to determine if an update is available for your vehicle. If available, touch **Software Update Available** to navigate to the scheduling screen, as mentioned above.
- Start updates using the Tesla mobile app.

NOTE: Some software updates can take up to three hours to complete. Model X must be in Park while the software is being updated. To ensure the fastest and most reliable delivery of software updates, leave the Wi-Fi turned on and connected whenever possible (see [Connecting to Wi-Fi on page 168](#)).

The yellow clock icon becomes a green download icon when a software update is downloading. If a yellow download icon displays, a software update is available but your vehicle is not connected to Wi-Fi. Connect your vehicle to Wi-Fi to start the download.

Software Update Preferences

You can choose how quickly and often you receive software updates. To change your preference, touch **Controls > Software > Software Update Preferences** and choose either of these options:

- **Standard:** Receive software updates using the normal rollout timeframe for your region and vehicle configuration. When a software release is made available it has generally been running on other customer vehicles for a period of time.
- **Advanced:** Receive the latest software updates for your region and vehicle configuration as soon as they are available. Tesla determines how, when, and where to send updates to vehicles based on various factors unique to each release. Keep in mind that although you receive updates as soon as they are available for your specific vehicle, you may not be in the first Tesla group of Tesla owners to receive the update. Choosing Advanced does not enroll your vehicle in Tesla's early access program.

NOTE: Tesla does not update software upon request for those wanting to receive the latest features and improvements. Selecting **Advanced** and consistently connecting to Wi-Fi (see [Connecting to Wi-Fi on page 168](#)) is the best way to receive the latest software updates.

NOTE: The software update screen persists until you install the update. You must install a software update as soon it becomes available. Any harm resulting from failure to install a software update is not covered by the vehicle's warranty. Failure or refusal to install updates can cause some vehicle features to become inaccessible, digital media devices to become incompatible, and can limit Tesla's ability to diagnose and service your vehicle.

NOTE: Reverting to a previous software version is not possible.

If the touchscreen displays a message indicating that a software update was not successfully completed, contact Tesla.

Charging

If Model X is charging when the software update begins, charging stops. Charging resumes automatically when the software update is complete. If you are driving Model X at the scheduled update time, the update is canceled and must be rescheduled.

Viewing Release Notes

When a software update is complete, read the release notes displayed on the touchscreen to learn about changes or new features. To display release notes about the current version of your vehicle's software at any time, touch **Controls > Software > Release Notes**.



Software Updates

Tesla strongly recommends reading all release notes. They may contain important safety information or operating instructions for your Model X.

The Tesla mobile app allows you to communicate with Model X remotely using your iPhone® or Android™ phone.

NOTE: The information below may not represent an exhaustive list of the functions available on the Tesla mobile app. To ensure access to new and improved features, download updated versions of the mobile app as they become available.

To Use the Mobile App

To set up the Tesla mobile app to communicate with your Model X:

1. Download the Tesla mobile app to your phone.
2. Log in to the Tesla mobile app by entering your Tesla account credentials.
3. Enable mobile access to your Model X by touching **Controls > Safety > Mobile Access** (see [Controls on page 132](#)).

Your phone and vehicle must both be actively connected to cellular service to allow the mobile app to communicate with your vehicle. Tesla recommends that you always have a functional physical key readily available if parking in an area with limited or absent cellular service, such as an indoor parking garage.

NOTE: In the event that you require lockout assistance from Tesla due to a non-warranty issue, such as having limited cellular connectivity and having no secondary key available, your expenses are not covered under the Roadside Assistance policy.

NOTE: Tesla does not support the use of third party applications to contact Model X.

Overview

The Tesla mobile app's home screen allows you to:

- See the name of your vehicle (if you have one).
- View your vehicle's estimated range.
- See which drive mode the vehicle is in (Park, Reverse, Neutral, Drive).
- Lock or unlock your vehicle.
- Enable maximum defrost to warm your vehicle in cold conditions.
- Check your vehicle's charging information and open or close the charge port.
- Open the front trunk.
- View your vehicle's odometer, VIN, and current firmware version.

Media settings appear on the mobile app to pause, play, rewind, fast forward, and adjust the volume of the media currently playing in the vehicle.

For supported video sources, send videos to Tesla Theater by sharing the link through the mobile app. Navigate to the movie, show, or video you want to play on your phone and touch the share button. Share the video with the Tesla app and it appears on the touchscreen if Model X is in Park.

Profile

In the Profile tab located at the top corner of your phone's screen (shown as an avatar icon), you can:

- Switch to a different vehicle associated with your Tesla account, if you have access to more than one.
- Navigate the Tesla Shop.
- Access the Tesla inbox.
- Manage your account information and view your order history.
- View and customize notifications you receive under the Settings tab, such as Calendar sync, when your security alarm has been triggered, charging updates, and new software updates. You can start updates from afar and check its progress.

Controls

The Controls tab allows you to do the following:

- Open the front or rear trunk.
- Lock or unlock Model X from afar.
- Open or close the charge port.
- Flash the lights or honk the horn to find where Model X is parked.
- Enable Keyless Driving.

NOTE: Keyless Driving can be used when you do not have your key or to bypass PIN to Drive in cases where you forgot your PIN or your touchscreen is unresponsive (see [PIN to Drive on page 161](#)).

- Open and close your garage door if your vehicle has a programmed HomeLink connection, if available (see [HomeLink Universal Transceiver on page 165](#)).
- Vent the windows.

Climate

You can check the interior temperature and heat or cool the cabin before driving (even if it's in a garage), control the seat heaters, and defrost the windshield:

- Enable or disable defrost by swiping up the from bottom , which helps melt snow, ice, and frost on the windshield, windows, and mirrors.
- Enable or disable **Dog Mode** or **Camp Mode**.



Mobile App

- Customizing climate controls allows you to precondition the cabin to your desired temperature and turn on or off the steering wheel and seat heaters.
- Vent the windows.

Using the mobile app to precondition Model X also warms the Battery as needed. The mobile app will notify you once your vehicle has reached the desired preconditioning temperature.

NOTE: In extremely cold weather or icy conditions, it is possible that your charge port latch may freeze in place. In cases where you cannot remove or insert the charge cable, or the vehicle is not Supercharging due to the latch being frozen in place, use your Tesla mobile app to precondition your vehicle on **HI** for approximately 30-45 minutes (you must use your mobile app to precondition the vehicle; setting your climate to **HI** using the touchscreen is not effective). This can help thaw ice on the charge port latch so the charge cable can be removed or inserted.

Location

Locate Model X with directions, or track its movement across a map.

Summon

You can park or retrieve Model X using Summon (see [Summon on page 118](#)) or Smart Summon (see [Smart Summon on page 121](#)).

Schedule

Enable scheduled charging or departure, and precondition the vehicle. See [Using Scheduled Charging on page 179](#) and [Using Scheduled Departure on page 179](#) for more information.

Security

The Security tab allows you to do the following:

- Enable or disable Sentry Mode (see [Using Sentry Mode on page 162](#)).
- Enable or disable Valet Mode (see [Valet Mode on page 48](#)).
- Enable or disable Speed Limit Mode and receive notifications when the vehicle's driving speed is within approximately 3 mph (5 km/h) of your selected maximum speed (see [Safety on page 135](#)).

Upgrades

View and purchase the latest upgrades available for your vehicle, such as full self-driving.

Service

See [Schedule Service on page 182](#) for information on how to schedule service through the mobile app.

Roadside

View roadside resources and request roadside assistance (where applicable). For more information on Roadside Assistance, see [Contacting Tesla Roadside Assistance on page 214](#).

Granting Access to a Second Driver

Add and remove access permission for an additional driver from the Tesla mobile app.

NOTE: Tesla mobile app version 4.3.1 or higher is required. Additional drivers can either use a previously registered Tesla Account or use the app to create a new Tesla Account.

To add an additional driver, in the Tesla mobile app from the vehicle home screen, go to **Security > Add Driver** and follow the onscreen instructions.

NOTE: The additional driver has access to all app features except purchasing upgrades.

To remove access, use the mobile app and go to **Security > Manage Drivers** and follow the onscreen instructions.



High Voltage Components

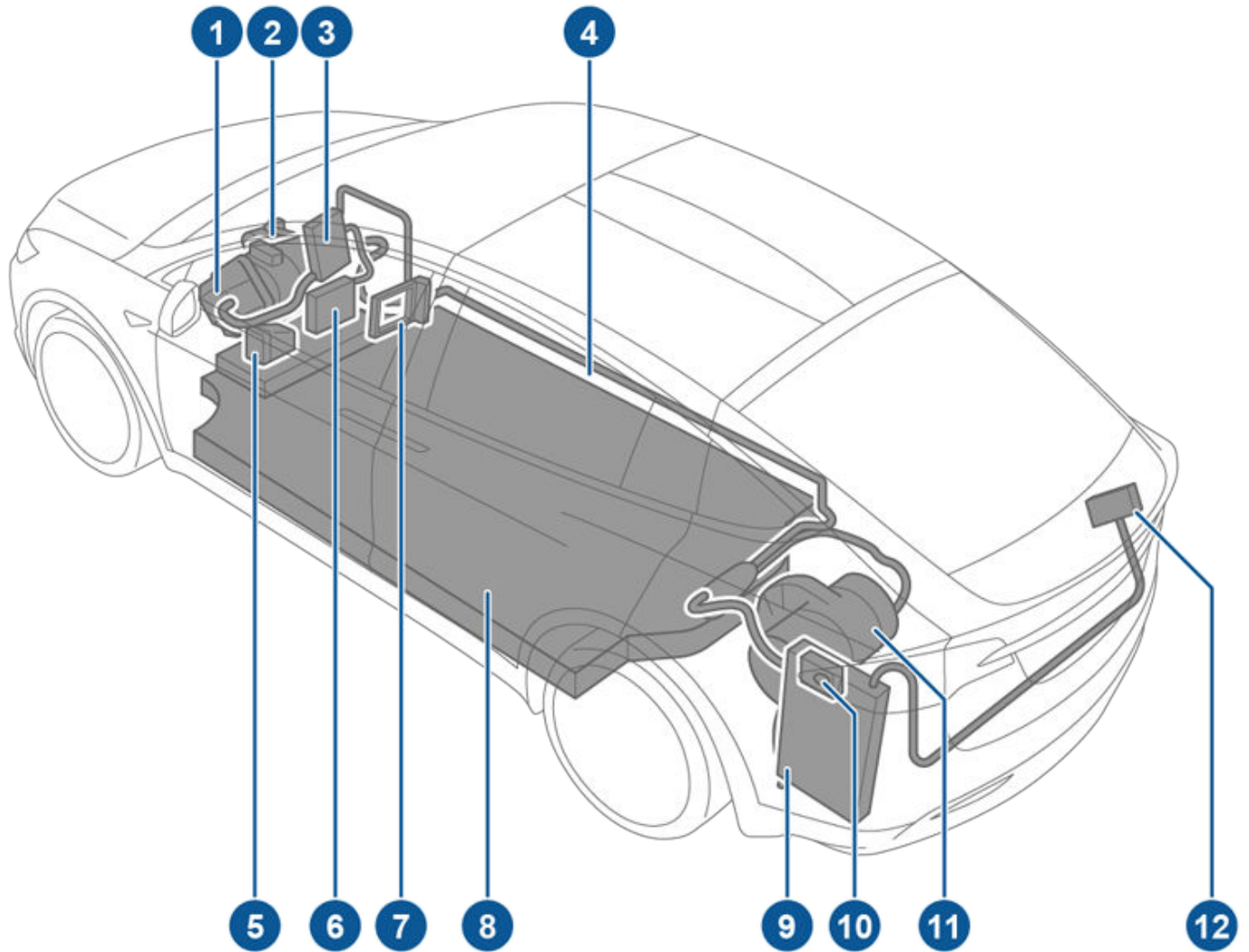

1. Front Motor
2. Air Conditioning Compressor
3. Forward Junction Box
4. High Voltage Cabling
5. Battery Coolant Heater
6. DC-DC Converter
7. Cabin Heater
8. High Voltage Battery
9. On-board Charger
10. Charge Port
11. Rear Motor
12. HV Cable to Rear HVAC Assembly



Electric Vehicle Components

- ⚠ WARNING:** The high voltage system has no user serviceable parts. Do not disassemble, remove or replace high voltage components, cables or connectors. High voltage cables are typically colored orange for easy identification.
- ⚠ WARNING:** Read and follow all instructions provided on the labels that are attached to Model X. These labels are there for your safety.
- ⚠ WARNING:** In the unlikely event that a fire occurs, immediately contact your local fire emergency responders.

Charging Equipment

Charging equipment designed specifically to charge your Model X is available from Tesla. A Tesla Wall Connector, which installs in your parking space, is the fastest way to charge Model X in daily use.

In most market regions, Model X is equipped with a Mobile Connector and the adapter(s) needed to plug into the most commonly used power outlets. When using the Mobile Connector, first plug the Mobile Connector into the power outlet, attach an adapter (if needed), and then plug in Model X. For more information about your Mobile Connector, see the Mobile Connector Owner's Manual (available on the touchscreen). Additional adapters can be purchased from Tesla.

Tesla offers adapters (for example, J1772, CHAdeMO, and Combined Charging System (CCS)) to allow you to plug into the most commonly used public charging stations in your region. Open the charge port door using the touchscreen (see [Charging Instructions on page 176](#)), plug the adapter into the charging port on Model X, and then connect the station's charging connector to the adapter. For information on the charging equipment available for your region, go to www.tesla.com, choose your region, and then view the available charging options.

More details on public charging station adapters is available at <https://www.tesla.com/chademo>.



About the High Voltage Battery

Model X has one of the most sophisticated battery systems in the world. The most important way to preserve the high voltage Battery is to **LEAVE YOUR VEHICLE PLUGGED IN** when you are not using it. This is particularly important if you are not planning to drive Model X for several weeks.

NOTE: When left idle and unplugged, your vehicle periodically uses energy from the Battery for system tests and recharging the low voltage battery when necessary.

There is no advantage to waiting until the Battery's level is low before charging. In fact, the Battery performs best when charged regularly.

NOTE: If you allow the Battery to discharge to 0%, other components may become damaged or require replacement (for example, the low voltage battery). In these cases, you are responsible for repair and/or transporting expenses. Discharge-related expenses are not covered by the warranty or under the Roadside Assistance policy.

The peak charging rate of the Battery may decrease slightly after a large number of DC Fast Charging sessions, such as those at Superchargers. To ensure maximum driving range and Battery safety, the Battery charge rate is decreased when the Battery is too cold, when the Battery's charge is nearly full, and when the Battery conditions change with usage and age. These changes in the condition of the Battery are driven by battery physics and may increase the total Supercharging duration by a few minutes over time. You can minimize the amount of charge time by using Trip Planner to warm the Battery while driving to a Supercharger. See [Trip Planner on page 147](#) for more information.

Battery Care

Never allow the Battery to fully discharge. Even when Model X is not being driven, its Battery discharges very slowly to power the onboard electronics. The Battery can discharge at a rate of approximately 1% per day, though the discharge rate may vary depending on environmental factors (such as cold weather), vehicle configuration, and your selected settings on the touchscreen. Situations can arise in which you must leave Model X unplugged for an extended period of time (for example, at an airport when traveling). In these situations, keep the 1% in mind to ensure that you leave the Battery with a sufficient charge level. For example, over a two week period (14 days), the Battery may discharge by approximately 14%.

Discharging the Battery to 0% may result in damage to vehicle components. To protect against a complete discharge, Model X enters a low-power consumption mode when the displayed charge level drops to approximately 0%. In this mode, the Battery stops

supporting the onboard electronics and auxiliary low voltage battery. Once this low-power consumption mode is active, immediately plug in Model X to prevent a jump-start and low voltage battery replacement.

NOTE: If Model X is unresponsive and does not unlock, open, or charge, the low voltage battery may be discharged. In this situation, try jump starting the low voltage battery (see [Instructions for Transporters on page 215](#) for instructions on how to jump start the battery). If the vehicle is still unresponsive, contact Tesla.





Temperature Limits

For better long-term performance, avoid exposing Model X to ambient temperatures above 140° F (60° C) or below -22° F (-30° C) for more than 24 hours at a time.

Energy Saving Feature

Model X has an energy-saving feature that reduces the amount of energy being consumed by the displays when Model X is not in use. On newer vehicles, this feature is automated to provide an optimal level of energy saving. However, on older vehicles, you can control the amount of energy being consumed by the displays by touching **Controls > Display > Energy Saving**. For more information on maximizing range and saving energy, see [Getting Maximum Range on page 77](#).

Battery Warnings and Cautions

-  **WARNING:** The Battery has no parts that an owner or a non-Tesla authorized service technician can service. Under no circumstances should you open or tamper with the Battery. Always contact Tesla to arrange for Battery servicing.
-  **CAUTION:** If the Battery's charge level falls to 0%, you must plug it in. If you leave it unplugged for an extended period, it may not be possible to charge or use Model X without jump starting or replacing the low voltage battery. Leaving Model X unplugged for an extended period can also result in permanent Battery damage. If you are unable to charge Model X after attempting to jump start the low voltage battery, contact Tesla immediately.
-  **CAUTION:** The Battery requires no owner maintenance. Do not remove the coolant filler cap and do not add fluid. If the instrument panel warns you that the fluid level is low, contact Tesla immediately.
-  **CAUTION:** Do not use the Battery as a stationary power source. Doing so voids the warranty.

Opening the Charge Port

The charge port is located on the left side of Model X, behind a door that is part of the rear tail light assembly. Park Model X to ensure that the charge cable easily reaches the charge port.

With Model X unlocked (or a recognized key is within range) and in Park, press and release the button on the Tesla charge cable to open the charge port door.



You can also open the charge port door using any of these methods:

- On the touchscreen, touch the Charge Port icon (lightning bolt).
- On the touchscreen, navigate to **Controls > Charging > Open Charge Port**.
- Press the charge port door when Model X is unlocked or a recognized key is nearby.
- On the key fob, hold down the rear trunk button for 1-2 seconds.
- Use voice commands to open the charge port door (see [Voice Commands on page 159](#)). You can also use voice commands to close the charge port door, and begin or stop charging.

NOTE: The following image is provided for demonstration purposes only. Depending on market region and date of manufacture, your charge port may be slightly different.

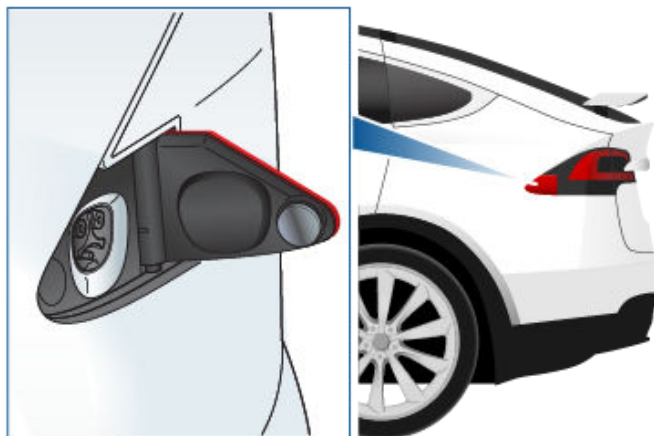

NOTE: The charge port lights up white when you open the charge port door. If you do not insert a charge cable into the charge port within a few minutes after opening the charge port door, the charge port door closes. If this happens, use the touchscreen to open the charge port door again.

NOTE: In extremely cold weather or icy conditions, it is possible that your charge port latch may freeze in place. In cases where you cannot remove or insert the charge cable, or the vehicle is not Supercharging due to the latch being frozen in place, use your Tesla mobile app to precondition your vehicle on **HI** for approximately 30-45 minutes (you must use your mobile app to precondition the vehicle; setting your climate to **HI** using the touchscreen is not effective). This can help thaw ice on the charge port latch so the charge cable can be removed or inserted.

 **CAUTION:** Do not try to force the charge port door open.

Plugging In

If desired, use the touchscreen to change the charge limit and the charging current (see [Charge Settings on page 178](#)).

To charge at a public charging station, plug the appropriate adapter into the vehicle's charging port, and then connect the station's charging connector to the adapter. The most commonly used adapter(s) for each market region are provided. Depending on the charging equipment you are using, you may need to start and stop charging using a control on the charging equipment.

If you are using the Mobile Connector, plug into the power outlet before plugging in Model X.

Align the connector to the charge port and insert fully. When the connector is properly inserted, charging begins automatically after Model X:

- Engages a latch that holds the connector in place;
- Shifts into Park (if it was in any other drive mode);
- Heats or cools the Battery, if needed. If the Battery requires heating or cooling, you may notice a delay before charging begins.

NOTE: Whenever Model X is plugged in but not actively charging, it draws energy from the wall outlet instead of using energy stored in the Battery. For example, if you are sitting in Model X and using the touchscreen while parked and plugged in, Model X draws energy from the wall outlet instead of the Battery.

 **CAUTION:** The connector end of the charge cable can damage the paint if you drop it onto Model X.



Charge Port Light

- **WHITE (OR LIGHT BLUE):** The charge port door is open. Model X is ready to charge and the connector is not inserted, or the charge port latch is unlocked and the connector is ready to be removed.
- **BLUE:** Model X detects that a connector has been plugged in.
- **BLINKING BLUE:** Model X is communicating with the connector. Either Model X is preparing to charge, or a charging session is scheduled to begin at a specified future time.

- **BLINKING GREEN:** Charging is in progress. As Model X approaches a full charge, the frequency of the blinking slows.
- **SOLID GREEN:** Charging is complete.
- **SOLID AMBER:** The connector is not fully plugged in. Realign the connector to the charge port and insert fully.
- **BLINKING AMBER:** Model X is charging at a reduced current (AC charging only).
- **RED:** A fault is detected and charging has stopped. Check the instrument panel or touchscreen for an alert.

Charging Status

Charging status displays on the instrument panel when the charge port door is open.



1. **Driving distance:** Displays the total estimated driving distance or energy percentage (depending on your display setting) available.
NOTE: To change how energy units are displayed, touch **Controls > Display > Energy Display**.
2. **Charge status:** Charge status messages (such as Supercharging, Scheduled Charging) display here (see [Scheduled Charging and Scheduled Departure on page 179](#)).
3. **Time remaining:** The estimated time remaining to charge to your set limit (see [Charge Settings on page 178](#)).
NOTE: When charging to 100%, the vehicle may continue to charge with low power when charging is displayed as complete. This is expected operation. Because the added energy beyond this point is low, it is usually not beneficial to continue charging.
4. **Charging rate:** The maximum current available from the attached charge cable.
5. **Range gained:** Estimated increase in driving distance achieved in the charging session.
6. **Charging:** The current power of the charger.

During Charging

During charging, the charge port light pulses green, and the instrument panel displays real-time charging status. The frequency at which the green charge port light pulses slows down as the charge level approaches full. When charging is complete, the light stops pulsing and is solid green.

NOTE: If Model X is locked, the charge port light does not light up.

If the charge port light turns red while charging, a fault is detected. Check the instrument panel or touchscreen for an alert describing the fault. A fault can occur due to something as common as a power outage. If a power outage occurs, charging resumes automatically when power is restored.

NOTE: It is normal to hear sounds during charging. Particularly at high currents, the refrigerant compressor and fan operate as needed to keep the Battery cool.

NOTE: Air conditioning performance is generally not affected by charging. However, in some circumstances (for example, charging at high currents during a particularly warm day), the air coming from the vents may not be as cool as expected and a message displays on the instrument panel. This is normal and ensures that the Battery stays within an optimum temperature range while charging to support longevity and optimum performance.

WARNING: Never spray liquid at a high velocity (for example, a pressure washer) towards the charge port while charging. Doing so can result in serious injury or damage to the vehicle, charging equipment, or property.

Stopping Charging

Stop charging at any time by disconnecting the charge cable or touching **Stop Charging** on the touchscreen.

NOTE: To prevent unauthorized unplugging of the charge cable, the charge cable latch remains locked and Model X must be unlocked or able to recognize your key before you can disconnect the charge cable.

NOTE:

To disconnect the charge cable:

1. Press and hold the button on the connector handle to release the latch.

NOTE: You can also release the latch using the touchscreen or mobile app, or by pressing and holding the rear trunk button on the key fob. If your vehicle is equipped with a motorized charge port, you can also press the button to the left of the charge port to release the latch.

2. Pull the connector from the charge port.

To disconnect the charge cable when using an adapter at a public charge station:

1. Unlock Model X.
2. While holding the public charging handle in one hand and the adapter in the other hand, press and hold the button on the public charging handle and pull both outwards, removing the handle and adapter at the same time.

NOTE: If the charging station handle separates from the adapter, leaving the adapter in Model X, use the touchscreen to unlock the charge port.

3. Press and hold the button on the charging handle again to release the adapter from the public charging handle.

CAUTION: Tesla strongly recommends leaving Model X plugged in when not in use. This maintains the Battery at the optimum level of charge.

Charge Settings

Access charge settings by touching **Controls > Charging** when Model X is in Park.



1. **Driving distance:** Displays the total estimated driving distance available.
2. **Set limit:** Adjust the charge limit by dragging the arrow below the battery to indicate the level of charging you want. The setting you choose applies to immediate and scheduled charging sessions.

NOTE: A portion of the battery image may appear blue. This indicates that a small portion of the energy stored in the battery is not available because the battery is cold. This is normal and no reason for concern. When the battery warms up, the blue portion no longer displays.

You can further adjust charge settings:

- **Open Charge Port, Unlock Charge Port and Stop Charging:** When not charging, touch **Open Charge Port** or **Unlock Charge Port** to open the charge port door or to unlock the charge cable from the charge port. Use **Stop Charging** when you are finished charging.



- **Charge current at this location:** The current automatically sets to the maximum current available from the attached charge cable, unless it was previously reduced to a lower level. If needed, touch **-** or **+** to change the current (for example, you may want to reduce the current if you are concerned about overloading a domestic wiring circuit shared by other equipment). It is not possible to set the charging current to a level that exceeds the maximum available from the attached charge cable. When you change the current, Model X remembers the location. If you charge at the same location, you do not need to change it again.

NOTE: If Model X is charging and detects unexpected fluctuations in input power, the charging current is automatically reduced by 25%. For example, a 40 amp current is reduced to 30 amps. This automatic current reduction increases robustness and safety in situations when an external problem exists (for example, a home wiring system, receptacle, adapter or cord is unable to meet its rated current capacity). As a precaution, when Model X automatically reduces current, it saves the reduced current at the charging location. Although you can manually increase it, Tesla recommends charging at the lower current until the underlying problem is resolved and the charging location can provide consistent power.

- **Schedule:** Depending on the setting you select by touching **Switch to Scheduled Departure/Scheduled Charging**, this displays either a departure time for when the vehicle should be preconditioned and/or charged by or a time to start charging (see [Scheduled Charging and Scheduled Departure on page 179](#)).
- **Supercharging:** Displays supercharger usage fees, the location, the time that charging started, and a cost estimate for the session (see [Supercharger Usage Fees and Idle Fees on page 180](#)).

NOTE: To reduce congestion at high-usage supercharger sites, you may be limited to a maximum charge of 80% when not using Trip Planner (see [Trip Planner on page 147](#)).

Scheduled Charging and Scheduled Departure

Toggle between Scheduled Departure and Scheduled Charging by touching **Controls** > **Charging** > **Switch to Scheduled Charging/Scheduled Departure** when Model X is in Park.

NOTE: **Scheduled Charging/Scheduled Departure** settings are also available on the Climate Controls screen and in the Tesla mobile app.

Think of **Scheduled Charging** as “When do I want charging to start?” compared to **Scheduled Departure Off-Peak Charging** which is “When do I want charging to be complete?”

Scheduled Charging can be used together with **Scheduled Departure Preconditioning** but not with **Scheduled Departure Off-Peak Charging**.

Scheduled Charging/Scheduled Departure settings are automatically saved for each location.

NOTE: If you plug in Model X with both **Off-Peak Charging** and **Scheduled Charging** deselected, your vehicle charges immediately.

Using Scheduled Charging

Use **Scheduled Charging** to specify a daily time in which you want Model X to **start** charging.

With **Scheduled Charging** selected, enable the feature then set a daily time to start charging.

NOTE: **Scheduled Charging** starts charging immediately if Model X is plugged in up to 6 hours after the scheduled start time. However, if Model X is plugged in after six hours of the scheduled charging time, charging may not start until the scheduled time on the next day.

Using Scheduled Departure

Use **Scheduled Departure** to set a daily time when you want Model X to be ready to drive. Your vehicle automatically calculates when it needs to start preconditioning and/or charging. This ensures that charging is complete and/or the cabin climate and Battery are preconditioned by your departure time.

When **Scheduled Departure** is displayed, touch **Schedule** to set a daily time when you want Model X to be ready to drive. Specify a time, then touch **Settings** to enable one or both of the following departure features. When plugging in with **Off-Peak Charging** enabled, the vehicle briefly draws power (you may hear clicking) to calculate the necessary charging start time.

After you've specified your desired settings, touch **Set**. The touchscreen displays your scheduled departure time.

- **Preconditioning** warms the Battery for improved performance and ensures a comfortable cabin climate at your set departure time.

NOTE: When Model X is not plugged in, preconditioning operates but only when the Battery's charge level is above 20%.



Charging Instructions

- **Off-Peak Charging** delays charging and automatically starts charging in order to finish before your scheduled departure time while also ensuring to charge the Battery during off-peak hours to reduce energy costs. Touch **Change Off-Peak Hours** to customize the time when off-peak utility rates end.

NOTE: Choosing **Off-Peak Charging** can reduce energy costs even in market regions where off-peak utility rates are not applicable. For example, if charging starts as soon as you plug in, charging may complete much sooner. This causes the Battery to cool down to ambient temperatures and requires energy to warm it back up by your departure time. Therefore, even if off-peak utility rates are not applicable to you, it is recommended that you set Off-Peak Hours to the same time as your departure time in order to reduce energy consumption.

NOTE: If there is not enough time to reach the charge limit, charging starts immediately in order to charge as much as possible.

NOTE: Once charging has started and there is not enough time to complete charging during off-peak hours, charging continues until the charge limit is reached.

You can limit **Preconditioning** and **Off-Peak Charging** to weekdays only.

Supercharger Usage Fees and Idle Fees

When charging at a Tesla supercharger, information about the charging session displays at the bottom of the charging screen. This includes the location, the time that charging started, and a cost estimate for the session. When you stop supercharging, the estimated cost of the session displays until a new supercharging session begins. If free charging is applicable, the estimated cost displays as zero.

NOTE: Estimated cost may not reflect the final cost of the supercharging session. Final pricing for supercharging sessions can be found in your Tesla account.

When charging at a Tesla supercharger, you are subject to idle fees. Idle fees are designed to encourage drivers to move their vehicle from the Supercharger when charging is complete. Idle fees are in effect only when half or more of the Superchargers at a site are occupied. The Tesla mobile app notifies you when charging is almost complete, and again when charging is complete. Additional notifications are sent if idle fees are incurred. Idle fees are waived if you move your vehicle within five minutes of when charging completed.

Log into your Tesla account to view fees and details about Supercharger sessions, track the remaining balance of free credits, set up a payment method, and make payments. Once a payment method is saved, fees are automatically paid from your account.

Manually Releasing Charge Cable

If the usual methods for releasing a charge cable from the charge port (using the charge handle release button, touchscreen, or mobile app) do not work, carefully follow these steps:

1. Ensure that Model X is not actively charging by displaying the charging screen on the touchscreen. If necessary, touch **Stop Charging**.
2. Open the rear trunk.
3. Pull the charge port's release cable downwards to unlatch the charge cable.



WARNING: Do not pull the release cable while simultaneously attempting to remove the charge cable from the charge port. Always pull the release cable *before* attempting to remove the charge cable. Failure to follow these instructions can result in electric shock and serious injury.



NOTE: The release cable may be recessed within the opening of the trim.

4. Pull the charge cable from the charge port.



CAUTION: Use the release cable **only** in situations where you can not release the charge cable using the usual methods. Continuous use can damage the release cable or charging equipment.



 **WARNING:** Do not perform this procedure when your vehicle is charging, or if any orange high voltage conductors are exposed. Failure to follow these instructions can result in electric shock and serious injury or damage to the vehicle. If you are uncertain as to how to safely perform this procedure, contact your nearest Service Center.

Service Intervals

Your vehicle should generally be serviced on an as-needed basis. However, Tesla recommends the following maintenance items and intervals, as applicable to your vehicle, to ensure continued reliability and efficiency of your Model X.

- Brake fluid health check every 2 years (replace if necessary) or, if the vehicle is used for towing, replace the brake fluid every 2 years.
- A/C desiccant bag replacement every 4 years.
- Cabin air filter replacement every 2 years.
- HEPA filter replacement every 3 years.
- Clean and lubricate brake calipers every year or 12,500 miles (20,000 km) if in an area where roads are salted during winter
- Rotate tires every 6,250 miles (10,000 km) or if tread depth difference is 2/32 in (1.5 mm) or greater, whichever comes first

NOTE: The above intervals are based on normal driving behaviors and scenarios. Additionally, the above list should not be considered comprehensive and does not include consumable parts such as windshield wipers, brake pads, etc.

NOTE: Damages or failures caused by maintenance or repairs performed by non-Tesla certified technicians are not covered by the warranty.

Schedule Service

Scheduling a service visit through the mobile app is easy. After touching **Schedule Service**, select the type of service needed and follow the directions in the mobile app. Provide as much detail as possible, such as:

- Photos, sound recordings, or videos.
- Date(s), time(s), and time zone when the issue occurred.
- Country of use and location.
- Approximate speed the vehicle was traveling (if applicable).
- Environmental conditions (rain, snow, cold, etc.).
- Road name and type of road (if applicable).
- Quality of lane markings (if applicable).
- Applicable vehicle settings.
- Identifiable symptoms.

Visit <https://www.tesla.com/support/service-visits> for more information on scheduling service.

Daily Checks

- Check the Battery's charge level, displayed on the instrument panel or mobile app.
- Check the condition and pressure of each tire (see [Tire Care and Maintenance on page 184](#)).
- Check that all exterior lights, horn, turn signals, and wipers and washers are working.
- Check for any unexpected indicator lights or vehicle alerts on the touchscreen or instrument panel.
- Check the operation of the brakes, including the parking brake.
- Check the operation of the seat belts (see [Seat Belts on page 31](#)).
- Look for abnormal fluid deposits underneath Model X that might indicate a leak. It is normal for a small pool of water to form (caused by the air conditioning system's dehumidifying process).
- Look around the exterior of Model X and immediately remove any corrosive substances (such as bird droppings, tree resin, tar spots, dead insects, industrial fallout, etc.) to prevent damage to the paint (see [Cleaning on page 190](#)).

Monthly Checks

- Check windshield washer fluid level and top up if necessary (see [Topping Up Windshield Washer Fluid on page 195](#)).
- Check that the air conditioning system is operating correctly (see [Climate Controls on page 138](#)).

NOTE: In addition to cooling the interior, the air conditioning compressor also cools the Battery. Therefore, in hot weather, the air conditioning compressor can turn on even if you turned it off. This is normal because the system's priority is to cool the Battery to ensure it stays within an optimum temperature range to support longevity and optimum performance. Also, even when not in use, you may hear Model X emit a whining noise or the sound of water circulating. These sounds are normal and occur when the internal cooling systems turn on to support various vehicle functions, such as maintaining the low voltage battery and balancing the temperature of the high voltage Battery.



WARNING: Contact Tesla immediately if you notice any significant or sudden drop in fluid levels or uneven tire wear.

Fluid Replacement Intervals

Your Battery coolant does not need to be replaced for the life of your vehicle under most circumstances. Brake fluid should be checked every 2 years, replacing if necessary*.



*If the vehicle is used for towing, the brake fluid should be replaced every 2 years regardless of the health check.

NOTE: Any damage caused by opening the Battery coolant reservoir is excluded from the warranty.

High Voltage Safety

Your Model X has been designed and built with safety as a priority. However, be aware of these precautions to protect yourself from the risk of injury inherent in all high-voltage systems:

- Read and follow all instructions provided on the labels that are attached to Model X. These labels are there for your safety.
- The high voltage system has no user-serviceable parts. Do not disassemble, remove or replace high voltage components, cables or connectors. High voltage cables are colored orange for easy identification.
- If a collision occurs, do not touch any high voltage wiring, connectors, or components connected to the wiring.
- In the unlikely event that a fire occurs, immediately contact your local fire emergency responders.

 **WARNING:** Always disconnect the charge cable before working underneath Model X, even if charging is not in progress.

 **WARNING:** Keep your hands and clothing away from cooling fans. Some fans operate even when Model X is powered off.

 **WARNING:** Some fluids (battery acid, Battery coolant, brake fluid, windshield washer additives, etc.) used in vehicles are poisonous and should not be inhaled, swallowed, or brought into contact with open wounds. For your safety, always read and follow instructions printed on fluid containers.

Displaying Tire Pressures

You can display tire pressures on the instrument panel by using the right or left steering wheel buttons to display **Car Status** (see [Using Left Steering Wheel Buttons on page 50](#) or [Using Right Steering Wheel Buttons on page 51](#)). You can also choose whether you want to display tire pressures using Bar or PSI by touching **Controls > Display > Tire Pressure**.

Maintaining Tire Pressures

Keep tires inflated to the pressures shown on the Tire and Loading Information label, even if it differs from the pressure printed on the tire itself. The Tire and Loading Information label is located on the center door pillar and is visible when the front door is open.

If you are towing a trailer, do not use the tire pressures printed on the Tire and Loading Information Label. Instead, refer to the tire pressures published in the towing section (see [Towing and Accessories on page 82](#)).



The Tire Pressure indicator light on the instrument panel alerts you if one or more tires is under- or over-inflated.

The Tire Pressure indicator light does not immediately turn off when you adjust tire pressure. After inflating the tire to the recommended pressure, you must drive over 15 mph (25 km/h) for a short amount of time to activate the Tire Pressure Monitoring System (TPMS), which turns off the Tire Pressure indicator light.

If the indicator light flashes for one minute whenever you power on Model X, a fault with the TPMS is detected (see [TPMS Malfunction on page 188](#)).

NOTE: Your vehicle's tire pressures will drop in cold ambient temperatures. If the TPMS indicator light appears, inflate the tires before driving. The tires will lose one PSI for every 10° F (6° C) drop in outside temperature. Proper tire pressures help protect tires from potholes and improve range when properly inflated.



WARNING: Under-inflation is the most common cause of tire failures and can cause a tire to overheat, resulting in severe tire cracking, tread separation, or blowout, resulting in unexpected loss of vehicle control and increased risk of injury. Under-inflation also reduces the vehicle's range and tire tread life.



WARNING: Check tire pressures using an accurate pressure gauge when tires are cold. It takes only about one mile (1.6 km) of driving to warm up the tires sufficiently to affect tire pressures. Parking the vehicle in direct sunlight or in hot weather can also affect tire pressures. If you must check warm tires, expect increased pressures. Do not let air out of warm tires in an attempt to match recommended cold tire pressures. A hot tire at or below the recommended cold tire inflation pressure is dangerously under-inflated.

Checking and Adjusting Tire Pressures

Follow these steps when tires are cold and Model X has been stationary for over three hours:

1. Refer to the Tire and Loading Information label located on the driver's center door pillar for the target tire pressure.
2. Remove the valve cap.
3. Firmly press an accurate tire pressure gauge onto the valve to measure pressure.
4. If required, add or remove air to reach the recommended pressure.

NOTE: You can release air by pressing the metal stem in the center of the valve.

5. Re-check pressure using the accurate tire gauge.
6. Repeat steps 3 and 4 as necessary until the tire pressure is correct.
7. Reinstall the valve cap to prevent dirt from entering. Periodically check the valve for damage and leaks.

Inspecting and Maintaining Tires

Regularly inspect the tread and side walls for any sign of distortion (bulges), foreign objects, cuts or wear.



WARNING: Do not drive Model X if a tire is damaged, excessively worn, or inflated to an incorrect pressure. Check tires regularly for wear, and ensure there are no cuts, bulges or exposure of the ply/cord structure.



Tire Wear

Adequate tread depth is important for proper tire performance. Tires with a tread depth less than 4/32" (3 mm) are more likely to hydroplane in wet conditions and should not be used. Tires with a tread depth less than 5/32" (4 mm) do not perform well in snow and slush and should not be used when driving in winter conditions.

Model X is originally fitted with tires that have wear indicators molded into the tread pattern. When the tread has been worn down to 3/32" (2 mm), the indicators start to appear at the surface of the tread pattern, producing the effect of a continuous band of rubber across the width of the tire. For optimal performance and safety, Tesla recommends replacing tires before the wear indicators are visible.

Tire Rotation, Balance, and Wheel Alignment

Tesla recommends rotating the tires every 6,250 miles (10,000 km) or if tread depth difference is 2/32 in (1.5 mm) or greater, whichever comes first.

Model X tires can be rotated side-to-side (left-to-right) but not front-to-back as the front and rear tire size is different.

Unbalanced wheels (sometimes noticeable as vibration through the steering wheel) affect vehicle handling and tire life. Even with regular use, wheels can get out of balance. Therefore, they should be balanced as required.

If tire wear is uneven (on one side of the tire only) or becomes abnormally excessive, check the alignment of wheels.

Punctured Tires

A puncture eventually causes the tire to lose pressure, which is why it is important to check tire pressures frequently. Permanently repair or replace punctured or damaged tires as soon as possible.

Your tubeless tires may not leak when penetrated, provided the object remains in the tire. If, however, you feel a sudden vibration or ride disturbance while driving, or you suspect a tire is damaged, immediately reduce your speed. Drive slowly, while avoiding heavy braking or sharp steering and, when safe to do so, stop the vehicle. Arrange to have Model X transported to a Tesla Service Center, or to a nearby tire repair center.

NOTE: In some cases, you can temporarily repair small tire punctures (under 1/4" (6 mm)) using an optional tire repair kit available from Tesla. This allows you to slowly drive Model X to Tesla or to a nearby tire repair facility.

⚠ WARNING: Do not drive with a punctured tire that has not been repaired, even if the puncture has not caused the tire to deflate. A punctured tire can deflate suddenly at any time.

Flat Spots

If Model X is stationary for a long period, tires can form flat spots. When Model X is driven, these flat spots cause a vibration which gradually disappears as the tires warm up and regain their original shape.

To minimize flat spots during storage, inflate tires to the maximum pressure indicated on the tire wall. Then, before driving, release air to adjust tire pressure to the recommended levels.

Improving Tire Mileage

To improve the mileage you get from your tires, maintain tires at the recommended tire pressures, observe speed limits and advisory speeds, and avoid:

- Pulling away quickly, or hard acceleration.
- Fast turns and heavy braking.
- Potholes and objects in the road.
- Hitting curbs when parking.
- Contaminating tires with fluids that can cause damage.

Replacing Tires and Wheels

Tires degrade over time due to the effects of ultraviolet light, extreme temperatures, high loads, and environmental conditions. It is recommended that tires are replaced every six years, or sooner if required, even if tread depth is above the minimum.

Wheel and tires are matched to suit the handling characteristics of the vehicle. Replacement tires must comply with the original specification. If tires other than those specified are used, ensure that the load and speed ratings marked on the tire (see [Understanding Tire Markings on page 208](#)) equal or exceed those of the original specification.

When a tire set becomes worn, replace all four tires at the same time. If tires need to be replaced early, we recommend replacing the tires in pairs unless the other tires are fairly new (for example, minimal wear relative to the new tire). Place the new tires on the rear if all four tires are of the same size. Always balance the wheel and tire after replacing a tire. Consult with a professional tire retailer and installer for further guidance.

Tire Care and Maintenance

If you replace a wheel, the TPMS (Tire Pressure Monitoring System) sensors need to be reset to ensure they provide accurate warnings when tires are under- or over-inflated (see [Automatic Reset of TPMS Sensors on page 187](#)).

For the specification of the original wheels and tires installed on Model X, see [Wheels and Tires on page 207](#).

WARNING: For your safety, use only tires and wheels that match the original specification. Tires that do not match the original specification can affect the operation of the TPMS.

WARNING: Never exceed the speed rating of your vehicle's tires. The speed rating is shown on the sidewall of your tires (see [Understanding Tire Markings on page 208](#)).

Asymmetric Tires

Model X tires are asymmetric and must be mounted on the wheel with the correct sidewall facing outward. The sidewall of the tire is marked with the word **OUTSIDE**. When new tires are installed, make sure that the tires are correctly mounted on the wheels.



WARNING: Road holding is seriously impaired if the tires are incorrectly installed on the wheels.

Removing and Installing Aero Covers

If your Model X is equipped with aero covers, you must remove them to access the lug nuts.

To remove an aero cover:

1. Grasp the aero cover firmly with both hands.
2. Pull the aero cover toward you to release the retaining clips.

To install an aero cover:

1. Align the aero cover into position so that the notch at the base of the Tesla "T" is aligned with the tire's valve stem.
2. Push firmly around the perimeter of the aero cover until it fully snaps into place.

For Gemini wheels, press on the perimeter of the cover until it aligns with the wheel surface. Press on the Tesla "T" in the center until the cap snaps into place. See [Parts and Accessories on page 198](#) for more information.

CAUTION: To prevent the aero cover from falling off, ensure that it is fully secured before driving.

Removing and Installing Lug Nut Covers

If your Model X is equipped with lug nut covers, you must remove them to access the lug nuts.

To remove a lug nut cover:

1. Insert the curved part of the lug nut cover tool, if equipped (located in the glovebox in some vehicles, or you can use a small allen wrench) into the hole at the base of the Tesla "T".

NOTE: The lug nut cover tool can also be purchased at an auto parts store or through online retailers.



2. Maneuver the lug nut cover tool so that it is fully inserted into the hole in the lug nut cover.
3. Twist the lug nut cover tool so that the curved part is touching the middle of the lug nut cover.
4. Firmly pull the lug nut tool away from the wheel until the lug nut cover is released.



To install the lug nut cover:

1. Align the lug nut cover into position.
2. Push firmly on the lug nut cover until it fully snaps into place.



CAUTION: Make sure the lug nut cover is fully secure before driving to prevent it from falling off.

Wheel Configuration

If you are installing new wheels or swapping them for different ones, update your vehicle's wheel configuration by touching **Controls > Service > Wheel Configuration**. This allows Model X to learn the new wheels and provide more accurate status updates on your vehicle. Select a wheel from the drop down menu that matches the new wheels you plan to install on Model X. Selecting new wheels in the wheel configuration also changes the wheels that appear on your vehicle's avatar on the touchscreen.

Ensure you are aware if your vehicle is equipped with staggered wheels, meaning the wheels are different sizes in the front and rear. Check the front and rear tire sizes marked on the tire sidewall to see if they match or are different sizes. If the wheels are staggered, take extra precaution to ensure the new wheels you install are staggered in the same way as the previous wheels.

NOTE: Changing your vehicle's wheel configuration can impact range estimates, tire pressure warning levels, and vehicle visualization.



WARNING: Only use Tesla-approved wheels when installing or swapping wheels. Using non Tesla-approved wheels can cause serious damage. Tesla is not liable for damage caused by using wheels not approved by Tesla.

Tire Pressure Monitoring

Each tire should be checked monthly when cold and inflated to the recommended pressures that are printed on the Tire and Loading Information label located on the driver's door pillar (see [Maintaining Tire Pressures on page 184](#)). If your vehicle has tires of a different size than the size indicated on the vehicle placard or tire inflation pressure label, determine the proper tire inflation pressure for those tires.

As an added safety feature, your vehicle has been equipped with a TPMS that displays a tire pressure telltale (Tire Pressure Warning) on the instrument panel when one or more of your tires is significantly under- or over-inflated. Accordingly, when the Tire Pressure indicator light displays on the instrument panel to alert you about tire pressure, stop and check your tires as soon as possible, and inflate them to the proper pressure (see [Maintaining Tire Pressures on page 184](#)). Driving on a significantly under-inflated tire causes the tire to overheat and can lead to tire failure. Under-inflation also reduces range efficiency and tire tread life, and may affect the vehicle's handling and stopping ability.



If Model X detects a fault with the TPMS, this indicator flashes for one minute whenever you power on Model X.

NOTE: Installing accessories that are not approved by Tesla can interfere with the TPMS.



WARNING: The TPMS is not a substitute for proper tire maintenance, including manually checking tire pressures and regularly inspecting the condition of tires. It is the driver's responsibility to maintain correct tire pressure, even if under- or over-inflation has not reached the level for the TPMS to trigger the Tire Pressure Warning on the instrument panel.

Automatic Reset of TPMS Sensors

After replacing one or more wheels (but not after replacing a tire or rotating wheels), the TPMS sensors are reset to ensure tire pressure warnings are accurate. TPMS sensors reset automatically after driving over 15 mph (25 km/h) for longer than 10 minutes.

NOTE: After replacing a wheel, false tire pressure warnings may display before you've driven 15 mph (25 km/h) for longer than 10 minutes.

Replacing a Tire Sensor

If the Tire Pressure warning indicator displays frequently, contact Tesla to determine if a tire sensor needs to be replaced. If a non-Tesla Service Center repairs or replaces a tire, the tire sensor may not work until Tesla performs the setup procedure.



Tire Care and Maintenance

TPMS Malfunction

Model X has also been equipped with a TPMS malfunction indicator to indicate when the system is not operating properly.



The TPMS malfunction indicator is combined with the tire pressure indicator light. When the system detects a malfunction, the indicator flashes for approximately one minute, then remains continuously lit. This sequence continues upon subsequent vehicle start-ups as long as the malfunction exists. When the TPMS malfunction indicator is on, the system might not be able to detect or signal under- or over-inflated tires as intended.

TPMS malfunctions can occur for a variety of reasons, including installing replacement or alternate tires or wheels that prevent the TPMS from functioning properly. Always check the TPMS malfunction indicator light after replacing one or more tires or wheels on your vehicle to ensure that the replacement tires or wheels allow the TPMS to continue to function properly.

NOTE: If a tire has been replaced or repaired using a different tire sealant than the one available from Tesla, and a low tire pressure is detected, it is possible that the tire sensor has been damaged. Contact Tesla to have the fault repaired as soon as possible.

Seasonal Tire Types

Understand Your Tire Type

The type of tires that your vehicle is originally equipped with depends on vehicle model and market region. It is important to understand the capabilities of your vehicle's tires and whether they are suited for summer, all-season, or winter driving. Check the information on the sidewall of a tire for information about a tire's performance characteristics (see [Understanding Tire Markings on page 208](#))

Summer and All-Season Tires

Summer tires and all season tires are designed for maximum dry and wet road performance but are not designed to perform well in winter conditions. All-season tires are designed to provide adequate traction in most conditions year-round, but may not provide the same level of traction as winter tires in snowy or icy conditions. All-season tires can be identified by "ALL SEASON" and/or "M+S" (mud and snow) on the tire sidewall.

If driving in cold temperatures or on roads where snow or ice may be present, Tesla recommends using winter tires. If not equipped with winter tires, contact Tesla for winter tire recommendations.



WARNING: In cold temperatures or on snow or ice, summer and all-season tires do not provide adequate traction. Selecting and installing the appropriate tires for winter conditions is important to ensure the safety and optimum performance of your Model X.

Winter Tires

Use winter tires to increase traction in snowy or icy conditions. When installing winter tires, always install a complete set of four tires at the same time. Winter tires must be the same diameter, brand, construction and tread pattern on all four wheels. Contact Tesla for winter tire recommendations.



Winter tires can be identified by a mountain/snowflake symbol on the tire's sidewall.

When driving with winter tires, you may experience more road noise, shorter tread life, and less traction on dry roads.

Driving in Low Temperatures

Tire performance is reduced in low ambient temperatures, resulting in reduced grip and an increased susceptibility to damage from impacts. Performance tires (summer applications) have reduced traction in ambient temperatures below 40° F (5° C), and are not recommended in snow/ice conditions. Performance tires can temporarily harden when cold, causing you to hear rotational noise for the first few miles (kilometers) until the tires warm up.

Using Tire Chains

Tesla has tested and approved the following tire chains to increase traction in snowy conditions. Tire chains should only be installed on the rear tires. The approved tire chains can be purchased from Tesla.

Tire Size	Recommended Chain
20"/22"	KONIG K-SUMMIT K67

When installing tire chains, follow the instructions and warnings provided by the tire chain manufacturer. Mount them evenly and as tight as possible.

When using tire chains:

- Inspect the tire chains for loose fittings and damaged links before each use.
- Set air suspension to Standard (see [Air Suspension on page 157](#)).



- Avoid heavily loading Model X (heavy loads can reduce the clearance between the tires and the body).
- Do not drive the vehicle without the chains properly installed.
- Drive slowly. Do not exceed 30 mph (48 km/h).
- Remove the tire chains as soon as conditions allow.

NOTE: Tire chains are prohibited in some jurisdictions. Check local laws before installing tire chains.



CAUTION: Air suspension should remain in the **Medium** ride height setting to avoid damage.



CAUTION: Using non-recommended tire chains, or using tire chains on other sized tires can damage the suspension, body, wheels, and/or brake lines. Damage caused by using non-recommended tire chains, or incorrectly installing tire chains, is not covered by the warranty.



CAUTION: Never deflate your tires to put on tire chains. When re-inflated, the chains might fit too tightly and cause tire damage.



CAUTION: Ensure that the tire chains cannot touch suspension components or brake lines. If you hear the chains making unusual noises that would indicate contact with Model X, stop and investigate immediately.

Cleaning the Exterior

To prevent damage to the paint, immediately remove corrosive substances (bird droppings, tree resin, dead insects, tar spots, road salt, industrial fallout, etc.). Do not wait until Model X is due for a complete wash. If necessary, use denatured alcohol to remove tar spots and stubborn grease stains, then immediately wash the area with water and a mild, non-detergent soap to remove the alcohol.

Keep the exterior cameras free of dirt, condensation, or obstructions. These substances can cause unclear pictures or Autopilot and safety features to stop working (see [Cleaning a Camera on page 190](#)).

Follow these steps when washing the exterior of Model X:

1. Rinse Thoroughly

Before washing, flush grime and grit from the vehicle using a hose. Flush away accumulations of mud in areas where debris easily collects (such as wheel wells and panel seams). If salt has been used on the highways (such as during winter months), thoroughly rinse all traces of road salt from the underside of the vehicle, wheel wells, and brakes.

2. Hand Wash

Hand wash Model X using a clean soft cloth and cold or lukewarm water containing a mild, high-quality car shampoo.

 **CAUTION:** Some cleaners and car shampoos contain chemicals that can cause damage or discoloration, especially to plastic trim pieces, lamps, or camera lenses. For example, some car cleaning formulas contain hydroxide or other highly alkaline or caustic ingredients that can damage exterior components. Damage or discoloration resulting from cleaning products is not covered by the warranty.

3. Rinse with Clean Water

After washing, rinse with clean water to prevent soap from drying on the surfaces.

4. Dry Thoroughly and Clean Exterior Glass

After washing and rinsing, dry thoroughly with a chamois. If necessary, dry the brakes by going on a short drive and applying the brakes multiple times.

Clean windows and mirrors using an automotive glass cleaner. Do not scrape, or use any abrasive cleaning fluid on glass or mirrored surfaces.

Cleaning a Camera

To ensure a clear picture, the camera lens must be clean and free of obstructions. Remove any build-up of dirt or debris by spraying water onto the camera lens with a spray bottle or pressure washer.

 **CAUTION:** Do not attempt to remove dirt or debris by wiping an exposed lens with your hands or a cloth. This debris can damage the surface of the lens when rubbed against it during wiping.

 **CAUTION:** Do not use chemical-based or abrasive cleaners. Doing so can damage the surface of the lens.

Cautions for Exterior Cleaning

 **CAUTION:** Do not wash in direct sunlight.

 **CAUTION:** Do not use windshield treatment fluids. Doing so can interfere with wiper friction and cause a chattering sound.

 **CAUTION:** Do not use hot water, detergents, or highly alkaline or caustic cleaning products, especially those containing hydroxide.

 **CAUTION:** If using a pressure washer, maintain a distance of at least 12" (30 cm) between the nozzle and the surface of Model X. Avoid aiming the water jet directly at parking sensors (if equipped). Keep the nozzle moving and do not concentrate the water jet on any one area.

 **CAUTION:** Do not aim water hoses directly at windows, door, or hood seals or at electronic modules or exposed cabling.

 **CAUTION:** To avoid corrosive damage that may not be covered by the warranty, rinse away any road salt from the underside of the vehicle, wheel wells, and brakes. After cleaning the vehicle, dry the brakes by going on a short drive and applying the brakes multiple times.

 **CAUTION:** Avoid using tight-napped or rough cloths, such as washing mitts. A high-quality microfiber cleaning cloth is recommended.

 **CAUTION:** If washing in an automatic car wash, use touchless car washes only. These car washes have no parts (brushes, etc.) that touch the surfaces of Model X. Some touchless car washes use caustic solutions that, over time, can cause discoloration of decorative exterior trim. Avoid exposure to soaps and chemicals above pH 13. If unsure, check the product label or ask the staff at the car wash. Damage caused by improper washing is not covered by the warranty.

 **CAUTION:** If washing in an automatic car wash, make sure the vehicle is locked. In addition, avoid using controls on the touchscreen that can result in accidentally opening doors or trunks while the vehicle is being washed. Any damage caused is not covered by the warranty.

CAUTION: Ensure the wipers are off before washing Model X to avoid the risk of damaging the wipers.

CAUTION: Do not use chemical based wheel cleaners or pre-wash products. These can damage the finish on the wheels.

WARNING: Never spray liquid at a high velocity (for example, if using a pressure washer) towards the charge port while Model X is charging. Failure to follow these instructions can result in serious injury or damage to the vehicle, charging equipment, or property.

Cleaning the Interior

Frequently inspect and clean the interior to maintain its appearance and to prevent premature wear. If possible, immediately wipe up spills and remove marks. For general cleaning, wipe interior surfaces using a soft cloth (such as microfiber) dampened with a mixture of warm water and mild non-detergent cleaner (test all cleaners on a concealed area before use). To avoid streaks, dry immediately with a soft lint-free cloth.

Interior Glass

Do not scrape, or use any abrasive cleaning fluid on glass or mirrored surfaces. This can damage the reflective surface of the mirror and the heating elements in the rear window.

Airbags

Do not allow any substance to enter an airbag cover. This could affect correct operation.

Dashboard and Plastic Surfaces

Do not polish the upper surfaces of the dashboard. Polished surfaces are reflective and could interfere with your driving view.

Seats

Wipe spills and chemical residues from interior surfaces as soon as possible using a soft cloth moistened with warm water and non-detergent soap. Wipe gently in a circular motion. Then wipe dry using a soft, lint-free cloth.

Although seating surfaces are designed to repel stains, Tesla recommends regular cleaning to maintain performance and an as-new appearance. Promptly treat dye transfer from clothing, such as indigo-dyed denim. Avoid contact with harsh chemicals, including certain cosmetics. Never use cleaners containing alcohol or bleach. Spot-test cleaners on an inconspicuous area before applying to visible surfaces.

If equipped with leather seats, note that leather is prone to dye-transfer which can cause discoloration, particularly on light colored leather. White and tan leather is coated with an anti-soiling treatment. Using detergents or commercially available leather cleaners and conditioners is not recommended because they can discolor or dry out the leather.

Vacuum cloth seats as needed to remove any loose dirt.

CAUTION: Aftermarket, non-Tesla seat covers may inhibit the sensitivity of a seat's occupancy sensors and may cause staining or damage.

Carpets

Avoid over-wetting carpets. For heavily soiled areas, use a diluted upholstery cleaner.

Seat Belts

Extend the belts to wipe. Do not use any type of detergent or chemical cleaning agent. Allow the belts to dry naturally while extended, preferably away from direct sunlight.

Door Seals

Wipe door seals with a damp cloth to remove any debris. Excessive debris on the door seals can cause paint damage when contacting surrounding surfaces. Avoid using alcohol wipes or any chemical products that can potentially deteriorate the coating on the door seals.

Touchscreen and Instrument Panel

Clean the touchscreen and instrument panel using a soft lint-free cloth specifically designed to clean monitors and displays. Do not use cleaners (such as a glass cleaner) or alcohol-based gel products (such as hand sanitizer) and do not use a wet wipe or a dry statically-charged cloth (such as a recently washed microfiber). To wipe the touchscreen without activating buttons and changing settings, you can enable Screen Clean Mode. Touch **Controls > Display > Screen Clean Mode**. The display darkens to make it easy to see dust and smudges. To exit Screen Clean Mode, press and hold **HOLD TO EXIT**.





Chrome and Metal Surfaces

Polish, abrasive cleaners, alcohol-based gel products (such as hand sanitizer), and hard cloths can damage the finish on chrome and metal surfaces.



Cleaning

Cautions for Interior Cleaning

-  **CAUTION:** Using solvents (including alcohol), alcohol-based gel products (such as hand sanitizer), bleach, citrus, naphtha, or silicone-based products or additives on interior components can cause damage.
-  **CAUTION:** Statically-charged materials can cause damage to the touchscreen or instrument panel.
-  **WARNING:** If you notice any damage on an airbag or seat belt, contact Tesla immediately.
-  **WARNING:** Do not allow any water, cleaners, or fabric to enter a seat belt mechanism.
-  **WARNING:** Exposure to chemical cleaners can be hazardous and can irritate eyes and skin. Read and observe the instructions provided by the manufacturer of the chemical cleaner.



Polishing, Touch Up, and Body Repair

To preserve the cosmetic appearance of the body, you can occasionally treat the paint surfaces with an approved polish containing:

- Very mild abrasive to remove surface contamination without removing or damaging the paint.
- Filling compounds that fill scratches and reduce their visibility.
- Wax to provide a protective coating between the paint and environmental elements.

Regularly inspect the exterior paint for damage. Treat minor chips and scratches using a paint touch-up pen (available for purchase from Tesla). Use the touch-up pen after washing but before polishing or waxing.

Repair rock chips, fractures or scratches. Refer to <https://www.tesla.com/support/body-shop-support> for more information on repair locations and available services.

-  **CAUTION:** Do not use cutting pastes, color restoration compounds, or polishes containing harsh abrasives. These can scour the surface and permanently damage the paint.
-  **CAUTION:** Do not use chrome polish or other abrasive cleaners.

Using a Car Cover

To preserve the cosmetic appearance of the body when Model X is not being used, use a genuine Tesla car cover. Car covers can be purchased from Tesla. See [Parts and Accessories on page 198](#).

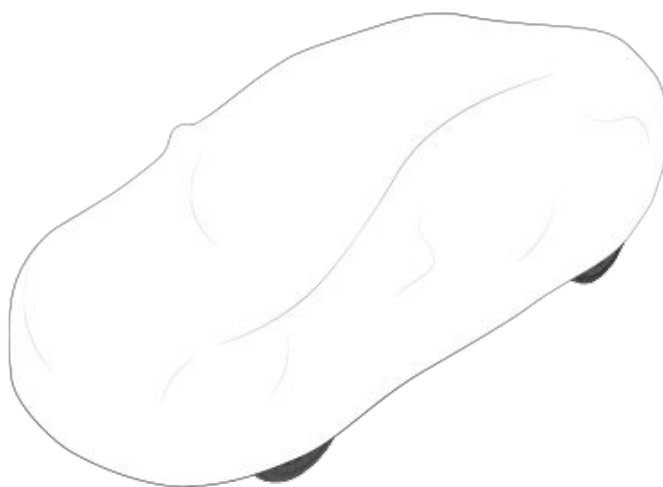

-  **CAUTION:** Use only a Tesla-approved car cover when Model X is plugged in. Using a non-Tesla car cover can prevent the Battery from being adequately cooled during charging.

Floor Mats

To extend the life of your carpet and make them easier to clean, use genuine Tesla floor mats (see [Parts and Accessories on page 198](#)). Maintain floor mats by regularly cleaning them and checking that they are properly attached. Replace floor mats if they become excessively worn.

-  **WARNING:** To avoid potential interference with a foot pedal, ensure that the driver's floor mat is securely fastened, and never place an additional floor mat on top of it. Floor mats should always rest on top of the vehicle carpeting surface and not on another floor mat or other covering.



Checking and Cleaning Wiper Blades

Periodically clean the edge of the wiper blades and check the rubber for cracks, splits, and roughness. If damaged, replace the blade immediately to prevent damage to the glass and improve visibility.

Contaminants on the windshield, or on the wiper blades, can reduce the effectiveness of the wipers. Contaminants include ice, wax spray from car washes, washer fluid with bug and/or water repellent, bird droppings, tree sap, and other organic substances.

Follow these guidelines for cleaning:

- Clean the windshield and wiper blades using washer fluid, isopropyl (rubbing) alcohol, or non-abrasive glass cleaner approved for use on automotive glass and rubber. Inappropriate products can cause damage or smears, and create glare on the windshield.
- Lift the wiper arm a short distance away from the windshield, just far enough to access the wiper blade. Do not lift a wiper arm beyond its intended position.

If the wipers remain ineffective after cleaning, replace the wiper blades.

Replacing Wiper Blades

For optimum performance, replace the wiper blades at least once a year.

NOTE: Only install replacement blades that are identical to the original blades. Using inappropriate blades can damage the wiper system and windshield.

NOTE: The wiper washing system is an integrated part of the wiper blades on Model X

To replace the wiper blades:

1. Shift into Park and turn off the wipers.
2. Touch **Controls > Service > Wiper Service Mode > ON** to move the wipers to the service position.
3. Lift the wiper arm a short distance away from the windshield, just far enough to access the wiper blade.

 **CAUTION:** Wiper blades do not lock into a lifted position. Do not lift a wiper arm beyond its intended position.

4. Squeeze the two tabs to release the wiper blade from the wiper arm.

 **CAUTION:** The wiper blade is still connected to the washer hose and cannot be removed yet.

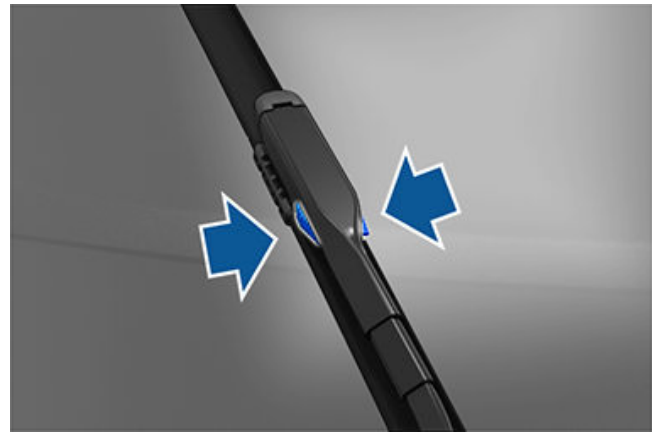

5. Place a towel between the wiper arm and windshield to avoid scratching or cracking the windshield.
6. Disconnect the washer hose from the wiper blade, taking care to avoid spilling any washer fluid.



7. Hold the wiper arm and press the locking tab while sliding the blade down the arm.
8. Fully insert the washer hose onto the nipple of the new wiper blade.
9. Align the new wiper blade on the wiper arm and slide it toward the end of the wiper arm until it locks into place.
10. Turn Wiper Service Mode off to return the wipers to their normal position.

Cleaning Washer Jets

If a windshield washer becomes blocked, use a thin strand of wire to clear any blockages from the nozzles.



Wiper Blades and Washer Jets

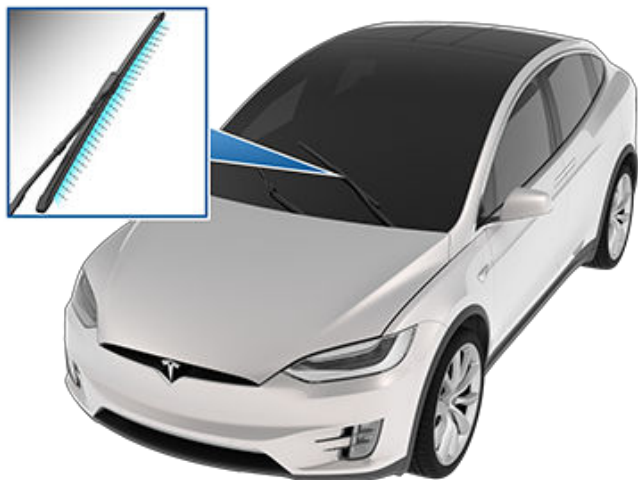

⚠ WARNING: Do not operate the washers while cleaning Model X. Windshield washer fluid can irritate eyes and skin. Read and observe the washer fluid manufacturer's instructions.



Removing the Maintenance Panel

To check fluid levels, remove the maintenance panel:

1. Open the hood.
2. Pull the maintenance panel upward to release the clips that hold it in place.

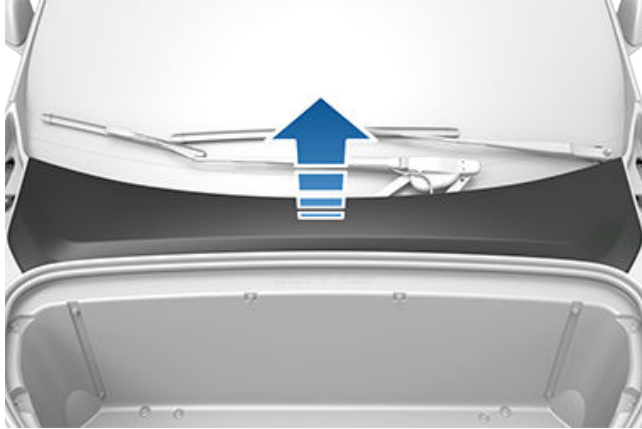

CAUTION: The maintenance panel protects the front trunk from water. When re-attaching, make sure it is fully seated.

Checking Battery Coolant

Your Battery coolant should not need to be replaced for the life of your vehicle under most circumstances. However, if the quantity of fluid in the cooling system drops below the recommended level, the instrument panel displays a warning message. Stop driving Model X as soon as safety permits and contact Tesla.

Fluid Level Check

DO NOT REMOVE THE FILLER CAP AND DO NOT ADD FLUID. Doing so can result in damage not covered by the warranty.

Do Not Top Up Battery Coolant

WARNING: Battery coolant can be hazardous and can irritate eyes and skin. Under no circumstances should you remove the filler cap and/or add coolant. If the instrument panel warns you that the fluid level is low, contact Tesla immediately.

To maximize the performance and life of the Battery, the cooling system uses a specific mixture of G-48 ethylene-glycol coolant (HOAT). Contact Tesla for more specific information about the coolant.

Checking Brake Fluid

WARNING: Contact Tesla immediately if you notice increased movement of the brake pedal or a significant loss of brake fluid. Driving under these conditions can result in extended stopping distances or complete brake failure.



A red brake indicator on the instrument panel alerts you if the quantity of fluid in the brake reservoir drops below the recommended level. If it displays while driving, stop as soon as safety permits by gently applying the brakes. Do not continue driving. Contact Tesla immediately.

Fluid Level Check

Tesla checks the brake fluid level and health at the regularly scheduled maintenance intervals.

Topping Up the Brake Fluid

Do not top up your brake fluid. The following instructions are provided for information purposes and future reference only:

1. Clean the filler cap before removing it to prevent dirt from entering the reservoir.
2. Unscrew the cap and remove it.
3. Top up the reservoir to the **MAX** mark using the appropriate brake fluid.
4. Reinstall the filler cap, ensuring it is fully secured.

WARNING: Only use new fluid from a sealed airtight container. Never use previously used fluid or fluid from a previously opened container—fluid absorbs moisture which decreases braking performance.

WARNING: Brake fluid is highly toxic. Keep containers sealed and out of the reach of children. In the event of accidental consumption, seek medical attention immediately.

CAUTION: Brake fluid damages painted surfaces. Immediately soak up any spills with an absorbent cloth and wash the area with a mixture of car shampoo and water.

Topping Up Windshield Washer Fluid

The only reservoir into which you can add fluid is the windshield washer fluid reservoir, which is located behind the front trunk. When the level is low, a message displays on the instrument panel.

To top up the washer fluid:



Fluid Reservoirs

1. Open the hood.
2. Clean around the filler cap before opening it to prevent dirt from entering the reservoir.
3. Open the filler cap.
4. While avoiding spilling, fill the reservoir until the fluid level is visible just below the filler neck.



5. Wipe up any spills immediately and wash the affected area with water.
6. Reinstall the filler cap.

NOTE: Some national or local regulations restrict the use of Volatile Organic Compounds (VOCs). VOCs are commonly used as antifreeze in washer fluid. Use a washer fluid with limited VOC content only if it provides adequate freeze resistance for all climates in which you drive Model X.

- CAUTION:** Do not add formulated washer fluids that contain water repellent or bug wash. These fluids can cause streaking, smearing, and squeaking or other noises.
- WARNING:** In temperatures below 40° F (4° C), use a washer fluid with antifreeze. In cold weather, using a washer fluid without antifreeze can impair visibility through the windshield.
- WARNING:** Windshield washer fluid can irritate eyes and skin. Read and observe the instructions provided by the washer fluid manufacturer.



Jacking Procedure

Follow the steps below to lift Model X. Ensure that any non-Tesla repair facility is aware of these lifting points.

1. Position Model X centrally between the lift posts.
2. If your Model X is equipped with air suspension, it automatically self-levels, even when power is off (see [Jack Mode on page 197](#)). Use the touchscreen to set the suspension as follows:
 - Touch **Controls** > **Suspension**.
 - Press the brake pedal, then touch **Very High** to maximize the height of the suspension.
 - Touch **Controls** > **Service** > **Jack Mode** to disable self-leveling.
3. Close the falcon wing doors.
4. Position the lift arm pads under the designated body lift points at the locations shown.

WARNING: DO NOT position the lift arm pads under the Battery or side rails, as shown in red.

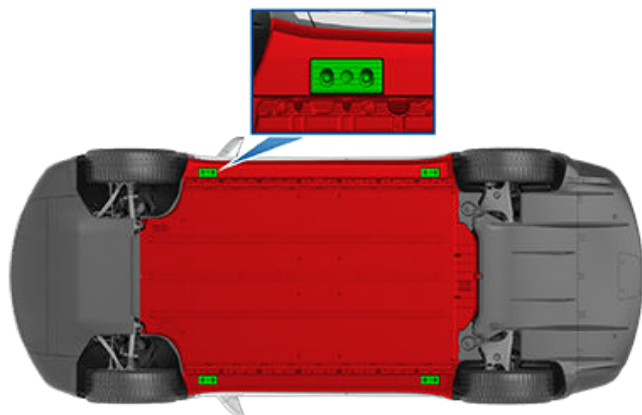

5. Adjust the height and position of the lift arm pads to ensure that they are correctly located.
6. With assistance, raise the lift to the desired height, ensuring the lift arm pads remain in their correct positions.
7. Engage any lift safety locks. Follow the lift manufacturer's instructions.

NOTE: Jack mode cancels when Model X is driven over 4 mph (7 km/h).

NOTE: Jack mode may be unexpectedly enabled in situations where an object is supporting the vehicle's weight (for example the bumper of the vehicle is resting on a curb).

WARNING: The air suspension system automatically self-levels, even when power is off. You **MUST** disable this system by engaging Jack mode before lifting or jacking. If you do not disable the air suspension, Model X can attempt to self-level, causing serious damage, bodily injury, or death.

WARNING: Never raise Model X when the charge cable is connected, even if charging is not in progress.

WARNING: Do not work on an incorrectly supported vehicle. Doing so can cause serious damage, bodily injury, or death.

CAUTION: DO NOT lift from under the Battery or side rails. Place the lift arm pads under the designated body lift points only. The locations shown are the only approved lifting points for Model X. Lifting at any other points can cause damage. Damage caused by incorrectly lifting Model X is not covered by the warranty.

Jack Mode

If Model X is equipped with air suspension, it automatically self-levels, even when power is off. To prevent damage when jacking or lifting the vehicle, you must activate Jack mode to disable self-leveling. Jack mode prevents the self-leveling that occurs even when Model X is powered off.

Press the brake pedal, then touch **Controls** > **Service** > **Jack Mode**.

To deactivate, touch **Jack Mode** again.

NOTE: Jack Mode automatically cancels when you drive over 4 mph (7 km/h).

NOTE: Model X also sets Jack mode automatically if it detects that the vehicle cannot lower to its target height, or if it detects that an object is supporting the vehicle's weight (for example the bumper of the vehicle is resting on a curb).

Parts, Accessories, and Modifications

Use only genuine Tesla parts and accessories. Tesla performs rigorous testing on parts to ensure their suitability, safety, and reliability. Purchase these parts from Tesla, where they are professionally installed and where you can receive expert advice about modifications to Model X. Accessories are available for purchase from Tesla stores or online at www.tesla.com.

NOTE: Some accessories may not be available in your market region.

Tesla is unable to assess parts manufactured by other distributors and therefore accepts no responsibility if you use non-Tesla parts on Model X.

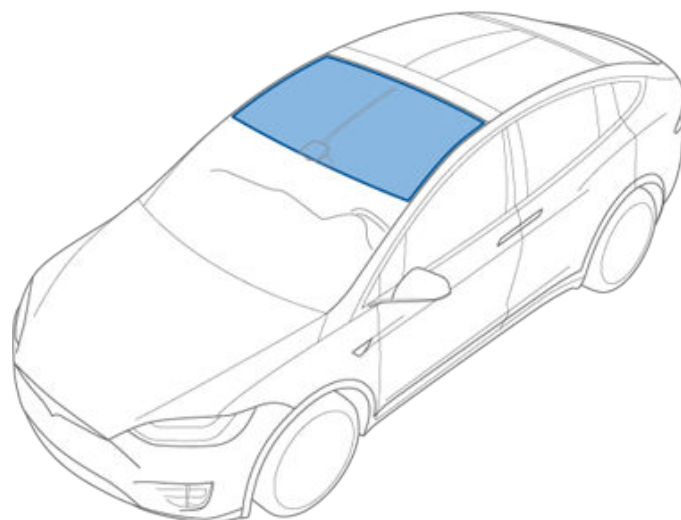

⚠ WARNING: Installing non-approved parts and accessories, or performing non-approved modifications, can affect the performance of Model X and the safety of its occupants. Any damage caused by using or installing non-approved parts, or by performing non-approved modifications, is not covered by the warranty.

⚠ WARNING: Tesla does not accept liability for death, personal injury or damage that occurs if you use or install non-approved accessories or make non-approved modifications.

Body Repairs

If your Model X is in a collision, contact Tesla or a Tesla-approved Body Shop to ensure that it is repaired with genuine Tesla parts. Tesla has selected and approved body shops that meet strict requirements for training, equipment, quality, and customer satisfaction.

Some repair shops and insurance companies might suggest using non-original equipment or salvaged parts to save money. However, these parts do not meet Tesla's high standards for quality, fit and corrosion resistance. In addition, non-original equipment and salvaged parts (and any damage or failures they might cause) are not covered by the warranty.

Using RFID Transponders

When attaching an RFID transponder (used by many automated toll systems) inside Model X, place the transponder in the topmost area of the windshield as shown. This ensures best results and minimizes any obstruction to your driving view.

NOTE: You can also attach a weather-proof transponder to the front license plate.



Vehicle Identification Number

You can find the VIN at the following locations:

- Touch **Controls** > **Software**.
- Stamped on a plate located at the top of the dashboard. Can be seen by looking through the windshield.
- Stamped on the chassis under the sill panel on the rear passenger door. To remove the sill panel, gently pry it upward using a flat-bladed tool.

NOTE: The VIN was not stamped on the chassis on vehicles manufactured between approximately June 2, 2016 and Feb 28, 2017.

! **CAUTION:** Removing the sill panel to view the VIN is not recommended because damage is likely to occur. The panel is held in place with fragile clips that break easily. Damage caused by removing the sill panel is not covered by the warranty.

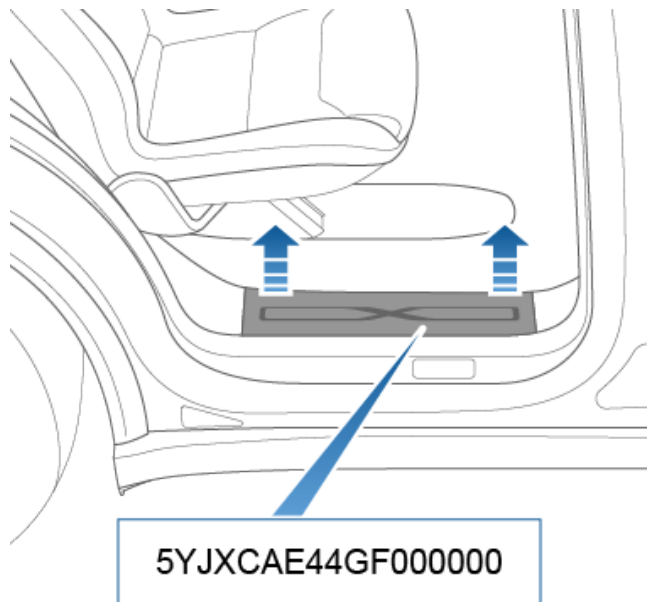

Emission Control Label

The emission control label is located on the opening face of the liftgate.

NOTE: For vehicles with a model year of 2022 or newer, the emission control label is now located on the inside of the front hood and may not match the label shown.





Vehicle Loading

Load Capacity Labeling

It is important to understand how much weight your Model X can safely carry. This weight is called the vehicle capacity weight and includes the weight of all occupants, cargo and any additional equipment added to your Model X since it was manufactured.

One or more labels attached to the center door pillar indicate how much weight Model X can safely carry. Labels are visible when the front door is open.

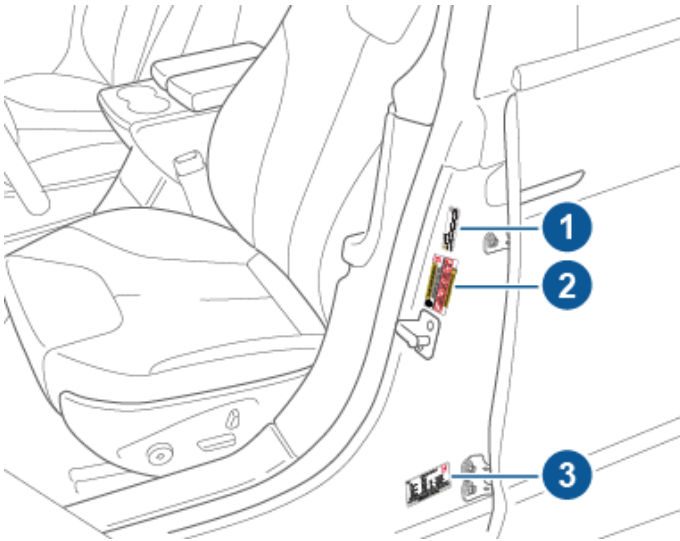

1. Towing label (if equipped)
2. Tire and Loading Information label
3. Vehicle Certification label

NOTE: Towing capability is available only if Model X is equipped with the Towing Package.

WARNING: Overloading Model X has an adverse effect on braking and handling, which can compromise your safety or cause damage.

CAUTION: Never load more than 300 lbs (136 kg) in the front trunk. Doing so can cause damage.

CAUTION: Never load more than 175 lbs (80 kg) on the upper trunk compartment or more than 285 lbs (130 kg) in the lower trunk compartment. Doing so can cause damage.

CAUTION: Never store large amounts of liquid in Model X. A significant spill can cause electrical components to malfunction.

Towing Label

If equipped with the towing package, the Towing Label instructs you to refer to this owner's manual for tire pressures that should be used when towing a trailer. Do not use the tire pressures printed on the Tire and Loading Information Label.

IMPORTANT!
For towing and high speed driving, please refer to owner's manual for tire inflation pressure requirements.

Depending on vehicle manufacture date, Model X may or may not have a towing label.

NOTE: Towing capability is available only if Model X is equipped with the Towing Package. Tire pressure information, along with other information related to towing, is located in the topic "Towing a Trailer" in the Driving section of the onscreen Owner's Manual.

Tire and Loading Information Label

The Tire and Loading Information label provides:

- The maximum number of occupant seating positions.
- The maximum vehicle capacity weight.
- The size of the original tires.
- The cold inflation pressures for the original front and rear tires. These pressures are recommended to optimize ride and handling characteristics.

United States/Canada:

TIRE AND LOADING INFORMATION
RENSEIGNEMENTS SUR LES PNEUS ET LE CHARGEMENT

SEATING CAPACITY/NOMBRE DE PLACES - TOTAL X FRONT/AVANT X REAR/ARRIÈRE X
THE COMBINED WEIGHT OF OCCUPANTS AND CARGO SHOULD NEVER EXCEED
LE POIDS TOTAL DES OCCUPANTS ET DU CHARGEMENT NE DOIT JAMAIS DÉPASSER

TIRE/PNEU	FRONT/AVANT	REAR/ARRIÈRE	SPARE/DE SECOURS
ORIGINAL TIRE SIZE/ TAILLE DES PNEUS D'ORIGINE	depends on vehicle model	depends on vehicle model	NONE/AUCUN
COLD TIRE PRESSURE/ PRESSION DES PNEUS A FROID	depends on vehicle model	depends on vehicle model	NONE/AUCUN

SEE OWNER'S MANUAL FOR ADDITIONAL INFORMATION. VOIR LE MANUEL DE L'USAGER POUR PLUS DE RENSEIGNEMENTS.

Mexico:

INFORMACIÓN DE NEUMÁTICOS Y DE CARGA

NÚMERO TOTAL DE PLAZAS - ADELANTE 2 ATRÁS
EL PESO COMBINADO DE LOS OCUPANTES Y LA CARGA NUNCA DEBE EXCEDER

NEUMÁTICO	DELANTERO	TRASERO	REFACCIÓN
TAMAÑO DE NEUMÁTICO ORIGINAL			N/A
PRESIÓN DE INFLADO PARA LLANTAS EN FROID			N/A

CONSULTE EL MANUAL DEL PROPIETARIO PARA MÁS INFORMACIÓN

Never change this label, even if you use different tires in the future.

NOTE: If Model X is loaded to its full capacity, double check all tires to ensure they are inflated to their recommended pressure levels.



⚠ WARNING: Tire pressures printed on the Tire and Loading Information label DO NOT APPLY to towing. When towing, tire pressures must be increased. For information about the tire pressures required when towing, see [Towing and Accessories](#) on page 82.

Vehicle Certification Label

The Vehicle Certification label provides:

- GVWR - Gross Vehicle Weight Rating. The maximum allowable total mass of Model X. This is calculated as the weight of Model X equipped with the heaviest factory selectable options, all passengers, fluids, and cargo.
- GAWR FRT and GAWR RR - Gross Axle Weight Rating for the front and rear axles. The GAWR is the maximum distributed weight that each axle can support.

United States:

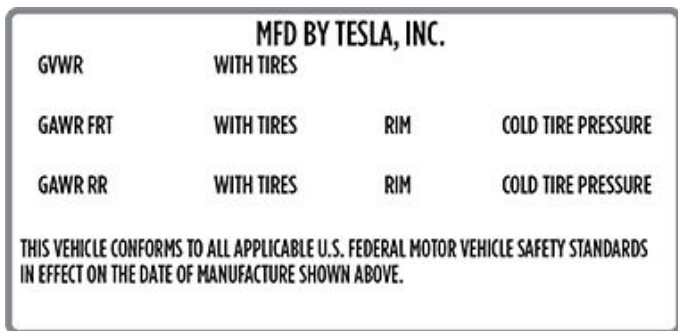

Canada:



Mexico:



⚠ CAUTION: To prevent damage, never load Model X so that it is heavier than GVWR or exceeds the individual GAWR weights.

Calculating Load Limits

1. Locate the statement “The combined weight of occupants and cargo should never exceed XXX lbs or XXX kg” on the “Tire and Loading Information” label.
2. Determine the combined weight of all occupants that will ride in the vehicle.
3. Subtract the combined weight of the occupants from XXX lbs or XXX kg (see Step 1).
4. The resulting figure equals the available cargo load capacity. For example, if the “XXX” amount equals 1400 lbs (635 kg) and there will be five 150 lb (68 kg) passengers in the vehicle, the amount of available cargo capacity is 650 lbs (1400 - 750) (5 x 150) = 650 lbs or 295 kg (635 - 340) (5 x 68) = 295 kg).
5. Determine the combined cargo weight being loaded on the vehicle. That weight must not exceed the available cargo load capacity calculated in Step 4.

⚠ WARNING: Trunks are the preferred places to carry objects. In a collision, or during hard braking and sharp turns, loose items in the cabin could injure occupants.

Example Load Limit Calculations

How much cargo Model X can carry depends on the number and weight of passengers. The following calculated load limit examples assume passengers weigh 150 lbs (68 kg). If passengers weigh more or less, available cargo weight decreases or increases respectively.

Driver and one passenger

Description	Total
Vehicle capacity weight	954 lbs (433 kg)
Subtract occupant weight (2 x 150 lbs/68 kg)	300 lbs (136 kg)
Available cargo weight	654 lbs (297 kg)



Vehicle Loading

Driver and four passengers

Description	Total
Vehicle capacity weight	954 lbs (433 kg)
Subtract occupant weight (5 x 150 lbs/68 kg)	750 lbs (340 kg)
Available cargo weight	204 lbs (93 kg)

The cargo weight should be distributed between the front and rear trunks.

 **CAUTION:** Never load more than 175 lbs (80 kg) on the rear load floor (above the lower trunk compartment) or more than 285 lbs (130 kg) in the lower trunk compartment. Doing so can cause damage.



Exterior Dimensions

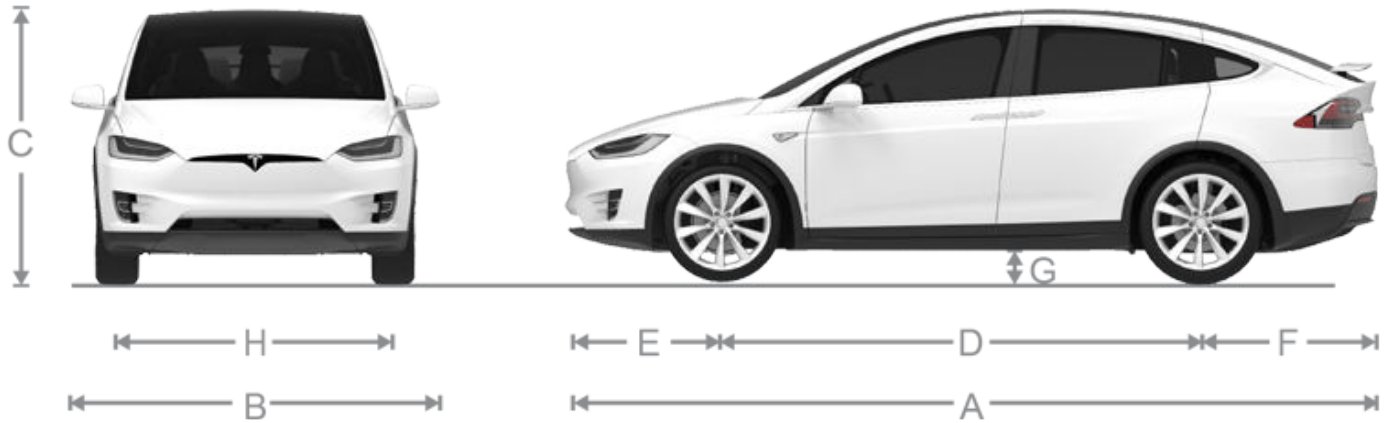

A	Overall Length	198.9 in	5,052 mm
B	Overall Width (including mirrors)	89.4 in	2,271 mm
	Overall Width (including folded mirrors)	81.6 in	2,072 mm
	Overall Width (excluding mirrors)	78.7 in	1,999 mm
C	Overall Height	66 in*	1,684 mm*
D	Wheel Base	116.7 in	2,965 mm
E	Overhang - Front	38.9 in	989 mm
F	Overhang - Rear	43.2 in	1,098 mm
G	Ground Clearance:		
	Standard, with skis	7 in	171 mm
	Standard, without skis	7 in	183 mm
	Very high, with skis	8 in	211 mm
	Very high, without skis	9 in	223 mm
H	Track - Front	67.1 in	1,705 mm
	Track - Rear	67.3 in	1,710 mm

*Values are approximate. Dimensions can vary depending on a vehicle's options and various other factors.

Interior Dimensions

Head Room	Front	41.7 in	1059 mm
	Rear	40.9 in	1039 mm
	Third	37.1 in	942 mm
Leg Room	Front	41.2 in	1046 mm
	Rear	38.4 in	975 mm
	Third	32.7 in	831 mm



Dimensions and Weights

Shoulder Room	Front Rear Third	60.7 in 56.8 in 40 in	1542 mm 1442 mm 1016 mm
Hip Room	Front Rear Third	55.6 in 59 in 38.5 in	1412 mm 1498 mm 978 mm

Cargo Volume

	Front Trunk	Rear*	Total
Seven Seat Vehicles	6.6 cu ft (187 L)	76.5 cu ft (2166 L)**	83.1 cu ft (2353 L)
Six Seat Vehicles	6.6 cu ft (187 L)	70.7 cu ft (2002 L)**	77.3 cu ft (2189 L)
Five Seat Vehicles	6.6 cu ft (187 L)	81.2 cu ft (2299.5 L)**	87.8 cu ft (2486.5 L)

* Maximum cargo volume behind the front row seats. Includes the 12.6 cu ft (357 L) cargo area in the rear trunk (area behind the third row seats, if equipped).

** Second row seats fully forward and/or folded.

Weights

Refer to the certification label for mass data (see [Identification Labels on page 199](#)).

Motor Type

Front Motor	AC permanent magnet synchronous motor, liquid-cooled, with variable frequency drive
Rear Motor	AC induction motor, liquid-cooled, with variable frequency drive
Nominal Voltage	320 volts

Transmission

Type	Specifications
Type	Single speed fixed gear
Overall Final Drive Ratio	Small motor: 9.0:1 Large motor: 9.7:1
Reverse Gear	Reverse direction of motor, limited to 15 mph (24 km/h)

Steering

Steering	Specifications
Type	Variable rack and pinion with electronic power steering, speed sensitive
Number of turns lock to lock	2.33
Turning Circle (curb to curb)	40.8 ft (12.4 m)

Brakes

Brakes	Specifications
Type	4-wheel anti-lock braking system (ABS) with Electronic Brake Force Distribution, Integrated Advanced Stability Control and Electronic Accelerator pedal actuated regenerative braking system
Calipers	Front: Four piston, fixed Rear: Single piston, floating
Rotor Diameters (ventilated)	Front: 13.98"/355 mm Rear: 14.37"/365 mm
Front Rotor thickness	New: 1.26"/32 mm Service limit: 1.18"/30 mm
Rear Rotor thickness	New: 1.10"/28 mm Service limit: 1.02"/26 mm
Front Brake Pad Thickness (excluding back plate)	0.346"/8.8 mm



Brakes	Specifications
Rear Brake Pad Thickness (excluding back plate)	0.354"/9 mm
Parking brake	Electrically actuated parking brake calipers
Brake Disc Friction Pair	Front: .31"/8 mm
	Rear: .28"/7 mm

Suspension

Suspension	Specifications
Front	Independent, virtual pivot double wishbone
Rear	Independent, virtual pivot double wishbone

Battery - Low Voltage

Battery - Low Voltage	Specifications
Rating	33 amp hour or higher
Voltage and Polarity	Low voltage negative (-) ground

Battery - High Voltage

Battery - High Voltage	Specifications
Type	Liquid-cooled lithium ion (Li-ion)
Temperature Range	Do not expose Model X to ambient temperatures above 140° F (60° C) or below -22° F (-30° C) for more than 24 hours at a time.



Wheel Specifications (Factory)

Wheel Type	Size	Offset
20" All Season - Front	9.0J x 20	1.575" (40 mm)
20" All Season - Rear	9.5J x 20	1.378" (35 mm)
20" Summer - Front	9.0J x 20	1.575" (40 mm)
20" Summer - Rear	10.0J x 20	1.378" (35 mm)
22" Summer - Front	9.0J x 22	1.575" (40 mm)
22" Summer - Rear	10.0J x 22	1.378" (35 mm)
Lug Nut Torque	129 lb. ft (175 Nm)	
Lug Nut Socket Size	21 mm	

NOTE: For instructions on how to jack/lift Model X, see [Jacking and Lifting on page 197](#).

Tire Specifications (Factory)

Tire Type	Size	Load Index / Speed Rating
20" - Continental - Front	265/45R20	108 / V
20" - Continental - Rear	275/45R20	110 / V
22" - Continental, Goodyear, or Pirelli - Front	265/35R22	102 / W
22" - Continental, Goodyear, or Pirelli - Rear	285/35R22	106 / W

Refer to the tire pressures printed on the Tire and Loading Information label. This label is located on the driver's door pillar and is visible when the driver's door is open (see [Maintaining Tire Pressures on page 184](#)).

Winter tires can be purchased from a Tesla service center or may be available for purchase on the Tesla web site.



Understanding Tire Markings

Laws require tire manufacturers to place standardized information on the sidewall of all tires. This information identifies and describes the fundamental characteristics of the tire. It also provides the tire identification number (TIN) for certification of safety standards, and in case of a recall.



1	Tire category. P indicates that the tire is for passenger vehicles.
2	Tire width. This 3-digit number is the width (in millimeters) of the tire from sidewall edge to sidewall edge.
3	Aspect ratio. This 2-digit number is the sidewall height as a percentage of the tread width. So, if the tread width is 205 mm, and the aspect ratio is 50, the sidewall height is 102 mm.
4	Tire construction. R indicates that the tire is of Radial ply construction.
5	Wheel diameter. This 2-digit number is the diameter of the wheel rim in inches.
6	Load index. This 2 or 3-digit number is the weight each tire can support. This number is not always shown.



7	Speed rating. When stated, indicates the maximum speed (in mph) at which the tire can be used for extended periods. Q=99 mph (160 km/h), R=106 mph (170 km/h), S=112 mph (180 km/h), T=118 mph (190 km/h), U=124 mph (200 km/h), H=130 mph (210 km/h), V=149 mph (240 km/h), W=168 mph (270 km/h), Y=186 mph (300 km/h), (Y)=vehicle's top speed (exceeds the "Y" rating).
8	Tire composition and materials. The number of plies in both the tread area and the sidewall area indicates how many layers of rubber coated material make up the structure of the tire. Information is also provided on the type of materials used.
9	Maximum tire load. The maximum load which can be carried by the tire.
10	Maximum permissible inflation pressure. This pressure should not be used for normal driving.
11	U.S. DOT Tire Identification Number (TIN). Begins with the letters DOT and indicates that the tire meets all federal standards. The next 2 digits/letters represent the plant code where it was manufactured, and the last 4 digits represent the week and year of manufacture. For example, the number 1712 is used to represent the 17th week of 2012. The other numbers are marketing codes used at the manufacturer's discretion. This information can be used to contact consumers if a tire defect requires a recall.
12	Treadwear grade. This number indicates the tire's wear rate. The higher the treadwear number is, the longer it should take for the tread to wear down. A tire rated at 400, for example, lasts twice as long as a tire rated at 200.
13	Traction grade. Indicates a tire's ability to stop on wet roads. A higher graded tire should allow you to stop your vehicle in a shorter distance than a tire with a lower grade. Traction is graded from highest to lowest as AA, A, B, and C.
14	Temperature grade. The tire's resistance to heat is grade A, B, or C, with A indicating the greatest resistance. This grading is provided for a correctly inflated tire, which is being used within its speed and loading limits.



Uniform Tire Quality Grading

The following information relates to the tire grading system developed by the National Highway Traffic Safety Administration (NHTSA), which grades tires by tread wear, traction and temperature performance. Tires that have deep tread, and winter tires, are exempt from these marking requirements.

Where applicable, quality grades are found on the tire's sidewall between the tread shoulder and maximum section width. For example:

- TREADWEAR 180
- TRACTION AA
- TEMPERATURE A

The quality grades are described next.

NOTE: In addition to the marking requirements, passenger car tires must conform to Federal Safety Requirements.

Treadwear

The treadwear grade is a comparative rating based on the wear rate of the tire when tested under controlled conditions on a specified government test course.

For example, a tire graded 150 wears one and a half times better on a government test course than a tire graded 100. The relative performance of tires depends on the actual conditions of their use, however, and can depart significantly from the norm due to variations in driving habits, service practices, road characteristics, and climate.

Traction

The traction grades, from highest to lowest, are: AA, A, B, and C. These grades represent a tire's ability to stop on wet pavement as measured under controlled conditions on test surfaces of asphalt and concrete. A tire marked C might have poor traction performance.

 **WARNING:** Defective tires are dangerous. Do not drive if a tire is damaged, excessively worn, or is inflated to an incorrect pressure. The safety of the vehicle and occupants can be adversely affected. Check tires regularly for wear and to ensure there are no cuts, bulges or exposure of the ply/cord structure.

 **WARNING:** The traction grade assigned to the tire is based on straight-ahead braking tests, and does not include: acceleration, cornering, hydroplaning or peak traction characteristics.

Temperature

The temperature grades are A (the highest), B, and C, representing the tire's resistance to the generation of heat and its ability to dissipate heat when tested under controlled conditions on a specified indoor laboratory test wheel. Sustained high temperature can cause the tire to degenerate and reduce tire life, and excessive temperature can lead to sudden tire failure.

The grade C corresponds to the minimum level of performance that all passenger car tires must meet under the Federal Motor Safety Standard No. 109. Grades B and A represent levels of performance on the laboratory test wheel that exceed the minimum requirements.

 **WARNING:** A tire's temperature grade is established for a tire that is properly inflated and not overloaded. Excessive speed, under-inflation, or excessive loading, either separately or in combination, can cause heat buildup and possible tire failure.



Tire and Loading Glossaries

General Wheel and Tire Terms

Accessory Weight	The combined weight (in excess of those items replaced) of items available as factory installed equipment.
Bead	The inner edge of a tire that is shaped to fit to the rim and form an air tight seal. The bead is constructed of steel wires which are wrapped, or reinforced, by the ply cords.
Cold Tire Pressure	The air pressure in a tire that has been standing in excess of three hours, or driven for less than one mile.
Curb Weight	The weight of a standard vehicle, including any optional equipment fitted, and with the correct fluid levels.
Gross Vehicle Weight	The maximum permissible weight of a vehicle with driver, passengers, load, luggage, and equipment.
kPa (kilo pascal)	A metric unit used to measure pressure. One kilo pascal equals approximately 0.145 psi.
Maximum Inflation Pressure	The maximum pressure to which the tire should be inflated. This pressure is given on the tire side wall in psi (lbf/in ²).  CAUTION: This pressure marked on the tire is the maximum allowed by the tire manufacturer. It is not the pressure Tesla recommends using for Model X.
Maximum Loaded Vehicle Weight	The sum of curb weight, accessory weight, vehicle capacity weight, and production options weight.
Production Options Weight	The combined weight of options installed which weigh in excess of 3 lb (1.4 kg) more than the standard items that they replaced, and are not already considered in curb or accessory weights.
PSI (lbf/in ²)	Pounds per square inch (the unit used to measure tire pressure).
Recommended Tire Inflation Pressure	Tire inflation pressure, established by Tesla, which is based on the type of tires that are mounted on the vehicle at the factory. This information can be found on the Tire and Loading Information label located on the door pillar.
Rim	The metal support for a tire, or tire and tube, upon which the tire beads are seated.
Vehicle Capacity Weight	The number of seats multiplied by 150 lbs (68 kg) plus the rated amount of load/luggage.

Load Carrying Definitions

Normal occupant weight	68 kilograms (150 lbs) times the number of occupants specified in the second column of the tables for calculating load limits (see Vehicle Loading on page 200).
Occupant distribution	Distribution of occupants in a vehicle.
Passenger car tire	A tire intended for use on passenger cars, multipurpose passenger vehicles, and trucks, that have a gross vehicle weight rating (GVWR) of 10,000 lbs (4536 kg) or less.
Rim diameter	Nominal diameter of the bead seat.
Rim size designation	Rim diameter and width.
Rim type designation	The manufacturing industry's designation for a rim by style or code.
Rim width	Nominal distance between the rim's flanges.
Vehicle maximum load on the tire	Load on an individual tire that is determined by distributing to each axle its share of the maximum loaded vehicle weight and dividing by two.



Wheels and Tires

Vehicle normal load on the tire	Load on an individual tire that is determined by distributing to each axle its share of the curb weight, accessory weight, and normal occupant weight and dividing by two.
---------------------------------	--

Pneumatic Radial Tire Definitions

Bead separation	A breakdown of the bond between components in the bead.
Bias ply tire	A pneumatic tire in which the ply cords that extend to the beads are laid at alternate angles substantially less than 90 degrees to the center line of the tread.
Carcass	The tire structure, except tread and sidewall rubber which, that when inflated, bears the load.
Chunking	The breaking away of pieces of the tread or sidewall.
Cord	The strands forming the plies in the tire.
Cord separation	The parting of cords from adjacent rubber compounds.
Cracking	Any parting within the tread, sidewall, or inner liner of the tire extending to cord material.
Extra load tire	A tire designed to operate at higher loads and higher inflation pressure than the corresponding standard tire.
Groove	The space between two adjacent tread ribs.
Inner liner	The layer(s) forming the inside surface of a tubeless tire that contains the inflating medium within the tire.
Inner liner separation	The parting of the inner liner from cord material in the carcass.
Load rating	The maximum load that a tire is rated to carry for a given inflation pressure.
Maximum load rating	The load rating for a tire at the maximum permissible inflation pressure for that tire.
Measuring rim	The rim on which a tire is fitted for physical dimension requirements.
Open splice	Any parting at any junction of tread, sidewall, or inner liner that extends to the cord material.
Outer diameter	The overall diameter of an inflated new tire.
Overall width	The linear distance between the exteriors of the sidewalls of an inflated tire, including elevations due to labeling, decorations, or protective bands or ribs.
Ply	A layer of rubber-coated parallel cords.
Ply separation	A parting of rubber compound between adjacent plies.
Pneumatic tire	A mechanical device made of rubber, chemicals, fabric and steel or other materials, that, when mounted on an automotive wheel, provides the traction and contains the gas or fluid that sustains the load.
Radial ply tire	A pneumatic tire in which the ply cords that extend to the beads are laid at substantially 90 degrees to the center line of the tread.
Reinforced tire	A tire designed to operate at higher loads and at higher inflation pressures than the corresponding standard tire.
Section width	The linear distance between the exteriors of the sidewalls of an inflated tire, excluding elevations due to labeling, decoration, or protective bands.
Sidewall	The portion of a tire between the tread and bead.
Sidewall separation	The parting of the rubber compound from the cord material in the sidewall.



Snow tire	A tire that attains a traction index equal to or greater than 110, compared to the ASTM E1136-93 (re-approved 2003, incorporated by reference, see §571.5) Standard Reference Test Tire when using the snow traction test as described in ASTM F1805-00 (incorporated by reference, see §571.5), and that is marked with an Alpine Symbol specified in S5.5(i) on at least one sidewall.
Test rim	The rim on which a tire is fitted for testing, and may be any rim listed as appropriate for use with that tire.
Tread	The portion of a tire that comes into contact with the road.
Tread rib	A tread section running around the circumference of a tire.
Tread separation	The pulling away of the tread from the tire carcass.
Tread wear indicators (TWI)	The projections within the principal grooves designed to give a visual indication of the degrees of wear of the tread.
Wheel-holding fixture	The fixture used to hold the wheel and tire assembly securely during testing.



Contacting Tesla Roadside Assistance

Tesla Roadside Assistance is available to you 24 hours a day, 365 days a year, for the duration of your warranty period. Tesla Roadside Assistance is also available to speak with roadside service professionals to answer any questions and explain the proper procedure for transporting your vehicle.

When contacting Tesla Roadside Assistance, please provide:

- The Vehicle Identification Number (VIN). The VIN is displayed when you touch **Controls > Software**. The VIN can also be seen on the upper dashboard by looking through the driver's side of the windshield.
- Your exact location.
- The nature of the problem.

If available in your region, you can also expedite your request, by choosing the Roadside Assistance option in the Tesla mobile app.

NOTE: For a detailed description of Tesla's Roadside Assistance policy, go to the support page on the Tesla web site for your region.

Regional Phone Number(s)

Mexico: [1-800-228-8145](tel:1-800-228-8145)

United States and Canada: [1-877-79TESLA](tel:1-877-79TESLA) ([1-877-798-3752](tel:1-877-798-3752))

NOTE: The phone number is also available by touching **Controls > Service**.



DO NOT TRANSPORT WITH WHEELS ON THE GROUND

The front motor in Model X generates power when the wheels spin. Always transport Model X with all four tires off the ground. Ensure that the tires are unable to spin at any time during transport.

⚠ WARNING: NEVER TRANSPORT YOUR VEHICLE WITH THE TIRES IN A POSITION WHERE THEY CAN SPIN. DOING SO CAN LEAD TO SIGNIFICANT DAMAGE AND OVERHEATING. IN RARE CASES EXTREME OVERHEATING MAY CAUSE THE SURROUNDING COMPONENTS TO IGNITE.



Do not transport Model X using any method that is not specified by Tesla. Adhere to the instructions provided in the following sections and observe all warnings and cautions provided. Damage caused by improper transporting of your vehicle is not covered by the warranty.

NOTE: Tesla is not liable or responsible for reimbursing services not dispatched through Tesla Roadside Assistance.

Approved Methods for Transporting

NOTE: The tires are allowed to rotate slowly (under 3 mph or 5 km/h) and for a very short distance (less than 30 feet or 10 meters) only when Transport Mode is enabled (see [Activate Transport Mode on page 216](#)) while the vehicle is being winched onto a flatbed truck or pulled out of a parking space for repositioning. Exceeding these boundaries can lead to significant damage and overheating that is not covered by the warranty.

A flatbed truck or comparable transport vehicle is the recommended method of transporting Model X. The vehicle can face either direction when using a flatbed.



If Model X must be transported without a flatbed truck, then wheel lifts and dollies must be used to ensure that all four wheels are off the ground. This method may only be used for a maximum of 35 miles (55 km), and must not exceed the manufacturer speed rating of the dollies. With this method, Tesla recommends the vehicle facing forward so that the front wheels are lifted and the rear wheels are on dollies.

NOTE: Transporting Model X with the front wheels on dollies is not recommended, but may be done if an external steering wheel lock is applied and care is taken to prevent the front wheels from spinning. **DO NOT TRANSPORT YOUR VEHICLE IF THERE IS ANY CHANCE OF THE FRONT WHEELS SPINNING.**



⚠ CAUTION: Enable Transport Mode (see [Activate Transport Mode on page 216](#)) before winching Model X onto a flatbed truck (see [Pull onto the Flatbed Truck - With Tow Eye on page 216](#)). If Transport Mode is not available or the touchscreen is not accessible, self-loading dollies or tire skates must be used to load the vehicle into the approved transportation position. Tesla is not responsible for any damage caused by or during the transport of Model X, including personal property damage or damage caused by using self-loading dollies or tire skates.

⚠ WARNING: Model X is equipped with high voltage components that may be compromised as a result of a collision (see [High Voltage Components on page 173](#)). Before transporting Model X, it is important to assume these components are energized. Always follow high voltage safety precautions (wearing personal protection equipment, etc.) until emergency response professionals have evaluated the vehicle and can accurately confirm that all high voltage systems are no longer energized. Failure to do so may result in serious injury.

Disable the Self-Leveling Air Suspension System

If Model X is equipped with the air suspension system, it automatically self-levels, even when power is off. To prevent damage, you must activate Jack Mode to disable self-leveling:



Instructions for Transporters

1. Touch **Controls** > **Suspension** on the touchscreen.
2. Press the brake pedal, then touch **Very High** to maximize height.
3. Touch **Controls** > **Service** > **Jack Mode**.

NOTE: Jack Mode cancels when driving speed exceeds 4 mph (7 kph).

WARNING: Failure to activate Jack Mode on a vehicle equipped with the air suspension system can result in the vehicle becoming loose during transport, which may cause significant damage.

Activate Transport Mode

Transport Mode keeps the parking brake disengaged while winching Model X onto a flatbed truck. When active, Transport Mode displays a message indicating that the vehicle will remain free-rolling. The following are required to enable Transport Mode:

- Low voltage power is required. You are unable to use the touchscreen to activate Transport Mode if Model X has no power.
- Model X must detect a key fob. Transport Mode is available only when a key fob is detected.

To activate Transport Mode:

1. Ensure the vehicle is in Park.
2. Chock the tires or otherwise ensure Model X is secure.
3. Press and hold the brake pedal, then on the touchscreen, touch **Controls** > **Service** > **Towing**. The touchscreen displays a message reminding you how to properly transport Model X.
4. Press and hold the **Transport Mode** button until it turns blue. Model X is now free-rolling and can slowly be rolled (no faster than walking speed) or winched.

To cancel Transport Mode, shift Model X into Park.

NOTE: If Model X loses low voltage power after Transport Mode is enabled, Transport Mode cancels.

CAUTION: If the electrical system is not working, and you therefore cannot use the touchscreen to activate Transport Mode, use self-loading dollies or tire skates. Before doing so, always check the manufacturer's specifications and recommended loading capacity.

Pull onto the Flatbed Truck - With Tow Eye

1. Locate the tow eye.

2. Remove the tow eye cover by inserting a small flat screwdriver into the slot located along the top of the cover, then prying gently to release the cover from the top snap.



NOTE: Keep the tow eye cover in a safe place so you can replace it when towing is complete.

3. Fully insert the tow eye into the opening, then turn it counter-clockwise until securely fastened.



4. Attach the winch cable to the tow eye.
CAUTION: Before pulling, make sure the tow eye is securely fastened.
5. Activate Transport Mode by touching **Controls** > **Service** > **Towing**.
6. Pull Model X slowly onto the flatbed truck.



Pull onto the Flatbed Truck - Without Tow Eye

⚠ CAUTION: To avoid damage, only pull the vehicle onto a flatbed truck using a properly-installed tow eye. Using the chassis, frame, or suspension components to pull the vehicle can result in damage.

⚠ WARNING: If the vehicle is pulled onto the flatbed truck without a tow eye, all suspension fasteners should be checked for proper torque and all components should be visually inspected for damage prior to driving the vehicle again. If a fastener is loose, or if any damage is found, the affected component(s) should be replaced.

It is strongly recommended that you connect the winch to your vehicle's tow eye, as described previously. However, if a situation arises in which the tow eye is not available (lost, misplaced, etc.), the following instructions describe how to attach tow straps.

1. Attach the tow straps to each of the lower suspension arms underneath the front of the vehicle.



2. To protect the underbody from damage, place a protective barrier (such as a piece of wood) between the tow strap and underbody.
3. Activate Transport Mode by touching **Controls > Service > Towing**.
4. Pull Model X slowly onto the flatbed truck.

Secure the Tires

The vehicle's tires must be secured onto the truck using the eight-point tie-down method.

- Ensure any metal parts on the tie-down straps do not contact painted surfaces or the face of the wheels.
- Do not place tie-down straps over body panels or through the wheels.

⚠ CAUTION: Attaching the tie-down straps to the chassis, suspension or other parts of the vehicle's body may cause damage.





About this Owner Information

Document Applicability

For the latest and greatest information that is customized to your vehicle, view the Owner's Manual on your vehicle's touchscreen by touching **Controls** > **Service** > **Owner's Manual**. The information is specific to your vehicle depending on the features you purchased, vehicle configuration, market region and software version. In contrast, owner information that is provided by Tesla elsewhere is updated as necessary and may not contain information unique to your vehicle.

Information about new features is displayed on the touchscreen after a software update, and can be viewed at any time by touching **Controls** > **Software** > **Release Notes**. If the content in the Owner's Manual on how to use your vehicle conflicts with information in the Release Notes, the Release Notes take precedence.

Illustrations

The illustrations provided in this document are for demonstration purposes only. Depending on vehicle options, software version and market region, the information displayed on the touchscreen in your vehicle may appear slightly different.

Feature Availability

Some features are available only on some vehicle configurations and/or only in specific market regions. Options or features mentioned in the Owner's Manual does not guarantee they are available on your specific vehicle.

Errors or Inaccuracies

All specifications and descriptions are known to be accurate at time of publishing. However, because continuous improvement is a goal at Tesla, we reserve the right to make product modifications at any time. To communicate any inaccuracies or omissions, or to provide general feedback or suggestions regarding the quality of the Owner's Manual, send an email to ownersmanualfeedback@tesla.com.

Location of Components

Owner information may specify the location of a component as being on the left or right side of the vehicle. As shown, left (1) and right (2) represent the side of the vehicle when sitting inside.

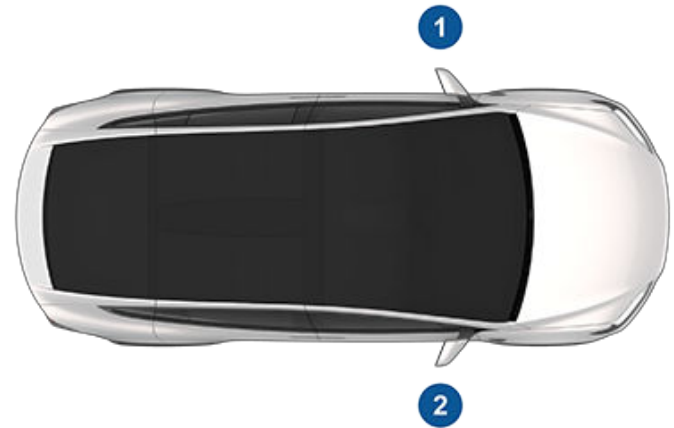

Copyrights and Trademarks

© 2012-2022 Tesla, Inc. All information in this document and all vehicle software is subject to copyright and other intellectual property rights of Tesla, Inc. and its licensors. This material may not be modified, reproduced or copied, in whole or in part, without the prior written permission of Tesla, Inc. and its licensors. Additional information is available upon request. Tesla uses software created by the Open Source community. Please visit Tesla's Open Source software website at <http://www.tesla.com/opensource>. HD Radio is a registered trademark of iBiquity Digital Corporation. The following are trademarks or registered trademarks of Tesla, Inc. in the United States and other countries:

TESLA

TESLA MOTORS

TESLA ROADSTER

MODEL S

MODEL X

MODEL 3

MODEL Y

T E S L A





All other trademarks contained in this document are the property of their respective owners and their use herein does not imply sponsorship or endorsement of their products or services. The unauthorized use of any trademark displayed in this document or on the vehicle is strictly prohibited.



Event Data Recorder (EDR)

Model X is equipped with an event data recorder (EDR). The main purpose of an EDR is to record, in certain crash or near crash-like situations, such as an air bag deployment or hitting a road obstacle, data to better understand how the vehicle's systems performed. The EDR is designed to record data related to vehicle dynamics and safety systems for a short period of time, typically 30 seconds or less. The EDR in Model X is designed to record data such as:

- How various systems in your vehicle were operating;
- Whether or not the driver and passenger safety belts were buckled/fastened;
- How far (if at all) the driver was depressing the accelerator and/or brake pedal; and,
- How fast the vehicle was traveling.

The data can help provide a better understanding of the circumstances in which crashes and injuries occur.

NOTE: EDR data is recorded by your vehicle only if a non-trivial crash situation occurs; no data is recorded by the EDR under normal driving conditions and no personal data (for example, name, gender, age, and crash location) is recorded. However, other parties, such as law enforcement, could combine the EDR data with the type of personally identifying data routinely acquired during a crash investigation.

To read data recorded by an EDR, special equipment is required, and access to the vehicle or the EDR is needed. In addition to the vehicle manufacturer, other parties, such as law enforcement, that have the special equipment, can read the information if they have access to the vehicle or the EDR. Tesla may also access the EDR remotely in some crash circumstances.

Vehicle Telematics

Model X is equipped with electronic modules that monitor and record data from various vehicle systems, including the motor, Autopilot components, Battery, braking and electrical systems. The electronic modules record information about various driving and vehicle conditions, including braking, acceleration, trip and other related information regarding your vehicle. These modules also record information about the vehicle's features such as charging events and status, the enabling/disabling of various systems, diagnostic trouble codes, VIN, speed, direction and location.

The data is stored by the vehicle and may be accessed, used and stored by Tesla service technicians during vehicle servicing or periodically transmitted to Tesla wirelessly through the vehicle's telematics system. This data may be used by Tesla for various purposes, including, but not limited to: providing you with Tesla telematics services; troubleshooting; evaluation of your vehicle's quality, functionality and performance; analysis

and research by Tesla and its partners for the improvement and design of our vehicles and systems; to defend Tesla; and as otherwise may be required by law. In servicing your vehicle, Tesla can potentially resolve issues remotely simply by reviewing your vehicle's data log.

Tesla's telematics system wirelessly transmits vehicle information to Tesla on a periodic basis. The data is used as previously described and helps ensure the proper maintenance of your vehicle. Additional Model X features may use your vehicle's telematics system and the information provided, including features such as charging reminders, software updates, and remote access to, and control of, various systems of your vehicle.

Tesla does not disclose the data recorded in your vehicle to any third party except when:

- An agreement or consent from the vehicle's owner (or the leasing company for a leased vehicle) is obtained.
- Officially requested by the police or other authorities.
- Used as a defense for Tesla.
- Ordered by a court of law.
- Used for research purposes without disclosing details of the vehicle owner or identification information.
- Disclosed to a Tesla affiliated company, including their successors or assigns, or our information systems and data management providers.

For additional information regarding how Tesla processes data collected from your vehicle, please review Tesla's Privacy Notice at <http://www.tesla.com/about/legal>.

Data Sharing

For quality assurance and to support the continuous improvement of advanced features such as Autopilot, your Model X may collect analytics, road segment, diagnostic, and vehicle usage data and send to Tesla for analysis. This analysis helps Tesla improve products and services by learning from the experience of billions of miles that Tesla vehicles have driven. Although Tesla shares this data with partners that contribute similar data, the collected information does not identify you personally and can be sent to Tesla only with your explicit consent. In order to protect your privacy, personal information is either not logged at all, is subject to privacy preserving techniques, or is removed from any reports before being sent to Tesla. You have control over what data you share by touching **Controls > Software > Data Sharing**.

For additional information regarding how Tesla processes data collected from your vehicle, please review Tesla's Privacy Notice at <http://www.tesla.com/about/legal>.



NOTE: Although Model X uses GPS in connection with driving and operation, as discussed in this owner's manual, Tesla does not record or store vehicle-specific GPS information, except the location where a crash occurred. Consequently, Tesla is unable to provide historical information about a vehicle's location (for example, Tesla is unable to tell you where Model X was parked/traveling at a particular date/time).

Quality Control

You might notice a few miles/km on the odometer when you take delivery of your Model X. This is a result of a comprehensive testing process that ensures the quality of your Model X.

The testing process includes extensive inspections during and after production. The final inspection takes place at Tesla and includes a road test conducted by a technician.

California Proposition 65

-  **WARNING:** Operating, servicing and maintaining a passenger vehicle or off-highway motor vehicle can expose you to chemicals including phthalates and lead, which are known to the State of California to cause cancer and birth defects or other reproductive harm. To minimize exposure, wear gloves or wash your hands frequently when servicing your vehicle. For more information go to: www.P65Warnings.ca.gov/passenger-vehicle.
-  **WARNING:** Certain components of this vehicle such as airbag modules and seat belt pretensioners may contain Perchlorate Material. Special handling may be required for service or vehicle end of life disposal. See www.dtsc.ca.gov/hazardouswaste/perchlorate.
-  **WARNING:** Battery posts, terminals, and related accessories contain lead and lead compounds. Wash hands after handling.



Contacting Tesla

For detailed information about your Model X, go to <http://www.tesla.com> and log on to your Tesla account or sign up to get an account.

If you have any questions or concerns about your Model X, in the United States, Canada or Puerto Rico, call 1-877-79TESLA (1-877-798-3752) and in Mexico, call 1-800-228-8145.

NOTE: You can also use voice commands to provide feedback to Tesla. Say "Report", "Feedback", or "Bug report" followed by brief comments. Model X takes a snapshot of its systems, including your current location, vehicle diagnostic data, and screen captures of the touchscreen and instrument panel. Tesla periodically reviews these notes and uses them to continue improving Model X.

Reporting Safety Defects - US

If you believe that Model X has a defect which could cause a crash or could cause injury or death, you should immediately inform the National Highway Traffic Safety Administration (NHTSA) in addition to notifying Tesla.

If NHTSA receives similar complaints, it may open an investigation. If it finds that a safety defect exists in a group of vehicles, it may order a recall and remedy campaign. However, NHTSA cannot become involved in individual problems between you, your dealer, or Tesla.

To contact NHTSA, you may call the Vehicle Safety Hotline toll-free at 1-888-327-4236 (TTY: 1-800-424-9153); go to www.safercar.gov; or write to: Administrator, National Highway Traffic Safety, 1200 New Jersey Avenue SE., Washington, DC 20590. You can also obtain other information about motor vehicle safety from www.safercar.gov.

Reporting Safety Defects - Canada

If you believe that your Model X has a defect which could cause a crash or could cause injury or death, you should immediately inform Transport Canada, in addition to notifying Tesla. To contact Transport Canada, call their toll-free number: 1-800-333-0510.



Key and Passive Unlocking System

FCC Certification

Model Number	Mfr	Frequency	Tested For
Key fob 1048598	Tesla	2.4 GHz	USA Canada Mexico Taiwan
WC1	Tesla	127.7KHz	Global

The devices listed above comply with Part 15 of the FCC rules, Industry Canada's license-exempt RSS Standard(s) and EU Directive 2014/53/EU.

1. This device may not cause harmful interference, and
2. This device must accept any interference received, including interference that may cause undesired operation.

Changes or modifications not expressly approved by Tesla could void your authority to operate the equipment.

La Operación de Este Equipo no está Sujeta a las dos following conditions:

1. Es Posible Que Este Equipo o Dispositivo no causar interferencia perjudicial.
2. Este Equipo o Dispositivo debe Aceptar Cualquier interferencia. Incluyendo La Que Pueda causar do Operación no Deseada.

Radiation Exposure Statement

The product complies with FCC/IC RF Exposure for Low Power Consumer Wireless Power Transfer. The RF exposure limit set forth for an uncontrolled environment is safe for the operations intended, as described in this manual. Compliance was demonstrated at a distance of 20 cm or greater between the human body and the device. If the function is available, the device's output power could be lowered.

IC Certification

The following device is used in vehicles in Canada:

- Key fob Model Number: 1048598 (2.4 GHz)
- Key fob Manufacturer: Tesla

Per IC 20098-1048598, this device complies with Industry Canada license-exempt RSS standard(s). Operation is subject to the following two conditions:

1. This device may not cause harmful interference, and
2. This device must accept any interference received, including interference that may cause undesired operation.

Le présent appareil est conforme aux CNR d'Industrie Canada applicables aux appareils radioexempts de licence. L'exploitation est autorisée aux deux conditions suivantes :

1. L'Appareilne doit pas produire de brouillage, et
2. L'Utilisateur de l'appareil doit accepter tout brouillage radioélectrique subi, même si le brouillage est susceptible d'en compromettre le fonctionnement.



Radio Regulatory Compliance

Cet équipement est conforme aux limites d'exposition aux rayonnements IC établies pour un environnement non contrôlé.

Déclaration d'exposition aux radiations:

Le produit est conforme à l'exposition RF IC pour le transfert de puissance sans fil de consommateurs de faible puissance. La limite d'exposition RF fixée pour un environnement non contrôlé est sans danger pour le fonctionnement prévu tel que décrit dans ce manuel. L'exposition RF supplémentaire que la conformité a été démontrée à 20cm et plus de séparation du corps de l'utilisateur ou de mettre l'appareil à la puissance de sortie inférieure si une telle fonction est disponible.

IC Certification

La Operación de Este Equipo no está Sujeta a las dos condiciones siguientes:

1. Es Posible Que Este Equipo o Dispositivo no causar interferenciaperjudicial.
2. Este Equipo o Dispositivo debe Aceptar Cualquier interferencia. Incluyendo La Que Pueda causar do Operación no Deseada.

Central Body Controller

FCC Certification

Model Number	Mfr	MHz / GHz	Tested For
Central Body Controller 1031503	Tesla	315 / 2.4	USA Canada

Per FCC ID 2AEIM-1031503, the devices listed above comply with Part 15 of the FCC rules. Operation is subject to the following two conditions:

1. This device may not cause harmful interference, and
2. This device must accept any interference received, including interference that may cause undesired operation.

Changes or modifications not expressly approved by Tesla could void your authority to operate the equipment.

IC Certification

The following device is used in vehicles in Canada:

- Central Body Controller Model Number: 1031503 (315 MHz / 2.4 GHz)
- Central Body Controller Manufacturer: Tesla

Per IC 20098-1031503, this device complies with Industry Canada license-exempt RSS standard(s). Operation is subject to the following two conditions:

1. This device may not cause harmful interference, and
2. This device must accept any interference received, including interference that may cause undesired operation.

Integral Component Only

The Central Body Controller is an integral part of the vehicle that is installed and secured around other interior trim components. The Central Body Controller is designed and intended for use only as an integral component and cannot be sold and/or marketed separately.



Tire Pressure Monitoring System

FCC IDs: TZSTPMS201, Z9F-201FS43X

IC ID: 11852A-201FS4X

The tire pressure monitoring system (TPMS) complies with Part 15 of the FCC rules and RSS-210 of Innovation, Science and Economic Development Canada. Operation is subject to the following two conditions:

1. This device may not cause harmful interference, and
2. This device must accept any interference received, including interference that may cause undesired operation.

Changes or modifications not expressly approved by Tesla could void your authority to operate the equipment.

HomeLink

This device complies with Part 15 of the FCC rules, RSS-210 Industry Canada, and with EU Directive 2014/53/EU.

Operation is subject to the following conditions:

- This device may not cause harmful interference.
- This device must accept any interference received, including interference that may cause undesired operation.

Any changes or modifications to the device not expressly approved by the manufacturer or Tesla could void your authority to operate the equipment.

Radio Frequency Information

This equipment has been tested and found to comply with the limits for a Class B digital device, pursuant to Part 15 of the FCC Rules. These limits are designed to provide reasonable protection against harmful interference in a residential installation. This equipment generates, uses and can radiate radio frequency energy and, if not installed and used in accordance with the instructions, may cause harmful interference to radio communications. However, there is no guarantee that interference will not occur in a particular installation. If this equipment does cause harmful interference to radio or television reception, which can be determined by turning the equipment off and on, try to correct the interference by one or more of the following measures:

- Reorient or relocate the receiving antenna.
- Increase the separation between the equipment and receiver.
- Connect the equipment into an outlet on a circuit different from that to which the receiver is connected.
- Consult the dealer or an experienced radio/TV technician for help.

(APP_w207)

Autosteer temporarily unavailable

Autosteer is currently unavailable. This could be a temporary condition due to external conditions that include:

- Missing or faded lane markers
- Narrow or winding roads
- Poor visibility due to rain, snow, fog, or other weather conditions
- Extremely hot or cold temperatures
- Bright light due to other vehicle headlights, direct sunlight, or other light sources

If the alert is caused by a temporary factor like these, no action or service is typically needed. Continue to your destination. The alert will clear and Autosteer will be available once the condition is no longer present.

Please note that the minimum speed to initiate Autosteer when there is no vehicle detected ahead of you and while driving on a road with visible lane markings is 18 mph (30 km/h), unless certain vehicle and environmental conditions are met. If a vehicle is detected ahead of you:

- You can initiate Autosteer at any speed under 90 mph (150 km/h).
- You can even initiate Autosteer when stationary, provided the other vehicle is at least 5 feet (150 cm) in front of you.

This alert will be present if you have temporarily exceeded 90 mph (150 km/h) with Autosteer active, and Autosteer will not be available for the rest of your current drive.

NOTE: If this alert becomes active while you are driving in Germany, Autosteer should again be available once your vehicle is traveling below 90 mph (150 km/h).

If Autosteer is not available by the time you reach your destination, and remains unavailable during your next planned drive, the problem might be one of these issues:

- Damage or obstruction caused by mud, ice, snow, or other environmental factors
- Obstruction caused by an object mounted on the vehicle, like a bike rack
- Obstructions caused by adding paint or adhesive products like wraps, stickers, or rubber coatings to your vehicle
- A damaged or misaligned bumper

The solution might be as simple as washing your vehicle. If you do not find any obvious obstructions or you find damage to the vehicle, schedule service at your convenience. Your vehicle is OK to drive in the meantime.

For more information, see [Autosteer on page 101](#).

(APP_w218)

Autosteer speed limit exceeded

Take control of steering wheel

Autosteer is unavailable because your vehicle has exceeded the maximum speed limit for this driver assistance feature. Autosteer is only available at speeds up to 90 mph (150 km/h).

Take immediate control of the steering wheel and maintain control until you reach your destination. Your vehicle is OK to drive.

In most cases, Autosteer will not be available for the rest of your current drive. To reset it, you will need to bring the vehicle to a complete stop and shift into Park. When you shift into Drive to travel to your next destination, Autosteer should again be available.



Please note that the minimum speed to initiate Autosteer when there is no vehicle detected ahead of you and while driving on a road with visible lane markings is 18 mph (30 km/h), unless certain vehicle and environmental conditions are met.

If a vehicle is detected ahead of you:

- You can initiate Autosteer at any speed under 90 mph (150 km/h).
- You can even initiate Autosteer when stationary, provided the other vehicle is at least 5 feet (150 cm) in front of you.

NOTE: If this alert becomes active while you are driving in Germany, Autosteer should again be available once your vehicle is traveling below 90 mph (150 km/h).

If Autosteer is not available during your next drive, and remains unavailable throughout subsequent drives, schedule service at your convenience. Your vehicle is OK to drive in the meantime.

For more information, see [Autosteer on page 101](#).

(APP_w221)

Cruise control unavailable Reduced front radar visibility

Traffic-Aware Cruise Control and Autosteer are unavailable because the radar located in the front bumper area of your vehicle has no or low visibility. Continue to your destination. Your vehicle is OK to drive.

Traffic-Aware Cruise Control and Autosteer will remain unavailable as long as the radar lacks adequate visibility. This could be a temporary obstruction caused by factors like snow, ice, dirt, or mud. If the alert is caused by a temporary factor like these, no action might be needed: the condition might clear during your drive.

If the alert persists throughout your drive, examine the front bumper before your next planned drive and attempt to clear any obstruction.

- See the [About Autopilot on page 93](#) sections “How It Works” and “Cleaning Cameras and Sensors” for more on the radar location and care needed if clearing dirt / debris from that area of the vehicle.
- See [Cleaning on page 190](#) for general cleaning tips and cautions.

Once the radar regains adequate visibility, the alert will clear and both Traffic-Aware Cruise Control and Autosteer should again be available.

If this alert persists throughout subsequent drives but no obstruction is visible on the front bumper where the radar is located, schedule service at your earliest convenience. Your vehicle is OK to drive in the meantime.

(APP_w222)

Cruise control unavailable Reduced front camera visibility

Traffic-Aware Cruise Control and Autosteer are unavailable because one or more of the front cameras in your vehicle is blocked or blinded by external conditions. Continue to your destination. Your vehicle is OK to drive.

Traffic-Aware Cruise Control and Autosteer will remain unavailable while a front camera lacks adequate visibility. Cameras can be blocked or blinded due to many factors that include:

- Dirt or debris on the camera surface
- Environmental conditions like rain, fog, snow, or dew
- Bright sunlight or glare from another light source
- Condensation (water droplets or mist) on the camera surface

Troubleshooting Alerts

This is often a temporary issue that will clear up when condensation evaporates or a particular environmental condition is no longer present.

If the alert does not clear by the end of your drive, inspect and clean the front camera area at the top center of the windshield before your next planned drive. Check the camera surface for condensation, dirt, or other debris and attempt to clear any obstruction. See the [About Autopilot on page 93](#) sections “How It Works” and “Cleaning Cameras and Sensors” for more on front camera location and tips for careful cleaning.

Although condensation on the inside of the front camera enclosure cannot be wiped clean, you can usually clear it quicker by following these steps:

1. Pre-condition the cabin with the temperature set to High and A/C turned ON.
2. Turn on the front windshield defroster.

Once all front cameras regain adequate visibility, the alert will clear and both Traffic-Aware Cruise Control and Autosteer should again be available.

If this alert persists throughout subsequent drives but no front camera obstruction is visible, schedule service at your earliest convenience. Your vehicle is OK to drive in the meantime.

(APP_w224)

Cruise control unavailable Continue driving to allow cameras to calibrate

Traffic-Aware Cruise Control and Autosteer are unavailable because the cameras on your vehicle are not fully calibrated. Continue to your destination. Your vehicle is OK to drive.

Traffic-Aware Cruise Control and Autosteer will remain unavailable until camera calibration is complete.

Your vehicle must maneuver with great precision when features like Traffic-Aware Cruise Control and Autosteer are active. Before these features can be used for the first time, the cameras must complete an initial self-calibration. Occasionally, one or more cameras can become uncalibrated.

Calibration typically completes after your vehicle has driven 20–25 miles (32–40 km), but the distance varies depending on road and environmental conditions. For example, driving on a straight road with highly visible lane markings helps the cameras calibrate quicker.

See [Drive to Calibrate Cameras on page 94](#) for more information.

When calibration is complete, Traffic-Aware Cruise Control and Autosteer should be available.

If the alert persists and camera calibration has not completed after your vehicle has driven 100 miles (160 km) or more, or Traffic-Aware Cruise Control and Autosteer remain unavailable despite successful camera calibration, contact Tesla Service at your earliest convenience. Your vehicle is OK to drive in the meantime.

(APP_w304)

Camera blocked or blinded Clean camera or wait for it to regain visibility

One or more of the vehicle cameras is blocked or blinded due to external conditions. When the cameras cannot provide accurate visual information, some or all Autopilot features may be temporarily unavailable.

Cameras can be blocked or blinded due to many factors, including:

- Dirt or debris on the camera surface
- Environmental conditions like rain, fog, snow, or dew
- Bright sunlight or glare from another light source
- Condensation (water droplets or mist) on the camera surface



Continue to your destination. Your vehicle is OK to drive.

This is often a temporary issue that will be resolved when condensation evaporates or a particular environmental condition is no longer present.

If the alert does not clear by the time you reach your destination, check camera surfaces for condensation, dirt, or other debris.

For camera locations, see [About Autopilot on page 93](#).

Clean the cameras as necessary before your next planned drive. For recommended cleaning procedures, see [Cleaning Cameras and Sensors on page 95](#).

If you continue to see this alert after cleaning the cameras, check the inside surfaces of the door pillar camera enclosures for condensation.

Although condensation inside the camera enclosures cannot be wiped clean, you can usually clear it faster by following these steps:

1. Pre-condition the cabin with the temperature set to High and A/C turned ON.
2. Turn on the front windshield defroster.
3. Direct the air vents toward the door pillar cameras.

For more information on clearing condensation from camera enclosures, see [Cleaning Cameras and Sensors on page 95](#).

If the alert does not clear by the end of your next planned drive, despite cleaning the indicated camera(s) and following recommended steps to clear condensation, schedule service at your next convenient opportunity. Your vehicle is OK to drive in the meantime.

(BMS_u030)

Charging adapter has electric arc flash hazard Use different charging equipment

Charging is unavailable because your vehicle has detected an electric arc flash hazard in the third-party charging adapter used to connect a Combined Charging System (CCS) charge handle to your vehicle's charge port.

An electric arc flash can occur if you attempt to unplug **while actively charging with the third-party charging adapter**, and an electric arc flash can cause serious bodily injury and/or property damage.

Follow the steps below to mitigate this risk:

1. Make sure charging is completely stopped.
 - a. Use your vehicle touchscreen to confirm charging has stopped, or to stop charging if necessary.
 - b. Use the charging station display and controls to confirm charging has stopped, or to end any active charging session.
2. Make sure no flashing green or blue light (LED) is visible on your vehicle's charge port.
3. Unplug the charging adapter from your vehicle's charge port.
4. Confirm again that the charging station indicates no active charging session.
5. Unplug the charging adapter from the charge handle.

Use different charging equipment to charge your vehicle. For more information on charging, see [Charging Instructions on page 176](#).

You can also try charging your vehicle using a Tesla Supercharger or Destination Charging location, all of which can be located through the map on your vehicle's touchscreen display. See [Maps and Navigation on page 143](#) for more details. Additional third-party charging stations may also be available in your area to help you to pinpoint the issue.

(CC_f001)

Unable to charge - Insufficient grounding Proper wiring or outlet grounding must be verified

What this alert means:

No ground connection detected in the Wall Connector.

What to do:

Have the Wall Connector inspected by an electrician to make sure it is properly grounded. Your electrician should ensure there is proper grounding at your circuit breaker or power distribution box and also ensure that appropriate connections are made to the Wall Connector.

For more information, see the [installation guide](#) for your Wall Connector.

(CC_f002)

Unable to charge - Insufficient grounding Disconnect and retry or use different equipment

What this alert means:

Ground fault. Current is leaking through an unsafe path. Possible Line to ground or Neutral to ground fault.

What to do:

Try charging again by disconnecting the Wall Connector from the vehicle and reconnecting. If the issue persists, turn OFF the circuit breaker servicing the Wall Connector, wait 10 seconds, turn the circuit breaker ON again, then try reconnecting the Wall Connector to the vehicle. If the issue persists, consult your electrician or contact Tesla.

For more information, see the [installation guide](#) for your Wall Connector.

(CC_f003)

Unable to charge - Wall Connector GFCI tripped Disconnect and retry or use different equipment

What this alert means:

Ground fault. Current is leaking through an unsafe path. Possible Line to ground or Neutral to ground fault.

What to do:

Try charging again by disconnecting the Wall Connector from the vehicle and reconnecting. If the issue persists, turn OFF the circuit breaker servicing the Wall Connector, wait 10 seconds, turn the circuit breaker ON again, then try reconnecting the Wall Connector to the vehicle. If the issue persists, consult your electrician or contact Tesla.

For more information, see the [installation guide](#) for your Wall Connector.

(CC_f004)

Unable to charge - Wall Connector issue Wall Connector needs service

What this alert means:

Wall Connector hardware issue. Possible issues include:

1. Contactor not working



2. Self-test of internal ground fault monitoring circuit failed
3. Thermal sensor disconnected
4. Other hardware component issues

What to do:

An internal issue was detected by the Wall Connector.

1. Try charging again by disconnecting the Wall Connector from the vehicle and reconnecting.
2. If the issue persists, turn OFF the circuit breaker for the Wall Connector, wait 10 seconds, and turn the circuit breaker ON again. Then try reconnecting the Wall Connector to the vehicle.
3. If the issue persists, have an electrician make sure all wires are properly connected and torqued according to the instructions in the Wall Connector Installation Manual.
4. Once your electrician has completed all work and restored power to the Wall Connector, try charging again by reconnecting the Wall Connector to the vehicle.
5. If the issue persists, the Wall Connector requires service.

For more information, see the [installation guide](#) for your Wall Connector.

(CC_f005)

**Unable to charge - Wall Connector GFCI tripped
Disconnect and retry or use different equipment**

What this alert means:

Ground fault. Current is leaking through an unsafe path. Possible Line to ground or Neutral to ground fault.

What to do:

Try charging again by disconnecting the Wall Connector from the vehicle and reconnecting. If the issue persists, turn OFF the circuit breaker servicing the Wall Connector, wait 10 seconds, turn the circuit breaker ON again, then try reconnecting the Wall Connector to the vehicle. If the issue persists, consult your electrician or contact Tesla.

For more information, see the [installation guide](#) for your Wall Connector.

(CC_f006)

**Unable to charge - Wall Connector overcurrent
Disconnect and retry or use different equipment**

What this alert means:

Over current protection.

What to do:

Reduce the vehicle's charge current setting. If the issue persists, service is required.

For more information, see the [installation guide](#) for your Wall Connector.

(CC_f007)

**Unable to charge - Input voltage too high
Voltage must be within Wall Connector rating**

What this alert means:

Over or under voltage protection.

What to do:

Consult your electrician to ensure appropriate voltage on the circuit breaker that services the Wall Connector.

For more information, see the [installation guide](#) for your Wall Connector.

(CC_f008)**Unable to charge - Input voltage too low
Voltage must be within Wall Connector rating****What this alert means:**

Over or under voltage protection.

What to do:

Consult your electrician to ensure appropriate voltage on the circuit breaker that services the Wall Connector.

For more information, see the [installation guide](#) for your Wall Connector.

(CC_f009)**Unable to charge - Input wired incorrectly
Input wiring to Wall Connector must be corrected****What this alert means:**

Input miswired: possibly Line and Neutral are swapped.

What to do:

The wiring between the wall power and the Wall Connector has been incorrectly installed. Consult your electrician.

For more information, see the [installation guide](#) for your Wall Connector.

(CC_f010)**Unable to charge - Wall Connector issue
Wall Connector needs service****What this alert means:**

Wall Connector hardware issue. Possible issues include:

1. Contactor not working
2. Self-test of internal ground fault monitoring circuit failed
3. Thermal sensor disconnected
4. Other hardware component issues

What to do:

An internal issue was detected by the Wall Connector.

1. Try charging again by disconnecting the Wall Connector from the vehicle and reconnecting.
2. If the issue persists, turn OFF the circuit breaker for the Wall Connector, wait 10 seconds, and turn the circuit breaker ON again. Then try reconnecting the Wall Connector to the vehicle.
3. If the issue persists, have an electrician make sure all wires are properly connected and torqued according to the instructions in the Wall Connector Installation Manual.



4. Once your electrician has completed all work and restored power to the Wall Connector, try charging again by reconnecting the Wall Connector to the vehicle.
5. If the issue persists, the Wall Connector requires service.

For more information, see the [installation guide](#) for your Wall Connector.

(CC_f011)

Unable to charge - Wall Connector too hot Let Wall Connector cool and try again

What this alert means:

Over temperature protection (latchoff).

What to do:

Make sure the Wall Connector is not covered by anything and that there is no heat source nearby. If the problem persists in normal ambient temperatures (under 100°F or 38°C) , service is required.

For more information, see the [installation guide](#) for your Wall Connector.

(CC_f012)

Unable to charge - Wall connection too hot Outlet or Wall Connector wiring must be checked

High temperature detected by Wall Connector alerts indicate the building connection to the Wall Connector is getting too warm, so charging has stopped to protect the wiring and Wall Connector.

This is not typically an issue with your vehicle or your Wall Connector, but rather an issue with the building wiring. This may be caused by a loose building wiring connection to the Wall Connector and can be fixed quickly by an electrician.

To regain normal charge operation, try the following steps.

If the Wall Connector is plugged into a wall outlet, make sure:

- The plug is fully inserted into the receptacle / outlet
- The plug / outlet area is not blocked or covered by anything
- There is no heat source nearby

If the issue persists or the Wall Connector is hard-wired, contact an electrician to inspect the building wiring connection to the Wall Connector. They should make sure that all wires are properly connected and torqued according to the installation guide for the Wall Connector.

For more information, see the [installation guide](#) for your Wall Connector.

(CC_f013)

Unable to charge - Charge handle too hot Check charge handle or charge port for debris

What this alert means:

Over temperature protection (latchoff).

What to do:



Troubleshooting Alerts

Make sure the connector is fully inserted into the charge inlet in the vehicle's charging port, is not covered by anything, and there is no heat source nearby. If the issue persists in normal ambient temperatures (under 100°F or 38°C), service is required.

For more information, see the [installation guide](#) for your Wall Connector.

(CC_f014)

Unable to charge - Wall Connector issue Wall Connector needs service

What this alert means:

Wall Connector hardware issue. Possible issues include:

1. Contactor not working
2. Self-test of internal ground fault monitoring circuit failed
3. Thermal sensor disconnected
4. Other hardware component issues

What to do:

An internal issue was detected by the Wall Connector.

1. Try charging again by disconnecting the Wall Connector from the vehicle and reconnecting.
2. If the issue persists, turn OFF the circuit breaker for the Wall Connector, wait 10 seconds, and turn the circuit breaker ON again. Then try reconnecting the Wall Connector to the vehicle.
3. If the issue persists, have an electrician make sure all wires are properly connected and torqued according to the instructions in the Wall Connector Installation Manual.
4. Once your electrician has completed all work and restored power to the Wall Connector, try charging again by reconnecting the Wall Connector to the vehicle.
5. If the issue persists, the Wall Connector requires service.

For more information, see the [installation guide](#) for your Wall Connector.

(CC_f015)

Unable to charge - Vehicle connection issue Insert charge handle fully into charge port

What this alert means:

A communication error occurred between the Wall Connector and the vehicle.

What to do:

Try charging again by disconnecting the Wall Connector from the vehicle and reconnecting.

1. If the issue persists, turn OFF the circuit breaker servicing the Wall Connector, wait 10 seconds, turn the circuit breaker ON again, then try reconnecting the Wall Connector to the vehicle.
2. If the issue persists and other charging equipment is available, plug the vehicle into another Wall Connector or a Mobile Connector to determine if the vehicle is able to communicate with other charging equipment.
3. If the issue persists, service is required.

For more information, see the [installation guide](#) for your Wall Connector.



(CC_f016)

Unable to charge - Vehicle connection issue Insert charge handle fully into charge port

What this alert means:

A communication error occurred between the Wall Connector and the vehicle.

What to do:

Try charging again by disconnecting the Wall Connector from the vehicle and reconnecting.

1. If the issue persists, turn OFF the circuit breaker servicing the Wall Connector, wait 10 seconds, turn the circuit breaker ON again, then try reconnecting the Wall Connector to the vehicle.
2. If the issue persists and other charging equipment is available, plug the vehicle into another Wall Connector or a Mobile Connector to determine if the vehicle is able to communicate with other charging equipment.
3. If the issue persists, service is required.

For more information, see the [installation guide](#) for your Wall Connector.

(CC_f017)

Unable to charge - Vehicle connection issue Insert charge handle fully into charge port

What this alert means:

A communication error occurred between the Wall Connector and the vehicle.

What to do:

Try charging again by disconnecting the Wall Connector from the vehicle and reconnecting.

1. If the issue persists, turn OFF the circuit breaker servicing the Wall Connector, wait 10 seconds, turn the circuit breaker ON again, then try reconnecting the Wall Connector to the vehicle.
2. If the issue persists and other charging equipment is available, plug the vehicle into another Wall Connector or a Mobile Connector to determine if the vehicle is able to communicate with other charging equipment.
3. If the issue persists, service is required.

For more information, see the [installation guide](#) for your Wall Connector.

(CC_f018)

Unable to charge - Vehicle connection issue Insert charge handle fully into charge port

What this alert means:

A communication error occurred between the Wall Connector and the vehicle.

What to do:

Try charging again by disconnecting the Wall Connector from the vehicle and reconnecting.

1. If the issue persists, turn OFF the circuit breaker servicing the Wall Connector, wait 10 seconds, turn the circuit breaker ON again, then try reconnecting the Wall Connector to the vehicle.
2. If the issue persists and other charging equipment is available, plug the vehicle into another Wall Connector or a Mobile Connector to determine if the vehicle is able to communicate with other charging equipment.

3. If the issue persists, service is required.

For more information, see the [installation guide](#) for your Wall Connector.

(CC_f019)

Unable to charge - Vehicle connection issue Insert charge handle fully into charge port

What this alert means:

A communication error occurred between the Wall Connector and the vehicle.

What to do:

Try charging again by disconnecting the Wall Connector from the vehicle and reconnecting.

1. If the issue persists, turn OFF the circuit breaker servicing the Wall Connector, wait 10 seconds, turn the circuit breaker ON again, then try reconnecting the Wall Connector to the vehicle.
2. If the issue persists and other charging equipment is available, plug the vehicle into another Wall Connector or a Mobile Connector to determine if the vehicle is able to communicate with other charging equipment.
3. If the issue persists, service is required.

For more information, see the [installation guide](#) for your Wall Connector.

(CC_f020)

Unable to charge - Wall Connector issue Wall Connector needs service

What this alert means:

Wall Connector hardware issue. Possible issues include:

1. Contactor not working
2. Self-test of internal ground fault monitoring circuit failed
3. Thermal sensor disconnected
4. Other hardware component issues

What to do:

An internal issue was detected by the Wall Connector.

1. Try charging again by disconnecting the Wall Connector from the vehicle and reconnecting.
2. If the issue persists, turn OFF the circuit breaker for the Wall Connector, wait 10 seconds, and turn the circuit breaker ON again. Then try reconnecting the Wall Connector to the vehicle.
3. If the issue persists, have an electrician make sure all wires are properly connected and torqued according to the instructions in the Wall Connector Installation Manual.
4. Once your electrician has completed all work and restored power to the Wall Connector, try charging again by reconnecting the Wall Connector to the vehicle.
5. If the issue persists, the Wall Connector requires service.

For more information, see the [installation guide](#) for your Wall Connector.



(CC_f021)

Unable to charge - No primary Wall Connector Check that primary unit is powered and available

What this alert means:

Load sharing (circuit breaker sharing) network: Need one (and only one) Wall Connector set as primary.

What to do:

Only one Wall Connector can be set to a primary configuration. Have your electrician confirm:

1. Only one of the Wall Connectors is set as primary.
2. All other Wall Connectors linked to the primary unit are set to paired position (position F).

For more information, see the [installation guide](#) for your Wall Connector.

(CC_f022)

Unable to charge - More than 1 primary unit Ensure only 1 Wall Connector is set as primary

What this alert means:

Load sharing (circuit breaker sharing) network: Need one (and only one) Wall Connector set as primary.

What to do:

Only one Wall Connector can be set to a primary configuration. Have your electrician confirm:

1. Only one of the Wall Connectors is set as primary.
2. All other Wall Connectors linked to the primary unit are set to paired position (position F).

For more information, see the [installation guide](#) for your Wall Connector.

(CC_f023)

Unable to charge - Too many Wall Connectors Ensure no more than 3 units paired with primary

What this alert means:

Load sharing (circuit breaker sharing) network: More than three Wall Connectors are paired with the same primary unit.

What to do:

Consult your electrician to have one or more paired Wall Connectors moved to a different circuit and disconnected (unpaired) from this load sharing (circuit breaker sharing) network.

For more information, see the [installation guide](#) for your Wall Connector.

(CC_f024)

Unable to charge - Low Wall Connector current Primary unit current setting must be increased

What this alert means:

Incorrect rotary switch setting.

What to do:

Have your electrician adjust the Wall Connector's internal rotary switch to a valid operating current setting. They should first make sure there is no power to the Wall Connector. The correlation between switch setting and current should be printed on the inside of the Wall Connector. Your electrician should also refer to the Set the Operating Current section in the Wall Connector Installation Manual.

If the Wall Connector is set up for load sharing (circuit breaker sharing) and paired with other Wall Connectors, the rotary switch of the primary unit must be set to an operating current setting that allows each paired Wall Connector to receive at least 6A of charge current.

Example: Three Wall Connectors are paired for load sharing. The primary unit needs to be set to a current of at least $3 * 6A = 18A$ or greater.

For more information, see the [installation guide](#) for your Wall Connector.

(CC_f025) Unable to charge - Wall Connector issue Wall Connector needs service

What this alert means:

Wall Connector hardware issue. Possible issues include:

1. Contactor not working
2. Self-test of internal ground fault monitoring circuit failed
3. Thermal sensor disconnected
4. Other hardware component issues

What to do:

An internal issue was detected by the Wall Connector.

1. Try charging again by disconnecting the Wall Connector from the vehicle and reconnecting.
2. If the issue persists, turn OFF the circuit breaker for the Wall Connector, wait 10 seconds, and turn the circuit breaker ON again. Then try reconnecting the Wall Connector to the vehicle.
3. If the issue persists, have an electrician make sure all wires are properly connected and torqued according to the instructions in the Wall Connector Installation Manual.
4. Once your electrician has completed all work and restored power to the Wall Connector, try charging again by reconnecting the Wall Connector to the vehicle.
5. If the issue persists, the Wall Connector requires service.

For more information, see the [installation guide](#) for your Wall Connector.

(CC_f026) Unable to charge - Wall Connector issue Wall Connector needs service

What this alert means:

Wall Connector hardware issue. Possible issues include:

1. Contactor not working
2. Self-test of internal ground fault monitoring circuit failed
3. Thermal sensor disconnected



4. Other hardware component issues

What to do:

An internal issue was detected by the Wall Connector.

1. Try charging again by disconnecting the Wall Connector from the vehicle and reconnecting.
2. If the issue persists, turn OFF the circuit breaker for the Wall Connector, wait 10 seconds, and turn the circuit breaker ON again. Then try reconnecting the Wall Connector to the vehicle.
3. If the issue persists, have an electrician make sure all wires are properly connected and torqued according to the instructions in the Wall Connector Installation Manual.
4. Once your electrician has completed all work and restored power to the Wall Connector, try charging again by reconnecting the Wall Connector to the vehicle.
5. If the issue persists, the Wall Connector requires service.

For more information, see the [installation guide](#) for your Wall Connector.

(CC_f027)

Unable to charge - Wall Connector issue Wall Connector needs service

What this alert means:

Wall Connector hardware issue. Possible issues include:

1. Contactor not working
2. Self-test of internal ground fault monitoring circuit failed
3. Thermal sensor disconnected
4. Other hardware component issues

What to do:

An internal issue was detected by the Wall Connector.

1. Try charging again by disconnecting the Wall Connector from the vehicle and reconnecting.
2. If the issue persists, turn OFF the circuit breaker for the Wall Connector, wait 10 seconds, and turn the circuit breaker ON again. Then try reconnecting the Wall Connector to the vehicle.
3. If the issue persists, have an electrician make sure all wires are properly connected and torqued according to the instructions in the Wall Connector Installation Manual.
4. Once your electrician has completed all work and restored power to the Wall Connector, try charging again by reconnecting the Wall Connector to the vehicle.
5. If the issue persists, the Wall Connector requires service.

For more information, see the [installation guide](#) for your Wall Connector.

(CC_f028)

Unable to charge - Incorrect switch setting Wall Connector rotary switch must be adjusted

What this alert means:

Incorrect rotary switch setting.

What to do:



Troubleshooting Alerts

Have your electrician adjust the Wall Connector's internal rotary switch to a valid operating current setting. They should first make sure there is no power to the Wall Connector. The correlation between switch setting and current should be printed on the inside of the Wall Connector. Your electrician should also refer to the Set the Operating Current section in the Wall Connector Installation Manual.

If the Wall Connector is set up for load sharing (circuit breaker sharing) and paired with other Wall Connectors, the rotary switch of the primary unit must be set to an operating current setting that allows each paired Wall Connector to receive at least 6A of charge current.

Example: Three Wall Connectors are paired for load sharing. The primary unit needs to be set to a current of at least $3 * 6A = 18A$ or greater.

For more information, see the [installation guide](#) for your Wall Connector.

(CC_f029)

Unable to charge - Vehicle connection issue Insert charge handle fully into charge port

What this alert means:

A communication error occurred between the Wall Connector and the vehicle.

What to do:

Try charging again by disconnecting the Wall Connector from the vehicle and reconnecting.

1. If the issue persists, turn OFF the circuit breaker servicing the Wall Connector, wait 10 seconds, turn the circuit breaker ON again, then try reconnecting the Wall Connector to the vehicle.
2. If the issue persists and other charging equipment is available, plug the vehicle into another Wall Connector or a Mobile Connector to determine if the vehicle is able to communicate with other charging equipment.
3. If the issue persists, service is required.

For more information, see the [installation guide](#) for your Wall Connector.

(CC_f030)

Unable to charge - Primary / paired unit mismatch Wall Connector current ratings must match

What this alert means:

Load sharing (circuit breaker sharing) network: The paired Wall Connectors have different maximum current capabilities.

What to do:

Only Wall Connectors with the same maximum current capabilities can be paired in a load sharing (circuit breaker sharing) network. Have your electrician inspect the type labels on the Wall Connectors and make sure the current capabilities match. It is further recommended that your electrician only pair Wall Connectors with the same part number, as an easy way to make sure paired units are compatible.

For more information, see the [installation guide](#) for your Wall Connector.

(CC_f041)

Charge rate reduced - Wall connection hot Outlet or Wall Connector wiring must be checked

High temperature detected by Wall Connector alerts indicate the building connection to the Wall Connector is getting too warm, so charging has been slowed to protect the wiring and Wall Connector.



This is not typically an issue with your vehicle or your Wall Connector, but rather an issue with the building wiring. This may be caused by a loose building wiring connection to the Wall Connector and can be fixed quickly by an electrician.

To regain normal charge speed, contact an electrician to inspect the building wiring connection to the Wall Connector. They should make sure that all wires are properly connected and torqued according to the installation guide for the Wall Connector.

For more information, see the [installation guide](#) for your Wall Connector.

(CHG_f035)

Charging equipment communication error Try again or try different equipment

Your vehicle is unable to charge because it cannot communicate effectively with the external charging equipment. It cannot sense a valid control pilot signal coming from the charging equipment.

First, confirm the lack of effective communication is caused by the external charging equipment rather than an issue with your vehicle. This is usually the case.

Try charging the vehicle using different external charging equipment (including charge cable, charging station, or charging stall).

- If the vehicle begins charging, the issue was likely with the equipment.
- If the vehicle still does not charge, the issue may be with the vehicle.

If the issue is suspected to be with the vehicle, inspect the charge port inlet and the charge cable connector for any obstructions (use a flashlight as necessary). Debris, moisture, and/or foreign objects present in the charge port inlet or the charge cable connector can prevent the charge port from properly communicating with the charging equipment.

It is recommended that any debris / foreign objects be removed and any moisture be allowed to dry. Afterward, try re-inserting the cable into the charge port. Charging should now be possible.

As this alert is usually specific to external charging equipment and power sources, and it does not typically indicate an issue with your vehicle that can be resolved by scheduling service, it is recommended that you:

- Try charging with multiple, different types of charging equipment.
- Make sure any charge port inlet obstruction has been removed.

You can also try charging your vehicle using a Tesla Supercharger or Destination Charging location, all of which can be located through the map on your vehicle's touchscreen display. See [Maps and Navigation on page 143](#) for more details. Additional third-party charging stations may also be available in your area to help you to pinpoint the issue.

For more information on troubleshooting Mobile Connector or Wall Connector status lights, refer to the product's Owner's Manual at [Charging & Adapter Product Guides](#). If using other external charging equipment, refer to the manufacturer's provided documentation for troubleshooting tips.

For more information on charging, see [Charging Instructions on page 176](#).

(CHG_f083)

Cannot charge - Poor grid power quality possible Retry / Try other charge location or Supercharging

Charging has stopped due to a condition that prevents your vehicle from charging with AC power. DC fast charging / Supercharging should still function as expected.

This condition could occur due to power supply disturbances caused by the external charging equipment or by the electrical power grid. In some cases, this condition can even result from turning on nearby electric devices that draw a lot of power.

Troubleshooting Alerts

If these possible causes can be ruled out, then a condition with your vehicle itself may also be affecting AC charging.

This alert is often accompanied by other alerts that can help you identify and troubleshoot the condition. Start by investigating any other displayed alerts that relate to charging.

Further troubleshooting tips based on equipment type:

- If using a Mobile Connector, try charging your vehicle with a different wall outlet.
 - If your vehicle starts to charge and continues to charge as expected, the issue was likely with the original wall outlet. It is recommended that you contact an electrician to inspect the building wiring connection to that outlet.
 - If your vehicle still does not start to charge, or does not continue to charge as expected, the issue may be with the Mobile Connector or the electrical grid.
- If using a Wall Connector, try charging your vehicle with different charging equipment like a Mobile Connector powered by a separate wall outlet.
 - If your vehicle starts to charge and continues to charge as expected, the issue was likely with the Wall Connector. Contact an electrician to inspect the building wiring connection to the Wall Connector. They should make sure that all wires are properly connected and torqued according to the installation guide for the Wall Connector.

As this alert is usually specific to external charging equipment and power sources, and it does not typically indicate an issue with your vehicle that can be resolved by scheduling service, it is recommended that you:

- Try charging with different wall outlets.
- Try charging with multiple, different types of charging equipment at different locations.

You can also try charging your vehicle using a Tesla Supercharger or Destination Charging location, all of which can be located through the map on your vehicle's touchscreen display. See [Maps and Navigation on page 143](#) for more details. Additional third-party charging stations may also be available in your area to help you to pinpoint the issue.

For more information on troubleshooting Mobile Connector or Wall Connector status lights, refer to the product's Owner's Manual at [Charging & Adapter Product Guides](#). If using other external charging equipment, refer to the manufacturer's provided documentation for troubleshooting tips.

(CHG_f091) Charging equipment not recognized Try again or try different equipment

The charge port is unable to detect whether a charge cable is inserted or the type of charge cable connected.

If this alert appears while a charge cable **is** connected, it should be determined whether the issue is caused by the charging equipment or the vehicle. Try charging the vehicle using different external charging equipment (charge cable, charging station, charging stall, etc.).

- If the vehicle begins charging, the issue was likely with the equipment.
- If the vehicle still does not charge, the issue may be with the vehicle.

If this alert appears while a charge cable is **not** connected or if the issue is suspected to be with the vehicle, inspect the charge port inlet and the charge cable connector for any obstructions (use a flashlight as necessary). Debris, moisture, and/or foreign objects present in the charge port inlet or the charge cable connector can prevent the charge port from properly detecting charge cables.

It is recommended that any debris / foreign objects be removed and any moisture be allowed to dry. Afterward, try re-inserting the cable into the charge port. Charging should now be possible.

As this alert is usually specific to external charging equipment and power sources, and it does not typically indicate an issue with your vehicle that can be resolved by scheduling service, it is recommended that you:



- Try charging with multiple, different types of charging equipment.
- Make sure any charge port inlet obstruction has been removed.

You can also try charging your vehicle using a Tesla Supercharger or Destination Charging location, all of which can be located through the map on your vehicle's touchscreen display. See [Maps and Navigation on page 143](#) for more details. Additional third-party charging stations may also be available in your area to help you to pinpoint the issue.

For more information on troubleshooting Mobile Connector or Wall Connector status lights, refer to the product's Owner's Manual at [Charging & Adapter Product Guides](#). If using other external charging equipment, refer to the manufacturer's provided documentation for troubleshooting tips.

For more information on charging, see [Charging Instructions on page 176](#).

(CHGS_f083)

Cannot charge - Poor grid power quality possible Retry / Try other charge location or Supercharging

Charging has stopped due to a condition that prevents your vehicle from charging with AC power. DC fast charging / Supercharging should still function as expected.

This condition could occur due to power supply disturbances caused by the external charging equipment or by the electrical power grid. In some cases, this condition can even result from turning on nearby electric devices that draw a lot of power.

If these possible causes can be ruled out, then a condition with your vehicle itself may also be affecting AC charging.

This alert is often accompanied by other alerts that can help you identify and troubleshoot the condition. Start by investigating any other displayed alerts that relate to charging.

Further troubleshooting tips based on equipment type:

- If using a Mobile Connector, try charging your vehicle with a different wall outlet.
 - If your vehicle starts to charge and continues to charge as expected, the issue was likely with the original wall outlet. It is recommended that you contact an electrician to inspect the building wiring connection to that outlet.
 - If your vehicle still does not start to charge, or does not continue to charge as expected, the issue may be with the Mobile Connector or the electrical grid.
- If using a Wall Connector, try charging your vehicle with different charging equipment like a Mobile Connector powered by a separate wall outlet.
 - If your vehicle starts to charge and continues to charge as expected, the issue was likely with the Wall Connector. Contact an electrician to inspect the building wiring connection to the Wall Connector. They should make sure that all wires are properly connected and torqued according to the installation guide for the Wall Connector.

As this alert is usually specific to external charging equipment and power sources, and it does not typically indicate an issue with your vehicle that can be resolved by scheduling service, it is recommended that you:

- Try charging with different wall outlets.
- Try charging with multiple, different types of charging equipment at different locations.

You can also try charging your vehicle using a Tesla Supercharger or Destination Charging location, all of which can be located through the map on your vehicle's touchscreen display. See [Maps and Navigation on page 143](#) for more details. Additional third-party charging stations may also be available in your area to help you to pinpoint the issue.

For more information on troubleshooting Mobile Connector or Wall Connector status lights, refer to the product's Owner's Manual at [Charging & Adapter Product Guides](#). If using other external charging equipment, refer to the manufacturer's provided documentation for troubleshooting tips.

(CHG_u001)

Charge rate reduced - Unexpected voltage drop Remove extension cords / Have wiring inspected

Charging speed has been reduced because the onboard charger in your vehicle has detected a large voltage drop during charging.

Likely causes of this issue include:

- Problems with the building wiring and/or the wall outlet.
- An extension cord or other wiring that cannot support the requested charge current.

This issue can also result from turning on electric devices that draw a lot of power from the same branch circuit while the vehicle is charging.

If this issue has occurred multiple times at your normal charging location, contact an electrician to inspect the electrical installation. They should check the following:

- Any installed charging equipment and its connection to the building wiring.
- The building wiring, including any wall outlet used with a Mobile Connector.
- The electrical connection to the power utility line where it enters the building.

Discuss with the electrician whether the charge current on the vehicle should be lowered, or if the installation should be upgraded to support a higher charge current.

As this alert is usually specific to external charging equipment and power sources, and it does not typically indicate an issue with your vehicle that can be resolved by scheduling service, it is recommended that you:

- Try charging with multiple, different types of charging equipment at different locations.
- Contact an electrician to inspect the wiring and equipment at your normal charging location.

You can also try charging your vehicle using a Tesla Supercharger or Destination Charging location, all of which can be located through the map on your vehicle's touchscreen display. See [Maps and Navigation on page 143](#) for more details. Additional third-party charging stations may also be available in your area to help you to pinpoint the issue.

For more information on troubleshooting Mobile Connector or Wall Connector status lights, refer to the product's Owner's Manual at [Charging & Adapter Product Guides](#). If using other external charging equipment, refer to the manufacturer's provided documentation for troubleshooting tips.

(CHG_u002)

Charging stopped due to large voltage drop Remove extension cords / Have wiring inspected

Charging has been interrupted because the onboard charger in your vehicle has detected an unusually large voltage drop.

Likely causes of this issue include:

- Problems with the building wiring and/or the wall outlet.
- An extension cord or other wiring that cannot support the requested charge current.

This issue can also result from turning on electric devices that draw a lot of power from the same branch circuit while the vehicle is charging.

If this issue has occurred multiple times at your normal charging location, contact an electrician to inspect the electrical installation. They should check the following:



- Any installed charging equipment and its connection to the building wiring.
- The building wiring, including any wall outlet used with a Mobile Connector.
- The electrical connection to the power utility line where it enters the building.

Discuss with the electrician whether the charge current on the vehicle should be lowered, or if the installation should be upgraded to support a higher charge current.

As this alert is usually specific to external charging equipment and power sources, and it does not typically indicate an issue with your vehicle that can be resolved by scheduling service, it is recommended that you:

- Try charging with multiple, different types of charging equipment at different locations.
- Contact an electrician to inspect the wiring and equipment at your normal charging location.

You can also try charging your vehicle using a Tesla Supercharger or Destination Charging location, all of which can be located through the map on your vehicle's touchscreen display. See [Maps and Navigation on page 143](#) for more details. Additional third-party charging stations may also be available in your area to help you to pinpoint the issue.

For more information on troubleshooting Mobile Connector or Wall Connector status lights, refer to the product's Owner's Manual at [Charging & Adapter Product Guides](#). If using other external charging equipment, refer to the manufacturer's provided documentation for troubleshooting tips.

(CHG_u004)

Charging stopped - Power lost while charging Check power source and charging equipment

Power has been lost during charging. This could result from the charging equipment losing power from the source (for example, a wall outlet) or from an issue with the charging equipment.

This alert is often accompanied by other alerts that can help you identify and troubleshoot the issue. Start by investigating any other displayed alerts that relate to charging issues.

Alternatively, you can check Mobile Connector or Wall Connector status lights to confirm power to the device, and also refer to the product owner's manual for troubleshooting information based on blink codes. If using other (non-Tesla) external charging equipment, check for a display or other user interface that provides troubleshooting help.

If there is clearly no power to the charging equipment, check the circuit breaker for the wall outlet / Wall Connector to make sure it has not tripped.

Further troubleshooting tips based on equipment type:

- If using a Mobile Connector, try charging the vehicle with a different wall outlet.
 - If the vehicle starts to charge, the issue was likely with the original wall outlet. It is recommended that you contact an electrician to inspect the building wiring connection to that outlet.
 - If the vehicle still does not charge, the issue may be with the Mobile Connector.
- If using a Wall Connector, try charging the vehicle with different charging equipment like a Mobile Connector powered by a separate wall outlet.
 - If the vehicle starts to charge, the issue was likely with the Wall Connector. Contact an electrician to inspect the building wiring connection to the Wall Connector. They should make sure that all wires are properly connected and torqued according to the installation guide for the Wall Connector.

As this alert is usually specific to external charging equipment and power sources, and it does not typically indicate an issue with your vehicle that can be resolved by scheduling service, it is recommended that you:

- Try charging with different wall outlets.
- Try charging with different charging equipment.

Troubleshooting Alerts

You can also try charging your vehicle using a Tesla Supercharger or Destination Charging location, all of which can be located through the map on your vehicle's touchscreen display. See [Maps and Navigation on page 143](#) for more details. Additional third-party charging stations may also be available in your area to help you to pinpoint the issue.

For more information on troubleshooting Mobile Connector or Wall Connector status lights, refer to the product's Owner's Manual at [Charging & Adapter Product Guides](#). If using other external charging equipment, refer to the manufacturer's provided documentation for troubleshooting tips.

(CHG_u005)

Unable to charge - Charge station not powered Check power source or try a different station

Charging cannot begin because the charging equipment is not ready. A charge handle is detected, but the charging station is not communicating with the vehicle. This issue could occur because:

- The charging station is not powered.
- The control pilot signal between the charging station and the vehicle is interrupted.

Try charging the vehicle with different charging equipment or at a different charging station.

If the vehicle starts to charge, the issue was likely with the equipment.

If using a Mobile Connector or Wall Connector, first check the status lights on the front. If no status lights are visible, check the power source and contact an electrician to inspect the building wiring connection to the wall outlet or the Wall Connector to confirm that all wires are properly connected and torqued.

If using other external charging equipment, consult the product's owner's manual to learn how to confirm that the station is powered. Contact an electrician to inspect the building wiring and charging equipment as necessary.

If the vehicle still does not charge, the issue may be with the vehicle.

As this alert is usually specific to external charging equipment and power sources, and it does not typically indicate an issue with your vehicle that can be resolved by scheduling service, it is recommended that you:

- Try charging with different charge equipment / at different stations.

You can also try charging your vehicle using a Tesla Supercharger or Destination Charging location, all of which can be located through the map on your vehicle's touchscreen display. See [Maps and Navigation on page 143](#) for more details. Additional third-party charging stations may also be available in your area to help you to pinpoint the issue.

For more information on troubleshooting Mobile Connector or Wall Connector status lights, refer to the product's Owner's Manual at [Charging & Adapter Product Guides](#). If using other external charging equipment, refer to the manufacturer's provided documentation for troubleshooting tips.

(CHG_u006)

Charge port latch not engaged Fully insert charge cable or check for obstruction

The charge port latch is unable to latch the charge cable in the charge port inlet. If the latch is not engaged, AC charging (for example, charging with a Mobile Connector or Wall Connector) will be limited to 16A and DC Fast Charging / Supercharging will be unavailable.

Try re-inserting the charge cable fully into the charge port inlet.

If your vehicle begins charging and the charge port light pulses green, the charge cable may not have been fully inserted before. The latch may not have engaged during previous attempts because the cable was not fully inserted. AC charging should no longer be limited, and DC Fast Charging / Supercharging should be available.



If charging is still limited or the vehicle will not charge at all, inspect the charge port inlet and the charge cable connector for any obstructions (use a flashlight as needed). Debris and/or foreign objects in the charge port inlet or the charge cable connector can prevent you from fully inserting the charge cable. If the cable is not fully inserted, the charge port latch will not engage.

It is recommended that any debris / foreign objects be removed. Afterward, try re-inserting the cable into the charge port inlet. AC charging should no longer be limited, and DC Fast Charging / Supercharging should be available.

As this alert is usually specific to external charging equipment and power sources, and it does not typically indicate an issue with your vehicle that can be resolved by scheduling service, it is recommended that you:

- Make sure the charge cable is fully inserted during charging.
- Make sure any charge port inlet obstruction has been removed.

You can also try charging your vehicle using a Tesla Supercharger or Destination Charging location, all of which can be located through the map on your vehicle's touchscreen display. See [Maps and Navigation on page 143](#) for more details. Additional third-party charging stations may also be available in your area to help you to pinpoint the issue.

For more information on troubleshooting Mobile Connector or Wall Connector status lights, refer to the product's Owner's Manual at [Charging & Adapter Product Guides](#). If using other external charging equipment, refer to the manufacturer's provided documentation for troubleshooting tips.

For more information on charging, see [Charging Instructions on page 176](#).

(CHG_u007)

Charging equipment reports error

Check equipment for error code or message

Charging was interrupted because the external charging equipment has reported a fault that prevents the vehicle from charging.

Inspect the external charging equipment and look for status lights, displays, or other status indicators on the equipment. Consult the equipment owner's manual for further troubleshooting instructions.

Try charging the vehicle with different charging equipment or at a different charging station.

- If the vehicle starts to charge, the issue was likely with the equipment.
- If the vehicle still does not charge, the issue may be with the vehicle.

As this alert is usually specific to external charging equipment and power sources, and it does not typically indicate an issue with your vehicle that can be resolved by scheduling service, it is recommended that you:

- Try charging with different charge equipment / at different stations.

You can also try charging your vehicle using a Tesla Supercharger or Destination Charging location, all of which can be located through the map on your vehicle's touchscreen display. See [Maps and Navigation on page 143](#) for more details. Additional third-party charging stations may also be available in your area to help you to pinpoint the issue.

For more information on troubleshooting Mobile Connector or Wall Connector status lights, refer to the product's Owner's Manual at [Charging & Adapter Product Guides](#). If using other external charging equipment, refer to the manufacturer's provided documentation for troubleshooting tips.

(CHG_u010)

External charging equipment error detected

Try different charging equipment

AC charging cannot begin due to a condition that prevents your vehicle from charging with AC power. DC fast charging / Supercharging should still function as expected.



Troubleshooting Alerts

Your vehicle's onboard charger is detecting input voltage at the charge port when no power has been requested from the external charging equipment, which indicates the external charging equipment is not functioning as expected.

This can sometimes be caused by a hardware issue specific to the external charging equipment, which prevents the charging equipment from switching power to the vehicle on or off when requested. It could also occur due to another condition affecting the external charging equipment, or a condition affecting your vehicle itself.

As this alert is usually specific to external charging equipment, and it does not typically indicate an issue with your vehicle that can be resolved by scheduling service, it is recommended that you try charging with multiple, different types of charging equipment.

You can also try charging your vehicle using a Tesla Supercharger or Destination Charging location, all of which can be located through the map on your vehicle's touchscreen display. See [Maps and Navigation on page 143](#) for more details. Additional third-party charging stations may also be available in your area to help you to pinpoint the issue.

For more information on troubleshooting Mobile Connector or Wall Connector status lights, refer to the product's Owner's Manual at [Charging & Adapter Product Guides](#). If using other external charging equipment, refer to the manufacturer's provided documentation for troubleshooting tips.

(CHG_u012)

Charging slowed - Poor grid power quality possible Unplug and retry / Try different charging location

Charging speed has been reduced due to a condition that affects your vehicle's ability to charge with AC power. DC fast charging / Supercharging should still function as expected.

This condition could occur due to power supply disturbances caused by the external charging equipment or by the electrical power grid. In some cases, this condition can even result from turning on nearby electric devices that draw a lot of power.

If these possible causes can be ruled out, then a condition with your vehicle itself may also be affecting AC charging.

This alert is often accompanied by other alerts that can help you identify and troubleshoot the condition. Start by investigating any other displayed alerts that relate to charging.

Further troubleshooting tips based on equipment type:

- If using a Mobile Connector, try charging your vehicle with a different wall outlet.
 - If charging speed is no longer reduced, the issue was likely with the original wall outlet. It is recommended that you contact an electrician to inspect the building wiring connection to that outlet.
 - If charging speed is still reduced, the issue may be with the Mobile Connector or the electrical grid.
- If using a Wall Connector, try charging your vehicle with different charging equipment like a Mobile Connector powered by a separate wall outlet.
 - If charging speed is no longer reduced, the issue was likely with the Wall Connector. Contact an electrician to inspect the building wiring connection to the Wall Connector. They should make sure that all wires are properly connected and torqued according to the installation guide for the Wall Connector.

As this alert is usually specific to external charging equipment and power sources, and it does not typically indicate an issue with your vehicle that can be resolved by scheduling service, it is recommended that you:

- Try charging with different wall outlets.
- Try charging with multiple, different types of charging equipment at different locations.

You can also try charging your vehicle using a Tesla Supercharger or Destination Charging location, all of which can be located through the map on your vehicle's touchscreen display. See [Maps and Navigation on page 143](#) for more details. Additional third-party charging stations may also be available in your area to help you to pinpoint the issue.



For more information on troubleshooting Mobile Connector or Wall Connector status lights, refer to the product's Owner's Manual at [Charging & Adapter Product Guides](#). If using other external charging equipment, refer to the manufacturer's provided documentation for troubleshooting tips.

(CHG_u013)

Charging equipment communication lost

Check power source and charging equipment

Charging stopped because communication between the vehicle and the external charging equipment was interrupted.

Confirm whether the external charging equipment is powered by looking for any status lights, displays, or other indicators on the equipment.

If the equipment is **not** powered, try to restore the external charging equipment's power source.

- If attempting to charge at a public station and power is unable to be restored, contact the station operator.
- If attempting to charge at a private station (for example: charging at home) and power is unable to be restored, contact an electrician.

If the equipment is powered, try charging the vehicle using different external charging equipment.

- If the vehicle begins charging, the issue was likely with the equipment.
- If the vehicle still does not charge, the issue may be with the vehicle.

As this alert is usually specific to external charging equipment and power sources, and it does not typically indicate an issue with your vehicle that can be resolved by scheduling service, it is recommended that you:

- Make sure the external charging equipment is powered.
- Try charging with multiple, different types of charging equipment.

You can also try charging your vehicle using a Tesla Supercharger or Destination Charging location, all of which can be located through the map on your vehicle's touchscreen display. See [Maps and Navigation on page 143](#) for more details. Additional third-party charging stations may also be available in your area to help you to pinpoint the issue.

For more information on troubleshooting Mobile Connector or Wall Connector status lights, refer to the product's Owner's Manual at [Charging & Adapter Product Guides](#). If using other external charging equipment, refer to the manufacturer's provided documentation for troubleshooting tips.

(CHG_u014)

Charging equipment reports error

Check equipment for error code or message

Charging was interrupted because the external charging equipment has reported a fault that prevents the vehicle from charging.

Inspect the external charging equipment and look for status lights, displays, or other status indicators on the equipment. Consult the equipment owner's manual for further troubleshooting instructions.

Try charging the vehicle with different charging equipment or at a different charging station.

- If the vehicle starts to charge, the issue was likely with the equipment.
- If the vehicle still does not charge, the issue may be with the vehicle.

As this alert is usually specific to external charging equipment and power sources, and it does not typically indicate an issue with your vehicle that can be resolved by scheduling service, it is recommended that you:



- Try charging with different charge equipment / at different stations.

You can also try charging your vehicle using a Tesla Supercharger or Destination Charging location, all of which can be located through the map on your vehicle's touchscreen display. See [Maps and Navigation on page 143](#) for more details. Additional third-party charging stations may also be available in your area to help you to pinpoint the issue.

For more information on troubleshooting Mobile Connector or Wall Connector status lights, refer to the product's Owner's Manual at [Charging & Adapter Product Guides](#). If using other external charging equipment, refer to the manufacturer's provided documentation for troubleshooting tips.

(CHG_w032)

Charge rate reduced - Wall connection hot Outlet or Wall Connector wiring must be checked

High temperature detected by Wall Connector alerts indicate the building connection to the Wall Connector is getting too warm, so charging has been slowed to protect the wiring and Wall Connector.

This is not typically an issue with your vehicle or your Wall Connector, but rather an issue with the building wiring. This may be caused by a loose building wiring connection to the Wall Connector and can be fixed quickly by an electrician.

To regain normal charge speed, contact an electrician to inspect the building wiring connection to the Wall Connector. They should make sure that all wires are properly connected and torqued according to the installation guide for the Wall Connector.

Wall Connector installation guides can be found [here](#).

(CHG_w037)

Unable to charge - Wall connection too hot Outlet or Wall Connector wiring must be checked

High temperature detected by Wall Connector alerts indicate the building connection to the Wall Connector is getting too warm, so charging has stopped to protect the wiring and Wall Connector.

This is not typically an issue with your vehicle or your Wall Connector, but rather an issue with the building wiring. This may be caused by a loose building wiring connection to the Wall Connector and can be fixed quickly by an electrician.

To regain normal charge operation, contact an electrician to inspect the building wiring connection to the Wall Connector. They should make sure that all wires are properly connected and torqued according to the installation guide for the Wall Connector.

Wall Connector installation guides can be found [here](#).

(CP_w043)

Charge port door sensor fault Charge port may not operate as expected

One of the charge port door sensors is not functioning normally. When this occurs, the charge port may be unable to accurately sense the charge port door position and the charge port may not operate as expected.

- The charge port latch may intermittently remain engaged when the charge port door is opened.
- The charge port light may illuminate only intermittently when the charge port door is opened.

If you encounter these or similar behaviors while the alert is present, try closing the charge port door and then opening it again to restore normal function.

For more information, see [Opening the Charge Port on page 176](#).



For more information on charging, see [Charging Instructions on page 176](#).

(CP_w054)

Charge port latch not engaged Fully insert charge cable or check for obstruction

The charge port latch is unable to latch the charge cable in the charge port inlet. If the latch is not engaged, AC charging (for example, charging with a Mobile Connector or Wall Connector) will be limited to 16A and DC Fast Charging / Supercharging will be unavailable.

The charge port light will pulse amber if this alert appears during AC charging and will be solid amber if this alert appears when attempting to DC Fast Charge / Supercharge.

Try re-inserting the charge cable fully into the charge port inlet.

If your vehicle begins charging and the charge port light pulses green, the charge cable may not have been fully inserted before. The latch may not have engaged during previous attempts because the cable was not fully inserted. AC charging should no longer be limited, and DC Fast Charging / Supercharging should be available.

If charging is still limited or the vehicle will not charge at all, inspect the charge port inlet and the charge cable connector for any obstructions (use a flashlight as needed). Debris and/or foreign objects in the charge port inlet or the charge cable connector can prevent you from fully inserting the charge cable. If the cable is not fully inserted, the charge port latch will not engage.

It is recommended that any debris / foreign objects be removed. Afterward, try re-inserting the cable into the charge port inlet. AC charging should no longer be limited, and DC Fast Charging / Supercharging should be available.

As this alert is usually specific to external charging equipment and power sources, and it does not typically indicate an issue with your vehicle that can be resolved by scheduling service, it is recommended that you:

- Make sure the charge cable is fully inserted during charging.
- Make sure any charge port inlet obstruction has been removed.

You can also try charging your vehicle using a Tesla Supercharger or Destination Charging location, all of which can be located through the map on your vehicle's touchscreen display. See [Maps and Navigation on page 143](#) for more details. Additional third-party charging stations may also be available in your area to help you to pinpoint the issue.

For more information on troubleshooting Mobile Connector or Wall Connector status lights, refer to the product's Owner's Manual at [Charging & Adapter Product Guides](#). If using other external charging equipment, refer to the manufacturer's provided documentation for troubleshooting tips.

For more information on charging, see [Charging Instructions on page 176](#).

(DI_u015)

Cruise control unavailable

Cruise Control, including Traffic-Aware Cruise Control, is currently unavailable. Take control and drive your vehicle manually.

Continue to your destination. Your vehicle is OK to drive.

Cruise Control might become unavailable due to many factors, including:

- Driver input or behavior:
 - Unbuckling the driver's seat belt
 - Not closing the doors, front trunk, or trunk
 - Canceling a Cruise Control request
 - Trying to activate Cruise Control below minimum speed of 18mph (30 km/h)

- Environmental / external conditions
- Vehicle System Restraints:
 - May include camera or radar lack of visibility
- Valet Mode is active:
 - For more information, see [Valet Mode on page 48](#).

When any condition preventing Cruise Control activation is no longer present, Cruise Control should be available.

If this alert persists throughout subsequent drives, schedule service at your convenience. Your vehicle is OK to drive in the meantime.

For more information, see [Traffic-Aware Cruise Control on page 96](#).

(DI_u024) **Autopark canceled** **Take control**

Autopark has been canceled. You need to park or finish parking your vehicle manually.

Once the parking maneuver is complete, apply the brakes and shift into Park. Your vehicle will otherwise remain free-rolling.

Autopark can be canceled due to many factors, including the following:

- Driver input or behavior
 - Using the gear stalk
 - Moving the steering wheel
 - Pressing the accelerator pedal
 - Pressing the brake pedal
 - Opening a door and/or exiting the vehicle
 - Pressing the Cancel button on the touchscreen
- Environmental / external conditions
 - Steep slope / grade
 - Weather conditions affecting visibility / sensor function
 - Curb cannot be detected
- A trailer is attached to the vehicle
- Vehicle system constraints

Autopark should be available again during your next drive.

If this alert persists throughout subsequent drives, schedule service at your earliest convenience. Your vehicle is OK to drive in the meantime.

For more information, see [To Cancel Parking on page 117](#) and [Limitations on page 117](#).

(DI_u025) **Autopark aborted**

Autopark has aborted and the Electronic Parking Brake has been applied. You need to park or finish parking your vehicle manually.

Once the parking maneuver is complete, apply the brakes and shift into Park. Your vehicle will otherwise remain free-rolling.



Autopark can abort due to many factors, including the following:

- Driver input or behavior
 - Using the gear stalk
 - Moving the steering wheel
 - Pressing the accelerator pedal
 - Pressing the brake pedal
 - Opening a door and/or exiting the vehicle
 - Pressing the Cancel button on the touchscreen
- Environmental / external conditions
 - Steep slope / grade
 - Weather conditions affecting visibility / sensor function
 - Curb cannot be detected
- A trailer is attached to the vehicle
- Vehicle system constraints

Autopark should be available again during your next drive.

If this alert persists throughout subsequent drives, contact Tesla Service at your earliest convenience. Your vehicle is OK to drive in the meantime.

For more information, see [To Cancel Parking on page 117](#) and [Limitations on page 117](#).

(DI_w039)

Regenerative braking temporarily reduced Regen will increase as vehicle is driven

Regenerative braking performance has been temporarily reduced to below 65% of its full capacity. The exact reduction is indicated by the dashed lines on the power meter.

While this alert is present, the deceleration rate of the vehicle due to regenerative braking will be reduced and more brake pedal application will be required to slow the vehicle (similar to what is needed in a gas-powered, non-electric, vehicle).

This alert is expected under the following conditions:

- Battery is near full charge:
 - Regenerative braking is reduced when the battery is at 95% charge or higher.
- Battery is cold:
 - The battery may not be warm enough for full regenerative braking performance (possibly at the beginning of a drive).
 - In extremely cold climates, this alert may remain present indefinitely and regenerative braking may remain reduced, as driving the vehicle may not warm the battery enough to fully restore performance.

Typically, driving will clear this alert because it will reduce the battery charge level below 95% and sufficiently warm the battery.

This is a completely normal part of vehicle operation and should not cause alarm. The notice on the screen is for your information only.

For more information on regenerative braking, see the Regenerative Braking section in the Owner's Manual. [Regenerative Braking on page 68](#).



(DI_w168)

Vehicle Hold feature unavailable Keep brake pedal pressed while stopped

Vehicle Hold is currently unavailable due to system constraints. When stopping, use the brake pedal to bring your vehicle to a complete stop and keep your vehicle stationary.

Continue to your destination. Your vehicle is OK to drive.

If Vehicle Hold is not available during your next drive, contact Tesla Service. Your vehicle is OK to drive in the meantime.

For more information, see [Vehicle Hold on page 73](#).

(DI_w172)

Powertrain requires service Avoid hard acceleration

An issue has been detected in the powertrain system. The vehicle is OK to drive, but you should schedule service as soon as possible for a powertrain inspection.

Your vehicle has detected excessive backlash (lash) between the drive unit and the wheels. High, or excessive, lash is indicative of mechanical wear.

There are many possible causes, so a powertrain inspection is needed.

Your vehicle is OK to drive to your immediate destination and to a service center. Avoid hard or heavy acceleration, as this puts more stress on the powertrain.

Schedule a service appointment at your earliest opportunity. If this issue is not addressed, your vehicle might unexpectedly stop while you are driving.

(GTW_w017)

Electrical system power reduced Non-essential features may be unavailable

Some non-essential features, like seat heaters or cabin heating / cooling, may be unavailable or may operate at a reduced level. This is expected behavior designed to help your vehicle maintain adequate electrical power for essential functions.

This alert may be present due to various vehicle conditions. For more information and further recommended actions, check for other alerts specific to conditions affecting your vehicle's electrical system.

(GTW_w018)

Electrical system power reduced Non-essential features may be unavailable

Some non-essential features, like seat heaters or cabin heating / cooling, may be unavailable or may operate at a reduced level. This is expected behavior designed to help your vehicle maintain adequate electrical power for essential functions.

This alert may be present due to various vehicle conditions. For more information and further recommended actions, check for other alerts specific to conditions affecting your vehicle's electrical system.



(GTW_w174)

12V battery must be replaced - Schedule service Software will not update until battery is replaced

The low voltage battery is showing degraded performance and needs to be replaced. Until the low voltage battery is replaced, vehicle software updates will not complete.

It is recommended that you have the low voltage battery replaced at your earliest convenient opportunity.

You can schedule service via your Tesla Mobile App, or with an independent service provider that offers low voltage battery replacement for your vehicle. Please note that independent service provider options may vary, based on your vehicle configuration and your location.

Your vehicle is OK to drive with this alert present. However, if you delay the low voltage battery replacement, your vehicle may eventually not have enough electrical power to start or to restart after a recent drive.

If the low voltage battery does not have enough electrical power to turn on your vehicle or open the doors, see [Battery Care on page 175](#) for recommended actions.

For more information on the battery system, see [High Voltage Battery Information on page 175](#).

(GTW_w360)

Assist for low brake performance activated To stop, keep brake pedal firmly pressed

Hydraulic Fade Compensation is active. This brake assist function activates temporarily to make sure you have full braking capability in conditions where reduced braking performance is detected by your vehicle.

Continue to press the brake pedal as you normally would, and do not "pump" (repeatedly press and release) the pedal as this will interrupt the function.

This alert will clear when your vehicle comes to a stop or you are no longer pressing the brake pedal. It may still be displayed for up to 5 seconds afterward.

When this assist function activates, you may feel the brake pedal pull away from your foot and notice a strong increase in brake pressure. You may also hear a pumping sound coming from the brake hydraulic unit at the front of the vehicle. This will usually last for a few seconds, depending on road surface and vehicle speed. This is completely normal and does not indicate any issue with your vehicle.

Reduced braking performance is usually temporary, and can occur for a number of reasons including high brake temperatures after heavy brake use, or driving in extremely cold or wet conditions. It can also indicate that your brake pads or rotors have worn to the point that normal replacement is needed.

If you continue to experience reduced braking performance which does not improve over time, please contact Tesla service at your convenience for a brake inspection.

For more information, see [Hydraulic Fade Compensation on page 68](#).

(GTW_w405)

Electrical system power reduced Vehicle may shut down unexpectedly

The electrical system cannot maintain the voltage required to support all vehicle features.

If this alert is present while you are driving, it is possible your vehicle will shut down unexpectedly.

It is also possible that your vehicle will not restart after the current drive.

Troubleshooting Alerts

It is recommended that you eliminate or reduce your use of any non-essential features. This can help your vehicle maintain adequate electrical power for essential functions. It may also prevent your vehicle from shutting down before you reach your immediate destination, although this is not guaranteed.

If this alert remains active, schedule service immediately. Without service, your vehicle may shut down unexpectedly or may not restart.

(MCU_u019)

Active service connection to vehicle Service performing remote diagnostics

A service technician is remotely logged into your vehicle for diagnosis or repair. You may notice some loss of Infotainment functionality while the connection persists, but this alert does not indicate an issue with your vehicle.

Your vehicle is OK to drive.

This alert should clear automatically after the technician completes vehicle diagnosis or repair. You may find it necessary to restart your touchscreen to restore full Infotainment functionality after the alert has cleared. For more information, see [Restarting the Touchscreen](#) in your vehicle's [Do It Yourself Guide](#).

If this alert does not clear after 24 hours, it is recommended that you schedule service via your Tesla Mobile App or with an independent service provider. Please note that independent service provider options may vary, based on your vehicle configuration and your location.

(MCU_w008)

Air pressure in tires very low PULL OVER SAFELY - Check for flat tire

This alert indicates that one or more of the tires on your vehicle is extremely low or flat.

The Tire Pressure Monitoring System (TPMS) has detected that the air pressure in one or more of your tires is significantly lower than the recommended cold tire pressure. This recommended cold pressure (RCP) is displayed on the Tire and Loading information label.

You should pull over carefully as soon as possible. In a safe location, check for a flat tire.

You can request Tesla roadside assistance options (mobile tire, loaner wheel, tow) if required. See [Contacting Tesla Roadside Assistance on page 214](#) for more information.

In a non-emergency situation, it is recommended that you visit a local tire shop for assistance or schedule service using your Tesla Mobile App

See [Maintaining Tire Pressures on page 184](#) for detailed information on how to keep the tires properly inflated.

The alert will clear once the TPMS has a consistent tire pressure measurement for each of your tires within 3 psi of the recommended cold pressure.

- The alert and Tire Pressure indicator light may still be present immediately after you have filled your tires to the recommended cold pressure, but both should clear once you have driven a short distance.
- You may need to drive over 15 mph (25 km/h) for at least 10 minutes for the Tire Pressure Monitoring System to measure and report your updated tire pressures.

For more information on tire pressure, inflation, and maintenance, see [Tire Care and Maintenance on page 184](#).

(MCU_w010)

Air pressure below recommendation for tires Check pressure and refill air as needed

This alert does NOT indicate that there is a flat tire.



The tire pressure monitoring system (TPMS) has detected that the air pressure in one or more of your tires is at least 20% lower than the recommended cold tire pressure. This recommended pressure should be displayed on the Tire and Loading information label.

See [Maintaining Tire Pressures on page 184](#) for detailed information on how to keep the tires properly inflated.

This alert may appear in cold weather because the air in your tires naturally contracts when it becomes cold, decreasing tire pressures.

- Although drops in tire pressure are expected in colder weather, air should still be added to maintain the recommended cold tire pressure.
- The alert may clear as the vehicle is driven. This is because the tires will warm up and the tire pressure will increase.
 - Even if the alert clears, the tires should still be refilled with air once they have cooled. For the best experience with your vehicle, the recommended cold tire pressure should be maintained at all times.

The alert should clear once the Tire Pressure Monitoring System detects that each of your tires is inflated to the recommended cold pressure.

- The alert and Tire Pressure indicator light may still be present immediately after you have filled your tires to the recommended cold pressure, but both should clear once you have driven a short distance.
- You may need to drive over 15 mph (25 km/h) for at least 10 minutes for the Tire Pressure Monitoring System to measure and report your updated tire pressures.

If you repeatedly see this alert for the same tire, have the tire inspected for a slow leak. You can visit a local tire shop or schedule service using your Tesla Mobile App.

For more information on tire pressure and inflation, see [Tire Care and Maintenance on page 184](#).

(MCU_w029)

Service is required Schedule service now

This alert is set remotely by Tesla when a condition requiring service is detected on your vehicle.

This alert can be set due to various conditions. When you schedule service, more information should be available.

This alert can only be cleared by a service technician after your vehicle has been serviced.

As this alert can be present due to various conditions, it is recommended that you schedule service at your earliest convenience.

(THC_u0005)

Air conditioning temporarily reduced Vehicle systems being cooled

Cabin air conditioning performance has been temporarily reduced because your vehicle needs to focus on cooling the high voltage battery (Battery) and/or powertrain. This is completely normal and does not indicate a problem with your vehicle or the air conditioning (A/C) system.

In addition to cooling the vehicle interior, the A/C system also cools the Battery. The A/C system's priority is to cool the Battery to make sure it stays within an optimal temperature range that supports longevity and best performance.

In high temperature environments, it is normal for your vehicle to focus more for brief periods on cooling the Battery. When this happens, it is most often because the vehicle is supercharging in hot weather.

No action is required. Your vehicle is OK to drive.

Troubleshooting Alerts

The alert should clear in a short time, and cabin air conditioning performance should return to normal. In some cases, the alert and vehicle behavior will continue until supercharging is complete.

If the alert persists over multiple drives and is accompanied by other alerts that indicate potential issues with the A/C system, contact Tesla Service at your convenience to schedule an A/C system inspection.

(UMC_w002)

Unable to charge - Mobile Connector GFCI tripped Disconnect and retry or use different equipment

The vehicle cannot charge because the ground-fault circuit interrupter (GFCI) in the Mobile Connector has tripped.

Like the GFCI in a wall outlet, this feature is designed to stop the flow of electricity when there is a problem. It has interrupted charging to protect your vehicle and the charging equipment.

This could happen for many reasons. The problem could be in the charge cable, the charge handle, the charge port, or even an onboard vehicle component.

Inspect the charge port as well as the charge handle for pooled water or unusual levels of moisture.

- If you find excessive moisture, wait and let both the inside area of the charge port and the exposed portion of the charge handle dry sufficiently before trying again.

Inspect the charge equipment for damage.

- If the cable is in any way damaged or deteriorated, **do not use it**. Try different charging equipment instead.
- If the cable is in good condition, try charging again with the same Mobile Connector.

If the issue persists and prevents charging, try charging with different charging equipment.

As this alert is usually specific to external charging equipment and power sources, and it does not typically indicate an issue with your vehicle that can be resolved by scheduling service, it is recommended that you:

- Try charging with multiple, different types of charging equipment.

You can also try charging your vehicle using a Tesla Supercharger or Destination Charging location, all of which can be located through the map on your vehicle's touchscreen display. See [Maps and Navigation on page 143](#) for more details. Additional third-party charging stations may also be available in your area to help you to pinpoint the issue.

For more information on troubleshooting Mobile Connector status lights and charging issues, refer to the [product's owner's manual](#).

(UMC_w004)

Unable to charge with Mobile Connector Voltage too high / Try a different wall outlet

The vehicle cannot charge, or charging is interrupted, because **either** the Mobile Connector:

- Detects the wall outlet voltage is too high.

OR

- Detects an unexpected increase in supply voltage from the wall outlet.

Try charging the vehicle with a different wall outlet.

If the vehicle starts to charge, the issue was likely with the original wall outlet. It is recommended that you contact an electrician to inspect the building wiring connection to that outlet.



If the vehicle still does not charge when you try a different wall outlet, try charging at a different location.

As this alert is usually specific to external charging equipment and power sources, and it does not typically indicate an issue with your vehicle that can be resolved by scheduling service, it is recommended that you:

- Try charging with different wall outlets.
- Try charging with different charging equipment.

You can also try charging your vehicle using a Tesla Supercharger or Destination Charging location, all of which can be located through the map on your vehicle's touchscreen display. See [Maps and Navigation on page 143](#) for more details. Additional third-party charging stations may also be available in your area to help you to pinpoint the issue.

For more information on troubleshooting Mobile Connector status lights and charging issues, refer to the [product's owner's manual](#).

(UMC_w005) Unable to charge with Mobile Connector Voltage too low / Try a different wall outlet

The vehicle cannot charge, or charging is interrupted, because **either** the Mobile Connector:

- Does not detect enough supply voltage from the wall outlet.

OR

- Detects an unexpected drop in supply voltage from the wall outlet.

Try charging the vehicle with a different wall outlet.

If the vehicle starts to charge, the issue was likely with the original wall outlet. It is recommended that you contact an electrician to inspect the building wiring connection to that outlet.

If the vehicle still does not charge when you try a different wall outlet, try charging at a different location.

As this alert is usually specific to external charging equipment and power sources, and it does not typically indicate an issue with your vehicle that can be resolved by scheduling service, it is recommended that you:

- Try charging with different wall outlets.
- Try charging with different charging equipment.

You can also try charging your vehicle using a Tesla Supercharger or Destination Charging location, all of which can be located through the map on your vehicle's touchscreen display. See [Maps and Navigation on page 143](#) for more details. Additional third-party charging stations may also be available in your area to help you to pinpoint the issue.

For more information on troubleshooting Mobile Connector status lights and charging issues, refer to the [product's owner's manual](#).

(UMC_w008) Unable to charge - Wall plug temperature high Wall outlet and wiring inspection recommended

High temperature detected by Mobile Connector alerts indicate the outlet used to charge is becoming too warm, so charging has stopped to protect the outlet.

This is not typically an issue with your vehicle or your Mobile Connector, but rather an issue with the outlet. A warm outlet may be caused by a plug that is not fully inserted, a loose building wiring connection to the outlet, or an outlet that is beginning to wear out.

Troubleshooting Alerts

To regain normal charge operation, make sure your adapter is fully plugged into the outlet. If charging speed does not return to normal, contact an electrician to inspect the outlet and building wiring connections to the outlet and complete any repairs needed.

If the outlet is worn, it should be replaced with a high-quality outlet. Consider upgrading to a Tesla Wall Connector for greater convenience and highest charging speed.

(UMC_w013)

Wall plug adapter error - Charge rate reduced **Plug adapter fully into Mobile Connector and retry**

Your Mobile Connector is unable to communicate with the wall plug adapter. Because your Mobile Connector cannot monitor the wall plug adapter temperature, charge current is automatically reduced to 8A.

It is recommended that you try the following troubleshooting steps:

1. Unplug your Mobile Connector, including the wall plug adapter, completely from the wall outlet.
2. Make sure the connection between the wall plug adapter and the main body of your Mobile Connector is secure.
 - a. Disconnect the wall plug adapter completely from the main body of your Mobile Connector.
 - b. Fully reinsert the wall plug adapter into the main body of your Mobile Connector by pushing it into the socket until it snaps into place.
3. Try charging again by plugging the Mobile Connector, including wall plug adapter, fully into the wall outlet.
4. If the alert persists, try using a different wall plug adapter (see steps above to make sure the adapter is fully connected to your Mobile Connector).
 - a. If the alert is no longer present, the issue is likely with the wall plug adapter you were using previously.
 - b. If the alert persists, the issue is likely with your Mobile Connector.

It is recommended that you obtain another wall plug adapter or Mobile Connector as needed, based on the troubleshooting steps above.

In the meantime, you can continue to charge with the same equipment. The charge rate will be reduced, as charge current will be limited to 8A while this condition persists.

You can also try charging your vehicle using a Tesla Supercharger or Destination Charging location, all of which can be located through the map on your vehicle's touchscreen display. See [Maps and Navigation on page 143](#) for more details. Additional third-party charging stations may also be available in your area to help you to pinpoint the issue.

For more information on troubleshooting Mobile Connector status lights and charging issues, refer to the [product's owner's manual](#).

(UMC_w014)

Wall plug adapter error - Charge rate reduced **Plug adapter fully into Mobile Connector and retry**

Your Mobile Connector is unable to communicate with the wall plug adapter. Because your Mobile Connector cannot identify the type of wall outlet the wall plug adapter is connected to, charge current is automatically reduced to 8A.

It is recommended that you try the following troubleshooting steps:

1. Unplug your Mobile Connector, including the wall plug adapter, completely from the wall outlet.
2. Make sure the connection between the wall plug adapter and the main body of your Mobile Connector is secure.
 - a. Disconnect the wall plug adapter completely from the main body of your Mobile Connector.
 - b. Fully reinsert the wall plug adapter into the main body of your Mobile Connector by pushing it into the socket until it snaps into place.
3. Try charging again by plugging the Mobile Connector, including wall plug adapter, fully into the wall outlet.



4. If the alert persists, try using a different wall plug adapter (see steps above to make sure the adapter is fully connected to your Mobile Connector).
 - a. If the alert is no longer present, the issue is likely with the wall plug adapter you were using previously.
 - b. If the alert persists, the issue is likely with your Mobile Connector.

It is recommended that you obtain another wall plug adapter or Mobile Connector as needed, based on the troubleshooting steps above.

In the meantime, you can continue to charge with the same equipment. The charge rate will be reduced, as charge current will be limited to 8A while this condition persists.

You can also try charging your vehicle using a Tesla Supercharger or Destination Charging location, all of which can be located through the map on your vehicle's touchscreen display. See [Maps and Navigation on page 143](#) for more details. Additional third-party charging stations may also be available in your area to help you to pinpoint the issue.

For more information on troubleshooting Mobile Connector status lights and charging issues, refer to the [product's owner's manual](#).

(UMC_w015)

Wall plug adapter error - Charge rate reduced

Plug adapter fully into Mobile Connector and retry

Your Mobile Connector is unable to communicate with the wall plug adapter. Because your Mobile Connector cannot identify the type of wall outlet the wall plug adapter is connected to, charge current is automatically reduced to 8A.

It is recommended that you try the following troubleshooting steps:

1. Unplug your Mobile Connector, including the wall plug adapter, completely from the wall outlet.
2. Make sure the connection between the wall plug adapter and the main body of your Mobile Connector is secure.
 - a. Disconnect the wall plug adapter completely from the main body of your Mobile Connector.
 - b. Fully reinsert the wall plug adapter into the main body of your Mobile Connector by pushing it into the socket until it snaps into place.
3. Try charging again by plugging the Mobile Connector, including wall plug adapter, fully into the wall outlet.
4. If the alert persists, try using a different wall plug adapter (see steps above to make sure the adapter is fully connected to your Mobile Connector).
 - a. If the alert is no longer present, the issue is likely with the wall plug adapter you were using previously.
 - b. If the alert persists, the issue is likely with your Mobile Connector.

It is recommended that you obtain another wall plug adapter or Mobile Connector as needed, based on the troubleshooting steps above.

In the meantime, you can continue to charge with the same equipment. The charge rate will be reduced, as charge current will be limited to 8A while this condition persists.

You can also try charging your vehicle using a Tesla Supercharger or Destination Charging location, all of which can be located through the map on your vehicle's touchscreen display. See [Maps and Navigation on page 143](#) for more details. Additional third-party charging stations may also be available in your area to help you to pinpoint the issue.

For more information on troubleshooting Mobile Connector status lights and charging issues, refer to the [product's owner's manual](#).



(UMC_w017)

Charge rate reduced - Wall plug temperature high Wall outlet and wiring inspection recommended

High temperature detected by Mobile Connector alerts indicate the outlet used to charge is becoming too warm, so charging has been slowed to protect the outlet.

This is not typically an issue with your vehicle or your Mobile Connector, but rather an issue with the outlet. A warm outlet may be caused by a plug that is not fully inserted, a loose building wiring connection to the outlet, or an outlet that is beginning to wear out.

To regain normal charge speed, make sure your adapter is fully plugged into the outlet. If charging speed does not return to normal, contact an electrician to inspect the outlet and building wiring connections to the outlet and complete any repairs needed.

If the outlet is worn, it should be replaced with a high-quality outlet. Consider upgrading to a Tesla Wall Connector for greater convenience and highest charging speed.

A

ABS (Anti-lock Braking System): [67](#)
absolute speed limit: [130](#)
access panel, removing: [195](#)
accessories: [23](#)
 plugging into power socket: [23](#)
accessory carrier: [82](#)
adaptive headlights: [58](#)
adjacent lane speed: [101](#)
aero covers: [186](#)
air conditioning: [138](#)
air filter: [141](#)
air suspension: [157](#)
airbags: [42](#)
alarm: [161](#)
all-season tires: [188](#)
always connected, setting: [78](#)
Always Show Estimated Round Trip Energy: [147](#)
anti-lock braking (ABS): [67](#)
apps: [5](#)
Arcade: [151](#)
audio: [50](#), [148](#), [151](#)
 playing files: [148](#), [151](#)
 settings: [148](#)
 steering wheel buttons: [50](#)
 volume control: [148](#)
Auto High Beam: [57](#)
Auto Lane Change: [103](#)
auto-raising suspension: [157](#)
automatic emergency braking: [128](#)
automatic navigation: [143](#)
 navigating: [143](#)
Autopark: [116](#)
autopilot: [124](#)
 side collision warning: [124](#)
Autopilot: [93](#), [96](#), [101](#), [103](#), [116](#), [118](#), [127](#), [130](#)
 Auto Lane Change: [103](#)
 automatic emergency braking: [127](#)
 Autopark: [116](#)
 Autosteer: [101](#)
 collision avoidance assist: [127](#)
 forward collision warning: [127](#)
 overtake acceleration: [96](#)
 overview: [93](#)
 speed assist: [130](#)
 speed limit warning: [130](#)
 staying within speed limits: [130](#)
 Summon: [118](#)
 Traffic-Aware Cruise Control: [96](#)

Autopilot components: [93](#)

Autosteer: [101](#)

average range: [78](#)

B

backup camera: [79](#)
Battery (high voltage): [175](#), [195](#), [207](#)
 care of: [175](#)
 coolant: [195](#)
 specifications: [207](#)
 temperature limits: [175](#)
battery (key), replacing: [9](#)
battery (low voltage): [175](#), [207](#)
 complete discharge: [175](#)
 specifications: [207](#)
bicycle carrier: [82](#)
Blind Spot Camera: [124](#)
Blind Spot Collision Warning: [124](#)
Blind Spot Collision Warning Chime: [124](#)
Bluetooth: [149](#), [154](#)
 devices, playing audio files from: [149](#)
 general information: [154](#)
 phone, pairing and using: [154](#)
body repairs: [198](#)
body touch up: [192](#)
Boombox: [152](#)
brakes: [67](#), [128](#), [195](#), [205](#)
 automatic in emergencies: [128](#)
 fluid level: [195](#)
 overview of: [67](#)
 specifications: [205](#)
Bumper Clearance (Summon): [118](#)

C

cabin air filter: [141](#)
cabin temperature control: [138](#)
Calendar: [154](#), [156](#)
calibration of doors: [8](#)
California Proposition 65: [221](#)
camera, rear-facing: [79](#)
cameras (autopilot): [93](#)
Camp: [141](#)
car cover: [192](#)
car status, displaying: [50](#), [51](#)
car washes: [190](#)
Caraoke): [149](#)
cargo area: [18](#)
cargo volume: [205](#)
carpets, cleaning: [191](#)
CCS (Combo): [174](#)



CE certifications: [223](#)
CHAdEMO: [174](#)
chains: [188](#)
change of ownership: [137](#)
charge port: [176](#)
charge port light: [177](#)
charge port manual release: [180](#)
charge port release cable: [180](#)
charging: [173](#), [174](#), [176](#)

- components and equipment: [173](#)
- instructions: [176](#)
- public charging stations: [174](#)

charging locations, finding: [146](#)
charging stations, displaying on map: [143](#)
child protection: [16](#)

- disabling rear window switches: [16](#)

child seats: [34](#)

- installing and using: [34](#)

child-protection lock: [14](#)

- disabling liftgate and rear door handles: [14](#)

cleaning: [190](#)
climate controls: [138](#)
cold weather best practices: [91](#)
collision avoidance assist: [127](#)
connecting to Wi-Fi: [168](#)
console: [21](#), [23](#), [24](#)

- cup holders: [24](#)
- low voltage power socket: [23](#)
- USB ports: [21](#)

consumption chart: [78](#)
contact information: [215](#), [223](#)

- roadside assistance: [215](#)
- Tesla: [223](#)

copyrights: [218](#)
cruise control: [96](#)
cup holders: [24](#)

D

damping, suspension: [157](#)
dashboard overview: [3](#)
Dashcam: [162](#)
data recording: [220](#)
data sharing: [220](#)
declarations of conformity: [223](#)
delivery mileage: [221](#)
devices: [21](#), [149](#)

- Bluetooth, playing audio files: [149](#)
- connecting: [21](#)

dimensions: [203](#)
Dog: [141](#)

dome (map) lights: [57](#)
door labels: [200](#)
door seals: [191](#)

- cleaning: [191](#)

Door Unlock Mode: [14](#)
doors: [8](#)
doors, opening: [8](#)
Drive: [56](#)
drive away locking: [14](#)
drive modes: [56](#)
driver: [26](#), [48](#)

- profiles: [48](#)
- seat adjustment: [26](#)

driving: [26](#), [54](#), [77](#)

- seating position: [26](#)
- starting: [54](#)
- tips to maximize range: [77](#)

E

Easter Eggs: [151](#)
Easy Entry: [28](#), [29](#)
easy entry, driver profile: [48](#)
EDR (event data recorder): [220](#)
electric parking brake: [69](#)
emergency braking: [127](#)
emergency flashers: [59](#)
Emergency Lane Departure Avoidance: [124](#)
emergency rear door opening: [15](#)
emission label: [199](#)
energy: [60](#), [68](#)

- gained from regenerative braking: [68](#)
- range information: [60](#)

Energy app: [78](#)
energy saving mode: [78](#)
energy use predictions (navigating): [147](#)
Entertainment: [151](#)
Erase & Reset: [137](#)
event data recording: [220](#)
exterior: [2](#), [57](#), [190](#), [192](#), [203](#)

- car cover: [192](#)
- cleaning: [190](#)
- dimensions: [203](#)
- lights: [57](#)
- overview: [2](#)
- polishing, touch up, & repair: [192](#)

F

factory defaults, restoring: [137](#)
factory reset: [137](#)
favorites (Media Player): [149](#)

Favorites (navigation): [143](#)
FCC certifications: [223](#)
features, downloading new: [169](#)
firmware (software) updates: [169](#)
flash drive: [162](#)
flashers, warning: [59](#)
floor mats: [192](#)
fluids: [182](#), [195](#)
 replacement intervals: [182](#)
 reservoirs, checking: [195](#)
fog lights: [57](#)
forward collision warning: [127](#)
front and rear seats: [26](#)
front passenger detection: [44](#)
front trunk: [19](#)

G

garage doors, opening: [165](#)
gates, opening: [165](#)
GAWR: [201](#)
glovebox: [21](#)
Glovebox PIN: [161](#)
Gross Axle Weight Rating: [201](#)
Gross Vehicle Weight Rating: [201](#)
ground clearance: [203](#)
GVWR: [201](#)

H

hazard warning flashers: [59](#)
headlights: [57](#), [58](#)
 adaptive: [58](#)
 after exit: [58](#)
 high beams: [57](#)
heating: [138](#)
height adjustments (air suspension): [157](#)
height adjustments (suspension): [197](#)
 disabling (Jack mode): [197](#)
high beam headlights: [57](#)
high voltage: [173](#), [183](#), [207](#)
 Battery specifications: [207](#)
 components: [173](#)
 safety: [183](#)
hills, stopping on: [73](#)
Home: [5](#)
 button: [5](#)
 screen: [5](#)
Home location: [145](#)
HomeLink: [118](#), [165](#), [225](#)
 FCC certification: [225](#)
 programming and using: [165](#)

 when using Summon: [118](#)

hood: [19](#)
horn: [51](#)
hub caps: [186](#)

I

I'm Feeling Lucky, Hungry: [143](#)
IC certifications: [223](#)
identification labels: [199](#)
inductive phone charger: [22](#)
instant range: [78](#)
instrument panel: [60](#), [191](#)
 cleaning: [191](#)
 overview of: [60](#)
interior: [3](#), [57](#), [138](#), [191](#), [203](#)
 cleaning: [191](#)
 dimensions: [203](#)
 lights: [57](#)
 overview: [3](#)
 temperature control: [138](#)
intrusion detection: [161](#)
ISOFIX/LATCH child seats, installing: [36](#)

J

J1772: [174](#)
Jack mode: [197](#)
jacking: [197](#)

K

Keep Climate On: [141](#)
key: [8](#), [9](#), [10](#), [223](#)
 FCC and IC certifications: [223](#)
 how to use: [8](#)
 ordering extras: [10](#)
 replacing battery: [9](#)
key fob: [54](#)
 key fob not inside: [54](#)
keyless entry: [8](#)

L

label: [200](#), [201](#)
 Tire and Loading Information: [200](#)
 vehicle certification: [201](#)
lane assist: [124](#)
lane change, automatic: [103](#)
Lane Departure Avoidance: [124](#)
LATCH/ISOFIX child seats, installing: [36](#)
liftgate: [17](#)
 adjust opening height: [17](#)
 opening: [17](#)



lifting: [197](#)

lights: [57](#), [58](#), [59](#)

 adaptive headlights: [58](#)

 hazard warning: [59](#)

 headlights after exit: [58](#)

 turn signals: [58](#)

load limits: [200](#)

location tracking: [143](#)

locking and unlocking doors: [8](#)

lug nut covers: [186](#)

lumbar adjustment: [26](#)

M

maintenance: [182](#), [184](#), [190](#), [193](#), [195](#)

 brake fluid, checking: [195](#)

 cleaning: [190](#)

 daily checks: [182](#)

 fluid replacement intervals: [182](#)

 monthly checks: [182](#)

 panel, removing: [195](#)

 replacing wiper blades: [193](#)

 service intervals: [182](#)

 tires: [184](#)

 washer fluid, topping up: [195](#)

 washer jets, cleaning: [193](#)

map orientation: [143](#)

map updates: [147](#)

mats: [192](#)

media: [148](#), [151](#)

 settings: [148](#)

 sources, show and hide: [148](#)

mileage upon delivery: [221](#)

mirrors: [53](#)

mobile app: [171](#)

mobile app access: [171](#)

Mobile Connector: [174](#), [176](#)

 description: [174](#)

 using: [176](#)

modifications: [198](#)

motor specifications: [205](#)

My Apps: [7](#)

my car does what?: [151](#)

N

Navigate on Autopilot: [106](#)

NCC certifications: [223](#)

Neutral: [56](#)

NHTSA, contacting: [223](#)

O

Obstacle-Aware Acceleration: [127](#)

occupancy sensor: [44](#)

occupant classification: [45](#)

odometer: [76](#)

Off-Peak Charging: [179](#)

offset from speed limit: [130](#)

Online Routing: [147](#)

overhang dimensions: [203](#)

overtake acceleration: [96](#)

Owner Information, about: [218](#)

P

Park: [56](#)

Park Assist: [71](#)

parking brake: [69](#)

parking, using Autopark: [116](#)

parking, using Summon: [118](#)

parking, when towing a trailer: [87](#)

parts replacement: [198](#)

passenger detection: [44](#)

passenger front airbag: [44](#)

pedestrian warning: [80](#)

personal data, erasing: [137](#)

phone: [51](#), [154](#)

 steering wheel buttons: [51](#)

 using: [154](#)

phone app: [155](#)

PIN: [48](#)

PIN to Drive: [161](#)

power cycling: [54](#)

power management: [78](#)

power socket: [23](#)

power windows: [16](#)

powered liftgate: [14](#)

powering on and off: [54](#)

Preconditioning: [179](#)

Proposition 65: [221](#)

public charging stations: [174](#)

R

radio: [148](#), [151](#)

Radio Frequency information: [223](#)

range: [60](#), [68](#), [77](#)

 displayed on instrument panel: [60](#)

 driving tips to maximize: [77](#)

 regenerative braking: [68](#)

range assurance: [78](#)

Range mode: [77](#)

Re-route: [147](#)
rear seats, accessing: [28, 29](#)
rear view camera: [79](#)
rear window switches, disabling: [16](#)
recent (Media Player): [149](#)
Recents (navigation): [143](#)
recording: [162](#)
regenerative braking: [68](#)
relative speed limit: [130](#)
release notes: [169](#)
restarting the touchscreen: [54](#)
Reverse: [56](#)
RFID transponders: [198](#)
ride height (air suspension): [157](#)
roadside assistance: [215](#)
rotating tires: [185](#)
Round Trip Energy (navigating): [147](#)

S

safety defects, reporting: [223](#)
safety information: [33, 41, 47](#)
 airbags: [47](#)
 child seats: [41](#)
 seat belts: [33](#)
Schedule: [179](#)
schedule service: [171](#)
scheduled charging: [179](#)
scheduled departure: [179](#)
 using: [179](#)
seat belts: [31, 32, 191](#)
 cleaning: [191](#)
 in a collision: [32](#)
 overview of: [31](#)
 pre-tensioners: [32](#)
 wearing when pregnant: [32](#)
seat covers: [30](#)
seat heaters: [138](#)
seating capacity: [200](#)
seating position: [45](#)
seats: [26, 138](#)
 adjusting: [26](#)
 heaters: [138](#)
seats, second row: [27](#)
security settings: [161](#)
self-leveling: [157](#)
sensors: [93](#)
Sentry Mode: [162](#)
service data recording: [220](#)
service intervals: [182](#)
Settings, erasing: [137](#)
shifting: [56](#)
shortcuts: [7](#)
 adding to My Apps: [7](#)
Show Calendar Upon Entry: [154, 156](#)
side camera(s): [79](#)
Side Clearance (Summon): [118](#)
side collision warning: [124](#)
slip start: [70](#)
Smart Summon: [121](#)
Software Reinstall: [169](#)
software reset: [137](#)
software update preferences: [169](#)
software updates: [169](#)
specifications: [203, 205, 207](#)
 brakes: [205](#)
 cargo volume: [205](#)
 dimensions: [203](#)
 exterior: [203](#)
 High Voltage Battery: [207](#)
 interior: [203](#)
 low voltage battery: [207](#)
 motor: [205](#)
 steering: [205](#)
 subsystems: [205](#)
 suspension: [207](#)
 tires: [207](#)
 transmission: [205](#)
 wheels: [207](#)
speed assist: [130](#)
speed limit warning: [130](#)
spoiler: [81](#)
stability control: [70](#)
starting: [54](#)
steering specifications: [205](#)
steering, automatic: [101](#)
summer tires: [188](#)
Summon: [118](#)
Summon Distance: [118](#)
sun visors: [25](#)
superchargers, displaying on map: [143](#)
supercharging: [180](#)
 described: [180](#)
 idle fees: [180](#)
 pay-per-use fees: [180](#)
suspension (air): [157](#)
suspension specifications: [207](#)

T

telematics: [220](#)
temperature: [51, 60, 138, 175, 210](#)



Index

- Battery (high voltage), limits: [175](#)
 - cabin, controls for: [138](#)
 - heated: [51](#)
 - outside: [60](#)
 - tires: [210](#)
 - Teslacam: [162](#)
 - third row seats, accessing: [28](#), [29](#)
 - third row seats, folding and raising: [30](#)
 - tie-down straps: [217](#)
 - tilt/intrusion detection: [161](#)
 - Tire and Loading Information label: [200](#)
 - tire noise: [188](#)
 - Tire Pressure Monitoring System: [187](#), [225](#)
 - FCC certification: [225](#)
 - overview of: [187](#)
 - tire pressures, checking: [184](#)
 - tire pressures, displaying: [184](#)
 - tire pressures, when towing: [84](#)
 - tires: [184](#), [185](#), [187](#), [188](#), [207](#), [208](#), [210](#)
 - all-season: [188](#)
 - balancing: [185](#)
 - chains: [188](#)
 - inspecting and maintaining: [184](#)
 - pressures, displaying: [184](#)
 - pressures, how to check: [184](#)
 - quality grading: [210](#)
 - replacing: [185](#)
 - replacing a tire sensor: [187](#)
 - rotation: [185](#)
 - specification: [207](#)
 - summer: [188](#)
 - temperature grades: [210](#)
 - tire markings: [208](#)
 - traction grade: [210](#)
 - treadwear grade: [210](#)
 - wheel configuration: [184](#)
 - winter: [188](#)
 - toll system transponders, attaching: [198](#)
 - torque specifications: [205](#)
 - touch up body: [192](#)
 - touchscreen: [5](#), [7](#), [169](#), [191](#)
 - adding shortcuts: [7](#)
 - cleaning: [191](#)
 - customizing My Apps: [7](#)
 - main: [5](#)
 - rear: [5](#)
 - software updates: [169](#)
 - touchscreens: [5](#)
 - overview of: [5](#)
 - tow eye, locating: [216](#)
 - tow hitch, connecting: [87](#)
 - tow hitch, disconnecting: [88](#)
 - towing: [215](#)
 - towing a trailer: [82](#)
 - towing capacity: [83](#)
 - towing guidelines: [86](#)
 - towing instructions: [215](#)
 - Towing Label: [200](#)
 - Toybox: [151](#)
 - TPMS: [187](#), [225](#)
 - FCC certification: [225](#)
 - overview of: [187](#)
 - Tracking Disabled: [143](#)
 - traction control: [70](#)
 - trademarks: [218](#)
 - Traffic Light and Stop Sign Control: [109](#)
 - Traffic-Aware Cruise Control: [96](#)
 - Trailer Brakes for towing: [85](#)
 - Trailer Mode: [84](#)
 - trailer, towing: [82](#)
 - transmission specifications: [205](#)
 - transponders, attaching: [198](#)
 - Transport Canada, contacting: [223](#)
 - Transport Mode: [216](#)
 - transporting: [215](#)
 - trip chart: [78](#)
 - trip meter: [76](#)
 - Trip Planner: [147](#)
 - trunk, front: [19](#)
 - trunk, rear: [14](#), [17](#)
 - child lock: [14](#)
 - disabling interior handle: [14](#)
 - turn signals: [58](#)
- ## U
- ultrasonic sensors: [93](#)
 - uniform tire quality grading: [210](#)
 - Unlock on Park: [8](#)
 - unlocking when key fob doesn't work: [14](#)
 - USB devices: [21](#)
 - connecting: [21](#)
 - USB flash drive: [161](#), [162](#)
 - USB ports: [21](#)
- ## V
- Valet mode: [48](#)
 - vehicle certification label: [201](#)
 - Vehicle Hold: [73](#)
 - Vehicle Identification Number (VIN): [199](#)
 - vehicle loading: [200](#)



View Live Camera: [162](#)
voice commands: [159](#)
volume control: [5](#)
volume control (media): [148](#)

W

Walk-Away Door Lock: [14](#)
Wall Connector: [174](#)
warning flashers: [59](#)
washer fluid, topping up: [195](#)
washer jets, cleaning: [193](#)
washers, using: [66](#)
wheel chocks: [217](#)
wheels: [185](#), [186](#), [207](#)
 aero covers, removing and installing: [186](#)
 alignment: [185](#)
 lug nut covers, removing and installing: [186](#)
 replacing: [185](#)
 specifications: [207](#)
 torque: [207](#)
Wi-Fi, connecting to: [168](#)
windshield washer fluid, topping up: [195](#)
winter tires: [188](#)
wiper blades, replacing: [193](#)
wiper defrosters: [66](#)
wipers, defrosting: [66](#)
wipers, using: [66](#)
wireless phone charger: [22](#)
Work location: [145](#)

TESLA

Publication date: 2022/4/14