



TESLA



ClipperCreek Inc.

Users Manual

HOME CONNECTOR

Table of Contents

Safety and regulatory information	
Warnings and cautions	1
FCC Declaration of Conformity	1
Features and specifications	
Features	2
Specifications	3
Utility service connections	
120V above ground	4
230V above ground	6
Installation	
Installing the Home Connector	7
Electrical connection	
120V above ground	8
230V above ground	9
Post-installation testing	
Confirming a successful installation	10
Operating instructions	
Home connector front panel	11
Front panel indicator lights	11
In case of difficulty	12
Vehicle charging instructions	12
Maintenance, Warranty, and Service	
Maintenance	13
Warranty	13
Customer service	13
For the service technician	
GFCI (CCID) trip	14
Ground missing	14

SAVE THESE IMPORTANT SAFETY INSTRUCTIONS

This manual contains important instructions that must be followed during the installation, operation, and maintenance of the Home Connector.

Warnings and cautions

 **WARNING:** The Home Connector must be installed by a qualified electrician and in accordance with all local electrical codes and ordinances. ▲

 **WARNING:** The Home Connector must be grounded through a permanent wiring system or an equipment grounding conductor. Failure to properly ground the Home Connector could result in fire, serious injury, or death. ▲

 **WARNING:** Do not install the Home Connector near flammable, explosive, or combustible materials. ▲

 **WARNING:** Do not operate a Home Connector with a visibly damaged cable. Contact Tesla Motors immediately. ▲

 **WARNING:** The Home Connector contains no user-serviceable parts. Do not attempt to repair or service the Home Connector yourself. If the Home Connector requires servicing, contact Tesla Motors. ▲

 **Caution:** When transporting the Home Connector, handle with care to prevent its internal components from being damaged.

 **Caution:** Incorrect installation and testing of the Home Connector could result in damage to the vehicle's Battery and to the Home Connector itself. These damages will void the warranty for the vehicle and the Home Connector.

 **Caution:** Do not operate the Home Connector in temperatures outside its operating range of -40°F to 122°F (-40°C to +50°C).

 **Caution:** Ensure that the Home Connector's charge cable is positioned so it will not be stepped on, tripped over, or subjected to damage or stress.

Environmental considerations

 At the end of its life, this product should be recycled according to local laws and regulations. Contact Tesla Motors for recycling information.

Product specification

All specifications and descriptions are accurate at the time of printing. Because improvement is a constant goal at Tesla Motors, we reserve the right to make changes at any time, without notice and without obligation.

FCC Declaration of Conformity

This device complies with Part 15 of the FCC rules. Operation is subject to the following two conditions: (1) This device may not cause harmful interference, and (2) this device must accept any interference received, including interference that may cause undesired operation.

Radio and television interference

The equipment described in this manual has been designed to protect against Radio Frequency Interference (RFI). However, there are some instances where high powered radio signals or nearby RF-producing equipment (such as digital phones, RF communications equipment, etc.) could affect operations.

If interference to your Home Connector is suspected, relocate or turn off nearby electrical appliances during charging, before contacting Tesla Motors for assistance.

Important!

Changes or modifications to this product not authorized by Tesla Motors could void the FCC compliance.

Features and specifications

Features

The Home Connector features ground fault protection with self-testing and auto-reclosure (see below).

Note: Manual resetting or testing is not required.

Ground monitoring circuit

The Home Connector features a ground monitoring circuit that continuously checks for the presence of a safe ground connection.

Auto-reclosure

If a problem occurs that interrupts charging, the Home Connector will automatically clear the error condition and re-attempt charging.

If a problem is immediately sensed a second time, the Home Connector will wait 13 minutes before re-attempting to charge. This process will repeat several times.

After several unsuccessful attempts, no further charging attempts will be made and the appropriate front panel indicator light will be illuminated to indicate the nature of the failure (see Front panel indicator lights, page 11).

This feature helps to ensure that your vehicle will be charged and ready for use when needed. Temporary problems such

as ground faults or utility power surges will be overcome automatically, without your attention.

Cold load pickup

This feature is activated if the utility power fails during charging.

Providing the charging cable is plugged into the vehicle when utility power is restored, the Amber **CHARGING** light will blink and the unit will delay energizing the cable for a period between 2 and 12 minutes. This prevents the utility grid from experiencing a large surge at turn-on, allowing electric vehicles in the area to begin drawing current at random times, rather than all at once.

If desired, you can manually resume charging by pressing and holding the **START** button on the front panel.

Note: If a power outage occurs, the Home Connector will automatically try to resume charging when power is restored.

Specifications

Voltage and wiring (120V above ground)	240V AC <i>single-phase</i> : L1, L2, and Safety Ground
	208V AC <i>3-phase, wye-connected</i> : Any 2 phases, and safety ground.
	240V AC <i>3-phase, delta-connected</i> : With center tap on one leg, use only the two phases on either side of the center tap. The two phases must both measure 120V AC to ground. Do not use the third leg (208V "stinger").
Voltage and wiring (230V above ground)	230V AC <i>single-phase</i> : LINE, NEUTRAL, and EARTH.
Current and frequency	90A Circuit Breaker. The maximum current for the vehicle is 70A. At 240V, this will be 17 kW maximum. At 230V, this will be 16 kW maximum. The frequency is 50-60 Hz.
Cable length	Approximately 25' (7.6 m)
Dimensions	Height: 14" (363 mm) Width: 17" (432 mm) Depth: 6" (152 mm)
Weight	Weight: 47 lbs (21 kg)
Operating temperature	-40°F to 122°F -40°C to 50°C
Ratings and agency approvals	NEMA 4 - outdoor use, watertight. UL and CSA approved. CE compliant. FCC Part 15 compliant.

Utility service connections

120V above ground

! WARNING: The Home Connector is a single-phase device. Do not connect all 3 phases of a 3-phase feed. ▲

The following types of service connection are primarily used in North America.

IMPORTANT! Before commencing on the installation of the Home Connector it is important you correctly identify the type of utility service connection available on site. If you are unsure about the type of connection available at the service panel, consult the local utility company, or contact Tesla Motors for assistance.

Only three wires are connected, but care must be taken that the service transformer secondary connection is definitely known, and the three wires from the main circuit breaker panel are correctly connected and labeled. The illustrations in this section show the most commonly used wiring formats.

Note: The L1, L2, and GND outputs in the following illustrations correspond to the inputs on the Home Connector.

Ground (Earth) connection

Always connect the Neutral at the service to earth ground. Ground fault protection is not possible unless the Neutral (center tap on the service transformer) is connected to an earth ground.

If ground is not provided by the electrical service, you must install a grounding stake nearby.

The grounding stake must be connected to the ground bar in the main breaker panel, and Neutral connected to ground at that point.

! WARNING: Always follow local electrical codes when installing the grounding stake. ▲

220/240V Single Phase

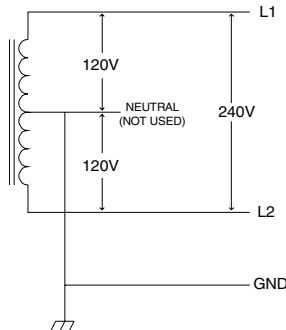

208V 3-Phase, wye-connected

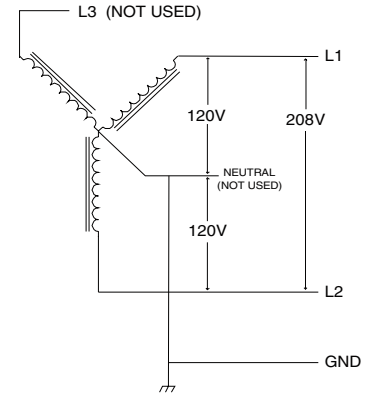

With a wye-connected secondary, any two of the legs can be used to provide 208V to the Home Connector. For example, L1 and L2, or L1 and L3, or L2 and L3.

! Caution: The unused leg (L3 in the illustration) must remain open. Do not connect to a Neutral bar, or to Ground.

The two used phases must each measure 120V to Neutral.

! Caution: The center point of the 3 phases (normally used as Neutral) must be grounded to earth at only one point. This is usually at the Service Entry Breaker Panel

Note: A current-carrying Neutral is not required.

240V 3-Phase, delta-connected, with center tap on one leg

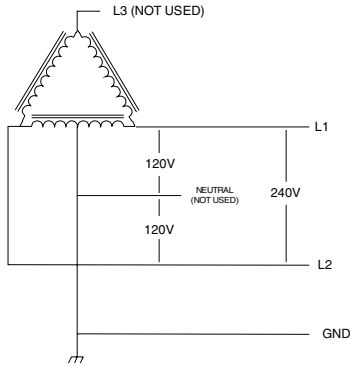

With the delta connection, one leg must be center tapped, and only the two phases on either side of the center tap can be used.

! The third line (L3 in the illustration) of the delta is 208V, with respect to neutral, and is sometimes referred to as a “stinger.” Do not use this third line.

The two used phases must each measure 120V to neutral.

Consult the transformer manufacturer’s literature to verify that the single leg can supply the required power.

! Caution: Do not use a 3-phase delta-connected transformer secondary without a center tap on one leg. No “neutral” point is available for the required ground connection.

Note: The Home Connector’s contactor will only close if it detects the presence of a ground wire connected to a neutral point on the transformer secondary.

Utility service connections

230V above ground

! WARNING: The Home Connector is a single-phase device. ▲

The following types of service connection are primarily used in Europe and Australia (sometimes known as “TT Power Grid”).

IMPORTANT! Before commencing on the installation of the Home Connector it is important you correctly identify the type of utility service connection available on site. If you are unsure about the type of connection available at the service panel, consult the local utility company, or contact Tesla Motors for assistance.

When connecting the Line and Neutral wires, care must be taken that the service transformer secondary connection is definitely known, and the wires from the main circuit breaker panel are correctly connected and labeled. The illustration provided on this page shows the most commonly used wiring format in Europe.

Note: The LINE, NEUTRAL, and EARTH outputs on the following illustration correspond to the inputs on the Home Connector.

Ground (Earth) connection

Always connect the Neutral line at the service panel to Earth. Ground fault protection is not possible unless the Neutral line is connected to Earth.

If an Earth connection is not available, you must install a grounding stake nearby.

The grounding stake must be connected to the ground bar in the main breaker panel, and Neutral connected to Earth at that point.

! WARNING: Always follow local electrical codes when installing the grounding stake. ▲

230V Single Phase

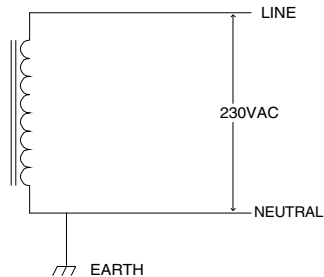

! Caution: The LINE connection must measure 230V RMS to NEUTRAL. EARTH must also be connected to the Home Connector.

Installing the Home Connector

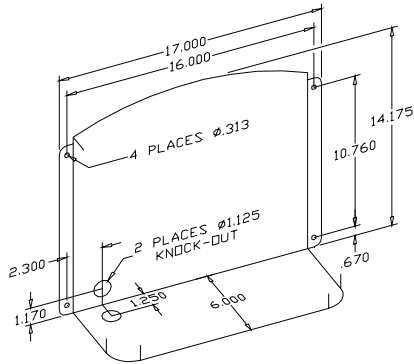

Note: Dimensions above are shown in inches. 1 inch = 2.54 cm.

1. Locate the wall mounting position:
 - The bottom of the Home Connector must be positioned 38 inches (1 meter) above the ground.
 - The mounting holes are spaced 16" (40.6 cm) apart to accommodate wall studs.

In the absence of solid structural framing, you must provide an adequate mounting surface.

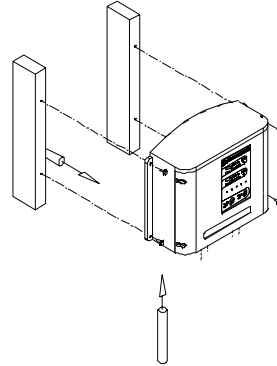

2. Attach the Home Connector to the wall studs using four 1/4" x 2 1/2" (M6) lag screws. The length of the screws must be adequate to securely anchor the Home Connector.
If mounting on a concrete wall, use a multi-set (or equivalent).
3. Remove the applicable power entry knock-out from the Home Connector, push the power leads through the hole, then connect the power conduit to the hole.

Continue the installation by following the electrical connection procedure, provided next.

Electrical connection

120V above ground

! WARNING: Before commencing any electrical installation, always make sure that the electricity supply has been isolated at the main circuit breaker panel. ▲

Note: The following connection details described here are primarily used in North America.

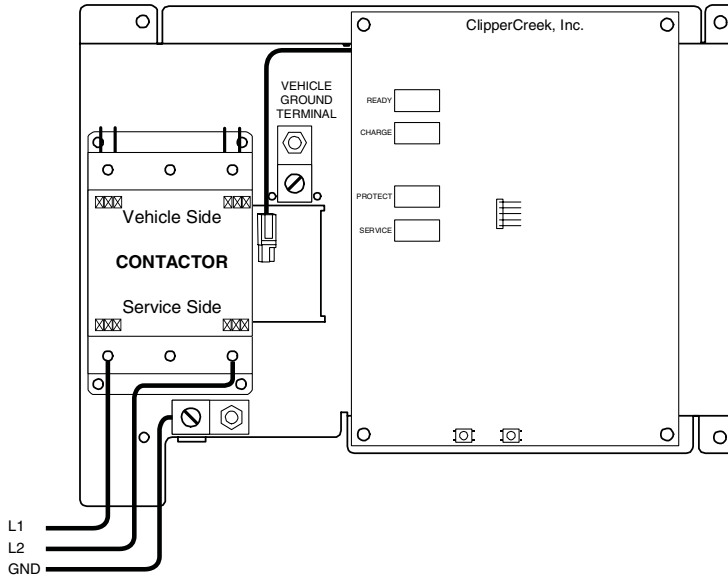

To access the electrical connections, open the enclosure by removing the two screws on the left-hand side using a T15 Torx L driver. Then unhook the latch located on the bottom of the unit (over the cable holder).

! Caution: Before connecting any wires, make sure you have identified the type of utility service connection available. For more information, refer to Utility service connections, page 4.

Note:

- The Home Connector requires a dedicated 208/240 VAC 60 Hz, single-phase circuit, with its own 90A circuit breaker.
- Do not use a GFCI breaker. The Home Connector contains a Personal Protection circuit specifically designed for use with electric vehicles.
- Only 3 wires are required (L1, L2 and GND), as shown in the illustration. For branch circuits of 90A, use 4 AWG, 75°C copper wire. For installations less than 90A, use conductors sized according to Table 310.16 of NEC, or in accordance with local electrical codes.
- The two phases (L1 and L2) are terminated on the input side of the CONTACTOR. The ground (GND) is terminated on the Ground Terminal at the bottom of the enclosure.
- Be careful not to damage the PC Board when removing the power entry knock-out, attaching the conduit, or when wiring the service conductors to the contactor.

Installation is complete. Before securing the enclosure, perform the post-installation testing procedure described on page 10.

230V above ground

⚠ WARNING: Before commencing any electrical installation, always make sure that the electricity supply has been isolated at the main circuit breaker panel. ▲

Note: The following connection details described here are primarily used in Europe and Australia.

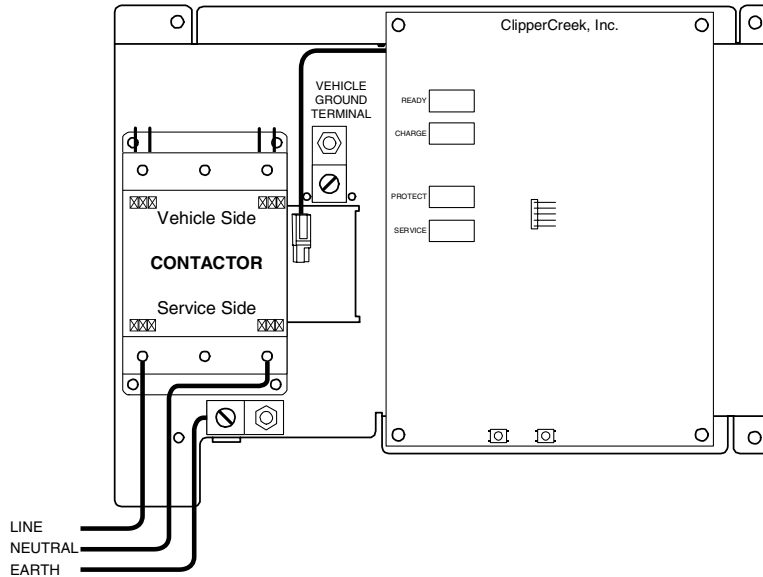

To access the electrical connections, open the enclosure by removing the two screws on the left-hand side using a T15 Torx L driver. Then unhook the latch located on the bottom of the unit (over the cable holder).

⚠ Caution: Before connecting any wires, make sure you have identified the type of utility service connection available. For more information, refer to Utility service connections, page 4.

Note:

- The Home Connector requires a dedicated 230 VAC 50Hz, single-phase circuit, with its own 90A circuit breaker.
- Do not use a GFCI breaker. The Home Connector contains a Personal Protection circuit specifically designed for use with electric vehicles.
- Only 3 wires are required (LINE, NEUTRAL, and EARTH), as shown in the illustration.

For branch circuits of 90A, use 4 AWG, 75°C copper wire. For installations less than 90A, use conductors sized according to local electrical codes.

- The LINE and NEUTRAL lines are terminated on the input side of the contactor. The EARTH line is terminated on the Service Earth terminal at the bottom of the enclosure.
- Be careful not to damage the PC Board when removing the power entry knock-out, attaching the conduit, or when wiring the service conductors to the contactor.

Installation is complete. Before securing the enclosure, perform the post-installation testing procedure described on page 10.

Post-installation testing

Confirming a successful installation

Apply utility power and observe that only the green **READY** light illuminates.

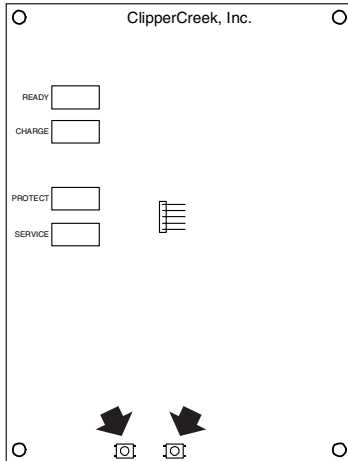

Two "Charge Test" buttons on the PC board (arrowed in illustration) simulate connection to a vehicle.

Push both buttons at the same time and verify that the contactor closes, and the amber **CHARGING** light illuminates.

If a vehicle is available, connect the Home Connector to the vehicle and verify that the contactor closes, and the amber **CHARGING** light illuminates.

Once a successful installation has been confirmed, close the Home Connector's enclosure door and secure the latch. Reinsert the two Torx screws on the left-hand side and hand tighten them with a T15 Torx L driver until snug.

Home connector front panel

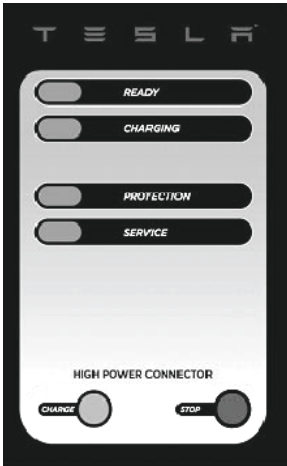

The front panel on the Home Connector has four indicator lights:

- **READY** - illuminates green to indicate that the unit is receiving power.
- **CHARGING** - illuminates amber when a vehicle is being charged.
To stop charging, push the **STOP** button on the bottom of the panel before disconnecting the charge cable from the vehicle.
- **PROTECTION** - illuminates red if a fault has occurred.
- **SERVICE** - illuminates red if a fault has occurred.

Front panel indicator lights

GREEN READY LIGHT	AMBER CHARGING LIGHT	RED PROTECTION LIGHT	RED SERVICE LIGHT	CONDITION
OFF	OFF	OFF	OFF	No service power
ON	OFF	OFF	OFF	Home Connector has power but the vehicle is either not connected, or has not requested a charge
ON	ON	OFF	OFF	Vehicle is charging
ON	Blinking	OFF	OFF	Cold load pick-up mode (see page 2). To bypass, press the START button on the Home Connector's front panel.
ON	OFF	OFF	ON (Steady)	Ground monitor interrupt
ON	OFF	ON (Steady)	OFF	Charging fault on vehicle
ON	OFF	1 Blink	OFF	Ground fault on vehicle
ON	OFF	2 or more Blinks	2 or more Blinks	Service needed. Contact Tesla Motors.

Operating instructions

In case of difficulty

Tesla Motors understands that you will rely heavily on the Home Connector to charge your Roadster. Therefore, should problems arise, every effort will be made to restore service as soon as possible. To minimize unnecessary wait time if charging stops and either the red **PROTECTION** or red **SERVICE** lights illuminate, follow these steps before contacting Tesla Motors:

- Press the **START** button the Home Connector's front panel to restart charging.
- If the red **PROTECTION** or **SERVICE** light remains illuminated, unplug the vehicle. If the red light goes out, plug the vehicle back in and see if charging begins normally.
- If charging does not begin normally and the red **PROTECTION** or **SERVICE** light continues to illuminate, unplug the vehicle and switch power off at the circuit breaker. Wait a few seconds and switch the breaker back on again. If the **PROTECTION** or **SERVICE** light does not come back on, plug the vehicle back in. Charging should begin normally.

If charging does not begin after following these steps, contact Tesla Motors.

Vehicle charging instructions

For detailed information on how to charge your Tesla Roadster, refer to the 'Owner's Manual'.

Maintenance

 **WARNING:** The Home Connector has no user-serviceable components within it. If the unit is not operating correctly, please contact Tesla Motors. ▲

The Home Connector requires no periodic maintenance other than the occasional cleaning.

Always ensure that after charging, the charging cable is returned to the cable hanger and the charging connector is clear of the floor.

Regularly inspect the Home Connector and charging cable for signs of damage. If damage is found, contact Tesla Motors.

Cleaning Instructions

 **WARNING:** Turn off input power at the circuit breaker before cleaning the Home Connector. ▲

 **WARNING:** Do not use cleaning solvents, scouring powder, or any type of abrasive pad to clean the Home Connector, its charging cable or the vehicle's charging port. ▲

 **WARNING:** To reduce the risk of electrical shock or equipment damage, do not allow liquid to enter the Home Connector while cleaning it. ▲

The outside of the Home Connector, the charging cable, and the connector end of the charging cable should be regularly cleaned with a clean dry or damp cloth to remove any accumulation of dust and dirt.

Warranty

The Home Connector is covered by a one year parts and labor warranty. For a detailed description of this warranty, contact Tesla Motors.

Customer service

To obtain service for your Home Connector, contact Tesla Motors. Have the model and serial number ready. These can be found on the label attached to the side of the enclosure.

For the service technician

GFCI (CCID) trip

If the Home Connector detects a ground fault, the contactor will open and the front panel's red **PROTECTION** light will illuminate. The system waits 13 minutes after sensing a fault, then automatically attempts recovery. After several such attempts, the Home Connector will stay in the **PROTECTION** mode and the red **PROTECTION** light will blink continuously.

If a ground fault error or an electric vehicle connection error has been detected, follow these steps:

1. Unplug the vehicle.
2. Inspect the connector and the vehicle's charge port to verify they are clean and undamaged. If necessary remove any accumulation of dust or dirt from the charge port, or the cable connector, using a clean dry or damp cloth.
3. Plug the vehicle back in. If the fault persists, contact Tesla Motors for assistance.

Ground missing

When the Home Connector detects a missing Service Ground (Earth connection), the red **SERVICE** light on the front panel will illuminate. The Home Connector's contactor will not close until a proper Service Ground (Earth connection) has been detected.

[TESLAMOTORS.COM](https://teslamotors.com)
