

This manual is for reference and historical purposes, all rights reserved.

**This page is copyright© by M. Butkus, NJ.**

This page may not be sold or distributed without the expressed permission of the producer

I have no connection with any camera company

On-line camera manual library

This is the full text and images from the manual. This may take 3 full minutes for the PDF file to download.

**If you find this manual useful, how about a donation of \$3 to: M. Butkus, 29 Lake Ave., High Bridge, NJ 08829-1701 and send your e-mail address so I can thank you. Most other places would charge you \$7.50 for a electronic copy or \$18.00 for a hard to read Xerox copy.**

**This will allow me to continue to buy new manuals and pay their shipping costs.**

**It'll make you feel better, won't it?**

**If you use Pay Pal or wish to use your credit card,  
click on the secure site on my main page.**

**Voigtländer**



**BESSAMATIC**

24 x 36  
35 mm

**INSTRUCTIONS FOR USE**

## Right Here

is the most important piece of advice of this instruction booklet. We have prepared it with a great deal of care to show everything in the clearest possible way. So please read this booklet carefully before you load your first film and begin to take pictures.

First of all make yourself thoroughly familiar with the camera. When studying the instructions, open up the four folded cover pages to the top and bottom. You will find there a clear view of all the controls. Look at these pages while you practise the various operations with the empty camera.

Remember also that the BESSAMATIC is very robust, but nevertheless an optical and mechanical precision instrument. It therefore requires gentle and sensible treatment. The camera will repay careful handling with beautifully clear and sharp pictures for many years to come.

VOIGTLÄNDER A. G. BRAUNSCHWEIG

# BESSAMATIC

24 x 36 · 35 mm

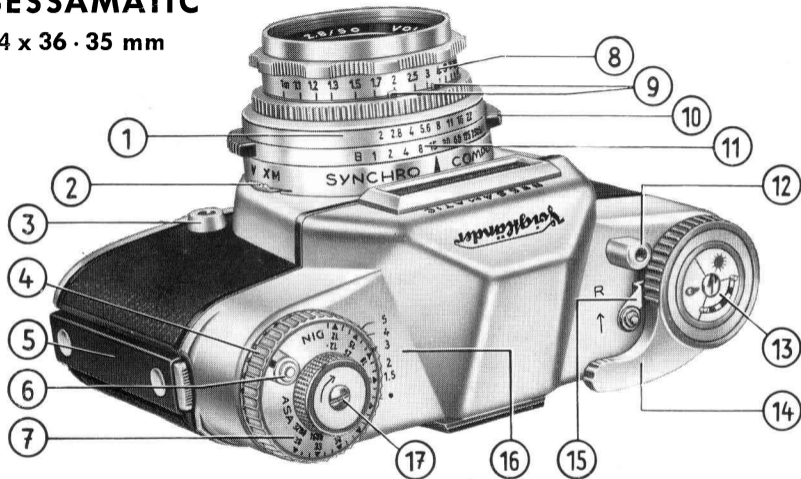

Illustration I

- 1 Aperture ring**
- 2 Synchronizing lever**  
for M or X synchronization and  
self-timer (V)
- 3 Flash socket**
- 4 Setting knob**  
for exposure meter readings
- 5 Locking device for camera back**
- 6 Interlocking lever** for disc 7
- 7 Setting disc** for film speed
- 8 Distance scale**
- 9 Depth of field indicator**
- 10 Rotating handles for shutter ring 11**
- 11 Shutter ring**
- 12 Release button**  
with cable release socket
- 13 Film type indicator**
- 14 Rapid winding lever**  
for tensioning the shutter and  
advancing the film
- 15 Reversing lever**
- 16 Divisions**  
for filter factors
- 17 Film rewind knob**
- 18 Locking catch**  
for the synchronizing lever
- 19 Lens changing catch**
- 20 Honeycomb cell window**  
of the photo-electric exposure meter



Illustration II

## Contents

### To start with, loading the film

	Page
Setting the film speed .....	2
and the film type indicator .....	3
Setting the film counter .....	5
Inserting the film cassette .....	6
Getting ready for the first exposure – the rapid winder ..	7
Unloading – changing partly exposed films .....	8

### Then, taking the picture

Viewing through the finder .....	9
Setting the exposure .....	10–11
Setting the distance .....	12
Holding the camera and releasing .....	13
The interchangeable lenses and their handling .....	14
Aperture and depth of field .....	15

### And a few hints

Flash shots .....	16–19
Filters and Focar lenses .....	20–22
Right angle finder and accessory shoe – portrait attachment .....	23
Hints for exposure and colour shots .....	24–26
Selftimer – double exposure “at will” .....	27
Universal case for BESSAMATIC .....	28

## Setting the Film Speed

Make it a rule: Always set the film speed before inserting the film, because the function of the automatic exposure control depends on that.

On the setting knob (4) you will find the film speed values according to DIN and ASA, as indicated on the film package. To set the speed, pull out the rewind knob (17) completely (illustration III on off-folded cover page), pull the interlocking device (6) outwards and turn setting disc (7) to the left or right to bring the required film speed value opposite the red index mark on the milled rim of the knob.

Special setting marks are provided for ASA value 10 and 32: The point before figure 12 corresponds to 10 ASA, the point behind figure 25 to 32 ASA.



5  
4  
3  
2  
1.5

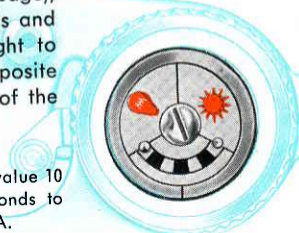



## The Film Type Indicator

serves to remind you of the type of film you have loaded in your camera. It has no effect on the exposure itself.

To set it, turn disc (13) till the sector with the corresponding film symbol is situated opposite the black mark.

**These are the symbols for the three film types:**

-  = **Black-and-white film**
-  = **Colour film for daylight**
-  = **Colour film for artificial light**



## Loading the Camera

You may use in your BESSAMATIC camera all types of films commercially available – wherever you buy it.

The daylight cassettes with the perforated 35 mm black-and-white, colour negative, or colour reversal film supply 36 or 20 exposures sized 24 x 36 mm.

Although the cassettes are light-tight, it is advisable not to expose them to strong light. Make a point therefore of always loading and unloading the camera in the shade – even the shadow of your own body will do.



## Opening the Camera Back

Press together both spring catches (5) and swing open the back.

## Setting the Film Counter

The film counter automatically shows the number of exposures still available at any time. It therefore runs backwards from No. 36 or No. 20 (in other words the first exposure) to No. 1. Always set the film counter before loading the camera.

Move the reversing lever (15) in the direction of the arrow towards "R". This permits the transport shaft (26) to turn freely in either direction. Now turn the shaft to the left or to the right by the milled centre until the  $\blacklozenge$  mark (36-exposure cassettes) appears in the window (24) below the white index line. With 20-exposure cassettes set the  $\odot$  mark to the white line.

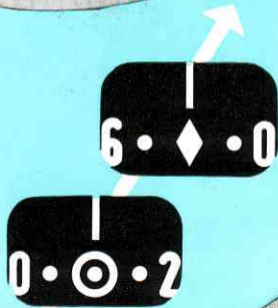
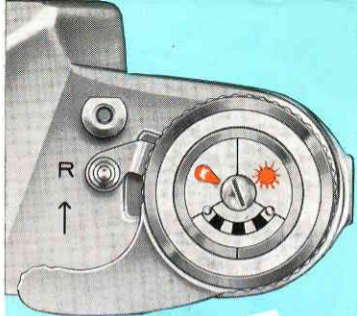

## Inserting the Cassette . . .

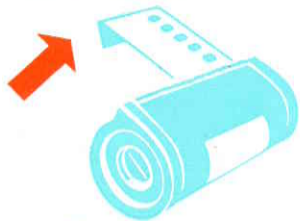

Fully pull out the rewind knob (17) as shown in illustration III of the open cover, and turn the take-up spool (25) so that the long slit is on top.

Sharply fold back about  $\frac{3}{8}$  inch of the beginning of the film, and push it into the slot up to the fold. The film edge must lie close against the spool flange (see illustration).

Draw the filmcassette across the film track (23) and insert it in the cassette chamber (22). Push back the rewind knob (17), turning it slightly if necessary to make the shaft (28) engage the cassette core.

The film should now lie flat in the film track as shown in illustration IV. Make sure that the lower sprocket of the transport shaft (30) engages the perforation holes of the film. Finally close the camera back – both catches must engage firmly.

## ... getting Ready for the First Exposure

Swing the rapid winder (14) **as far as it will go**. At the same time the reversing lever (15) at "R" is pushed back into its original position. Then alternately operate the release (12) and the rapid winder until No. 36 or No. 20 respectively appears in the film counter window.

## The Rapid Winder

must always be pulled **right through** – it will then fly back automatically. This movement tensions the shutter, brings down the mirror into the optical path of the finder, advances the film by one frame, and also advances the film counter.

An interlocking mechanism prevents a second operation of the rapid winder before making an exposure. Similarly the finder image re-appears – and the shutter can be released – only after operating the rapid winder. You will find a hint on "double exposure at will" (trick shots on page 27).

If the rapid winder is locked to start with, (in other words the shutter is still tensioned), first press the release.

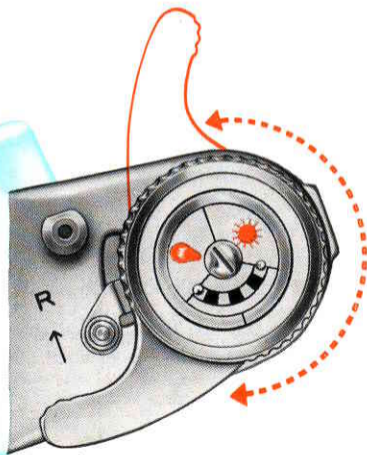

## Unloading the Camera

Push the reversing lever (15) to R, and pull up the rewind knob (17) **to its first stop only** (see illustration). Then turn the rewind knob in the direction of the arrow until the diamond  $\blacklozenge$  mark (with a 36-exposure film) or the  $\odot$  mark (with a 20-exposure film) appears again in the film counter window. Now you can open the camera back. Fully pull out the rewind knob and remove the cassette with the exposed film from the film chamber.

When trying to obtain more than 36 or 20 exposures from your film, it may happen that the rapid winder cannot be swung completely and that it blocks. In this case do not apply force, otherwise you will tear the perforation or make the film slip out of the cassette. Proceed as follows: Push rewind knob towards R (it may move a bit harder), swing rapid winder completely and let it return to its original position. Unload the camera as described above.

## Changing Partly Exposed Films

Rewind the partly exposed film as described above. Remember also to make a note of the number of the last exposed frame, and to re-set the DIN-ASA disc and the film type indicator if necessary. When re-loading the original film, first of all put the black lens cap over the front lens mount. Then insert the film in the usual way and alternately work the rapid winder and press the release until the number of the frame you originally noted appears in the film counter window. Advance the film once more, and you can carry on shooting.

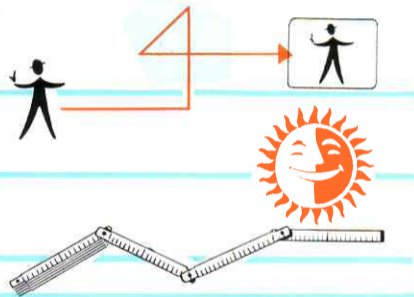

The finder image is only visible when you have operated the rapid winder, thus advancing the film and tensioning the shutter. You therefore see immediately whether the camera is ready to shoot.

## With one Look through the Viewfinder

– through the large and bright double system view- and rangefinder of the BESSAMATIC

- you see the subject upright, right-way-round, and free from parallax, with the precise field of view covered by the film –
- you control the exposure by means of the exposure automatic,
- you accurately focus all interchangeable lenses either with the optical split-image rangefinder or with the ground glass screen.

The spring-loaded pre-selecting diaphragm ensures that you view and focus always at the full lens aperture. The diaphragm automatically closes down to the pre-set value when you release the shutter.

## Setting the correct Exposure . . . quick and simple

### ① Presetting the exposure time

Turn setting knob (4) till the speed figure required is opposite mark ▲.

### ② Superimposing the two pointers

With a short turn of the setting knob you superimpose the two pointers in the viewfinder (see illustration on the right) – and right away you set the correct exposure by means of the automatic control. The illustration shows: preselected speed  $1/60$  sec. – pointers superimposed at aperture 5.6.

#### To point 1:

The **black figures** ( $1/500$ – $1/60$  sec.) are exposure times which you can safely use for hand-held shots.

With the **red figures** ( $1/30$ – $1$  sec.) it is advisable to support the camera during the exposure (e. g. on a table, trunk of a tree or tripod).

At "B" the shutter opens on pressing the release and remains open as long as you keep the button pressed down. In this case – as well as in connection with the long speeds (red figures) – always use a tripod and a cable release; the latter can be screwed into the release button.





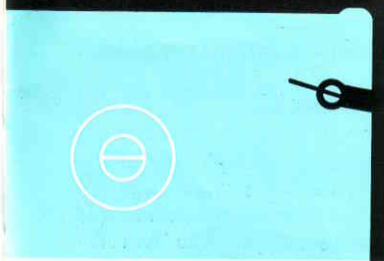

### To point 2:

when superimposing the setting mark with the lightmeter needle, the setting knob first moves only the aperture ring. However, if superimposing cannot be done this way (i. e. aperture  $f/2.8$  or  $f/22$  on Color-Skopar lens has been reached) turn the setting knob beyond a little resistance until mark and needle are aligned. Now the shutter speed has also been altered.

#### **General rules for setting the exposure:**

**Hold camera horizontal when setting the correct exposure, even when you want to shoot with the camera held upright. This way the exposure meter will render most accurate results. Special hints for determining the exposure: See page 24 and 25.**

In case the depth of field or the shutter speed are insufficient for the type of picture you wish to take proceed as follows:

Turn the shutter ring until the required aperture-speed-combination is opposite index ▲. This does not effect the correct exposure prior determined in the finder. Make sure that you stop turning the shutter ring when having reached one of the extremes of the aperture ring of the respective lens.

## Setting the Distance

You can do this in two ways:

- **In the split-image rangefinder** vertical lines of the subject are displaced to the left or right (with the camera held horizontal) or upwards and downwards (with the camera held upright) as you turn the distance scale (example I). When the lens is accurately focused the two parts of the image register accurately across the split circle (example II).
- **The ground-glass screen** is most suitable for focusing subjects without prominent vertical or horizontal lines. In this case rotate the distance scale until the subject appears sharp on the ground-glass screen.

The two red pointers (9) which move over the distance scale show you at the same time the exact depth of field (see also page 15).

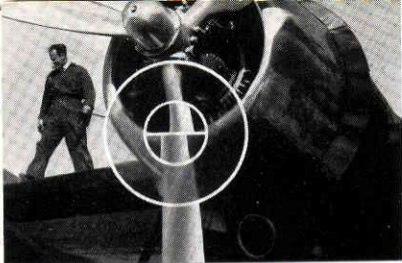

Example I

Example II

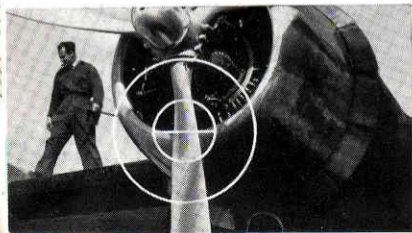

## Holding the Camera and Releasing

For the exposure we suggest that you hold the BESSAMATIC as shown in the illustrations. You can of course also hold it in any other way, provided you have a sound grip on the camera with both hands and you can comfortably press the release button.

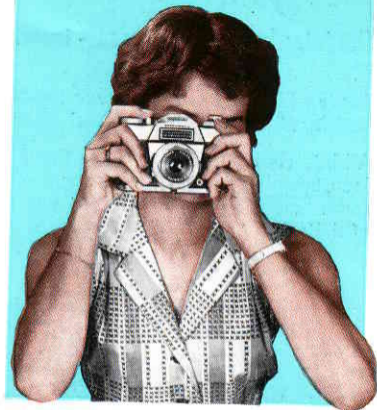

To make the exposure, smoothly depress the release button – never jerk it! The finder image disappears at the instant of the exposure and reappears again when you have operated the rapid winder.

## The interchangeable Lenses – inserting and removing

For the BESSAMATIC you may choose amongst interchangeable lenses of different speeds and focal lengths, for the most effective rendering of any subject.

All interchangeable lenses are fitted in a quick changing bayonet mount and are accurately focused with the two-way rangefinder. As the taking lens of the BESSAMATIC is at the same time also the finder lens you always see the correct view in the finder irrespective of the subject distance or the focal length of the lens used. Special instructions are available for the Voigtländer-Zoomar f/2.8 (36–82 mm).

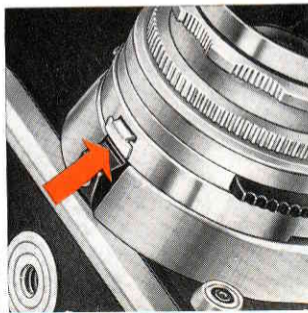
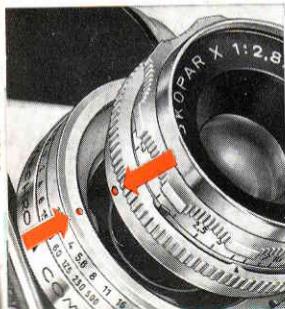

When you insert the lens in the shutter opening make sure that the red dot on the lens mount is opposite the red dot on the aperture ring (see illustration). Then turn the lens slightly to the right **until it engages** – it is now firmly mounted in the camera.

To remove the lens, depress the catch (19), turn the lens to the left, and lift it out of the shutter (see illustration).

All lenses can automatically be set to their maximum aperture only.

## - Reading the depth of field

The depth of field covers that part of the subject, in front of and behind the focused distance which is reproduced on the film with acceptable sharpness. This depth of field, however, is not permanent; it grows when stopping down and it decreases the more the lens is opened up.

Please note:

Large apertures (e. g.  $f/2.8$ )  
= smaller depth of field;

Small apertures (e. g.  $f/16$ )  
= wider depth of field.

You can instantly read off the depth of field at any distance setting and with every interchangeable lens with the exception of the Voigtländer-Zoomar  $f/2.8$ . The two red pointers (9) above the distance scale (8) automatically indicate the limits of the sharp zone (see illustration).

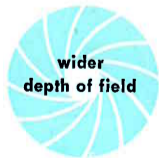

## Flash Shots

The Synchro-Compur diaphragm shutter permits fully synchronized flash shots up to the fastest shutter speed of  $1/500$  second, with any flash gun or electronic flash unit on the market.

With black-and-white film the flash can be used on its own, or equally well combined with daylight or artificial light sources, such as tungsten lamps.

For flash shots with daylight type or artificial light type colour film refer to the appropriate instruction leaflets. In case of doubt your photo dealer will be glad to advise you.

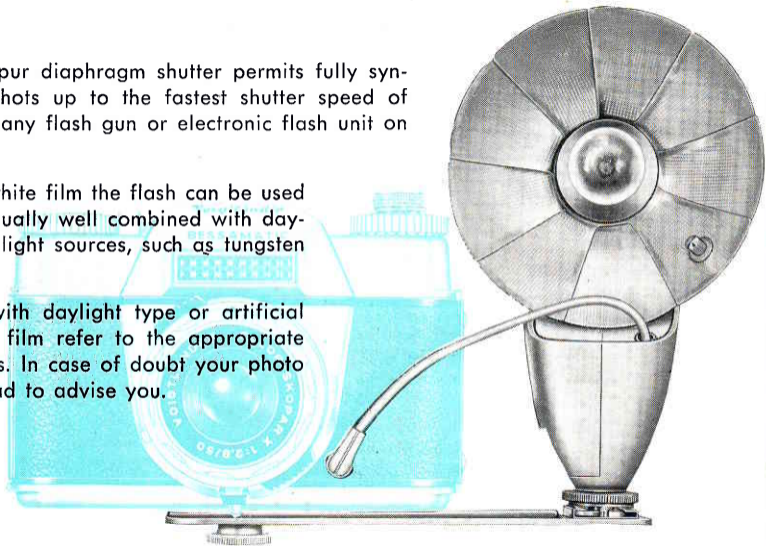

## Mounting the Flash Gun on the Camera

The flash gun or the flash holder of an electronic unit is usually fitted to the side of the camera by means of a special bracket – as shown in the illustration on the left for the Voigtländer flash gun. A separate accessory shoe can also be clamped behind the finder eyepiece mount; you can then fit the flash gun on the top of the camera as well.

The flash cable completes the electric circuit between the flash unit and the camera shutter. Push the plug of the flash cable into the flash socket (3) as shown in the illustration on the right.



## Setting the Shutter and the Aperture

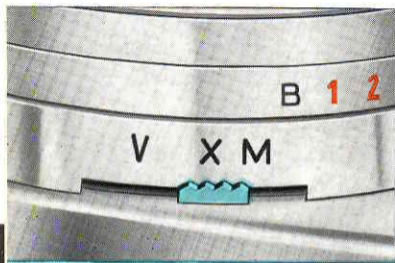

### **X setting:**

The firing circuit closes when the shutter is fully open.

### **M setting:**

The firing circuit closes before the shutter opens, to allow for the firing delay of class M flash bulbs.

Flash bulbs and electronic flash units differ in their characteristics such as the firing delay and light output. To ensure that the peak brightness of the flash coincides with the instant when the shutter is fully open, there are two types of synchronization: M and X.

Before taking a flash shot therefore depress the locking lever (18) of the Synchro-Compur shutter and move the synchronizing lever (2) to M or X as required. You can then use all types of flash at the appropriate shutter speeds listed in the table opposite. Note: for flash shots with the selftimer (synchronizing lever set to V) use only the shutter speeds listed in the table under X. When moving the synchronizing lever, locking catch (18) has to be pressed.

The lens aperture required for correct exposure can be obtained from the so-called guide number. This is usually quoted on the flash bulb packing or in the leaflets issued with the bulb or electronic flash unit. To find the correct aperture divide the appropriate guide number by the distance in feet between the subject and the camera with a flash gun. In short,

$$\text{aperture} = \text{guide number} : \text{distance.}$$



## Suitable shutter speeds

Flash bulbs		Synchronizing lever set to	
Type		X	M
PF 1 PF 5 PF 14 PF 25	}	1—1/30 sec.	1/60—1/500 sec.
XM 1 XM 5	}	1—1/30 sec.	1/60—1/500 sec.
M 2 M 5		1—1/30 sec. 1—1/30 sec.	not suitable 1/60—1/500 sec.
No 0 No 5 No 25	}	1—1/30 sec.	1/60—1/500 sec.



Electronic flash units	Synchronizing lever set to
Type	X
Instantaneous firing	1—1/500

## Voigtländer-Filter

are hard coated and carry a 40.5 mm. diameter screw mount. The filter factors given below are approximate values, as they necessarily depend on the colour sensitivity of the black-and-white film used, and on the light conditions prevailing at the time of the exposure.

		Filter factor
<b>Yellow filter G 1.5 x</b>	Slight filtering effect for outdoor shots such as sports and action subjects, and pictures with low sun. ....	1.5
<b>Yellow filter G 3 x</b>	Universal filter for landscapes and other outdoor subjects; indispensable for snow pictures. ....	3
<b>Green filter Gr 4 x</b>	Lightens green tones in landscapes. Recommended for artificial light portraiture and for copying of coloured originals. ....	4
<b>Orange filter Or 5 x</b>	Strongly cuts blue light for dramatic effects. Reduces atmospheric haze in distant views. ....	5
<b>Ultra-Violet filter UV</b>	Cuts out ultra-violet radiation in high mountains or near the sea. Eliminates unpleasant blue casts in colour shots. Requires no exposure increase. ....	—
<b>Polarizing Filter P</b>	Reduces or cuts out disturbing reflections from shiny surfaces (spectacles, polished areas, water) other than metal. Special instructions included with every filter ....	2.5 4—5
	With strong reflections .....	

## Setting the Filter Factors

With any filter (except the ultra-violet filter) the exposure setting requires some correction. You can carry out this adjustment with the aid of the coloured dots below the setting knob (4) and the filter factors marked alongside from 1.5 to 5. Proceed as follows:

Turn the setting knob to the left until the coloured dot with its index line (or if necessary an intermediate value) next to the black dot is opposite the index line of the required filter factor (16). The setting marker will now no longer be superimposed on the exposure meter needle in the finder.

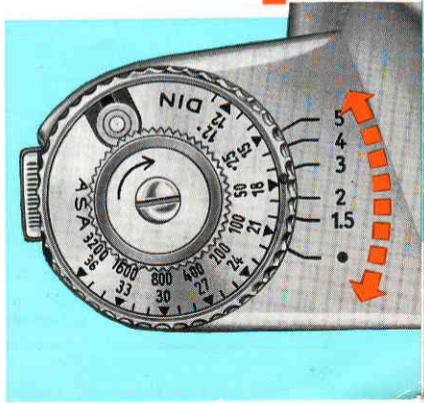
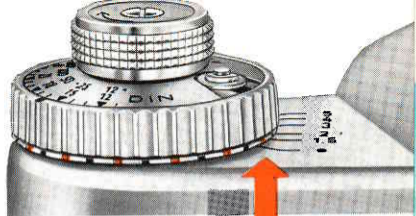

## Hints on Using the Exposure Meter

Generally it is sufficient to sight a subject with the camera as described on page 10. (Holding the camera **horizontally** renders the most accurate exposure.) This measures the light reflected from the subject and is suitable for all average conditions without excessive contrasts of light and shade.

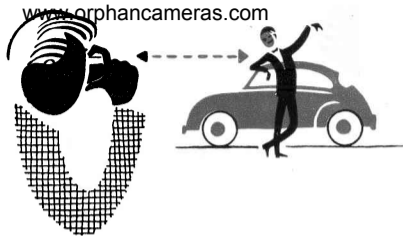

In some cases, however, a more refined method should be adopted, using the so-called close-up readings:

- with light subjects against a dark background and vice versa;
- with close-ups of small objects and animals;
- and principally with pictures of people, especially portraits.

In this case go sufficiently close to the subject so that the meter cell reads only the important parts of the subject.

With tricky subjects **incident light** readings are more useful. This especially applies to extreme brightness contrasts between the subject and its background or surroundings (for instance against-the-light shots, snow scenes, etc.).

In this case mount the diffusing screen in front of the exposure meter window (20). Take the reading from the subject towards the camera position to be used. This then measures the light actually reaching the subject. Incident light readings are also successful for interiors – with or without artificial light.

**Note, however, that with incident light readings the correct exposure will of course also depend on the light reflected from the subject. Naturally it is not possible to quote any correction factors for that. So go by your own experience in deriving exposures from incident light readings.**



## Hints for Colour Shots



- Motives representing large coloured areas without any excessive light contrasts are most suitable for colour shots.
- Persons should be placed in good contrast against a quiet and neutral back ground; outdoor portraits give best results when the sun is slightly covered by clouds.
- When shooting landscapes make sure to get a coloured foreground into your picture. In high mountains and on the beach a UV haze filter helps to avoid a bluish colour cast.
- Sunlight appears orange in the morning and evening. Motives illuminated by the blue sky only and not by direct sun light tend to show a bluish cast on the picture.
- For the purpose of lighting up shadows when taking daylight pictures use a white reflector or blue type flash bulb or electronic flash unit. Combined artificial and daylight may render wrong colours in the picture.

## Shots with Self-timer

**Tension the shutter**, press the locking catch (18) and set the synchronizing lever (2) to position "V". If you now press the release, the shutter runs down automatically after a delay of about 10 seconds. At that point the synchronizing lever moves back from the V into the "X" position.

**Do not use the self-timer with the shutter set to "B". The synchronizing lever, once set to "V" cannot be pushed back to the X or M positions by hand.**

**Self-timer and flashlight:** See page 18.



## Double Exposures "at will"

on the same picture frame required for i. e. certain trick shots are very easy, in spite of the automatic double exposure prevention device.

Move the reversing lever (15) towards "R" after the **first** exposure and operate the rapid winder again. The shutter has been tensioned again, but the film has not been transported. Now you are ready to expose the same picture frame for a **second** time.

## The Universal Case for the BESSAMATIC Camera

— fashionable and well-shaped, made of best genuine cow hide, has the advantage that your complete camera outfit is at your disposal at the right moment.

Within the universal case the BESSAMATIC camera with its Color-Skopar standard lens is put into a separate leather container with a leather strap, which can be carried round your neck in the same way as the ordinary everready case. Moreover, space is available for the additional interchangeable lenses and two lens hoods, for the right angle finder, the accessory shoe and eight filters and/or Focar lenses.





## Care of the Camera and Lens

Successful results and long life of your BESSAMATIC depend largely on proper care and correct operation.

- Therefore always handle the camera gently and never use force. In particular protect the camera against hard knocks and do not drop it. When travelling by car do not keep the camera in the glove compartment. In the long run such a "vibration test" will not do the built-in photo-electric exposure meter any good.
- Clean the lens only with a soft, fluffless cloth. However, first remove coarse particles of grit (or sand at the seaside) carefully with a soft sable brush. Finger marks and other traces of grease on the lens surface can be removed with a piece of cotton wool moistened with pure alcohol or ether.
- In case of any trouble consult your photo dealer, or post the camera to the Voigtländer agent in your country, or to the Service Department, Voigtländer AG, Braunschweig, Western Germany.

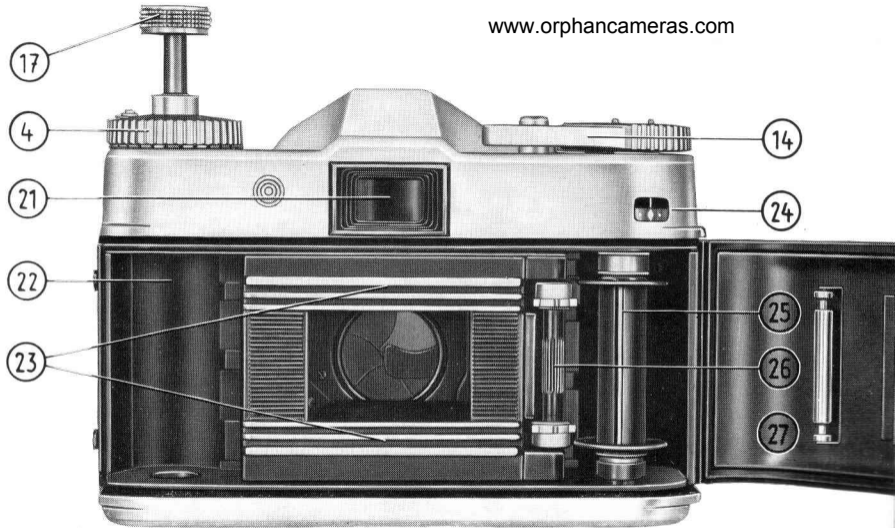

BESSAMATIC without film and with extended rewind knob

Illustration III

- 4 **Setting knob**  
for exposure meter readings
- 14 **Rapid winder**  
for tensioning the shutter and  
advancing the film
- 17 **Film rewind knob**
- 21 **Finder eyepiece**
- 22 **Cassette chamber**
- 23 **Film track**
- 24 **Film counter window**
- 25 **Take-up spool**  
with slit on top
- 26 **Film transport shaft**  
with milled centre for setting the  
film counter
- 27 **Camera back,**  
open
- 28 **Shaft of rewind knob**  
engaged in cassette
- 29 **Film leader**  
folded over and hooked into  
take-up spool
- 30 **Sprocket of transport shaft**  
engaged in the film perforations

**Please, notice when taking tripod shots**

According to the standard of the American Standard Association (ASA) for light-weight-cameras the tripod screw may have a length of up to 0.175 inch (about 4.5 mm). If screws longer than 0.175 inch are forced into the threaded socket the camera will be damaged.

With tripods having a 0.340 inch screw a spacer must be applied before mounting the camera to the tripod.

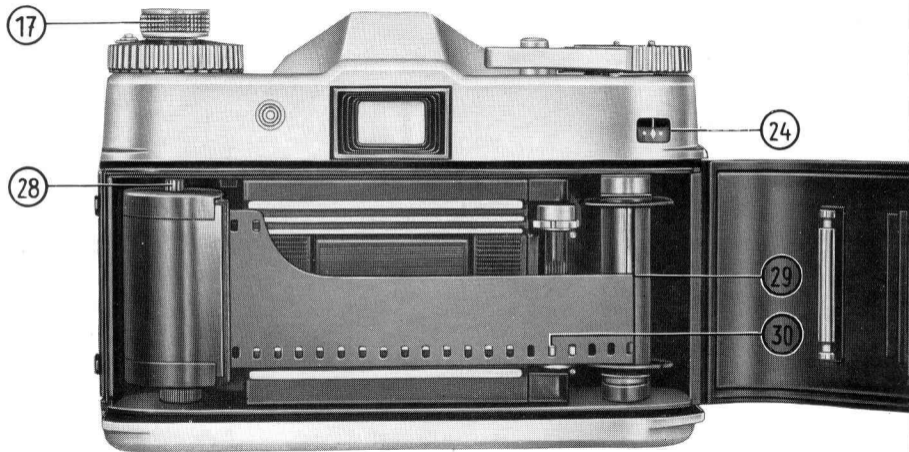
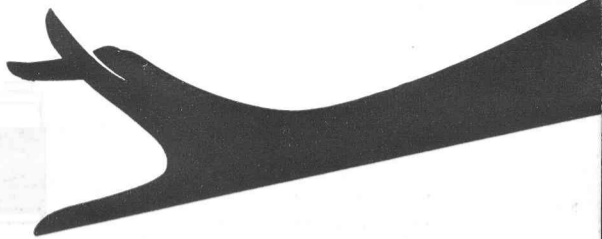

Illustration IV



**W**e guarantee this camera according to present-day standards of technical perfection against defects due to faulty material and workmanship. Should any such defects become apparent in use, they will be rectified free of charge if the claim is made within a reasonable time after purchase. We cannot entertain claims for further damages, consequential or otherwise, or for the free repair of faults caused by incorrect handling or storage.

**VOIGTLÄNDER A. G. BRAUNSCHWEIG**