



***STARPLUS™***  
***STSe***  
***Key Systems***

**System Programming & Operations Manual**

August 2005 - Issue 1.0

---

---

| Issue | Release Date | Changes         | Page |
|-------|--------------|-----------------|------|
| 1.0   | 8-05         | Initial Release | --   |

**LIFE SUPPORT APPLICATIONS POLICY**

**VODAVI Technology, Inc.** products are not authorized for and should not be used within Life Support applications. Life Support systems are equipment intended to support or sustain life and whose failure to perform when properly used in accordance with instructions provided can be reasonably expected to result in significant personal injury or death.

**VODAVI Technology, Inc.** warranty is limited to replacement of defective components and does not cover injury to persons or property or other consequential damages.

**Copyright © 2005 VODAVI Technology, Inc.**

**All Rights Reserved**

This material is copyrighted by VODAVI Technology, Inc., and may be duplicated by Authorized Dealers only. Any unauthorized reproductions, use or disclosure of this material, or any part thereof, is strictly prohibited and is a violation of the Copyright Laws of the United States (17 U.S.C. Section 101 et. seq.).

VODAVI reserves the right to make changes in specifications at any time and without notice. The information furnished by VODAVI in this material is believed to be accurate and reliable, but is not warranted to be true in all cases.

*STARPLUS™* is a registered trademark of VODAVI Technology, Inc.

mlj/2005

# Contents

## 1 Introduction

|   |            |
|---|------------|
| <b>General Description .....</b>                | <b>1-3</b> |
| System Features .....                           | 1-4        |
| Digital Keypad Telephones .....                 | 1-5        |
| 24-Button Digital Keypad / Button Diagram ..... | 1-7        |

## 2 Features and Operation

|  |             |
|--|-------------|
| <b>About This Manual .....</b>                 | <b>2-3</b>  |
| Content Summary .....                          | 2-3         |
| Manual Format & Description .....              | 2-4         |
| <b>911 Feature .....</b>                       | <b>2-5</b>  |
| 911 Alert .....                                | 2-6         |
| Enhanced 911 Integration .....                 | 2-7         |
| Enhanced 911 Power Failure Station .....       | 2-8         |
| <b>Account Codes .....</b>                     | <b>2-8</b>  |
| Account Codes - Forced .....                   | 2-9         |
| Account Codes - Traveling COS (Verified) ..... | 2-10        |
| Initialize Verified Account Code Table .....   | 2-13        |
| Print Verified Account Codes .....             | 2-13        |
| <b>Answering Machine Emulation .....</b>       | <b>2-14</b> |
| <b>Attendant Assignment/Features .....</b>     | <b>2-15</b> |
| <b>Automatic Privacy .....</b>                 | <b>2-16</b> |
| <b>Background Music .....</b>                  | <b>2-16</b> |
| <b>Back Light Display .....</b>                | <b>2-17</b> |
| <b>Battery Backup (Memory) .....</b>           | <b>2-18</b> |
| <b>Baud Rate Assignments .....</b>             | <b>2-19</b> |
| <b>Call Back .....</b>                         | <b>2-20</b> |
| Manual Callback .....                          | 2-20        |
| Call Back Button Flash Rate .....              | 2-21        |
| Automatic Call Back Timer .....                | 2-21        |
| Auto Call Back - BLF Flash Rate .....          | 2-22        |
| <b>Call Coverage .....</b>                     | <b>2-22</b> |
| Call Coverage Ring Timer .....                 | 2-24        |
| <b>Call Forward .....</b>                      | <b>2-25</b> |
| Call Forwarding .....                          | 2-25        |
| Call Forward - All Calls .....                 | 2-27        |
| Call Forward - Busy .....                      | 2-28        |
| Call Forward - Busy / No Answer .....          | 2-29        |
| Call Forward - Follow Me .....                 | 2-30        |
| Call Forward - No Answer .....                 | 2-31        |
| Call Forward - External (Off-Net) .....        | 2-32        |

---

|   |             |
|---|-------------|
| Call Forward Button Flash Rate .....                        | 2-33        |
| Call Forward Display .....                                  | 2-34        |
| <b>Call Forward - Preset .....</b>                          | <b>2-34</b> |
| Preset Call Forward - Station .....                         | 2-35        |
| Preset Call Forward - CO Line .....                         | 2-39        |
| Preset Forward Voice Mail ID .....                          | 2-41        |
| Preset Forward Timer (Incoming Call to a Destination) ..... | 2-42        |
| <b>Calling Forward Override .....</b>                       | <b>2-43</b> |
| <b>Calling Station Handsfree Mode Override .....</b>        | <b>2-43</b> |
| <b>Calling Station Tone Mode Override .....</b>             | <b>2-43</b> |
| <b>Call Park .....</b>                                      | <b>2-44</b> |
| Call Park - System .....                                    | 2-44        |
| Call Park Recall Timer .....                                | 2-45        |
| Call Park - Personal .....                                  | 2-45        |
| Call Park - Station .....                                   | 2-46        |
| <b>Call Pickup .....</b>                                    | <b>2-47</b> |
| Directed Call Pickup .....                                  | 2-49        |
| Group Call Pickup .....                                     | 2-49        |
| <b>Call Transfer .....</b>                                  | <b>2-50</b> |
| Ringback on Transfer .....                                  | 2-52        |
| Unanswered CO Call Transfer .....                           | 2-53        |
| <b>Camp On .....</b>  | <b>2-54</b> |
| Camp On Button Flash Rate .....                             | 2-55        |
| Camp On Recall .....  | 2-55        |
| <b>Card Slot Programming .....</b>                          | <b>2-55</b> |
| <b>Centrex/PBX .....</b>                                    | <b>2-57</b> |
| CO / PBX Programming .....                                  | 2-57        |
| Off-Hook Preference .....                                   | 2-58        |
| Private Line Appearance .....                               | 2-58        |
| Programming *, #, and Hook-Flashes into Speed Dial .....    | 2-58        |
| Centrex/PBX Flash .....                                     | 2-58        |
| Centrex/PBX Flash Timer .....                               | 2-59        |
| Centrex/PBX Transfer .....                                  | 2-59        |
| PBX Dialing Codes .....                                     | 2-60        |
| <b>Class Of Service .....</b>                               | <b>2-61</b> |
| Class of Service - CO Line .....                            | 2-62        |
| Station Day Class of Service .....                          | 2-63        |
| Station Night Class of Service .....                        | 2-64        |
| <b>CO Flexible Port Assignment .....</b>                    | <b>2-66</b> |
| <b>CO Line - Access .....</b>                               | <b>2-67</b> |
| <b>CO Line Attributes .....</b>                             | <b>2-68</b> |
| Initialize CO Line Attributes .....                         | 2-68        |
| Print CO Line Attributes .....                              | 2-70        |
| <b>CO Line DTMF Sending .....</b>                           | <b>2-71</b> |
| DTMF / Dial Pulse Programming .....                         | 2-71        |

---



---

|   |              |
|---|--------------|
| DTMF On/Off Time Operation .....                                      | 2-72         |
| <b>CO Line Group .....</b>  | <b>2-73</b>  |
| Line Group Access - Station .....                                     | 2-73         |
| CO Line Group Programming .....                                       | 2-74         |
| <b>CO Line Group Queuing .....</b>                                    | <b>2-75</b>  |
| <b>CO Line - Identification .....</b>                                 | <b>2-76</b>  |
| CO Line Identification Display .....                                  | 2-76         |
| <b>CO Line - Incoming Ringing Assignment .....</b>                    | <b>2-78</b>  |
| CO Line Ringing Assignments .....                                     | 2-78         |
| Incoming CO Line Ringing - Setting Flash Rate .....                   | 2-80         |
| Display Ring Assignments .....  | 2-81         |
| Release Timer .....   | 2-82         |
| Reseize Timer .....   | 2-83         |
| Guard Timer .....   | 2-83         |
| Seize Timer .....   | 2-84         |
| Transmit Volume .....   | 2-84         |
| <b>CO Line Loop and Pool Buttons .....</b>                            | <b>2-85</b>  |
| In-Use Hold (I-Hold) Flash Rate .....                                 | 2-87         |
| <b>CO Line - Loop Supervision .....</b>                               | <b>2-88</b>  |
| Loop Supervision Programming .....                                    | 2-88         |
| CO Line Loop Supervision - Forced Disconnect .....                    | 2-89         |
| SLT Loop Supervision Programming .....                                | 2-89         |
| <b>CO Line - Queue .....</b>  | <b>2-91</b>  |
| Line Queuing .....  | 2-91         |
| CO Line Queue Button Flash Rate .....                                 | 2-93         |
| <b>CO Line - Ringing Options .....</b>                                | <b>2-93</b>  |
| Transfer CO Ringing .....   | 2-95         |
| Recall CO Ringing .....   | 2-95         |
| Queued CO Ringing Flash Rate .....                                    | 2-96         |
| Reminder Ring Timer .....   | 2-96         |
| CO Direction .....  | 2-97         |
| <b>CO Port Parameters and Feature Codes .....</b>                     | <b>2-98</b>  |
| Initialize CO Port Assignments / Flexible Numbering Assignments ..... | 2-98         |
| Print CO Port Parameters and Feature Codes .....                      | 2-98         |
| <b>CO Ring Detect Timer .....</b>                                     | <b>2-99</b>  |
| <b>CO Tolerance .....</b>   | <b>2-100</b> |
| <b>Conference .....</b>   | <b>2-101</b> |
| Conference Enable/Disable .....                                       | 2-101        |
| Conference / DISA Timer .....   | 2-102        |
| Conference Combinations .....   | 2-103        |
| <b>Cordless Key Telephone Unit Feature Button .....</b>               | <b>2-105</b> |
| <b>Database Administration .....</b>                                  | <b>2-106</b> |
| Administration Access .....   | 2-106        |
| Administration Password .....   | 2-108        |
| <b>Database Printout (Dump) .....</b>                                 | <b>2-109</b> |

---

|   |              |
|---|--------------|
| <b>Daylight Saving Time</b> .....                               | <b>2-110</b> |
| <b>Dial Pulse Sending</b> .....                                 | <b>2-111</b> |
| Dial Pulse Parameters .....                                     | 2-111        |
| Pulse Dial Inter-Digit Timer .....                              | 2-111        |
| Pulse-to-Tone Switchover .....                                  | 2-112        |
| <b>Direct Inward Dialing</b> .....                              | <b>2-112</b> |
| DID Phone Number .....  | 2-114        |
| Name Assigned to DID Number .....                               | 2-114        |
| Erasing a DID Table Entry .....                                 | 2-115        |
| DID/ICLID Ringing Assignments .....                             | 2-116        |
| View DID/ICLID Ringing Assignments .....                        | 2-117        |
| Preset Call Forward Destination - Day/Night/Special .....       | 2-118        |
| Preset Forward Voice Mail ID .....                              | 2-119        |
| Preset Forward Timer (Incoming Call to a Destination) .....     | 2-120        |
| Music-On-Hold (per CO Line) .....                               | 2-121        |
| Universal Night Answer (UNA) / Universal Day Answer (UDA) ..... | 2-122        |
| DID Digits .....  | 2-123        |
| DID Incoming Signaling .....                                    | 2-124        |
| DID/TIE Signaling .....   | 2-124        |
| DID Collect Timer .....   | 2-126        |
| Initialize DID-TIE Parameters .....                             | 2-127        |
| Print DID-TIE Parameters .....                                  | 2-128        |
| <b>Direct Inward System Access (DISA)</b> .....                 | <b>2-129</b> |
| DISA Access Code .....  | 2-129        |
| DISA Programming .....  | 2-129        |
| DISA Call Forwarding .....                                      | 2-130        |
| DISA CO-to-CO .....   | 2-131        |
| <b>Direct Station Selection / Busy Lamp Field</b> .....         | <b>2-132</b> |
| <b>Direct Transfer Mode</b> .....                               | <b>2-133</b> |
| <b>Directory Dial</b> .....                                     | <b>2-134</b> |
| Initialize Directory Dial Table Parameters .....                | 2-138        |
| Print Directory Dial Table Parameters .....                     | 2-139        |
| Dial-By-Name .....  | 2-140        |
| <b>Distinctive Ringing</b> .....                                | <b>2-141</b> |
| CO Line Distinctive Ring Tone .....                             | 2-141        |
| Enabling/Disabling CO Line Distinctive Ring Tone .....          | 2-143        |
| Distinctive Ring Tone - Station .....                           | 2-143        |
| <b>Do Not Disturb / Page Block</b> .....                        | <b>2-147</b> |
| One-Time Do Not Disturb .....                                   | 2-149        |
| Do Not Disturb Button Flash Rate .....                          | 2-150        |
| Do Not Disturb - DSS/BLF Flash Rate .....                       | 2-150        |
| <b>Door Box</b> .....   | <b>2-151</b> |
| <b>Executive Override</b> .....                                 | <b>2-152</b> |
| Executive Override - Enable/Disable .....                       | 2-152        |
| Executive Override Blocking .....                               | 2-154        |

---



---

|   |              |
|---|--------------|
| Executive Override Warning Tone .....                         | 2-156        |
| Barge-In Warn Tone .....                                      | 2-157        |
| <b>Executive/Secretary Pairs .....</b>                        | <b>2-158</b> |
| <b>External Day Ring .....</b>                                | <b>2-159</b> |
| <b>External Night Ring .....</b>                              | <b>2-159</b> |
| <b>Fax Detect .....</b>                                       | <b>2-160</b> |
| <b>Fixed Station/Port Number .....</b>                        | <b>2-162</b> |
| <b>Flash Rates (Programmable) .....</b>                       | <b>2-162</b> |
| <b>Flexible Button Function Assignment .....</b>              | <b>2-163</b> |
| Display Flexible Buttons .....                                | 2-168        |
| <b>Flexible Numbering .....</b>                               | <b>2-171</b> |
| Station Port Inquiry .....                                    | 2-172        |
| <b>Group Listening .....</b>                                  | <b>2-172</b> |
| <b>Headset Mode .....</b>                                     | <b>2-173</b> |
| <b>Hold - Exclusive .....</b>                                 | <b>2-176</b> |
| Exclusive Hold Flash Rate .....                               | 2-176        |
| Exclusive Hold Recall Timer .....                             | 2-177        |
| <b>Hold - Preference .....</b>                                | <b>2-177</b> |
| <b>Hold - System .....</b>                                    | <b>2-178</b> |
| System Hold Flash Rate .....                                  | 2-178        |
| System Hold Recall Timer .....                                | 2-178        |
| <b>Hot Keypad .....</b>                                       | <b>2-179</b> |
| <b>Hot Line / Ring Down .....</b>                             | <b>2-179</b> |
| <b>Hunt Groups .....</b>                                      | <b>2-179</b> |
| Station / Pilot / Pilot All Ring -- Hunting Assignments ..... | 2-180        |
| Overflow .....  | 2-181        |
| Initialize Hunt Group Parameters .....                        | 2-182        |
| Print Hunt Group Parameters .....                             | 2-183        |
| <b>Idle Speaker Mode .....</b>                                | <b>2-183</b> |
| <b>In and Out Button .....</b>                                | <b>2-184</b> |
| <b>Incoming Calling Line Identification .....</b>             | <b>2-185</b> |
| <b>Intercom .....</b>   | <b>2-185</b> |
| Intercom Calling .....  | 2-187        |
| Incoming Intercom Ringing Flash Rate .....                    | 2-188        |
| Intercom Signaling Select .....                               | 2-188        |
| Intercom Transfer .....                                       | 2-189        |
| <b>Inter-Digit Time-Out .....</b>                             | <b>2-189</b> |
| <b>ISDN .....</b>   | <b>2-190</b> |
| Name/Number Display When Using PRI .....                      | 2-191        |
| Outbound DID Number on PRI .....                              | 2-195        |
| <b>ISDN Programming - Page A .....</b>                        | <b>2-197</b> |
| Primary Rate Interface (PRI) CO Type .....                    | 2-197        |
| Framing .....   | 2-198        |
| Power .....   | 2-198        |
| Directory Number - PRI .....                                  | 2-198        |

---

|  |              |
|--|--------------|
| Max Out I-Frames .....                     | 2-199        |
| Leading 1 .....                            | 2-199        |
| Leading 011 .....                          | 2-200        |
| PRI 7/11 Digit Number Plan .....           | 2-200        |
| Calling Number .....                       | 2-201        |
| Loopback .....                             | 2-201        |
| <b>ISDN Programming - Page B .....</b>     | <b>2-202</b> |
| Maximum Number Retransmission .....        | 2-203        |
| Maximum Octets .....                       | 2-203        |
| Maximum TEI Request .....                  | 2-204        |
| Maximum XID Retransmission .....           | 2-204        |
| T-200 .....                                | 2-204        |
| Minimum TEI ID Check Message .....         | 2-205        |
| Minimum TEI ID Request .....               | 2-205        |
| Message Exchange Timer .....               | 2-205        |
| Minimum XID Retransmission .....           | 2-206        |
| Inter-Digit T / O .....                    | 2-206        |
| Set-Up Timer .....                         | 2-207        |
| Disconnect Timer .....                     | 2-207        |
| Release Request .....                      | 2-207        |
| Link Disconnect .....                      | 2-208        |
| Call Proceeding .....                      | 2-208        |
| Connect Request .....                      | 2-208        |
| Restart Request Timer .....                | 2-209        |
| Initialize ISDN Parameters .....           | 2-209        |
| Print ISDN Parameters .....                | 2-210        |
| <b>Keyset Mode .....</b>                   | <b>2-212</b> |
| <b>Last Number Redial .....</b>            | <b>2-215</b> |
| <b>LCD .....</b>                           | <b>2-215</b> |
| LCD Display - Contrast .....               | 2-215        |
| LCD Interactive Display .....              | 2-216        |
| <b>LCOB Loop Length .....</b>              | <b>2-223</b> |
| <b>Leading Digit .....</b>                 | <b>2-223</b> |
| <b>Least Cost Routing .....</b>            | <b>2-224</b> |
| <b>Light Control .....</b>                 | <b>2-224</b> |
| <b>Message Wait .....</b>                  | <b>2-225</b> |
| <b>Message Waiting Reminder Tone .....</b> | <b>2-226</b> |
| <b>Music-On-Hold .....</b>                 | <b>2-226</b> |
| MOH Assignments .....                      | 2-227        |
| Music-On-Hold - Enable/Disable .....       | 2-227        |
| Music-On-Hold (per CO Line) .....          | 2-228        |
| <b>Mute Key .....</b>                      | <b>2-229</b> |
| <b>Muted Ring .....</b>                    | <b>2-230</b> |
| <b>Name In Display .....</b>               | <b>2-231</b> |
| Name / Number Display At Idle .....        | 2-232        |



|   |              |
|---|--------------|
| <b>Name/Number Translation Table .....</b>              | <b>2-233</b> |
| <b>Night Service .....</b>                              | <b>2-235</b> |
| Automatic/Manual Operation .....                        | 2-235        |
| Day of Week Programming .....                           | 2-236        |
| Automatic Night Mode Operation .....                    | 2-236        |
| External Night Ringing .....                            | 2-236        |
| Manual Operation .....                                  | 2-236        |
| Night Class of Service (COS) .....                      | 2-236        |
| Night Ringing Assignments .....                         | 2-237        |
| Universal Night Answer (UNA) .....                      | 2-237        |
| Weekly Night Mode Schedule .....                        | 2-237        |
| <b>Off-Hook Signaling .....</b>                         | <b>2-237</b> |
| <b>Off-Hook Voice Over .....</b>                        | <b>2-238</b> |
| <b>Outside Calls .....</b>                              | <b>2-241</b> |
| <b>Paging .....</b>                                     | <b>2-242</b> |
| Paging Access .....                                     | 2-243        |
| Paging - Meet Me .....                                  | 2-244        |
| Paging Time-Out Timer .....                             | 2-245        |
| Page Warning Tone .....                                 | 2-245        |
| Paging Zone(s) .....                                    | 2-246        |
| <b>Pause Timer .....</b>                                | <b>2-247</b> |
| <b>Personal Messages .....</b>                          | <b>2-248</b> |
| Pre-assigned Messages .....                             | 2-248        |
| Custom Messages .....                                   | 2-249        |
| Date and Time Entry Messages .....                      | 2-250        |
| Scrollable Canned Messages .....                        | 2-251        |
| Personal Messages Flexible Button .....                 | 2-252        |
| <b>Preferred Line Answer .....</b>                      | <b>2-253</b> |
| <b>Privacy Release .....</b>                            | <b>2-254</b> |
| Per CO Line Option .....                                | 2-254        |
| Per Station Option .....                                | 2-256        |
| <b>Private Line .....</b>                               | <b>2-258</b> |
| <b>Recall .....</b>                                     | <b>2-258</b> |
| Answering a Recall .....                                | 2-258        |
| Transfer Recall Timer .....                             | 2-258        |
| <b>Repeat Redial .....</b>                              | <b>2-259</b> |
| <b>Relay Programming .....</b>                          | <b>2-260</b> |
| <b>Remote Administration .....</b>                      | <b>2-261</b> |
| Program Mode Entry .....                                | 2-261        |
| Modem Answer Timer .....                                | 2-261        |
| Database Upload/Download .....                          | 2-262        |
| <b>Remote System Monitor And Maintenance .....</b>      | <b>2-262</b> |
| Maintenance .....                                       | 2-262        |
| Monitor .....   | 2-262        |
| <b>Ring Down / Hot Line / Off-Hook Preference .....</b> | <b>2-263</b> |

---



---

|   |              |
|---|--------------|
| <b>Save Number Redial (SNR)</b> .....         | <b>2-266</b> |
| <b>School Zone</b> .....                      | <b>2-267</b> |
| <b>Single Line Telephone</b> .....            | <b>2-270</b> |
| Compatibility .....                           | 2-270        |
| SLT DTMF Receiver Timer .....                 | 2-270        |
| SLT Hook Flash Timer .....                    | 2-271        |
| SLT Hook Flash Bounce Timer .....             | 2-271        |
| <b>Software Version (MBU)</b> .....           | <b>2-272</b> |
| <b>Speakerphone</b> .....                     | <b>2-272</b> |
| Speakerphone Options .....                    | 2-272        |
| Speakerphone Operation .....                  | 2-274        |
| <b>Speed Dial</b> .....                       | <b>2-275</b> |
| Station Speed Dial Numbers .....              | 2-275        |
| System Speed Dial Access .....                | 2-276        |
| Speed Bins - Chaining .....                   | 2-278        |
| Initialize System/Station Speed Numbers ..... | 2-278        |
| Print System Speed Numbers .....              | 2-279        |
| <b>Station Attributes</b> .....               | <b>2-280</b> |
| Initialize Station Attributes .....           | 2-280        |
| Print Station Attributes .....                | 2-282        |
| <b>Station Identification</b> .....           | <b>2-283</b> |
| Station ID Lock .....                         | 2-285        |
| <b>Station Message Detail Recording</b> ..... | <b>2-286</b> |
| SMDR Enable/Disable .....                     | 2-288        |
| Long Distance - All Calls .....               | 2-288        |
| Character Print Assignment .....              | 2-289        |
| Baud Rate Display .....                       | 2-289        |
| SMDR Port Assignments .....                   | 2-289        |
| SMDR Call Qualification Timer .....           | 2-290        |
| <b>Station Relocation</b> .....               | <b>2-291</b> |
| <b>System Parameters</b> .....                | <b>2-292</b> |
| Initialize System Parameters .....            | 2-292        |
| Print System Parameters .....                 | 2-296        |
| <b>System Reset</b> .....                     | <b>2-298</b> |
| <b>T-1 Alarm Programming</b> .....            | <b>2-299</b> |
| Enable/Disable (Carrier Loss Alarm) .....     | 2-299        |
| Blue Alarm .....                              | 2-300        |
| Yellow Alarm .....                            | 2-301        |
| Red Alarm .....                               | 2-301        |
| Bipolar Variations Alarm .....                | 2-302        |
| Frame Slip Alarm .....                        | 2-302        |
| Data Errors Alarm .....                       | 2-303        |
| Clear Alarm .....                             | 2-303        |
| Minor Alarm .....                             | 2-304        |
| Major Alarm .....                             | 2-304        |

---



---

|  |              |
|--|--------------|
| Time Period .....                                    | 2-305        |
| Attendant Display - T-1 Alarms .....                 | 2-305        |
| <b>T-1 Trunking .....</b>                            | <b>2-306</b> |
| T-1 Signaling Type .....                             | 2-306        |
| T-1 Ringback Option .....                            | 2-308        |
| T-1 Dial Tone Option .....                           | 2-308        |
| Wink Timer .....                                     | 2-309        |
| T-1 Collect Timer .....                              | 2-310        |
| T-1 Incoming Signaling .....                         | 2-310        |
| T-1 Framing Type .....                               | 2-311        |
| <b>Tenant Groups .....</b>                           | <b>2-312</b> |
| Enable/Disable the Tenant Groups Feature .....       | 2-312        |
| Attendant Station Assignment for Tenant Groups ..... | 2-313        |
| Station Assignment to a Tenant Group .....           | 2-313        |
| CO Line Assignments for Tenant Groups .....          | 2-314        |
| Incoming Ring Assignments .....                      | 2-315        |
| CO Line Sharing .....                                | 2-316        |
| <b>Text Messaging (Silent Response) .....</b>        | <b>2-316</b> |
| <b>Toll Restriction .....</b>                        | <b>2-318</b> |
| Entering Toll Table .....                            | 2-320        |
| Allow Table .....                                    | 2-321        |
| Deny Table .....                                     | 2-323        |
| Special Table .....                                  | 2-324        |
| Display Toll Table Entries .....                     | 2-325        |
| Initialize Exception Tables .....                    | 2-326        |
| Print Exception Tables .....                         | 2-327        |
| Toll Restriction Related Items .....                 | 2-328        |
| <b>Uniform Call Distribution .....</b>               | <b>2-329</b> |
| <b>Universal Day/Night Answer .....</b>              | <b>2-329</b> |
| Universal Day Answer (UDA) .....                     | 2-330        |
| Universal Night Answer (UNA) .....                   | 2-331        |
| <b>Virtual Stations .....</b>                        | <b>2-332</b> |
| <b>Voice Mail .....</b>                              | <b>2-333</b> |
| Alternate Voice Mail Group .....                     | 2-334        |
| Standard Leave Mail Index Entry .....                | 2-334        |
| Retrieve Mail Index Entry .....                      | 2-335        |
| Station Assignments .....                            | 2-335        |
| No Answer Leave Mail Index Entry .....               | 2-336        |
| Busy Leave Mail Index Entry .....                    | 2-336        |
| VMID Station Numbers .....                           | 2-337        |
| VM Transfer with ID Digits .....                     | 2-337        |
| VM Tone Mode Calling Option .....                    | 2-338        |
| Voice Mail ID Translation .....                      | 2-339        |
| Message Waiting Indication .....                     | 2-340        |
| Message Wait / VM Button Flash Rate .....            | 2-341        |

Voice Mailbox Button ..... 2-342

Voice Mail Group Button ..... 2-342

Voice Mail Group Access ..... 2-342

Initialize Voice Mail Group Parameters ..... 2-343

Print Voice Mail Group Parameters ..... 2-344

**Voice Mail In-Band Features ..... 2-345**

    In-Band Signaling Integration ..... 2-345

    Voice Mail In-Band Digits ..... 2-346

    Voice Mail Transfer / Forward ..... 2-346

    Voice Mail Broker ..... 2-347

    Voice Mail ID Digit Length ..... 2-347

    Voice Mail Modem Access ..... 2-348

**Voice Mail One-Touch Recording ..... 2-349**

    One-Touch Recording Warning Tone ..... 2-351

**Voice Mail Outpulsing Table ..... 2-351**

    Voice Mail In-Band Signaling ..... 2-351

    Voice Mail Disconnect Table ..... 2-353

**Voice Mail System Message Wait Indications ..... 2-354**

**Volume Control ..... 2-355**

### 3 Attendant Features and Operation

**Introduction ..... 3-3**

**Attendant Features - Index ..... 3-4**

**911 Alert ..... 3-5**

**Attendant CO Line External (Off-Net) Forward ..... 3-6**

**Attendant Custom Message ..... 3-7**

**Attendant Day/Night/Special ..... 3-8**

**Attendant Directory List Programming ..... 3-9**

**Attendant Disable Outgoing CO Line ..... 3-12**

**Attendant Override ..... 3-13**

**Attendant Setting Time and Date ..... 3-14**

**Attendant Station Assignment ..... 3-15**

**Attendant Unavailable ..... 3-16**

**Attendant Voice Mail Alarm Clear ..... 3-17**

**DSS/BLF Console with Map ..... 3-17**

    Busy Lamp Field Indicators ..... 3-17

    Direct Station Calling ..... 3-17

    Release Key ..... 3-17

    Transfer Search ..... 3-17

    Mapping Options ..... 3-18

    Station ID for DSS/BLF Console With Map ..... 3-21

**Display Timer ..... 3-21**

**ICLID Call Management Tables ..... 3-22**

    Answered Call Management Table ..... 3-22

    Unanswered Call Management Table ..... 3-23

**Recall ..... 3-24**  
 Attendant Recall Timer ..... 3-24  
**Release Button ..... 3-24**  
**Speed Dial - System Storing ..... 3-25**

**4 Uniform Call Distribution**

**Uniform Call Distribution ..... 4-3**  
 UCD Calls In Queue Status Display ..... 4-3  
 Alternate UCD Group Assignments ..... 4-4  
 Incoming CO Direct Ringing ..... 4-4  
 Message Interval Timer ..... 4-5  
 No-Answer Recall Timer ..... 4-5  
 No-Answer Retry Timer ..... 4-6  
 Overflow Station Assignment ..... 4-6  
 Overflow Station Forwarding ..... 4-7  
 Overflow Timer ..... 4-8  
 Primary Agent Assignments ..... 4-8  
 Primary Recorded Announcement ..... 4-9  
 Recorded Announcements ..... 4-9  
 Recorded Announcement Tables ..... 4-10  
 Ring Timer ..... 4-11  
 Secondary Recorded Announcement ..... 4-12  
 UCD Available/Unavailable ..... 4-12  
 Wrap-up Timer ..... 4-14  
 Initialize UCD Group Parameters ..... 4-15  
 Print UCD Group Parameters ..... 4-16

**A ICLID / Caller ID**

**Introduction ..... A-3**  
**Functional Performance ..... A-4**  
**Caller ID Name/Number ..... A-4**  
 Calling Number/Name Display ..... A-5  
 Incoming Number/Name for SMDR Records ..... A-6  
 Local Name Translation ..... A-6  
**ICLID Programming ..... A-6**  
 Enable/Disable ..... A-7  
 Name in Display ..... A-7  
 Baud Rate Display ..... A-8  
 Port Assignment ..... A-8  
 Ring Delay Timer ..... A-9  
 Initialize ICLID-DID Tables ..... A-10  
 Print ICLID - DID Tables ..... A-12  
**ICLID Call Management Tables ..... A-14**  
 Answered Call Management Table ..... A-14  
 Unanswered Call Management Table ..... A-15

## B Least Cost Routing

|   |            |
|---|------------|
| <b>Introduction</b> .....               | <b>B-3</b> |
| LCR Tables .....                        | B-3        |
| LCR Flowchart .....                     | B-4        |
| Operation (When LCR is Enabled) .....   | B-5        |
| <b>Programming LCR Tables</b> .....     | <b>B-5</b> |
| 3-Digit Area / Office Code Table .....  | B-6        |
| 6-Digit Office Code Table .....         | B-7        |
| Exception Code Table .....              | B-8        |
| Route List Table .....                  | B-8        |
| Insert/Delete Table .....               | B-10       |
| Daily Start Time Table .....            | B-11       |
| Weekly Schedule Table .....             | B-13       |
| LCR Routing for Toll Information .....  | B-14       |
| LCR Call Progress .....                 | B-14       |
| Default LCR Database .....              | B-15       |
| Forced Least Cost Routing (LCR) .....   | B-15       |
| LCR Class of Service (COS) .....        | B-16       |
| Enable/Disable Least Cost Routing ..... | B-18       |
| Call Cost Display .....                 | B-18       |
| Initialize LCR Tables .....             | B-19       |
| Print LCR Tables .....                  | B-20       |
| LCR Printout .....                      | B-21       |

## C Flash-Based Voice Mail

|   |             |
|---|-------------|
| <b>Introduction</b> .....                                   | <b>C-3</b>  |
| System Capabilities .....                                   | C-3         |
| Basic Features .....  | C-3         |
| <b>Programming the Voice Mail System</b> .....              | <b>C-4</b>  |
| Card Slot Programming .....                                 | C-4         |
| Recorded Announcement Tables .....                          | C-5         |
| Programming Devices for Flash-based Voice Mail System ..... | C-6         |
| Programming System Functions Via Telephone .....            | C-7         |
| Programming System Functions Via Computer .....             | C-17        |
| Voice Prompts .....   | C-38        |
| Remote Programming & Maintenance Connection .....           | C-43        |
| <b>User Operations</b> .....                                | <b>C-44</b> |
| How to Use the Voice Mail System .....                      | C-44        |
| Getting Started .....                                       | C-44        |
| Message Options .....                                       | C-45        |
| Mailbox Greeting Options .....                              | C-49        |
| Passwords .....   | C-51        |
| Outcall Notification .....                                  | C-51        |
| Direct Transfer .....                                       | C-51        |

**D Hard Drive-Based Voice Mail**

**Introduction ..... D-3**  
 Basic Features ..... D-3  
**Programming the Voice Mail System ..... D-4**  
 Card Slot Programming ..... D-4  
 Recorded Announcement Tables ..... D-5  
 Programming Devices for Hard Drive-based Voice Mail System ..... D-6  
 Programming System Functions Via Computer ..... D-8  
 Programming System Functions Via Telephone ..... D-36  
 Voice Prompts ..... D-43  
 System Maintenance ..... D-44  
 Troubleshooting ..... D-54  
**User Operations ..... D-56**  
 How to Use the Voice Mail System ..... D-56  
 Getting Started ..... D-57  
 Message Options ..... D-58  
 Mailbox Options ..... D-61

**E Customer Database Programming**

**Introduction ..... E-3**  
**Program Mode Entry (Key Station) ..... E-6**  
**Program Mode Entry (Data Terminal or PC) ..... E-6**  
**Initialization ..... E-6**  
**Database Programming Worksheets ..... E-7**  
**Database Upload/Download Routine ..... E-7**  
 Upload/Download through Remote Administration ..... E-7

**F Quick Reference**

**Flash Code Index ..... F-3**  
**Default Numbering Plan ..... F-16**





---

---

# 1

# Introduction

This manual provides the information necessary to operate and maintain the *STSe* System. The described features are based on the current software release. If any of these features do not work on your system, call your sales representative regarding upgrade of your system.

» » » » » » » »

# NOTES

» » » » » » » »

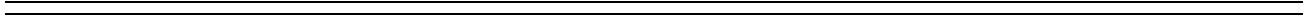

---

## General Description

### **Allows Flexibility and Software Control**

The *STSe* Digital Key Telephone System is a fully digital hybrid Key Telephone System, designed to meet the telecommunication needs of small to medium-sized business offices.

The system has been designed to allow a high level of software control over the system's hardware. The software incorporates a vast array of features and capabilities including PC Database Administration and Least Cost Routing.

### **Incorporates Command Processing & Voice Switching**

The *STSe* System incorporates state of the art digital technology for command processing and voice switching, using a Pulse Code Modulation/Time Division Multiplexing (PCM/TDM, "A" law or "U" law) distributed switching matrix.

### **Supports Multiple Devices**

The *STSe* system supports a combination of Digital Keysets and wireless terminals as well as analog single line devices. With the keysets, commonly used features are activated by direct button selection. Additionally, many functions may be accessed by dialing specific codes or optionally, by assigning these dial codes to Flexible Buttons on the keyset. In addition to key telephones, an array of optional terminals is available.

With the flexibility of the *STSe* extensive feature content, and the capability to use an array of instruments, the *STSe* can be tailored to meet the short and long term needs of the most demanding customer requirements.

*Introduction**System Features*

*This page displays a condensed list of the extensive features available in the STSe System:*

|  |  |
|--|--|
| 911 Feature                                | Incoming Calling Line Identification   |
| Account Codes                              | Initializing - System Parameters       |
| Answering Machine Emulation                | Intercom                               |
| Attendant Assignment / Features            | Inter-Digit Time-Out                   |
| Automatic Privacy                          | Keypad Mode                            |
| Background Music                           | Last Number Redial                     |
| Battery Back-Up (Memory)                   | LCD - Contrast                         |
| Baud Rate Assignments                      | LCD - Display                          |
| Call Back                                  | Least Cost Routing (LCR)               |
| Call Coverage                              | Message Wait                           |
| Call Forward                               | Message Waiting Reminder Tone          |
| Call Forward - Preset                      | Music-On-Hold                          |
| Calling Forward Override                   | Mute Key                               |
| Calling Station Handsfree Mode Override    | Name In Display                        |
| Calling Station Tone Mode / Override       | Name / Number Translation Table        |
| Call Park - Station                        | Night Service                          |
| Call Park - System                         | Off-Hook Signaling                     |
| Call Pickup                                | Off-Hook Voice Over                    |
| Call Transfer                              | Outside Calls                          |
| Camp On                                    | Paging                                 |
| Centrex/PBX                                | Pause Timer                            |
| Class Of Service (COS)                     | PBX Dialing Codes                      |
| CO Line - Access                           | Personal Messages                      |
| CO Line Attributes                         | Preferred Line Answer                  |
| CO Line DTMF Sending                       | Printing - System Parameters           |
| CO Line Group                              | Privacy Release                        |
| CO Line - Identification                   | Private Line                           |
| CO Line - Incoming Ringing Assignment      | Recall                                 |
| CO Line Loop and Pool Buttons              | Repeat Redial                          |
| CO Line - Loop Supervision                 | Relay Programming                      |
| CO Line - Queue                            | Remote Administration*                 |
| CO Line - Ringing Options                  | Remote System Monitor And Maintenance* |
| CO Port Parameters                         | Save Number Redial (SNR)               |
| CO Ring Detect Timer                       | Single Line Telephone (SLT)            |
| Conference                                 | Software Version (MBU)                 |
| Cordless Key Telephone Unit Feature Button | Speakerphone                           |
| Database Administration                    | Speed Dial                             |
| Database Printout (Dump)                   | Station Attributes                     |
| Dial By Name                               | Station Identification                 |
| Dial Pulse Sending                         | Station Message Detail Recording       |
| Direct Inward System Access (DISA)         | Station Relocation                     |
| Direct Station Selection / Busy Lamp Field | Station Speed Dial Numbers             |
| Direct Transfer Mode                       | System Parameters                      |
| Directory Dial                             | System Reset                           |
| Distinctive Ringing                        | System Speed Bin Access                |
| Do Not Disturb                             | Text Messaging (Silent Response)       |
| Executive Override                         | Toll Restriction                       |
| Executive / Secretary Pairs                | Uniform Call Distribution (UCD)        |
| External Day Ring                          | Universal Day/Night Answer             |
| External Night Ring                        | Voice Mail                             |
| Fixed Station/Port Number                  | Voice Mail In-Band Features            |
| Flash Rates (Programmable)                 | Voice Mail One-Touch Recording         |
| Flexible Button Assignment                 | Voice Mail Outpulsing Table            |
| Flexible Numbering                         | Volume Control                         |
| Group Listening                            |  |
| Headset Mode                               |  |
| Hold - Exclusive                           |  |
| Hold - Preference                          |  |
| Hold - System                              |  |
| Hot Keypad                                 |  |
| Hot Line / Ring Down                       |  |
| Hunt Groups                                |  |
| ICLID / Caller ID*                         |  |
| Idle Speaker Mode                          |  |

\* = May require additional hardware or software

## *Digital Keypad Telephones*

Each STSe System provides all the keys, indicators, and features described.

**Handset and Speaker** are located at the left side of the front panel. A handset is provided to allow confidential conversation when desired. Lifting the handset from its cradle (going off-hook) disengages the station's built-in speaker. The speaker is located directly below the center portion of the handset. The station may be operated with the handset on-hook. When this occurs, audio is transmitted to the station user through the station's speaker.

**Flexible Buttons** provide access to idle outside lines, DSS/BLF for internal stations, access speed dial numbers and activate features. These buttons can be programmed by the individual station user. The default flexible feature buttons are described as follows:

- » CALL BACK button lets you initiate a call back request to another busy station. As soon as that station becomes idle, the station that left the call back request is automatically signaled. A flexible button must be assigned to use this feature.
- » PICK-UP button lets you pick up a tone ringing intercom call, transferred, incoming, or recalling outside call to a specific unattended station, by group or directed call pick-up.
- » DND (DO NOT DISTURB) button lets the user place their telephone into Do Not Disturb mode to eliminate incoming outside line ringing, intercom calls, transfers and paging announcements. The station in DND can use the telephone to make normal outgoing calls. On Attendant stations, this button becomes the system Night Mode button. A flexible button must be assigned to use this feature.
- » LINE QUEUE button lets you queue to an outside line when all lines in a group are busy. Your station is placed in queue, awaiting a line in the same group to become available.

**Outside Calls** are announced by a tone signal repeated every 3.2 seconds. The corresponding outside line indicator flashes slowly.

**Intercom Calls** can be tone ringing or voice announced. If voice announced, the receiving station receives three tone bursts prior to the announcement. If a tone ringing call, the receiving station hears a tone ring every 2.4 seconds.

*Introduction*

### 24-Button Speakerphone

The 24-button Digital Telephone has 24 flexible, dual color LEDs that can be customized for each application.

When the flexible buttons are used as DSS buttons, station status can be seen in a single glance. When they are used as CO/PBX/Centrex buttons, line status is easily monitored.

This integrated speakerphone offers call announce with hands-free intercom and a hot keypad that allows dialing while the phone is on-hook.

The three interactive soft keys provide additional feature functionality.



### DSS Console

When the DSS Console is added, 48 additional buttons can be used to support an attendant or other answering position.



### 24-Button Digital Keypad / Button Diagram

The following illustration and its corresponding table describe the physical features of the Vodavi 24-Button Digital Display Telephone (P/N 3515).

#### Programming Requirement

A 24-button display telephone is necessary when programming the system features and functions available with the STSe System.

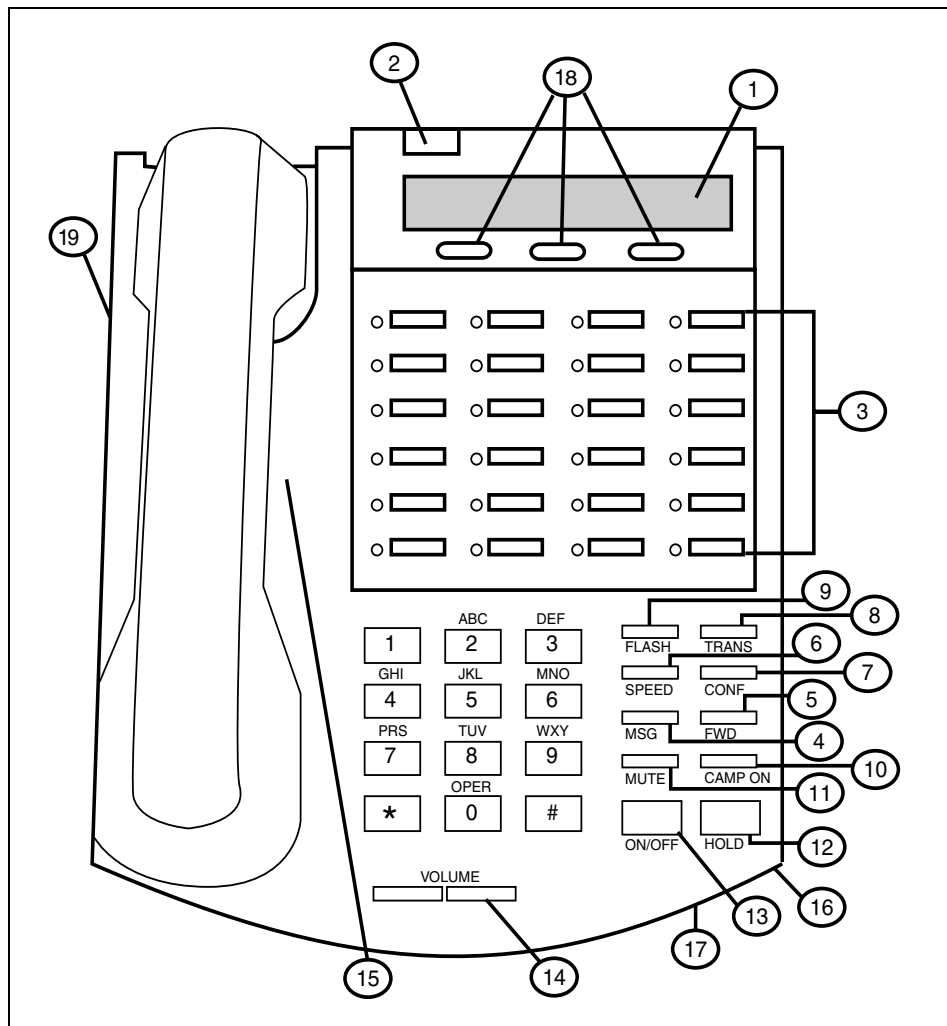

Figure 1-1: 24-Button Digital Key Telephone

**Table 1-1: 24-Button Digital Key Telephone Buttons**

| <b>NUMBER</b> | <b>FEATURE BUTTON</b> | <b>FUNCTION</b>  |
|---------------|-----------------------|--|
| <b>1</b>      | Display               | Displays information about telephone status, dialing directories, and text message information.  |
| <b>2</b>      | Message Indicator     | Programmable indication for Ring Line, Voice Mail, Message Wait, or handset operation  |
| <b>3</b>      | Flexible Button Keys  | Used to access outside lines or access call-handling features.   |
| <b>4</b>      | MSG Key               | Used for Auto-CallBack to a telephone which has left a text message or to access voice messages.   |
| <b>5</b>      | FWD Key               | Used to forward your calls to another destination, such as a station or voice mail.  |
| <b>6</b>      | SPEED Key             | Used to access speed dialing, save number redial and last number redial. This button also is used to access flexible button programming. |
| <b>7</b>      | CONF Key              | Used to establish conference calls.  |
| <b>8</b>      | TRANS Key             | Used to transfer an outside call from one station to another.  |
| <b>9</b>      | FLASH Key             | Used to end an outside call and to restore dial tone without hanging up receiver.  |
| <b>10</b>     | CAMP ON               | Used to alert a busy station that an outside line is on hold and waiting for them.   |
| <b>11</b>     | MUTE Key              | Used to activate/deactivate MUTE function. When activated, the party on the other end cannot hear you.                                   |
| <b>12</b>     | HOLD Key              | Used to place outside calls on hold or to retrieve held calls.   |
| <b>13</b>     | ON/OFF Key            | Used to make a call without lifting the handset.   |
| <b>14</b>     | VOLUME Key            | Used to adjust level of tones, background music, ringing, receiver volume, and display contrast.   |
| <b>15</b>     | Speaker               | Outputs tones and voice at your extension.   |
| <b>16</b>     | Microphone            | Used to talk with other party without using the handset.   |
| <b>17</b>     | H-T-P                 | Used to select mode of operation: Handsfree, Tone, or Privacy.   |
| <b>18</b>     | Interactive Soft Keys | Used to work in conjunction with fixed and flexible features.  |
| <b>19</b>     | Headset Jack          | 2.5 mm Headset Jack is located on the left side of the telephone.  |



---

---

# 2

## Features and Operation

Detailed descriptions of the System and Station features are presented in alphabetical order. An abbreviated feature index, that is organized in Flash code numerical sequence, is provided in [Appendix F](#).

» » » » » » » »

# NOTES

» » » » » » » »

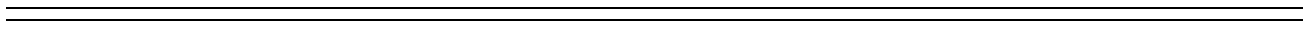

---

## About This Manual

### *Content Summary*

#### **Chapters**

The following chapters contain the descriptions, programming steps, and operating procedures for the more commonly-used features and functions.

- 2 - Features & Operation
- 3 - Attendant Features & Operation
- 4 - Uniform Call Distribution (UCD)

#### **Appendices**

Appendices contain detailed information on how to use the more complex features available. Worksheets and Tables are in the last two appendices for easy access to specific customer system information and frequently-used flash and feature codes.

- A - ICLID / Caller ID
- B - Least Cost Routing
- C - Flash-Based Voice Mail
- D - Hard Drive-Based Voice Mail
- E - Customer Database Programming
- F - Quick Reference Tables
  - Flash Codes
  - Default Numbering Plan

## Manual Format & Description

This diagram explains how the Features/Operations are organized in the following chapters and appendices. The manual format follows the basic outline as shown, but omits those elements that do not apply to a particular Feature or Operation.

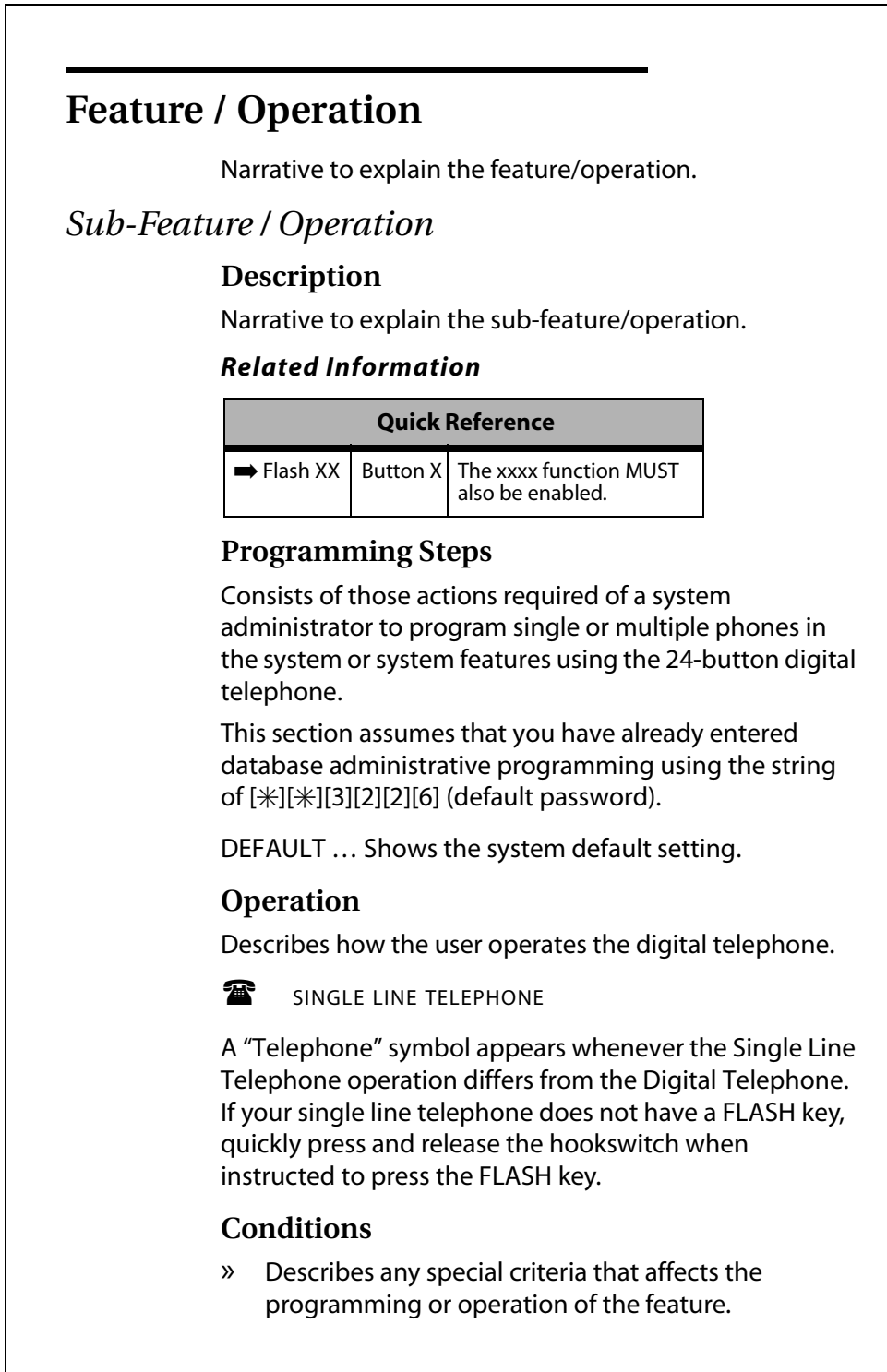

## 911 Feature

### Description

The 911 Feature allows stations in the system to dial 911 without using an access code. 911 calls are placed on 911 marked lines. If all lines are busy, an existing call is dropped and the 911 call is placed.

When this feature is enabled, Trunk Group/LCR Access Code 9 is not available.

### Related Information

| Quick Reference |  |   |
|-----------------|--|---|
| ➔ Flash 12      |  | To insert [9] for Centrex 911 calls (refer to <a href="#">"PBX Dialing Codes" on page 2-60</a> ). |

### Programming Steps

#### To enable/disable the 911 feature:

1. Press the 911 FEATURE flexible button (**FLASH 06, Button #13**). The following displays:

|                         |     |
|-------------------------|-----|
| 911 FEATURE<br>DISABLED | 0-1 |
|-------------------------|-----|

2. Enter a 0 or 1 on the dial pad to enable/disable the use of this feature.
  - [0] = Disabled
  - [1] = Enabled

DEFAULT ... Disabled

#### To designate the line(s) for 911 use:

1. Press **FLASH** and dial **[40]**. The following message displays:

|  |
|--|
| CO LINE ATTRIBUTES<br>SELECT A CO LINE RANGE |
|--|

2. Enter a valid number for the range of lines being programmed. If only one line is being programmed, enter that number twice (001 001).

|   |   |
|---|---|
|  <b>Note</b> | If HOLD is pressed without entering a CO line range, all CO lines are selected. |
|---|---|

3. Press HOLD to save the entry. A confirmation tone sounds and the display updates. Flexible button #19 (Page A) is lit. The following message displays to indicate current programming of that line or group of lines:

|   |
|---|
| XXX - XXX PAGE A<br>ENTER BUTTON NUMBER |
|---|

XXX-XXX = CO Line Range

4. Press **Button #15** to designate the line for 911 use.

|                       |     |
|-----------------------|-----|
| 911 TRUNK<br>DISABLED | 0-1 |
|-----------------------|-----|

5. Enter a 0 or 1 on the dial pad to enable/disable this feature.  
[0] = Disabled  
[1] = Enabled
6. Press HOLD to save the entry. A confirmation tone sounds and the display updates.

DEFAULT ... Disabled

## 911 Alert

### Description

Any station user or Attendant who programs a flexible button for 911 ALERT (feature code 608) will be alerted of internal stations placing 911 calls. The system can store the sixteen most recent 911 calls. Calling information includes the time/date of the call, as well as the station number from which the call was placed.

The initial 911 Alert indications include:

- Audible ringing tone
- Green flashing 911 ALERT flexible button LED
- Automatic LCD display of 911 call information

|           |     |          |
|-----------|-----|----------|
| E911 CALL | XX: | STA XXXX |
| MM/DD/YY  |     | HH:MM    |

*XX = Index number (01-16)*

### Operation

Station users and Attendants can press the 911 ALERT flexible button as necessary to view additional 911 calls' information in the stored list. After a station user or Attendant views the information for all 911 calls in the system list:

- All users' LEDs change to a solid red indication.
- The audible ringing tone at all stations ceases.
- The LCDs at all stations revert to a normal display.

The list remains available for review by pressing the 911 ALERT flexible button as necessary, until after the messages are deleted.

#### **To delete logged 911 Alert messages:**

An Attendant uses the following steps to delete the messages on a system-wide basis.

1. Press the 911 ALERT flexible button to display the 911 call information for deletion.
2. Press FLASH to delete that message.

## Enhanced 911 Integration

### Description

The E911 feature integrates the system to the Proctor PBX ANI-LINK product to provide enhanced 911 service. Loop Start lines can be connected to the Proctor unit and programmed to be 911 lines (FLASH 40, Page A, Button #15). When a 911 call is made from a station in the system, the system will send 911XXXX (XXXX=Station # that placed the 911 call) in DTMF format to the Proctor. If the station number is less than 4 digits, a leading 0 will automatically be added. The Proctor unit then accesses a CO trunk and sends the information in the proper format to the 911 Center.

This feature also provides a means to identify a power failure signal from the Proctor Unit. If a power failure signal is detected, the KSU routes 911 calls via trunks other than those marked for 911 use until the signal is removed.

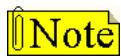

*The E911 feature ensures access to 911 by freeing a CO Line, then making a call. If you are using Centrex lines, a 2-second setting is recommended for Guard Timer programming (Flash 40, Page C, Button #6). This avoids situations where a line is seized by the 911 call before an existing call is dropped, causing the emergency call to be conferenced with the existing call.*

### Programming Steps

1. Press the ENHANCED 911 button (**FLASH 06, Button #14**). The following message displays:

|              |     |
|--------------|-----|
| ENHANCED 911 | 0-1 |
| DISABLED     |     |

2. Enter a 0 or 1 on the dial pad to enable/disable the use of this feature.

[0] = Disabled

[1] = Enabled

DEFAULT ... Disabled

### Conditions

- » The 911 Feature (FLASH 06, Button #13) must be enabled for Proctor Integration to work.
- » Only the lines connected to the Proctor should have the 911 Enable programmed (FLASH 40, Page A, Button #15).
- » It is recommended to have a power failure procedure in place to ensure that 911 calls are always routed. Refer to FLASH 09, Button #7 for programming information.

## Enhanced 911 Power Failure Station

### Description

The power failure signal is designed to be used with the normally open (NO) power failure leads from the Proctor unit connected to an SLT port or SLA device. When the leads close in power failure, this is detected as an off hook and 911 routing ceases to the Proctor unit. 911 calls are sent via trunks other than those marked for 911 use until the power failure lead opens, which is detected as an on hook. 911 calls are then routed again to the Proctor unit.

### Programming Steps

1. Press the E911 POWER FAILURE STATION button (**FLASH 09, Button #7**). The following message displays:

|                 |      |
|-----------------|------|
| PROCTOR 911 P/F | #### |
| ####            |      |

2. Enter a valid SLT station number (100-8999) to be used as the power failure station.
3. Press HOLD to save the entry. A confirmation tone sounds.

### Conditions

- » During a power failure, 911 calls are sent via trunks other than those marked for 911.
- » During a power failure, the station's digit information is not sent.
- » The feature requires either an SLT port or an SLA port for the integration to work.

---

## Account Codes

### Description

An account code is the last field within Station Message Detail Recording (SMDR), that provides tracking capabilities for specific calls by entering a verified/non-verified, variable length (up to 12 digits) identifier.

The use of forced Account Codes is optional, offered on a system-wide basis.

### Related Information

| Quick Reference |          |  |
|-----------------|----------|--|
| ➡ Flash 21      | Button 1 | The SMDR function <b>MUST</b> be enabled for the Forced Account Code feature to operate (refer to <a href="#">"SMDR Enable/Disable" on page 2-288</a> ). |



## Account Codes - Forced

### Description

The STSe allows arranging of the system so that all station users must enter an account code before placing an outside call.

Account codes can also be used as a Traveling Class-of-Service to upgrade a restricted station's class-of-service for unrestricted dialing. Account codes must be entered before the call when forced.

The system can force account codes on all restricted calls.

- When the Forced Account Code option is enabled, and the account code is entered, a station's Class of Service is upgraded to day COS1, night COS1.
- If option is disabled, a station's COS is not upgraded but the account code continues to be part of the SMDR record.

### Programming Steps

1. Press ACCOUNT CODES flexible button (**FLASH 05, Button #8**) to determine whether the use of Account Codes is forced or optional.
2. Enter a 0 or 1 that corresponds with the following entries:
  - [0] = Disabled
  - [1] = Enabled

|  |
|--|
| FORCED ACCOUNT CODE    0-1<br>DISABLED |
|--|

3. Press HOLD to save the entry. A confirmation tone sounds.

DEFAULT ... Account Codes are optional.

### Operation

- » If the account code contains fewer than 12 digits, dial [\*] to return to the intercom dial tone or to return to the call.
- » In order for an account code to become part of the SMDR record, the SMDR function must be enabled. Refer to ["SMDR Enable/Disable" on page 2-288](#)

### **Prior to placing an outside line call or during an outside line call:**

1. Press the preprogrammed ACCOUNT CODE button (feature code 627 - refer to ["Flexible Button Function Assignment" on page 2-163](#)).
2. Dial account code up to 12-digits.
3. Dial [9] or CO Access code. Dial tone sounds.
4. Dial the desired number.



## SINGLE LINE TELEPHONE

**To enter an Account Code before a call:**

1. Lift the handset.
2. Dial [627].
3. Dial the account code.
4. Dial [9] or CO Access code. Dial tone sounds.
5. Dial the desired number.

**To enter an Account Code during a call:**

1. Press the FLASH button. Your call will be placed on executive hold while you enter your account code.
2. Dial [627].
3. Dial the account code.

*Account Codes - Traveling COS (Verified)***Description**

The Verified Account Code/Traveling Class of Service (COS) feature provides the ability to track specific calls by entering a verified, variable length (up to 12 digits) identifier. Each account code can be assigned a day and night Class of Service for determining the dialing privileges allowed by that account code.

This feature provides a means for users to override a restricted station. If the dialed account code matches the Verified Account code table, an intercom dial tone is returned, otherwise an error tone is presented.

Using verified Account Codes is optional, available on a system-wide basis. SMDR must be enabled for the account code to print as part of the SMDR record. The STSe allows up to 250 12-digit account codes for verification purposes.

**Programming Steps****To enable or disable Verified Account Codes:**

1. Press the VERIFIED ACCT CODES flexible button (**FLASH 06, Button #3**). The following message displays:

|                     |     |
|---------------------|-----|
| VERIFIED ACCT CODES | 0-1 |
| DISABLED            |     |

2. Enter 0 or 1 on the dial pad to enable/disable Verified Account Codes.  
[0] = Disabled  
[1] = Enabled
3. Press HOLD to save the entry. A confirmation tone sounds.

DEFAULT ... Verified Acct Codes are disabled.

**To assign Verified Account Codes:**

1. Press **FLASH** and dial **[31]**. The following message displays:

|              |     |
|--------------|-----|
| ACCT         | COS |
| XXXXXXXXXXXX | ##  |

*ACCT = Up to 12-digit account code*

*COS = Class of Service for account codes*

2. Press the ACCT CODE flexible button (**Button #1**). Enter up to 12 digits (0-9, \*, #). [\*] represents a do not care digit. The system ignores all digits after this digit when entering an account code. The [#] represents a single do not care digit.
3. Press the CLASS OF SERVICE flexible button (**Button #2**). Enter a 2-digit Class of Service Number (1-7) that corresponds to Class of Service 1-7. The first digit represents Day COS and the second digit represents Night COS.
4. Press HOLD to complete the entry. A confirmation tone sounds.

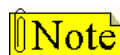

*Existing account code entries display in numerical order from lowest to highest. If an existing account code displays on the LCD when FLASH 31 is initially entered, the programming procedure creates a new account code, but does not delete the account code initially shown. If the intent is to **change** an existing account code from one number to another, perform the assignment procedure and delete the undesired account code entry by following the procedure in the following section.*

DEFAULT ... No Account Codes are assigned.

**To delete the currently displayed Verified Account Code:**

1. Press the DELETE CODE flexible button (**Button #3**) to delete the entire account code entry.
2. To display the next account code on the LCD, press the NEXT flexible button (**Button #18**).
3. To display the previous account code on the LCD, press the PREVIOUS flexible button (**Button #19**).

**To erase previously entered digits:**

1. Press the ERASE DIGITS flexible button (**Button #4**)
2. Each press of the button erases one digit. Continue until all desired digits are erased.
3. Re-enter the correct digits, then press HOLD to complete the entry. A confirmation tone sounds.

## Operation

### To use Verified Account Codes:

1. Press preprogrammed ACCOUNT CODE button before accessing a CO line.
2. Dial the account code up to 12-digits. If the account code matches a verified account code, intercom dial tone is returned. Otherwise an error tone is presented.



*SMDR must be enabled for the account code to become part of the SMDR record.*

3. Access the outside CO line or dial the LCR code and dial the desired numbers.

### To enter an Account Code before a call:

1. Lift the handset.
2. Dial [627].
3. Dial the account code.
4. Dial [9] or CO Access code. Dial tone sounds.
5. Dial the desired number.

## Conditions

- » Verified Account Codes allow use of an account code as a traveling Class of Service.
- » If LCR is activated in the system and verified account codes are activated, the user must enter the account code before dialing the LCR code.
- » When verified account codes are activated, station MUST enter an account code to dial a number that is restricted through station COS and toll restriction. An account code is not required for calls that are unrestricted through station COS and toll restriction.
- » When verified account codes are not forced, a station user may place a call without entering an account code. In this case, the station user's COS is based on their station COS, but a user can enter a verified account code to upgrade their COS.
- » The Redial feature does not support Verified Account Codes.
- » Keypad users must preprogram an ACCOUNT CODE flexible button.

## Initialize Verified Account Code Table

### Description

The Verified Account Code Table may be initialized to set all data fields to default values.

**Table 2-1: Verified Account Code Table Defaults**

| Program Code | Flexible Button        | Features         | Default Value (after initialization) |
|--------------|------------------------|------------------|--------------------------------------|
| FLASH 31     | VERIFIED ACCOUNT CODES |                  |                                      |
|              | 1                      | Account Code     | None                                 |
|              | 2                      | Class of Service | None                                 |
|              | 3                      | Delete Code      | N/A                                  |
|              | 4                      | Erase Digits     | N/A                                  |

### Programming Steps

1. Press the INITIALIZE ACCT CODES flexible button (**FLASH 80, Button #14**). The following message displays:

INITIALIZE ACCT CODES  
PRESS HOLD

2. Press the HOLD button. A confirmation tone sounds.

## Print Verified Account Codes

### Description

The Print Verified Account Codes command dumps the entire database as a permanent record which can serve as a hardcopy of the database. The system baud rate must match that of the printer or receiving device.

|                    |    |    |    |                           |
|--------------------|----|----|----|---------------------------|
| ACCOUNT CODE TABLE | 11 | ## | 26 | ##                        |
| ENTRY COS DGTS     | 12 | ## | 27 | ##                        |
| -----              | 13 | ## | 28 | ##                        |
| 00 ##              | 14 | ## | 29 | ##                        |
| 01 ##              | 15 | ## | 30 | ##                        |
| 02 ##              | 16 | ## | 31 | ##                        |
| 03 ##              | 17 | ## | 32 | ##                        |
| 04 ##              | 18 | ## | 33 | ##                        |
| 05 ##              | 19 | ## | 34 | ##                        |
| 06 ##              | 20 | ## | 35 | ##                        |
| 07 ##              | 21 | ## | 36 | ##                        |
| 08 ##              | 22 | ## | 37 | ##                        |
| 09 ##              | 23 | ## | 38 | ##                        |
| 10 ##              | 24 | ## | 39 | ##                        |
|                    | 25 | ## | 40 | ##                        |
|                    |    |    |    | ... and so on through 249 |

**Figure 2-1: Verified Account Codes Printout**

## Programming Steps

1. Press PRINT ACCT CODES flexible button (**FLASH 85, Button #15**). The following displays:

```
PRINT ACCT CODES
PRESS HOLD
```

2. To print the VERIFIED ACCT CODES, press the HOLD button. The following displays:

```
PRINTING ACCT CODES
```

When the system finishes sending the requested information to the printer, a confirmation tone sounds.

---

## Answering Machine Emulation

### Description

When a call is sent to a voice mailbox, the station associated with that can press a preprogrammed button to listen to the caller leaving the voice mail message. If the mailbox owner decides to speak with the caller, the owner can press the preprogrammed button to be connected to the caller.

Two methods of notification are available, Ring Mode or Speaker Mode. The preprogrammed button type (654+0=Ring Mode, 654+1=Spkr Mode) defines the operation mode.

EXAMPLE -- Station A user places their phone in the answering machine mode by pressing the flexible button programmed on the telephone. The button light is solid red. Whatever button type is assigned on the telephone defines the operation mode of the feature.

When an incoming CO call rings at a station and forwards (except busy type) to the station's voice mailbox:

- In RING MODE, the preprogrammed answering machine flexible button flashes at 480 ipm red while the caller is in the owner's mailbox. The mailbox owner presses the preprogrammed flashing button and the audio is broadcast over the speaker of the keyset. The mute key is enabled on the keyset at this point. The LED light is solid green.
- In SPKR MODE, the voice mail message is broadcast over the speaker. The mute key is enabled on the keyset and the LED light is solid green.

### Display Messages

When a call is ringing the station in ring mode, this message displays:

```
SCREENING RING
MMM DDYY          HH:MM am
```

When a station is monitoring the caller in VM, this message displays:

```
SCREENING
MMM DD YY         HH:MM am
```

**NOTE ...** Answering Machine Emulation only operates on Station No Answer Call Forwarding.

## Operation

### **To set the Operation Mode:**

1. Press [SPEED] + [SPEED].
2. Press the desired flexible button for programming.
3. Dial [654] + [0] to select the ring mode or dial [654] + [1] to select the speaker mode.  
A confirmation tone sounds.

### **The Mailbox Owner has the following options when a call is sent to a voice mailbox:**

**To leave the caller in the voice mail** and stop the speaker broadcast, press the ON/OFF button. The mailbox owner can continue to listen to the message being left without taking action at their keyset. When the caller disconnects after leaving the voice mail message, the button returns to solid red and the keyset returns to idle.

**To talk to the party** leaving the message, press the MUTE key. The station remains in the CONF mode, and the caller hears the voicemail and the station user.

**To pick up the call**, press the ANSWERING MACHINE EMULATION flexible button. When the call is picked up, the voice mail system disconnects from the call, and the voice mail port returns to the idle (waiting) state. The caller is in a normal talk state with the CO caller.



#### SINGLE LINE TELEPHONE

Answering Machine Emulation cannot be used with Single Line Telephones.

## Conditions

- » The user must have a digital Keyset.
- » Keyset users must preprogram an ANSWERING MACHINE EMULATION flexible button.
- » After the in-band digits are sent to the voice mail, the station's flexible button status is checked. The feature is executed based on this check. The result of the check is as follows:  
Inactive = no feature operation executed  
Active = feature executed as per button function (ring mode or speaker mode)
- » An idle station can press the flexible button to go to the inactive mode. The LED extinguishes and no answer machine calls are presented to the station.
- » When button is programmed at the station, it is in the inactive mode (LED extinguishes).
- » If the station user answers the call, the normal CO line LCD window displays. The call timer shows the elapsed time including the time the caller was in VM. The call timer does not start at 0 in this case.

---

## Attendant Assignment/Features

Refer to [Chapter 3, Attendant Features and Operation](#).

---

## Automatic Privacy

### Description

Privacy is automatically provided on all calls. If one station is conversing, another station cannot intrude on that line.

The Automatic Privacy feature can be disabled, allowing up to seven other stations to join in on existing CO line conversations. Refer to *"Privacy Release" on page 2-254* for details.



Disabling of the privacy feature may be limited by federal, state or local law, so check the relevant laws in your area before disabling privacy.

---

## Background Music

### Description

Each digital telephone user may receive music over their speaker when an optional music source is connected to the system. The Background Music feature can be allowed or denied on a system-wide basis by programming. The system can be programmed to let stations activate their Background Music, in addition to Music-On-Hold.

### Programming Steps

1. Press the BACKGROUND MUSIC flexible button (**FLASH 05, Button #6**).
2. Enter a valid number (0 or 1) that corresponds with the following:  
[0] = Disabled or [1] = Enabled

|                  |     |
|------------------|-----|
| BACKGROUND MUSIC | 0-1 |
| ENABLED          |     |

3. Press HOLD to save the entry. A confirmation tone sounds.

DEFAULT ... Background Music channel is enabled.

### Operation

1. Dial **[632]** on the dial pad or press the preprogrammed flexible button. Enter [1] for ON or [0] for OFF on the dial pad.

|           |          |
|-----------|----------|
| 0:OFF     | 1:CH-1   |
| MMM DD YY | HH:MM am |

-or-

Use the Soft Key's BGM option as a toggle to turn background music on or off.

Confirmation tone sounds.



- Press the Volume Bar to change the volume. The following message displays:

SPEAKER BGM            [#####]  
 MMM DD YY            HH:MM am



SINGLE LINE TELEPHONE

The background music feature is not compatible with single line telephones.

**Conditions**

- » When you pick up the handset or press the ON/OFF button, music automatically discontinues.
- » When the headset is enabled, BGM discontinues.
- » A music source must be connected to the BGM/MOH connector.

---

## Back Light Display

**Description**

The STSe Key Telephone Unit can be programmed so that its LCD display background is lit. The three options for Backlight Display are:

- Off - No Back Light Display.
- On - Back Light Display always on during active calls or in an idle condition.
- In Use - Back Light Display only during active calls or when keypad or flexible buttons are pressed. The LCD will remain lit for 30 seconds after the call is completed.

**Programming**

To program the Back Light Display feature:

- Press **FLASH** and dial **[50]** or dial **[51]**. Flexible button #24 (New Range) is lit and one of the following messages displays:

**Flash 50 - Fixed Numbers**

STATION ATTRIBUTES  
 SELECT A STATION RANGE

**Flash 51 - Flexible Numbers**

ENTER STATION NUMBER

- Enter the range of **fixed** station numbers (100-149) to be programmed. If only one station is being programmed, enter that number twice, e.g., [101 101].

*If HOLD is pressed without entering a station range, All stations are selected.*

-or-

Enter a valid **flexible** number (100-8999) to be programmed.

*Features and Operation*

- Press HOLD to save the entry. A confirmation tone sounds and the display updates. Flexible button #19 is lit. The display updates to reflect current programming for Page A:

**Flash 50 - Fixed Numbers**

|   |
|---|
| XXX - XXX PAGE A<br>ENTER BUTTON NUMBER |
|---|

*XXX-XXX = fixed station range*

**Flash 51 - Flexible Numbers**

|                                    |
|------------------------------------|
| SXXX PAGE A<br>ENTER BUTTON NUMBER |
|------------------------------------|

*XXX = 3- or 4-digit flexible number*

- Press button #22. The display updates to reflect current programming for Page D.

**Flash 50 - Fixed Numbers**

|   |
|---|
| XXX - XXX PAGE D<br>ENTER BUTTON NUMBER |
|---|

*XXX-XXX = fixed station range*

**Flash 51 - Flexible Numbers**

|                                    |
|------------------------------------|
| SXXX PAGE D<br>ENTER BUTTON NUMBER |
|------------------------------------|

*XXX = 3- or 4-digit flexible number*

- Press **Button #7**. The following message displays:

|                   |     |
|-------------------|-----|
| BACK LIGHT<br>OFF | 0-2 |
|-------------------|-----|

- Enter a valid number on the dial pad to change this feature.
    - 0 = Off
    - 1 = On
    - 2 = In Use
  - Press HOLD to save the entry. A confirmation tone sounds and the display updates.
- DEFAULT ... Off.

**Operation****To select another Back Light Display option:**

- Preprogram a Back Light Display flexible button, using flexible feature code 637.
- Press the Back Light Display flexible button to rotary through the options.

---

## Battery Backup (Memory)

**Description**

A lithium battery is located on the Main Board Unit (MBU) to protect system memory in case of commercial power outage or the system power being turned off for a time period.

Battery Backup Memory retains all system features including system and station speed dial during a power outage.

---

## Baud Rate Assignments

### Description

The two RS-232 connectors on the BKSU can support features such as SMDR, ICLID, or remote programming.

PORT #1 -- First RS-232C port on the BKSU

PORT #2 -- Second RS-232C port on the BKSU

PORT #3 -- Optional modem

### Programming Steps

Press **FLASH** and dial **[15]**. The first button is lit and ready for programming Port #1. The following message displays:

| PORT | BAUD |
|------|------|
| 1    | 9600 |

1. Press the desired PORT # flexible button (**Buttons #1, #2, or #3**) to select the port to program.
2. Enter a 1-digit number for the baud rate:
 

|                 |                 |
|-----------------|-----------------|
| [1] = 150 Baud  | [5] = 2400 Baud |
| [2] = 300 Baud  | [6] = 4800 Baud |
| [3] = 600 Baud  | [7] = 9600 Baud |
| [4] = 1200 Baud |                 |

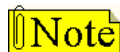

*The optional modem (port 3) has a fixed baud rate of 9600.*

3. Press HOLD to save the entry. A confirmation tone sounds and the display updates.

DEFAULT . . . Ports #1, #2, and #3 are set at the 9600 baud rate. The highest connection rate for ports #1 and #2 is 9600 baud, but the system will connect at lower speeds if necessary.

---

## Call Back

The two types of Call Back are Manual Call Back and Automatic Call Back.

### *Manual Callback*

#### **Description**

A station can initiate a call back request to another busy station. Once that station becomes idle, the station that left the call back request is signaled.

#### **Operation**

##### ***If you dial a telephone that is busy and want to activate Call Back:***

1. Press the preprogrammed CALL BACK button or use the Soft Key's CALL-BK option.
2. Hang up.  
When the busy station hangs up, you are signaled.
3. Answer the call; station you called is then signaled. (If your station is busy when signaled, an automatic MSG is left at your phone).



*A Call Back Request is automatically invoked anytime a user listens to the intercom busy tone for a preset period of time.  
Only one Call Back request can be left at a station; the second request is converted to a message wait call back request.*



SINGLE LINE TELEPHONE

##### ***If you dial a telephone that is busy and want to leave a Call Back indication:***

1. Press the FLASH button.
2. Dial [622] and replace the handset.



*Only one Call Back request can be left at a station; the second request will convert to a message waiting request.*

## Call Back Button Flash Rate

### Description

The Call Back Button flash rate is the rate at which the Call Back button flashes when a station at which you left a call back request becomes available. This flash rate can be programmed to 29 different options identified in the flash rate table. This enables the programmer to customize the key system configuration to desired flash rates.

### Programming Steps

1. Press the CALL BACK BTN flexible button (**FLASH 07, Button #16**). The following displays:

|                   |       |
|-------------------|-------|
| CALL BACK BTN     | 00-28 |
| RED 120 IPM FLASH |       |

2. Enter a valid number (00-28) on the dial pad to correspond to one of the 29 available options (refer to [Table 2-16 on page 2-163](#)).
3. Press HOLD to save the entry. A confirmation tone sounds and the display updates.

DEFAULT ... Call Back Button flash rate is set for a Red 120 ipm Flash (10).

## Automatic Call Back Timer

### Description

The Automatic Call Back Timer invokes a call back anytime a user listens to a busy tone for a programmable period of time. The Automatic Call Back Timer can be set to 00-99 seconds. Value 00 disables the timer. An Automatic Call Back does not occur when timer is disabled.

### Programming Steps

1. Press the AUTO CALL BACK TIMER flexible button (**FLASH 01, Button #17**). The following message displays:

|                |       |
|----------------|-------|
| AUTO CALL BACK | 00-99 |
| 10             |       |

2. Enter a valid number on the dial pad that corresponds to 00-99 seconds in 1-second increments.
3. Press HOLD to save the entry. A confirmation tone sounds and the display updates.

DEFAULT ... Automatic Call Back Timer is set for 10 seconds (enabled).

## Auto Call Back - BLF Flash Rate

### Description

The Auto Call Back BLF Flash Rate is the rate at which the Call Back flexible button flashes. This flash rate can be programmed to 29 different options identified in the flash rate table. This enables the programmer to customize the key system configuration to desired flash rates.

### Programming Steps

1. Press the AUTO CBCK BLF flexible button (**FLASH 07, Button #7**). The following message displays:

|                   |       |
|-------------------|-------|
| AUTO CBCK BLF     | 00-28 |
| RED 120 IPM FLASH |       |

2. Enter a valid number (00-28) on the dial pad to correspond to one of the 29 available options (refer to [Table 2-16 on page 2-163](#)).
3. Press HOLD to save the entry. A confirmation tone sounds and the display updates.

DEFAULT ... Auto Call Back BLF Flash Rate is set for a Red 120 ipm Flash (10).

---

## Call Coverage

### Description

The Call Coverage feature provides the functionality for stations to answer calls for other stations by utilizing call coverage buttons. Visual and Audible status of ringing stations to an assigned coverage station are provided. Multiple coverage stations can have the same remote ringing station(s) programmed on their stations. Once a coverage station answers the call, other stations attempting to answer the call receive a busy tone and the call coverage button extinguishes on all appearances of that button.

The Call Coverage button also functions as a DSS/BLF button for the covered station; therefore, when the Call Coverage button is pressed, the covered station is called. Also, when the covered station goes off hook, the Call Coverage button's BLF is lit.

Direct CO calls have ring and LCD priority over call coverage calls. The call coverage station must have a direct CO appearance or Loop button in order to pick up an external call. If the call coverage station is in DND, no audible ringing occurs, however visual and LCD information is presented.

This feature can be programmed by the station user or through admin programming.

DEFAULT ... No call coverage buttons are assigned.

### Operation

#### **To assign a Call Coverage Button:**

1. Press [SPEED] + [SPEED].
2. Press a desired flexible button.

3. Dial [647] for Non-Ringing or [646] for Ringing, followed by the station number to cover. A confirmation tone sounds.

**Once the button is assigned on the station and a call rings in:**

1. The coverage station receives a visual indication immediately and an audible indication for the covered station after a programmable period of time. The ring tone is the internal ring tone cadence. The flash rate is the same as the incoming CO line ringing rate.

- Ringing option = ringing, flashing Call Coverage LED, LCD display as in following illustration.

|  |
|--|
| CALL FOR STA XXXX<br>MMM DD YY                      HH:MM am |
|--|

- Non-Ringing option = flashing Call Coverage LED only (no ringing or change to LCD).

2. The Coverage station user then presses their flashing COVERAGE flexible button,  
-or-

Presses the ON/OFF button (only if the ringing option is selected).

The call is answered and ceases to ring at any other stations that may have the same coverage appearance. The following message will display after the call is answered.

|  |
|--|
| CALL FOR STA XXXX<br>FROM STA YYYY                      HH:MM am |
|--|

3. If the caller wants to be transferred to the covered station's voice mail:
  - a. Press the TRANS button.
  - b. Press the Voice Mail button.
  - c. Press the COVERAGE flexible button.
  - d. Hang up.



SINGLE LINE TELEPHONE

This feature can cover SLT extensions, however an SLT cannot perform the call coverage function. The SLT extension need not be physically installed, only the SLT card must be installed.

### Conditions

- » Direct CO calls have ring and LCD priority over call coverage calls. The call coverage station must have a direct CO appearance or Loop button to pick up an external call. If the call coverage station is in DND, no audible ringing occurs, however visual and LCD information is presented.
- » This feature can be programmed on any key station or DSS Console with an available flexible button. If the DSS with a call coverage button assigned is unplugged or moved, the station associated with that DSS stops ringing until the DSS is plugged in again.
- » Only one button type (646 or 647) per covered station can be assigned on a keyset.
- » Call Coverage ringing at the coverage station will use the distinctive ring of the covered station.

## Call Coverage Ring Timer

### Description

A Call Coverage Ring Timer enables the system administrator to set the amount of delay time before the call coverage feature provides an audible ring indication at the coverage station. The call coverage ring timer is a setting that can be applied on a per station basis.

The Call Coverage Ring Timer setting is variable from 00-99 seconds.

### Programming Steps

1. Press **FLASH** and dial **[50]** or dial **[51]**. Flexible button #24 (New Range) is lit and one of the following messages displays:

#### Flash 50 - Fixed Numbers

STATION ATTRIBUTES  
SELECT A STATION RANGE

#### Flash 51 - Flexible Numbers

ENTER STATION NUMBER

2. Enter the range of **fixed** station numbers (100-149) to be programmed. If only one station is being programmed, enter that number twice, e.g., [101 101].



If **HOLD** is pressed without entering a station range, All stations are selected.

-or-

Enter a valid **flexible** number (100-8999) to be programmed.

3. Press **HOLD** to save the entry. A confirmation tone sounds and the display updates. Flexible button #19 is lit. The display updates to reflect current programming for Page A:

#### Flash 50 - Fixed Numbers

XXX - XXX PAGE A  
ENTER BUTTON NUMBER

XXX-XXX = fixed station range

#### Flash 51 - Flexible Numbers

SXXX PAGE A  
ENTER BUTTON NUMBER

XXX = 3- or 4-digit flexible number

4. Press button #21. The display updates to reflect current programming for Page C.

#### Flash 50 - Fixed Numbers

XXX - XXX PAGE C  
ENTER BUTTON NUMBER

XXX-XXX = fixed station range

#### Flash 51 - Flexible Numbers

SXXX PAGE C  
ENTER BUTTON NUMBER

XXX = 3- or 4-digit flexible number



5. Press **Button #18**. The following message displays:

|                    |       |
|--------------------|-------|
| CALL COVERAGE RING | 00-99 |
| 05                 |       |

6. Enter a valid number on the dial pad that corresponds to 00-99 seconds.
7. Press HOLD to save the entry. A confirmation tone sounds and the display updates.

DEFAULT ... Call Coverage Ring Timer is set for 5 seconds.

---

## Call Forward

### Description

The following sections describe the programming and operation of available call forwarding options.

### *Call Forwarding*

#### Description

Stations can be allowed or denied the ability to forward all incoming CO calls, intercom calls, and transferred outside lines to another station or group.

Use Flash 50 programming when you want to modify a range of stations' attributes using **fixed** station numbers.

Use Flash 51 programming to modify a single station's attributes using a **flexible** station number.

#### Programming Steps

1. Press **FLASH** and dial **[50]** or dial **[51]**. Flexible button #24 (New Range) is lit and one of the following messages displays:

##### Flash 50 - Fixed Numbers

|  |
|--|
| STATION ATTRIBUTES<br>SELECT A STATION RANGE |
|--|

##### Flash 51 - Flexible Numbers

|                      |
|----------------------|
| ENTER STATION NUMBER |
|----------------------|

2. Enter the range of **fixed** station numbers (100-149) to be programmed. If only one station is being programmed, enter that number twice, e.g., [100 100].

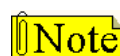

If HOLD is pressed without entering a station range, all stations are selected.

-or-

Enter a valid **flexible** number (100-8999) to be programmed.

- Press HOLD to save the entry. A confirmation tone sounds and the display updates. Flexible button #19 is lit. The display updates to reflect current programming for Page A:

**Flash 50 - Fixed Numbers**

|   |
|---|
| XXX - XXX PAGE A<br>ENTER BUTTON NUMBER |
|---|

*XXX-XXX = fixed station range*

**Flash 51 - Flexible Numbers**

|                                    |
|------------------------------------|
| SXXX PAGE A<br>ENTER BUTTON NUMBER |
|------------------------------------|

*XXX = 3- or 4-digit flexible number*

- Press the CALL FORWARD flexible button (**Button #10**). The following message displays:

|                         |     |
|-------------------------|-----|
| CALL FORWARD<br>ENABLED | 0-1 |
|-------------------------|-----|

- Enter a 0 or 1 on the dial pad to enable/disable this feature.  
[0] = Disabled  
[1] = Enabled
- Press HOLD to save the entry. A confirmation tone sounds.

DEFAULT ...Call Forwarding is enabled at all stations.

**Conditions**

- » Only one station at a time can be programmed when using a flexible station number.
- » When in Flash 51 programming, if you press HOLD without specifying a flexible number to be programmed, you will get the station that is in port/station 100.
- » Call Forward remains engaged until manually released. When released, the station number is returned to the LCD.
- » Calls cannot be forwarded to a station in the DND mode.
- » CO Line queues, a Message Waiting request, and pre-selected messages are canceled when a station is placed in the Forward mode.
- » A Forwarded Call signals to the forwarded station in the Tone mode, regardless of the Intercom Signaling Switch mode selection.
- » A station in the Forward mode can make outgoing calls.
- » A station denied the use of Call Forwarding receives an error tone when pressing the CALL FORWARD button.
- » If a CO Line rings into a station with manual Call Forward, the line sequences to the last station of the chain. If the last station is in DND mode or does not have a Direct appearance for the CO Line or a Loop button, the call reverts back to the first station.
- » If a CO Line rings into a station with both Station and Preset Call Forwarding, Station Call Forwarding takes precedence. Once the Station Forward determines the station to be rung as per above, preset Call Forward may then apply at the new station.
- » An unlimited number of stations can be set up in a Station Call Forward chain. However, a station cannot forward to a station that is already a member of their chain.

- » If the last number of the Station Call Forward chain is in DND mode, the internal caller gets a DND response.
- » If a private line rings into a station with Manual Call Forward the CO Line forwards, providing the forwarded station has a direct CO Line appearance or an available Loop button.

## *Call Forward - All Calls*

### **Description**

The Call Forward All Calls feature allows a station the ability to have all their calls (internal or external) forwarded immediately to a designated station, a UCD group pilot number, Voice Mail group number, Hunt group number, or speed dial bin number for off-net forwarding.

### **Operation**

#### **To activate All Call Forwarding:**

1. Lift handset or press ON/OFF button, press the FWD button or dial [640], then dial the All Calls code [6],  
-or-  
Use the Soft Key's ALL-FWD option when in an idle condition.
2. Press DSS button of desired station,  
-or-  
Dial the desired destination number where to forward calls, including a station number, UCD group number, Voice Mail, Hunt Group pilot numbers, and speed dial bins for off-net forwarding.
3. Replace handset; ON/OFF button extinguishes automatically, if used instead of handset.

#### **To remove All Call Forwarding:**

1. Lift handset or press ON/OFF button.
2. Either press the FWD button, dial [640] or [662], or use the Soft Key's CLR-FWD option. A confirmation tone sounds and the FWD LED extinguishes.
3. Replace handset; ON/OFF button extinguishes automatically, if used instead of handset.



#### **SINGLE LINE TELEPHONE**

The SLT operation uses the same procedures as used in Digital Telephone operation described above, except there is no FWD button or Soft Keys. The user must use the feature codes as described in the keyset section above.

### **Conditions**

- » Conditions are the same as described in the Conditions section of [“Call Forwarding” on page 2-25](#) plus those noted in the following bullets.
- » When in an All Call Forwarding mode, UCD calls cannot be received.
- » Calls to a station in both Station Call Forward and DND mode follow the forward.

## Call Forward - Busy

### Description

The Call Forward Busy feature allows a station the ability to have their calls forwarded to a designated station, a UCD group pilot number, Voice Mail group number, or Hunt group when their station is busy or in DND.

### Operation

#### **To activate Busy Call Forwarding:**

1. Lift the handset or press ON/OFF button, press the FWD button or dial [640] on the dial pad, then dial the Call Forward Busy code [8] on the dial pad.  
-or-  
Use the Soft Key's BSY-FWD option when in an idle condition.
2. Dial destination number where calls are to be forwarded. Confirmation tone sounds.
3. Replace handset; ON/OFF button extinguishes automatically, if used instead of handset.

#### **To remove Busy Call Forwarding:**

1. Lift handset or press ON/OFF button.
2. Either press the FWD button, dial [640] or [662], or use the Soft Key's CLR-FWD option. A confirmation tone sounds and the FWD LED extinguishes.
3. Replace handset; ON/OFF button extinguishes automatically, if used instead of handset.



#### SINGLE LINE TELEPHONE

The SLT operation uses the same procedures as used in Digital Telephone operation described above, except there is no FWD button or Soft Keys. The user must use the feature codes as described in the keyset section above.

### Conditions

- » Conditions are the same as described in the Conditions section of ["Call Forwarding" on page 2-25](#) plus those noted in the following bullets.
- » Calls to a station in both Station Call Forward and DND mode follow the forward.

## Call Forward - Busy / No Answer

### Description

The Call Forward Busy / No Answer feature allows a station the ability to forward a combination busy / no answer calls to a designated station, a UCD group pilot number, Voice Mail group number, or Hunt group. No answer calls forward when the system-wide no answer timer expires. Initial CO ringing, transferred CO ringing and intercom ringing calls can all be forwarded. Calls that ring to an idle station is call forwarded after expiration of the No Answer Ring Timer.

### Operation

#### **To activate Busy / No Answer Call Forwarding:**

1. Lift the handset or press ON/OFF button, press the FWD button or dial [640] on the dial pad, then dial the Call Forward Busy/No Answer code [9] on the dial pad.

-or-

Use the Soft Key's B/NA-FWD option when in an idle condition.

2. Dial the desired destination number where calls are to be forwarded. A confirmation tone sounds.
3. Replace handset; ON/OFF button extinguishes automatically, if used instead of handset.

#### **To remove Busy / No Answer Call Forwarding:**

1. Lift handset or press ON/OFF button.
2. Either press the FWD button, dial [640] or [662], or use the Soft Key's CLR-FWD option. A confirmation tone sounds and the FWD LED extinguishes.
3. Replace handset; ON/OFF button extinguishes automatically, if used instead of handset.



#### SINGLE LINE TELEPHONE

The SLT operation uses the same procedures as used in Digital Telephone operation described above, except there is no FWD button or Soft Keys. The user must use the feature codes as described in the keyset section above.

### Conditions

- » Conditions are the same as described in the Conditions section of ["Call Forwarding" on page 2-25](#) plus those noted in the following bullets.
- » ICM calls forwarded to a VM group receive ringback until a member of the VM group becomes available.
- » If a station is denied Station Call Forwarding, then Off-Net Forwarding is not allowed.
- » The No Answer Timer is controlled on an individual basis in Flash 50, Page C, Button #5 for manual forwarding and preset forwarding.

## Call Forward - Follow Me

### Description

The Follow Me feature lets a user who is away from their station, activate/deactivate call forwarding from another station in the system. This lets the user forward their calls to their current location or into Voice Mail, UCD, Hunt Groups, any other station in the system, or to an off-net location. When this call forward is activated, all calls presented to the forwarded station forward to the destination station immediately.

### Operation

#### **To activate Follow Me Call Forwarding:**

1. Lift the handset or press ON/OFF button.
2. Dial the Follow Me Forward code [642] on the dial pad.
3. Dial station number of the station from which forwarding is desired.
4. Dial the appropriate forwarding condition code.
 

|                 |                      |               |
|-----------------|----------------------|---------------|
| [6] = All Calls | [8] = Busy           | [*] = Off-Net |
| [7] = No Answer | [9] = Busy/No Answer |               |
5. Dial the three- or four-digit destination number where calls are to be forwarded (Station, Voice Mail, UCD or Hunt Group, or speed bin (only for off-net)). A confirmation sounds.
6. Replace handset; ON/OFF button extinguishes automatically, if used instead of handset.

#### **To remove Follow Me Call Forwarding:**

1. Lift the handset or press ON/OFF button.
2. Dial the Follow Me Forward code [642] on the dial pad.
3. Dial the station number of the station that forwarding is to be cancelled.
4. Dial [6] (regardless of the forward condition).
5. Redial the same station number. Confirmation tone sounds and FWD LED extinguishes.

#### **To establish Follow Me Call Forwarding (off-site location):**

1. Dial into the system on a DISA or TIE trunk. Enter the DISA access code, if applicable.
2. Dial the Follow Me Forward code [642] on the dial pad.
3. Dial the station number of the station from which forwarding is desired.
4. Dial the appropriate forwarding condition code.
 

|                 |                      |               |
|-----------------|----------------------|---------------|
| [6] = All Calls | [8] = Busy           | [*] = Off-Net |
| [7] = No Answer | [9] = Busy/No Answer |               |
5. Dial the three- or four-digit destination number where calls are to be forwarded (System Speed Bin (only for off-net), Station, Voice Mail, UCD or Hunt Groups). A confirmation tone sounds; five seconds later a dial tone is received.

#### **To remove Follow-me Call Forwarding (off-site location):**

1. Dial into the system on a DISA or TIE trunk. Enter the DISA access code, if applicable.
2. Dial the Follow-Me Forward code [642] on the dial pad.
3. Dial the station number of the station that forwarding is to be cancelled.
4. Dial [6] (regardless of the forward condition).
5. Redial the same station number. Confirmation tone sounds; 5 secs later = dial tone.

### Conditions

- » If a Call Forward mode is currently active at the station where forwarding is desired, the new forward becomes active and cancels the previous forward.
- » Both internal and external calls to the affected station forward to the designated location.
- » Call forwarding must be allowed in programming for the affected station.
- » When remote forward is activated, the forwarding is immediate.
- » A station's Call Forward status is stored in a battery protected area of memory. A station's Call Forward status is returned after a power failure or system reset occurs.
- » When a key telephone is forwarded remotely, the key station's forward button lights. The station user may cancel forwarding at their station by pressing ON/OFF, then FWD. SLT users can cancel their forwarding by going off hook and dialing the forward code.
- » DISA callers entering the code and making a mistake are given error tone for 3 seconds, silence for 2 seconds, then the dial tone is returned.

### *Call Forward - No Answer*

#### Description

The Call Forward No Answer feature allows a station the ability to have their calls forwarded to a designated station, a UCD group pilot number, Voice Mail group number or Hunt group number when there is no answer at the station. No answer calls forward when the No Answer Timer expires.

#### Operation

##### **To activate No Answer Call Forwarding:**

1. Lift the handset or press ON/OFF button, press the FWD button or dial [640] on the dial pad, then dial the Call Forward No Answer code [7] on the dial pad.

-or-

Use the Soft Key's N/A-FWD option when in an idle condition.

2. Dial the desired destination number where calls are to be forwarded. A confirmation tone sounds.
3. Replace handset; ON/OFF button extinguishes automatically, if used instead of handset.

##### **To remove No Answer Call Forwarding:**

1. Lift handset or press ON/OFF button.
2. Either press the FWD button, dial [640] or [662], or use the Soft Key's CLR-FWD option. A confirmation tone sounds and the FWD LED extinguishes.
3. Replace handset; ON/OFF button extinguishes automatically, if used instead of handset.



#### SINGLE LINE TELEPHONE

The SLT operation uses the same procedures as used in Digital Telephone operation described above, except there is no FWD button or Soft Keys. The user must use the feature codes as described in the keyset section above.

### Conditions

- » Conditions are the same as described in the Conditions section of *"Call Forwarding"* on [page 2-25](#) plus those noted in the following bullets.
- » A Camp On signal is allowed at the forwarded station if that station is busy.
- » Idle keyset in handsfree mode does not follow no answer forwarding for internal calls.
- » The No Answer Timer is controlled on an individual basis in Flash 50, Page C, Button #5 for manual forwarding and preset forwarding.

## Call Forward - External (Off-Net)

### Description

Stations are allowed to forward intercom and transferred CO line calls to an off-net location. The Call Forward Off-Net feature allows a station to reroute calls that would normally be lost. Calls can be forwarded to home or another off-net site. Initially-ringing CO calls cannot be forwarded with this feature.

### Operation

#### **To activate Off-Net Call Forwarding:**

1. Lift handset or press ON/OFF button.
2. Press the FWD button or dial [640] on the dial pad.
3. Dial [\*] on the dial pad. Dial the speed bin number (9000-9019 or 9020-9099) that contains the number where calls are to be forwarded. A confirmation tone sounds and the FWD button LED is Red Steady On.
4. Replace handset; ON/OFF button extinguishes automatically, if used instead of handset.

#### **To remove Off-Net Call Forwarding:**

1. Lift handset or press ON/OFF button.
2. Press the FWD button or dial either [640] or [662]. A confirmation tone sounds and the FWD LED extinguishes.
3. Replace handset; ON/OFF button extinguishes automatically, if used instead of handset.



#### SINGLE LINE TELEPHONE

The SLT operation uses the same procedures as used in Digital Telephone operation described above, except there is no FWD button. The user must use the feature codes as described in the keyset section above.

### Conditions

- » Forwarding is unconditional and occurs immediately when a station calls an Off-Net forwarded station.
- » The call to a station is not answered until the outgoing CO Line is seized and the digits are out-pulsed. The calling Station receives ICM ringback until answered. Upon answer, the Station receives whatever CO progress tones apply (Ringback, Busy, Error, Announcement, etc.).
- » If a station is denied Station Call Forwarding, Off-Net forwarding is not allowed.
- » Toll Restriction is based on the forwarding station's COS and the outgoing CO Line COS.



- » The calling station must have an appearance (Direct, Loop) for the outgoing (Off-Net) line. The call is not forwarded if a Direct Appearance or LOOP key is unavailable.
- » SMDR printout reflects transferred and outgoing calls like a DISA call record.
- » Station users may use a Station or System Speed Dial Bin for Station Off-Net Forward.
- » Call must be an intercom or transferred CO call.
- » The Attendant station must have access to the CO Line group used in the speed bin for the off-net forward to work.

## *Call Forward Button Flash Rate*

### **Description**

The Call Forward Button flash rate is the rate at which the Call Forward button flashes when any type of forward mode is used. This flash rate can be programmed to 29 different options identified in the flash rate table. This enables the programmer to customize the key system configuration to desired flash rates.

### **Programming Steps**

1. Press the CALL FORWARD BTN flexible button (**FLASH 07, Button #3**). The following message displays:

|                  |       |
|------------------|-------|
| CALL FORWARD BTN | 00-28 |
| RED STEADY ON    |       |

2. Enter a valid number (00-28) on the dial pad to correspond to one of the 29 available options (refer to [Table 2-16 on page 2-163](#)).
3. Press HOLD to save the entry. A confirmation tone sounds and the display updates.

DEFAULT ... Call Forward Button flash rate is set for a Red Steady On (01).

### **Conditions**

- » This feature only changes the flash rate for the fixed feature button of STSe telephones.

## Call Forward Display

### Description

When any type of station call forwarding is invoked, the LCD display normally indicates the call forwarding mode at all times. This feature has modified the LCD forwarding display to make the call forwarding mode display optional. This feature is enabled/disabled in admin programming on a system-wide basis. The call forward status is stored in a battery protected area of memory.

### Programming Steps

1. Press the CALL FWD DISPLAY STATUS flexible button (**FLASH 06, Button #4**).

|                  |     |
|------------------|-----|
| CALL FWD DISPLAY | 0-1 |
| ENABLED          |     |

2. Enter a 0 or 1 on the dial pad to enable/disable Call Forward Display.

[0] = Disabled

[1] = Enabled

3. Press HOLD to save the entry. A confirmation tone sounds.

DEFAULT ... Call Forward Display is enabled.

---

## Call Forward - Preset

### Description

The Call Forward Preset feature allows the system database to be configured so that incoming CO Lines, which are programmed to ring at a particular station, can be forwarded elsewhere in the system predetermined by programming. This feature is active if the station ringing is not answered in a specified time, and is particularly useful in overflow applications in which a Voice Mail or Auto Attendant may be in use.

The following Call Forward - Preset types are detailed in the next several sections:

**Preset Call Forward - Voice Mail, UCD, or Hunt Groups** -- CO Lines can be Preset Forwarded to ring to one of the group types in the system (Hunt, Voice Mail, or UCD). Each time the Preset Forward Timer expires (a total of 5 attempts), the group is checked for an idle station.

**Preset Call Forward - Off-Net** -- CO Lines can be preset forwarded to ring Off-Net via speed dial from any station. After the expiration of the preset forward timer, the system selects an idle CO line, dials the off-net location, then connects the two CO lines.

**Preset Call Forward - Per CO Line** -- The Preset Call Forward feature allows each CO line to be preset call forwarded on a per CO line basis. This allows a CO line to initially ring at multiple stations and forward to a predetermined destination. The destination can be a station or Hunt Group. Each CO line has a Preset Forward Timer. Each CO line also has a VMID field to allow specific VM digits to be sent when a CO line forwards to a VM group. Feature applies to initial CO ringing lines only.

If a forward destination is programmed in the CO line field, the CO call forwards to that destination after the CO Preset Forward timer expires. This forward occurs regardless of how many or how few stations the line is ringing on. Once the CO line is answered and transferred, station call forwarding rules are in effect.

Calls still follow all call or busy forwards, however, CO preset forward forwards the call if the first forward destination has not answered the call. VMID digits per CO line override station VMID. Calls ringing into UCD or VM Groups continue to ring the group. The CO call does not forward when ringing one of these types of groups.

**Preset Call Forward - Stations** -- Each station user may have Preset Call Forward in the database to direct incoming, transferred, as well as intercom calls to other destinations in the system. The system allows for different destinations based on a Busy or a No Answer condition, as well as internal versus external (CO) call.

### Preset Call Forward - Station

#### Description

The Preset Call Forward feature provides separate Busy and No Answer destinations for internal and external calls with a No Answer Timer associated to each station. External calls ringing that particular station, transferred calls, and internal calls follow this Preset Forward feature.

|             |  |
|-------------|--|
| <b>Note</b> | <p><i>Valid destination entries are:</i></p> <ul style="list-style-type: none"> <li><i>System Speed Bin Numbers</i></li> <li><i>Flexible Station Numbers</i></li> <li><i>Flexible Voice Mail Group Numbers</i></li> <li><i>Flexible Hunt Group Numbers</i></li> <li><i>Flexible UCD Group Numbers</i></li> </ul> |
|-------------|--|

Use Flash 50 programming when you want to modify a range of stations' attributes using **fixed** station numbers.

Use Flash 51 programming to modify a single station's attributes using a **flexible** station number.

#### Programming Steps

To program internal and external calls with separate Busy and No Answer destinations, perform the following steps.

1. Press **FLASH** and dial **[50]** or dial **[51]**. Flexible button #24 (New Range) is lit and one of the following messages displays:

**Flash 50 - Fixed Numbers**

STATION ATTRIBUTES  
SELECT A STATION RANGE

**Flash 51 - Flexible Numbers**

ENTER STATION NUMBER

---

*Features and Operation*

- Enter the range of **fixed** station numbers (100-149) to be programmed. If only one station is being programmed, enter that number twice, e.g., [100 100].



If HOLD is pressed without entering a station range, ALL stations are selected.

-or-

Enter a valid **flexible** number (100-8999) to be programmed.

- Press HOLD to save the entry. A confirmation tone sounds and the display updates. Flexible button #19 is lit. The display updates to reflect current programming for Page A:

#### Flash 50 - Fixed Numbers

XXX - XXX PAGE A  
ENTER BUTTON NUMBER

*XXX-XXX = fixed station range*

#### Flash 51 - Flexible Numbers

SXXX PAGE A  
ENTER BUTTON NUMBER

*XXX = 3- or 4-digit flexible number*

- Press button #21. The display updates to reflect current programming for Page C.

#### Flash 50 - Fixed Numbers

XXX - XXX PAGE C  
ENTER BUTTON NUMBER

*XXX-XXX = fixed station range*

#### Flash 51 - Flexible Numbers

SXXX PAGE C  
ENTER BUTTON NUMBER

*XXX = 3- or 4-digit flexible number*

### **Internal No Answer Destination**

- Press **Button #1**. The following message displays:

INTERNAL NO ANSWER FWD  
####

- Enter a valid flexible destination number and press HOLD.
- To delete the entry, press the [#] key and then press HOLD.

### **Internal Busy/DND Destination**

- Press **Button #2**. The following message displays:

INTERNAL BUSY FWD  
####

- Enter a valid flexible destination number and press HOLD.
- To delete the entry, press the [#] key and then press HOLD.

**Day External No Answer Destination**

1. Press **Button #3**. The following message displays:

|                |     |
|----------------|-----|
| DAY EXT NO ANS | FWD |
| ####           |     |

2. Enter a valid flexible destination number and press HOLD.
3. To delete the entry, press the [#] key and then press HOLD.

**Day External Busy/DND Destination**

1. Press **Button #4**. The following message displays:

|              |     |
|--------------|-----|
| DAY EXT BUSY | FWD |
| ####         |     |

2. Enter a valid flexible number and press HOLD.
3. To delete the entry, press the [#] key and then press HOLD.

**Night External No Answer Destination**

1. Press **Button #14**. The following message displays:

|                  |     |
|------------------|-----|
| NIGHT EXT NO ANS | FWD |
| ####             |     |

2. Enter a valid flexible destination number (if a 3-digit number, add a leading 0) and press HOLD.
3. To delete the entry, press the [#] key and then press HOLD.

**Night External Busy/DND Destination**

1. Press **Button #15**. The following message displays:

|                |     |
|----------------|-----|
| NIGHT EXT BUSY | FWD |
| ####           |     |

2. Enter a valid flexible number and press HOLD.
3. To delete the entry, press the [#] key and then press HOLD.

**Special External No Answer Destination**

1. Press **Button #16**. The following message displays:

|                    |     |
|--------------------|-----|
| SPECIAL EXT NO ANS | FWD |
| ####               |     |

2. Enter a valid flexible destination number (if a 3-digit number, add a leading 0) and press HOLD.
3. To delete the entry, press the [#] key and then press HOLD.

**Special External Busy/DND Destination**

1. Press **Button #17**. The following message displays:

|                  |     |
|------------------|-----|
| SPECIAL EXT BUSY | FWD |
| ####             |     |

2. Enter a valid flexible number and press HOLD.  
To delete the entry, press the [#] key and then press HOLD.

**Day No Answer Timer**

1. Press **Button #5**. The following message displays:

|                |       |
|----------------|-------|
| DAY NO ANS TMR | 00-99 |
| 10             |       |

2. Enter a valid number (00-99) and press HOLD (00=disable).

DEFAULT ... Day No Answer Timer is set at 10 seconds.

**Night No Answer Timer**

1. Press **Button #22** to access Flash 50/51, Page D programming.
2. Press **Button #5**. The following message displays:

|                  |       |
|------------------|-------|
| NIGHT NO ANS TMR | 00-99 |
| 10               |       |

3. Enter a valid number (00-99) and press HOLD (00=disable).

DEFAULT ... Night No Answer Timer is set at 10 seconds.

**Special No Answer Timer**

1. Press **Button #22** to access Flash 50/51, Page D programming (if not already on Page D).
2. Press **Button #6**. The following message displays:

|                    |       |
|--------------------|-------|
| SPECIAL NO ANS TMR | 00-99 |
| 10                 |       |

3. Enter a valid number (00-99) and press HOLD (00=disable).

DEFAULT ... Special No Answer Timer is set at 10 seconds.

**Internal DND Destination**

1. Press **Button #22** to access Flash 50/51, Page D programming, then press **Button #3**. The following message displays:

INTERNAL DND FWD  
####

2. Enter a valid flexible destination number (if a 3-digit number, add a leading 0) and press HOLD.
3. To delete the entry, press the [#] key and then press HOLD.

**External DND Destination**

1. Press **Button #22** to access Flash 50/51, Page D programming (if necessary), then press **Button #4**. The following message displays:

EXTERNAL DND FWD  
####

2. Enter a valid flexible destination number (if a 3-digit number, add a leading 0) and press HOLD.
3. To delete the entry, press the [#] key and then press HOLD.

**Conditions**

- » The No Answer Timer controls both Manual and Preset Forwarding (feature code 640 forwarding and FLASH 50, Page C, Buttons #1-4 and 14-17.
- » Station Forwarding overrides the Preset Forward settings.
- » Only one station at a time can be programmed when using a flexible station number.
- » When in Flash 51 programming, if you press HOLD without specifying a flexible number to be programmed, you will get the station that is in port/station 100.

***Preset Call Forward - CO Line*****Description**

The Preset Call Forward Destination feature enables a CO line to initially ring at multiple stations and forward to a pre-determined destination. The destination can be a station (DKT-SLT), Voice Mailbox, UCD group, or Hunt group. Each CO line has a Preset Forward Timer. Each CO line also has a VMID field to allow sending of specific VM digits when a CO line forwards to a VM group. Calls ringing into UCD Groups or Voice Mail Groups continue to ring the group. The CO line does not forward when ringing one of these types of groups.

## Programming Steps

1. Press **FLASH** and dial **[40]**. The following message displays:

CO LINE ATTRIBUTES  
 SELECT A CO LINE RANGE

2. Enter a valid number for the range of lines being programmed. If only one line is being programmed, enter that number twice (001 001).

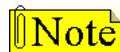

*If HOLD is pressed without entering a CO range, all CO lines are selected.*

3. Press HOLD to save the entry. A confirmation tone sounds and the display updates. Flexible Button #19 (Page A) is lit.
4. Press the Page B flexible button (Button #20). The following message displays:

XXX - XXX PAGE B  
 ENTER BUTTON NUMBER

*XXX-XXX = CO Line Range*

5. Press the PRESET FWD DAY DESTINATION flexible button (**Button #5**). The following message displays:

PRESET FORWARD DAY DEST  
 ####

6. Enter a valid forward destination on the dial pad.
  - [100-149] = Station Extensions
  - [440-447] = Voice Mail Groups 1-8
  - [450-457] = Hunt Groups 1-8
  - [550-565] = UCD Groups 1-16
7. Press HOLD. A confirmation tone sounds and the LCD display updates.
8. Press the PRESET FWD NIGHT DESTINATION flexible button (**Button #16**). The following message displays:

PRESET FWD NIGHT DEST  
 ####

9. Enter a valid forward destination on the dial pad.
  - [100-149] = Station Extensions
  - [440-447] = Voice Mail Groups 1-8
  - [450-457] = Hunt Groups 1-8
  - [550-565] = UCD Groups 1-16
10. Press HOLD. A confirmation tone sounds and the LCD display updates.



11. Press the PRESET FWD SPECIAL DESTINATION flexible button (**Button #17**). The following message displays:

PRESET FORWARD DAY DEST  
####

12. Enter a valid forward destination on the dial pad.  
[100-149] = Station Extensions  
[440-447] = Voice Mail Groups 1-8  
[450-457] = Hunt Groups 1-8  
[550-565] = UCD Groups 1-16
13. Press HOLD. A confirmation tone sounds and the LCD display updates.  
DEFAULT ... No destinations are assigned.

### Conditions

- » Preset Call Forwarding (CO Line) will not occur if initial ringing is to a group, e.g., UCD, VM, or hunt group.

## Preset Forward Voice Mail ID

### Description

The Preset Forward Voice Mail ID feature allows a programmer to assign which digits are sent to voice mail when a CO line is programmed to Preset Forward.

### Programming Steps

1. Press the PRESET FWD VMID flexible button (**FLASH 40, Page B, Button #6**). The following message displays:

PRESET FORWARD VMID 0-9999  
####

2. Enter a valid number on the dial pad that corresponds to 0-9999 for Voice Mail ID digits.
3. Press HOLD to complete the entry. A confirmation tone sounds and the display updates.

### To delete numbers currently entered:

1. Press [#] button four times.
2. Press the HOLD button to update (all information is erased).

DEFAULT ... No digits are sent.

## Preset Forward Timer (Incoming Call to a Destination)

### Description

The Preset Forward Timer determines the time an outside line rings before being forwarded to a predetermined destination as programmed in FLASH 40, Page C, Button #8. If a forward destination is programmed in the CO line field, the CO calls forward to that destination after the CO preset forward timer expires. This forward occurs regardless of how many stations the line is ringing.

This feature applies to initial CO ringing lines only and works with Preset Forward CO Line assignments. The CO Line Preset Forward Timer setting is variable from 00-99 seconds. A [00] entry disables the timer and the feature is disabled.

### Programming Steps

1. Press **FLASH** and dial **[40]**. The following message displays:

CO LINE ATTRIBUTES  
 SELECT A CO LINE RANGE

2. Enter a valid number for the range of lines being programmed. If only one line is being programmed, enter that number twice (001 001).

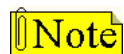

*If HOLD is pressed without entering a CO line range, all CO lines are selected.*

3. Press Button #21 to select Page C. The display updates. The following message displays to indicate current programming of that line or group of lines:

XXX - XXX PAGE C  
 ENTER BUTTON NUMBER

*XXX-XXX = CO Line Range*

4. Press the PRESET FWD TIMER flexible button (**Button #8**). The following message displays:

PRESET FWD TIMER      00-99  
 10

5. Enter valid number on dial pad which corresponds to 00–99 seconds.
6. Press HOLD to save the entry. A confirmation tone sounds and the display updates.

DEFAULT ... CO Line Preset Forward Timer is set at 10 seconds.

---

## Calling Forward Override

### Description

The Call Forward Override feature allows a user to reach a station that is call forwarded. This allows the calling station to override the forwarding which allows the user to use Off Hook Voice Over (OHVO), Executive Override, Monitor, Message Wait Indication, Camp On, or Call Back Request at that station rather than forwarding to another destination.

### Operation

1. Dial [5#] followed by the desired station extension.
2. Press the appropriate preprogrammed button.

*Call Back = [622]*

*Camp On = [620]*

*Executive Override = [625]*

*Message Wait = [623]*

*OHVO = [628]*

---

## Calling Station Handsfree Mode Override

### Description

Enables a calling station to override a called station's T intercom setting.

### Operation

***When placing a call to a station and handsfree is desired:***

1. Dial [7#] on the dial pad.
2. Dial the extension number,

-or-

Press DSS button of desired station (call connects to the station in handsfree mode).

---

## Calling Station Tone Mode Override

### Description

Enables a calling station to override a called station's H or P intercom settings.

### Operation

***When placing a call to a station and tone ringing is desired:***

1. Dial [6#] on the dial pad.
2. Dial the extension number,

-or-

Press DSS button of desired station (call tone rings station).

---

## Call Park

### *Call Park - System*

#### **Description**

An external call can be placed into one of 14 system park locations and can be retrieved by any station that has a direct line appearance or an available Loop button. Parked calls have their own recall timer that recalls the originating station, and if still unanswered, the Attendant(s).

#### **Operation**

##### **To park a call, either:**

1. Press the TRANS button. The caller will be put on hold.
2. Dial the parking location (424 to 437). A confirmation tone will sound.
3. If a busy tone is received, press TRANS twice and dial another park location, or press the CALL PARK flexible button for a different parking location.

-or-

1. Press the CALL PARK flexible button. The caller will be parked at the location programmed on the button.
2. If a busy tone is received, press TRANS twice and dial another park location, or press the CALL PARK flexible button for a different parking location.

##### **To retrieve a parked call:**

1. Lift the handset or press the ON/OFF button.
2. Press [#].
3. Dial parking location (424 to 437) where call was parked, or press the *preprogrammed* PARKED CALL PICKUP flexible button.

-or-

Use the Soft Key's P-PKP 1 option when in an idle condition (to pickup from park location 1 only).

##### **To create a PARKED CALL PICKUP button:**

1. Press [SPEED] + [SPEED].
2. Press the desired flexible button.
3. Dial [#] + the desired parking location (424-437).



SINGLE LINE TELEPHONE

##### **To park a call:**

1. Press the FLASH button. The caller is put on Exclusive Hold.
2. Dial parking location (424-437). A confirmation tone will sound.
3. If busy, press the FLASH button twice and dial another park location.

**To retrieve a parked call:**

1. Lift the handset and press the [#] button.
2. Dial parking location (424 to 437) where call was parked.

**Conditions**

- » Internal calls cannot be parked on system park locations (424-437); intercom calls can be parked using the personal park location.

*Call Park Recall Timer***Description**

This feature determines the time before a call placed in a Call Park location recalls the station placing the call in park. If unanswered by that station, the call recalls the Attendant.

The Call Park Recall Timer setting is variable from 000–600 seconds. A 000 entry disables the timer and there is no recall.

**Programming Steps**

1. Press the CALL PARK RECALL TIMER flexible button (**FLASH 01, Button #8**). The following message displays:

|                 |         |
|-----------------|---------|
| CALL PARK TIMER | 000-600 |
| 180             |         |

2. Enter a valid number on the dial pad that corresponds to 001-600 seconds.
3. Press HOLD to save the entry. A confirmation tone sounds and the display updates.

DEFAULT ... Call Park Recall Timer is set at 180 seconds.

*Call Park - Personal***Description**

Each telephone in the system can place a call into a personal park location and then later retrieve that call from the originating station. Internal calls and external calls can be placed into the stations' personal park location. Calls parked in a personal park location are subject to the system call park recall timer (refer to ["Call Park Recall Timer" on page 2-45](#)).

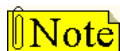

Only one call can be parked in a Personal Call Park location at one time. When dialing the Personal Park location and the location is already occupied, the initiating station receives the previously parked call and the second call is then parked.

**Operation****To park a call:**

1. Press the TRANS button. The caller is put on Exclusive Hold.
2. Dial the Personal Park location code [438] on the dial pad,  
-or-  
Press the preprogrammed PERSONAL PARK button.  
Dial tone sounds.

**To retrieve a parked call:**

Dial the Personal Call Park location code [438] on the dial pad,

-or-

Press the preprogrammed PERSONAL PARK button.

A talk path is established between the two parties.



SINGLE LINE TELEPHONE

**To park a call:**

1. Press the FLASH button. A dial tone sounds.
2. Dial [438]. Call is placed in personal park.
3. Dial [438]. The call is returned.

**Conditions**

- » If the Call Park user receives or makes a second call while the first call is parked, the user can alternately connect to the two calls by pressing the preprogrammed PERSONAL PARK button or dialing [438].
- » An external call parked in a Personal Call Park location recalls to the station that parked the call when the call park recall timer expires. The external call rings to this station until the system hold timer expires. The external call then recalls the Attendant (both the Attendant and initiating stations are ringing) and the Attendant recall timer is initiated. When the Attendant recall timer expires, the external call is disconnected.

## *Call Park - Station*

**Description**

Call park (by station number) allows external calls to be parked at a station other than your own.

**Operation****To park a call:**

1. Press the TRANS button. The call is put on Exclusive Hold.
2. Dial [439] + [XXX] (XXX=station number).

-or-

1. Press the TRANS button.
2. Press the preprogrammed CALL PARK (Station) button.
3. Dial [XXX] (XXX = station number).

**To retrieve a parked call:**

Dial [# 6] + [XXX] (XXX = the station number used to park the call) while at any telephone in the system, including the initiator's.

-or-

Dial [438] from the initiator's station.

**To create a CALL PARK (Station) button:**

1. Press [SPEED] + [SPEED].
2. Press the desired flexible button.
3. Dial [439] + [#]. A confirmation tone sounds.



SINGLE LINE TELEPHONE

The SLT user cannot park a call using the Call Park - Station feature. The SLT user can retrieve a Call Park - Station call by using the [#6] procedure as shown in the digital keyset section above.

**Conditions**

- » Only one call can be in a park location at a time. Multiple calls to the same station park location is not possible.
- » The #6 code is flexible and can be assigned in Flash 52 programming.
- » The call will be placed in the Station's Personal Park location.

---

## Call Pickup

**Description**

Stations are assigned to pickup groups. Stations can be in any combination of the 20 groups or in no group at all.

A station can pickup a call ringing to any specific unattended station by using the Directed Call Pickup procedure.

A station can pickup a call ringing to an unattended station within the same UCD group by using the Group Call Pickup Procedure.

Use Flash 50 programming when you want to modify a range of stations' attributes using **fixed** station numbers.

Use Flash 51 programming to modify a single station's attributes using a **flexible** station number.

**Programming Steps**

1. Press **FLASH** and dial **[50]** or dial **[51]**. Flexible button #24 (New Range) is lit and one of the following messages displays:

**Flash 50 - Fixed Numbers**

STATION ATTRIBUTES  
 SELECT A STATION RANGE

**Flash 51 - Flexible Numbers**

ENTER STATION NUMBER

- Enter the range of **fixed** station numbers (100-149) to be programmed. If only one station is being programmed, enter that number twice, e.g., [100 100].

|             |  |
|-------------|--|
| <b>Note</b> | If <b>HOLD</b> is pressed without entering a station range, all stations are selected. |
|-------------|--|

-or-

Enter a valid **flexible** number (100-8999) to be programmed.

- Press **HOLD** to save the entry. A confirmation tone sounds and the display updates. Flexible button #19 is lit. The display updates to reflect current programming for Page A:

#### Flash 50 - Fixed Numbers

|   |
|---|
| XXX - XXX PAGE A<br>ENTER BUTTON NUMBER |
|---|

XXX-XXX = fixed station range

#### Flash 51 - Flexible Numbers

|                                    |
|------------------------------------|
| SXXX PAGE A<br>ENTER BUTTON NUMBER |
|------------------------------------|

XXX = 3- or 4-digit flexible number

- Press button #20. The display updates to reflect current programming for Page B.

#### Flash 50 - Fixed Numbers

|   |
|---|
| XXX - XXX PAGE B<br>ENTER BUTTON NUMBER |
|---|

XXX-XXX = fixed station range

#### Flash 51 - Flexible Numbers

|                                    |
|------------------------------------|
| SXXX PAGE B<br>ENTER BUTTON NUMBER |
|------------------------------------|

XXX = 3- or 4-digit flexible number

- Press the **GROUP PICKUP** flexible button (**Button #5**). The following message displays:

|               |       |
|---------------|-------|
| PICKUP GROUPS | 01-20 |
| 1             |       |

- Enter a valid number (1-8) to program Pickup Groups.

[01] = Group 1      [06] = Group 6      [11] = Group 11      [16] = Group 16

[02] = Group 2      [07] = Group 7      [12] = Group 12      [17] = Group 17

[03] = Group 3      [08] = Group 8      [13] = Group 13      [18] = Group 18

[04] = Group 4      [09] = Group 9      [14] = Group 14      [19] = Group 19

[05] = Group 5      [10] = Group 10      [15] = Group 15      [20] = Group 20

- Press **HOLD** to save the entry. A confirmation tone sounds and the display updates.

DEFAULT ... All stations are in Group 1.

### Conditions

- » Only one station at a time can be programmed when using a flexible station number.
- » When in Flash 51 programming, if you press **HOLD** without specifying a flexible number to be programmed, you will get the station that is in port/station 100.



## *Directed Call Pickup*

### **Description**

A station user can pick up a call to another specific unattended station. The call must be a tone ringing call.

### **Operation**

#### **To create a Pickup Button:**

1. Press [SPEED] + [SPEED].
2. Press the desired flexible button.
3. Dial #0.

#### **To use Directed Call Pickup:**

1. Dial the station number of the known ringing telephone. Receive busy tone.
2. Press the preprogrammed PICKUP button to answer the call.



SINGLE LINE TELEPHONE

#### **To use Directed Call Pickup:**

1. Lift the handset.
2. Dial [#1].
3. Dial station number of ringing telephone.

### **Conditions**

- » User must have access to the specific outside line or a LOOP button for a Directed Call Pickup.

## *Group Call Pickup*

### **Description**

A station user can pickup a call to any unattended station within the same pickup group.

### **Operation**

#### **To create a Pickup Button:**

1. Press [SPEED] + [SPEED].
2. Press the desired flexible button.
3. Dial #0.

#### **To use Group Call Pickup:**

1. Lift handset or press ON/OFF button.
2. Dial [#0] on the dial pad,  
-or-  
Press preprogrammed PICKUP button to connect to calling party.



## SINGLE LINE TELEPHONE

**To use Group Call Pickup:**

Lift the handset and dial [#0]. You will be connected to the intercom or outside line call.

**Conditions**

- » User must have access to the specific outside line or LOOP button for a Group Call Pickup.

---

## Call Transfer

**Description**

An outside CO line call can be transferred from one keyset to another within the system. The transfer can be screened (announced) or unscreened to an idle or busy station, ACD or UCD Group, or Hunt Group. The line being transferred rings on the keyset and provides Exclusive Hold flashing indication to the receiving party's keyset. Any number of attempts can be made to locate someone by calling different keysets without losing the call.

The Direct Transfer Mode allows transferring of an outside CO line directly to the key station handset, if enabled in programming (refer to *"Direct Transfer Mode" on page 2-133*).

A system-wide database parameter can select music on hold or ringback tone to the CO caller when CO calls are transferred in the system.

Outside line calls can also be transferred to another outside destination by using a trunk-to-trunk transfer.

**Operation****To activate a PBX/Centrex Transfer, while connected to an outside line (PBX/Centrex):**

1. Press FLASH. The transfer dial tone sounds.
2. Dial the PBX/Centrex station number.
3. Hang up to complete the transfer.

**To activate a Screened Transfer, while connected to an outside line (PBX/Centrex):**

1. Press DSS button where to transfer call (if programmed on your telephone) or press TRANS button and dial the station number.

The called extension signals according to the intercom position.

2. When that extension answers, announce the transfer.
3. Hang up to complete transfer.



If Direct Transfer Mode is enabled in admin programming, the supervised transfer is transferred directly to the key station handset.

**To answer a Screened Transfer (your intercom signals based on selected H-T-P mode):**

1. Answer the intercom and receive the transfer notice.
2. Press the outside line button or loop button flashing on hold.

**To Transfer Search:**

When attempting to locate a party, press a DSS button to signal the desired station or press the TRANS button and dial the desired station number.

If the party is not located:

1. Press another DSS button or press TRANS and dial another station number to continue the search.
2. When called party answers, hang up to complete the transfer.

**To make an Unscreened Transfer:**

When called extension begins to signal, hang up to transfer the call (Recall Timer starts).

**To make a Trunk-To-Trunk Transfer**

1. Press TRANS. The transfer dial tone sounds.
2. Press a CO line / Loop flexible button.  
-or-  
Dial [9].  
-or-  
Dial a CO line/group access code.
3. Dial the desired outside line destination number.
4. Hang up to complete the transfer.



*E911 feature enabled precludes dial 9 access.  
LCR feature enabled precludes Loop button access.*



SINGLE LINE TELEPHONE

**To make a PBX/Centrex Transfer:**

1. Press the FLASH button. Intercom dial tone sounds.
2. Dial [660]. A Flash command is presented to the PBX or Centrex CO Line (stutter tone sounds).
3. Dial desired telephone number.
4. Replace handset to complete transfer.

**To activate a Screened Transfer (while connected to an outside line):**

1. Press the FLASH button.
2. Dial desired intercom number.
3. Announce the call.
4. Hang up to complete transfer.

**To make an Unscreened Transfer:**

1. Press the FLASH button.
2. Dial desired intercom number.
3. Hang up to complete transfer.

**To make a Trunk-To-Trunk Transfer**

1. Press the FLASH button. A dial tone will sound.
2. Dial [9].
  - or-
  - Dial a CO line/group access code.
3. Dial the desired outside line destination number.
4. Hang up to complete the transfer.



*E911 feature enabled precludes dial 9 access.*

**Ringback on Transfer****Description**

The Ringback on Transfer feature provides on a system-wide basis Music On Hold or ringback tone to the CO caller when CO calls are transferred. Callers hear music if a music source is connected to the system.

**Programming Steps**

1. Press the RINGBACK ON TRANSFER flexible button (**FLASH 06, Button #11**). The following message displays:

|                  |     |
|------------------|-----|
| RINGBACK ON XFER | 0-1 |
| DISABLED         |     |

2. Enter a 0 or 1 on the dial pad to enable/disable the use of this feature.
  - [0] = Disabled (Music, if music source is connected to system, otherwise silence)
  - [1] = Enabled (Ringback Tone)
3. Press HOLD to save the entry. A confirmation tone sounds.

DEFAULT ... Ringback on Transfer is disabled.

## *Unanswered CO Call Transfer*

### **Description**

The Unanswered CO Call Transfer feature provides station users the ability to transfer an incoming CO call that is currently ringing at their station without answering it. Only Incoming and Transferred calls can be forced. Calls may be forwarded to any available station, UCD group, or VM Group.

A destination station must have a direct appearance for that CO Line or Loop button and not in DND, or an error tone is presented to the originator and the call continues to ring their station. If the station is busy, the current call must be placed on hold, the ringing transfer initiated, and then the station can return to their original call. This feature is unavailable to Single Line Telephone users.

### **Operation**

#### ***When an incoming call rings an idle station:***

1. Press the preprogrammed UNANSWERED CO CALL TRANSFER flexible button,  
-or-  
Dial the Unanswered CO Call Transfer code [639] on the dial pad.
2. Press a DSS, Group button, or dial the station number or group number. Call is automatically transferred to that destination.

#### ***When an incoming or transferred call rings a busy station:***

1. Place the current call on hold and replace the handset or press ON/OFF.
2. Press the preprogrammed UNANSWERED CO CALL TRANSFER flexible button,  
-or-  
Dial the Incoming CO call transfer code [639] on the dial pad.
3. Press a DSS, Group button, or dial the station number or group number. Call is automatically transferred to that destination. The incoming transferred CO call receives Music On Hold during the transfer state.
4. Station user can return to call placed on hold.



SINGLE LINE TELEPHONE

Not applicable

### **Conditions**

- » Attendant stations do not send ID digits.
- » This feature only operates when the station is in an idle mode.

---

## Camp On

### Description

A station may alert a busy party that an outside line is waiting for them by using the CAMP ON button. To camp on a call, press the TRANS button to transfer the call to the desired busy station, then press the CAMP ON button. The busy party receives a muted ring over the keyset speaker, and a visual flashing CAMP ON LED. By pressing the CAMP ON button, the person called places their existing outside call on hold or drops an existing internal call, and is connected to the person placing the Camp On. They can then pick up the call on the appropriate line.

### Operation

#### **To alert a busy station of your call:**

1. Press the CAMP ON button or use the Soft Key's CAMP-ON option. The called station will receive one-burst of tone.
2. When the called party answers, consult with them or hang up to transfer call.

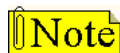

*If a station is in DND, only the Attendant can Camp On using the Attendant override feature.*

*Camp On or Override drops any internal callers to which that station is talking.*

#### **To answer a call that is waiting:**

When you hear one burst of muted ringing, press your flashing CAMP ON button.

Any outside line you are connected to is placed on hold. Converse with the station placing the call,

-or-

If a call is being transferred, press the flashing OUTSIDE LINE button.



SINGLE LINE TELEPHONE

#### **To alert a busy station of your call:**

1. Press the FLASH button.
2. Dial [620]. When the called line is alerted, they can choose to pick up your call or remain on original call.

#### **To answer a call that is waiting (while on a CO line call):**

1. Receive Camp on warning tone through the handset.
2. Choose desired call (hang up on present call and take new call, or ignore Camp On signal).

### Conditions

- » Calls cannot be camped on when a station is in DND or in Conference.
- » If the party that initiated the Camp On hangs up, then Camp On is canceled and the call is blind-transferred.

## Camp On Button Flash Rate

### Description

The Camp On button flash rate is the rate at which the Camp On button flashes when you receive a Camp On. This flash rate can be programmed to 29 different options identified in the flash rate table. This enables the programmer to customize the key system configuration to desired flash rates.

### Programming Steps

1. Press the CAMP ON BTN flexible button (**FLASH 07, Button #15**). The following message displays:

|                   |       |
|-------------------|-------|
| CAMP ON BTN       | 00-28 |
| RED 120 IPM FLASH |       |

2. Enter a valid number (00-28) on the dial pad to correspond to one of the 29 available options (refer to [Table 2-16 on page 2-163](#)).
3. Press HOLD to save the entry. A confirmation tone sounds and the display updates.

DEFAULT ... Camp On Button flash rate is set for a Red 120 ipm Flash (10).

## Camp On Recall

### Description

When a station does not answer a Camp On, that call recalls the person placing the Camp On, and if unanswered by them, recalls the Attendant(s).

---

## Card Slot Programming

### Description

The Card Slot Programming feature provides a means to assign the peripheral cards to alternative peripheral card slots.

Flash 24 also allows for partial signaling over T1IBs. For example, card slots ordinarily accommodate 24 CO line time slots each. This feature allows you to limit the amount of time slots per card to four (4), or multiples of four (4) up to 20. To use this feature, the card ID is programmed followed by the number of CO lines to be used in groups of four (4). A group of four (4) is known as a cluster. If the card number is programmed without a cluster number, all COs on that card are active.

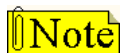

*When using partial signaling, the last channel in the cluster and the 24th channel are data channels (e.g., for partial signaling with one cluster, the 4th and 24th channels are data channels. If two clusters are used, then the 8th and 24th channels are data channels.)*

**Related Information**

| Quick Reference |            |   |
|-----------------|------------|---|
| ➔ Flash 80      | Button #20 | System Reset (refer to <i>"System Reset" on page 2-298</i> ). |

**Programming Steps**

1. Press **FLASH** and dial **[24]**. The following message displays on the display:

|                                  |
|----------------------------------|
| CABINET 0<br>ENTER BUTTON NUMBER |
|----------------------------------|

2. Press the button corresponding to the desired SLOT location. (Buttons #1-14 indicate peripheral card slots 0-13.)

|       |         |       |
|-------|---------|-------|
| CAB 0 | SLOT XX | 00-21 |
| DTIB  |         |       |

3. Enter a valid number for the type of card plugged into the current peripheral card slot.
 

|  |   |
|--|---|
| [00] = None                              | [13] = SL04 (represents SLIB w/ 4 ports)    |
| [02] = DTIB                              | [15] = LCI4 (represents LCOBC)              |
| [04] = SL02 (represents SLIB w/ 2 ports) | [16] = SI04 (represents SLIBC w/ 4 ports)   |
| [08] = PRIB                              | [17] = VM1B (represents VM Interface Board) |
| [09] = T1IB                              |   |
4. If the T1IB option is selected in step 3, then enter a valid number (1-5) to specify the desired cluster (partial) quantity; otherwise, skip to step 5.
 

|                     |                         |
|---------------------|-------------------------|
| [1] = cluster of 4  | [4] = cluster of 16     |
| [2] = cluster of 8  | [5] = cluster of 20     |
| [3] = cluster of 12 | No Entry = All CO lines |
5. Press HOLD to save the entry. A confirmation tone sounds and the display updates.
6. Press the reset button on the Main Board Unit (MBU).

DEFAULT ... Slot 0, 1, and 2 are identified as DTIB, LCI4, and SL02 respectively.

**Conditions**

- » After programming card slots, a system reset must be performed.
- » If a caller ID card is used in the system, you must use FLASH 40, Page C, Button #2 to set the Ring Delay Timer to a setting of 05 (sec). This allows sufficient time for receipt of ICLID information from the telephone company. Refer to *"Ring Delay Timer" on page A-9*.



## Centrex/PBX

The following features provide Centrex compatibility so that the STSe system's toll restriction feature can correctly interpret Centrex digits.

### CO / PBX Programming

#### Description

Each individual outside line connected to the system may be programmed as a CO or PBX line. Use the PBX mark when identifying Centrex lines.

#### Programming Steps

1. Press **FLASH** and dial **[40]**. The following message displays:

CO LINE ATTRIBUTES  
 SELECT A CO LINE RANGE

2. Enter a valid number for the range of lines being programmed. If only one line is being programmed, enter that number twice (001 001).



*If HOLD is pressed without entering a CO line range, all CO lines are selected.*

3. Press HOLD to save the entry. A confirmation tone sounds and the display updates. Flexible button #19 (Page A) is lit. The following message displays to indicate current programming of that line or group of lines:

XXX - XXX PAGE A  
 ENTER BUTTON NUMBER

*XXX-XXX = CO Line Range*

4. Press the CO/PBX flexible button (**Button #2**).
5. Enter a 0 or 1 which corresponds with the following entries:  
 [0] = PBX  
 [1] = CO

|          |     |
|----------|-----|
| PBX / CO | 0-1 |
| CO       |     |

6. Press HOLD to save the entry. A confirmation tone sounds.

DEFAULT ... All lines are assigned as CO lines.

## *Off-Hook Preference*

### **Description**

Telephones, key and SLT, may be programmed to have their personal Centrex line accessed automatically just by lifting the handset or pressing the ON/OFF button (Speaker Button on SLTs). Internal features to the STSe are still made available to digital telephones by accessing intercom before going off-hook. Refer to [“Ring Down / Hot Line / Off-Hook Preference” on page 2-263](#). An SLT can obtain ICM dial tone by pressing the FLASH button and dialing their extension number.

## *Private Line Appearance*

### **Description**

The STSe allows for private line assignment on an unlimited basis. Each station may have sole access to a particular outside line if desired and may also be assigned to receive incoming ringing on that line. Refer to [“CO Line Group Programming” on page 2-74](#), [“Line Group Access - Station” on page 2-73](#), and [“Flexible Button Function Assignment” on page 2-163](#).

## *Programming \*, #, and Hook-Flashes into Speed Dial*

### **Description**

Many Centrex codes utilize a hook-flash followed by, in many cases, the digit [\*] and or [#]. The STSe allows programming of these codes as a part of system or station speed dial sequences. Refer to [“Speed Dial” on page 2-275](#).

## *Centrex/PBX Flash*

### **Description**

Provides telephone users with the ability to terminate an outside call or transfer a call behind a PBX or Centrex and restore dial tone without hanging up the handset. A FLASH button is located on each digital telephone.

### **Operation**

When connected to an outside line:

Press FLASH to disconnect outside line and reseed outside line dial tone.



SINGLE LINE TELEPHONE

Press the FLASH button, then dial [660].

## Centrex/PBX Flash Timer

### Description

Flash is a programmable opening on a line for signaling. When using an outside line, flash lets a user obtain a new dial tone without losing the line. This is particularly useful behind a PBX or Centrex. Each CO line can be programmed for a flash time.

### Programming Steps

1. Press **FLASH** and dial **[40]**. The following message displays:

CO LINE ATTRIBUTES  
 SELECT A CO LINE RANGE

2. Enter a valid number for the range of lines being programmed. If only one line is being programmed, enter that number twice (001 001).



If **HOLD** is pressed without entering a CO line range, ALL CO lines are selected.

3. Press Button #21 to select Page C. The display updates. The following message displays to indicate current programming of that line or group of lines:

XXX - XXX PAGE C  
 ENTER BUTTON NUMBER

*XXX-XXX = CO Line Range*

4. Press the FLASH TIMER flexible button (**Button #1**).
5. Enter a valid number on the dial pad (01–20) which corresponds to 100 ms to 2 seconds.

|             |       |
|-------------|-------|
| FLASH TIMER | 01-20 |
| 10          |       |

6. Press **HOLD** to save the entry. A confirmation tone sounds and the display updates.

DEFAULT ... Flash Timer is set for 10 (1.0 seconds) and is variable from 01-20 (100 ms to 2 seconds).

## Centrex/PBX Transfer

### Description

When Centrex or PBX lines are connected to the *STSe*, users may, by using the Flash button, transfer callers to other Centrex or PBX extensions. The Flash command may also be included within a Speed Bin and programmed onto a flexible button for one button transfer. Consult your Centrex user guide for further instructions after flashing the line. Refer to [“Centrex/PBX Flash Timer” on page 2-59](#).

## Operation

### **While connected to an outside line (PBX/Centrex):**

1. Press the FLASH button. Receive transfer dial tone.
2. Dial a PBX/Centrex station number.
3. Hang up to complete the transfer.



SINGLE LINE TELEPHONE

### **While connected to an outside line (PBX/Centrex):**

1. Press the FLASH button. Receive transfer dial tone.
2. Dial [660].
3. Dial a PBX/Centrex station number.
4. Hang up to complete the transfer.

## PBX Dialing Codes

### Description

Five 1- or 2-digit PBX access codes can be programmed into memory. When dialed, these codes signal the system so toll restriction is applied at the next dialed digit. When a single digit code [9] is entered, it must be followed by [#] as the second digit. Refer to [“911 Feature” on page 2-5](#).



If 911 is enabled for a PBX trunk using Centrex, entry one in Flash 12 (of [9] + [#]) will insert the Centrex 9 (not LCR).

### Quick Reference

|            |        |           |   |
|------------|--------|-----------|---|
| ➔ Flash 40 | Page A | Button #2 | PBX/CO (refer to <a href="#">“CO / PBX Programming” on page 2-57</a> ). |
|------------|--------|-----------|---|

### Programming Steps

1. Press **FLASH** and dial **[12]**. The following message displays:

PBX DIAL CODES  
##, ##, ##, ##, ##

2. Enter valid numbers (one right after the other) on the dial pad, up to ten digits. If a single digit code is required, enter the code followed by [#].
3. Press HOLD to save the entry. A confirmation tone sounds and the display updates.
4. To delete a code, enter [#] [#] and press HOLD.

DEFAULT ... No PBX dialing codes are assigned.

### Conditions

- » Lines must be programmed as PBX lines before these codes apply.

## Class Of Service

### Description

Each station and each CO line is assigned a Class of Service (COS) which governs stations' dialing privileges. Day COS and Night COS assignments to stations provide the system administrator additional control over station dialing, preventing misuse of phones after hours.

Seven uniquely defined COSs are available for assignment to stations and five uniquely defined COSs are available for assignment to CO lines. Station COS works in conjunction with CO line COS to provide the most flexible means for offering custom toll restriction.

The following table depicts how the station and CO line COSs interact. After setting the station COS, any change to the CO line COS will result in a change in dialing privilege. For example, a station COS of 2 with a CO line COS of 5 gives the user an unrestricted calling privilege.

**Table 2-2: Class of Service (COS)**

|  |   | CO Line Class of Service |                    |                    |                    |               |
|--|---|--------------------------|--------------------|--------------------|--------------------|---------------|
|  |   | 1                        | 2                  | 3                  | 4                  | 5             |
| S<br>T<br>A<br>T<br>I<br>O<br>N<br><br>C<br>O<br>S | 1 | Unrestricted             | Unrestricted       | Unrestricted       | Canned Restricted* | Unrestricted  |
|  | 2 | Table A                  | Table A            | Unrestricted       | Canned Restricted* | Unrestricted  |
|  | 3 | Table B                  | Unrestricted       | Table B            | Canned Restricted* | Unrestricted  |
|  | 4 | Table A and B            | Table A            | Table B            | Canned Restricted* | Unrestricted  |
|  | 5 | Canned Restricted*       | Canned Restricted* | Canned Restricted* | Canned Restricted* | Unrestricted  |
|  | 6 | Intercom Only            | Intercom Only      | Intercom Only      | Intercom Only      | Intercom Only |
|  | 7 | Canned Restricted*       | Canned Restricted* | Canned Restricted* | Canned Restricted* | Unrestricted  |

\* Canned Restriction: No [0], [1], [#], [\*] as first dialed digit, and 7-digit dialing limitation; plus 1-800, 1-888, 1-866, 1-877, 1-911, 1-611 are allowed, and 411, 976, and 555 numbers are denied. COS 7 allows 10-digit dialing maximum.

### Related Information

| Quick Reference |   |
|-----------------|---|
| ➔ Flash 70      | Toll Restriction (refer to "Toll Restriction" on page 2-318). |

## Class of Service - CO Line

### Description

Through assignments of a CO Line Class of Service, the assigned CO line interacts with a station Class of Service.

### Programming Steps

1. Press **FLASH** and dial **[40]**. The following message displays:

|  |
|--|
| CO LINE ATTRIBUTES<br>SELECT A CO LINE RANGE |
|--|

2. Enter a valid number for the range of lines being programmed. If only one line is being programmed, enter that number twice (001 001).



If **HOLD** is pressed without entering a CO line range, all CO lines are selected.

3. Press **HOLD** to save the entry. A confirmation tone sounds and the display updates. Flexible button #19 (Page A) is lit. The following message displays to indicate current programming of that line or group of lines:

|   |
|---|
| XXX - XXX PAGE A<br>ENTER BUTTON NUMBER |
|---|

XXX-XXX = CO Line Range

4. Press the LINE COS flexible button (**FLASH 40, Page A, Button #9**).
5. Enter a valid number on the dial pad (1-5) corresponding to one of five possible Classes of Service to which a CO line may be assigned:
  - [1] = COS1; No restrictions
  - [2] = COS2; Table A governs, Station COS 2 and 4 are monitored
  - [3] = COS3; Table B governs, Station COS 3 and 4 are monitored
  - [4] = COS4; Restricts [0], [1], [\*], [#] dialed as first-digit and places a 7-digit dialing limitation. Allowed are: 1-800, 1-888, 1-866, 1-877, 1-911, and 1-611. Denied are: 411, 976, and 555.
  - [5] = COS5; Overrides Station COS 1, 2, 3, 4, 5, and 7, and allows unrestricted dialing.

|                  |     |
|------------------|-----|
| CLASS OF SERVICE | 1-5 |
| 1                |     |

6. Press **HOLD** to save the entry. A confirmation tone sounds and the display updates.  
DEFAULT ... Class of Service setting is 1.

## Station Day Class of Service

### Description

Each station must be assigned a certain COS for Day Mode operation and for Night Mode operation. Class of Service (COS) determines the station's dialing privileges.

Use Flash 50 programming when you want to modify a range of stations' attributes using **fixed** station numbers.

Use Flash 51 programming to modify a single station's attributes using a **flexible** station number.

### Programming Steps

1. Press **FLASH** and dial **[50]** or dial **[51]**. Flexible button #24 (New Range) is lit and one of the following messages displays:

#### Flash 50 - Fixed Numbers

STATION ATTRIBUTES  
SELECT A STATION RANGE

#### Flash 51 - Flexible Numbers

ENTER STATION NUMBER

2. Enter the range of **fixed** station numbers (100-149) to be programmed. If only one station is being programmed, enter that number twice, e.g., [100 100].

 **Note** If HOLD is pressed without entering a station range, all stations are selected.

-or-

Enter a valid **flexible** number (100-8999) to be programmed.

3. Press HOLD to save the entry. A confirmation tone sounds and the display updates. Flexible button #19 is lit. The display updates to reflect current programming for Page A:

#### Flash 50 - Fixed Numbers

XXX - XXX PAGE A  
ENTER BUTTON NUMBER

XXX-XXX = fixed station range

#### Flash 51 - Flexible Numbers

SXXX PAGE A  
ENTER BUTTON NUMBER

XXX = 3- or 4-digit flexible number

4. Press button #20. The display updates to reflect current programming for Page B.

#### Flash 50 - Fixed Numbers

XXX - XXX PAGE B  
ENTER BUTTON NUMBER

XXX-XXX = fixed station range

#### Flash 51 - Flexible Numbers

SXXX PAGE B  
ENTER BUTTON NUMBER

XXX = 3- or 4-digit flexible number

*Features and Operation*

- Press the DAY COS flexible button (**Button #2**).

|         |     |
|---------|-----|
| DAY COS | 1-7 |
| 1       |     |

- Enter a valid number on the dial pad (1-7) corresponding to one of seven possible Classes of Service to which a station may be assigned.

The seven classes of service are:

[1] = COS 1; No restrictions

[2] = COS 2; Table A governs

[3] = COS 3; Table B governs

[4] = COS 4; Table A and B govern

[5] = COS 5; Restricts [0], [1], [\*], [#] dialed as first-digit with a 7-digit maximum

[6] = COS 6; Intercom Only (no CO line access - results in a 911 block unless 911 Feature is active)

[7] = COS 7; Restricts [0], [1], [\*], [#] dialed as first-digit with a 10-digit maximum

- Press HOLD to save the entry. A confirmation tone sounds and the display updates.

DEFAULT ... All stations are assigned a COS 1 for Day Mode.

### Conditions

- » Only one station at a time can be programmed when using a flexible station number.
- » When in Flash 51 programming, if you press HOLD without specifying a flexible number to be programmed, you will get the station that is in port/station 100.

## Station Night Class of Service

### Description

Each station must be assigned a COS for Night Mode operation. The Night COS goes into affect when the system is manually or automatically placed into Night Mode. This prevents misuse of phones after hours. Class of Service determines the station's dialing privileges.

Use Flash 50 programming when you want to modify a range of stations' attributes using **fixed** station numbers.

Use Flash 51 programming to modify a single station's attributes using a **flexible** station number.

### Programming Steps

- Press **FLASH** and dial **[50]** or dial **[51]**. Flexible button #24 (New Range) is lit and one of the following messages displays:

#### Flash 50 - Fixed Numbers

|  |
|--|
| STATION ATTRIBUTES<br>SELECT A STATION RANGE |
|--|

#### Flash 51 - Flexible Numbers

|                      |
|----------------------|
| ENTER STATION NUMBER |
|----------------------|



- Enter the range of **fixed** station numbers (100-149) to be programmed. If only one station is being programmed, enter that number twice, e.g., [100 100].

**Note** If HOLD is pressed without entering a station range, all stations are selected.

-or-

Enter a valid **flexible** number (100-8999) to be programmed.

- Press HOLD to save the entry. A confirmation tone sounds and the display updates. Flexible button #19 is lit. The display updates to reflect current programming for Page A:

**Flash 50 - Fixed Numbers**

XXX - XXX PAGE A  
ENTER BUTTON NUMBER

XXX-XXX = fixed station range

**Flash 51 - Flexible Numbers**

SXXX PAGE A  
ENTER BUTTON NUMBER

XXX = 3- or 4-digit flexible number

- Press button #20. The display updates to reflect current programming for Page B.

**Flash 50 - Fixed Numbers**

XXX - XXX PAGE B  
ENTER BUTTON NUMBER

XXX-XXX = fixed station range

**Flash 51 - Flexible Numbers**

SXXX PAGE B  
ENTER BUTTON NUMBER

XXX = 3- or 4-digit flexible number

- Press the NIGHT COS flexible button (**Button #3**).

NIGHT COS 1-7  
1

- Enter a valid number on the dial pad (1-7) corresponding to one of seven possible Classes of Service to which a station may be assigned.

The seven Classes of Service are:

[1] = COS 1; No restrictions.

[2] = COS 2; Table A governs

[3] = COS 3; Table B governs

[4] = COS 4; Table A and B govern

[5] = COS 5; Restricts [0], [1], [\*], [#] dialed as first-digit and places a 7-digit maximum.

[6] = COS 6; Intercom Only (no CO line access - results in a 911 block (unless 911 Feature is active)

[7] = COS 7; Restricts [0], [1], [\*], [#] dialed as first-digit with a 10-digit maximum.

- Press HOLD to save the entry. A confirmation tone sounds and the display updates.

DEFAULT ... All stations are assigned a COS 1 for Night Mode.

### Conditions

- » Only one station at a time can be programmed when using a flexible station number.
- » When in Flash 51 programming, if you press HOLD without specifying a flexible number to be programmed, you will get the station that is in port/station 100.

---

## CO Flexible Port Assignment

### Description

The Flexible Port Assignment feature provides a means to assign CO line numbers to any CO line port in the system. This provides complete flexibility in determining CO line numbers within the system as long as they stay within the system numbering plan. A CO line can be assigned any number between 001 and the maximum number of CO lines in your system.

The buttons on the digital telephone are defined as shown when entering the Flexible Port Assignment Feature programming area:

All CO line numbers entered are stored in a temporary database area which is uploaded to the main database when the system is reset.

**Table 2-3: Flexible Port Assignments**

| Button # | CO Line # | Port # |
|----------|-----------|--------|
| 1        | 001-004   | 1-4    |
| 2        | 005-008   | 5-8    |
| 3        | 009-012   | 9-12   |
| 4        | 013-016   | 13-16  |
| 5        | 017-020   | 17-20  |
| 6        | 021-024   | 21-24  |
| 7        | 025-028   | 25-28  |

### Programming Steps

If the CO Line numbers need to be relocated to different ports, press **FLASH** and dial **[42]**. The following message displays:

CO 001 002 003 004

Buttons 1 through 7 indicate Ports 1 through 28 in increments of 4 ports per button. When the relocation program is initially entered, Button #1 is lit to indicate that the user is programming the CO Line numbers.

#### **To change the CO Line number assigned to any port:**

1. Dial the position number on the display (01 through 04).
2. Then dial the CO Line number desired and press HOLD.

**EXAMPLE 1** -- If [01003] is dialed and the HOLD button is pressed, the CO line number of the first entry on the display changes to [003]. Since [003] was shown as the third entry on the display, that entry is blank (###).

```
CO 003 002 ### 004 005
```

**EXAMPLE 2** -- If Button #3 (CO Ports 9-12) is pressed, the following display appears:

```
CO 009 010 011 012
```

**EXAMPLE 3** -- If [03012] is dialed, the CO line number of the third entry on the display changes to [012]. Since [012] was shown as the fourth entry, that entry is blank (###).

```
CO 009 010 012 ###
```



**Note**

When all the CO Line numbers desired have been programmed, a system reset is required to update the data. This is done so that the programming of CO Lines can be done while the system is in use.

## CO Line - Access

### Description

Through programming, telephones are allowed or denied access to particular outside lines or line groups. Refer to ["Line Group Access - Station" on page 2-73](#), ["Flexible Button Function Assignment" on page 2-163](#), and ["CO Line Group Programming" on page 2-74](#).

### Operation

#### **To access an outside line:**

1. Press idle CO line button, POOL button,  
-or-  
Dial CO line group access code or LCR code: 9, 801-823 or 88+LLL (LLL = CO Line number).
2. Dial desired number for outside call and lift handset to converse (or use speakerphone).



SINGLE LINE TELEPHONE

#### **To access an outside line:**

1. Lift the handset, and dial access code: 9, 801-823, or 88+LLL (LLL = CO line number).
2. Then dial telephone number.

### Conditions

- » Access to trunk group must be programmed by installer/administrator.
- » The CO line must be idle.

## CO Line Attributes

### Initialize CO Line Attributes

#### Description

CO Line parameters may be initialized to set all data fields to their original, default values. The following data fields are returned to their default value upon initializing the CO Line Attributes.

**Table 2-4: CO Line Attribute Defaults**

| Program Code       | Flexible Button           | Features                                | Default Value (after initialization) |
|--------------------|---------------------------|---|--------------------------------------|
| FLASH 40<br>PAGE A | 1                         | DTMF/Dial Pulse Programming             | DTMF                                 |
|                    | 2                         | CO/PBX Programming                      | CO                                   |
|                    | 3                         | Universal Night Answer (UNA)            | Enabled                              |
|                    | 4                         | DISA CO-to-CO (Per CO Line)             | Enabled                              |
|                    | 5                         | Privacy                                 | Enabled                              |
|                    | 6                         | Loop Supervision Programming            | 4=400 ms                             |
|                    | 7                         | DISA Programming                        | None                                 |
|                    | 8                         | CO Line Group Programming               | Group 01                             |
|                    | 9                         | Class of Service (COS) Programming      | COS 1                                |
|                    | 10                        | CO Line Ringing Assignments             | None                                 |
|                    | 11                        | CO Line Identification Display          | Line XXX                             |
|                    | 12                        | CO Direction                            | Incoming/Outgoing                    |
|                    | 13                        | Display Ring Assignments                | 100A                                 |
|                    | 14                        | DID/TIE Signal                          | Wink                                 |
|                    | 15                        | 911 Trunk                               | Disabled                             |
|                    | 17                        | Tenant Group CO Line Programming        | All Lines Group 0                    |
|                    | FLASH 40<br>PAGE B        | 1                                       | T-1 Signal Type                      |
| 2                  |                           | T-1 Ringback                            | Enabled                              |
| 3                  |                           | T-1 Dial Tone                           | Disabled                             |
| 4                  |                           | Transmit Volume                         | 5=0 db                               |
| 5                  |                           | Preset Call Forward Destination         | None                                 |
| 6                  |                           | Preset Forward Voice Mail ID            | None                                 |
| 7                  |                           | Universal Day Answer (UDA)              | Disabled                             |
| 8                  |                           | Music-On-Hold (per CO Line)             | Channel 1                            |
| 9                  |                           | Ring Tone (per CO Line)                 | Tone # 00                            |
| 16                 |                           | Preset Call Forward Night Destination   | None                                 |
| 17                 |                           | Preset Call Forward Special Destination | None                                 |
| 18                 | Fax Detect Enable/Disable | Disabled                                |                                      |

Table 2-4: CO Line Attribute Defaults

| Program Code | Flexible Button | Features                | Default Value (after initialization) |
|--------------|-----------------|-------------------------|--------------------------------------|
| FLASH 40     | 1               | Flash Timer Programming | 10=1.0 sec                           |
| PAGE C       | 2               | Ring Delay Timer        | 00=Disabled                          |
|              | 3               | Wink Timer              | 140 ms                               |
|              | 4               | Release Timer           | 020=200 ms                           |
|              | 5               | Reseize Timer           | 200=200 ms                           |
|              | 6               | Guard Timer             | 05=0.5 sec                           |
|              | 7               | Seize Timer             | 010=0.1 sec                          |
|              | 8               | Preset Forward Timer    | 10 sec                               |
|              | 9               | DID Collect Timer       | 015=150 ms                           |
|              | 10              | T-1 Collect Timer       | 015=150 ms                           |

### Programming Steps

1. Press the CO LINE ATTRIBUTES flexible button (**FLASH 80, Button #2**). The following message displays:

|   |
|---|
| <p>INITIALIZE CO LINES<br/>PRESS HOLD</p> |
|---|

2. Press the HOLD button. A confirmation tone sounds.

## Print CO Line Attributes

### Description

The Print CO Line Attributes command dumps the entire database as a permanent record which can serve as a hardcopy of the database. The system baud rate must match that of the printer or receiving device.

When printing the CO Line attributes the following data prints:

- All CO Line parameters within the specified range
- CO Line ringing assignments within the specified range
- Dial Pulse Ratio and Speed settings

```

CO LINE ATTRIBUTES
-----
CO 001                                CO 002
-----                                -----
DIAL PULSE/DTMF - DTMF                DIAL PULSE/DTMF - DTMF
PBX/CO - CO                            PBX/CO - CO
UNIVERSAL NIGHT ANS - ENABLED          UNIVERSAL NIGHT ANS - ENABLED
DISA TRK TO TRK - ENABLED              DISA TRK TO TRK - ENABLED
PRIVACY - ENABLED                      PRIVACY - ENABLED
LOOP SUPERVISION - 4                   LOOP SUPERVISION - 4
DISA TYPE - NONE                       DISA TYPE - NONE
LINE GROUP - 1                         LINE GROUP - 1
CLASS OF SERVICE - 1                   CLASS OF SERVICE - 1
LINE IDENTIFICATION - LINE 001         LINE IDENTIFICATION - LINE 002
CO DIRECTION - INCOMING-OUTGOING       CO DIRECTION - INCOMING-OUTGOING

RING ASSIGNMENTS                       RING ASSIGNMENTS
S100A                                  S100A

T-1 SIGNAL TYPE - LOOP START           T-1 SIGNAL TYPE - LOOP START
T-1 RINGBACK - ENABLED                 T-1 RINGBACK - ENABLED
T-1 DIALTONE - DISABLED                T-1 DIALTONE - DISABLED
TRANSMIT VOLUME - 0DB                  TRANSMIT VOLUME - 0DB
PRESET FORWARD DEST - #####           PRESET FORWARD DEST - #####
PRESET FWD VMID - NONE                 PRESET FWD VMID - NONE
UNIVERSAL DAY ANSWER - DISABLED        UNIVERSAL DAY ANSWER - DISABLED
MOH CHANNEL - 1                       MOH CHANNEL - 1
RING TONE - 0                          RING TONE - 0

DID/TIE SIGNALING - WINK                DID/TIE SIGNALING - WINK

911 TRUNK - DISABLED                   911 TRUNK - DISABLED
FLASH TIMER - 10                       FLASH TIMER - 10
RING DELAY TIMER - 0                   RING DELAY TIMER - 0
WINK TIMER - 140                       WINK TIMER - 140
RELEASE TIMER - 20                     RELEASE TIMER - 20
RESEIZE TIMER - 200                    RESEIZE TIMER - 200
GUARD TIMER - 5                        GUARD TIMER - 5
SEIZE TIMER - 10                       SEIZE TIMER - 10
PRESET FWD TIMER - 10                  PRESET FWD TIMER - 10

... and so on through all CO lines

```

**Figure 2-2: CO Line Attributes Printout**

## Programming Steps

1. Press the CO LINE ATTRIBUTES flexible button (**FLASH 85, Button #2**).

PRINT CO LINES  
 PRESS HOLD

2. To print data for:
  - ALL CO Lines, press the HOLD button.
  - A specified CO Line Range, enter 6 digits (3 digits for the first line and 3 digits for the last line in the range):
  - One CO Line, enter that line twice: [001001]
3. Then press the HOLD button. The following message displays and the CO Line data prints:

PRINTING CO LINES

When the system finishes sending the requested information to the printer, a confirmation tone sounds.

---

## CO Line DTMF Sending

Each CO interface circuit for outside lines can be individually programmed to send DTMF (tone) or dial pulse signals.

### *DTMF / Dial Pulse Programming*

#### Description

Each individual outside line can be programmed to be DTMF (tone) or dial pulse.

#### Programming Steps

1. Press **FLASH** and dial **[40]**. The following message displays:

CO LINE ATTRIBUTES  
 SELECT A CO LINE RANGE

2. Enter a valid number for the range of lines being programmed. If only one line is being programmed, enter that number twice (001 001).



*If HOLD is pressed without entering a CO line range, all CO lines are selected.*

*Features and Operation*

- Press HOLD to save the entry. A confirmation tone sounds and the display updates. Flexible button #19 (Page A) is lit. The following message displays to indicate current programming of that line or group of lines:

|   |
|---|
| XXX - XXX PAGE A<br>ENTER BUTTON NUMBER |
|---|

*XXX-XXX = CO Line Range*

- Press the DTMF/DIAL PULSE flexible button (**FLASH 40, Page A, Button #1**).
- Enter a 0 or 1 that corresponds with the following entries:  
 [0] = Dial Pulse  
 [1] = DTMF

|                      |     |
|----------------------|-----|
| PULSE / DTMF<br>DTMF | 0-1 |
|----------------------|-----|

- Press HOLD to save the entry. A confirmation tone sounds.

DEFAULT ... All lines are set for DTMF.

*DTMF On/Off Time Operation***Description**

The DTMF On/Off Time feature lets the installer select the DTMF On/Off Time on a system-wide basis. This lets the installer customize the system for certain applications that require more than the standard DTMF Time of 100ms on and 100ms off.

**Programming Steps**

- Press the DTMF TIME OPERATION flexible button (**FLASH 02, Button #6**). The following message displays:

|                       |     |
|-----------------------|-----|
| DTMF ON/OFF TIME<br>1 | 1-9 |
|-----------------------|-----|

- Enter a valid number (1-9) on the dial pad for the DTMF On and Off Times (100-900 ms).
- Press HOLD to save the entry. A confirmation tone sounds.

DEFAULT ... DTMF Time Operation is set for 100 ms On and 100 ms Off.



## CO Line Group

### Description

Outside lines can be placed in one of twenty-four groups if the customer's business requires such grouping. Stations are then individually assigned access to these groups and given the ability to dial on particular lines.

### Line Group Access - Station

#### Description

A station can access any combination of outside line groups, or a station may not be allowed access to outside lines. CO line groups are used primarily by single line telephones or for flexible buttons assigned as pooled group buttons on a Key Telephone.

Use Flash 50 programming when you want to modify a range of stations' attributes using **fixed** station numbers.

Use Flash 51 programming for a single station's attributes using a **flexible** station number.

#### Programming Steps

1. Press **FLASH** and dial **[50]** or dial **[51]**. Flexible button #24 (New Range) is lit and one of the following messages displays:

##### Flash 50 - Fixed Numbers

STATION ATTRIBUTES  
SELECT A STATION RANGE

##### Flash 51 - Flexible Numbers

ENTER STATION NUMBER

2. Enter the range of **fixed** station numbers (100-149) to be programmed. If only one station is being programmed, enter that number twice, e.g., [100 100].

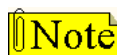

*If HOLD is pressed without entering a station range, all stations are selected.*

-or-

Enter a valid **flexible** number (100-8999) to be programmed.

3. Press HOLD to save the entry. A confirmation tone sounds and the display updates. Flexible button #19 is lit. The display updates to reflect current programming for Page A:

##### Flash 50 - Fixed Numbers

XXX - XXX PAGE A  
ENTER BUTTON NUMBER

*XXX-XXX = fixed station range*

##### Flash 51 - Flexible Numbers

SXXX PAGE A  
ENTER BUTTON NUMBER

*XXX = 3- or 4-digit flexible number*

4. Press button #20. The display updates to reflect current programming for Page B.

**Flash 50 - Fixed Numbers**

|   |
|---|
| XXX - XXX PAGE B<br>ENTER BUTTON NUMBER |
|---|

*XXX-XXX = fixed station range*

**Flash 51 - Flexible Numbers**

|                                    |
|------------------------------------|
| SXXX PAGE B<br>ENTER BUTTON NUMBER |
|------------------------------------|

*XXX = 3- or 4-digit flexible number*

5. Press the CO LINE GROUP ACCESS flexible button (**Button #8**). The following message displays:

|                                   |
|-----------------------------------|
| LINE GROUP ACCESS      01-23<br>1 |
|-----------------------------------|

6. To add a Line Group, enter a valid number (00, or 01–23) to designate the outside line groups that the station can access, press 1, and then press HOLD to save the entry. A confirmation tone sounds and the display updates.

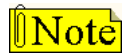

*00+1+HOLD = No Access (911 calls are blocked unless 911 Feature is active).  
 01+1+HOLD = Access to Group 1 by dialing Code 9 or 801 (Code 800 if 911 Feature is active).  
 Users access Line Groups 2-23 by dialing 802-823, respectively.*

7. To delete a Line Group, enter a valid number (00, or 01-23), press 0, and then press HOLD. A confirmation tone sounds and the display updates.

DEFAULT ... Stations are allowed access to Group 1.

**Conditions**

- » Only one station at a time can be programmed when using a flexible station number.
- » When in Flash 51 programming, if you press HOLD without specifying a flexible number to be programmed, you will get the station that is in port/station 100.

**CO Line Group Programming****Description**

Twenty four line groups are available for CO line assignment. Groups should be assigned according to type (local, FX, WATS, etc.). All unassigned CO lines should be programmed into a different group so they are not accessed by Line Queuing, Pooled Group access (Pool Buttons), Speed Dial, or LCR features.

Any Line Group can be used for programming a line(s) as private; for private lines, assign Line Group access to only one station in Flash 50/51, Page B, Button #8. Ordinarily, use Line Group 0 as a private line. Also, all unused CO Lines should be placed in Line Group 0.

CO Lines assigned to a Line Group 0 can only be accessed by stations with a direct CO appearance (button) on their phone.

## Programming Steps

1. Press **FLASH** and dial **[40]**. The following message displays:

```
CO LINE ATTRIBUTES
SELECT A CO LINE RANGE
```

2. Enter a valid number for the range of lines being programmed. If only one line is being programmed, enter that number twice (001 001).



If **HOLD** is pressed without entering a CO line range, all CO lines are selected.

3. Press **HOLD** to save the entry. A confirmation tone sounds and the display updates. Flexible button #19 (Page A) is lit. The following message displays to indicate current programming of that line or group of lines:

```
XXX - XXX PAGE A
ENTER BUTTON NUMBER
```

*XXX-XXX = CO Line Range*

4. Press the CO LINE GROUP flexible button (**Button #8**).
5. Enter a valid number on the dial pad (0-23) which corresponds to Groups 0-23.

```
LINE GROUP          0-23
1
```

6. Press **HOLD** to save the entry. A confirmation tone sounds and the display updates.

DEFAULT ... All lines are placed in Line Group 1.

---

## CO Line Group Queuing

### Description

The CO Line Group Queuing feature allows trunk group queuing to be turned on (enabled) or turned off (disabled) per group. This feature is used only in conjunction with LCR.

### Programming Steps

1. Press **FLASH** and dial **[39]**. The following message displays:

```
CO LINE GROUP QUEUING
ENTER BUTTON NUMBER
```

2. Press button 1-24 to select desired CO Group (0-23) to be programmed. The following displays:

```
GROUP 1              0-1
ENABLED
```

3. Dial a 0 or 1 to enable/disable this feature.  
     [0] = Disabled  
     [1] = Enabled
4. Press HOLD to save the entry. A confirmation tone sounds.

---

## CO Line - Identification

### Description

The CO Line Identification feature allows entering a name into the database for each individual line (trunk) connected to the system. The name may be entered in any combination up to 12-characters in length (this represents 24 digits entered). When the CO line identification field is programmed, display telephones receive the identification field in place of the default field (LINE XXX).

SMDR always prints the line number in place of the programmed name. A programmable data field is available for each line in the system.

### *CO Line Identification Display*

#### Description

The CO Line Identification Display feature allows the entry of a name for each line (trunk) connected to the system. Once entered into the database, LCD phones, including the Attendant stations, receive the programmed line name in place of the default LINE XXX message. This applies to all line call processing conditions where the current LINE XXX message displays. SMDR continues to print out the line number in place of the programmed name. If the line name was not programmed, the current LINE XXX display is the default. A programmable data field is available for each line in the system. Line names may be assigned using the range programming.

A message similar to the following display is used for all CO Line displays when a name is programmed for a CO Line.

|  |
|--|
| LINE RINGING<br>nnnnnnnnnnnn          HH:MM am |
|--|

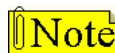

Entries can be made using a keyboard by following the same outlined procedures using [Figure E-1: Data Terminal Program Codes Cross Reference](#).

### Programming Steps

Each CO line can be programmed to have a name associated to it in database programming.

1. Press **FLASH** and dial **[40]**. The following message displays:

|  |
|--|
| CO LINE ATTRIBUTES<br>SELECT A CO LINE RANGE |
|--|

2. Enter a valid number for the range of lines being programmed. If only one line is being programmed, enter that number twice (001 001).

**Note** If HOLD is pressed without entering a CO line range, all CO lines are selected.

3. Press HOLD to save the entry. A confirmation tone sounds and the display updates. Flexible button #19 (Page A) is lit. The following message displays to indicate current programming of that line or group of lines:

XXX - XXX PAGE A  
ENTER BUTTON NUMBER

XXX-XXX = CO Line Range

4. Press the CO LINE IDENTIFICATION flexible button (**Button #11**). The following displays:

LINE IDENTIFICATION  
LINE 001

5. Enter the name by using keys on the dial pad as follows. Valid alphanumeric characters are: [A-Z], [0-9], [\*], [#], [-], [spaces] and other ASCII characters as listed in [Figure 2-3](#). Any combination up to 12 characters may be entered (this represents 24 digits entered).

|                              |                      |                              | Other Codes |            |         |        |
|------------------------------|----------------------|------------------------------|-------------|------------|---------|--------|
| 1                            | A-21<br>B-22<br>C-23 | D-31<br>E-32<br>F-33         | 1 = 1#      | 8 = 8#     | " = 01  | * = *# |
| G-41<br>H-42<br>I-43         | J-51<br>K-52<br>L-53 | M-61<br>N-62<br>O-63         | 2 = 2#      | 9 = 9#     | , = 02  | ( = #1 |
| P-71<br>R-72<br>S-73<br>Q-74 | T-81<br>U-82<br>V-83 | W-91<br>X-92<br>Y-93<br>Z-94 | 3 = 3#      | 0 = 0#     | ? = 03  | ) = #2 |
| *                            | OPER                 | 0                            | 4 = 4#      | Space = 11 | / = 04  | + = #3 |
|                              |                      |                              | 5 = 5#      | : = 12     | ! = *1  | = = #4 |
|                              |                      |                              | 6 = 6#      | - = 13     | \$ = *2 | # = ## |
|                              |                      |                              | 7 = 7#      | ' = 14     | & = *4  | . = 24 |

Figure 2-3: Dial Pad Keys

6. Press HOLD to save the entry. A confirmation tone sounds and the display updates.

**Note** If an error is made while entering digits, press HOLD to save the erroneous entry. Key in digits over the old name; if excess characters remain, use the digits [11] to transpose spaces over the undesired characters.

## CO Line - Incoming Ringing Assignment

### Description

Each CO line may be programmed (in database admin) so that incoming ringing on the specified CO line(s) may be assigned initial ringing to one of the following destinations:

- One or more stations (Keyset or SLT)
- A UCD, Voice Mail, or Hunt Group
- Off-Net (via Speed Dial)

The ring-in follows Day Ring assignments unless Night Service mode or Special Ring mode is active, in which case all incoming CO calls follow Night Ring or Special Ring assignments.

When ringing is assigned to a keyset, a direct line appearance or an idle LOOP button must be available to receive the call. Station call forwarding of the initial ringing CO call is possible and can be directed to other keysets with an available LOOP button or direct appearance.

- If the initial ringing CO call cannot ring at the destination assigned, the call rings at the first Attendant station.
- If all ringing assignments are deleted, calls continue to ring at Station 100.

### CO Line Ringing Assignments

#### Description

Each CO Line may be assigned to ring any station in the system; UCD, Voice Mail or Hunt Group, or Off-Net (via speed dial). CO Line ringing is programmed on a per CO Line destination basis. Each destination may be designated to ring during the day, during the night, during both day and night, or on a Special Ring basis. Stations that are assigned for initial ring-in **must have** a LOOP button(s) to answer calls if a direct CO appearance is unavailable.

An incoming CO line may be programmed to any number of stations but it cannot be programmed to ring a mixture of stations and groups in the same time period. Incoming calls directed Off-Net are connected to an outgoing system speed bin. CO lines assigned to ring multiple stations do not follow any station's forwarding.

#### Programming Steps

1. Press **FLASH** and dial **[40]**. The following message displays:

CO LINE ATTRIBUTES  
SELECT A CO LINE RANGE

2. Enter a valid number for the range of lines being programmed. If only one line is being programmed, enter that number twice (001 001).

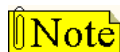

If **HOLD** is pressed without entering a CO line range, all CO lines are selected.

- Press HOLD to save the entry. A confirmation tone sounds and the display updates. Flexible button #19 (Page A) is lit. The following message displays to indicate current programming of that line or group of lines:

|   |
|---|
| XXX - XXX PAGE A<br>ENTER BUTTON NUMBER |
|---|

XXX-XXX = CO Line Range

- Press the RING ASSIGNMENT flexible button (**Button #10**). The display shows the following information:

|                                |
|--------------------------------|
| RING ASSIGNMENTS<br>ENTER DDDR |
|--------------------------------|

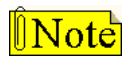

The actual LCD displays a 3-digit destination field (DDD), but both a 3- or 4-digit entry is possible.

- Enter a valid Destination (DDD) or (DDDD) and Ring type (R) followed by the HOLD button. A confirmation tone sounds and the display updates.

**Table 2-5: CO Line Ringing Assignments**

| Valid 3- and 4-Digit Destinations (DDD) and (DDDD) | Valid Ring Types (R)                                  |
|--|---|
| System Speed Bins [9020-9099], for Off-Net Ringing | [0] = No Ring; unassigned; or to delete a destination |
| Flexible Extension Numbers*                        | [1] = Day Ring [D]                                    |
| Flexible Numbers for Voice Mail Groups 1-8*        | [2] = Night Ring [N]                                  |
| Flexible Numbers for Hunt Groups 1-8*              | [3] = Day/Night Ring [DN]                             |
| Flexible Numbers for Direct Ringing to Modem*      | [4] = Special Only [S]                                |
| Flexible Numbers for UCD Groups 1-16*              | [5] = Day/Special [DS]                                |
|  | [6] = Night/Special [NS]                              |
|  | [7] = All Modes [Day/Night/Special [A]                |

\* Internal flexible numbers range = 100-8999

*Features and Operation***To add multiple stations:**

Enter: DDDDR HOLD DDDDR HOLD DDDDR HOLD...etc.  
 (Example: 10073 HOLD, 10083 HOLD, 10093 HOLD)

**To delete a single station:**

Enter: DDDD0 HOLD  
 (Example: 10080 HOLD)

**To delete multiple stations:**

Enter: DDDD0 HOLD DDDD0 HOLD...etc.  
 (Example: 10080 HOLD, 10090 HOLD)

DEFAULT ... All CO lines ring at the Attendant, Station 100 during Day and Night Modes.

*Incoming CO Line Ringing - Setting Flash Rate***Description**

The Incoming CO Line Ringing flash rate is the rate at which an Incoming CO line or Loop Button flashes. This flash rate can be programmed to 29 different options identified in the flash rate table, which enables the programmer to customize the key system configuration to desired flash rates.

**Programming Steps**

1. Press the INC CO RING flexible button (**FLASH 07, Button #1**). The following message displays:

|                     |       |
|---------------------|-------|
| INC CO RING         | 00-28 |
| RED 480 IPM FLUTTER |       |

2. Enter a valid number (00-28) on the dial pad that correspond to one of the 29 available options (refer to [Table 2-16 on page 2-163](#)).
3. Press HOLD to save the entry. A confirmation tone sounds and the display updates.

DEFAULT ... Incoming CO Ringing flash rate is set for RED 480 ipm Flutter (08).



## Display Ring Assignments

### Description

### Programming Steps

1. Press **FLASH** and dial **[40]**. The following message displays:

```
CO LINE ATTRIBUTES
SELECT A CO LINE RANGE
```

2. Enter a valid number for the range of lines being programmed. If only one line is being programmed, enter that number twice (001 001).



If **HOLD** is pressed without entering a CO line range, all CO lines are selected.

3. Press **HOLD** to save the entry. A confirmation tone sounds and the display updates. Flexible button #19 (Page A) is lit. The following message displays to indicate current programming of that line or group of lines:

```
XXX - XXX PAGE A
ENTER BUTTON NUMBER
```

*XXX-XXX = CO Line Range*

4. Press **Button #13** to display ring assignments. Assignments are displayed in sets of six, up to the number programmed. The following format displays the assignments.

```
XDDDDRR XDDDDRR XDDDDRR
XDDDDRR XDDDDRR XDDDDRR
```

*XDDDD = Destination type ID letter followed by number to be dialed:*

*[F] plus Fixed Number, e.g., F102*

*[H] plus Hunt Group Number, e.g., H6700*

*[M] plus Modem Extension Number, e.g., M6099 (default = M499N)*

*[S] plus Station Number, e.g., S6002*

*[U] plus UCD Group/Agent Number, e.g., U6034*

*[V] plus Voice Mail Group Number, e.g., V6899*

*[B] plus Speed Bin Number, e.g., B9090*

*RR:*

*[0] = No Ring*

*[D] = Day Ring*

*[N] = Night Ring*

*[DN] = Day/Night Ring*

*[S] = Special Only*

*[DS] = Day/Special*

*[NS] = Night/Special*

*[A] = All Modes (Day/Night/Special)*

5. Press **Button #13** additional times to cycle to the next group of six ring assignments. Ring assignments are displayed in numerical order, from the lowest to the highest number.

## Release Timer

### Description

The Release Timer option allows the user to adjust the release timer on a per CO Line basis. The release timer is used on ground start type trunks.

This timer is a lead filter timer. The CO must remove ground from the tip lead for longer than this timer in order for the system to recognize it.

### Programming Steps

1. Press **FLASH** and dial **[40]**. The following message displays:

CO LINE ATTRIBUTES  
 SELECT A CO LINE RANGE

2. Enter a valid number for the range of lines being programmed. If only one line is being programmed, enter that number twice (001 001).

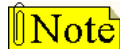

*If HOLD is pressed without entering a CO line range, all CO lines are selected.*

3. Press Button #21 to select Page C. The display updates. The following message displays to indicate current programming of that line or group of lines:

XXX - XXX PAGE C  
 ENTER BUTTON NUMBER

*XXX-XXX = CO Line Range*

4. Press the RELEASE TIMER Button (**Button #4**) in the flexible button field. The following message displays:

RELEASE TIMER            000-255  
 020

5. Enter a valid number on the dial pad which corresponds to 000-255 ms.
6. Press HOLD button to save entry. A confirmation tone sounds and the display updates.

DEFAULT ... Release Timer is set for 200 ms.

## Reseize Timer

### Description

The Reseize Timer option lets the user adjust the Reseize Timer on a per CO Line basis. The Reseize Timer can be used on any trunk type. This timer sets the time period that a trunk is held disconnected after receiving a disconnect before being reseized when a device is queued for a member of the trunk group.

### Programming Steps

1. Press the RESEIZE TIMER Button (**FLASH 40, Page C, Button #5**) in the flexible button field. The following message displays:

|               |         |
|---------------|---------|
| RESEIZE TIMER | 000-255 |
| 200           |         |

2. Enter a valid number on the dial pad that corresponds to 000–255 (0 ms to 2.55 seconds).
3. Press HOLD to save the entry. A confirmation tone sounds and the display updates.

DEFAULT ... Reseize Timer is set for two seconds.

## Guard Timer

### Description

The outgoing Guard Timer is used to set the length of time a CO is held busy to outgoing seizure after a valid release is detected. If a user attempts to access a CO line before the Guard Timer expires, their LED illuminates to indicate that the line is seized, however the CO line is not actually seized until the timer expires. The user gets a busy tone, and may receive a delayed CO dial tone if the timer is set to a large value.

### Programming Steps

1. Press the GUARD TIMER button (**FLASH 40, Page C, Button #6**) in the flexible button field. The following message displays:

|             |      |
|-------------|------|
| GUARD TIMER | 1-60 |
| 05          |      |

2. Enter a valid number on the dial pad which corresponds to 1–60 (100 ms to 6 seconds).
3. Press HOLD to save the entry. A confirmation tone sounds and the display updates.

DEFAULT ...Guard Timer is set for 0.5 seconds.

## Seize Timer

### Description

The Seize Timer option allows the user to adjust the Seize Timer on a per CO Line basis. The Seize Timer is used on ground start type trunks. This Seize Timer is a lead filter timer. The CO must provide ground at the tip lead for longer than this timer in order for the system to recognize it.

### Programming Steps

1. Press the SEIZE TIMER Button (**FLASH 40, Page C, Button #7**) in the flexible button field. The following message displays:

|             |         |
|-------------|---------|
| SEIZE TIMER | 000-255 |
| 010         |         |

2. Enter a valid number on the dial pad which corresponds to 000–255 (100 ms to 2.55 seconds).
3. Press the HOLD button to save the entry. A confirmation tone heard and the display updates.

DEFAULT ... Seize Timer is set for 0.1 seconds.

## Transmit Volume

### Description

Up to ten volume levels are available for each CO Line in the system.

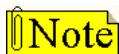

*Do NOT adjust this option without consulting Technical Support first. The default settings were set to apply to most applications. Have the dB readings on all CO lines available when calling Technical Support.*

### Programming Steps

1. Press **FLASH** and dial **[40]**. The following message displays:

|                        |
|------------------------|
| CO LINE ATTRIBUTES     |
| SELECT A CO LINE RANGE |

2. Enter a valid number for the range of lines being programmed. If only one line is being programmed, enter that number twice (001 001).

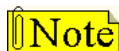

*If HOLD is pressed without entering a CO line range, all CO lines are selected.*

3. Press HOLD to save the entry. A confirmation tone sounds and the display updates. Flexible Button #19 (Page A) is lit.

4. Press the Page B flexible button (Button #20). The following message displays:

|   |
|---|
| XXX - XXX PAGE B<br>ENTER BUTTON NUMBER |
|---|

XXX-XXX = CO Line Range

5. Press the TRANSMIT VOLUME flexible button (**Button #4**). The following message displays:

|  |
|--|
| TRANSMIT VOLUME            0-9<br>0 DB |
|--|

6. Enter a valid number (0-9) for the desired volume level.

|            |             |
|------------|-------------|
| [0] -15 dB | [5] 0 dB    |
| [1] -12 dB | [6] +3 dB   |
| [2] -9 dB  | [7] +6 dB   |
| [3] -6 dB  | [8] +7.5 dB |
| [4] -3 dB  | [9] +9.0 dB |

7. When the desired level is selected, press HOLD to complete the entry. A confirmation tone sounds and the display updates.

DEFAULT ... All CO lines are programmed for level 5 (0 dB).

---

## CO Line Loop and Pool Buttons

### Description

A station not having a direct appearance for a CO line receives incoming CO calls and transferred CO calls under the LOOP button. Only one call at a time can be connected to a keyset on the LOOP button.

- If more than one LOOP button is on a key set, the LOOP buttons may be conferenced together.
- If all programmed LOOP buttons on a keyset are busy or have a CO call on hold, the party attempting to transfer a CO line to that station receives a busy tone and cannot transfer the call to that station.
- If a transfer is attempted, the CO line recalls the initiator immediately.

CO lines are also presented to a Loop when dialing out using LCR or when using speed dial to dial out and the line chosen does not appear on the key station.

The Pool Group feature is used primarily to access CO lines that do not appear on a station, so that outgoing calls may be made. Pooled group keys are associated to CO line groups and may be programmed for use on any of the flexible buttons. CO lines are accessed in descending order of priority starting with the highest numbered available (not busy) CO line in a CO line group. Stations may have as many POOL buttons as there are CO line groups. Multiple POOL buttons for the same group are also allowed.

---

*Features and Operation*

Use Flash 50 programming when you want to modify a range of stations' attributes using **fixed** station numbers.

Use Flash 51 programming to modify a single station's attributes using a **flexible** station number.

### Programming Steps

1. Press **FLASH** and dial [**50**] or dial [**51**]. Flexible button #24 (New Range) is lit and one of the following messages displays:

#### Flash 50 - Fixed Numbers

|  |
|--|
| STATION ATTRIBUTES<br>SELECT A STATION RANGE |
|--|

#### Flash 51 - Flexible Numbers

|                      |
|----------------------|
| ENTER STATION NUMBER |
|----------------------|

2. Enter the range of **fixed** station numbers (100-149) to be programmed. If only one station is being programmed, enter that number twice, e.g., [100 100].

|   |  |
|---|--|
|  <b>Note</b> | <i>If HOLD is pressed without entering a station range, all stations are selected.</i> |
|---|--|

-or-

Enter a valid **flexible** number (100-8999) to be programmed.

3. Press HOLD to save the entry. A confirmation tone sounds and the display updates. Flexible button #19 is lit. The display updates to reflect current programming for Page A:

#### Flash 50 - Fixed Numbers

|   |
|---|
| XXX - XXX PAGE A<br>ENTER BUTTON NUMBER |
|---|

*XXX-XXX = fixed station range*

#### Flash 51 - Flexible Numbers

|                                    |
|------------------------------------|
| SXXX PAGE A<br>ENTER BUTTON NUMBER |
|------------------------------------|

*XXX = 3- or 4-digit flexible number*

4. Press the CO LOOP POOL flexible button (**Button #17**). The following message displays:

|  |
|--|
| CO LOOP POOL FLEX      0-1<br>DISABLED |
|--|

5. Enter a 0 or 1 on the dial pad to enable/disable this feature.  
[0] = Disable  
[1] = Enable
6. Press HOLD to save the entry. A confirmation tone sounds.

DEFAULT ... CO Loop Pool is disabled.

## Operation

To make a Loop button:

1. Press the SPEED button twice.
2. Press the desired flexible button.
3. Dial [89].
4. Press HOLD.

## Conditions

- » Only one station at a time can be programmed when using a flexible station number.
- » When in Flash 51 programming, if you press HOLD without specifying a flexible number to be programmed, you will get the station that is in port/station 100.

## *In-Use Hold (I-Hold) Flash Rate*

### Description

The In Use-Hold (I-Hold) flash rate is the rate at which a CO Line button or Loop button flashes when a call is placed on In-Use Hold (I-Hold). This flash rate can be programmed to 29 different options identified in the flash rate table. This enables the programmer to customize the key system configuration to desired flash rates.

### Programming Steps

1. Press the IN-USE HOLD flexible button (**FLASH 07, Button #14**). The following message displays:

|                    |       |
|--------------------|-------|
| IN-USE HOLD        | 00-28 |
| GREEN 60 IPM FLASH |       |

2. Enter a valid number (00-28) on the dial pad to correspond to one of the 29 available options (refer to [Table 2-16 on page 2-163](#)).
3. Press HOLD to save the entry. A confirmation tone sounds and the display updates.

DEFAULT ... In-Use Hold (I-Hold) flash rate is set for a Green 60 ipm Flash (17).

## CO Line - Loop Supervision

### Description

The STSe can be programmed to monitor CO lines while on-hold or connected to RAN devices or Voice Mail systems, or in Trunk-to-Trunk connections for disconnect signal provided by the Telco. After a disconnect signal is detected, the STSe releases the CO lines and automatically place them back in service.

### Loop Supervision Programming

#### Description

Loop Supervision is used primarily with DISA, Voice Mail / Auto Attendant and with unsupervised conference applications. It lets the system detect when loop current is broken and an outside line is no longer being used. To determine timer value for loop supervision, consult your local central office for type and duration of loop supervision signal.

#### Programming Steps

1. Press **FLASH** and dial **[40]**. The following message displays:

CO LINE ATTRIBUTES  
 SELECT A CO LINE RANGE

2. Enter a valid number for the range of lines being programmed. If only one line is being programmed, enter that number twice (001 001).



*If HOLD is pressed without entering a CO line range, all CO lines are selected.*

3. Press HOLD to save the entry. A confirmation tone sounds and the display updates. Flexible button #19 (Page A) is lit. The following message displays to indicate current programming of that line or group of lines:

XXX - XXX PAGE A  
 ENTER BUTTON NUMBER

*XXX-XXX = CO Line Range*

4. Press the LOOP SUPV flexible button (**Button #6**).
5. Enter a valid number (1-9) on the dial pad which corresponds to 100-900 ms. (0 = disabled).

LOOP SUPERVISION      0-9  
 4

6. Press HOLD to save the entry. A confirmation tone sounds and the display updates.

DEFAULT ... Loop Supervision is set for 400 ms for all CO Lines.



## CO Line Loop Supervision - Forced Disconnect

### Description

This feature ensures that when a party disconnects at the end of a call, the other party is automatically disconnected from the line. This is useful in a system that is connected to a Telco that provides loop supervision, but does not tear down the call. In this case, when the feature is disabled, a dial tone is received by the remaining party - one who may not have permission for outside line use.

Most Telco services do provide a disconnect. This disconnect sounds a tone to the remaining party to positively indicate the disconnect. This is a desired function and consequently this feature is normally left in its default disabled state.

### Programming Steps

1. Press the LOOP SUP IN TALK flexible button (**FLASH 05, Button #14**).

|                  |     |
|------------------|-----|
| LOOP SUP IN TALK | 0-1 |
| DISABLED         |     |

2. Enter a valid number (0 or 1):  
[0] = Disabled  
[1] = Enabled
3. Press HOLD to save the entry. A confirmation tone sounds.

DEFAULT ... CO Line Loop Supervision - Forced Disconnect is disabled.

## SLT Loop Supervision Programming

### Description

Loop Supervision is used primarily with DISA, Voice Mail / Auto Attendant and with unsupervised conference applications. It lets the system detect when loop current is broken and an outside line is no longer being used. Loop supervision can be disabled on SLT lines so that voice mail ports will drop calls when the outside party hangs up.

### Programming Steps

1. Press **FLASH** and dial **[50]** or dial **[51]**. Flexible button #24 (New Range) is lit and one of the following messages displays:

#### Flash 50 - Fixed Numbers

|  |
|--|
| STATION ATTRIBUTES<br>SELECT A STATION RANGE |
|--|

#### Flash 51 - Flexible Numbers

|                      |
|----------------------|
| ENTER STATION NUMBER |
|----------------------|

*Features and Operation*

- Enter the range of **fixed** station numbers (100-149) to be programmed. If only one station is being programmed, enter that number twice, e.g., [100 100].

|             |   |
|-------------|---|
| <b>Note</b> | If HOLD is pressed without entering a station range, all stations are selected. |
|-------------|---|

-or-

Enter a valid **flexible** number (100-8999) to be programmed.

- Press HOLD to save the entry. A confirmation tone sounds and the display updates. Flexible button #19 is lit. The display updates to reflect current programming for Page A:

**Flash 50 - Fixed Numbers**

|   |
|---|
| XXX - XXX PAGE A<br>ENTER BUTTON NUMBER |
|---|

*XXX-XXX = fixed station range*

**Flash 51 - Flexible Numbers**

|                                    |
|------------------------------------|
| SXXX PAGE A<br>ENTER BUTTON NUMBER |
|------------------------------------|

*XXX = 3- or 4-digit flexible number*

- Press button #21. The display updates to reflect current programming for Page C.

**Flash 50 - Fixed Numbers**

|   |
|---|
| XXX - XXX PAGE C<br>ENTER BUTTON NUMBER |
|---|

*XXX-XXX = fixed station range*

**Flash 51 - Flexible Numbers**

|                                    |
|------------------------------------|
| SXXX PAGE C<br>ENTER BUTTON NUMBER |
|------------------------------------|

*XXX = 3- or 4-digit flexible number*

- Press the SLT SUPERVISION button (**Button #7**). The following message displays:

|                            |     |
|----------------------------|-----|
| SLT SUPERVISION<br>ENABLED | 0-1 |
|----------------------------|-----|

- Dial a valid number [0] to disable or [1] to enable SLT Loop Supervision.
- Press HOLD to save the entry.

DEFAULT ... The SLT Loop Supervision setting is [1] (enabled).

**Conditions**

- » Only one station at a time can be programmed when using a flexible station number.
- » When in Flash 51 programming, if you press HOLD without specifying a flexible number to be programmed, you will get the station that is in port/station 100.

## CO Line - Queue

### Description

When all outside lines in a group are busy, stations can be placed in queue awaiting a line in the same group to become available. If a station doesn't answer the queue signal within 15 seconds, that station is dropped from the queue. A station can queue only one line at a time.

### Line Queuing

#### Description

Stations can be allowed or denied the ability to manually queue for a busy group of CO lines. Even when disabled, stations have automatic LCR queuing privileges.

Use Flash 50 programming when you want to modify a range of stations' attributes using **fixed** station numbers.

Use Flash 51 programming to modify a single station's attributes using a **flexible** station number.

#### Programming Steps

1. Press **FLASH** and dial **[50]** or dial **[51]**. Flexible button #24 (New Range) is lit and one of the following messages displays:

##### Flash 50 - Fixed Numbers

STATION ATTRIBUTES  
SELECT A STATION RANGE

##### Flash 51 - Flexible Numbers

ENTER STATION NUMBER

2. Enter the range of **fixed** station numbers (100-149) to be programmed. If only one station is being programmed, enter that number twice, e.g., [100 100].



If **HOLD** is pressed without entering a station range, all stations are selected.

-or-

Enter a valid **flexible** number (100-8999) to be programmed.

3. Press **HOLD** to save the entry. A confirmation tone sounds and the display updates. Flexible button #19 is lit. The display updates to reflect current programming for Page A:

##### Flash 50 - Fixed Numbers

XXX - XXX PAGE A  
ENTER BUTTON NUMBER

XXX-XXX = fixed station range

##### Flash 51 - Flexible Numbers

SXXX PAGE A  
ENTER BUTTON NUMBER

XXX = 3- or 4-digit flexible number

- Press the QUEUING flexible button (**Button #7**). The following message displays:

|              |     |
|--------------|-----|
| LINE QUEUING | 0-1 |
| ENABLED      |     |

- Enter a 0 or 1 on the dial pad to enable/disable this feature.  
[0] = Disabled  
[1] = Enabled
- Press HOLD to save the entry. A confirmation tone sounds.

DEFAULT ... CO Line Queuing is enabled at all stations.

### Operation

***If you wish to be placed on a list waiting for an outside line to become available:***

- Press desired busy OUTSIDE LINE button,  
-or-  
Press the POOL button. (Busy tone sounds.)
- Press the preprogrammed CO LINE QUEUE button (621).
- Replace handset or press ON/OFF button.

### ***To answer a queue:***

If you hear ringing and an outside line of the line group or a LOOP button you queued onto is rapidly flashing:

- Lift handset or press ON/OFF button.
- Press flashing OUTSIDE LINE button or LOOP button to answer.



SINGLE LINE TELEPHONE

- Dial outside line access code. Receive busy tone.
- Press the FLASH button.
- Dial [621]. Confirmation tone sounds.

### Conditions

- » A LOOP button or direct appearance of the queued line is required.
- » Only one station at a time can be programmed when using a flexible station number.
- » When in Flash 51 programming, if you press HOLD without specifying a flexible number to be programmed, you will get the station that is in port/station 100.

## CO Line Queue Button Flash Rate

### Description

The Line Queue Button flash rate is the rate at which the Line Queue button flashes after queuing onto a busy line. This button flashes when the busy line becomes available. This flash rate can be programmed to 29 different options identified in the flash rate table which enables the programmer to customize the key system configuration to desired flash rates.

### Programming Steps

1. Press the LINE QUEUE BTN flexible button (**FLASH 07, Button #17**).

|                     |       |
|---------------------|-------|
| LINE QUEUE BTN      | 00-28 |
| RED 480 IPM FLUTTER |       |

2. Enter a valid number (00-28) on the dial pad to correspond to one of the 29 available options (refer to [Table 2-16 on page 2-163](#)).
3. Press HOLD to save the entry. A confirmation tone sounds and the display updates.

DEFAULT ... Line Queue Button flash rate is set for a Red 480 ipm Flutter (08).

---

## CO Line - Ringing Options

### Description

When a CO call rings at a busy station, the call rings at the station using a muted ring signal. This option allows a user to receive a reminder ring at their busy station, instead of muted ringing. A reminder ring timer is also available to provide the reminder ring every time the timer expires, as long as the incoming CO line remains connected.

Use Flash 50 programming when you want to modify a range of stations' attributes using **fixed** station numbers.

Use Flash 51 programming to modify a single station's attributes using a **flexible** station number.

### Programming Steps

1. Press **FLASH** and dial [**50**] or dial [**51**]. Flexible button #24 (New Range) is lit and one of the following messages displays:

#### Flash 50 - Fixed Numbers

|  |
|--|
| STATION ATTRIBUTES<br>SELECT A STATION RANGE |
|--|

#### Flash 51 - Flexible Numbers

|                      |
|----------------------|
| ENTER STATION NUMBER |
|----------------------|

*Features and Operation*

- Enter the range of **fixed** station numbers (100-149) to be programmed. If only one station is being programmed, enter that number twice, e.g., [100 100].

|   |  |
|---|--|
|  <b>Note</b> | <i>If HOLD is pressed without entering a station range, all stations are selected.</i> |
|---|--|

-or-

Enter a valid **flexible** number (100-8999) to be programmed.

- Press HOLD to save the entry. A confirmation tone sounds and the display updates. Flexible button #19 is lit. The display updates to reflect current programming for Page A:

**Flash 50 - Fixed Numbers**

|   |
|---|
| XXX - XXX PAGE A<br>ENTER BUTTON NUMBER |
|---|

*XXX-XXX = fixed station range*

**Flash 51 - Flexible Numbers**

|                                    |
|------------------------------------|
| SXXX PAGE A<br>ENTER BUTTON NUMBER |
|------------------------------------|

*XXX = 3- or 4-digit flexible number*

- Press the RINGING OPTIONS flexible button (**Button #14**). The following message displays:

|                 |     |
|-----------------|-----|
| CO RING OPTIONS | 0-1 |
| MUTED RING      |     |

- Enter a 0 or 1 on the dial pad to enable/disable this feature.  
[0] = Muted Ring  
[1] = Reminder Ring
- Press HOLD to save the entry. A confirmation tone sounds.

DEFAULT ... Muted Ringing is allowed at all stations.

**Conditions**

- » Only one station at a time can be programmed when using a flexible station number.
- » When in Flash 51 programming, if you press HOLD without specifying a flexible number to be programmed, you will get the station that is in port/station 100.

## Transfer CO Ringing

### Description

The Transfer CO Ringing flash rate is the rate at which a CO Line button or Loop button flashes when a call is transferred to you. This flash rate can be programmed to 29 different options identified in the flash rate table. This enables the programmer to customize the key system configuration to desired flash rates.

### Programming Steps

1. Press the TRANSFER CO RING flexible button (**FLASH 07, Button #9**). The following message displays:

|                   |       |
|-------------------|-------|
| TRANSFER CO RING  | 00-28 |
| RED 120 IPM FLASH |       |

2. Enter a valid number (00-28) on the dial pad to correspond to one of the 29 available options (refer to [Table 2-16 on page 2-163](#)).
3. Press HOLD to save the entry. A confirmation tone sounds and the display updates.

DEFAULT ... Transfer CO Ringing flash rate is set for a Red 120 ipm Flash (10).

## Recall CO Ringing

### Description

The Recall CO Ringing flash rate is the rate at which a CO Line button or Loop button flashes when a call recalls to your station. This flash rate can be programmed to 29 different options identified in the flash rate table. This enables the programmer to customize the key system configuration to desired flash rates.

### Programming Steps

1. Press the RECALL CO RING flexible button (**FLASH 07, Button #10**). The following message displays:

|                     |       |
|---------------------|-------|
| RECALL CO RING      | 00-28 |
| RED 480 IPM FLUTTER |       |

2. Enter a valid number on the dial pad to correspond to one of the 29 available options (refer to [Table 2-16 on page 2-163](#)).
3. Press HOLD to save the entry. A confirmation tone sounds and the display updates.

DEFAULT ... Recall CO Ringing flash rate is set for a Red 480 ipm Flutter (08).

## Queued CO Ringing Flash Rate

### Description

The Queued CO Ringing flash rate is the rate at which a CO Line button or Loop button flashes when a queued line becomes available. This flash rate can be programmed to 29 different options identified in the flash rate table. This enables the programmer to customize the key system configuration to desired flash rates.

### Programming Steps

1. Press the QUEUED CO RING flexible button (**FLASH 07, Button #11**). The following message displays:

|                       |       |
|-----------------------|-------|
| QUEUED CO RING        | 00-28 |
| GREEN 480 IPM FLUTTER |       |

2. Enter a valid number (00-28) on the dial pad to correspond to one of the 29 available options (refer to [Table 2-16 on page 2-163](#))
3. Press HOLD to save the entry. A confirmation tone sounds and the display updates.

DEFAULT ... Queued CO Ringing flash rate is set for a Green 480 ipm Flutter (22).

## Reminder Ring Timer

### Description

When a CO line rings at a busy station, the call rings at the station using muted ringing. The CO Line Ringing Option feature enables a user to receive a reminder ring instead of muted ring. This timer provides a reminder ring every time the timer expires, as long as the incoming CO line remains connected.

If the user continues their present conversation and the CO party does not hang up, the Reminder Ring timer expires and the user receives another ring burst. When the key set user ends the existing call, ringing for the CO call reverts to normal ringing.

The Reminder Ring Timer setting is variable from 00-99 seconds in 1-second increments.

### Programming Steps

1. Press the REMINDER RING flexible button (**FLASH 01, Button #18**). The following message displays:

|               |       |
|---------------|-------|
| REMINDER RING | 00-99 |
| 00            |       |

2. Enter a valid number on the dial pad that corresponds to 00-99 seconds in 1-second increments. A value of 00 disables the timer, therefore the user only receives one ring burst at the beginning of the call.
3. Press HOLD to save the entry. A confirmation tone sounds and the display updates.

DEFAULT ... Reminder Ring Timer is set to 00 second.



## CO Direction

### Description

CO Lines can be programmed on a per CO Line basis for the type of CO Line desired:

#### Incoming

- Incoming restricts the CO Line for incoming calls only.
- Users can place call on hold, park the call, and other stations can pick up the call.

#### Outgoing

- Outgoing restricts the CO Line to outgoing calls only.
- Users can place call on hold, park the call, and other stations can pick up the call.

#### Incoming and Outgoing

- Incoming and outgoing type allow calls to be received or dialed out.

### Programming Steps

1. Press **FLASH** and dial **[40]**. The following message displays:

CO LINE ATTRIBUTES  
SELECT A CO LINE RANGE

2. Enter a valid number for the range of lines being programmed. If only one line is being programmed, enter that number twice (001 001).

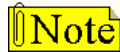

*If HOLD is pressed without entering a CO line range, all CO lines are selected.*

3. Press HOLD to save the entry. A confirmation tone sounds and the display updates. Flexible button #19 (Page A) is lit. The following message displays to indicate current programming of that line or group of lines:

XXX - XXX PAGE A  
ENTER BUTTON NUMBER

*XXX-XXX = CO Line Range*

4. Press the CO DIRECTION flexible button. (**Button #12**). The following message displays:

CO DIRECTION                      0-3  
INCOMING - OUTGOING

5. Enter a valid number (0-3) on the dial pad which corresponds to the desired CO type:
  - [0] = Out-of-Service (OOS)
  - [1] = Incoming Only
  - [2] = Outgoing Only
  - [3] = Both Incoming and Outgoing
6. Press HOLD to save the entry. A confirmation tone sounds and the display updates.

DEFAULT ... All CO Lines default to both incoming and outgoing type.

## CO Port Parameters and Feature Codes

### *Initialize CO Port Assignments / Flexible Numbering Assignments*

#### Description

CO Port Parameters and Flexible Numbering Assignments can be initialized to default values. Refer to *"FLASH 52" on page F-12*, within *Table F-1*, for default values of Flexible Numbering Assignments.

#### Programming Steps

1. Press the CO PORTS/COD flexible button (**FLASH 80, Button #4**).
2. The following message displays:

INITIALIZE CO PORTS/COD  
PRESS HOLD

3. Press the HOLD button. A confirmation tone sounds.

### *Print CO Port Parameters and Feature Codes*

#### Description

The Print CO Port Parameters and Feature Codes command dumps the entire database as a permanent record which can serve as a hardcopy of the database. The system baud rate must match that of the printer or receiving device.

```

CO PORT NUMBERS
 001  002  003  004  005  006  007  008
 009  010  011  012  013  014  015  016
 017  018  019  020  021  022  023  024
 025  026  027  028

STATION PORT NUMBERS
FIXED  FLEX  NAME
 100   100  STATION 100
 101   101  STATION 101
  ::   ::   ::
 149   149  STATION 149
 430   430  CALL PARK GROUP 1
  ::   ::   ::
 (...actual printout includes all feature codes)

```

**Figure 2-4: CO Port Attributes and Feature Codes Printout**

### Programming Steps

1. Press the CO PORTS/CODES flexible button (**FLASH 85, Button #4**). The following message displays:

```
PRINT CO PORTS/CODES
PRESS HOLD
```

2. To print the CO Port Parameters and Feature Codes, press the HOLD button. The following message displays:

```
PRINTING CO PORT
```

When the system finishes sending the requested information to the printer, a confirmation tone sounds.

---

## CO Ring Detect Timer

### Description

The CO Ring Detect Timer controls the time necessary to detect an outside line ringing into the system. The duration of the ringing signal from the CO or the PBX is matched with ringing detection circuitry in the STSe. The ring detect can range from 200 ms to 900 ms programmed in 100 ms increments. This timer helps prevent false ringing.

### Programming Steps

1. Press the CO RING DETECT TIMER flexible button (**FLASH 01, Button #11**). The following message displays:

```
CO RING DETECT      2-9
3
```

2. Enter a valid number on the dial pad that corresponds to 2-9 (200 ms to 900 ms).
3. Press HOLD to save the entry. A confirmation tone sounds and the display updates.

DEFAULT ... CO Ring Detect Timer is set at 3 (300 ms).

---

## CO Tolerance

### Description

This feature allows you to compensate for CO lines that have high Db levels. Such lines are typically found when a customer location is close to a CO location. In certain instances this can cause the keyset to produce undesirable speakerphone effects.

### Programming Steps

1. Press **FLASH** and dial **[41]**. The following message displays:

|                                    |
|------------------------------------|
| CO FEATURES<br>ENTER BUTTON NUMBER |
|------------------------------------|

2. Press Button #11. The following message displays:

|              |     |
|--------------|-----|
| CO TOLERANCE | 0-1 |
| ENABLED      |     |

3. Enter a valid number on the dial pad.  
[0] = Disabled (Close to a CO)  
[1] = Enabled (Normal CO condition)
4. Press HOLD to save the entry. A confirmation tone sounds and the display updates.  
DEFAULT ... Enabled (1) is the default.

---

## Conference

### Description

The two types of conferencing are the multi-party conference and the unsupervised conference.

Multi-party conference - can include up to eight parties. A maximum of five external parties can be conferenced.

Unsupervised Conference - the conference initiator can exit a conference with two outside parties and leave them in an unsupervised conference. The initiator can re-enter the conference at any time. The STSe can automatically terminate the call when both parties hang up, when Loop Supervision is provided by the Telco and enabled in the database. A programmable conference timer disconnects the unsupervised conference if the initiator does not re-enter.

### Conference Enable/Disable

#### Description

The Conference Enable/Disable feature allows administering of the system conference feature on a per station basis for the ability of a station to initiate a conference.

Use Flash 50 programming when you want to modify a range of stations' attributes using **fixed** station numbers.

Use Flash 51 programming to modify a single station's attributes using a **flexible** station number.

#### Programming Steps

1. Press **FLASH** and dial **[50]** or dial **[51]**. Flexible button #24 (New Range) is lit and one of the following messages displays:

##### Flash 50 - Fixed Numbers

STATION ATTRIBUTES  
 SELECT A STATION RANGE

##### Flash 51 - Flexible Numbers

ENTER STATION NUMBER

2. Enter the range of **fixed** station numbers (100-149) to be programmed. If only one station is being programmed, enter that number twice, e.g., [100 100].

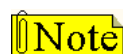

If HOLD is pressed without entering a station range, all stations are selected.

-or-

Enter a valid **flexible** number (100-8999) to be programmed.

- Press HOLD to save the entry. A confirmation tone sounds and the display updates. Flexible button #19 is lit. The display updates to reflect current programming for Page A:

**Flash 50 - Fixed Numbers**

|   |
|---|
| XXX - XXX PAGE A<br>ENTER BUTTON NUMBER |
|---|

*XXX-XXX = fixed station range*

**Flash 51 - Flexible Numbers**

|                                    |
|------------------------------------|
| SXXX PAGE A<br>ENTER BUTTON NUMBER |
|------------------------------------|

*XXX = 3- or 4-digit flexible number*

- Press the CONFERENCE flexible button (**Button #3**). The following message displays:

|                       |     |
|-----------------------|-----|
| CONFERENCE<br>ENABLED | 0-1 |
|-----------------------|-----|

- Enter a 0 or 1 on the dial pad to enable/disable this feature.  
[0] = Disabled  
[1] = Enabled
- Press HOLD to save the entry. A confirmation tone sounds.

DEFAULT ... Conference is enabled.

**Conditions**

- » Only one station at a time can be programmed when using a flexible station number.
- » When in Flash 51 programming, if you press HOLD without specifying a flexible number to be programmed, you will get the station that is in port/station 100.

**Conference / DISA Timer****Description**

The Conference/DISA Timer determines the time an unsupervised conference can continue after the initiator of the conference has exited.

The Conference/DISA Timer setting is variable from 01-99 minutes. A 00 entry disables the timer and no automatic disconnect occurs.

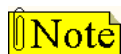

*The Conference Timer also allows the system administrator to control the time a DISA caller is allowed after establishing a Trunk-to-Trunk call. At the expiration of the Conference Timer, a tone is presented to both DISA parties, then one minute later the system automatically releases both trunks.*

*The Conference Timer does not affect or control a DISA-to-Station call.*

## Programming Steps

1. Press the CONFERENCE/DISA TIMER flexible button (**FLASH 01, Button #9**). The following message displays:

|                  |       |
|------------------|-------|
| CONFERENCE TIMER | 00-99 |
| 10               |       |

2. Enter a valid number on the dial pad that corresponds to 01-99 minutes.
3. Press HOLD to save the entry. A confirmation tone sounds and the display updates.

DEFAULT ... Conference/DISA Timer is set at 10 minutes.

## Conference Combinations

### Description

Only stations that have conference enabled can institute a conference.

- Add-On Conference -- Up to eight internal parties can engage in a conference, or seven internal parties with one external party.
- Multi-Line Conference -- One internal station can engage in a conference with up to five outside parties.

### Capacities

The total number of conferences that can be conducted simultaneously system-wide depends upon several factors. The following table shows the system capacity for conferences using specific amounts of parties per conference. Multiple conference capacity configurations are possible. For example, you could have one 8-party conference and five 3-party conferences simultaneously.

| Parties per Conference | Maximum Conferences |
|------------------------|---------------------|
| 3 or 4                 | 10                  |
| 5                      | 5                   |
| 6                      | 3                   |
| 7 or 8                 | 2                   |

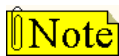

*A maximum of eight parties can be included in a conference.*

### Operation

#### To establish a Conference:

1. Lift handset, then select intercom station or dial desired outside party.
2. When called party answers, press the CONF button.
3. Add next conference party by selecting another outside line or intercom station or by using the Soft Key's ADD MEM option.
4. If the next conference party is an outside line and a busy or wrong number is encountered, press one of the conference parties on hold. This drops the busy or wrong number party. Press the conference button again and repeat step 4.
5. When last party answers, press the CONF button twice (all parties are connected).

**To exit a Conference (controller only) perform ONE of the following:**

1 -- Press ON/OFF button to ON, press MUTE, then replace handset (to monitor conference).

*To exit a multi-line conference in progress:*

2 -- Press the HOLD button to place outside parties on hold. The Hold Timer starts. If one of the two parties is internal, that party is dropped.

3 -- Either press CONF and hang up, press the ON/OFF button, or use the Soft Key's EXIT option to leave the other conference parties still connected in an unsupervised conference. The CONF button flashes and the timer starts. There is a warning tone before the other parties are dropped.

**To re-enter a Conference:**

When the controller re-enters the conference, the disconnect timer is reset.

- Lift handset to re-enter a monitored conference.
- To re-enter a conference placed on hold, repeat steps for establishing a conference.
- To re-enter an unsupervised conference, lift handset and press flashing CONF button or use the Soft Key's RE-ENTER option. CONF button lights steady; a confirmation sounds.

**To terminate a Conference, a conference initiator who is active in the conference must:**

Replace handset or push ON/OFF button to OFF.

**To terminate an Unsupervised Conference:**

Press the flashing CONF button or use the Soft Key's END option while on-hook, all parties are dropped.

**To terminate a party from a Conference (while in conference):**

1. Press line button of party to drop.
2. Replace handset or press ON/OFF button.
3. Lift handset or press ON/OFF button, then press flashing CONF button.



SINGLE LINE TELEPHONE

**To set up a Conference with one external and one other internal station:**

1. Make outside call.
2. Press the FLASH button to put the call on hold.
3. Dial number of internal station you wish to add.
4. When that station answers, press the FLASH button again, all three parties are connected.

**To set up a Conference with Personal Park:**

1. While connected to an outside line, press the FLASH button. The intercom dial tone sounds.
2. Dial [438]. The first call is placed in personal park.
3. Dial desired number for second call.
4. Press the FLASH button. The Intercom dial tone sounds.
5. Dial [664]. All three parties are conferenced.
6. Hang up to terminate the conference.



## Cordless Key Telephone Unit Feature Button

### Description

If a Cordless Key Telephone Unit (CKTU) is associated with the station, the FLEX Button on the CKTU may be assigned to function as any one of the 24 Flexible Buttons on the telephone. This programming area defines which Flexible Button on the telephone is applied to the CKTU FLEX Button. Not all features are available to be assigned to the CKTU FLEX button.

Use Flash 50 programming when you want to modify a range of stations' attributes using **fixed** station numbers.

Use Flash 51 programming to modify a single station's attributes using a **flexible** station number.

### Programming Steps

1. Press **FLASH** and dial **[50]** or dial **[51]**. Flexible button #24 (New Range) is lit and one of the following messages displays:

#### Flash 50 - Fixed Numbers

STATION ATTRIBUTES  
SELECT A STATION RANGE

#### Flash 51 - Flexible Numbers

ENTER STATION NUMBER

2. Enter the range of **fixed** station numbers (100-149) to be programmed. If only one station is being programmed, enter that number twice, e.g., [100 100].

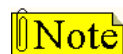

*If HOLD is pressed without entering a station range, all stations are selected.*

-OR-

Enter a valid **flexible** number (100-8999) to be programmed.

3. Press HOLD to save the entry. A confirmation tone sounds and the display updates. Flexible button #19 is lit. The display updates to reflect current programming for Page A:

#### Flash 50 - Fixed Numbers

XXX - XXX PAGE A  
ENTER BUTTON NUMBER

*XXX-XXX = fixed station range*

#### Flash 51 - Flexible Numbers

SXXX PAGE A  
ENTER BUTTON NUMBER

*XXX = 3- or 4-digit flexible number*

4. Press button #20. The display updates to reflect current programming for Page B.

**Flash 50 - Fixed Numbers**

|   |
|---|
| XXX - XXX PAGE B<br>ENTER BUTTON NUMBER |
|---|

*XXX-XXX = fixed station range*

**Flash 51 - Flexible Numbers**

|                                    |
|------------------------------------|
| SXXX PAGE B<br>ENTER BUTTON NUMBER |
|------------------------------------|

*XXX = 3- or 4-digit flexible number*

5. Press the CORDLESS KEY flexible button (**Button #17**) to assign the FLEX Buttons. The following message displays:

|                                   |
|-----------------------------------|
| CORDLESS KEY BTN      00-30<br>XX |
|-----------------------------------|

*XX = Assigned FLEX Button (01-24 = Button 1-24)  
00 = None*

DEFAULT ... No button (00) is assigned to the FLEX.

**Conditions**

- » Only one station at a time can be programmed when using a flexible station number.
- » When in Flash 51 programming, if you press HOLD without specifying a flexible number to be programmed, you will get the station that is in port/station 100.

---

## Database Administration

### Administration Access

**Description**

The Administration Access feature allows a station to access Database Administration. Each station can be enabled/disabled for system programming.

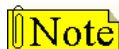

*Station 100 always has programming access regardless of this setting.*

Use Flash 50 programming when you want to modify a range of stations' attributes using **fixed** station numbers.

Use Flash 51 programming to modify a single station's attributes using a **flexible** station number.

## Programming Steps

1. Press **FLASH** and dial **[50]** or dial **[51]**. Flexible button #24 (New Range) is lit and one of the following messages displays:

### Flash 50 - Fixed Numbers

STATION ATTRIBUTES  
SELECT A STATION RANGE

### Flash 51 - Flexible Numbers

ENTER STATION NUMBER

2. Enter the range of **fixed** station numbers (100-149) to be programmed. If only one station is being programmed, enter that number twice, e.g., [100 100].



If **HOLD** is pressed without entering a station range, all stations are selected.

-or-

Enter a valid **flexible** number (100-8999) to be programmed.

3. Press **HOLD** to save the entry. A confirmation tone sounds and the display updates. Flexible button #19 is lit. The display updates to reflect current programming for Page A:

### Flash 50 - Fixed Numbers

XXX - XXX PAGE A  
ENTER BUTTON NUMBER

XXX-XXX = fixed station range

### Flash 51 - Flexible Numbers

SXXX PAGE A  
ENTER BUTTON NUMBER

XXX = 3- or 4-digit flexible number

4. Press the ADMIN ACCESS flexible button (**Button #18**). The following message displays:

ADMIN ACCESS                      0-1  
DISABLED

5. Enter a 0 or 1 on the dial pad to enable/disable this feature.

[0] = Disable

[1] = Enable

6. Press **HOLD** to save the entry. A confirmation tone sounds.

DEFAULT ... This feature is disabled.

## Conditions

- » Only one station at a time can be programmed when using a flexible station number.
- » When in Flash 51 programming, if you press **HOLD** without specifying a flexible number to be programmed, you will get the station that is in port/station 100.

## Administration Password

### Description

The password used to enter customer database programming can be customized by the programmer. This lets the system administrator block unauthorized personnel from entering database admin.



*Care should be taken when changing the programming password so authorized personnel are not locked out, which could prevent or delay them from making necessary programming changes.*

### Programming Steps

1. Press the ADMIN PASSWORD flexible button (**FLASH 20, Button #2**). The following message displays:

ADMIN PASSWORD  
3226

2. Enter a valid number on the dial pad that corresponds with 0000-9999.
3. Press HOLD to save the entry. A confirmation tone sounds and the display updates.

DEFAULT ... Admin Password is set for 3226.

### Operation

On the dial pad, press [\*][\*] plus dial the valid Admin Password. A confirmation tone sounds.

---

## Database Printout (Dump)

### Description

Through a system programming command, either portions of or a complete database dump can be printed using one of the RS-232C connectors located on the BKSU.

The Print System Database command dumps the entire database as a permanent record which can serve as a hardcopy of the database. The system baud rate must match that of the printer or receiving device.

Printing the entire database takes a while to print. A database prints in the following order:

1. All System Parameters
2. All CO Line Programming
3. All CO Ports
4. All Station Attributes
5. All Station Ports
6. Exception Tables (Allow/Deny/Special)
7. System Speed Dial Numbers
8. ICLID Ringing Assignment Table
9. Directory Dialing Table
10. Hunt Group Parameters (Bins 9020-9099)
11. LCR Tables
12. ICLID Parameters and Table(s)
13. UCD Group Parameters
14. Voice Mail Group Parameters
15. DID Translation Table
16. DID-TIE Timers
17. Verified Account Codes Table

### Programming Steps

1. Press the ENTIRE SYSTEM flexible button (**FLASH 85, Button #8**). The following message displays:

PRINT DATABASE  
PRESS HOLD

2. To print the entire database, press the HOLD button. The display updates to indicate what portion of the database is printing.
3. When the system finishes sending the database to the printer, a confirmation tone sounds.

---

## Daylight Saving Time

### Description

The Daylight Saving Time feature allows the system to automatically update the system's time when Daylight Saving Time begins and ends.

### Programming Steps

1. Press the DAYLIGHT SAVING flexible button (**FLASH 05, Button #16**). The following message displays:

|                 |     |
|-----------------|-----|
| DAYLIGHT SAVING | 0-1 |
| DISABLED        |     |

2. Enter a 0 or 1 on the dial pad to enable/disable this feature.  
[0] = Disable  
[1] = Enable
3. Press HOLD to save the entry. A confirmation tone sounds.

DEFAULT ... This feature is disabled.

### Conditions

- » If enabled, on the first Sunday in April, the system will automatically "spring ahead" by one hour, from 02:00 a.m. local standard time to 03:00 a.m. local daylight saving time.
- » If enabled, on the last Sunday in October, the system will automatically "fall back" by one hour, from 02:00 a.m local daylight saving time to 01:00 local standard time.

---

## Dial Pulse Sending

### Description

Each CO interface circuit for outside lines can be programmed to send dial pulse or DTMF signals.

### *Dial Pulse Parameters*

#### Description

By default, all lines are DTMF (tone) signaling. If pulse dialing is required, the individual outside line must be programmed for Dial Pulse (DP). The dial pulse break/make ratio is fixed at 60/40 and the dial speed of the dial pulse signal is fixed at 10 pps.

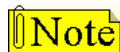

*This program code is only used when an outside (CO) line is programmed for Dial Pulse.*

#### Programming Steps

Press the DIAL PULSE flexible button (**FLASH 41, Button #1**). The following informational message displays:

|                |     |
|----------------|-----|
| DIAL PULSE     | 0-0 |
| 60 / 40 10 PPS |     |

### *Pulse Dial Inter-Digit Timer*

#### Description

This governs the inter-digit time of the Pulse Dial Digits, rotary dial mode. The Pulse Dial Ring Timer setting is variable from 300-600 ms.

#### Programming Steps

1. Press the PULSE DIAL I/D TIMER flexible button (**FLASH 02, Button #5**). The following message displays:

|                 |         |
|-----------------|---------|
| INT DIGIT PULSE | 300-600 |
| 300             |         |

2. Enter a valid number on the dial pad that corresponds to 300-600 ms.
3. Press HOLD to save the entry. A confirmation tone sounds and the display updates.

DEFAULT ... Pulse Dial Ring Timer is set for 300 ms.

## *Pulse-to-Tone Switchover*

### **Description**

When commanded, the system changes the signaling on an outside line from dial pulse to DTMF (tone), allowing the use of common carriers behind a dial pulse outside line. This can be done manually when dialing, or can be stored within a speed dial number.

### **Operation**

To perform the change-over:

Dial [\*] on the dial pad. The remaining digit(s) is sent using DTMF.

(The Pulse-To-Tone Switchover command may also be included in a speed dial bin.)

---

## **Direct Inward Dialing**

### **Description**

This feature allows the number and name field of the LCD display on a direct inward dialing (DID) call to be presented to the ICLID port. Calls are identified in the SMDR field as Answered (I) or Unanswered (U) followed by the DID number.

DID calls are treated as incoming calls and follow the same rules established for CO lines. DID information transferred from the network is captured and translated to direct a specific DID number to a specific station, Hunt group of stations, or Voice Mail group. The DID call appears at the destination station under an assigned Loop or CO button.

When receiving a DID call, the destination station hears the CO line ringing and the assigned CO or Loop button flashes at the incoming CO line flash rate. The destination station then presses the flashing CO or Loop button, is connected to the incoming DID call, and CO line ringing stops and the LED for the CO or Loop button lights steady.

If the outside caller disconnects from a two-party conversation, the Central Office opens the loop and returns the line to idle state. The STSe Digital System detects the disconnect signal, release the line, and provides a busy tone to the keyset/SLT (unless the SLT is a VM port), and disconnects from the DID line. If the extension called hangs up the phone, the central office detects disconnects, and returns the line to the idle state.

The DID feature provides one-way direct inward dialing access to specific stations on specific DID lines from the public telephone network, without going through an Attendant answering position. DID capabilities refer to incoming calls only.

The DID feature requires a T-1 Interface Board (T1IB) with DNIS capability that provides 24 one-way DID circuits on the STSe. The system can accept 2-7 digits from the Central Office.

By default, all entries in the DID Table (000-999) have phone numbers assigned. Refer to [Table 2-6: DID Translation / Route Default Table Entries](#) for additional information.



**Table 2-6: DID Translation / Route Default Table Entries**

| DID Translation Table<br>(Flash 44) |                  | Route Table<br>(Flash 43) |                     |
|-------------------------------------|------------------|---------------------------|---------------------|
| DID Table Entry                     | Default Route(s) | Route Table Entry         | Default Destination |
| 000-049                             | 100-149          | 100-149                   | 100A-149A           |
| 050-098                             | 1                | 1                         | None                |
| 099                                 | 199              | 199                       | 199A                |
| 100-149                             | 100-149          | 100-149                   | 100A-149A           |
| 150-198                             | 1                | 1                         | None                |
| 199                                 | 199              | 199                       | 199A                |
| 200-249                             | 100-149          | 100-149                   | 100A-149A           |
| 250-298                             | 1                | 1                         | None                |
| 299                                 | 199              | 199                       | 199A                |
| 300-349                             | 100-149          | 100-149                   | 100A-149A           |
| 350-398                             | 1                | 1                         | None                |
| 399                                 | 199              | 199                       | 199A                |
| 400-449                             | 100-149          | 100-149                   | 100A-149A           |
| 450-498                             | 1                | 1                         | None                |
| 499                                 | 199              | 199                       | 199A                |
| 500-549                             | 100-149          | 100-149                   | 100A-149A           |
| 550-598                             | 1                | 1                         | None                |
| 599                                 | 199              | 199                       | 199A                |
| 600-649                             | 100-149          | 100-149                   | 100A-149A           |
| 650-698                             | 1                | 1                         | None                |
| 699                                 | 199              | 199                       | 199A                |
| 700-749                             | 100-149          | 100-149                   | 100A-149A           |
| 750-798                             | 1                | 1                         | None                |
| 799                                 | 199              | 199                       | 199A                |
| 800-849                             | 100-149          | 100-149                   | 100A-149A           |
| 850-898                             | 1                | 1                         | None                |
| 899                                 | 199              | 199                       | 199A                |
| 900-949                             | 100-149          | 100-149                   | 100A-149A           |
| 950-998                             | 1                | 1                         | None                |
| 999                                 | 199              | 199                       | 199A                |

**Route 000** in the DID Ringing Assignment Table is used as the intercept route. Calls to numbers not contained in the DID table follow Route 000. If Route 000 is defaulted to None, the call follows Route 001.

**Route 001** is used as the Busy DID Route. DO NOT program any entries in this Route if you intend to provide a busy tone to callers dialing a busy DID/DNIS number.

**Programming Steps**

Press **FLASH** and dial **[44]**. The following message displays:

DID RRR XXXXXXXX  
n.....n

[RRR] = Route Number (000-251)

[###] = DID Number (Directory # from Central Office)

[n...n] = Name Assigned to DID Number

The top left button (ROUTE) in the flexible button field is lit for programming the Route number. The LEDs for the UP Button (**Button #18**), the DOWN Button (**Button #19**) is also lit.

**To change to a different DID Route Number:**

1. Press either the UP Button (**Button #18**),  
-or-  
Press the DOWN Button (**Button #19**).
2. Enter a valid Route Number (000-251) to be associated with the DID Number.  
This Route Number is the same Route Number in the ICLID Ringing Assignments Table (**FLASH 43**) and determines the destination of the DID number associated with this Route Number. The display shows the route number as it is entered.
3. Press the HOLD button to save the entry. A confirmation tone sounds.

*DID Phone Number***Programming Steps**

1. Press the PHONE NUMBER flexible button (**Button #2**) to program the DID Number.
2. Enter the DID Number to be associated with a valid Route Number (000-251). Up to 7 digits can be entered.  
By default, only the last three digits are used for routing which is determined in Flash 43.
3. Use the BACK SPACE flexible button (**Button #5**) to erase the current number or to correct for errors.
4. Press HOLD to save the entry. A confirmation tone sounds.  
If the DID number is already in the DID Translation Table, the Route Number associated with the DID number displays.



By default, the DID Table is filled with numbers. If error tone is received when the HOLD button is pressed, the DID Table is full and an entry needs to be deleted to make room for this new phone number.

*Name Assigned to DID Number***Programming Steps**

1. Press the NAME flexible button (**Button #3**) to enter the desired name for the DID trunk. Maximum length is 16 characters.
2. Press the HOLD button to update the database. A confirmation tone sounds.
3. Use the BACK SPACE flexible button (**Button #5**) to erase the current letter to correct for errors.

### DID Name and Number Codes

The display shows the DID name or number as it is entered.

|                              |                      |                              | Other Codes |            |         |        |
|------------------------------|----------------------|------------------------------|-------------|------------|---------|--------|
| 1                            | A-21<br>B-22<br>C-23 | D-31<br>E-32<br>F-33         | 1 = 1#      | 8 = 8#     | " = 01  | * = *# |
| G-41<br>H-42<br>I-43         | J-51<br>K-52<br>L-53 | M-61<br>N-62<br>O-63         | 2 = 2#      | 9 = 9#     | , = 02  | ( = #1 |
| P-71<br>R-72<br>S-73<br>Q-74 | T-81<br>U-82<br>V-83 | W-91<br>X-92<br>Y-93<br>Z-94 | 3 = 3#      | 0 = 0#     | ? = 03  | ) = #2 |
| *                            | OPER                 | 0                            | 4 = 4#      | Space = 11 | / = 04  | + = #3 |
|                              |                      |                              | 5 = 5#      | : = 12     | ! = *1  | = = #4 |
|                              |                      |                              | 6 = 6#      | - = 13     | \$ = *2 | # = ## |
|                              |                      |                              | 7 = 7#      | ' = 14     | & = *4  | . = 24 |

Figure 2-5: DID Name/Number Codes

### Erasing a DID Table Entry

#### Programming Steps

##### To clear entries from DID Table:

1. Press the CLEAR ENTRY Button (**Button #4**) to clear an entire Phone Number, Name and Route from the DID Table.
2. Press the HOLD button to save the entry. A confirmation tone sounds.

##### To change to a different DID Route:

Press the UP button (**Button #18**) to advance to the DID Route Number,

-or-

Press the DOWN button (**Button #19**) to return to a previous DID Route Number.

## DID/ICLID Ringing Assignments

### Description

DID/ICLID Ringing Assignments let you change the ring assignment based on the incoming number received. This feature permits you to select from 252 ringing routes for each entry in the name to number translation table (**Flash 55**). For example, this feature could be used to reroute selected customers to a specific UCD group and bypass the general Attendant.

The Direct Inward Dialing (DID) feature permits one-way direct inward dialing access to stations on specific DID lines from the public telephone network, without going through an Attendant answering position. DID capabilities refer to incoming calls only.

The system accepts 3-7 digits from the Central Office. This lets the number and name field of the LCD display on a DID. Calls are identified in the SMDR field as answered (I) or Unanswered (U) followed by the DID number. At least one DTMF receiver must be installed.

### Programming Steps

1. Press **FLASH** and dial **[43]**. The following message displays.

ROUTE 000 DDDDR

*000 = Route Number (000–251)*

*DDDD = 3- or 4-Digit Ringing Destination Number*

*R = Ringing Type*

2. Press the RING ASSIGNMENT flexible button (**Button #1**). LED #1 is lit indicating Route 000 is ready for programming.

#### To change to a different DID Route:

Press the UP button (**Button #18**) to advance to the DID Route Number, or  
 Press the DOWN button (**Button #19**) to return to a previous DID Route Number, or  
 Press (**Button #20**) and dial a desired route number followed by HOLD to change to a specific route.

3. Enter a valid Destination (DDD) or (DDDD) and Ring type (R) followed by HOLD. A confirmation tone sounds and the display updates.

-or-

If Ringing Assignment is for a specific Tenant Group Attendant, enter a two-digit entry of [0] and Ring type (R) followed by HOLD.

| Valid 3- and 4-Digit Destinations (DDD) and (DDDD)   | Valid Ring Types (R)                              |
|--|---|
| System Speed Bins [9020-9099], for Off-Net Ringing   | [0] = No Ring; unassigned; or to delete a station |
| Flexible Extension Numbers*                          | [1] = Day Ring [D]                                |
| Flexible Numbers for Voice Mail Groups 1–8*          | [2] = Night Ring [N]                              |
| Flexible Numbers for Hunt Groups 1–8*                | [3] = Day/Night Ring [DN]                         |
| Flexible Numbers for Direct Ringing to Modem*        | [4] = Special Only [S]                            |
| Flexible Numbers for UCD Groups 1–16*                | [5] = Day/Special [DS]                            |
| Local Number/Name Translation Table Number [600-799] | [6] = Night/Special [NS]                          |
|  | [7] = All Modes [Day/Night/Special [A]            |

\* Internal flexible numbers range = 100-8999

## View DID/ICLID Ringing Assignments

### Description

Keysets designated to ring on an incoming CO line but not designated to ring on the DID/ICLID ring, may receive a ring cycle before the call is moved. The same ringing restrictions applied to CO line ringing are applied to DID/ICLID ringing.

### Programming Steps

1. Press **Button #17** to display ring assignments. Assignments are displayed in sets of five, up to the number programmed. Press **Button #17** additional times to cycle to the next group of five ring assignments.

|  |
|--|
| ROUTE 000 XDDDDRR XDDDDRR<br>XDDDDRR XDDDDRR XDDDDRR |
|--|

XDDDD = Destination type ID letter followed by number to be dialed:

[F] plus Fixed Number, e.g., F102

[H] plus Hunt Group Number, e.g., H6700

[M] plus Modem Extension Number, e.g., M6099 (default = M499N)

[S] plus Station Number, e.g., S6002

[U] plus UCD Group/Agent Number, e.g., U6034

[V] plus Voice Mail Group Number, e.g., V6899

[B] plus Speed Bin Number, e.g., B9090

RR:

[0] = No Ring

[D] = Day Ring

[N] = Night Ring

[DN] = Day/Night Ring

[S] = Special Only

[DS] = Day/Special

[NS] = Night/Special

[A] = All Modes (Day/Night/Special)

Multiple Station Assignments are accomplished by assigning another destination with ring status, DDDDR, and pressing HOLD. This can be done for up to the maximum number of stations on the system.

#### To advance to the next route:

Press the NEXT flexible button (**Button #18**) to advance to the next route number.

#### To return to a previous route:

Press the PREVIOUS flexible button (**Button #19**) to return to the previous route number.

#### To select a different route:

1. Press the SELECT ROUTE NUMBER flexible button (**Button #20**) to select the desired route number.
2. Enter a valid route number (000–251).
3. Press HOLD to change to the different route entered. A confirmation tone sounds.

DEFAULT ... No destinations or ringing assignments exist.

## Preset Call Forward Destination - Day/Night/Special

### Description

The Preset Call Forward Destination feature enables a CO line to initially ring at multiple stations and forward to a pre-determined destination. The destination can be a station (EKT-SLT), Voice Mailbox, UCD group, Hunt group, or speed bin. Each CO line has a Preset Forward Timer. Each CO line also has a VMID field to allow sending of specific VM digits when a CO line forwards to a VM group. Calls ringing into UCD Groups or Voice Mail Groups continue to ring the group. The CO line does not forward when ringing one of these types of groups.

### Programming Steps

1. Press **FLASH** and dial **[43]**. The **Button #1** LED is illuminated and the following message displays:

ROUTE 000 DDDDRR

*000 = Route Number (000-251)*

*DDDD = 3- or 4-Digit Ringing Destination Number*

*R = Ringing Type*

2. Enter a valid number for the route to be programmed.
3. Press **Button #2** to set a Preset Forward Day Destination.

PRESET FORWARD DAY DEST  
 ####

4. Enter the destination number, then press HOLD. A confirmation tone sounds and the LCD display updates.
5. Press **Button #3** to set a Preset Forward Night Destination.

PRESET FORWARD NIGHT DEST  
 ####

6. Enter the destination number, then press HOLD. A confirmation tone sounds and the LCD display updates.
7. Press **Button #4** to set a Preset Forward Special Destination.

PRESET FORWARD SPECIAL DEST  
 ####

8. Enter the destination number, then press HOLD. A confirmation tone sounds and the LCD display updates.

DEFAULT ... No destinations are assigned.

## Conditions

- » Preset Call Forwarding (CO Line) will not occur if initial ringing is to a group, e.g., UCD, VM, or hunt group.

## Preset Forward Voice Mail ID

### Description

When a route is preset forwarded or rings directly into a VM group and a number is entered in this area of programming, the call will be sent to the voice processing system. If no number is entered in this area of programming, and the DID call is preset forwarded or rings directly into a VM group, it will pass the DID as the VMID.

When forwarded to VM, the standard leave and retrieve tables for the destination VM group will be utilized.

### Programming Steps

1. Press **FLASH** and dial **[43]**. The **Button #1** LED is illuminated and the following message displays:

ROUTE 000 DDDRRR

*000 = Route Number (000-251)*

*DDDD = 3- or 4-Digit Ringing Destination Number*

*R = Ringing Type*

2. Enter a valid number for the route to be programmed.
3. Press **Button #5** and the following displays:

PRESET FORWARD VMID 0-9999  
 ####

4. Enter a valid number on the dial pad that corresponds to 0-9999 for Voice Mail ID digits.
5. Press HOLD to complete the entry. A confirmation tone sounds and the display updates.

### **To delete numbers currently entered:**

1. Press [#] button four times.
2. Press the HOLD button to update (all information is erased).

DEFAULT ... No digits are sent.

## Preset Forward Timer (Incoming Call to a Destination)

### Description

The Preset Forward Timer will begin when a call is routed via the route table. If the timer expires before a ringing destination answers, the call will forward to the appropriate destination as programmed in Flash 43, Buttons #2-4.

### Programming Steps

1. Press **FLASH** and dial **[43]**. The **Button #1** LED is illuminated and the following message displays:

```
ROUTE 000 DDDRR
```

*000 = Route Number (000-251)*

*DDD = 3- or 4-Digit Ringing Destination Number*

*R = Ringing Type*

2. Enter a valid number for the route to be programmed.
3. Press the PRESET FWD DAY TMR flexible button (**Button #6**). The following message displays:

```
PRESET FWD DAY TMR    00-99
10
```

4. Enter valid number on dial pad which corresponds to 00–99 seconds.
5. Press HOLD to save the entry. A confirmation tone sounds and the display updates.

DEFAULT ... Preset Forward Day Timer is set at 10 seconds.

6. Press the PRESET FWD NGT TMR flexible button (**Button #11**). The following message displays:

```
PRESET FWD NGT TMR    00-99
10
```

7. Enter valid number on dial pad which corresponds to 00–99 seconds.
8. Press HOLD to save the entry. A confirmation tone sounds and the display updates.

DEFAULT ... Preset Forward Night Timer is set at 10 seconds.

9. Press the PRESET FWD SPL TMR flexible button (**Button #12**). The following message displays:

```
PRESET FWD SPL TMR    00-99
10
```

10. Enter valid number on dial pad which corresponds to 00–99 seconds.
11. Press HOLD to save the entry. A confirmation tone sounds and the display updates.

DEFAULT ... Preset Forward Special Timer is set at 10 seconds.



## Music-On-Hold (per CO Line)

### Description

This feature allows a specific MOH channel to be associated with a route.

### Programming Steps

1. Press **FLASH** and dial **[43]**. The **Button #1** LED is illuminated and the following message displays:

|                 |
|-----------------|
| ROUTE 000 DDDRR |
|-----------------|

000 = Route Number (000-251)

DDD = 3- or 4-Digit Ringing Destination Number

R = Ringing Type

2. Enter a valid number for the route to be programmed.
3. Press the MUSIC-ON-HOLD flexible button (**Button #7**). The following message displays:

|             |     |
|-------------|-----|
| MOH CHANNEL | 0-8 |
| 1           |     |

4. Enter a valid number on the dial pad to change this feature.  
[0] = No Music-On-Hold  
[1] = Channel 1  
: : : : :  
[8] = Channel 8
5. Press HOLD to save the entry. A confirmation tone sounds and the display updates.

**Table 2-7: MOH Programming Codes**

| Program Code  | Flexible Button | Feature           | Default (after initialization) |
|---|-----------------|-------------------|--------------------------------|
| FLASH 09  | 2               | Music Channel #4* | ##                             |
|   | 3               | Music Channel #5* | ##                             |
|   | 4               | Music Channel #6* | ##                             |
|   | 5               | Music Channel #7* | ##                             |
|   | 6               | Music Channel #8* | ##                             |
| * Music Channels 4-8 can only be used for Music-On-Hold functions |                 |                   |                                |

DEFAULT ... Channel 1 is used for Music-On-Hold.

## Universal Night Answer (UNA) / Universal Day Answer (UDA)

### Description

This feature will allow calls that use the route table to be picked up by stations not normally assigned access to the line(s) by dialing feature code [#5]. This station must have a direct CO appearance or an available loop key assigned to do this.

### Programming Steps

1. Press **FLASH** and dial **[43]**. The **Button #1** LED is illuminated and the following message displays:

|                 |
|-----------------|
| ROUTE 000 DDDRR |
|-----------------|

000 = Route Number (000-251)

DDDD = 3- or 4-Digit Ringing Destination Number

R = Ringing Type

2. Enter a valid number for the route to be programmed.
3. Press the UNIVERSAL DAY ANSWER flexible button (**Button #8**).
4. Enter a 0 or 1 on the dial pad to enable/disable this feature.  
[0] = Disabled  
[1] = Enabled

|                      |     |
|----------------------|-----|
| UNIVERSAL DAY ANSWER | 0-1 |
| DISABLED             |     |

5. Press HOLD to save the entry. A confirmation tone sounds.
6. Press the UNA flexible button (**Button #9**).
7. Enter a 0 or 1 on the dial pad to enable/disable this feature.  
[0] = Disabled  
[1] = Enabled

|          |     |
|----------|-----|
| UNA      | 0-1 |
| DISABLED |     |

8. Press HOLD to save the entry. A confirmation tone sounds.

DEFAULT ... UDA is disabled and UNA is enabled.

### Operation

Upon hearing an incoming signal:

1. Lift handset.
2. Dial the UDA/UNA access code [#5] on the dial pad. You are connected to ringing outside line.

## DID Digits

### Description

The DID Digits option allows the installer to adjust the amount of DID Digits received from the CO. This amount is used by all DID trunks in the system.

The DID Translation table can be programmed to determine the number of digits used for the routing of a DID call.

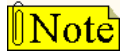

At least one DTMF receiver *MUST* be installed in the system.

### Programming Steps

#### To change the number of DID Digits:

1. Press the DID DIGITS flexible button (**FLASH 41, Button #3**). The following message is shown on the display phone:

|            |     |
|------------|-----|
| DID DIGITS | 2-7 |
| 3          |     |

2. Enter a valid number (2–7) on the dial pad which corresponds to the number of digits used for the routing of the DID Number.
3. Press the HOLD button to save the entry. A confirmation tone sounds and the display updates.

DEFAULT ... Number of DID digits is set to 3.

## DID Incoming Signaling

### Description

The DID Incoming Signal option allows the installer to determine the type of incoming signaling used by all T-1 trunks in the system.

### Programming Steps

DTMF is the DID Signaling type used for DID Trunks. Do not change the default setting of DTMF unless instructed to do so by technical support.

1. Press the DID INCOMING SIGNALING flexible button (**FLASH 41, Button #5**) for programming the type of DID signaling desired.

The following message is shown on the display phone:

|                   |     |
|-------------------|-----|
| DID INC SIGNALING | 0-1 |
| DTMF              |     |

2. Enter a 0 or 1 on the dial pad.  
[0] = Not applicable (reserved for future use)  
[1] = DTMF
3. Press the HOLD button to save the entry. A confirmation tone sounds and the display updates.

DEFAULT ... DID Incoming Signaling type is set for DTMF.

## DID/TIE Signaling

### Description

The DID/TIE Signaling feature can be programmed for one-way direct access inward dialing access to specific stations on specific DID lines without going through an Attendant answering position.

### Programming Steps

1. Press **FLASH** and dial **[40]**. The following message displays:

|  |
|--|
| CO LINE ATTRIBUTES<br>SELECT A CO LINE RANGE |
|--|

2. Enter a valid number for the range of lines being programmed. If only one line is being programmed, enter that number twice (001 001).

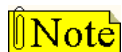

If HOLD is pressed without entering a CO line range, all CO lines are selected.

3. Press HOLD to save the entry. A confirmation tone sounds and the display updates. Flexible button #19 (Page A) is lit. The following message displays to indicate current programming of that line or group of lines:

|   |
|---|
| XXX - XXX PAGE A<br>ENTER BUTTON NUMBER |
|---|

*XXX-XXX = CO Line Range*

4. Press **Button #14**. The following message displays:

|                   |     |
|-------------------|-----|
| DID/TIE SIGNALING | 0-2 |
| WINK              |     |

5. Dial a valid number (0-2) on the dial pad.  
[0] = Immediate Start  
[1] = Wink Start  
[2] = Delay Start

6. Press HOLD to save the entry.

DEFAULT ... DID/TIE Signaling is set to Wink Start.

## DID Collect Timer

### Description

The DID Collect Timer is only used when the DID Incoming Signaling is set for dial pulse. This is a time-out timer that looks at the incoming digits one digit at a time. If a second digit isn't detected within the 150 ms, the telephone system attempts to process that digit. If a second digit is detected, the system waits 150 ms to see if a third digit is received. Otherwise, the telephone system attempts to process the two digits already received. This process continues until no additional digits are received and the time-out timer expires. The DID Collect Timer setting is variable from 100ms to 2.0 seconds.

### Programming Steps

1. Press **FLASH** and dial **[40]**. The following message displays:

```
CO LINE ATTRIBUTES
SELECT A CO LINE RANGE
```

2. Enter a valid number for the range of lines being programmed. If only one line is being programmed, enter that number twice (001 001).

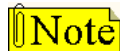

If **HOLD** is pressed without entering a CO line range, all CO lines are selected.

3. Press Button #21 to select Page C. The display updates. The following message displays to indicate current programming of that line or group of lines:

```
XXX - XXX PAGE C
ENTER BUTTON NUMBER
```

XXX-XXX = CO Line Range

4. Press the DID COLLECT TIMER Button (**Button #9**) in the flexible button field. The following message displays:

```
DID COLLECT TIMER   010-200
015
```

5. Enter a valid number on the dial pad that corresponds to 010–200 (100 ms to 2.0 seconds).
6. Press **HOLD** button to save entry. A confirmation tone sounds and the display updates.

DEFAULT ... DID Collect Timer is set for 150 milliseconds.

## Initialize DID-TIE Parameters

### Description

The DID-TIE Parameters and Timers may be initialized, setting all data fields to their original default values.

**Table 2-8: DID-TIE Parameter Defaults**

| Program Code | Flexible Button             | Features              | Default Value (after initialization) |
|--------------|-----------------------------|-----------------------|--------------------------------------|
| FLASH 41     | MISCELLANEOUS CO PARAMETERS |                       |                                      |
|              | 1                           | Dial Pulse Parameters | 60/40 10 pps                         |
|              | 3                           | DID Digits            | 3                                    |
|              | 5                           | DID Incoming Signal   | DTMF                                 |
|              | 6                           | T-1 Incoming Signal   | DTMF                                 |
|              | 7                           | T-1 Framing Type      | D4SF-AMI                             |
|              | 8                           | LCOB Loop Length      | 1=Long                               |
|              | 9                           | Display PRI Name      | 0=Disabled                           |
|              | 11                          | CO Tolerance          | Enabled                              |
|              | 12                          | Shared Tenants CO     | Disabled                             |

### Programming Steps

1. Press the DID-TIE PARAMETERS flexible button (**FLASH 80, Button #13**). The following message displays:

|                                       |
|---------------------------------------|
| INITIALIZE DID-TIE TMRS<br>PRESS HOLD |
|---------------------------------------|

2. Press the HOLD button. A confirmation tone sounds.

## Print DID-TIE Parameters

### Description

The Print DID-TIE command dumps the entire database as a permanent record which can serve as a hard copy of the database. The system baud rate must match that of the printer or receiving device.

When printing the DID-TIE Timers, the following data is printed:

- DID Parameters and Timers
- TIE Line Parameters and Timers

```
DID SIGNALING - WINK
DID DIGITS - 3

TIE SIGNALING - WINK
DID INC SIGNALING - DTMF
TIE INC SIGNALING - DTMF
T1 INC SIGNALING - DTMF
```

**Figure 2-6: DID-TIE Parameters Printout**

### Programming Steps

1. Press the DID-TIE PARAMETERS flexible button (**FLASH 85, Button #14**). The following message displays:

```
PRINT DID/TIE TMRS
PRESS HOLD
```

2. To print the DID-TIE Parameters, press the HOLD button. The following message displays:

```
PRINTING DID/TIE TMRS
```

When the system has finished sending the requested information to the printer, confirmation tone sounds.



## Direct Inward System Access (DISA)

The STSe allows programming of an unlimited number of outside line calls to provide direct access to the system. DISA callers may access LCR, All Internal/External Paging, All Call Paging, Call Park Pick-Up, and Meet-Me Paging. A DTMF receiver must be available for DISA operation. The duration of a trunk-to-trunk DISA call can be set by system administrator.

Incoming DISA callers may access all line groups such as FX or WATS lines or other outgoing services while away from the office.

DISA callers may dial any station directly without going through the Attendant.



*Vodavi has taken precautions to prevent fraud by requiring a security code for this feature. However, it is may still be vulnerable to fraud.*

### DISA Access Code

#### Description

The DISA Access Code feature permits assigning a 3-digit access code to the system. Anyone calling on a DISA line must use this code to gain access to system features. To disable the DISA access code, enter (#) three times. Use of this feature with or without access code can be abused by callers.

#### Programming Steps

1. Press the DISA ACCESS CODE flexible button (**FLASH 20, Button #1**). The following message displays:

DISA ACCESS CODE  
100

2. Enter a valid number (000–999) on the dial pad for the DISA access code.
3. Press HOLD to save the entry. A confirmation tone sounds and the display updates.

DEFAULT ... 100 is the assigned access code.

### DISA Programming

#### Description

Each CO can be assigned as a DISA line using 1 of the 5 DISA types available.

- DISA can be programmed using Range programming.
- DISA callers are subject to the Class of Service placed on the line accessed for out dialing.
- A system administrator can control call duration after establishing a Trunk-to-Trunk call.
- After expiration of the Conference Timer, a tone is presented to both DISA parties, then one minute later the system automatically releases both trunks.
- The Conference Timer does not affect or control a DISA-to-Station call.

## Programming Steps

1. Press **FLASH** and dial **[40]**. The following message displays:

|  |
|--|
| CO LINE ATTRIBUTES<br>SELECT A CO LINE RANGE |
|--|

2. Enter a valid number for the range of lines being programmed. If only one line is being programmed, enter that number twice (001 001).

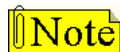

If **HOLD** is pressed without entering a CO line range, all CO lines are selected.

3. Press **HOLD** to save the entry. A confirmation tone sounds and the display updates. Flexible button #19 (Page A) is lit. The following message displays to indicate current programming of that line or group of lines:

|   |
|---|
| XXX - XXX PAGE A<br>ENTER BUTTON NUMBER |
|---|

XXX-XXX = CO Line Range

4. Press the DISA flexible button (**Button #7**).

|           |     |
|-----------|-----|
| DISA TYPE | 0-4 |
| NONE      |     |

5. Enter a valid number (0-4) on the dial pad to indicate type of DISA desired.
  - [0] = No DISA
  - [1] = 24-Hour DISA
  - [2] = Night DISA
  - [3] = 24-Hour DISA with forwarding
  - [4] = Night DISA with forwarding
6. Press **HOLD** to save the entry. A confirmation tone sounds and the display updates.

DEFAULT ... No outside lines are assigned as DISA lines.

## DISA Call Forwarding

Four options are available for a DISA line: 1) 24-hour, 2) night, 3) 24-hour with forwarding, 4) or night with forwarding. The CO line ringing at a station follows preset forward or no-answer call forward using the preset forward timer the same as an initially ringing CO line does. It follows direct forward and busy forward the same as an initially ringing CO line. If the preset forward timer is set to 00 (disabled) the first forward of the DISA ringing call at a station takes 15 seconds.

## DISA CO-to-CO

### Description

The DISA CO-to-CO (or Conference) option on the CO line governs a DISA caller's ability to access other outside lines. CO lines must have DISA CO-to-CO enabled to allow a DISA caller to establish an outgoing CO-to-CO connection. This allows for specific CO line access restriction on DISA calls. A station with Conference enabled can initiate a conference on CO lines regardless of the CO line conference marking.

The CO line conference flag affects a DISA caller's ability to access outgoing CO lines as shown in the following table:

**Table 2-9: CO Line Conference Flag**

| Incoming DISA CO  | DISA Caller Attempts to Access |                   |
|-------------------|--------------------------------|-------------------|
|                   | CO-to-CO Enabled               | CO-to-CO Disabled |
| CO-to-CO Enabled  | Call Allowed                   | Call Denied       |
| CO-to-CO Disabled | Call Denied                    | Call Denied       |

### Programming Steps

1. Press **FLASH** and dial **[40]**. The following message displays:

CO LINE ATTRIBUTES  
 SELECT A CO LINE RANGE

2. Enter a valid number for the range of lines being programmed. If only one line is being programmed, enter that number twice (001 001).

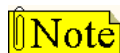

*If HOLD is pressed without entering a CO line range, all CO lines are selected.*

3. Press HOLD to save the entry. A confirmation tone sounds and the display updates. Flexible button #19 (Page A) is lit. The following message displays to indicate current programming of that line or group of lines:

XXX - XXX PAGE A  
 ENTER BUTTON NUMBER

*XXX-XXX = CO Line Range*

4. Press the DISA CO-TO-CO flexible button (**Button #4**).
5. Enter a 0 or 1 on the dial pad to enable/disable this feature.

[0] = Disabled

[1] = Enabled

DISA CO-TO-CO                      0-1  
 ENABLED

6. Press HOLD to save the entry. A confirmation tone sounds.

DEFAULT ... DISA CO-to-CO is enabled for all CO lines.

### Operation

1. Call the phone number the system administrator specified as the DISA line. The system answers and returns internal dial tone.
2. Enter the DISA access code specified by the system administrator, if applicable. Dial tone returns.

#### **To place an outgoing call:**

1. Dial a group access code: 9, 801–823. CO Dial tone returns.
2. Dial the desired telephone number.

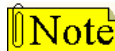

The conference timer monitors a DISA **trunk-to-trunk** call and release the lines one (1) minute after the time expires.

#### **To reach an internal station:**

Dial the desired station number. (Ringback tone sounds.)



If the station dialed is unattended, busy or in DND, intercom dial tone returns, (after the Preset Call Forward Timer expires).



**WARNING:** Toll fraud can occur if DISA is not properly implemented.

---

## Direct Station Selection / Busy Lamp Field

A user with Direct Station Selection (DSS) buttons assigned at their Key Station can call an intercom station or transfer a CO call by pressing the appropriate DSS button.

When a button on a Digital Telephone is assigned as a DSS, it also serves as a Busy Lamp Field (BLF) to display the status of that telephone. Refer to [“Flexible Button Function Assignment” on page 2-163](#) for additional information.

---

## Direct Transfer Mode

### Description

An outside CO line can be transferred from one keyset to another. By using the TRANS button, a screened (announced) transfer can be transferred directly to the handset on any key station. Any number of attempts can be made to locate someone by calling different keysets without losing the call. If a line is transferred to a busy station, it receives muted ringing.

When enabled, supervised transfers (screened transfers) to stations in the handset mode connect calls directly to the handset. The station user must have a direct appearance of that CO line or a Loop button. This feature is programmed on a system-wide basis in admin programming.

### Programming Steps

1. Press the DIRECT TRANSFER flexible button (**FLASH 06, Button #7**). The following message displays:

|                        |     |
|------------------------|-----|
| DIRECT XFER<br>ENABLED | 0-1 |
|------------------------|-----|

2. Enter a 0 or 1 on the dial pad to enable/disable this feature.  
[0] = Disabled  
[1] = Enabled
3. Press HOLD to save the entry. A confirmation tone sounds.

DEFAULT ... Direct Transfer Mode is enabled.

## Directory Dial

### Description

Directory Dial enables display telephone station users to obtain a directory of station users and have the system dial the extension currently displayed. The STSe provides locations for up to 200 names (000-199). Directory dial also lets users program a name with a speed dial bin for use in later locating a speed dial number. When prompted, the system displays the name associated with a speed dial number so when the desired name is shown, the user may then have the system dial the number.

Directory Dial allows users to associate a name with an entry in the local number/name translation table. When prompted, the system displays the name associated with the table so when the desired name is shown, the user may then have the system dial the number.

Directory Dial also includes the following functions:

- ❑ The Directory Dial list may be programmed and maintained at the first assigned Attendant station. However, this admin routine lets the system programmer maintain the list locally (at Attendant) or remotely via modem access.
- ❑ May be used to transfer a call from one station to another.

### Related Information

| Quick Reference |  |
|-----------------|--|
| ➡ Flash 55      | Name/Number Translation Table (refer to <a href="#">"Name/Number Translation Table" on page 2-233</a> ). |

### Programming Steps

#### To enter, change, erase or view entries in the Directory Dial List:

Press **FLASH** and dial **[23]**. The following message displays

DIR LST AAA BIN/ICM : XXXX  
 nnnnnnnnnnnnnnnnnnnnnnnnnnnnnnnnnnn

AAA = Directory list entry number (000-199)

XXXX = Either:

A 3-digit station number (100-149)

-or-

A 3-digit local number/name translation table number (600-799)

-or-

A 4-digit system speed bin number (9020-9099)

nnn = programmed name (blank if none)

#### To select a Directory List entry:

1. Press Flexible button #20 for a directory list entry.
2. Dial a valid directory list entry number (000-199).
3. Press HOLD to save the entry. A confirmation tone sounds and the display updates.

**To scroll through the Directory List:**

- Press the NEXT flexible button (**Button #18**) to scroll up (next entry).
- Press the PREV flexible button (**Button #19**) to scroll back (previous entry).

**To associate a number to an Intercom number or System Speed Dial Bin:**

1. Press the BIN/ICM flexible button (**Button #1**).
2. Enter one of the following: a Station Intercom number, a System Speed Dial number, or a Local Number/Name Translation Table number.

100-149 = Extension Numbers

9020-9099 = System Speed Numbers

600-799 = Local Number/Name Translation Table

3. Press HOLD to save the entry. A confirmation tone sounds and the display updates.

**BIN/ICM** – Each entry in the directory dialing list must be associated to a system speed dial bin (for calling a destination outside of the system), to an intercom station (for calling internal station including CO line transfers), or to a Local Number/Name Translation Table.

**To enter/change current name shown on the display:**

1. Press the NAME flexible button (**Button #2**).
2. Enter the name (up to 24 characters may be entered) by using keys on the dial pad as illustrated in the following figure:

| <table border="1"> <tr> <td style="text-align: center;">1</td> <td>A-21<br/>B-22<br/>C-23</td> <td>D-31<br/>E-32<br/>F-33</td> </tr> <tr> <td>G-41<br/>H-42<br/>I-43</td> <td>J-51<br/>K-52<br/>L-53</td> <td>M-61<br/>N-62<br/>O-63</td> </tr> <tr> <td>P-71<br/>R-72<br/>S-73<br/>Q-74</td> <td>T-81<br/>U-82<br/>V-83</td> <td>W-91<br/>X-92<br/>Y-93<br/>Z-94</td> </tr> <tr> <td style="text-align: center;">*</td> <td style="text-align: center;">OPER<br/>0</td> <td style="text-align: center;">#</td> </tr> </table> | 1                            | A-21<br>B-22<br>C-23 | D-31<br>E-32<br>F-33         | G-41<br>H-42<br>I-43 | J-51<br>K-52<br>L-53 | M-61<br>N-62<br>O-63 | P-71<br>R-72<br>S-73<br>Q-74 | T-81<br>U-82<br>V-83 | W-91<br>X-92<br>Y-93<br>Z-94 | * | OPER<br>0 | # | Other Codes |  |  |  |
|--|------------------------------|----------------------|------------------------------|----------------------|----------------------|----------------------|------------------------------|----------------------|------------------------------|---|-----------|---|-------------|--|--|--|
|  | 1                            | A-21<br>B-22<br>C-23 | D-31<br>E-32<br>F-33         |                      |                      |                      |                              |                      |                              |   |           |   |             |  |  |  |
|  | G-41<br>H-42<br>I-43         | J-51<br>K-52<br>L-53 | M-61<br>N-62<br>O-63         |                      |                      |                      |                              |                      |                              |   |           |   |             |  |  |  |
|  | P-71<br>R-72<br>S-73<br>Q-74 | T-81<br>U-82<br>V-83 | W-91<br>X-92<br>Y-93<br>Z-94 |                      |                      |                      |                              |                      |                              |   |           |   |             |  |  |  |
|  | *                            | OPER<br>0            | #                            |                      |                      |                      |                              |                      |                              |   |           |   |             |  |  |  |
|  | 1 = 1#                       | 8 = 8#               | " = 01                       | * = *#               |                      |                      |                              |                      |                              |   |           |   |             |  |  |  |
|  | 2 = 2#                       | 9 = 9#               | , = 02                       | ( = #1               |                      |                      |                              |                      |                              |   |           |   |             |  |  |  |
| 3 = 3#   | 0 = 0#                       | ? = 03               | ) = #2                       |                      |                      |                      |                              |                      |                              |   |           |   |             |  |  |  |
| 4 = 4#   | Space = 11                   | / = 04               | + = #3                       |                      |                      |                      |                              |                      |                              |   |           |   |             |  |  |  |
| 5 = 5#   | : = 12                       | ! = *1               | = = #4                       |                      |                      |                      |                              |                      |                              |   |           |   |             |  |  |  |
| 6 = 6#   | - = 13                       | \$ = *2              | # = ##                       |                      |                      |                      |                              |                      |                              |   |           |   |             |  |  |  |
| 7 = 7#   | ' = 14                       | & = *4               | . = 24                       |                      |                      |                      |                              |                      |                              |   |           |   |             |  |  |  |

**Figure 2-7: Directory List Keypad Map**

3. If an error is made while entering the name, press the BACK SPACE flexible button (**Button #4**). This button backspaces one character at a time.
4. Press HOLD to save the entry. A confirmation tone sounds and the display updates.

**Name** – A name up to 24 characters may be entered into each directory dial list entry. The names display alphabetically when accessed by a station user. It is possible to have multiple entries that are associated to the same station number or system speed dial bin. This lets the same name be entered into the list several times.

For example, by last name and by first name, pointed to a station number and a speed dial bin (home, or mobile phone number), or several different names associated to the same speed dial bin.

**To clear an entry:**

1. Press the CLEAR flexible button (**Button #3**).
2. Press HOLD to save the entry. A confirmation tone sounds and the display updates. The entry is erased (both the BIN/ICM assignment and the programmed name).

**Clear** – Entries in the table may be erased and cleared which allows placement of another entry into the list. When a system speed dial bin is deleted or changed, the name associated to the bin must also be erased. When a multiple table listing is associated to one system speed dial bin it may be necessary to clear more than one entry.

**Operation****To view the Directory List:**

1. Dial the Directory List dial code [680] on the dial pad,  
-or-  
Press flexible button programmed as a directory dialing button.  
-or-  
Use the Soft Key's DIR-DIAL option when in an idle condition.
2. Press a button on the keypad, once, twice or three times, that represents the letter of the alphabet to begin viewing the list of names (e.g., when 2 is first pressed, it produces names starting with A. When 2 is pressed a second time, names that start with B display. Pressing 2 a third time displays names that start with C). The alphabet is represented on the keypad as shown below.

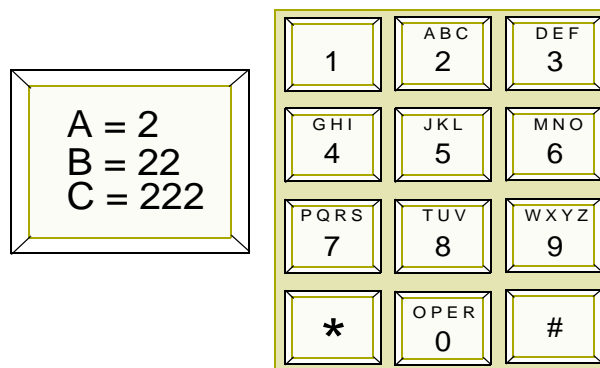
**Figure 2-8: Directory Dialing Keypad Map**

Names beginning with the letter chosen display on the LCD display.

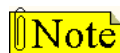

*If there are no names in the Directory List beginning with the desired letter, a name with the next higher letter displays on the LCD display.  
The letters "Q" and "Z" are not marked on many telephone keypads; however, the illustration above shows the correct keys used to access these letters.*



3. Dial [\*] to scroll up (next entry) through the list,  
-or-  
Dial [#] to scroll down (previous entry) through the list,  
-or-  
Press another key to view the list for a different letter of the alphabet.
4. When the desired name displays on the LCD, press the SPEED button to automatically dial the destination station or outside phone number (via speed dial).

**To transfer a call using Directory Dialing while on a call:**

1. Press the TRANS button.
2. Dial the Directory Dial Code [680] on the dial pad,  
-or-  
Press the flexible button programmed for directory dialing.
3. Press the digit associated with the person's name and when it displays, press SPEED to automatically dial the destination station.
4. Hang up to complete the transfer.

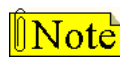

*Calls may be transferred to internal stations only. An attempt to transfer a call off-net (via a speed dial bin) results in the call recalling upon going on-hook.*



SINGLE LINE TELEPHONE

Not applicable

**Conditions**

- » If the desired party is an intercom station, that station is signaled according to their intercom selector/H-T-P switch (SLT stations tone ring).
- » If the desired party is associated to a speed dial bin, the system selects a CO line and dials the number programmed into the speed dial bin. Call progress tones are then heard.
- » If station is in Directory Dial mode and a CO or intercom call rings in, the station must exit Directory Dial mode to answer the call.

## Initialize Directory Dial Table Parameters

### Description

The Directory Dial Table Parameters may be initialized setting all data fields to their original default values.

**Table 2-10: Directory Dial Table Defaults**

| Program Code | Flexible Button      | Features                   | Default Value (after initialization) |
|--------------|----------------------|----------------------------|--------------------------------------|
| FLASH 23     | DIRECTORY DIAL TABLE |                            |                                      |
|              | 1                    | Bin/ICM/RDN Numbering      | None                                 |
|              | 2                    | Name Changes               |                                      |
|              | 3                    | Clear an entry             |                                      |
|              | 4                    | Backspace to correct error |                                      |

### Programming Steps

1. Press the DIRECTORY DIAL TABLE flexible button (**FLASH 80, Button #9**). The following message displays:

|                                     |
|-------------------------------------|
| INITIALIZE DIR - DIAL<br>PRESS HOLD |
|-------------------------------------|

2. Press the HOLD button. A confirmation tone sounds.

## Print Directory Dial Table Parameters

### Description

The Print Directory Dial Table command dumps the entire database as a permanent record which can serve as a hardcopy of the database. The system baud rate must match that of the printer or receiving device.

This is an example of the Directory Dial Table database printout.

| LST | BIN | NAME | 049 | 149 |
|-----|-----|------|-----|-----|
| --- | --- |      | 050 | 150 |
| 000 | 100 |      | 051 | 151 |
| 001 | 101 |      | 052 | 152 |
| 002 | 102 |      | 053 | 153 |
| 003 | 103 |      | 054 | 154 |
| 004 | 104 |      | 055 | 155 |
| 005 | 105 |      | 056 | 156 |
| 006 | 106 |      | 057 | 157 |
| 007 | 107 |      | 058 | 158 |
| 008 | 108 |      | 059 | 159 |
| 009 | 109 |      | 060 | 160 |
| 010 | 110 |      | 061 | 161 |
| 011 | 111 |      | 062 | 162 |
| 012 | 112 |      | 063 | 163 |
| 013 | 113 |      | 064 | 164 |
| 014 | 114 |      | 065 | 165 |
| 015 | 115 |      | 066 | 166 |
| 016 | 116 |      | 067 | 167 |
| 017 | 117 |      | 068 | 168 |
| 018 | 118 |      | 069 | 169 |
| 019 | 119 |      | 070 | 170 |
| 020 | 120 |      | 071 | 171 |
| 021 | 121 |      | 072 | 172 |
| 022 | 122 |      | 073 | 173 |
| 023 | 123 |      | 074 | 174 |
| 024 | 124 |      | 075 | 175 |
| 025 | 125 |      | 076 | 176 |
| 026 | 126 |      | 077 | 177 |
| 027 | 127 |      | 078 | 178 |
| 028 | 128 |      | 079 | 179 |
| 029 | 129 |      | 080 | 180 |
| 030 | 130 |      | 081 | 181 |
| 031 | 131 |      | 082 | 182 |
| 032 | 132 |      | 083 | 183 |
| 033 | 133 |      | 084 | 184 |
| 034 | 134 |      | 085 | 185 |
| 035 | 135 |      | 086 | 186 |
| 036 | 136 |      | 087 | 187 |
| 037 | 137 |      | 088 | 188 |
| 038 | 138 |      | 089 | 189 |
| 041 | 141 |      | 090 | 190 |
| 042 | 142 |      | 093 | 193 |
| 043 | 143 |      | 094 | 194 |
| 044 | 144 |      | 095 | 195 |
| 045 | 145 |      | 096 | 196 |
| 046 | 146 |      | 097 | 197 |
| 047 | 147 |      | 098 | 198 |
| 048 | 148 |      | 099 | 199 |

Figure 2-9: Directory Dialing Table Printout

## Programming Steps

1. Press the DIRECTORY DIAL TABLE flexible button (**FLASH 85, Button #10**). The following message displays:

```
PRINT DIR - DIAL
PRESS HOLD
```

2. To print the Directory Dialing Table parameters, press the HOLD button. The following message displays:

```
PRINTING DIR - DIAL
```

When the system finishes sending the requested information to the printer, a confirmation tone sounds.

## Dial-By-Name

### Description

The system allows station users to dial extension numbers, or speed bins, by entering the name of a person that has been programmed for that station. The system database allows entry of a name (alphanumeric) up to 24 characters in length for each station. The programmed name can be used for dial-by-name station users and in directory dialing. This feature should not be confused with the *Name In Display* feature.

### Operation

1. Dial the Dial-By-Name code [6\*] on the dial pad,  
-or-  
Press the preprogrammed DIAL-BY-NAME flexible button.
2. Dial person's last name on the keypad as shown:

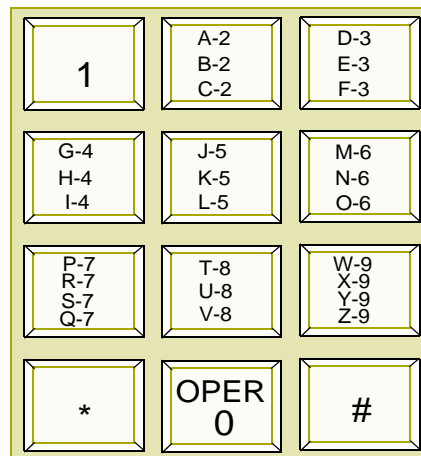

Figure 2-10: Dial-By-Name Keypad Map

EXAMPLE -- To search for the name BROWN, press [2][7][6][9][6].

- When the system finds a unique numeric match to the name being dialed, the call is placed to the station matching the name.
- The intercom call signals the station according to the H-T-P button.
- If fewer than 8 digits are dialed, the numeric match is dialed after a 10-second interdigit time-out occurs, or if [#] is pressed.

### Conditions

- » The system dials the station that matches the dialed name when a unique match is found. If multiple names are located (found) after eight digits, the first one is dialed.
- » Names are entered as part of the system attributes database. Numbers may be entered as part of a name. To avoid conflicts, all names must have a unique numerical sequence.

---

## Distinctive Ringing

### *CO Line Distinctive Ring Tone*

#### Description

The ring tone signal used to notify stations of an incoming call can be changed in administrative programming to provide distinctive ringing on a per CO line basis. A distinctive ring tone can be programmed for each CO line that is used to ring each station. The system provides 36 different ring tones that can be selected for each CO line in the system.

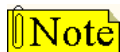

*CO Line Distinctive Ring Tone overrides station distinctive ring tone.*

#### Programming Steps

1. Press **FLASH** and dial **[40]**. The following message displays:

CO LINE ATTRIBUTES  
SELECT A CO LINE RANGE

2. Enter a valid number for the range of lines being programmed. If only one line is being programmed, enter that number twice (001 001).



*If HOLD is pressed without entering a CO line range, all CO lines are selected.*

3. Press **HOLD** to save the entry. A confirmation tone sounds and the display updates. Flexible Button #19 (Page A) is lit.

Features and Operation

- Press the Page B flexible button (Button #20). The following message displays:

XXX - XXX PAGE B  
ENTER BUTTON NUMBER

XXX-XXX = CO Line Range

- Press the RING TONE flexible button (**Button #9**). The following message displays:

RING TONE                      00-36  
00

- Enter a valid number on the dial pad to change this feature.

**Table 2-11: Ringing Tones**

| Tone# | Freq     | Tone# | Freq     | Tone# | Freq      | Tone # | Freq      |
|-------|----------|-------|----------|-------|-----------|--------|-----------|
| 00    | 697/770  | 10    | 770/1209 | 20    | 852/0     | 30     | 1336/1477 |
| 01    | 697/852  | 11    | 770/1336 | 21    | 941/1209  | 31     | 1336/1633 |
| 02    | 697/941  | 12    | 770/1477 | 22    | 941/1336  | 32     | 1336/0    |
| 03    | 697/1209 | 13    | 770/1633 | 23    | 941/1477  | 33     | 1477/1633 |
| 04    | 697/1336 | 14    | 770/0    | 24    | 941/1633  | 34     | 1477/0    |
| 05    | 697/1477 | 15    | 852/941  | 25    | 941/0     | 35     | 1633/0    |
| 06    | 697/1633 | 16    | 852/1209 | 26    | 1209/1336 | 36     | No Ring   |
| 07    | 697/0    | 17    | 852/1336 | 27    | 1209/1477 |        |           |
| 08    | 770/852  | 18    | 852/1477 | 28    | 1209/1633 |        |           |
| 09    | 770/941  | 19    | 852/1633 | 29    | 1209/0    |        |           |

Tone Duration = 50 ms/50 ms

- Press HOLD to save the entry. A confirmation tone sounds and the display updates.

DEFAULT ... Ring Tone is set for 00 (697/770).

## Enabling/Disabling CO Line Distinctive Ring Tone

### Description

The CO Line Distinctive Ring Tone feature must be enabled and disabled in admin programming.

### Programming Steps

1. Press the CO RING TONE flexible button (**FLASH 06, Button #2**). The following message displays:

|               |     |
|---------------|-----|
| CO RING TONES | 0-1 |
| ENABLED       |     |

2. Enter a 0 or 1 on the dial pad to enable/disable the tone ring signal.  
[0] = Disabled  
[1] = Enabled
3. Press HOLD to save the entry. A confirmation tone sounds.

DEFAULT ... CO Line Distinctive Ring Tone is enabled.

## Distinctive Ring Tone - Station

### Description

The ring tone signal that notifies digital stations of an incoming call can be programmed in admin programming or changed by each digital station user to provide distinctive ringing. The system provides 36 different ring tone options.

Use Flash 50 programming when you want to modify a range of stations' attributes using **fixed** station numbers.

Use Flash 51 programming to modify a single station's attributes using a **flexible** station number.

### Programming Steps

To program a Distinctive Ring Tone:

1. Press **FLASH** and dial [**50**] or dial [**51**]. Flexible button #24 (New Range) is lit and one of the following messages displays:

#### Flash 50 - Fixed Numbers

|  |
|--|
| STATION ATTRIBUTES<br>SELECT A STATION RANGE |
|--|

#### Flash 51 - Flexible Numbers

|                      |
|----------------------|
| ENTER STATION NUMBER |
|----------------------|

## Features and Operation

- Enter the range of **fixed** station numbers (100-149) to be programmed. If only one station is being programmed, enter that number twice, e.g., [101 101].

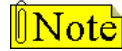

If HOLD is pressed without entering a station range, All stations are selected.

-or-

Enter a valid **flexible** number (100-8999) to be programmed.

- Press HOLD to save the entry. A confirmation tone sounds and the display updates. Flexible button #19 is lit. The display updates to reflect current programming for Page A:

#### Flash 50 - Fixed Numbers

XXX - XXX PAGE A  
ENTER BUTTON NUMBER

XXX-XXX = fixed station range

#### Flash 51 - Flexible Numbers

SXXX PAGE A  
ENTER BUTTON NUMBER

XXX = 3- or 4-digit flexible number

- Press button #21. The display updates to reflect current programming for Page C.

#### Flash 50 - Fixed Numbers

XXX - XXX PAGE C  
ENTER BUTTON NUMBER

XXX-XXX = fixed station range

#### Flash 51 - Flexible Numbers

SXXX PAGE C  
ENTER BUTTON NUMBER

XXX = 3- or 4-digit flexible number

- Press **Button #13**. The following message displays:

RING TONE                      00-36  
XX



- Enter a valid number on the dial pad to change this feature.

**Table 2-12: Ringing Tones**

| Tone# | Freq     | Tone# | Freq     | Tone# | Freq      | Tone # | Freq      |
|-------|----------|-------|----------|-------|-----------|--------|-----------|
| 00    | 697/770  | 10    | 770/1209 | 20    | 852/0     | 30     | 1336/1477 |
| 01    | 697/852  | 11    | 770/1336 | 21    | 941/1209  | 31     | 1336/1633 |
| 02    | 697/941  | 12    | 770/1477 | 22    | 941/1336  | 32     | 1336/0    |
| 03    | 697/1209 | 13    | 770/1633 | 23    | 941/1477  | 33     | 1477/1633 |
| 04    | 697/1336 | 14    | 770/0    | 24    | 941/1633  | 34     | 1477/0    |
| 05    | 697/1477 | 15    | 852/941  | 25    | 941/0     | 35     | 1633/0    |
| 06    | 697/1633 | 16    | 852/1209 | 26    | 1209/1336 | 36     | No Ring   |
| 07    | 697/0    | 17    | 852/1336 | 27    | 1209/1477 |        |           |
| 08    | 770/852  | 18    | 852/1477 | 28    | 1209/1633 |        |           |
| 09    | 770/941  | 19    | 852/1633 | 29    | 1209/0    |        |           |

Tone Duration = 50 ms/50 ms

- Press HOLD to save the entry. A confirmation tone sounds and the display updates.  
DEFAULT ... Distinctive Ring Tone is set for 00 (697/770).

### Operation

#### **To select a distinctive ring tone for a station:**

- Dial the Ring Tone program code [695] on the dial pad. The following message displays:

|                        |       |
|------------------------|-------|
| ENTER RING TONES       | 00-36 |
| XX PRESS SPEED TO SAVE |       |

- Enter a valid tone number. The telephone speaker sounds a steady tone that correlates to the 2-digit entry. The 2-digit tone number displays in the lower left corner of the LCD display.
- When the desired tone is selected (default ringing code is set to 00), press the SPEED button to save it as the tone to present when the station is tone rung. A confirmation tone sounds.

The ringing choices are as follows:

**Table 2-13: Ringing Tones**

| Tone# | Freq     | Tone# | Freq     | Tone# | Freq      | Tone # | Freq      |
|-------|----------|-------|----------|-------|-----------|--------|-----------|
| 00    | 697/770  | 10    | 770/1209 | 20    | 852/0     | 30     | 1336/1477 |
| 01    | 697/852  | 11    | 770/1336 | 21    | 941/1209  | 31     | 1336/1633 |
| 02    | 697/941  | 12    | 770/1477 | 22    | 941/1336  | 32     | 1336/0    |
| 03    | 697/1209 | 13    | 770/1633 | 23    | 941/1477  | 33     | 1477/1633 |
| 04    | 697/1336 | 14    | 770/0    | 24    | 941/1633  | 34     | 1477/0    |
| 05    | 697/1477 | 15    | 852/941  | 25    | 941/0     | 35     | 1633/0    |
| 06    | 697/1633 | 16    | 852/1209 | 26    | 1209/1336 | 36     | No Ring   |
| 07    | 697/0    | 17    | 852/1336 | 27    | 1209/1477 |        |           |
| 08    | 770/852  | 18    | 852/1477 | 28    | 1209/1633 |        |           |
| 09    | 770/941  | 19    | 852/1633 | 29    | 1209/0    |        |           |

*Tone Duration = 50 ms/50 ms*

### Conditions

- » Station users may listen to all tones by dialing the 2-digit codes one after another. The tone that is sounding when the SPEED button is pressed is saved as that station's tone ringing selection.
- » A station's tone ringing selection is maintained in a battery protected area of memory. Therefore, if a system experiences a power failure or a soft or hard restart, the tone ringing selection is restored.
- » The tone selected provides TONE ringing normal or muted to the station whenever the station is commanded to tone ring (i.e., this excludes Camp On tone programming confirmation tones or other specific tones not considered TONE ringing).
- » The selected tone is used to notify the station in the following cases:
  - Incoming CO Call
  - Incoming Intercom Call
  - Transferred CO Line
  - Recalling CO Line
  - Call Back Notification
  - Message Wait Call Back
  - All Types of Forwarded Calls
  - Executive/Secretary calls
  - Line Queue Call Back
  - LCR Queue Call Back
- » CO Line Distinctive Ring Tone supersedes station ring tone and Call Coverage Distinctive Ringing.

## Do Not Disturb / Page Block

### Description

Placing a keyset in Do Not Disturb (DND) eliminates incoming outside line ringing, intercom calls, transfers and paging announcements. A ringing station may go into DND to silence ringing. The Attendant can override a station in DND. Stations in DND can continue to make normal outgoing calls.

Placing a keyset in Page Block eliminates paging announcements only.

Stations can be individually allowed or denied the ability to place their telephone in Do Not Disturb / Page Block. By default, Do Not Disturb / Page Block is enabled at all digital stations. Do Not Disturb is enabled at all SLT stations, but SLT stations cannot use Page Block. Attendants cannot utilize DND or Page Block.

One-time Do Not Disturb allows a station user to turn off muted ringing that occurs while off hook (handset or ON/OFF) on another call. This is useful when having an important conversation and you do not wish to be disturbed by ringing. The station user, while off hook, (ON/OFF or handset) depresses the DND button which eliminates muted ringing. When the station goes on-hook the DND button is extinguished and DND is cancelled.

Use Flash 50 programming when you want to modify a range of stations' attributes using **fixed** station numbers.

Use Flash 51 programming to modify a single station's attributes using a **flexible** station number.

### Programming Steps

1. Press **FLASH** and dial **[50]** or dial **[51]**. Flexible button #24 (New Range) is lit and one of the following messages displays:

#### Flash 50 - Fixed Numbers

STATION ATTRIBUTES  
SELECT A STATION RANGE

#### Flash 51 - Flexible Numbers

ENTER STATION NUMBER

2. Enter the range of **fixed** station numbers (100-149) to be programmed. If only one station is being programmed, enter that number twice, e.g., [100 100].

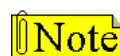

If **HOLD** is pressed without entering a station range, all stations are selected.

-or-

Enter a valid **flexible** number (100-8999) to be programmed.

- Press HOLD to save the entry. A confirmation tone sounds and the display updates. Flexible button #19 is lit. The display updates to reflect current programming for Page A:

**Flash 50 - Fixed Numbers**

|   |
|---|
| XXX - XXX PAGE A<br>ENTER BUTTON NUMBER |
|---|

*XXX-XXX = fixed station range*

**Flash 51 - Flexible Numbers**

|                                    |
|------------------------------------|
| SXXX PAGE A<br>ENTER BUTTON NUMBER |
|------------------------------------|

*XXX = 3- or 4-digit flexible number*

- Press the DO NOT DISTURB flexible button (**Button #2**). The following message displays:

|                           |     |
|---------------------------|-----|
| DO NOT DISTURB<br>ENABLED | 0-1 |
|---------------------------|-----|

- Enter a 0 or 1 on the dial pad to enable/disable this feature.  
[0] = Disabled  
[1] = Enabled
- Press HOLD to save the entry. A confirmation tone sounds.

DEFAULT ... Do Not Disturb / Page Block is enabled at all digital stations. Do Not Disturb is enabled at all SLT stations.

**Operation****To activate Do Not Disturb:**

Press the preprogrammed DND button once (DND button lights steady). The DND button can be pressed while the phone is ringing to stop the ringing.

-or-

Use the Soft Key's DND option when in an idle condition.

**To activate Page Blocking:**

Press the preprogrammed DND button a second time (DND button flashes).

-or-

Use the Soft Key's DND option a second time when in an idle condition.

**To remove Do Not Disturb:**

Press the preprogrammed DND button a third time, use the Soft Key's DND option a third time, or dial either [631] or [662]. The button LED extinguishes and DND cancels.



SINGLE LINE TELEPHONE

**To activate Do Not Disturb:**

- Lift the handset.
- Dial [631].
- Replace the handset.

**To remove Do Not Disturb:**

1. Lift the handset.
2. Dial [631] or [662].
3. Replace the handset.

**Conditions**

- » Calling stations receive a DND audible tone.
- » Attendants do not have DND capability.
- » DND capability is programmable on a per-station basis.
- » Only one station at a time can be programmed when using a flexible station number.
- » When in Flash 51 programming, if you press HOLD without specifying a flexible number to be programmed, you will get the station that is in port/station 100.

***One-Time Do Not Disturb*****Description**

Prevents calls from ringing at your station while you are on a call. The One-Time DND condition automatically cancels when you end your call.

Stations can be individually allowed or denied the ability to place their telephone in Do Not Disturb. Attendants cannot utilize DND.

**Operation****To activate One-time Do Not Disturb:**

Press the preprogrammed DND button while you are off-hook and connected to a CO line or intercom call. The DND button LED lights and off-hook tones at your station cancel.

**To cancel One-time Do Not Disturb:**

Replace handset. The DND button LED extinguishes and DND cancels.

## Do Not Disturb Button Flash Rate

### Description

The Do Not Disturb Button flash rate is the rate at which your Do Not Disturb button flashes when you place your station in a Do Not Disturb mode. This flash rate can be programmed to 29 different options identified in the flash rate table. This enables the programmer to customize the key system configuration to desired flash rates.

### Programming Steps

1. Press the DND BTN flexible button (**FLASH 07, Button #18**). The following message displays:

|               |       |
|---------------|-------|
| DND BTN       | 00-28 |
| RED STEADY ON |       |

2. Enter a valid number (00-28) on the dial pad to correspond to one of the 29 available options (refer to [Table 2-16 on page 2-163](#)).
3. Press HOLD to save the entry. A confirmation tone sounds and the display updates.

DEFAULT ... Do Not Disturb Button flash rate is set for Red Steady On (01).

## Do Not Disturb - DSS/BLF Flash Rate

### Description

This feature controls the rate at which your DSS/BLF buttons for other stations flash, to indicate that they are in a Do Not Disturb mode. This flash rate can be programmed to 29 different options identified in the flash rate table. This enables the programmer to customize the key system configuration to desired flash rates.

### Programming Steps

1. Press the DND – DSS/BLF flexible button (**FLASH 07, Button #6**). The following message displays:

|                         |       |
|-------------------------|-------|
| DND DSS / BLF           | 00-28 |
| RED 60 IPM DBL WINK OFF |       |

2. Enter a valid number (00-28) on the dial pad to correspond to one of the 29 available options (refer to [Table 2-16 on page 2-163](#)).
3. Press HOLD to save the entry. A confirmation tone sounds and the display updates.

DEFAULT ... Do Not Disturb DSS/BLF flash rate is set for a Red 60 ipm Double Wink Off (04).

---

## Door Box

### Description

The Door Box is an intercom unit that can be installed at an entrance to a building. The unit houses a Call Button that a visitor can use for two-way communication with a person inside the building who has a keyset with a **call coverage flexible button** associated with the Door Box. (Refer to [“Call Coverage” on page 2-22](#) for more information on this feature).

Alternatively, the unit can be mounted beyond the reach of visitors and wired to a conventional doorbell switch, which then serves as the Call Button. This option helps protect the Door Box from damage that might be caused by rough handling by visitors or vandals. The unit is wired into a DTIB port in the KSU.

The Door Box can be programmed so that it will provide a unique ring tone to the call coverage station when the visitor presses the Call Button or the doorbell switch. Refer to [“Distinctive Ring Tone - Station” on page 2-143](#).



Placing the Door Box in an enclosed area that offers environmental protection is recommended.

### Programming Steps

The Door Box must be identified as a Door Box station (020) in Flash 50/51, Page B, Button #1 programming. Refer to [“Station Identification” on page 2-283](#).

### Operation

#### **To place a call from the Door Box:**

1. The visitor presses the Call Button once or the doorbell switch once, depending on set up.  
The visitor hears ringing from the Door Box until the keyset user answers the call or until the tenth ring when the phone will stop ringing. The visitor can press the Call Button or doorbell again to resume another 10-ring cycle.  
The keyset with the call coverage flexible button associated with the Door Box also receives ringing and the call coverage button LED illuminates.
2. The keyset user answers the call by going off-hook with the handset or by pressing the ON/OFF button for speakerphone operation.  
The visitor converses in a handsfree mode.  
The Call Button LED is lit whenever the Door Box is in an active state.

#### **To place a call to the Door Box:**

1. The keyset user goes off-hook and presses a flexible button preprogrammed with the Door Box station number or dials that number.
2. The Door Box emits three short bursts of tone to notify the visitor of the call and then the visitor can converse in a handsfree mode.  
The Call Button LED is lit whenever the Door Box is in an active state.

## Executive Override

### Description

The Executive Override feature lets certain stations be designated as Executive stations with the ability to override and barge-in on other key sets engaged in a CO line or intercom conversation. If Supervisor Monitor with barge-in function is allowed, this feature **MUST** be disabled. An optional warning tone is programmed on a system-wide basis to enable or disable the tone. This tone is presented to all parties prior to actual cut through of the third party.



*The Executive Override Blocking feature (FLASH 50, Page A, Button #13) allows or disallows an Executive to override an extension. This prevents an extension with override capability from overriding designated stations.*

Supervisor Barge-In can be programmed in [FLASH 50, Page A, Button #12].

### Executive Override - Enable/Disable

#### Description

This system programmable option enables or disables a warning tone when the station marked as an executive is cut-thru to the conversation. This is useful for UCD agent supervisors or training personnel who require a service observing option.

A separate condition has been added to this feature which allows or disallows an Executive to override an extension. This prevents an extension with override capability from overriding an Executive's station.



*Use of this feature when the Executive Override warning tone is disabled may be interpreted as a violation of federal, state or local laws, and an invasion of privacy. Check applicable laws in your area before intruding on calls using this feature.*



*A change in volume may occur on the CO line or intercom call after the barge-in occurs.*

Use Flash 50 programming when you want to modify a range of stations' attributes using **fixed** station numbers.

Use Flash 51 programming to modify a single station's attributes using a **flexible** station number.

#### Programming Steps

1. Press **FLASH** and dial **[50]** or dial **[51]**. Flexible button #24 (New Range) is lit and one of the following messages displays:

##### Flash 50 - Fixed Numbers

STATION ATTRIBUTES  
SELECT A STATION RANGE

##### Flash 51 - Flexible Numbers

ENTER STATION NUMBER



- Enter the range of **fixed** station numbers (100-149) to be programmed. If only one station is being programmed, enter that number twice, e.g., [100 100].

 *If HOLD is pressed without entering a station range, all stations are selected.*

-or-

Enter a valid **flexible** number (100-8999) to be programmed.

- Press HOLD to save the entry. A confirmation tone sounds and the display updates. Flexible button #19 is lit. The display updates to reflect current programming for Page A:

**Flash 50 - Fixed Numbers**

XXX - XXX PAGE A  
ENTER BUTTON NUMBER

*XXX-XXX = fixed station range*

**Flash 51 - Flexible Numbers**

SXXX PAGE A  
ENTER BUTTON NUMBER

*XXX = 3- or 4-digit flexible number*

- Press the EXECUTIVE OVERRIDE flexible button (**Button #4**). The following displays:

EXEC OVERRIDE                      0-1  
DISABLED

- Enter a 0 or 1 on the dial pad to enable/disable this feature.  
[0] = Disabled  
[1] = Enabled
- Press HOLD to save the entry. A confirmation tone sounds.

 *Use of this feature when the Executive Override Warning Tone is disabled may be interpreted as a violation of federal, state, or local laws, and an invasion of privacy. Check applicable laws in your area before intruding on calls using this feature.*

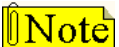
 *A change in volume may occur on the CO line or intercom call after the barge-in occurs.*

DEFAULT ... Executive Override is disabled for all stations.

**Operation**

**To use Executive Override, when calling a busy station:**

- Press the preprogrammed EXECUTIVE OVERRIDE button (The programming code is 625). Executive station is bridged onto the CO line conversation in progress at the called station. An optional warning tone is presented to all parties prior to cut-through.
- Replace handset at Executive station to terminate the override.

## Conditions

- » An error tone occurs when the called party:
  - Is in a conference.
  - Is already on an OHVO call.
  - Has a Camp On at their station.
- » If Executive joins a call and one of the members does a hook-flash or presses their transfer button, the Executive is dropped.
- » If Executive does a hook-flash or presses Transfer button, it is ignored.
- » When the Executive joins an intercom call or CO call and the Executive is not in a mute state, and any member of the party hangs up, the call is converted to a two-party conversation.
- » When the Executive joins an intercom call or CO call and the Executive is in the mute state, and either of the two parties in the intercom call hang up, the call is dropped. If the Executive hangs up, the call remains a two-party conversation.
- » Certain forwarding types affect override operation; except to override forwarding, dial [5#] + extension number.
- » Intercom button disallows Executive Override.
- » Only one station at a time can be programmed when using a flexible station number.
- » When in Flash 51 programming, if you press HOLD without specifying a flexible number to be programmed, you will get the station that is in port/station 100.
- » Recording the conversation is not possible when using Executive Override.

## *Executive Override Blocking*

### Description

The Executive Override Blocking feature allows or disallows override of an extension. This prevents a user with override capability from overriding a station.

Use Flash 50 programming when you want to modify a range of stations' attributes using **fixed** station numbers.

Use Flash 51 programming to modify a single station's attributes using a **flexible** station number.

### Programming Steps

1. Press **FLASH** and dial **[50]** or dial **[51]**. Flexible button #24 (New Range) is lit and one of the following messages displays:

#### Flash 50 - Fixed Numbers

STATION ATTRIBUTES  
SELECT A STATION RANGE

#### Flash 51 - Flexible Numbers

ENTER STATION NUMBER

- Enter the range of **fixed** station numbers (100-149) to be programmed. If only one station is being programmed, enter that number twice, e.g., [100 100].



If HOLD is pressed without entering a station range, all stations are selected.

-or-

Enter a valid **flexible** number (100-8999) to be programmed.

- Press HOLD to save the entry. A confirmation tone sounds and the display updates. Flexible button #19 is lit. The display updates to reflect current programming for Page A:

#### Flash 50 - Fixed Numbers

```
XXX - XXX PAGE A
ENTER BUTTON NUMBER
```

XXX-XXX = fixed station range

#### Flash 51 - Flexible Numbers

```
SXXX PAGE A
ENTER BUTTON NUMBER
```

XXX = 3- or 4-digit flexible number

- Press the EXECUTIVE OVERRIDE BLOCK flexible button (**Button #13**). The following message displays:

```
EXEC OVERRIDE BLOCK    0-1
DISABLED
```

- Enter a 0 or 1 on the dial pad to enable/disable this feature.
  - [0] = Disabled
  - [1] = Enabled
- Press HOLD to save the entry. A confirmation tone sounds.

DEFAULT ... Executive Override Blocking is disabled at all stations.

### Conditions

- » Only one station at a time can be programmed when using a flexible station number.
- » When in Flash 51 programming, if you press HOLD without specifying a flexible number to be programmed, you will get the station that is in port/station 100.

## Executive Override Warning Tone

### Description

The Executive Override Warning enables Executive stations to override and barge-in on other key sets engaged in conversation on a CO line. Prior to actual cut through of the third party, a warning tone is presented to all parties notifying them of the barge-in. This warning tone, however, is a programmable option on a system-wide basis, that either enables or disables the tone. When tone is disabled, no audible signal is presented to parties to signal barge-in.



*Use of this feature when the Executive Override Warning Tone is disabled may be interpreted as a violation of federal, state, or local laws, and an invasion of privacy. Check applicable laws in your area before intruding on calls using this feature.*



*A change in volume may occur on the CO line or intercom call after the barge-in occurs.*

### Programming Steps

1. Press the EXEC OVER WARN TONE flexible button (**FLASH 05, Button #4**).
2. Enter a valid number (0 or 1) that corresponds with the following entries:
  - [0] = Disabled
  - [1] = Enabled

|                   |     |
|-------------------|-----|
| EXECUTIVE WARNING | 0-1 |
| ENABLED           |     |

3. Press HOLD to save the entry. A confirmation tone sounds.

DEFAULT ... Executive Override Warning Tone is enabled.

## Barge-In Warn Tone

### Description

When the Barge-in Warn Tone feature is enabled, it produces a tone to notify a station that another station is about to use Executive Override or the Barge-in feature to cut into the existing conversation.

### Programming Steps

1. Press the BARGE IN WARN TONE flexible button (**FLASH 06, Button #1**). The following message displays:

BARGE IN WARN TONE      0-1  
ENABLED

2. Enter a 0 or 1 on the dial pad to enable/disable the conference tone.  
[0] = Disabled  
[1] = Enabled
3. Press HOLD to save the entry. A confirmation tone sounds.

 *Display stations continue to receive the CONFERENCE display regardless of the warning tone setting.*

Privacy is ensured on all communications in the system. If desired, the user may elect to disable the Barge In feature, thus allowing up to seven other stations to join existing CO Line conversations.

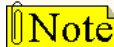
 *Disabling of the Barge In feature may be limited by federal, state, or local law, so check the relevant laws in your area before disabling privacy.*

**Table 2-14: CO Line Barge In Flag**

| Station Attempting to Access CO Line | CO Line in Use by Another Station |                                       |
|--------------------------------------|-----------------------------------|---------------------------------------|
|                                      | Privacy Enabled                   | Privacy Disabled                      |
| Privacy Enabled                      | Private (no cut-through)          | Private (no cut-through)              |
| Privacy Disabled                     | Private (no cut-through)          | Privacy Release (cut-through allowed) |

DEFAULT ... Barge-in Warn Tone is enabled.

---

## Executive/Secretary Pairs

### Description

There are four Executive/Secretary pairs available. When an Executive station is busy or in DND, intercom calls and transfers are automatically routed to the designated Secretary.

The assigned secretary may Camp On to the Executive Station when the station is busy or in Do-Not-Disturb. There can be only one pairing of stations, with no duplicates. You cannot pair Executive 100 to Secretary 101, then pair Secretary 101 to Executive 100. The same Secretary station can be specified for more than one Executive station (101-105 and 102-105). Entering [#] six times removes the assignments. Individual pairs may be changed by pressing the associated flexible button.

### Programming Steps

1. Press **FLASH** and dial **[13]**. The following message displays:

|  |
|--|
| EXEC SECY PAIRINGS<br>####, ####      PAIR 1 |
|--|

The first button is lit indicating the first pair may be programmed.

2. Enter a valid Executive flexible station number, followed by a "1" to add or a "0" to delete.
3. Press HOLD to save the data. A confirmation tone sounds and the display updates.
4. Enter a valid Secretary station number, followed by a "1" to add or a "0" to delete.
5. Press HOLD to save the data. A confirmation tone sounds and the display updates.
  - To program a second pair, press the second flexible button in the flexible button field and enter station numbers as in steps 2-5.
  - To program a third pair, press the third button in the flexible button field and enter station numbers as in steps 2-5.
  - To program a fourth pair, press the fourth button in the flexible button field and enter station numbers as in steps 2-5.

DEFAULT ... No Executive/Secretary pairs are assigned.

### Conditions

- » If you are designated the Executive station and your phone is busy or in DND, all calls are routed to the Secretary station.
- » If you are the designated Secretary station, you can signal the Executive that is busy or in DND by using the Camp On feature.

---

## External Day Ring

### Description

The system can be programmed so CO lines marked for UDA provides ringing out of the external page ports when the system is in the Day Mode.

### Programming Steps

1. Press the EXT DAY RING flexible button (**FLASH 06, Button #5**). The following message displays:

|                   |     |
|-------------------|-----|
| EXTERNAL DAY RING | 0-1 |
| DISABLED          |     |

2. Enter a 0 or 1 on the dial pad to enable/disable External Day Ring.  
[0] = Disabled  
[1] = Enabled
3. Press HOLD to save the entry. A confirmation tone sounds.

DEFAULT ... External Day Ring is disabled.

---

## External Night Ring

### Description

When outside lines are marked UNA, ringing activates a tone over external paging when an incoming call occurs on those lines during night service.

### Programming Steps

1. Press the EXT NIGHT RING flexible button (**FLASH 05, Button #3**).
2. Enter a valid number (0 or 1) that corresponds with the following entries:  
[0] = Disabled  
[1] = Enabled

|                     |     |
|---------------------|-----|
| EXTERNAL NIGHT RING | 0-1 |
| DISABLED            |     |

3. Press HOLD to save the entry. A confirmation tone sounds.

DEFAULT ... External Night Ring is disabled.

## Fax Detect

### Description

This feature allows CO lines to be designated as fax detect line types. Upon a marked CO line receiving a call, the CO line will be transferred to the fax detect circuit to determine if the call is a fax call. If it is, the call will be sent to a pre-programmed destination, if it is not a fax call, the call will ring to destinations in the ring assignment table.

### Programming

#### **Fax Detect enable/disable on a per CO line basis:**

1. Press **FLASH** and dial **[40]**. The following message displays:

CO LINE ATTRIBUTES  
 SELECT A CO LINE RANGE

2. Enter a valid number for the range of lines being programmed. If only one line is being programmed, enter that number twice (001 001).



*If HOLD is pressed without entering a CO line range, all CO lines are selected.*

3. Press HOLD to save the entry. A confirmation tone sounds and the display updates. Flexible Button #19 (Page A) is lit.
4. Press the Page B flexible button (Button #20). The following message displays:

XXX - XXX PAGE B  
 ENTER BUTTON NUMBER

*XXX-XXX = CO Line Range*

5. Press the FAX DETECT flexible button (**Button #18**). The following message displays:

FAX DETECT                      0-1  
 DISABLED

6. Enter a 0 or 1 that corresponds with the following entries:  
 [0] = Disabled  
 [1] = Enabled
7. Press HOLD to save the entry. A confirmation tone sounds.

DEFAULT ... Fax Detect is disabled.



**Fax Route:**

1. Press **FLASH** and dial **[09]**.
2. Press the MUTE RING flexible button (**Button #13**). The following message displays:

|           |         |
|-----------|---------|
| MUTE RING | 000-251 |
| 148       |         |

3. Enter the fax station number.
4. Press HOLD to save the entry. A confirmation tone sounds.

DEFAULT ... station number 148.

**Fax Timeout:**

This determines how long a CO call will ring to the fax detect circuitry before the call is considered a non-fax call and the call is routed via the Flash 40 ring assignment.

1. Press the FAX TIMEOUT flexible button (**FLASH 01, Button #5**). The following message displays:

|             |       |
|-------------|-------|
| FAX TIMEOUT | 00-99 |
| 15          |       |

2. Enter a valid number on the dial pad that corresponds to 00-99 seconds.
3. Press HOLD to save the entry. A confirmation tone sounds and the display updates.

DEFAULT ... Transfer Recall Timer is set for 15 seconds.

**Long Fax Detect:**

This is the amount of time a call will ring before a call is sent to the fax machine. If the Short Time option is selected, the call will ring for 3.5 seconds before being sent to the fax machine. If the Long Time option is selected, the call will ring for 7 seconds.

1. Press the LONG FAX DETECT flexible button (**FLASH 05, Button #19**).

|                 |     |
|-----------------|-----|
| LONG FAX DETECT | 0-1 |
| DISABLED        |     |

2. Enter a valid number (0 or 1):  
     [0] = Disabled (Short Time option)  
     [1] = Enabled (Long Time option)
3. Press HOLD to save the entry. A confirmation tone sounds.

DEFAULT ... Fax Detect Long Time is disabled, which means that the fax detect time is 3.5 seconds.

---

## Fixed Station/Port Number

### Description

When a station dials the feature code 611 on a display telephone, it will display the Fixed Station/Port Number for that telephone. For example, when using flexible numbering some programming steps require the "FIXED" code. This code allows you to dial 611 and quickly determine the fixed port for that station.

STATION PORT:  
XXX



SINGLE LINE TELEPHONE

Not applicable

---

## Flash Rates (Programmable)

### Description

Fixed and flexible button flash rates can be programmed. Nineteen features/functions can be programmed to use on of 14 different red or 14 different green flash rate options. These are set up in FLASH 07 of admin programming. Refer to section that covers the feature/function for the detailed programming steps.

All other flash rates in the system are fixed (defaulted).

When in FLASH 07, the buttons on the digital telephone are mapped as shown in the following illustration.

**Table 2-15: Button Map for Flash Rate Functions**

| Button # | Feature/Function  | Button # | Feature/Function |
|----------|-------------------|----------|------------------|
| 1        | INC CO RING       | 12       | EXCLUSIVE HOLD   |
| 2        | INC ICW RING      | 13       | SYSTEM HOLD      |
| 3        | CALL FORWARD BTN  | 14       | IN USE HOLD      |
| 4        | MSG WAIT/VM BTN   | 15       | CAMP ON BTN      |
| 6        | DND DSS/BLF       | 16       | CALLBACK BTN     |
| 7        | AUTO CBCK DSS/BLF | 17       | LINE QUEUE BTN   |
| 8        | UCD UNAVL DSS/BLF | 18       | DND BTN          |
| 9        | TRANSFER CO RING  | 20       | UCD WRAPUP END   |
| 10       | RECALL CO RING    | 21       | DND PAGE BLOCK   |
| 11       | QUEUED CO RING    | 22       | IN & OUT         |

Table 2-16: Flash Rates

| Red LED Flash Rates |                     | Green LED Flash Rates |                     |
|---------------------|---------------------|-----------------------|---------------------|
| 00                  | Off                 | 15                    | Steady On           |
| 01                  | Steady On           | 16                    | 30 ipm Flash        |
| 02                  | 30 ipm Flash        | 17                    | 60 ipm Flash        |
| 03                  | 60 ipm Flash        | 18                    | 60 ipm Dbl Wink Off |
| 04                  | 60 ipm Dbl Wink Off | 19                    | 240 ipm Flash       |
| 05                  | 240 ipm Flash       | 20                    | 240 ipm Flutter     |
| 06                  | 240 ipm Flutter     | 21                    | 480 ipm Flash       |
| 07                  | 480 ipm Flash       | 22                    | 480 ipm Flutter     |
| 08                  | 480 ipm Flutter     | 23                    | 15 ipm Flash        |
| 09                  | 15 ipm Flash        | 24                    | 120 ipm Flash       |
| 10                  | 120 ipm Flash       | 25                    | 120 ipm Flutter     |
| 11                  | 120 ipm Flutter     | 26                    | 30 ipm Dbl Flash    |
| 12                  | 30 ipm Dbl Flash    | 27                    | 480 ipm Dbl Wink    |
| 13                  | 480 ipm Dbl Wink    | 28                    | 480 ipm Dbl Flash   |
| 14                  | 480 ipm Dbl Flash   |                       |                     |

## Flexible Button Function Assignment

### Description

This feature allows programming of flexible button functions from your own telephone or via Administrative programming. Range programming can assign button functions to multiple stations.

The possible functions you may assign to these buttons include:

- **Outside Line** -- Automatically accesses assigned line (User programmable).
- **DSS/BLF** -- Automatically signal assigned station and provides BLF for off-hook and DND (User programmable).
- **Feature** -- Any feature with a dialing code (Personalized Messages, Paging, Account Code, Call Park, Music, etc.) can be assigned to a flexible button (User programmable).
- **Group Access** (UCD, Hunt, Voice Mail group pilot numbers) -- User programmable.
- **Speed Dial** -- Automatically dials Speed number (System, Station, Saved Number Redial, Last Number Redial) (User programmable).
- **Pooled Group Access** -- Some or all outside lines can be grouped; pressing this button accesses the highest numbered unused CO line in that group (User programmable).
- **Loop** -- Used to answer a transferred call on a line for which a user does not have a button assigned (User programmable).
- **Unassign** (Locked-Out) -- Specific buttons may be designated as unused or locked out. When a button is programmed as unused, the button may not be programmed by the station user using flexible button programming procedures.
- **Flexible Station Assignments** -- Allows assignment of stations and complete flexibility within the system numbering plan. A station can be assigned a number between 100-8999.

The Digital Telephone has 24 flexible buttons that can be programmed.

#### 24-BUTTON DEFAULT

|                     |                   |                   |                      |
|---------------------|-------------------|-------------------|----------------------|
| STA 100<br>* 1 Q    | STA 101<br>* 2 W  | STA 102<br>* 3 E  | STA 103<br>* 4 R     |
| STA 104<br>* 5 T    | STA 105<br>* 6 Y  | STA 106<br>* 7 U  | STA 107<br>* 8 I     |
| STA 108<br>* 9 O    | STA 109<br>* 10 P | STA 110<br>* 11 A | STA 111<br>* 12 S    |
| CO 1<br>* 13 D      | CO 2<br>* 14 F    | CO 3<br>* 15 G    | CO 4<br>* 16 H       |
| CO 5<br>* 17 J      | CO 6<br>* 18 K    | LOOP<br>* 19 L    | POOL<br>* 20 :       |
| CALL BACK<br>* 21 Z | PICKUP<br>* 22 X  | DND<br>* 23 C     | LINE QUEUE<br>* 24 V |

Use Flash 50 programming when you want to modify a range of stations' attributes using **fixed** station numbers.

Use Flash 51 programming to modify a single station's attributes using a **flexible** station number.

#### Programming Steps

1. Press **FLASH** and dial **[50]** or dial **[51]**. Flexible button #24 (New Range) is lit and one of the following messages displays:

##### Flash 50 - Fixed Numbers

STATION ATTRIBUTES  
SELECT A STATION RANGE

##### Flash 51 - Flexible Numbers

ENTER STATION NUMBER

2. Enter the range of **fixed** station numbers (100-149) to be programmed. If only one station is being programmed, enter that number twice, e.g., [100 100].

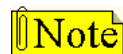

If **HOLD** is pressed without entering a station range, all stations are selected.

-or-

Enter a valid **flexible** number (100-8999) to be programmed.

3. Press HOLD to save the entry. A confirmation tone sounds and the display updates. Flexible button #19 is lit. The display updates to reflect current programming for Page A:

**Flash 50 - Fixed Numbers**

```
XXX - XXX PAGE A
ENTER BUTTON NUMBER
```

*XXX-XXX = fixed station range*

**Flash 51 - Flexible Numbers**

```
SXXX PAGE A
ENTER BUTTON NUMBER
```

*XXX = 3- or 4-digit flexible number*

4. Press button #20. The display updates to reflect current programming for Page B.

**Flash 50 - Fixed Numbers**

```
XXX - XXX PAGE B
ENTER BUTTON NUMBER
```

*XXX-XXX = fixed station range*

**Flash 51 - Flexible Numbers**

```
SXXX PAGE B
ENTER BUTTON NUMBER
```

*XXX = 3- or 4-digit flexible number*

5. Press the BUTTON ASSIGN flexible button (**Button #11**). The following message displays:

```
FLEX BUTTON PROG
ENTER BUTTON DATA
```

6. Enter a valid button number [01-24] to program, the desired function code (0-4 or #) plus any related information (e.g., CO line number if assigning a CO Line button), and then press HOLD.

**Function Codes**

*[0] = Flexible/user changeable*

*[1] = CO line*

*[2] = Loop button/all-purpose CO appearance*

*[3] = Pool for specific groups*

*[4] = Direct feature programmable*

*[#] = Locks button*

**To assign a Flexible Button (user programmable):**

Enter [BB], [0], [HOLD]

*BB = Desired Flexible Button Number*

When a button is assigned as a flexible button [0], the user can program any features or functions to which they have access on the buttons.

**To assign a CO Line Button:**

Enter [BB], [1], [LLL], [HOLD]

*BB = Desired Flexible Button Number*

*LLL = CO Line Number*

Buttons assigned as specific CO lines provide direct access and appearance of the CO line at a station. The station receives call status indications such as LED flash rates for incoming ringing when the line is placed on HOLD, etc. CO Line ringing is programmed in CO Line Attribute programming.

**To assign a Loop Button:**

Enter [BB], [2], [HOLD]

*BB = Desired Flexible Button Number*

Used for a station without direct CO line appearance to answer the line ringing in or transferred to the station. It is recommended that all stations be given a loop button so they can receive a transferred call on a line for which they have no button access.

**To assign a Pool Group Button:**

Enter [BB], [3], [GG], [HOLD]

*BB = Desired Flexible Button Number*

*GG = Line Group Number (00-23)*

Some or all outside CO lines may be grouped together and accessed via a POOL button for the purpose of placing an outgoing CO call. Pressing this button accesses the highest numbered unused CO line in that CO line group.

**To assign a function to a Flexible Button (admin programmable):**

Enter [BB], [4], [XXX], [HOLD]

*BB = Desired Flexible Button Number*

*XXX = Desired Flexible Feature Code*

Refer to *"Default Numbering Plan" on page F-16* for a listing of flexible feature codes.

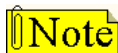

*The [XXX] entry implies that you add any additional information required for the function as described in the Default Numbering Plan. For example, to assign a speed dialing function to a button, you enter the feature code 668 followed by the speed bin number.*

**To unassign (lock out) a button:**

Enter [BB], [#], [HOLD]

*BB = Desired Flexible Button Number*



SINGLE LINE TELEPHONE

To assign an Off-Hook Preference function for an SLT:

After completing the first five steps of Flash 50/51, Page B, Button #11 programming described earlier in this section, continue programming using one of the following options.

**To assign a CO Line access function:**

Enter [01], [1], [LLL], [HOLD]

*LLL = CO Line Number*

**To assign a CO Line Group access function:**

Enter: [01], [3], [GG], [HOLD]

GG = Line Group Number (00-23)

**To assign other functions:**

Enter [01], [4], [XXX], [HOLD]

XXX = Desired Flexible Feature Code



Possible functions to assign for SLT Off-Hook Preference include: CO Line access, CO Line Group access, LCR, call to a station, call to a Hunt Group, call to a UCD Group, Call to Voice Mail.

**Operation****To program a user-programmable Flexible Button:**

1. Press the SPEED button twice.
2. Press the desired button to program (it must be programmed in the database as a multifunction button).
3. Dial the desired feature code. Refer to ["Default Numbering Plan" on page F-16](#).

**To erase a user programmable Flexible Button:**

1. Press the SPEED button twice.
2. Press the button to erase.
3. Press the FLASH button. Confirmation tone sounds.
4. Replace handset or press ON/OFF button.

**Conditions**

- » Only one station at a time can be programmed when using a flexible station number.
- » When in Flash 51 programming, if you press HOLD without specifying a flexible number to be programmed, you will get the station that is in port/station 100.

## Display Flexible Buttons

### Description

Each time the DISPLAY BUTTONS flexible button is subsequently pressed, the next five buttons display starting with the lowest button number.

- When a button is assigned as flexible button [0], the user can program any features or functions on the buttons to which they have access.
- When the buttons are programmed with user programmed functions, the display shows the function assigned to the button.

Use Flash 50 programming when you want to modify a range of stations' attributes using **fixed** station numbers.

Use Flash 51 programming to modify a single station's attributes using a **flexible** station number.

### Programming Steps

1. Press **FLASH** and dial **[50]** or dial **[51]**. Flexible button #24 (New Range) is lit and one of the following messages displays:

#### Flash 50 - Fixed Numbers

STATION ATTRIBUTES  
SELECT A STATION RANGE

#### Flash 51 - Flexible Numbers

ENTER STATION NUMBER

2. Enter the range of **fixed** station numbers (100-149) to be programmed. If only one station is being programmed, enter that number twice, e.g., [100 100].

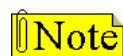

*If HOLD is pressed without entering a station range, all stations are selected.*

-OR-

Enter a valid **flexible** number (100-8999) to be programmed.

3. Press HOLD to save the entry. A confirmation tone sounds and the display updates. Flexible button #19 is lit. The display updates to reflect current programming for Page A:

#### Flash 50 - Fixed Numbers

XXX - XXX PAGE A  
ENTER BUTTON NUMBER

*XXX-XXX = fixed station range*

#### Flash 51 - Flexible Numbers

SXXX PAGE A  
ENTER BUTTON NUMBER

*XXX = 3- or 4-digit flexible number*



- Press button #20. The display updates to reflect current programming for Page B.

**Flash 50 - Fixed Numbers**

|   |
|---|
| XXX - XXX PAGE B<br>ENTER BUTTON NUMBER |
|---|

*XXX-XXX = fixed station range*

**Flash 51 - Flexible Numbers**

|                                    |
|------------------------------------|
| SXXX PAGE B<br>ENTER BUTTON NUMBER |
|------------------------------------|

*XXX = 3- or 4-digit flexible number*

- Press the DISPLAY BUTTONS flexible button (**Button #14**) to display programming assignments. The following message displays:

|         |         |         |
|---------|---------|---------|
| BUTTONS | BBS0100 | BBS0101 |
| BBS0102 | BBS0103 | BBS0104 |

*BB = Button Number*

*LCD above is an example. Refer to the following table for additional legend information.*

**Operation****To check flexible button programming at the keyset:**

- Lift handset.
- Press SPEED, then dial [7] + [#].
- Dial [2] to select the KEYBTN option.
- Press the desired flexible button(s) to display programming for the button(s) on the LCD.
- When finished, replace the handset.

## Features and Operation

| <b>Flex Button</b> | <b>Designation</b>                       | <b>Flex Button</b> | <b>Designation</b>                 |
|--------------------|--|--------------------|------------------------------------|
| ACALM              | Attendant Clear Alarm                    | MRVM               | Voice Mail Mailbox (Remote)        |
| ACCT               | Account Code Enter                       | MSG                | Message Wait Key                   |
| AMEM               | Agent Member Display                     | MUSIC              | Background Music                   |
| ANS                | Answering Mach. Emulation Mode           | MUTE               | Mute Key                           |
| AOVR               | Attendant Override                       | MVM[B]             | Voice Mail Mailbox 1-8             |
| APAGE              | All Call Page                            | M[ZZ]              | Personalized Message w/ Msg Nbr    |
| AUNA               | Attendant DND                            | NTS                | Night Service                      |
| AUTOR              | Auto Redial                              | ODND               | UCD Overflow Station Avail/Unavail |
| AVL                | UCD Avail/Unavail                        | OFW                | Offnet Forward                     |
| B[9BBB]            | Speed Dial Button with Bin Number        | OHP                | Off-Hook Preference                |
| C[XXXX]            | Call Coverage (w/o ringing)              | OHVO               | Off-Hook Voice Over                |
| CAMP               | Camp-On                                  | PARK[CCCC]         | Call Park with Park Location       |
| CBAK               | Call Back                                | PKUP               | Pickup                             |
| CID                | Caller ID Name/Number Toggle             | PL[GG]             | Pool with CO Line Group Number     |
| CIQ                | UCD Calls in Queue                       | PPARK              | Personal Park                      |
| CLCRQ              | Cancel LCR Queue                         | REL                | Release Key                        |
| CONF               | Conference Key                           | RPARK              | Station Call Park                  |
| CSM                | Custom Message                           | SLGIN              | Supervisor Login                   |
| D[XXXX]            | Call Coverage (with ringing)             | SLOUT              | Supervisor Logout                  |
| DIALN              | Dial By Name                             | SNR                | Save Number Redial                 |
| DISCO              | Disable CO Line Outbound                 | SPD                | Speed Directory Dial               |
| DND                | Do Not Disturb                           | SPEED              | Speed Key                          |
| DRG                | Distinctive Ringing                      | STRC               | Stop Internal Trace                |
| E911               | E911 List                                | STS                | Supervisor Status Display          |
| EAC                | External All Call                        | S[XXXX]            | Station DSS / BLF                  |
| EOR                | Executive Override                       | U[UUUU]            | UCD Group with Pilot Number        |
| EP[N]              | External Page with Zone                  | UNA                | Universal Answer                   |
| FFW                | Incoming Transfer CO Line                | VMREC              | VM Record (One Touch Record)       |
| FLASH              | Flash Key                                | VOL                | Gain Key                           |
| FWD                | Call Forward Key                         | V[VVVV]            | VM Group with Pilot Number         |
| GPU                | Group Pickup                             | XFER               | Transfer Key                       |
| H[HHHH]            | Hunt Group with Pilot Number             |                    |                                    |
| HFREE              | Headset Mode                             |                    |                                    |
| HOLD               | Hold Key                                 |                    |                                    |
| HPT                | Handsfree/Private/Tone toggle btn/switch |                    |                                    |
| IAC                | Internal All Call Page                   |                    |                                    |
| IANS               | ICLID Answered Call                      |                    |                                    |
| ICM                | Intercom                                 |                    |                                    |
| IP[N]              | Internal Page with Zone                  |                    |                                    |
| IUANS              | Display ICLID Unanswered Calls           |                    |                                    |
| LCR                | LCR Access                               |                    |                                    |
| LINEQ              | CO Line Queue Key                        |                    |                                    |
| L[LLL]             | CO Line Button (CO Line [LLL])           |                    |                                    |
| LOOP               | Loop                                     |                    |                                    |
| LNR                | Last Number Redial                       |                    |                                    |
| MMP                | Meet Me Page                             |                    |                                    |
| MON                | Monitor Key                              |                    |                                    |

----- LEGEND -----

[B] Mailbox Number  
 [9BBB] Speed Dial Bin Number  
 [CCCC] Call Park Location  
 [GG] Pool or CO Line Group Number  
 [HHHH] Hunt Group Flexible Number  
 [LLL] CO Line Number  
 [N] Page Zone Number  
 [UUUU] UCD Group Pilot Number  
 [VVVV] Voice Mail Group Flexible Number  
 [XXXX] Flexible Station Number  
 [ZZ] Personalized Message Number

**Conditions**

- » Only one station at a time can be programmed when using a flexible station number.
- » When in Flash 51 programming, if you press HOLD without specifying a flexible number to be programmed, you will get the station that is in port/station 100.

## Flexible Numbering

### Description

The Flexible Numbering feature allows the system numbering plan to be modified from its default value (refer to *"Default Numbering Plan" on page F-16*) to accommodate specific customer requirements. Station, Pilot, and Feature Access Code numbers may be changed with this feature. The length of these numbers may also be modified to meet specific customer applications.

### Programming Steps

Press **FLASH** and dial **[52]**. The following message displays:

|                   |           |
|-------------------|-----------|
| FIX: 100          | FLEX: 100 |
| NAME: STATION 100 |           |

#### To select a Fixed or Flexible Code:

1. Press Button 24 (Fixed) or Button 21 (Flexible).
2. Enter the desired code to change.
3. Press HOLD. The fixed and flexible number, as well as a description of the code, displays on the LCD.

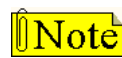

You can scroll through the codes by using the **PREVIOUS** button (23) or the **NEXT** button (22).

#### To change a Flexible Code:

1. Select the desired code.
2. Press Button 1. The red LED illuminates.
3. Delete the flexible number by pressing button 2 and then pressing HOLD. The flexible number field will be blank.
4. Enter the new code (2-4 digits).
5. Press HOLD.



Station/Pilot numbers can only contain 0-9.  
Feature codes can contain 0-9, \*, #.

#### To erase a Flexible Code:

1. Select the desired code.
2. Press Button 1 (must be lit).
3. Press Button 2.
4. Press HOLD.

### Conditions

- » Feature access codes cannot conflict with station numbering.
- » CO line numbers are fixed and cannot be changed.

*Features and Operation*

- » If no VM ID digits are programmed in the station field, the flexible number assigned to the station will be sent to the VM unit.
- » Flash 06, Button #15 is the programming area to automatically assign the VMID digits to be the same as the flexible station numbering.
- » The SMDR will output 4-digit numbers in the station field. If less than 4 digits is selected in the numbering plan, leading spaces will be added in place of the numbers. The 3-4 digit SMDR programming area will be removed from programming.
- » The programming will print out as part of the CO-STA port programming area. The flexible numbering can be initialized in the CO-STA initialization area.

*Station Port Inquiry***Description**

When using flexible numbering, some programming steps require the fixed code. This feature allows you to dial a feature code to reveal the fixed port for your station.

**Operation**

Dial feature code [611]. The fixed Station/Port Number for your station displays.

|                      |
|----------------------|
| STATION PORT:<br>XXX |
|----------------------|

---

**Group Listening****Description**

All digital key stations have a built-in speakerphone. Station users may use the speaker to monitor a call while using the handset to converse with the outside party. This enables other people in the room to listen to both parties in the conversation.

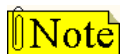

*This feature is not available when the station is in headset mode.*

**Programming Steps**

1. Press the GROUP LISTENING flexible button (**FLASH 05, Button #9**).
2. Enter a 0 or 1 that corresponds with the following entries:
  - [0] = Disabled
  - [1] = Enabled

|                 |     |
|-----------------|-----|
| GROUP LISTENING | 0-1 |
| DISABLED        |     |

3. Press HOLD to save the entry. A confirmation tone sounds.

DEFAULT ... Group Listening is disabled.

## Operation

### **To activate Group Listening while conversing on the handset:**

Press the ON/OFF button. Both parties can then be heard on the digital station's speaker. The speakerphone microphone is muted while the handset is off-hook.

### **To deactivate Group Listening while off-hook:**

Press the ON/OFF button.

## Conditions

- » While using the speakerphone, lifting the handset turns off the speakerphone. To activate group listening, press the ON/OFF button (to ON) while the handset is off-hook.
- » While in group listening mode, pressing the MUTE button causes the transmit from the handset to be muted (the speakerphone microphone is already muted). However, the distant end is still heard over the handset receiver and the station speaker.
- » If full speakerphone operation is desired while in group listening mode, simply set the handset on-hook.
- » Group listening is unavailable when the station is in headset mode.
- » When placing the handset on-hook to full speakerphone operation, it is normal to hear a squeal caused by audio feedback. To eliminate this noise, press MUTE prior to initiating speakerphone operation.
- » Must be enabled in System Features Programming.

---

## Headset Mode

### Description

Each digital telephone can be individually programmed for headset operation. When programmed, an industry-standard, electret-mic-compatible, modular headset with its adapter box may be connected to a digital telephone for headset use. This allows handset or headset operation by switching the selector switch on the adapter box. Speakerphone operation and call announce on intercom are disabled while a station has enabled headset mode.

Once programmed in station programming (Flash 50/51, Page B, Buttons #4 and #18), the user may then select between headset mode or normal handset/speakerphone mode by simply dialing a code, pressing a user programmable flexible button, or using the Soft Key's Headset option.

### Related Information

| Quick Reference |        |           |   |
|-----------------|--------|-----------|---|
| ➡ Flash 50      | Page B | Button #4 | The Speakerphone function MUST be disabled for use of the headset (refer to option 2 in <i>"Speakerphone Options"</i> on page 2-272). |

## Programming Steps

1. Press **FLASH** and dial **[50]** or dial **[51]**. Flexible button #24 (New Range) is lit and one of the following messages displays:

### Flash 50 - Fixed Numbers

STATION ATTRIBUTES  
SELECT A STATION RANGE

### Flash 51 - Flexible Numbers

ENTER STATION NUMBER

2. Enter the range of **fixed** station numbers (100-149) to be programmed. If only one station is being programmed, enter that number twice, e.g., [100 100].



If **HOLD** is pressed without entering a station range, all stations are selected.

-or-

Enter a valid **flexible** number (100-8999) to be programmed.

3. Press **HOLD** to save the entry. A confirmation tone sounds and the display updates. Flexible button #19 is lit. The display updates to reflect current programming for Page A:

### Flash 50 - Fixed Numbers

XXX - XXX PAGE A  
ENTER BUTTON NUMBER

*XXX-XXX = fixed station range*

### Flash 51 - Flexible Numbers

SXXX PAGE A  
ENTER BUTTON NUMBER

*XXX = 3- or 4-digit flexible number*

4. Press button #20. The display updates to reflect current programming for Page B.

### Flash 50 - Fixed Numbers

XXX - XXX PAGE B  
ENTER BUTTON NUMBER

*XXX-XXX = fixed station range*

### Flash 51 - Flexible Numbers

SXXX PAGE B  
ENTER BUTTON NUMBER

*XXX = 3- or 4-digit flexible number*

5. Press the **DISPLAY BUTTONS** flexible button (**Button #18**) to display programming assignments. The following message displays:

|              |     |
|--------------|-----|
| HEADSET MODE | 0-1 |
| 2.5 MM JACK  |     |

6. Dial a valid option number (0 or 1) to identify the location where you plug the headset into the *STSe* keyset.

*0 = plugged into the jack normally used for the handset*

*1 = plugged into the 2.5 mm jack located on the left side of the keyset*

7. Press HOLD to save the entry. A confirmation tone sounds.

DEFAULT ... Option 1, the 2.5 mm jack, is the default setting.

### Operation

The user connects the modular headset to either the handset jack on the telephone (leaving the handset in place) or the 2.5 mm jack located on the left side of the keyset. The ON/OFF button on the Digital Telephone is used to initiate and end calls while using the headset.

#### **To activate Headset Mode:**

Dial [634] on the dial pad,

-or-

Press preprogrammed HEADSET MODE button.

-or-

Use the Soft Key's HEADSET option when in an idle condition.



*While Headset mode is active, the ON/OFF button activates the headset and disables speakerphone and intercom call announce operation at your station. To install the headset, see the Installation Manual.*

#### **To deactivate Headset Mode:**

Dial [634] on the dial pad,

-or-

Use the Soft Key's HEADSET option.

-or-

Press the preprogrammed HEADSET MODE button.

LED extinguishes.



*Station must be programmed for headset operation in database programming before the flexible button can be programmed.*



#### **SINGLE LINE TELEPHONE**

Not applicable

### Conditions

- » The Headset Mode flexible feature code 634 can be programmed onto a flexible button. The button acts as a toggle (i.e., the first depression turns Headset Mode on, the second depression turns Headset Mode off.
- » Transmission and reception quality when using the headset is dependent upon the headset used.
- » Intercom calls to a station in Headset Mode will always be presented to the station in the Tone Mode.
- » If the 2.5 mm jack is used for the headset connection, a user may alternate between the handset and the headset during a conversation by either lifting the handset or by pressing [ON/OFF] and then replacing the handset to return to headset operation.
- » Page announcements will be presented to the keyset speaker when the station is idle.

---

## Hold - Exclusive

### Description

When a line is placed on Exclusive Hold, no other station in the system can retrieve the call.

### Operation

Exclusive Hold may be programmed and activated on the first or second depression of the HOLD button. CO Lines, while in a transfer hold, are always placed in an Exclusive Hold condition.



SINGLE LINE TELEPHONE

#### **While connected to an outside line, to place a call on Exclusive Hold:**

Press the FLASH button. Handset must stay off-hook.

#### **To retrieve the call:**

Press the FLASH button again.

### *Exclusive Hold Flash Rate*

#### Description

The Exclusive Hold flash rate is the rate at which a CO Line button or Loop button flashes when a call is placed on Exclusive Hold. This flash rate can be programmed to 29 different options identified in the flash rate table. This enables the programmer to customize the key system configuration to desired flash rates.

#### Programming Steps

1. Press the EXCLUSIVE HOLD flexible button (**FLASH 07, Button #12**). The following message displays:

|                     |       |
|---------------------|-------|
| EXCLUSIVE HOLD      | 00-28 |
| GREEN 120 IPM FLASH |       |

2. Enter a valid number (00-28) on the dial pad to correspond to one of the 29 available options (refer to [Table 2-16 on page 2-163](#)).
3. Press HOLD to save the entry. A confirmation tone sounds and the display updates.

DEFAULT ... Exclusive Hold flash rate is set for a Green 120 ipm Flash (24).



## *Exclusive Hold Recall Timer*

### **Description**

The System Hold Recall Timer determines the time before a call placed on Exclusive Hold recalls the station placing the Hold. If unanswered by that station, the call recalls the Attendant.

The Exclusive Hold Recall Timer setting is variable from 000-300 seconds. An entry of 000 disables the timer and there is no recall.

### **Programming Steps**

1. Press the EXCLUSIVE HOLD RECALL TIMER flexible button (**FLASH 01, Button #2**). The following message displays:

|                 |         |
|-----------------|---------|
| EXC HOLD RECALL | 000-300 |
| 180             |         |

2. Enter a valid number on the dial pad that corresponds to 000-300 seconds.
3. Press HOLD to save the entry. A confirmation tone sounds and the display updates.

DEFAULT ... Exclusive Hold Recall Timer is set for 180 seconds.

---

## **Hold - Preference**

### **Description**

The Hold Preference feature allows either System or Exclusive hold as the primary hold on the first depression of the HOLD button, depending upon programming. A second depression invokes the second hold preference.

### **Programming Steps**

1. Press the HOLD PREF flexible button (**FLASH 05, Button #2**).
2. Enter a valid number (0 or 1) that corresponds with the following entries:

[0] = Exclusive Hold

[1] = System Hold

|                 |     |
|-----------------|-----|
| HOLD PREFERENCE | 0-1 |
| SYSTEM          |     |

3. Press HOLD to save the entry. A confirmation tone sounds.

DEFAULT ... Hold Preference is System Hold.

---

## Hold - System

When a line is placed on System Hold, any station in the system with an appearance of that line can retrieve the call.

### *System Hold Flash Rate*

#### **Description**

The System Hold flash rate is the rate at which a CO Line button or Loop button flashes when a call is placed on System Hold. This flash rate can be programmed to 29 different options identified in the flash rate table. This enables the programmer to customize the key system configuration to desired flash rates.

#### **Programming Steps**

1. Press the SYSTEM HOLD flexible button (**FLASH 07, Button #13**). The following displays:

|                     |       |
|---------------------|-------|
| SYSTEM HOLD         | 00-28 |
| RED 60 IPM DBL WINK |       |

2. Enter a valid number (00-28) on the dial pad to correspond to one of the 29 available options (refer to [Table 2-16 on page 2-163](#)).
3. Press HOLD to save the entry. A confirmation tone sounds and the display updates.

DEFAULT ... System Hold flash rate is set for a Red 60 ipm Double Wink (04).

### *System Hold Recall Timer*

#### **Description**

The System Hold Recall Timer determines the time before a call placed on System Hold recalls the station placing the hold. If unanswered by that station, the call recalls the Attendant.

The System Hold Recall Timer setting is variable from 000-300 seconds. An entry of 000 disables the timer and there is no recall.

#### **Programming Steps**

1. Press the SYSTEM HOLD RECALL TIMER flexible button (**FLASH 01, Button #1**). The following message displays:

|                    |         |
|--------------------|---------|
| SYSTEM HOLD RECALL | 000-300 |
| 060                |         |

2. Enter a valid number on the dial pad that corresponds to 000-300 seconds.
3. Press HOLD to save the entry. A confirmation tone sounds and the display updates.

DEFAULT ... System Hold Recall Timer is set for 60 seconds.

---

## Hot Keypad

### Description

The Hot Keypad feature enables a station user to activate the telephone by dialing digits or pressing telephone buttons without going off hook.

---

## Hot Line / Ring Down

### Description

Stations may be programmed to immediately call or ring down a particular station or outside number upon going off hook. This is done by programming the stations Off-Hook preference to activate a DSS or Speed dial feature key (refer to [“Ring Down / Hot Line / Off-Hook Preference” on page 2-263](#)). This feature can be overridden if the station user selects a CO line first when going off-hook.

---

## Hunt Groups

### Description

The system can be programmed for up to 12 Hunt Groups, 4 of which are only for RAN applications in UCD. Each Hunt Group can contain up to 24 stations each. Each Hunt Group can be independently arranged to use a pilot hunting or station hunting technique. If a station is in DND or is forwarded in any manner, it is considered busy.

### Programming Steps

1. Press **FLASH** and dial **[30]**. The following message displays:

|                               |                  |
|-------------------------------|------------------|
| HXXXX                         | ####, ####, #### |
| ####, ####, ####, ####, ####, |                  |

- The top left button in the flexible button field is lit for programming Hunt Group 1 (XXXX = flexible hunt group number).
2. To change Hunt Groups or enter a different Hunt Group, press the appropriate flexible button 1-8. Hunt Groups 458-461 are only used for RAN applications in UCD (refer to [Chapter 4, Uniform Call Distribution](#)).
  3. Enter a valid 3- or 4-digit flexible station number, or flexible station numbers up to eight stations per group, followed by a “1” to add or a “0” to delete. Hunt groups are joined or chained together by entering another Hunt Group Pilot Number as the last entry of the group.
  4. Press HOLD to save the entry. A confirmation tone sounds and the display updates.

## Station / Pilot / Pilot All Ring -- Hunting Assignments

### Description

**Pilot Hunting** -- Incoming CO, transferred CO, and intercom calls can be directed to a pilot number of a hunt group. The system searches sequentially (in the order the extensions were entered in the database programming) for an idle station in the group and rings that station. Calls directly to stations (by calling the extension number) within the hunt group do not hunt but receive call progress tones from the extension.

**Pilot All Ring Hunting** -- rings all idle stations in a particular Hunt group at one time.

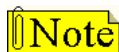

**"All Ring"** hunt groups cannot be chained together.

**Station (Circular) Hunting** -- Transferred CO, and intercom calls that are presented to a busy, or DND station, that are members of a Station Hunt Group, search sequentially (in the order the extensions were entered in database programming) for an idle station in the group and rings that station. Direct ringing CO Line calls to the station number ring at the station. If station hunting is desired on a direct ringing call, program the station hunting pilot number in the CO Line ring assignment list. This lets the member of the hunt group to receive private/hunt group calls.

### Programming Steps

1. Press **FLASH** and dial **[30]**.
2. Press the flexible button (1-8) representing the group to be assigned a new hunting assignment.
3. Press the STATION/PILOT flexible button (**FLASH 30, Button #13**) to indicate Pilot, Pilot All Ring Hunting, or Station Hunting.

|                |     |
|----------------|-----|
| HXXXX          | 0-2 |
| PILOT RING ONE |     |

4. Dial a valid number (0-2):
  - [0] = Pilot (Default; shown on LCD as PILOT RING ONE)
  - [1] = Pilot All Ring Hunting (shown on LCD as PILOT RING ALL)
  - [2] = Station Hunting (shown on LCD as CIRCULAR HUNT)

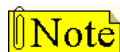

**Fixed Hunt Group numbers 458-461 are ONLY for RAN applications.**

5. Press HOLD to save the entry. A confirmation tone sounds and the display updates.

## *Overflow*

### **Description**

After assigning a hunt assignment for a group, an overflow destination can be established. If all stations within the group are busy and another CO line call is placed to the group or a CO line call is transferred to the group, the call will be forwarded to the overflow destination. The overflow call can be transferred immediately or can be retained in a queue (for answering by a group member that becomes available) until the Overflow Timer setting expires and then it transfers.

### **Programming Steps**

Prior to using the following procedures, ensure that you first select the desired hunt group by pressing the appropriate button (1-8).

#### ***To establish an overflow destination:***

1. Press the desired Button #14 - #17 to choose the type of destination for overflow forwarding.
  - 14 = Overflow Destination - Day
  - 15 = Overflow Destination - Night
  - 16 = Overflow Destination - Special
  - 17 = Overflow Destination - VMID
2. Enter the destination number.
3. Press HOLD to save the entry. A confirmation tone sounds and the display updates.

#### ***To enable/disable queuing:***

1. Press Button #19 to access the Queue options.
2. Dial a valid number (0-1):
  - [0] = Disable (calls overflow immediately)
  - [1] = Enable (calls go in queue and overflow when the Overflow Timer setting expires)
3. Press HOLD to save the entry. A confirmation tone sounds and the display updates.  
 DEFAULT ... Queue is set to (0) Disable.

#### ***To set the Overflow Timer:***

1. Press Button #18.
2. Enter the desired delay time (00-99 seconds) to establish the amount of time the call will remain in queue before it transfers to the overflow destination. An entry of 00 will disable the Overflow feature.
3. Press HOLD to save the entry. A confirmation tone sounds and the display updates.  
 DEFAULT ... Overflow Timer is set to (10) seconds.

## Initialize Hunt Group Parameters

### Description

Hunt Group Parameters may be initialized setting all data fields to their original, default value.

**Table 2-17: Hunt Group Defaults**

| Program Code | Flexible Button | Features                         | Default Value (after initialization) |
|--------------|-----------------|----------------------------------|--------------------------------------|
| FLASH 30     | HUNT GROUPS     |                                  |                                      |
|              | 1-12            | Hunt Group Programming           | None                                 |
|              | 13              | Station/Pilot Hunting Assignment | Pilot                                |
|              | 14              | Overflow Destination - Day       | None                                 |
|              | 15              | Overflow Destination - Night     | None                                 |
|              | 16              | Overflow Destination - Special   | None                                 |
|              | 17              | Overflow Destination - VMID      | None                                 |
|              | 18              | Overflow Timer                   | 10 sec                               |
|              | 19              | Queue                            | Disabled                             |

### Programming Steps

1. Press the HUNT GROUPS flexible button (**FLASH 80, Button #10**). The following message displays:

|   |
|---|
| <p>INITIALIZE HUNT GROUP<br/>PRESS HOLD</p> |
|---|

2. Press the HOLD button. A confirmation tone sounds.

## Print Hunt Group Parameters

### Description

The Print Hunt Group command dumps the entire database as a permanent record which can serve as a hardcopy of the database. The system baud rate must match that of the printer or receiving device.

| HUNT GROUPS |                | RAN HUNT GROUPS |                |
|-------------|----------------|-----------------|----------------|
| HG 0..450   | PILOT RING ONE | HG 8..458       | PILOT RING ONE |
| HG 1..451   | PILOT RING ONE | HG 9..459       | PILOT RING ONE |
| HG 2..452   | PILOT RING ONE | HG10..460       | PILOT RING ONE |
| HG 3..453   | PILOT RING ONE | HG11..461       | PILOT RING ONE |
| HG 4..454   | PILOT RING ONE |                 |                |
| HG 5..455   | PILOT RING ONE |                 |                |
| HG 6..456   | PILOT RING ONE |                 |                |
| HG 7..457   | PILOT RING ONE |                 |                |

**Figure 2-11: Hunt Group Parameters Printout**

### Programming Steps

1. Press the HUNT GROUPS flexible button (**FLASH 85, Button #11**). The following message displays:

PRINT HUNT GROUP  
PRESS HOLD

2. To print data for Hunt Group Parameters, press the HOLD button. The following message displays:

PRINTING HUNT GROUP

When the system finishes sending the requested information to the printer, a confirmation tone sounds.

## Idle Speaker Mode

### Description

The Idle Speaker Mode feature allows you to select whether the first digit dialed is audible over the digital telephone speaker. This feature is allowed or denied on a system-wide basis in programming.



When this feature is enabled, there can be some idle speaker noise.

### Programming Steps

1. Press the IDLE SPEAKER MODE flexible button (**FLASH 05, Button #10**).
2. Enter a 0 or 1 that corresponds with the following entries:  
     [0] = First digit dialed is audible (Disabled)  
     [1] = First digit dialed is Muted (Enabled)

|                   |     |
|-------------------|-----|
| IDLE SPEAKER MODE | 0-1 |
| DISABLED          |     |

3. Press HOLD to save the entry. A confirmation tone sounds.  
 DEFAULT ... Idle Speaker Mode is disabled.

---

## In and Out Button

### Description

An In and Out Button will toggle a station from an in status to an out status and from an out status to an in status. When in an out status, the LCD will display "OUT MODE" and all incoming calls will forward to the Preset Internal Busy Forward destination (Flash 50/51, Page C, Button #2). If no forwarding destination is programmed in Flash 50/51, the call will be presented without forwarding.

### Programming Steps

1. Press the IN AND OUT BTN flexible button (**FLASH 07, Button #22**). The following message displays:

|                   |       |
|-------------------|-------|
| IN AND OUT BTN    | 00-28 |
| RED 120 IPM FLASH |       |

2. Enter a valid number (00-28) on the dial pad to correspond to one of the 29 available options (refer to [Table 2-16 on page 2-163](#)).
3. Press HOLD to save the entry. A confirmation tone sounds and the display updates.  
 DEFAULT ... In and Out button flash rate is set for a Red 120 ipm Flash (10).

### Operation

Press the preprogrammed In and Out Button (feature code 644).

### Conditions

- » Attendant stations and SLT stations do not have the In and Out feature capability.



---

## Incoming Calling Line Identification

For information about Incoming Calling Line Identification (ICLID), refer to [Appendix A, "ICLID / Caller ID."](#)

---

## Intercom

### Description

The Intercom Button feature provides station users the function of ringing a busy station via the intercom without using the Camp On or Executive Override features. This also allows stations to place intercom calls on hold. If calls are ringing on intercom buttons and a Handsfree call is received, the Handsfree call is allowed and the calls ringing continue with muted ringing. Multiple intercom path buttons can be assigned to a single station, however up to five internal parties can be placed on hold per station. Music-On-Hold is provided to intercom callers on hold.

This feature can be programmed on any key station or DSS Console with an available flexible button. If there is an available intercom button, a station calling that station cannot OHVO, Camp On, or Override that station. Depending on the key station programming, intercom ringing is muted or reminder ringing.

If all intercom buttons are in use, then the station may utilize the Camp On or Executive Override features. By default, no intercom buttons are assigned to any key stations.

### Operation

#### **To program a Flexible Button as an Intercom Button:**

1. Press the SPEED button twice.
2. Press the desired flexible button to program.
3. Dial [645] on the dial pad. A confirmation tone sounds. If an error was made during entry, error tone sounds.

#### **When an intercom call rings a busy station (with intercom button):**

1. The calling station receives ringback tone instead of busy tone. The called station hears muted or reminder ring and their intercom button LED starts flashing at the incoming CO line rate. This indicates an incoming intercom call.
2. The called station can place the current CO call on hold by pressing the HOLD button,  
-or-  
Place the current intercom call on hold by pressing the HOLD button. The intercom call is placed on hold on the available intercom button.

3. The called station then presses the flashing intercom button to answer the incoming intercom call. Once the call is answered, the following message displays on the called station LCD:

|  |
|--|
| CALL FROM STA XXX<br>MMM DD YY                      HH:MM am |
|--|

Sta XXX can be a programmed station name.



SINGLE LINE TELEPHONE

Not applicable

### Conditions

- » If calls are ringing on intercom buttons and a Handsfree call is received, the Handsfree call is allowed and the calls ringing continue with muted ringing.
- » Multiple intercom path buttons can be assigned to a single station, however up to five internal parties can be placed on hold per station. Music-On-Hold is provided to the intercom caller on hold.
- » Once an intercom button is set up on the keyset, callers dialing that station always receive ringback tone as long as an available intercom button is idle. If all intercom buttons are in use, the station may use the Camp On or Executive Override features to reach the station. Internal callers are dropped after the Camp On is answered.
- » This feature can be programmed on any key station or DSS Console with an available flexible button. If there is an available intercom button, the following actions cannot be performed: Executive Override, OHVO, Camp On or Override.
- » A call ringing to a station on an intercom button rings muted or reminder ringing, depending on the stations tone ringing cadence.
- » Up to five internal parties can be placed on hold. No recall timers apply to Intercom buttons. Internal callers can be placed and removed from hold when they appear on an Intercom button.
- » To utilize the capability of intercom buttons, busy forward cannot be active at the station.
- » A call ringing to a station on an intercom button and the DND button is pressed, returns DND tone to the caller and the call is dropped.

## Intercom Calling

### Description

The system's architecture allows non-blocking of intercom calls. A station is reached on intercom by dialing the associated station number.

### Operation

#### **To place an Intercom Call:**

1. Press the DSS button of the party to be called (if programmed at your phone),  
-or-  
Dial the extension number.



*Dialing a number in the numbering plan activates the telephone automatically.*

(You hear ringing if the called station is in the T answering mode; or three bursts of tone if called station is in the H or P position.)

2. Lift handset or use the speakerphone after the tone bursts stop.
3. Hang up to end the call.

#### **To answer an Intercom Call:**

**In the T mode**, you hear repeated bursts of intercom tone ringing and the HOLD button slow flashes.

Lift the handset or press the ON/OFF button to answer,

-or-

Position the H-T-P switch to the H mode to reply.

**In the P mode**, you hear three bursts of tone and one-way announcement. The calling party cannot hear conversations in progress.

Lift the handset or press the ON/OFF button to answer,

-or-

Position the H-T-P switch to the H mode to reply.

**In the H mode**, you hear three bursts of tone and an announcement.

Reply handsfree or lift the handset for privacy.



SINGLE LINE TELEPHONE

#### **To place an intercom call:**

1. Lift the handset.
2. Dial the intercom number.  
You will hear ringing if the called station is in the "T" answering mode or two bursts of tone if the called station is in the "H" or "P" modes.
3. Hang up to end the call.

**To answer an intercom call:**

Lift the handset,

-or-

If your SLT is equipped with a speakerphone, press the Speaker button to converse in a handsfree mode.

*Incoming Intercom Ringing Flash Rate***Description**

The Incoming Intercom Ringing flash rate is the rate an Incoming DSS button flashes if you have a DSS appearance for the calling station. This flash rate can be programmed to 29 different options identified in the flash rate table. This enables the programmer to customize the key system configuration to desired flash rates.

**Programming Steps**

1. Press the INC ICM RING flexible button (**FLASH 07, Button #2**). The following message displays:

|                     |       |
|---------------------|-------|
| INC ICM RING        | 00-28 |
| RED 120 IPM FLUTTER |       |

2. Enter a valid number (00-28) on the dial pad to correspond to one of the 29 available options (refer to [Table 2-16 on page 2-163](#)).
3. Press HOLD to save the entry. A confirmation tone sounds and the display updates.

DEFAULT ... Incoming Intercom Ringing flash rate is set for Red 120 ipm Flutter (11).

*Intercom Signaling Select***Description**

Users can control the method by which they receive intercom calls and signals. A convenient HPT button is located on each digital telephone for easy selection. The choices are:

**Handsfree (H)** -- The station user, upon hearing a tone burst and voice announcement over the speaker, can reply handsfree.

**Privacy (P)** -- The station user receives a burst of tone and a voice announcement over their speaker. The microphone is deactivated for privacy. The called party must lift the handset or press the MUTE button to answer the call.

**Tone Ringing (T)** -- A standard tone ring notifies the party of an incoming intercom call. The called party answers by lifting the handset or moving the switch to the handsfree (H) position or pressing the ON/OFF button.

## *Intercom Transfer*

### **To use Intercom Transfer without DSS Buttons:**

1. Receive or make an intercom call.
2. Press the TRANS button. Intercom dial tone sounds.
3. Dial the station.
4. When the second station answers, you are in a supervised transfer mode (first station is staged for transfer).
5. Hang up (stations 1 and 2 are connected).

### **To use Intercom Transfer with DSS Buttons:**

1. Receive or make an intercom call using a DSS button.
2. Press the TRANS button. Intercom dial tone sounds.
3. Press the DSS button where to transfer the call.
4. Hang up (stations 1 and 2 are connected).

---

## **Inter-Digit Time-Out**

The Inter-Digit Time-Out feature allows programming of the inter-digit time-out on a system-wide basis. This feature applies to intercom calls. DISA inter-digit time-out remains unaffected by this timer. The Inter-Digit Time-out setting is variable from 1-99 seconds.

### **Programming Steps**

1. Press the INTER-DIGIT TIMEOUT flexible button (**FLASH 01, Button #20**). The following message displays:

|                  |       |
|------------------|-------|
| INTERDIGIT T / O | 01-99 |
| 05               |       |

2. Enter a valid number that corresponds to 01-99 seconds in 1-second increments.
3. Press HOLD to save the entry. A confirmation tone sounds and the display updates.

DEFAULT ... Inter-Digit Time-out is set for 5 seconds.

---

## ISDN

### **Description**

Current STSe software supports Primary Rate Interface (PRI) Integrated Services Digital Network (ISDN) circuits. The PRI provides 23 bearer channels and one data channel (23B+D).

Calling Number and Called Number services are supported with the PRI. Calling Number services will be routed in the same manner as ANI/ICLID calls using the ICLID route table and name/number translation table.

The rules and conditions of ANI/ICLID are the same, and still apply to Calling Number service on ISDN lines. Called Number services will be routed using the DID/DNIS route table. The rules and conditions of DID and DNIS are the same, and still apply to ISDN Called Number service on ISDN lines.

### **Channels**

- The bearer channels (B channels) transport voice information to and from the Central Office.
- The data channel (D channel) controls all signaling information for the bearer channels.

### **PRIB**

- The PRIB only supports the NI-2 standard.
- The PRIB does not support the trunk features of paging, reseize, queuing, or RAN support.
- Vodavi has successfully integrated its PRI ISDN with the Lucent 5 ESS, Siemens, Stromburg Carlson, and the DMS 100 Central Offices. Vodavi ISDN should interface with all Central Office switches, but this has not been verified. Therefore some delays in service may be experienced.

## Name/Number Display When Using PRI

### Description

This feature provides the capability to display the caller's name (up to 15 characters) when inbound calls are received using PRI.

The specific LCD display obtained is based upon the type of signaling used and other variables described in the examples and in the Conditions section for this feature.

When using DNIS or ANI signaling (FLASH 40, Page B, Button #1), if the Calling Party Number matches the Name/Number Translation Table, then the upper two LCD examples in either [Figure 2-13](#) or [Figure 2-14](#) applies. If the Calling Party Number does not match the Name/Number Translation Table, but does match the DID Translation Table, then the upper two LCD examples in either [Figure 2-15](#) or [Figure 2-16](#) applies.

Examples are based on this scenario:

- Incoming PRI call 614-6100 from an SLT with the telephone number of 480-991-8569 and the name of ABC Technology Co
- Incoming call (DID number - 3 digits)
- Name in DID Translation Table is George (FLASH 44)
- Name in Name/Number Translation Table is Vodavi Comm Systems (FLASH 55)

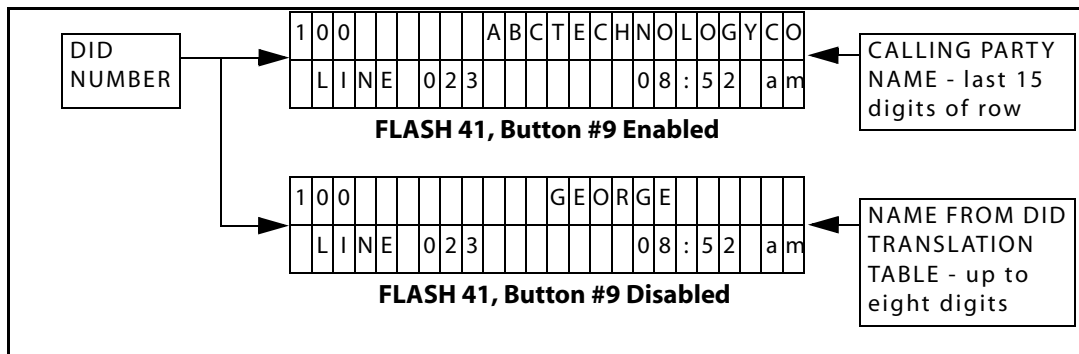

**Figure 2-12: Display Examples (Using DID Signaling)**

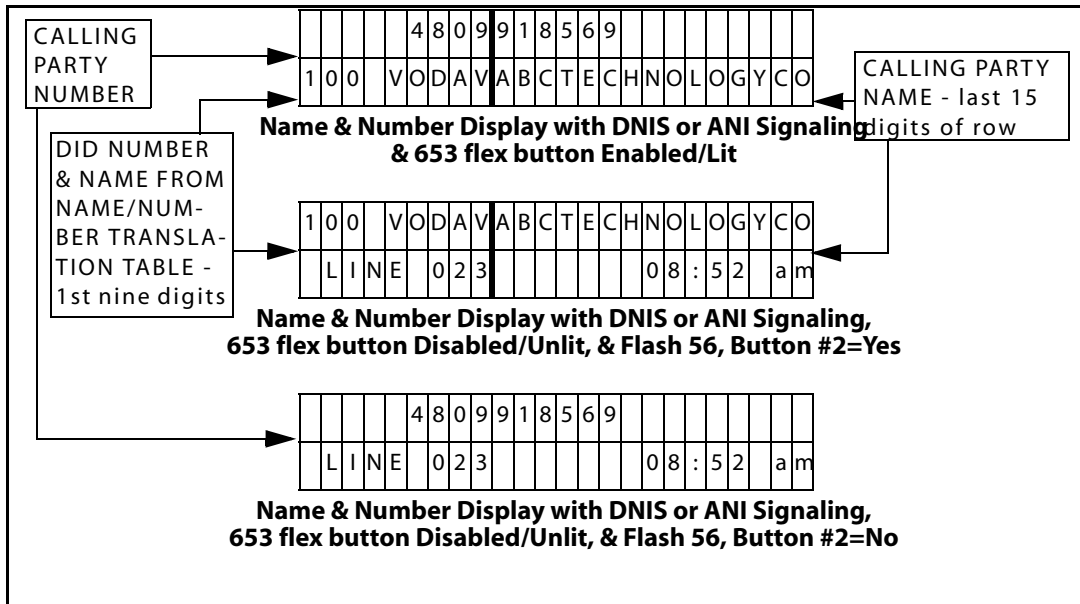

Figure 2-13: Display Examples (Using DNIS or ANI Signaling & FLASH 41, Button #9 Enabled)

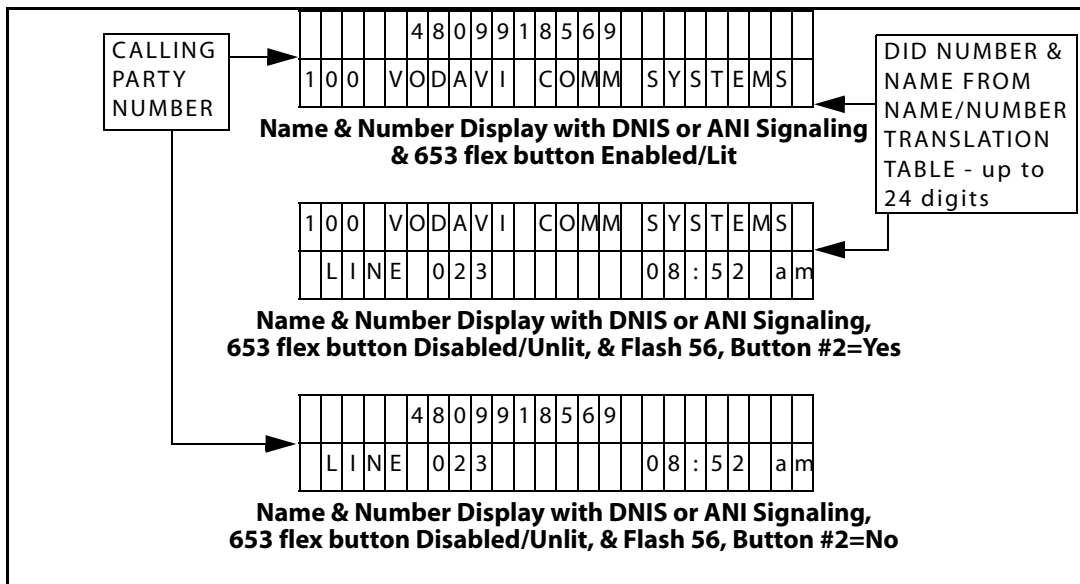

Figure 2-14: Display Examples (Using DNIS or ANI Signaling & FLASH 41, Button #9 Disabled)



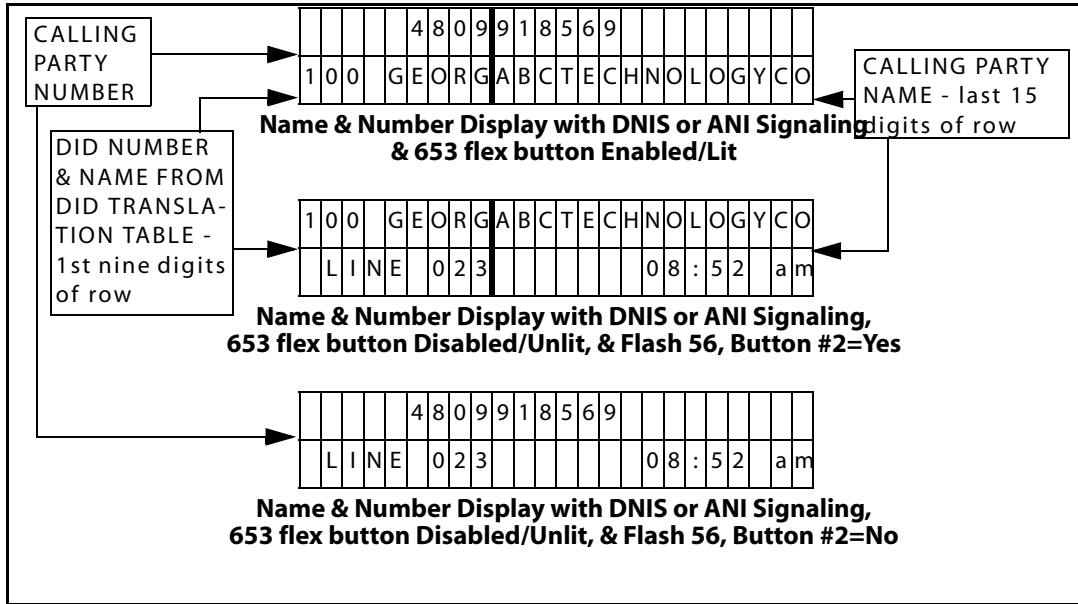

Figure 2-15: Display Examples (Using DNIS or ANI Signaling & FLASH 41, Button #9 Enabled)

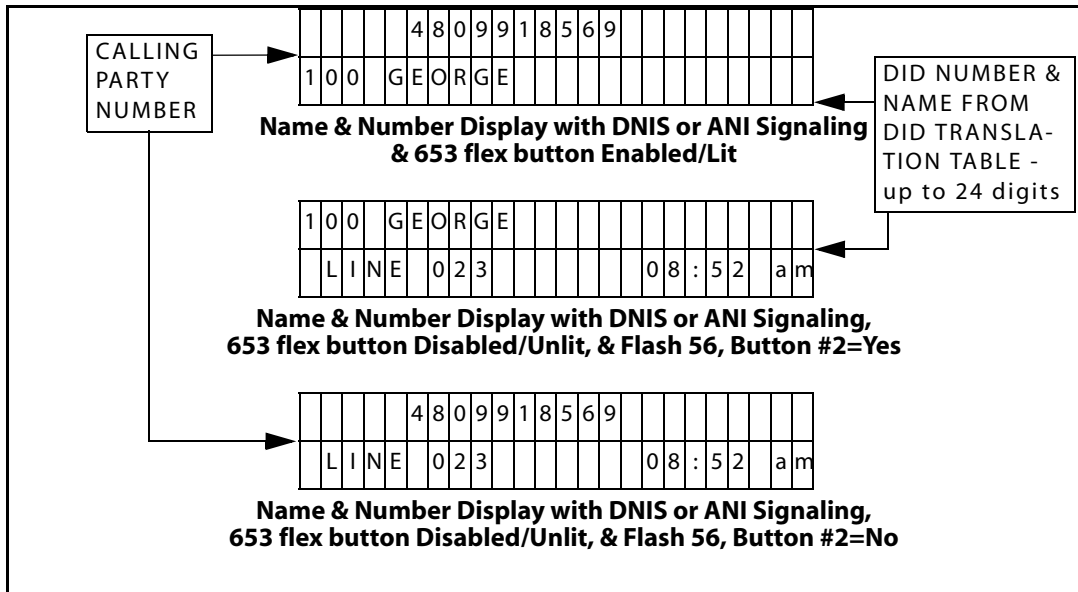

Figure 2-16: Display Examples (Using DNIS or ANI Signaling & FLASH 41, Button #9 Disabled)

## Programming Steps

1. Press **FLASH** and dial **[41]**. The following message displays:

|                                    |
|------------------------------------|
| CO FEATURES<br>ENTER BUTTON NUMBER |
|------------------------------------|

2. Press Button #9. The following message displays:

|                  |     |
|------------------|-----|
| DISPLAY PRI NAME | 0-1 |
| DISABLED         |     |

3. Enter a valid number on the dial pad.  
[0] = Disabled  
[1] = Enabled
4. Press HOLD to save the entry. A confirmation tone sounds and the display updates.

DEFAULT ... Disabled (0) is the default.

## Operation

If DID signaling is used, there are no operational steps required - the calling party's name is displayed if FLASH 41, Button #9 is enabled.

If DNIS or ANI signaling is used, press the preprogrammed flexible button (feature code 653) to enable the Caller ID/Number function. The flexible button acts as a toggle - LED lit = enabled (calling party name **and** number display as shown in upper LCD examples of [Figure 2-13](#) through [Figure 2-16](#)), LED unlit = disabled (calling party name **or** number displays as shown in the bottom two LCD examples of [Figure 2-13](#) through [Figure 2-16](#)).

## Conditions

- » The PRI line from the telephone company must be capable of providing calling-party names.
- » The *Name/Number Display When Using PRI* feature is available with software version V1.02 and higher.
- » The LCD display of names/numbers will be truncated if they are longer than the space you allowed in Flash 41 programming.
- » The Telco-provided name of the caller is always a 15 digit string, regardless of the actual length of the caller's name. The following conditions are based on **default** settings of Flash 41, Buttons #9, #10, and #11.
  - When using DNIS or ANI signaling (FLASH 40, Page B, Button #1), if the DID number and the name in the Name/Number Translation Table (set in FLASH 55) exceeds nine digits (including the space between them), the name in the Name/Number Translation Table will be truncated to accommodate 15 digits for the calling party name display, e.g., VODAVI COMM SYSTEMS is truncated to VODAV in the upper two examples of [Figure 2-13](#).

- When using DNIS or ANI signaling (FLASH 40, Page B, Button #1), if the DID number and the name in the DID Translation Table (set in FLASH 44) exceeds nine digits (including the space between them), the name in the DID Translation Table will be truncated to accommodate 15 digits for the calling party name display, e.g., GEORGE is truncated to GEORG in the upper two examples of [Figure 2-15](#).

## Outbound DID Number on PRI

When the STSe sends caller ID information through the PRI to a central office, it is able to send seven to ten digits to identify the exact station number to an outside caller who is equipped with caller ID. Use of this feature allows the specific station number to be displayed instead of the main directory number of the PRI line.

This feature is implemented on a per station basis.

Use Flash 50 programming when you want to modify a range of stations' attributes using **fixed** station numbers.

Use Flash 51 programming to modify a single station's attributes using a **flexible** station number.

### Programming Steps

1. Press **FLASH** and dial **[50]** or dial **[51]**. Flexible button #24 (New Range) is lit and one of the following messages displays:

#### Flash 50 - Fixed Numbers

STATION ATTRIBUTES  
SELECT A STATION RANGE

#### Flash 51 - Flexible Numbers

ENTER STATION NUMBER

2. Enter the range of **fixed** station numbers (100-149) to be programmed. If only one station is being programmed, enter that number twice, e.g., [100 100].



*If HOLD is pressed without entering a station range, All stations are selected.*

-or-

Enter a valid **flexible** number (100-8999) to be programmed.

3. Press HOLD to save the entry. A confirmation tone sounds and the display updates. Flexible button #19 is lit. The display updates to reflect current programming for Page A:

#### Flash 50 - Fixed Numbers

XXX - XXX PAGE A  
ENTER BUTTON NUMBER

*XXX-XXX = fixed station range*

#### Flash 51 - Flexible Numbers

SXXX PAGE A  
ENTER BUTTON NUMBER

*XXX = 3- or 4-digit flexible number*

4. Press button #21. The display updates to reflect current programming for Page C.

**Flash 50 - Fixed Numbers**

|   |
|---|
| XXX - XXX PAGE C<br>ENTER BUTTON NUMBER |
|---|

*XXX-XXX = fixed station range*

**Flash 51 - Flexible Numbers**

|                                    |
|------------------------------------|
| SXXX PAGE C<br>ENTER BUTTON NUMBER |
|------------------------------------|

*XXX = 3- or 4-digit flexible number*

5. Press **Button #8**. The following message displays:

|                     |
|---------------------|
| OUTBOUND DID NUMBER |
|---------------------|

6. Dial the station number (seven to ten digits).  
 7. Press the HOLD button. A confirmation tone sounds and the display updates



*To prevent a previously programmed station number from displaying by this feature, use Flash 50/51, Page C, Button #8 and press HOLD.  
 The Outbound DID Number On PRI feature does not work if the call is processed through a network before dialing out. The feature will work if a call is dialed out directly from a hub or node over its own Telco PRI line.*

**Conditions**

- » This feature does not apply to CO to CO calls.

---

## ISDN Programming - Page A

### Description

This section describes the procedures and steps necessary to program ISDN attributes. When entering the ISDN attributes portion of the database, the programmer may decide to enter information for a range of slots or one specific slot. Range programming lets the programmer change a specific parameter or a few parameters for an entire range of slots, leaving intact the remaining data fields that do not require change. Those data fields continue to operate with the previously programmed data. By default, Page A is shown.

### Programming Steps

1. Press **FLASH** and dial **[45]**. The following message displays:

|  |
|--|
| ISDN ATTRIBUTES<br>SELECT A SLOT RANGE |
|--|

2. Enter a valid number for the range of slots being programmed. If only one slot is being programmed, enter that number twice (02 02 = Slot 2).
3. Press HOLD to save the entry. A confirmation tone sounds and the display updates. Flexible button #19 (Page A) is lit. The following message displays to indicate current programming of that slot or group of slots:

|                                       |
|---------------------------------------|
| YY - YY PAGE A<br>ENTER BUTTON NUMBER |
|---------------------------------------|

YY = Slot (0-13)

### Primary Rate Interface (PRI) CO Type

#### Description

Changes to PRI CO Type area are not possible at this time (setting = NI2).

#### Programming Steps

1. Press PRI CO TYPE flexible button (**FLASH 45, Page A, Button #2**).
2. To view a CO type setting, enter a valid number (1-4).

|             |     |
|-------------|-----|
| PRI CO TYPE | 1-4 |
| NI2         |     |

1 = NI2  
2 = PPNI2 (point-to-point NI2)  
3 = Future feature (5 ESS Custom)  
4 = Future feature (Nortel)

DEFAULT ... NI2 is the PRI CO type.

## Framing

### Description

Framing options include T1, ESF, and D4.

### Programming Steps

1. Press the FRAMING flexible button (**FLASH 45, Page A, Button #3**).
2. To view a Framing setting, enter a valid number (0-2).

|         |     |
|---------|-----|
| FRAMING | 0-2 |
| ESF     |     |

0 = T1

1 = ESF

2 = D4

DEFAULT ... ESF is the framing setting.

## Power

Do not change the Power setting unless advised to do so by Technical Support.

### Programming Steps

1. Press the POWER flexible button (**FLASH 45, Page A, Button #5**).

|          |     |
|----------|-----|
| POWER    | 0-1 |
| DISABLED |     |

2. Enter a 0 or 1 on the dial pad to enable/disable this feature.
  - [0] = Disabled
  - [1] = Enabled
3. Press the HOLD button. A confirmation tone sounds and the display updates.

DEFAULT - Power is disabled.

## Directory Number - PRI

### Description

The Directory Number is the main number of the PRI lines and it will be viewed by the called party on their caller ID display.

### Programming Steps

1. Press the DIRECTORY NUMBER flexible button (**FLASH 45, Page A, Button #6**).

|                  |           |
|------------------|-----------|
| DIRECTORY NUMBER | 0-9, *, # |
|------------------|-----------|

2. Enter a valid number (0-9,\*,#) on the dial pad (up to 24 digits). This number is sent as the calling party number on all channels of the selected PRIB.
3. Press the HOLD button. A confirmation tone sounds and the display updates.

### *Max Out I-Frames*

#### **Description**

The Max Out I-Frames feature controls the maximum number of sequentially numbered I-Frames that may be outstanding/unacknowledged at any given time. This is a system parameter which shall not exceed 127. Do not change the Max Out I-Frames setting unless advised to do so by Technical Support.

#### **Programming Steps**

1. Press the MAX OUT I-FRAMES flexible button (**FLASH 45, Page A, Button #7**).

|                    |         |
|--------------------|---------|
| MAX OUT I - FRAMES | 000-127 |
| K                  | 001     |

2. Enter a valid number (000-127) on the dial pad.
3. Press the HOLD button. A confirmation tone sounds and the display updates.

### *Leading 1*

#### **Description**

0 disables the leading 1 from being sent to the CO when users dial national long distance numbers. 1 enables the leading 1 to be sent to the CO on national long distance numbers. If enabled, and the user does not dial a 1, the 1 will automatically be applied.

#### **Programming Steps**

1. Press the LEADING 1 flexible button (**FLASH 45, Page A, Button #8**).

|           |     |
|-----------|-----|
| LEADING 1 | 0-1 |
| ENABLED   |     |

2. Enter a 0 or 1 on the dial pad to enable/disable this feature.  
[0] = Disabled  
[1] = Enabled
3. Press the HOLD button. A confirmation tone sounds and the display updates.

DEFAULT ... Leading 1 is enabled.

## Leading 011

### Description

0 disables the leading 011 from being sent to the CO when users dial international numbers. 1 enables the leading 011 to be sent to the CO on international numbers. If enabled, and the user does not dial a 011, the 011 will automatically be applied.

### Programming Steps

1. Press the LEADING 011 flexible button (**FLASH 45, Page A, Button #9**).

|             |     |
|-------------|-----|
| LEADING 011 | 0-1 |
| ENABLED     |     |

2. Enter a 0 or 1 on the dial pad to enable/disable this feature.
  - [0] = Disabled
  - [1] = Enabled
3. Press the HOLD button. A confirmation tone sounds and the display updates.

DEFAULT ... Leading 011 is enabled.

## PRI 7/11 Digit Number Plan

### Description

The PRI 7/11 Digit Number Plan is the specific plan that a particular Central Office uses for 7- to 11-digit PRI calls.

### Programming Steps

1. Press the PRI 7/11 DIG flexible button (**FLASH 45, Page A, Button #10**).

|              |     |
|--------------|-----|
| PRI 7/11 DIG | 0-1 |
| ITU          |     |

2. Enter a 0 or 1 on the dial pad to select the desired Number Plan.
  - [0] = Selects ITU number plan
  - [1] = Selects CO number plan
3. Press the HOLD button. A confirmation tone sounds and the display updates.

DEFAULT ... ITU (ISDN plan)

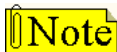

When connecting a PRI to a Nortel DMS 100, enter a 1 for the number plan.



**Nortel DMS 100 Only**

1. Change Flash 45, button 10 (Numbering Plan) to CO by dialing 1 HOLD.
2. Set the definition in the DMS 100 Central Office Switch.
  - The DMS 100 Office refers to this switch as National or N12 Standard so they know not to look at this parameter in their switch.
  - LTDEF should be set to NI PRI N12 V1.

*Calling Number***Description**

0 disables the calling party number from being sent to the CO. 1 will enable the calling party number feature and the number will be sent to the CO.

**Programming Steps**

1. Press the CALLING NUMBER flexible button (**FLASH 45, Page A, Button #11**).

|                           |     |
|---------------------------|-----|
| CALLING NUMBER<br>ENABLED | 0-1 |
|---------------------------|-----|

2. Enter a 0 or 1 on the dial pad to enable/disable this feature.
  - [0] = Disabled
  - [1] = Enabled
3. Press the HOLD button. A confirmation tone sounds and the display updates.  
DEFAULT ... Calling Number is enabled.

*Loopback***Description**

Do not change the Loopback setting unless advised to do so by Technical Support.

**Programming Steps**

1. Press the LOOPBACK flexible button (**FLASH 45, Page A, Button #12**).

|                    |     |
|--------------------|-----|
| LOOPBACK<br>NORMAL | 0-2 |
|--------------------|-----|

2. Enter a valid number (0-2) on the dial pad.
  - [0] = Normal mode
  - [1] = Near end mode
  - [2] = Far end mode
3. Press the HOLD button. A confirmation tone sounds and the display updates.  
DEFAULT ... Loopback setting is normal.

---

## ISDN Programming - Page B

### Description

When entering the ISDN attributes portion of the database, the programmer may decide to enter information for a range of slots or for one specific slot. Range programming lets the programmer change a specific parameter or a few parameters for an entire range of slots, leaving intact the remaining data fields that do not require change. Those data fields continue to operate with the previously programmed data.



**IMPORTANT**--

These timers **should not be adjusted** UNLESS working with Technical Support or your telephone company.

### Programming Steps

1. Press **FLASH** and dial **[45]**. The following message displays:

ISDN ATTRIBUTES  
SELECT A SLOT RANGE

2. Enter a valid number for the range of slots being programmed. If only one slot is being programmed, enter that number twice (02 02 = Slot 2).
3. Press HOLD to save the entry. A confirmation tone sounds and the display updates. Flexible button #19 (Page A) is lit.
4. Press button #20 to select Page B. The following message displays to indicate current programming of that slot or group of slots:

YY - YY PAGE B  
ENTER BUTTON NUMBER

*YY = Slot (0-13)*

## Maximum Number Retransmission

### Description

The Maximum Number of Retransmissions of a frame (N200) is a system parameter. Do not change the Maximum Number Retransmission setting unless advised to do so by Technical Support.

### Programming Steps

1. Press the MAX # RETRANSMSN flexible button (**FLASH 45, Page B, Button #1**).

|                  |     |
|------------------|-----|
| MAX # RETRANSMSN | 0-9 |
| N200             | 3   |

2. Enter a valid number (0-9) on the dial pad.
3. Press the HOLD button. A confirmation tone sounds and the display updates.

DEFAULT ... Maximum Number Retransmission is 3.

## Maximum Octets

### Description

The maximum number of octets in an I-Frame/information field (N201) is a system parameter. Do not change the Maximum Octets setting unless advised to do so by Technical Support.

### Programming Steps

1. Press the MAX OCTETS flexible button (**FLASH 45, Page B, Button #2**).

|            |         |
|------------|---------|
| MAX OCTETS | 000-999 |
| N201       | 260     |

2. Enter a valid number (000-999) on the dial pad.
3. Press the HOLD button. A confirmation tone sounds and the display updates.  
(000 = Disable)

DEFAULT ... Maximum Octet setting is 260.

## *Maximum TEI Request*

### **Description**

This feature is reserved for future use.

### **Programming Steps**

1. Press the MAX TEI RQST flexible button (**FLASH 45, Page B, Button #3**).

|              |         |
|--------------|---------|
| MAX TEI RQST | 000-999 |
| N202         | 003     |

2. Enter a valid number (000-999) on the dial pad.
3. Press the HOLD button. A confirmation tone sounds and the display updates.

DEFAULT ... Maximum TEI Request setting is 003.

## *Maximum XID Retransmission*

### **Description**

Do not change the Maximum number of XID Retransmissions setting unless advised to do so by Technical Support.

### **Programming Steps**

1. Press the MAX XID RETRANSMISSION flexible button (**FLASH 45, Page B, Button #4**).

|                        |     |
|------------------------|-----|
| MAX XID RETRANSMISSION | 0-9 |
| N204                   | 3   |

2. Enter a valid number (0-9 seconds) on the dial pad.
3. Press the HOLD button. A confirmation tone sounds and the display updates.

DEFAULT ... Maximum XID Retransmission setting is 3 seconds.

## *T-200*

### **Description**

The T-200 timer is used to set the time to wait for an I-Frame acknowledgement. Do not change the T-200 timer setting unless advised to do so by Technical Support.

### **Programming Steps**

1. Press the T-200 flexible button (**FLASH 45, Page B, Button #5**).

|      |       |
|------|-------|
| T200 | 00-99 |
| 01   |       |

2. Enter a valid number (00-99 seconds) on the dial pad.
3. Press the HOLD button. A confirmation tone sounds and the display updates.

DEFAULT ... T200 setting is 1 second.

## *Minimum TEI ID Check Message*

### **Description**

The Minimum TEI ID Check Message feature sets the minimum time between retransmission of the TEI identity check messages. Do not change the Minimum TEI ID Check Message setting unless advised to do so by Technical Support.

### **Programming Steps**

1. Press the MIN TEI ID CHK MSG flexible button (**FLASH 45, Page B, Button #6**).

|                    |       |
|--------------------|-------|
| MIN TEI ID CHK MSG | 00-99 |
| T201               | 01    |

2. Enter a valid number (00-99 seconds) on the dial pad.
3. Press the HOLD button. A confirmation tone sounds and the display updates.

DEFAULT ... Minimum TEI ID Check Message setting is 1 second.

## *Minimum TEI ID Request*

### **Description**

This feature is reserved for future use.

### **Programming Steps**

1. Press the MIN TEI ID RQST flexible button (**FLASH 45, Page B, Button #7**).

|                     |       |
|---------------------|-------|
| MIN TEI ID RQST MSG | 00-99 |
| T202                | 02    |

2. Enter a valid number (00-99 seconds) on the dial pad.
3. Press the HOLD button. A confirmation tone sounds and the display updates.

DEFAULT ... Minimum TEI ID Request setting is 2 seconds.

## *Message Exchange Timer*

### **Description**

The Message Exchange Timer setting establishes the maximum time allowed without frames being exchanged. Do not change the Message Exchange Timer setting unless advised to do so by Technical Support.

### **Programming Steps**

1. Press the MSG EXCHANGE TIMER flexible button (**FLASH 45, Page B, Button #8**).

|                    |       |
|--------------------|-------|
| MSG EXCHANGE TIMER | 00-99 |
| T203               | 15    |

2. Enter a valid number (00-99 seconds) on the dial pad.

3. Press the HOLD button. A confirmation tone sounds and the display updates.

DEFAULT ... Message Exchange Timer setting is 15 seconds.

### *Minimum XID Retransmission*

#### **Description**

The Minimum XID Retransmission setting establishes the minimum time between XID messages. Do not change the Minimum XID Retransmission setting unless advised to do so by Technical Support.

#### **Programming Steps**

1. Press the MIN XID RETRANSMSN flexible button (**FLASH 45, Page B, Button #9**).

|                    |     |
|--------------------|-----|
| MIN XID RETRANSMSN | 0-9 |
| T204               | 3   |

2. Enter a valid number (0-9 seconds) on the dial pad.
3. Press the HOLD button. A confirmation tone sounds and the display updates.

DEFAULT ... Minimum XID Retransmission setting is 3 seconds.

### *Inter-Digit T / O*

#### **Description**

Do not change the Inter-digit time out setting unless advised to do so by Technical Support.

#### **Programming Steps**

1. Press the INTER-DIGIT T/O flexible button (**FLASH 45, Page B, Button #10**).

|                 |       |
|-----------------|-------|
| INTER-DIGIT T/O | 00-99 |
| T302            | 25    |

2. Enter a valid number (00-99 seconds) on the dial pad.
3. Press the HOLD button. A confirmation tone sounds and the display updates.

DEFAULT ... Inter-digit Timeout setting is 25 seconds.

## Set-Up Timer

### Description

The Set-up Timer setting establishes the response time to setup message. Do not change the Set-up Timer setting unless advised to do so by Technical Support.

### Programming Steps

1. Press the SET UP TIMER flexible button (**FLASH 45, Page B, Button #11**).

|             |       |
|-------------|-------|
| SETUP TIMER | 00-99 |
| T303        | 10    |

2. Enter a valid number (00-99 seconds) on the dial pad.
3. Press the HOLD button. A confirmation tone sounds and the display updates.

DEFAULT ... Set-up Timer setting is 10 seconds

## Disconnect Timer

### Description

The Disconnect Timer setting establishes the response time to a disconnect message. Do not change the Disconnect Timer setting unless advised to do so by Technical Support.

### Programming Steps

1. Press the DISCONNECT TIMER flexible button (**FLASH 45, Page B, Button #12**).

|                  |       |
|------------------|-------|
| DISCONNECT TIMER | 00-99 |
| T305             | 04    |

2. Enter a valid number (00-99 seconds) on the dial pad.
3. Press the HOLD button. A confirmation tone sounds and the display updates.

DEFAULT ... Disconnect Timer setting is 4 seconds.

## Release Request

### Description

Do not change the Release Request setting unless advised to do so by Technical Support.

### Programming Steps

1. Press the RELEASE REQUEST flexible button (**FLASH 45, Page B, Button #13**).

|                 |       |
|-----------------|-------|
| RELEASE REQUEST | 00-99 |
| T308            | 04    |

2. Enter a valid number (00-99 seconds) on the dial pad.
3. Press the HOLD button. A confirmation tone sounds and the display updates.

DEFAULT ... Release Request Timer setting is 4 seconds.

## *Link Disconnect*

### **Description**

Do not change the Link Disconnect Timer setting unless advised to do so by Technical Support.

### **Programming Steps**

1. Press the LINK DISCONNECT flexible button (**FLASH 45, Page B, Button #14**).

|                 |       |
|-----------------|-------|
| LINK DISCONNECT | 20-30 |
| T309            | 30    |

2. Enter a valid number (20-30 seconds) on the dial pad.
3. Press the HOLD button. A confirmation tone sounds and the display updates.

DEFAULT ... Link Disconnect setting is 30 seconds.

## *Call Proceeding*

### **Description**

Do not change the Call Proceeding setting unless advised to do so by Technical Support.

### **Programming Steps**

1. Press the CALL PROCEEDING flexible button (**FLASH 45, Page B, Button #15**).

|                 |       |
|-----------------|-------|
| CALL PROCEEDING | 00-99 |
| T310            | 60    |

2. Enter a valid number (00-99 seconds) on the dial pad.
3. Press the HOLD button. A confirmation tone sounds and the display updates.

DEFAULT ... Call Proceeding setting is 60 seconds.

## *Connect Request*

### **Description**

Do not change the Connect Request Timer setting unless advised to do so by Technical Support.

### **Programming Steps**

1. Press the CONNECT REQUEST flexible button (**FLASH 45, Page B, Button #16**).

|                 |       |
|-----------------|-------|
| CONNECT REQUEST | 00-99 |
| T313            | 04    |

2. Enter a valid number (00-99 seconds) on the dial pad.
3. Press the HOLD button. A confirmation tone sounds and the display updates.

DEFAULT ... Connect Request setting is 4 seconds.



## Restart Request Timer

### Description

Do not change the Restart Request Timer setting unless advised to do so by Technical Support.

### Programming Steps

1. Press the RESTART REQ TIMER flexible button (**FLASH 45, Page B, Button #17**).

|                   |       |
|-------------------|-------|
| RESTART REQ TIMER | 0-200 |
| T316              | 120   |

2. Enter a valid number (0-200 seconds) on the dial pad.
3. Press the HOLD button. A confirmation tone sounds and the display updates.

DEFAULT ... Restart Request Timer setting is 120 seconds.

## Initialize ISDN Parameters

### Description

The ISDN Parameters may be initialized setting all data fields to their original, default values.

**Table 2-18: ISDN Parameter Defaults**

| Program Code       | Flexible Button | Features                   | Default Value (after initialization) |
|--------------------|-----------------|----------------------------|--------------------------------------|
| FLASH 45<br>PAGE A |                 | ISDN PARAMETERS            |                                      |
|                    | 2               | PRI CO Type                | NI2                                  |
|                    | 3               | Framing                    | ESF                                  |
|                    | 5               | Power                      | Disabled                             |
|                    | 6               | Directory Number           | None                                 |
|                    | 7               | Max Out I-Frames           | K 001                                |
|                    | 8               | Leading 1                  | Enabled                              |
|                    | 9               | Leading 011                | Enabled                              |
|                    | 10              | PRI 7/11 Digit Number Plan | ITU                                  |
|                    | 11              | Calling Number             | Enabled                              |
|                    | 12              | Loopback                   | Normal                               |

**Table 2-18: ISDN Parameter Defaults**

| Program Code | Flexible Button | Features                      | Default Value (after initialization) |
|--------------|-----------------|-------------------------------|--------------------------------------|
| PAGE B       | 1               | Maximum Number Retransmission | 3                                    |
|              | 2               | Maximum Octets                | 260                                  |
|              | 3               | Maximum TEI ID Request        | 003                                  |
|              | 4               | Maximum XID Retransmission    | 3 sec                                |
|              | 5               | T-200                         | 01 sec                               |
|              | 6               | Minimum TEI ID Check Message  | 01 sec                               |
|              | 7               | Minimum TEI ID Request        | 02 sec                               |
|              | 8               | Message Exchange Timer        | 15 sec                               |
|              | 9               | Minimum XID Retransmission    | 3 sec                                |
|              | 10              | Inter Digit T/O               | 25 sec                               |
|              | 11              | Set-up Timer                  | 10 sec                               |
|              | 12              | Disconnect Timer              | 04 sec                               |
|              | 13              | Release Request               | 04 sec                               |
|              | 14              | Link Disconnect               | 30 sec                               |
|              | 15              | Call Proceeding               | 60 sec                               |
|              | 16              | Connect Request               | 04 sec                               |
|              | 17              | Restart Request Timer         | 120 sec                              |

### Programming Steps

1. Press the ISDN flexible button (**FLASH 80, Button #15**). The following message displays:

INITIALIZE ISDN  
PRESS HOLD

2. Press the HOLD button. A confirmation tone sounds.

### Print ISDN Parameters

#### Description

The Print ISDN command dumps the entire database as a permanent record which can serve as a hard copy of the database. The system baud rate must match that of the printer or receiving device.

When printing the ISDN Timers, the following data is printed:

- ISDN Parameters and Timers

□ ISDN Line Parameters and Timers

```

ISDN ATTRIBUTES
-----

SLOT 7
-----
BRI CO TYPE           - NI1
PRI CO TYPE           - NI2
FRAMING                - ESF
NT/TE MODE            - TE
POWER                  - DISABLED
DIRECTORY NUMBER      -
MAX OUT I-FRAMES      K- 1
LEADING 1              - ENABLED
LEADING 011           - ENABLED
7/8 DIGIT NUMBER PLAN - ITU
10 DIGIT NUMBER PLAN  - ITU
11 DIGIT NUMBER PLAN  - ITU
CALLING NUMBER        - ENABLED
LOOPBACK              - NORMAL
MAX # RETRANSM SN     N200- 3
MAX OCTETS            N201- 260
MAX TEI RQST         N202- 3
MAX # XID RETRANSM SN N204- 3
T200                  - 1
MIN TIEID CHK MSG    T201- 1
MIN TIEID RQST MSG   T202- 2
MSG EXCHANGE TIMER   T203- 15
MIN # XID RETRANSM SN T204- 3
INTER-DIGIT T/O      T302- 25
SETUP TIMER           T303- 10
DISCONNECT TIMER     T305- 4
RELEASE REQUEST       T308- 4
LINK DISCONNECT       T309- 30
CALL PROCEEDING       T310- 60
CONNECT REQUEST       T313- 4
RESTART REQ TIMER     T316- 120

```

**Figure 2-17: ISDN Attributes Printout**

### Programming Steps

1. Press the ISDN flexible button (**FLASH 85, Button #16**). The following message displays:

```

PRINT ISDN
PRESS HOLD

```

2. To print the ISDN Parameters, press the HOLD button. The following message displays:

```

PRINTING ISDN

```

When the system has finished sending the requested information to the printer, confirmation tone sounds.

## Keyset Mode

### Description

The Keyset Mode feature (digital KTU only) allows the station user to determine the mode in which the Digital Telephone with CTI Box and Wanderer (optional) operates. The six modes are: Inactive mode, PC Phone mode, ATD Command mode, ATH Command mode, CKTU mode, and SPI mode. Through the use of a dial code, the station user can also determine the baud rate for each mode selected. This setting is stored in back-up memory in the event of a power outage or system reset.

The following Modes are described:

- Inactive -- No CTI information is sent/received by the telephone.
- PC Phone -- CTI information used with Vodavi Discovery Desktop and Discovery PC Phone software must be set to 4800 baud rate.
- ATD -- This is the modem dialing command. The telephone recognizes the ATD and accepts digits after the command. This allows the PC connection to the telephone to use the AT Ringing command. (Available baud rates are: 1200, 2400, and 4800.)
- ATH or ATHX (X = 0 or 1) -- This is the modem on hook/off hook command. ATH or ATH0 forces the telephone to the on hook state from its current state. ATH1 forces the telephone to the off hook state from its current state.



*If the handset is off hook (lifted), these commands are discarded and no action is taken by the telephone.*

- CKTU -- Cordless Key Telephone Unit. This mode is used when the optional *Wanderer* is connected to the station. (Refer to the *Wanderer User Guide* for additional information.)
- SPI -- Service Provider Interface. This mode is used in conjunction with TAPI applications such as Discovery Link.
- TAPI -- For future use.

Use Flash 50 programming when you want to modify a range of stations' attributes using **fixed** station numbers.

Use Flash 51 programming to modify a single station's attributes using a **flexible** station number.

### Programming Steps

1. Press **FLASH** and dial **[50]** or dial **[51]**. Flexible button #24 (New Range) is lit and one of the following messages displays:

#### Flash 50 - Fixed Numbers

STATION ATTRIBUTES  
SELECT A STATION RANGE

#### Flash 51 - Flexible Numbers

ENTER STATION NUMBER

- Enter the range of **fixed** station numbers (100-149) to be programmed. If only one station is being programmed, enter that number twice, e.g., [100 100].

|             |  |
|-------------|--|
| <b>Note</b> | If <b>HOLD</b> is pressed without entering a station range, all stations are selected. |
|-------------|--|

-or-

Enter a valid **flexible** number (100-8999) to be programmed.

- Press **HOLD** to save the entry. A confirmation tone sounds and the display updates. Flexible button #19 is lit. The display updates to reflect current programming for Page A:

**Flash 50 - Fixed Numbers**

|   |
|---|
| XXX - XXX PAGE A<br>ENTER BUTTON NUMBER |
|---|

*XXX-XXX = fixed station range*

**Flash 51 - Flexible Numbers**

|                                    |
|------------------------------------|
| SXXX PAGE A<br>ENTER BUTTON NUMBER |
|------------------------------------|

*XXX = 3- or 4-digit flexible number*

- Press button #20. The display updates to reflect current programming for Page B.

**Flash 50 - Fixed Numbers**

|   |
|---|
| XXX - XXX PAGE B<br>ENTER BUTTON NUMBER |
|---|

*XXX-XXX = fixed station range*

**Flash 51 - Flexible Numbers**

|                                    |
|------------------------------------|
| SXXX PAGE B<br>ENTER BUTTON NUMBER |
|------------------------------------|

*XXX = 3- or 4-digit flexible number*

- Press the **KEYSET MODE** flexible button (**Button #12**). The following message displays:

|               |     |
|---------------|-----|
| KEYSET MODE   | 0-6 |
| INACTIVE MODE |     |

- Enter a valid number (0-6) to change the mode of a digital telephone:

[0] = Inactive Mode (normal mode without CTI box)

[1] = PC Phone (*Discovery Desktop*) Mode at 4800 baud

[2] = ATD Command Mode at 4800 baud

[3] = ATH Command Mode at 4800 baud

[4] = CKTU Mode at 4800 baud

[5] = SPI Mode at 4800 baud

[6] = TAPI Mode at 4800 baud

- Press **HOLD** to save the entry. A confirmation tone sounds and the display updates.

DEFAULT ... Keypad is set for Inactive Mode.

## Operation

At an idle station:

1. Dial the Keypad Mode code [648] on the dial pad,

-or-

Press the preprogrammed KEYPAD MODE button, the following displays:

|                  |        |
|------------------|--------|
| INACTIVE         | 2400   |
| MODE=* SAVE=HOLD | BAUD=# |

2. Press [\*] to scroll through the keypad modes.
3. Press [#] to scroll through the baud rates.
4. Press the HOLD button to save the desired entries.



SINGLE LINE TELEPHONE

Not applicable

## Conditions

- » Telephone must be in AT command mode to process AT commands.
- » CTI information is still sent out the RS-232 port in AT command mode.
- » The ATD command is always accepted by the telephone while it is in the AT command mode. ATHX is accepted only if enabled.
- » ATZ is always enabled if station is in the ATD or ATH command mode.
- » ATD accepts W to indicate a pause command (ATDT9W9982200).
- » ATH or ATH0 causes an on hook event. ATH1 must be specified to go off hook.
- » AT or ATZX (X = 0 or 1) is the modem reset/initialize command. When these commands are sent to the keypad, it returns OK in ASCII format.
- » Only one station at a time can be programmed when using a flexible station number.
- » When in Flash 51 programming, if you press HOLD without specifying a flexible number to be programmed, you will get the station that is in port/station 100.
- » Either the *Wanderer* or the CTI module can be connected to a station, but not both simultaneously.

---

## Last Number Redial

### Description

The Last Number Redial (LNR) feature permits the automatic redialing of the last telephone number dialed on an outside line. Up to 24-digits can be stored. Outside line selection of the same line used is automatic.

### Operation

#### **To use Last Number Redial, either:**

Press the preprogrammed LAST NUMBER REDIAL button (code 650).

-or-

Press [SPEED], then press [#].

-or-

Use the Soft Key's LNR option when in an idle condition.

The last number dialed over an outside line is automatically redialed.

- The system automatically selects the original line used to place the call and redials the number.
- If that line is busy, the system automatically selects another line from the same group and redials the number.
- If no lines are available in the same group, the station receives busy tone and can queue for a line.
- If the station user preselects a line before activating LNR, the preselection overrides the line that was used originally.



SINGLE LINE TELEPHONE

Not applicable

---

## LCD

### *LCD Display - Contrast*

#### Description

Four contrast adjustments are available to adjust the LCD for different lighting levels.

#### Operation

At idle phone, press volume bar up or down for desired effect.



SINGLE LINE TELEPHONE

Not applicable

#### Conditions

- » BGM must be inactive.

- » Handset must be in cradle.
- » ON/OFF button must be set to OFF.

## *LCD Interactive Display*

### **Description**

The STSe Digital Telephone provides you with a visual indication of call status and other information. Calls to and from other extensions, number dialed, line used, and Camp On are some of the items displayed. [Table 2-19 on page 2-217](#) shows Non-Soft Key LCD displays based on the function performed.

The three Soft Keys provide an ability to access commonly used features without having to preprogram those functions on a flexible button or use fixed buttons. Soft Key use is in conjunction with the LCD interactive displays.

### **Non-Soft Key LCD Displays**

Each display is arranged into **upper** and **lower** fields.

- The **upper** field shows the current activity of the telephone.
- The **lower** field is divided into two sections:
  - The *left* section of the **lower** field shows either the date, speed bin number, connected intercom station, or outside line number.
  - The *right* section of the **lower** field shows the current time or elapsed time on an outside call.

### **Soft Key LCD Displays**

Soft Key functions and corresponding LCD displays vary, dependent upon the telephone operating mode, e.g., idle mode, during a conference, active CO line call, or intercom call to a busy station.

When you use Soft Keys while in an idle mode, the following principles apply:

1. Press the right Soft Key to display the first two options.
2. Continue to press the right Soft Key to scroll through two additional options at a time until the desired option appears.
3. Press the left or center Soft Key located immediately below the desired option. Certain options require no further steps for activation, e.g., DND or Clear Forward options.
4. Dial appropriate digits as necessary to activate selected features, e.g., specific speed bin number for speed dialing or specific personal message number.

When you use Soft Keys while in a non-idle mode:

1. Press the right Soft Key. If options exist for the current mode of operation, the option(s) will appear on the LCD.
2. If more than two options exist, use the right Soft Key to scroll through additional options.
3. Press the left or center Soft Key located immediately below the desired option. Certain options require no further steps for activation.
4. Dial appropriate digits as necessary to activate selected features.



**Table 2-19: Liquid Crystal Displays (LCD)**

| Function                            | CALLING Station Display                       | CALLED Station Display                           |
|-------------------------------------|---|--|
| Idle Station                        | STATION XXX<br>MMM DD YY      HH:MM am        | STATION XXXNAME<br>MMM DD YY      HH:MM am       |
|                                     | STA XXXNAME<br>MMM DD YY      HH:MM am        |  |
| Manually Dialing Outgoing Calls     | 18005551212<br>LINE XXX      HH:MM:SS         |  |
| Recalling Line from Hold            | LINE XXX RECALLING<br>MMM DD YY      HH:MM am |  |
| Recalling Line from Another Station | RECALL FROM STA XXX<br>LINE XXX      HH:MM:SS | RECALL FROM ..(name)..<br>LINE XXX      HH:MM:SS |
| Connected to an Incoming CO line    |   | ***XXX***<br>LINE XXX      00:00:10              |
| Intercom Call                       | CALL TO STA XXX<br>MMM DD YY      HH:MM am    | CALL FROM STA XXX<br>MMM DD YY      HH:MM am     |
|                                     | CALL TO ..(name)..<br>MMM DD YY      HH:MM am | CALL FROM ..(name)..<br>MMM DD YY      HH:MM am  |
| Camp On                             | CALL TO STA XXX<br>MMM DD YY      HH:MM am    | CAMP ON BY STA XXX<br>MMM DD YY      HH:MM am    |
|                                     | CALL TO ..(name)..<br>MMM DD YY      HH:MM am | CAMP ON BY ..(name)..<br>MMM DD YY      HH:MM am |
| Conference                          | CONFERENCE<br>MMM DD YY      HH:MM am         | CONFERENCE<br>MMM DD YY      HH:MM am            |
| Internal Page                       | INTERNAL PAGE<br>ZONE X      HH:MM am         | PAGE FROM STA XXX<br>MMM DD YY      HH:MM am     |
|                                     |   | PAGE FROM ..(name)..<br>MMM DD YY      HH:MM am  |

**Table 2-19: Liquid Crystal Displays (LCD)**

| <b>Function</b>   | <b>CALLING Station Display</b>                                | <b>CALLED Station Display</b>                          |
|---|---|--|
| External Zone Page and External All Call Page                     | EXTERNAL PAGE<br>ZONE X                    HH:MM am           |  |
|   | EXTERNAL PAGE<br>MMM DD YY                HH:MM am            |  |
| All Call Page   | ALL CALL PAGE<br>MMM DD YY                HH:MM am            | PAGE FROM STA XXX<br>MMM DD YY                HH:MM am |
| Meet Me Page  | ALL CALL PAGE<br>MMM DD YY                HH:MM am            | PAGE FROM XXX<br>MMM DD YY                HH:MM am     |
|   | CALL FROM XXX<br>MMM DD YY                HH:MM am            | CALL TO XXX<br>MMM DD YY                HH:MM am       |
| Station Call Forward<br>(originating station and name in display) | FORWARDED TO STA XXX<br>MMM DD YY                HH:MM am     |  |
|   | FORWARDED TO ..(name)..<br>MMM DD YY                HH:MM am  |  |
| Station No-Answer Call Forward<br>(originating station)           | NO ANS FWD TO STA XXX<br>MMM DD YY                HH:MM am    |  |
|   | NO ANS FWD TO ..(name)..<br>MMM DD YY                HH:MM am |  |
| Station Busy/<br>No-Answer Call Forward<br>(originating station)  | BSY/NA FWD TO STA XXX<br>MMM DD YY                HH:MM am    |  |
|   | BSY/NA FWD TO ..(name)..<br>MMM DD YY                HH:MM am |  |

Table 2-19: Liquid Crystal Displays (LCD)

| Function  | CALLING Station Display   | CALLED Station Display  |
|---|---|---|
| Station Busy<br>Call Forward<br><br>(originating station)   | BUSY FWD TO STA XXX<br>MMM DD YY      HH:MM am<br><br>BUSY FWD TO ..(name)..<br>MMM DD YY      HH:MM am       |   |
| Forwarded Call<br><br>(name in display)                     | FORWARDED TO STA XXX<br>VIA STA XXX      HH:MM am<br><br>FORWARDED TO ..(name)..<br>VIA STA XXX      HH:MM am | CALL FROM STA XXX<br>VIA STA XXX      HH:MM am<br><br>CALL FROM ..(name)..<br>VIA STA XXX      HH:MM am |
| Forwarded<br>Intercom Call                                  | FORWARDED TO STA XXX<br>VIA STA XXX      HH:MM am   | CALL FROM STA XXX<br>VIA STA XXX      HH:MM am  |
| Station Forwarded to Voice Mail Group<br>(station idle)     | FORWARDED TO VOICE MAIL<br>MMM DD YY      HH:MM am  |   |
| Station Forwarded to UCD Group<br>(station idle)            | FORWARDED TO UCD 55X<br>MMM DD YY      HH:MM am   |   |
| Preset Forward  |   | FORWARD RING<br>LINE XXX      HH:MM am  |
| Station Call to Station Forwarded to a<br>Voice Mail Group* | FORWARDED TO VOICE MAIL<br>VIA STA XXX      HH:MM am  | FORWARDED TO VOICE MAIL<br>MMM DD YY      HH:MM am  |
| Call Pick-Up  | CALL TO STA XXX PICKED UP<br>BY STA XXX      HH:MM am   | CALL TO STA XXX<br>FROM STA XXX      HH:MM am<br><br>TRANSFER FROM STA XXX<br>LINE XXX      HH:MM am    |
| Exclusive Hold  | LINE HOLDING<br>LINE XXX      HH:MM am  |   |
| Do Not Disturb  | DO NOT DISTURB STA XXX<br>MMM DD YY      HH:MM am<br><br>DO NOT DISTURB ..(name)..<br>MMM DD YY      HH:MM am | STA IN DO NOT DISTURB<br>MMM DD YY      HH:MM am  |

Table 2-19: Liquid Crystal Displays (LCD)

| Function                                | CALLING Station Display                              | CALLED Station Display                            |
|---|--|---|
| Call Back                               | CALL BACK FROM STA XXX<br>MMM DD YY      HH:MM am    | CALL FROM STA XXX<br>MMM DD YY      HH:MM am      |
|   | CALL BACK FROM ..(name)..<br>MMM DD YY      HH:MM am | CALL FROM ..(name)..<br>MMM DD YY      HH:MM am   |
| Outside Line Transfer                   | TRANSFER FROM STA XXX<br>LINE XXX      HH:MM am      |   |
|   | TRANSFER FROM ..(name)..<br>LINE XXX      HH:MM am   |   |
| Message Waiting                         |  | MSG: XXX XXX XXX XXX<br>MMM DD YY      HH:MM am   |
| Reply to a Message Waiting              | CALL TO STA XXX<br>MMM DD YY      HH:MM am           | CALL BACK FROM STA XXX<br>MMM DD YY      HH:MM am |
|   | CALL TO ..(name)..<br>MMM DD YY      HH:MM am        |   |
| Programmed Flash Command (F)            | F*1  |   |
| Programmed Pause Command (P)            | 950777P1234567<br>SPEED XXXX      HH:MM am           |   |
| Programmed Pulse-To-Tone Switchover (S) | 950777S1234567<br>SPEED XXXX      HH:MM am           |   |
| CO Line Queuing                         | PLACED IN QUEUE FOR<br>LINE XXX      HH:MM am        |   |
|   | QUEUE CALL BACK<br>LINE XXX      HH:MM am            |   |
| Hunt Groups                             | CALL TO STA XXX<br>VIA HUNT      HH:MM am            |   |
|   | CALL TO ..(name)..<br>VIA HUNT      HH:MM am         |   |

**Table 2-19: Liquid Crystal Displays (LCD)**

| Function   | CALLING Station Display  | CALLED Station Display  |
|--|--|---|
| UCD Groups   | <div style="border: 1px solid black; padding: 2px; margin-bottom: 2px;">CALL TO STA XXX<br/>VIA UCD            HH:MM am</div> <div style="border: 1px solid black; padding: 2px;">CALL TO ..(name)..<br/>VIA UCD            HH:MM am</div> |   |
| Ringing CO Lines   |  | <div style="border: 1px solid black; padding: 2px;">LINE RINGING<br/>LINE XXX            HH:MM am</div>         |
| Display Security   | <div style="border: 1px solid black; padding: 2px;">DISPLAY SECURITY<br/>LINE XXX            HH:MM:SS</div>  |   |
| Station Forwarding Off-Net   | <div style="border: 1px solid black; padding: 2px;">FORWARDED TO SPEED XXXX<br/>MMM DD YY        HH:MM am</div>  |   |
| Call to Station Forwarded Off-Net<br>(before and after a call is answered) | <div style="border: 1px solid black; padding: 2px; margin-bottom: 2px;">FORWARDED OFF NET<br/>LINE XXX            CALLED 102</div> <div style="border: 1px solid black; padding: 2px;">2331234<br/>LINE XXX            HH:MM:SS</div>      | <div style="border: 1px solid black; padding: 2px;">FORWARDED TO SPEED XXXX<br/>MMM DD YY        HH:MM am</div> |
| Calls in Queue - UCD<br>(using dial code)                                  | <div style="border: 1px solid black; padding: 2px;">UCD 55X 02 CALLS IN QUEUE<br/>MMM DD YY        HH:MM am</div>  |   |
| Unavailable Mode (Agent Station) -<br>UCD                                  | <div style="border: 1px solid black; padding: 2px;">UNAVAILABLE UCD * XXX *<br/>MMM DD YY        HH:MM am</div>  |   |
| Station Call to Voice Mail Group Pilot<br>Number                           | <div style="border: 1px solid black; padding: 2px;">CALL TO VOICE MAIL<br/>MMM DD YY        HH:MM am</div>   |   |
| Dial By Name   | <div style="border: 1px solid black; padding: 2px;">DIAL NAME:<br/>MMM DD YY        HH:MM pm</div>   |   |
| Off-Hook Voice Over (OHVO)   | <div style="border: 1px solid black; padding: 2px;">ANNOUNCE TO STA XXX<br/>MMM DD YY        HH:MM am</div>  | <div style="border: 1px solid black; padding: 2px;">ANNOUNCE FROM STA XXX<br/>MMM DD YY        HH:MM am</div>   |
| Executive Override   | <div style="border: 1px solid black; padding: 2px;">MONITORING STA XXX<br/>MMM DD YY        HH:MM am</div>   |   |

**Table 2-19: Liquid Crystal Displays (LCD)**

| Function   | CALLING Station Display  | CALLED Station Display   |
|--|--|--|
| Voice Mail* Transfer with ID Digits  | <div data-bbox="613 407 1015 489" style="border: 1px solid black; padding: 2px;">CALL TO VOICE MAIL<br/>VIA XXX                    MMM DD YY</div> <div data-bbox="613 499 1015 581" style="border: 1px solid black; padding: 2px;">ENTER VM ID:<br/>MMM DD YY                HH:MM pm</div>               |  |
| Repeat Redial  | <div data-bbox="613 617 1015 699" style="border: 1px solid black; padding: 2px;">ENTER RPT REDIAL TIMER<br/>XXX                            066-999</div> <div data-bbox="613 709 1015 791" style="border: 1px solid black; padding: 2px;">RPT REDIAL CALLBACK:<br/>MMM DD YY                HH:MM pm</div> |  |
| <p>Call Coverage Station</p> <p>(after call is answered at coverage station in a non-network system or within same Node)</p> <p>(after call is answered at coverage station in a network with a call passed across a switch)</p> |  | <div data-bbox="1040 827 1442 909" style="border: 1px solid black; padding: 2px;">CALL FOR STA XXXX<br/>MMM DD YY                HH:MM am</div> <div data-bbox="1040 919 1442 1001" style="border: 1px solid black; padding: 2px;">CALL FOR STA XXXX<br/>FROM STA YYYY        HH:MM:SS</div> <div data-bbox="1040 1012 1442 1094" style="border: 1px solid black; padding: 2px;">XXXXXXXXXX CALLING<br/>YYYYYY                    HH:MM:SS</div> |
| Name/Number Display at Idle  | <div data-bbox="613 1142 1015 1224" style="border: 1px solid black; padding: 2px;">STA YYYYYYYYYYYY<br/>MMM DD YY                HH:MM pm</div>  |  |
| Scrollable Canned Messages   | <div data-bbox="613 1247 1015 1329" style="border: 1px solid black; padding: 2px;">XXXXXXXXXXXXXXXXXXXX<br/>NEXT=# PREV=* SAVE=HOLD</div>  |  |
| <p>Answering Machine Emulation</p> <p>(when a call rings the station in ring mode)</p>   | <div data-bbox="613 1373 1015 1455" style="border: 1px solid black; padding: 2px;">VM SCREENING RING<br/>MMM DD YY                HH:MM pm</div>   |  |
| <p>Answering Machine Emulation</p> <p>(when station monitors caller in VM)</p>   | <div data-bbox="613 1499 1015 1581" style="border: 1px solid black; padding: 2px;">VM SCREENING<br/>MMM DD YY                HH:MM pm</div>  |  |

## LCOB Loop Length

### Description

This feature is used to effectively reduce side tone when using LCOBC or LCOBE. When your system is located a short distance from the telephone company (Telco), use the Short option. When your system is located a long distance from the Telco, use the Long option.

### Programming Steps

1. Press **FLASH** and dial **[41]**. The following message displays:

|                                    |
|------------------------------------|
| CO FEATURES<br>ENTER BUTTON NUMBER |
|------------------------------------|

2. Press Button #8. The following message displays:

|                  |     |
|------------------|-----|
| LCOB LOOP LENGTH | 0-1 |
| LONG             |     |

3. Enter a valid number on the dial pad.  
[0] = Short  
[1] = Long
4. Press HOLD to save the entry. A confirmation tone sounds and the display updates.  
DEFAULT ... The Long option (1) is the default.

## Leading Digit

### Description

System administrators can tailor the system numbering plan to change all 3-digit numbers into 4-digit numbers that begin with a desired digit 0-8.

### Programming Steps

1. Press FLASH and dial [09]. The following message displays:

|  |
|--|
| SYSTEM PARAMETERS<br>ENTER BUTTON NUMBER |
|--|

2. Press Button #9. The following message displays:

|               |     |
|---------------|-----|
| LEADING DIGIT | 0-8 |
| 0             |     |

3. Dial a valid number (0-8) to identify the desired leading digit.
4. Press HOLD to save the entry.

|             |   |
|-------------|---|
| <b>Note</b> | Only 3-digit codes will be changed to include a leading digit, e.g., 2-digit codes such as group call pickup (#0) are not affected. |
|-------------|---|

---

## Least Cost Routing

For information about Least Cost Routing (LCR), refer to [Appendix B, "Least Cost Routing."](#)

---

## Light Control

### Description

The Light Control feature allows the light above the LCD on STSe digital telephones to be used as message wait, voice mail (including CO VM integration from the Telco; option #2 in this area of programming), headset off-hook, and ring indications. This feature can be programmed on a per station basis.

Use Flash 50 programming when you want to modify a range of stations' attributes using **fixed** station numbers.

Use Flash 51 programming to modify a single station's attributes using a **flexible** station number.

### Programming Steps

1. Press **FLASH** and dial **[50]** or dial **[51]**. Flexible button #24 (New Range) is lit and one of the following messages displays:

#### Flash 50 - Fixed Numbers

STATION ATTRIBUTES  
 SELECT A STATION RANGE

#### Flash 51 - Flexible Numbers

ENTER STATION NUMBER

2. Enter the range of **fixed** station numbers (100-149) to be programmed. If only one station is being programmed, enter that number twice, e.g., [100 100].

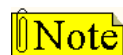

*If HOLD is pressed without entering a station range, all stations are selected.*

-or-

Enter a valid **flexible** number (100-8999) to be programmed.

3. Press HOLD to save the entry. A confirmation tone sounds and the display updates. Flexible button #19 is lit. The display updates to reflect current programming for Page A:

#### Flash 50 - Fixed Numbers

XXX - XXX PAGE A  
 ENTER BUTTON NUMBER

*XXX-XXX = fixed station range*

#### Flash 51 - Flexible Numbers

SXXX PAGE A  
 ENTER BUTTON NUMBER

*XXX = 3- or 4-digit flexible number*



- Press button #20. The display updates to reflect current programming for Page B.

**Flash 50 - Fixed Numbers**

|   |
|---|
| XXX - XXX PAGE B<br>ENTER BUTTON NUMBER |
|---|

XXX-XXX = fixed station range

**Flash 51 - Flexible Numbers**

|                                    |
|------------------------------------|
| SXXX PAGE B<br>ENTER BUTTON NUMBER |
|------------------------------------|

XXX = 3- or 4-digit flexible number

- Press the LIGHT CONTROL flexible button (**Button #15**).

|                       |     |
|-----------------------|-----|
| LIGHT CONTROL<br>NONE | 0-4 |
|-----------------------|-----|

- Enter a valid number (0-4) to change the mode of an ICLID phone.  
 [0] = None                                      [1] = Button Incoming Ringing @ 480 ipm  
 [2] = Voice Mail @ 240 ipm                [3] = Message Wait @ 60 ipm    [4] = Headset @ Steady
- Press HOLD to save the entry. A confirmation tone sounds and the display updates.

DEFAULT ... Light Control is set for None.

**Conditions**

- » Only one station at a time can be programmed when using a flexible station number.
- » When in Flash 51 programming, if you press HOLD without specifying a flexible number to be programmed, you will get the station that is in port/station 100.

---

## Message Wait

Stations that are busy, unattended and ringing, or in DND can be left a message indication by other stations in the system. Up to five messages can be left at one keyset. Upon return to the station, the user can answer the message waiting indication of each party in sequential order.

**To leave a message waiting indication:**

- Lift the handset or press the ON/OFF button.
- Dial the desired intercom station.
- Press the MSG button or use the Soft Key's MSG option. A confirmation tone will sound. The called party's MSG button will flash slowly.
- Replace the handset, or press ON/OFF to end the call.

**To answer a message waiting indication:**

If your MSG button is lit and/or you have an LCD display of "MSG: XXXX", you have a message waiting for you. The first message left is the first one called.

- Press the MSG button or dial [663]. The station that left message will be signaled with tone ringing.
- If the called station does not answer, press the MSG button once if you want to leave that station a message waiting indication.



## SINGLE LINE TELEPHONE

**To leave a message waiting indication:**

1. Lift the handset.
2. Dial the desired intercom station.
3. If you do not receive an answer, or a DND tone sounds, press the FLASH button.
4. Dial [623].
5. Hang up.

**To answer a message waiting indication:**

You have a message waiting for you, when your message waiting lamp is flashing or there is an interrupted dial tone when you lift the handset.

1. Lift the handset.
2. Dial [663]. The station that left message will ring.

---

## Message Waiting Reminder Tone

**Description**

The Message Wait Reminder Timer determines the time between repeated reminder tones to a key telephone with a message waiting. Digital station users may be reminded of a message waiting on their telephone with an audible signal presented at a timed interval. The Message Wait Reminder Tone setting is variable from 000-104 minutes.

**Programming Steps**

1. Press the MESSAGE WAIT REMINDER TONE flexible button (**FLASH 01, Button #13**).

|                  |         |
|------------------|---------|
| M / W TONE TIMER | 000-104 |
| 000              |         |

2. Enter a valid number on the dial pad that corresponds to 000-104 minutes.
3. Press HOLD to save the entry. A confirmation tone sounds and the display updates.

DEFAULT ... Message Wait Reminder Tone is set at 000 (disabled).

---

## Music-On-Hold

A music source, when connected to the system, provides music to all lines on Hold, parked calls, transferred calls and calls waiting to be answered by Uniform Call Distribution (UCD).

This feature can be allowed or denied on a system-wide basis in database programming. This feature can also allow or deny Music-On-Hold heard on each CO line and is programmable on a per CO line basis. This feature also allows the system to assign CO line circuits as additional music inputs. This increases the capacity of music channels beyond the one available on this system. A total of seven channels are available for use on the system.

## MOH Assignments

### Description

The MOH Assignments feature enables the system to assign CO line circuits as an additional 6 music-on-hold inputs. This increases the capacity of music channels beyond the one available on the first installed card in the BKSU for use by a MOH source.

A maximum of seven channels are available for use on the system. By default, no channels are assigned.

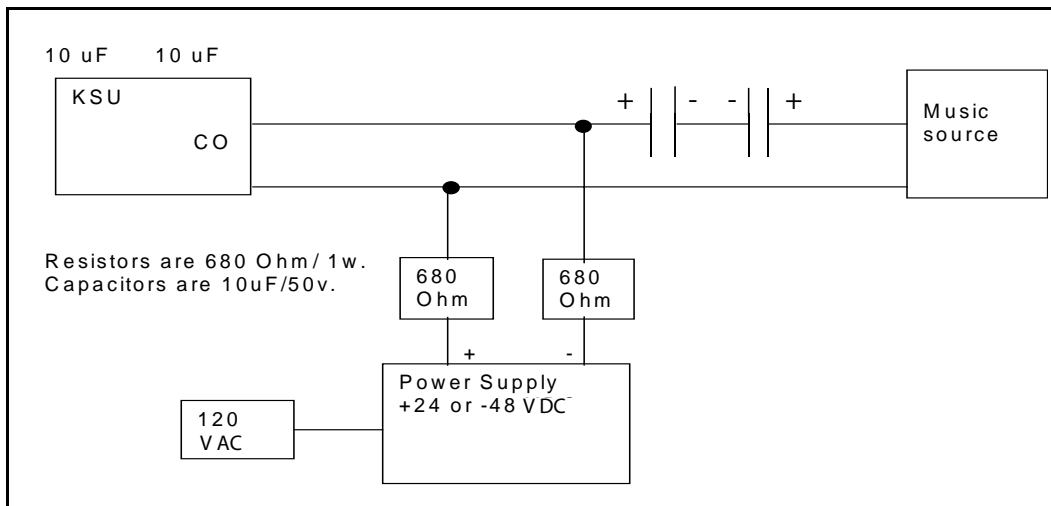

Figure 2-18: Wiring - Music Source to a CO Line

### Programming Steps

1. Press the MUSIC CH # flexible button (**FLASH 09, Button #1 through #6**). The following message displays:

```
MUSIC CHANNEL X   001-XXX
YYY
```

X= 3-8

XXX = Maximum CO Lines in your system

YYY = CO Line number specified for use for this channel

2. Enter a valid number (001-XXX) that corresponds to the CO line number desired.
3. Press HOLD to save the entry. A confirmation tone sounds.

## Music-On-Hold - Enable/Disable

### Description

When connected to the system, a music source provides music to all lines on Hold, parked calls, transferred calls and calls waiting to be answered by Uniform Call Distribution (UCD).

This feature is allowed or denied on a system-wide basis in programming.

## Programming Steps

1. Press MUSIC-ON-HOLD flexible button (**FLASH 05, Button #12**). Feature toggles on/off each time button is pressed; and the display updates.

[0] = Disabled

[1] = Enabled

|                          |     |
|--------------------------|-----|
| MUSIC ON HOLD<br>ENABLED | 0-1 |
|--------------------------|-----|

2. Press HOLD to save the entry. A confirmation tone sounds.

DEFAULT ... Music-On-Hold is enabled.

## Music-On-Hold (per CO Line)

### Description

The Music-On-Hold feature allows a user to select the Music-On-Hold channel for each CO line. This feature lets the system assign CO line circuits as additional music inputs. This increases the capacity of music channels beyond the one available on the first installed card in the BKSU. Up to seven channels are available for use on the system. The CO line can be assigned to NOT PLAY music for callers on hold.

### Programming Steps

1. Press **FLASH** and dial **[40]**. The following message displays:

|  |
|--|
| CO LINE ATTRIBUTES<br>SELECT A CO LINE RANGE |
|--|

2. Enter a valid number for the range of lines being programmed. If only one line is being programmed, enter that number twice (001 001).

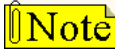
|   |   |
|---|---|
|  <b>Note</b> | If HOLD is pressed without entering a CO line range, all CO lines are selected. |
|---|---|

3. Press HOLD to save the entry. A confirmation tone sounds and the display updates. Flexible Button #19 (Page A) is lit.
4. Press the Page B flexible button (Button #20). The following message displays:

|   |
|---|
| XXX - XXX PAGE B<br>ENTER BUTTON NUMBER |
|---|

XXX-XXX = CO Line Range

- Press the MUSIC-ON-HOLD flexible button (**FLASH 40, Page B, Button #8**). The following message displays:

|             |     |
|-------------|-----|
| MOH CHANNEL | 0-8 |
| 1           |     |

- Enter a valid number on the dial pad to change this feature.  
[0] = No Music-On-Hold  
[1] = Channel 1  
: : : : :  
[8] = Channel 8
- Press HOLD to save the entry. A confirmation tone sounds and the display updates.

**Table 2-20: MOH Programming Codes**

| Program Code  | Flexible Button | Feature           | Default (after initialization) |
|---|-----------------|-------------------|--------------------------------|
| FLASH 09  | 1               | Music Channel #3* | ##                             |
|   | 2               | Music Channel #4* | ##                             |
|   | 3               | Music Channel #5* | ##                             |
|   | 4               | Music Channel #6* | ##                             |
|   | 5               | Music Channel #7* | ##                             |
|   | 6               | Music Channel #8* | ##                             |
| * Music Channels 3-8 can only be used for Music-On-Hold functions |                 |                   |                                |

DEFAULT ... Channel 1 is used for Music-On-Hold.

---

## Mute Key

### Description

Pressing the MUTE button while in the speakerphone mode or using the handset disables the microphone but does not affect the speech coming over the speaker or handset. Pressing the illuminated MUTE button again reactivates the microphone.

### Operation

#### **To disable the microphone:**

- Press MUTE while off-hook on speakerphone or handset to activate.
- Press MUTE again to deactivate. Mute automatically deactivates upon call termination.

### Conditions

- » Changing from handset to speakerphone (or the reverse) cancels the Mute function.

---

## Muted Ring

### Description

The Muted Ring feature provides the ability to set the system so that telephones will ring at a muted level (lesser volume than normal ringing) to alert a station user on an active call that another call is inbound.

### Programming

1. Press **FLASH** and dial **[09]**.
2. Press the MUTE RING flexible button (**Button #12**). The following message displays:

|           |     |
|-----------|-----|
| MUTE RING | 0-2 |
| KSU       |     |

3. Dial a valid Muted Ring code (0-2).
  - 0 = KSU (Muted Ring is controlled by KSU software)*
  - 1 = KEYSET (Muted Ring is controlled by keyset firmware)*
  - 2 = OFF (Muted Ring is disabled)*
4. Press [HOLD]. A confirmation tone sounds.

DEFAULT ... Ring code 0, where Muted Ring is controlled by KSU software.

## Name In Display

### Description

The Name in Display feature allows every extension (digital/SLT) the capability to program the users name for that station, so that people using display telephones see the name instead of the station number on their display. The name is programmed at each station by the user and may be up to seven letters in length.

### Operation

#### To create your name:

1. Dial [690] on the dial pad.
2. Enter the name (up to 7 characters may be entered) by using keys on the dial pad.

| Other Codes |            |         |        |
|-------------|------------|---------|--------|
| 1 = 1#      | 8 = 8#     | " = 01  | * = *# |
| 2 = 2#      | 9 = 9#     | , = 02  | ( = #1 |
| 3 = 3#      | 0 = 0#     | ? = 03  | ) = #2 |
| 4 = 4#      | Space = 11 | / = 04  | + = #3 |
| 5 = 5#      | : = 12     | ! = *1  | = = #4 |
| 6 = 6#      | - = 13     | \$ = *2 | # = ## |
| 7 = 7#      | ' = 14     | & = *4  | . = 24 |

|                              |                      |                              |
|------------------------------|----------------------|------------------------------|
| 1                            | A-21<br>B-22<br>C-23 | D-31<br>E-32<br>F-33         |
| G-41<br>H-42<br>I-43         | J-51<br>K-52<br>L-53 | M-61<br>N-62<br>O-63         |
| P-71<br>R-72<br>S-73<br>Q-74 | T-81<br>U-82<br>V-83 | W-91<br>X-92<br>Y-93<br>Z-94 |
| *                            | OPER<br>0            | #                            |

Figure 2-19: Name In Display Keypad Map

3. Press the SPEED button to complete the programming process.

#### To erase your name:

1. Dial [690] on the dial pad.
2. Press the SPEED button to complete the erasing process.



SINGLE LINE TELEPHONE

#### To create your name:

1. Dial [690] on the dial pad.
2. Enter the name (up to 7 characters may be entered) by using keys on the dial pad.
3. Press the FLASH button to complete the programming process.

#### To erase your name:

1. Dial [690] on the dial pad.
2. Press the FLASH button to complete the erasing process.

## Name / Number Display At Idle

### Description

The Name/Number Display feature allows the programmed seven-digit name and station number to display together. This option is programmable on a per station basis, however the feature must be enabled/disabled in admin programming. If a station has this feature enabled but has not programmed a name, the name portion of the LCD is blank. The priority of the idle display is UCD, Hunt, Station/Name, or Station alone.

Use Flash 50 programming when you want to modify a range of stations' attributes using **fixed** station numbers.

Use Flash 51 programming to modify a single station's attributes using a **flexible** station number.

### Programming Steps

1. Press **FLASH** and dial **[50]** or dial **[51]**. Flexible button #24 (New Range) is lit and one of the following messages displays:

#### Flash 50 - Fixed Numbers

STATION ATTRIBUTES  
SELECT A STATION RANGE

#### Flash 51 - Flexible Numbers

ENTER STATION NUMBER

2. Enter the range of **fixed** station numbers (100-149) to be programmed. If only one station is being programmed, enter that number twice, e.g., [100 100].



If HOLD is pressed without entering a station range, all stations are selected.

-or-

Enter a valid **flexible** number (100-8999) to be programmed.

3. Press HOLD to save the entry. A confirmation tone sounds and the display updates. Flexible button #19 is lit. The display updates to reflect current programming for Page A:

#### Flash 50 - Fixed Numbers

XXX - XXX PAGE A  
ENTER BUTTON NUMBER

XXX-XXX = fixed station range

#### Flash 51 - Flexible Numbers

SXXX PAGE A  
ENTER BUTTON NUMBER

XXX = 3- or 4-digit flexible number

4. Press the NAME/NUMBER DISPLAY flexible button (**Button #15**). The following message displays:

NAME AT IDLE LCD      0-1  
NAME



5. Enter a 0 or 1 on the dial pad to enable/disable this feature.  
[0] = Extension Number  
[1] = Name
6. Press HOLD to save the entry. A confirmation tone sounds.

DEFAULT ... Name displays on the LCD.

### Conditions

- » Not applicable to Single Line Telephones.
- » Only one station at a time can be programmed when using a flexible station number.
- » When in Flash 51 programming, if you press HOLD without specifying a flexible number to be programmed, you will get the station that is in port/station 100.

---

## Name/Number Translation Table

### Description

An administrable table in the KSU provides a local translation from a received calling number to a name. This can be administered by the customer from the Attendant console. This table is also shared by the ICLID features. In cases of conflict between the name delivered from the CO and that in the local translation table, the local translation table rules. 200 entries are provided in this table for the system.

An option was added to the Local Number/Name translation table to route an ICLID or Caller Entered ID Digits, based on a partial compare with the number entered in the translation table.



*If a match is found between a number in the translation table and an incoming call record, the translated name is displayed and/or stored in the unanswered call table.*

### Programming Steps

1. Press **FLASH** and dial **[55]**. The following message displays:

S - XXX ### ,

*XXX = Table Number 600-799*

*### = Route Number 000-251*

The Route Number LED (Button #1) is lit.

2. Enter a Route Number (000-251) from what was entered in ICLID Ringing Assignments, **FLASH [43]**.

**To program a phone number into the translation table:**

1. Press the PHONE NUMBER flexible button (**Button #2**) to enter the desired phone number into the translation table. Maximum length of a phone number is 14 characters, including spaces and dashes. For example, to enter 1-480-443-6000, press:  
[1]+[#]+[1]+[3]+[4]+[#]+[8]+[#]+[0]+[#]+[1]+[3]+[4]+[#]+[4]+[#]+[3]+[#]+[1]+[3]+[6]+[#]+[0]+[#]+[0]+[#]+[0]+[#] (Refer to [Figure 2-3 on page 2-77](#) for a description of keystroke combinations necessary for digit and other character entries.)

Your entry must be 14 character entries in length. If the desired phone number is less than 14 characters, use leading spaces as necessary. For example, to enter 443-6000, press:

[1]+[1]+[1]+[1]+[1]+[1]+[1]+[1]+[1]+[1]+[1]+[1]+[4]+[#]+[4]+[#]+[3]+[#]+[1]+[3]+[6]+[#]+[0]+[#]+[0]+[#]+[0]+[#]



If using a Caller ID Unit (CIDU), the 14-character phone number must use trailing spaces versus leading spaces.

2. Press HOLD to update the database. The BACK SPACE flexible button (**Button #5**) erases current number for error correction.

**To program a name into the translation table:**

1. Press the NAME flexible button (**Button #3**) to enter the desired name into the translation table. Maximum length is 24 characters (refer to [Figure 2-3 on page 2-77](#) for dial pad keys).
2. Press HOLD to update the database. The BACK SPACE flexible button (**Button #5**) erases the current letter for error correction.

**To erase a current phone number/name entry:**

- Press the CLEAR ENTRY flexible button (**Button #4**) to clear an entire phone number and name from the current index.
- Press the NEXT TABLE flexible button (**Button #18**) to advance to the next index and continue entering information into the translation table.
- Press the PREV TABLE flexible button (**Button #19**) to return to a previous index that is already programmed.

**To locate an existing index for editing:**

1. Press the TABLE NUMBER flexible button (**Button #20**). The following message displays:

ENTER TABLE NUMBER

2. Enter a valid number that corresponds to the table numbers 600-799.
3. Press HOLD to complete the entry.

---

## Night Service

### Description

The STSe can be programmed so it is automatically placed into and out of night mode. A programmable weekly time schedule lets the system administrator preset the time the system goes into night mode, and the time night mode is removed on a daily basis, including weekend operation.

The Night Service feature provides a means to put the system in night mode from any keyset or remove the system from night mode from any keyset, as long as the system was put in night mode by the NIGHT SERVICE flexible button [604]. If the system was placed in night mode by the Attendant using the DND button [631] or if the system was placed in night mode by the automatic schedule, the NIGHT SERVICE flexible button cannot remove the system from night mode.

**Digital Voice Mail (DVM)** -- The DVM Day/Night Operation can be set up to follow the same path as the Day/Night/Special Mode for the telephone system.

### Operation

#### **To enter Night Service Mode, from an idle station:**

Press the preprogrammed NIGHT SERVICE flexible button [604]. The system is now in the Night Service Mode.

#### **To remove Night Service Mode:**

Press the preprogrammed NIGHT SERVICE flexible button [604] again. The system is now removed from the Night Service Mode.

## *Automatic/Manual Operation*

### Description

If the system is operated in the automatic night mode the Attendant(s) can override the automatic mode by pressing the night key on the Attendant(s) phone. The schedule does not go into effect until the Attendant(s) press the night key again. When the system is placed into night mode, CO line ringing follows the night ringing assignments and stations are governed by their respective night COS.

The default times for automatic night mode are:

- Monday to Friday 08:00 17:00 (Daytime operation 8:00 am to 5:00 pm)
- Saturday and Sunday ##:## ##:## (24-hour night-mode operation)
  - An entry of 00:00 23:59 indicates 24 hours of day mode.
  - An entry of ##:## ##:## directs the system to ignore these days.

## Programming Steps

1. Press **FLASH** and dial **[22]**. The following message displays:

|     |      |       |      |
|-----|------|-------|------|
| DAY | END  | START | AUTO |
| MON | 0800 | 1700  | NO   |

2. Press the AUTO/MANUAL flexible button (**FLASH 22, Button #1**). This feature toggles on and off each time the button is pressed. The display updates with each toggle.  
LED On = Automatic Night Mode  
LED Off = Manual operation
3. If no other changes must be made, press HOLD to save the entry. A confirmation tone sounds.



Once enabled, this feature addresses the entire week.

## Day of Week Programming

### Programming Steps

**The MONDAY flexible button (Button #2) LED is lit. To change days of the week:**

1. Press the appropriate DAY OF WEEK flexible button (**FLASH 22, Buttons 2-8**).
2. Enter a valid number to indicate the hour and minutes to end night mode.
3. Press HOLD to save the entry. (Example: 07301830 [HOLD]) A confirmation tone sounds and the display updates.

## Automatic Night Mode Operation

The STSe can be programmed in database administration to place the system into Automatic Night Mode. The Attendant(s) can override the Automatic Night Mode schedule simply by pressing the NIGHT (DND) button [631].

## External Night Ringing

The system can be programmed so that CO lines marked for UNA rings on the external page speakers. Refer to ["Universal Day/Night Answer" on page 2-329](#).

## Manual Operation

The Attendant(s) can control the use of Night Mode manually by pressing the NIGHT (DND) button [631]. An LED indicates when the system is in Night Mode operation (flashing = Special Mode, off = Day Mode).

## Night Class of Service (COS)

The system allows each station to be assigned a different COS for night operation. The night COS goes into effect when the system is put into night mode manually or via the automatic schedule. Prevents the misuse of phones after hours.

### *Night Ringing Assignments*

Each CO line may be individually programmed for Night Ringing to other stations, to Hunt/UCD/Voice Mail groups, or off-net via Speed Dial. When the system is placed into night mode, manually or automatically, ringing follows the Night Ringing Assignments for each CO line.

### *Universal Night Answer (UNA)*

Incoming CO lines can be programmed for Universal Night Answer (UNA). Stations that do not have access to a line during the day can answer that line while the system is in the Night Mode by dialing a UNA code. Refer to [“Universal Night Answer \(UNA\)” on page 2-237](#).

### *Weekly Night Mode Schedule*

A programmable weekly night mode schedule provides for 24 hour, 7 day a week automatic night mode operation. The system can be put into and out of night mode automatically on a daily basis.

**Digital Voice Mail (DVM)** -- The DVM Day/Night Operation can be set up to follow the same path as the Day/Night/Special Mode for the telephone system.

#### **Conditions**

- » A station using the night key [604] can put the system into night mode.
- » The automatic schedule will override the station night key [604].
- » The Attendant DND setting [631] overrides both the automatic schedule and the station night key [604].

---

## **Off-Hook Signaling**

### **Description**

If a station has been programmed to receive direct outside line ringing and is busy on another call, the call rings at the station using either a muted ring signal or reminder ring depending on how the option is programmed (refer to [“CO Line - Ringing Options” on page 2-93](#)). A Reminder Ring Timer provides the reminder ring every time the timer expires, as long as the incoming CO line remains connected.

The system defaults this option to muted ringing. CO calls may also be camped-on to a busy station and receive muted ringing.

## Off-Hook Voice Over

### Description

Off-Hook Voice Over (OHVO) enables station users, off-hook on a CO or intercom call, to receive a voice announcement through the handset receiver without completely interrupting the existing call. Your voice is only heard through the handset of the called party's telephone. The Voice Over is muted so it does not override or drown out the existing conversation. The called party can connect to the two parties and carry on two independent conversations using the handset. The called party can also respond using the text messaging feature which sends messages to the calling party's display.

Another method provides for the receiving station to respond to an OHVO announcement using the MUTE feature button. This button is pressed to carry on a two-way conversation with the OHVO initiator while still listening to the original call.



*The calling station is placed in a one-time DND mode upon initiating the Voice Over. One-time DND cannot be toggled during the OHVO call. The station receiving the OHVO call must be off-hook and in the H mode.*

Use Flash 50 programming when you want to modify a range of stations' attributes using **fixed** station numbers.

Use Flash 51 programming to modify a single station's attributes using a **flexible** station number.

### Programming Steps

1. Press **FLASH** and dial **[50]** or dial **[51]**. Flexible button #24 (New Range) is lit and one of the following messages displays:

#### Flash 50 - Fixed Numbers

STATION ATTRIBUTES  
SELECT A STATION RANGE

#### Flash 51 - Flexible Numbers

ENTER STATION NUMBER

2. Enter the range of **fixed** station numbers (100-149) to be programmed. If only one station is being programmed, enter that number twice, e.g., [100 100].



*If HOLD is pressed without entering a station range, all stations are selected.*

-or-

Enter a valid **flexible** number (100-8999) to be programmed.

- Press HOLD to save the entry. A confirmation tone sounds and the display updates. Flexible button #19 is lit. The display updates to reflect current programming for Page A:

**Flash 50 - Fixed Numbers**

|   |
|---|
| XXX - XXX PAGE A<br>ENTER BUTTON NUMBER |
|---|

*XXX-XXX = fixed station range*

**Flash 51 - Flexible Numbers**

|                                    |
|------------------------------------|
| SXXX PAGE A<br>ENTER BUTTON NUMBER |
|------------------------------------|

*XXX = 3- or 4-digit flexible number*

- Press the OHVO flexible button (**Button #9**). The following message displays:

|                                     |
|-------------------------------------|
| OFF HOOK VOICE OVER 0-1<br>DISABLED |
|-------------------------------------|

- Enter a 0 or 1 on the dial pad to enable/disable this feature.  
[0] = Disabled  
[1] = Enabled
- Press HOLD to save the entry. A confirmation tone sounds.

DEFAULT ... Off-Hook Voice Over is disabled for all stations.

**Operation****To place an Off-hook Voice Over call:**

When an OHVO station calls a busy OHVO station and a busy tone is received, the calling OHVO station must press a preprogrammed OHVO button [628] or use the Soft Key's OHVO option to initiate an OHVO announcement, and the following occurs:

- The HOLD button LED flashes at the called OHVO station.
- The OHVO receiving station receives a one-beep warning tone. The station receiving the OHVO call must be off-hook and in H or P mode, then the calling OHVO party may begin the voice announcement to the called OHVO party. The called OHVO station's existing conversation is uninterrupted and the voice over announcement does not drown out the existing conversation. If receiving station is call forwarded, use 5# to override forwarding.
- The calling OHVO station is not connected or able to hear called station's conversation (the connection only allows the calling station to transmit to the called station).

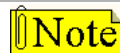

*The calling station is placed in a one-time DND mode upon initiating the Voice Over. One-Time DND cannot be toggled during the OHVO call. The station receiving the OHVO call must be off-hook and in H mode.*

**To respond to an Off-hook Voice Over:**

After receiving an OHVO announcement, **three options** are available to respond to the caller:

**Option 1** -- This method lets the receiving station respond to an OHVO announcement utilizing the MUTE feature button. This button is pressed to carry on a two-way conversation with the OHVO initiator while still listening to the original call.

**Option 2** -- The OHVO receiving station may respond to the calling station by using the Silent Text Messaging (this feature is only available to digital key telephones, and the calling station must be a digital display telephone).

The OHVO receiving station may press a preprogrammed Message button to respond to the voice over announcement without being released from the current call (e.g., by pressing a flexible button preprogrammed for the message IN MEETING, the calling station receives this message on the LCD display). Refer to *"Personal Messages" on page 2-248* and to *"Text Messaging (Silent Response)" on page 2-316*.

**Option 3** -- The OHVO receiving station may respond to the calling OHVO station by using the Camp On feature. The OHVO receiving station presses the flashing HOLD button to consult with the calling station. The existing call (CO line) goes on Exclusive Hold automatically. This method then follows Camp On procedures and operation.



SINGLE LINE TELEPHONE

Not applicable

### Conditions

- » The station must be in H or P mode to enable this feature.
- » The station receiving the OHVO call MUST be off-hook and in H or P mode.
- » The receiving station must have OHVO enabled.
- » When the receiving station responds via Camp On, all conditions and options available to Camp On apply. (Refer to *"Camp On" on page 2-54* for more information).
- » OHVO may be used to notify the receiving station of a transferred call (CO Line or Intercom) by announcing the call, then releasing to complete the transfer. When this occurs, the receiving station need not respond to the OHVO.
- » When a call is transferred via OHVO, the receiving station receives muted ringing after the transfer is complete.
- » Any messages including Canned, Custom, or Silent Response text messaging may be used to respond to an OHVO call. The message appears on the calling station and receiving station LCD displays.
- » If the calling station is a non-LCD telephone, the receiving station receives an error tone when responding via text messaging.
- » The called station may press a flexible button programmed as a Text Message button, [633+#]. Press this flexible button and dial the 2-digit message number (31-51) to respond to the calling station. DTMF digits are not heard by either party.
- » When silent messaging is used to respond to an OHVO call, the existing call on the receiving station is not disconnected while the messages are being sent to the calling station.
- » The calling station of an OHVO call must remain off-hook to receive silent messages. The calling station's voice transmit remains connected to the receiving station and may respond verbally to the text messages. The OHVO call ends when calling station goes on-hook.



- » If the receiving station is on-hook in speakerphone mode and a calling station initiates OHVO, the receiving station receives a Camp On warning tone and normal Camp On procedures are followed.
- » The receiving station may send a message, and then press MUTE to talk to the calling station. Each time a message is sent, the splash tone sounds and both displays are updated.
- » LEDs follow Camp On LED lamp sequences.
- » OHVO does not function if receiving station is in Group Listening Mode.
- » Only one station at a time can be programmed when using a flexible station number.
- » When in Flash 51 programming, if you press HOLD without specifying a flexible number to be programmed, you will get the station that is in port/station 100.

---

## Outside Calls

### Operation

#### **To answer an outside call:**

1. Lift handset or press ON/OFF button.
2. Press slow flashing OUTSIDE LINE button or LOOP button. (If your phone is programmed with Preferred Line Answer, you may answer an outside line by lifting the handset or pressing the ON/OFF button.)

#### **To make an outside call:**

1. Press OUTSIDE LINE or POOL button. ON/OFF button LED lights and dial tone sounds.
2. Dial the desired party.
3. When called party answers, lift handset to converse or use speakerphone.  
(A station user can also dial an individual trunk group access code to access an outside line.)

-or-

1. Dial CO line group code or LCR access code (9, 801-823, 88+LLL) (LLL= CO Line Number).
2. Dial desired telephone number.
3. When called party answers, lift handset or use speakerphone to converse.

#### **To place an outside call on hold:**

If your system is programmed for Exclusive Hold Preference:

Press HOLD button once for Exclusive Hold, twice for System Hold.

If your system is programmed for System Hold Preference:

Press HOLD button once for System Hold, twice for Exclusive Hold.

## Paging

### Description

Stations can individually be allowed or denied the ability to make pages. This applies to all internal and external zone paging. A station denied access to paging may still answer a Meet-Me Page announcement. (Station COS 6 does not deny a station the ability to make a page.)

External paging requires a three-digit dialing code and an externally provided amplifier and paging system. The page zone has a relay contact associated to it.

There are 20 internal paging zones available. A station can be in any or all zones or in no zone at all. Stations not assigned to a page group can still make page announcements, if allowed in station programming. Stations can be assigned to a page group in order to receive pages but not allowed to make page announcements.

### Operation

#### **If you were given the ability to make page announcements:**

1. Lift handset or press ON/OFF button, then press the preprogrammed PAGE button or dial the paging code.

[700] = All Call - Internal and External

[701- 720] = Internal Zone 1-20

[721] = Internal All Calls

[761] = External Zone

-or-

Use the Soft Key's ALLPG IN or ALLPG OUT options (versus codes 721 or 761) when in an idle condition.

2. Stations receiving a Page Announcement can press the Volume Bar to change the paging volume. The following message displays:

|              |          |
|--------------|----------|
| SPEAKER PAGE | [#####]  |
| MMM DD YY    | HH:MM am |



SINGLE LINE TELEPHONE

#### **If you were given the ability to make page announcements:**

1. Lift the handset or press the Speaker button.
2. Dial the paging code.
  - [700] = All Call - Internal and External
  - [701- 720] = Internal Zone 1-20
  - [721] = Internal All Calls
  - [761] = External Zone
3. Speak in normal tone of voice to deliver message.
4. Replace handset to terminate the page announcement.

## Paging Access

### Description

Use Flash 50 programming when you want to modify a range of stations' attributes using **fixed** station numbers.

Use Flash 51 programming to modify a single station's attributes using a **flexible** station number.

### Programming Steps

1. Press **FLASH** and dial **[50]** or dial **[51]**. Flexible button #24 (New Range) is lit and one of the following messages displays:

#### Flash 50 - Fixed Numbers

STATION ATTRIBUTES  
SELECT A STATION RANGE

#### Flash 51 - Flexible Numbers

ENTER STATION NUMBER

2. Enter the range of **fixed** station numbers (100-149) to be programmed. If only one station is being programmed, enter that number twice, e.g., [100 100].



*If HOLD is pressed without entering a station range, all stations are selected.*

-or-

Enter a valid **flexible** number (100-8999) to be programmed.

3. Press HOLD to save the entry. A confirmation tone sounds and the display updates. Flexible button #19 is lit. The display updates to reflect current programming for Page A:

#### Flash 50 - Fixed Numbers

XXX - XXX PAGE A  
ENTER BUTTON NUMBER

*XXX-XXX = fixed station range*

#### Flash 51 - Flexible Numbers

SXXX PAGE A  
ENTER BUTTON NUMBER

*SXXX = 3- or 4-digit flexible number*

4. Press the PAGE ACCESS flexible button (**Button #1**). The following message displays:

PAGE ACCESS                      0-1  
ENABLED

5. Enter a 0 or 1 on the dial pad to enable/disable this feature.  
[0] = Disabled  
[1] = Enabled
6. Press HOLD to save the entry. A confirmation tone sounds.

DEFAULT ... Paging is enabled at all stations.

### Conditions

- » Only one station at a time can be programmed when using a flexible station number.
- » When in Flash 51 programming, if you press HOLD without specifying a flexible number to be programmed, you will get the station that is in port/station 100.

## *Paging - Meet Me*

### Description

Users may answer a page call from any phone in the system by dialing [770]. The party who initiated the page must remain off-hook.

### Operation

#### **To request another party meet you on a page:**

1. Dial the desired internal or external paging code.
2. Request that party meet you on the page.
3. Do not hang up, wait for the requested party to answer. As soon as the paged party answers and is connected to you, the page circuit releases.

#### **To answer a meet me page:**

1. Go to the nearest telephone.
2. dial [770] on the dial pad,  
-or-  
Press the preprogrammed MEET ME button.  
You are connected to the paging party.



#### SINGLE LINE TELEPHONE

The SLT operation uses the same procedures as used in Digital Telephone operation described above, except there is no MEET ME button.

## Paging Time-Out Timer

### Description

The Paging Time-Out Timer determines the maximum length of a page announcement (internal, external or all call). The system automatically disconnects the page at the end of this time unless the person making the page has already hung up.

The Paging Time-out Timer setting is variable from 01–60 seconds. A 00 entry disables the timer and pages are not limited in length. *This affects the use of the Meet Me Page feature.*

### Programming Steps

1. Press the PAGING TIMEOUT TIMER flexible button (**FLASH 01, Button #10**). The following message displays:

|                |       |
|----------------|-------|
| PAGING TIMEOUT | 00-60 |
| 15             |       |

2. Enter a valid number on the dial pad that corresponds to 01-60 seconds.
3. Press HOLD to save the entry. A confirmation tone sounds and the display updates.

DEFAULT ... Paging Time-out Timer is set at 15 seconds.

## Page Warning Tone

### Description

The Page Warning Tone determines whether a page warning tone sounds over the Key Telephone speakers or external paging speakers, prior to a page announcement.

### Programming Steps

1. Press the PAGE WARN TONE flexible button (**FLASH 05, Button #5**).
2. Enter a valid number (0 or 1) that corresponds with the following:  
[0] = Disabled  
[1] = Enabled

|                   |     |
|-------------------|-----|
| PAGE WARNING TONE | 0-1 |
| ENABLED           |     |

3. Press HOLD to save the entry. A confirmation tone sounds.

DEFAULT ... Page Warning Tone is enabled.

## Paging Zone(s)

### Description

Stations are assigned to Page Zones. At least one station must be assigned to a Zone for that Zone to be active. Stations can be in any combination of the 20 zones or in none of the zones.

Use Flash 50 programming when you want to modify a range of stations' attributes using **fixed** station numbers.

Use Flash 51 programming to modify a single station's attributes using a **flexible** station number.

### Programming Steps

1. Press **FLASH** and dial **[50]** or dial **[51]**. Flexible button #24 (New Range) is lit and one of the following messages displays:

#### Flash 50 - Fixed Numbers

STATION ATTRIBUTES  
SELECT A STATION RANGE

#### Flash 51 - Flexible Numbers

ENTER STATION NUMBER

2. Enter the range of **fixed** station numbers (100-149) to be programmed. If only one station is being programmed, enter that number twice, e.g., [100 100].



*If HOLD is pressed without entering a station range, all stations are selected.*

-or-

Enter a valid **flexible** number (100-8999) to be programmed.

3. Press HOLD to save the entry. A confirmation tone sounds and the display updates. Flexible button #19 is lit. The display updates to reflect current programming for Page A:

#### Flash 50 - Fixed Numbers

XXX - XXX PAGE A  
ENTER BUTTON NUMBER

*XXX-XXX = fixed station range*

#### Flash 51 - Flexible Numbers

SXXX PAGE A  
ENTER BUTTON NUMBER

*XXX = 3- or 4-digit flexible number*

4. Press button #20. The display updates to reflect current programming for Page B.

#### Flash 50 - Fixed Numbers

XXX - XXX PAGE B  
ENTER BUTTON NUMBER

*XXX-XXX = fixed station range*

#### Flash 51 - Flexible Numbers

SXXX PAGE B  
ENTER BUTTON NUMBER

*XXX = 3- or 4-digit flexible number*

- Press the PAGE ZONE flexible button (**Button #6**). The following message displays:

|           |       |
|-----------|-------|
| PAGE ZONE | 01-20 |
| 1         |       |

- Enter a valid number (01-20) to program Paging Zone(s).

|               |                |                |                |
|---------------|----------------|----------------|----------------|
| [01] = Zone 1 | [06] = Zone 6  | [11] = Zone 11 | [16] = Zone 16 |
| [02] = Zone 2 | [07] = Zone 7  | [12] = Zone 12 | [17] = Zone 17 |
| [03] = Zone 3 | [08] = Zone 8  | [13] = Zone 13 | [18] = Zone 18 |
| [04] = Zone 4 | [09] = Zone 9  | [14] = Zone 14 | [19] = Zone 19 |
| [05] = Zone 5 | [10] = Zone 10 | [15] = Zone 15 | [20] = Zone 20 |

- Press HOLD to save the entry. A confirmation tone sounds and the display updates.

DEFAULT ... All stations are in Zone 1.

### Conditions

- » Only one station at a time can be programmed when using a flexible station number.
- » When in Flash 51 programming, if you press HOLD without specifying a flexible number to be programmed, you will get the station that is in port/station 100.

---

## Pause Timer

### Description

When dialing a speed number, a timed pause between digit sending can be placed in the number. The length of this pause can be programmed in the system database.

The Pause Timer determines the length of the pause when programmed for use with speed dialing and LCR Insert Tables. The Pause Timer setting is variable from 1–9 seconds. There is no 0 entry. Using this feature may affect Centrex transfers.

### Programing Steps

- Press the PAUSE TIMER flexible button (**FLASH 01, Button #7**). The following message displays:

|             |     |
|-------------|-----|
| PAUSE TIMER | 1-9 |
| 2           |     |

- Enter a valid number on the dial pad that corresponds to 1-9 seconds.
- Press HOLD to save the entry. A confirmation tone sounds and the display updates.

DEFAULT ... Pause Timer is set at 2 seconds.

---

## Personal Messages

### Description

There are various types of personal messages that a station user can use to display on the LCD of the digital key telephone calling that station. Message types include pre-assigned messages, customized messages, date and time messages, and scrollable canned messages.

### *Pre-assigned Messages*

#### Description

Each station can select a pre-assigned message to display on the LCD of any key telephone calling that station. There are ten messages available.

#### Operation

##### **To select a pre-assigned message:**

1. Dial [633] on the dial pad,  
-or-  
Press a preprogrammed PERSONAL MESSAGES button.
2. Dial the 2-digit code for the message that displays. A confirmation tone sounds and the DND button LED flashes.

|                        |                 |
|------------------------|-----------------|
| 00 = (clears messages) | 06 = On Trip    |
| 01 = On Vacation       | 07 = In Meeting |
| 02 = Return AM         | 08 = At Home    |
| 03 = Return PM         | 09 = On Break   |
| 04 = Return Tomorrow   | 10 = At Lunch   |
| 05 = Return Next Week  |                 |

##### **To cancel a pre-assigned message:**

1. Either dial the Personal Messages code [633] + [00], dial [662], or press the DND button.
2. Replace handset. DND button LED extinguishes.



#### SINGLE LINE TELEPHONE

SLT users can use pre-assigned messages as described above, except there is no PERSONAL MESSAGES button. The use of pre-assigned messages is cancelled by using feature code 662.

#### Conditions

- » This feature is unavailable at Attendant stations.
- » Stations cannot be call forwarded or in DND and have this feature active.



## Custom Messages

### Description

Each station can select from ten possible custom messages to display on the LCD of a key telephone calling that station. These messages are programmed from the first Attendant station for system-wide use.

Each station can also program three unique custom messages.

### Operation

#### **To select a custom message:**

1. Dial [633] on the dial pad,  
-or-  
Press a preprogrammed PERSONAL MESSAGES button.
2. Dial a valid message number (21-30) for the desired custom message. The first Attendant should provide a list of messages to each station user.

#### **To program a unique custom message:**

1. Dial [633] on the dial pad.
2. Dial a valid message number (18-20) for the desired custom message.
3. Enter a custom message, up to eight characters.
4. Press HOLD to save.

#### **To use a unique custom message:**

1. Dial [633] on the dial pad.  
-or-  
Press a preprogrammed PERSONAL MESSAGES button.
2. Dial a valid message number (18-20) for the desired custom message.

#### **To cancel a custom message:**

1. Either dial the Personal Messages code [633] + [00], dial [662], or press the DND button.
2. Replace handset. DND button LED extinguishes.



SINGLE LINE TELEPHONE

SLT users can use custom messages (21-30) as described above. Unique custom messages (18-20) are not applicable. Custom message use is cancelled by using feature code 662.

### Conditions

- » This feature is not available to Attendant stations.

## Date and Time Entry Messages

### Description

Station users can activate certain messages that let users enter a specific time or return date. These messages appear on the calling station's display to alert them of the desired party's return time or date.

### Operation

#### To activate a message with a custom return time or date:

1. Dial the Message Access code [633] on the dial pad.
2. Then dial the desired message number [11- 17].

Users may activate the following messages and be prompted to enter a return time or date:

[11] = Vacation Until: *MM/DD*

[12] = Return: *HH:MM xm* or *MM/DD*

[13] = On Trip Until: *MM/DD*

[14] = Meeting Until: *HH:MM xm*

[15] = At Home Until: *HH:MM xm*

[16] = On Break Until: *HH:MM xm*

[17] = At Lunch Until: *HH:MM xm*

3. Enter the date/time using buttons on the dial pad as shown in the following table.

|                              |                      |                              | Other Codes |            |         |        |
|------------------------------|----------------------|------------------------------|-------------|------------|---------|--------|
| 1                            | A-21<br>B-22<br>C-23 | D-31<br>E-32<br>F-33         | 1 = 1#      | 8 = 8#     | " = 01  | * = *# |
| G-41<br>H-42<br>I-43         | J-51<br>K-52<br>L-53 | M-61<br>N-62<br>O-63         | 2 = 2#      | 9 = 9#     | , = 02  | ( = #1 |
| P-71<br>R-72<br>S-73<br>Q-74 | T-81<br>U-82<br>V-83 | W-91<br>X-92<br>Y-93<br>Z-94 | 3 = 3#      | 0 = 0#     | ? = 03  | ) = #2 |
| *                            | OPER                 | #                            | 4 = 4#      | Space = 11 | / = 04  | + = #3 |
|                              | 0                    |                              | 5 = 5#      | : = 12     | ! = *1  | = = #4 |
|                              |                      |                              | 6 = 6#      | - = 13     | \$ = *2 | # = ## |
|                              |                      |                              | 7 = 7#      | ' = 14     | & = *4  | . = 24 |

Figure 2-20: Other Keypad Codes (Date and Time)

4. Press HOLD to enter message. A confirmation tone sounds; the DND button LED flashes.

#### To cancel the message:

1. Either dial the Personal Messages code [633] + [00], dial [662], or press the DND button.
2. Replace handset. DND button LED extinguishes.



SINGLE LINE TELEPHONE

Not applicable

## Scrollable Canned Messages

### Description

The Scrollable Canned Message feature allows the user to use a single digit [#] or [\*] to scroll through the canned messages and select one. When the desired message is displayed, pressing the hold button places that message on the station LCD. This feature operates when the phone is in the idle mode only. This feature cannot be activated if the station is in the Call Forward or DND mode(s). This feature is not available to Attendant stations.

### Operation

#### To select a Scrollable Canned Message:

1. Dial [633]+[#] on the dial pad,  
-or-  
Use the Soft Key's PERS-MSG option,  
-or-  
Press the PERSONAL MESSAGES button. Clear Messages is always first. The following message displays:

CLEAR MESSAGES  
NEXT=#    PREV=\*    SAVE=HOLD

2. Press [#] to scroll through the messages or press [\*] to scroll backward through the list.
3. Scroll forward through messages in the following order. The scroll is a rolodex-type scroll.
 

|                      |                       |
|----------------------|-----------------------|
| 1 - (Clear Messages) | 7 - On Vacation       |
| 2 - At Home          | 8 - Return AM         |
| 3 - At Lunch         | 9 - Return PM         |
| 4 - In Meeting       | 10 - Return Next Week |
| 5 - On Break         | 11 - Return Tomorrow  |
| 6 - On Trip          |                       |
4. When the desired message is shown on the LCD display, pressing the HOLD button activates that message on your station. Confirmation tone sounds and the DND button LED flashes.

#### To cancel the message:

1. Either dial the Personal Messages code [633] + [00], dial [662], or press the DND button.
2. Replace handset. DND button LED extinguishes.



SINGLE LINE TELEPHONE

Not applicable

### Conditions

- » The telephone receiving the message must be a display telephone.
- » When a message displays by a key telephone, the DND button LED flashes at 15 ipm.
- » When DND is invoked on the telephone the message cancels.

---

*Features and Operation*

- » Message Access (with a desired message) may be assigned to a flexible button.
- » Messages may be entered while off-hook on a call if an intercom call is camped onto the station. This causes the station calling to see the message.
- » Messages are retained in battery protected area of memory in the event of power failure or system reset.

### *Personal Messages Flexible Button*

#### **Description**

You can program code [633] onto a flexible button to speed access to select and use messages.

#### **Operation**

##### ***To program the Personal Messages Flexible Button:***

1. Press the SPEED button twice.
2. Press the desired flexible button. LED flashes.
3. Dial [633]+[#] on the dial pad. A confirmation tone sounds.

##### ***To use the flexible button, press that flexible button, then either:***

Dial the 2-digit message number (00-10 or 18-30) to activate the message. Confirmation tone sounds and DND button LED flashes.

-or-

Press [#] to scroll forward or [\*] to scroll backward through the list. When desired message is shown on the LCD, press HOLD to activate that message on your station. Confirmation tone sounds and DND button LED flashes



SINGLE LINE TELEPHONE

Not applicable

## Preferred Line Answer

### Description

A station with Preferred Line Answer can answer any assigned outside, transferred, or recalling line, or queue callbacks by lifting the handset or pressing the ON/OFF button. The station **MUST** be physically ringing, to function properly.

Use Flash 50 programming when you want to modify a range of stations' attributes using **fixed** station numbers.

Use Flash 51 programming to modify a single station's attributes using a **flexible** station number.

### Programming Steps

1. Press **FLASH** and dial **[50]** or dial **[51]**. Flexible button #24 (New Range) is lit and one of the following messages displays:

#### Flash 50 - Fixed Numbers

STATION ATTRIBUTES  
SELECT A STATION RANGE

#### Flash 51 - Flexible Numbers

ENTER STATION NUMBER

2. Enter the range of **fixed** station numbers (100-149) to be programmed. If only one station is being programmed, enter that number twice, e.g., [100 100].

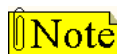

If **HOLD** is pressed without entering a station range, all stations are selected.

-or-

Enter a valid **flexible** number (100-8999) to be programmed.

3. Press **HOLD** to save the entry. A confirmation tone sounds and the display updates. Flexible button #19 is lit. The display updates to reflect current programming for Page A:

#### Flash 50 - Fixed Numbers

XXX - XXX PAGE A  
ENTER BUTTON NUMBER

XXX-XXX = fixed station range

#### Flash 51 - Flexible Numbers

SXXX PAGE A  
ENTER BUTTON NUMBER

SXXX = 3- or 4-digit flexible number

4. Press the **PREF LINE ANSWER** flexible button (**Button #8**). The following message displays:

PREF LINE ANSWER      0-1  
ENABLED

*Features and Operation*

5. Enter a 0 or 1 on the dial pad to enable/disable this feature.  
[0] = Disabled  
[1] = Enabled
6. Press HOLD to save the entry. A confirmation tone sounds.

DEFAULT ... Preferred Line Answer is enabled on all stations.

**Conditions**

- » Only one station at a time can be programmed when using a flexible station number.
- » When in Flash 51 programming, if you press HOLD without specifying a flexible number to be programmed, you will get the station that is in port/station 100.

---

## Privacy Release

**Description**

Privacy is insured on all communications in the system. If desired, the customer may elect to disable the Automatic Privacy feature, thus allowing up to seven other stations to join in on an existing CO Line conversations.

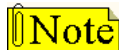

*Disabling of the privacy feature may be limited by federal, state or local law, so check the relevant laws in your area before disabling privacy.*

*Per CO Line Option***Description**

The Per CO Line feature allows programming of each CO line individually for privacy. This feature is useful for maintaining security on such lines as data lines, private lines, or special circuits requiring privacy. If privacy is disabled on a CO line then, while in use, another station may enter the conversation simply by pressing the CO line button. A programmable warning tone is presented to all parties prior to actual cut-thru. The station attempting to enter the conversation must also have privacy disabled.

**Table 2-21: CO Line Privacy Flag**

| Station Attempting to Access CO Line | CO Line in Use by Another Station |                                       |
|--------------------------------------|-----------------------------------|---------------------------------------|
|                                      | Privacy Enabled                   | Privacy Disabled                      |
| Privacy Enabled                      | Private (no cut-through)          | Private (no cut-through)              |
| Privacy Disabled                     | Private (no cut-through)          | Privacy Release (cut-through allowed) |

## Programming Steps

1. Press **FLASH** and dial **[40]**. The following message displays:

CO LINE ATTRIBUTES  
SELECT A CO LINE RANGE

2. Enter a valid number for the range of lines being programmed. If only one line is being programmed, enter that number twice (001 001).

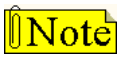
 *If HOLD is pressed without entering a CO line range, all CO lines are selected.*

3. Press HOLD to save the entry. A confirmation tone sounds and the display updates. Flexible button #19 (Page A) is lit. The following message displays to indicate current programming of that line or group of lines:

XXX - XXX PAGE A  
ENTER BUTTON NUMBER

XXX-XXX = CO Line Range

4. Press the PRIVACY flexible button (**Button #5**).

|                    |     |
|--------------------|-----|
| PRIVACY<br>ENABLED | 0-1 |
|--------------------|-----|

5. Enter a 0 or 1 on the dial pad to enable/disable this feature.  
[0] = Disabled  
[1] = Enabled
6. Press HOLD to save the entry. A confirmation tone sounds.

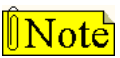
 *Disabling the privacy feature may be limited by federal, state or local law, so check the relevant laws in your area before disabling privacy.*

### Disabling Privacy Function:

The system can be programmed to eliminate CO Line Privacy, which allows another station to join existing outside line conversations as follows:

- Stations must have a direct CO line appearance to join CO line conversations in progress.
- A station must also have Privacy disabled before the system allows that station to enter an existing conversation.
- A programmed warning tone is presented to both parties prior to actual cut-through (Flash 06, Button 1).
- Up to seven other stations may join an existing conversation.
- The station joining the call receives a solid red LED indication.

DEFAULT ... Privacy is enabled for all CO Lines.

## Per Station Option

### Description

The system provides privacy on all communications in the system which prevents other stations from accidentally entering an existing conversation. However, the system provides the ability for a station to join an existing outside CO line conversation (on a per station basis). Each station can be granted the privilege to join an existing CO line conversation by simply pressing the CO line button of a CO line in use.

Privacy on an SLT can be useful in situations where a modem is using the SLT port for data transmission. Disabling this feature lets data transfer proceed without being interrupted with a Camp On tone. Both the station and the CO Line must have Privacy disabled before the system allows cut-through.

- If Privacy is disabled and a station joins an existing call, a programmable warning tone is presented to both parties prior to actual cut-through.
- If Privacy is disabled, up to seven other stations may join in on an existing conversation. Privacy is enabled for all stations in default.

**Table 2-22: Station Privacy Flag**

| Station Attempting to Access CO Line | CO Line in Use by Another Station |  |
|--------------------------------------|-----------------------------------|--|
|                                      | Privacy Enabled                   | Privacy Disabled                       |
| Privacy Enabled                      | Private (no cut-through)          | Private (no cut-through)               |
| Privacy Disabled                     | Private (no cut-through)          | Privacy Released (cut-through allowed) |

Use Flash 50 programming when you want to modify a range of stations' attributes using **fixed** station numbers.

Use Flash 51 programming to modify a single station's attributes using a **flexible** station number.

### Programming Steps

1. Press **FLASH** and dial **[50]** or dial **[51]**. Flexible button #24 (New Range) is lit and one of the following messages displays:

#### Flash 50 - Fixed Numbers

STATION ATTRIBUTES  
SELECT A STATION RANGE

#### Flash 51 - Flexible Numbers

ENTER STATION NUMBER



- 2. Enter the range of **fixed** station numbers (100-149) to be programmed. If only one station is being programmed, enter that number twice, e.g., [100 100].

|             |  |
|-------------|--|
| <b>Note</b> | If <b>HOLD</b> is pressed without entering a station range, all stations are selected. |
|-------------|--|

-or-

Enter a valid **flexible** number (100-8999) to be programmed.

- 3. Press **HOLD** to save the entry. A confirmation tone sounds and the display updates. Flexible button #19 is lit. The display updates to reflect current programming for Page A:

**Flash 50 - Fixed Numbers**

|   |
|---|
| XXX - XXX PAGE A<br>ENTER BUTTON NUMBER |
|---|

XXX-XXX = fixed station range

**Flash 51 - Flexible Numbers**

|                                    |
|------------------------------------|
| SXXX PAGE A<br>ENTER BUTTON NUMBER |
|------------------------------------|

XXX = 3- or 4-digit flexible number

- 4. Press the **PRIVACY** flexible button (**Button #5**). The following message displays:

|                    |     |
|--------------------|-----|
| PRIVACY<br>ENABLED | 0-1 |
|--------------------|-----|

- 5. Enter a 0 or 1 on the dial pad to enable/disable this feature.  
[0] = Disabled  
[1] = Enabled
- 6. Press **HOLD** to save the entry. A confirmation tone sounds.

|             |  |
|-------------|--|
| <b>Note</b> | Disabling the privacy feature may be limited by federal, state, and local law, so check the relevant laws in your area before disabling privacy. |
|-------------|--|

DEFAULT ... Privacy is enabled for all stations.

SINGLE LINE TELEPHONES

- 1. Enter a 0 or 1 on the dial pad to enable/disable the Camp On feature.  
[0] = No Camp On is allowed  
[1] = Camp On is allowed
- 2. Press **HOLD** to save the entry. A confirmation tone sounds.

**Conditions**

- » Only one station at a time can be programmed when using a flexible station number.
- » When in Flash 51 programming, if you press **HOLD** without specifying a flexible number to be programmed, you will get the station that is in port/station 100.

---

## Private Line

### Description

Private line programming allows certain lines to ring at a specific station only. When placed on Hold, these lines are active at the programmed station only. A private line can be transferred to other stations, provided the station receiving the call has a loop button or direct appearance of that CO line. Refer to [“CO Line Group Programming” on page 2-74](#), [“Line Group Access - Station” on page 2-73](#), and [“Flexible Button Function Assignment” on page 2-163](#).

---

## Recall

### *Answering a Recall*

#### Description

When an outside line remains on hold for an extended period of time, a recalling ring reminder is sent back to the originating station first and if not answered, recalls the Attendant station.

#### Operation

(If Preferred Line Answer is enabled, skip step 1.)

1. Press outside line, Loop or Pool button flashing at very fast rate.
2. Lift handset or press ON/OFF button to converse.

### *Transfer Recall Timer*

#### Description

The Transfer Recall Timer determines the time a transferred call rings at the station receiving the transfer before it recalls the station making the transfer. If unanswered by that station, the call recalls the Attendant. The Transfer Recall Timer setting is variable from 000-300 seconds. A 000 entry disables the timer and there is no recall.

#### Programming Steps

1. Press the TRANSFER RECALL flexible button (**FLASH 01, Button #4**). The following message displays:
2. Enter a valid number on the dial pad that corresponds to 000-300 seconds.

|                 |         |
|-----------------|---------|
| TRANSFER RECALL | 000-300 |
| 045             |         |

3. Press HOLD to save the entry. A confirmation tone sounds and the display updates.

DEFAULT ... Transfer Recall Timer is set for 45 seconds.

---

## Repeat Redial

### Description

The Repeat Redial feature allows a digital key station to press a flexible button and redial a busy or no-answer number after a specific interval. The user is signaled via a queue call back indication.

The RPT REDIAL flexible button flashes at the call back rate of 120 ipm for 15 seconds. If the station:

- Doesn't answer within the 15 seconds, the call back is canceled. The system retains the last call the user made.
- Is busy on an internal/external call when the Redial queue call back occurs, the call back does not occur until the user goes on-hook.

The user must enter a Redial Timer value when invoking this feature. This value is from 006-999 seconds. A 2-minute interval is entered as 120.

### Programming Steps

1. Press the RPT REDIAL flexible button (**FLASH 02, Button #1**). The following message displays:

|            |         |
|------------|---------|
| RPT REDIAL | 006-999 |
| 060        |         |

2. Enter a valid number that corresponds to 006-999 seconds.
3. Press HOLD to save the entry. A confirmation tone sounds and the display updates.

DEFAULT ... Repeat Redial Timer is set for 1 minute (60) and is variable from 006-999 seconds.

### Operation

#### **A keyset station user places a CO call and receives a Busy or No Answer:**

1. Press the preprogrammed RPT REDIAL flexible button [643]. The LCD prompts the user for a timer value.

|                         |         |
|-------------------------|---------|
| ENTER RPT REDIAL TIMER: |         |
| XXX                     | 000-999 |

2. Enter a valid number (000-999 seconds) for the Repeat Redial Timer. Entry of 000 will cancel the Repeat Redial feature. Default value is 060 (one minute). A confirmation tone sounds and the station user goes on-hook. The flexible button LED lights steady.

When the timer expires, the station is signaled via a CO line queue indication on the RPT REDIAL flexible button. During the Queue Call Back, the LCD display indicates this is a Redial Call Back. Once line queue is answered, the LCD indicates an outgoing CO line display.

**To activate a redial:**

Press the preprogrammed REDIAL flexible button,

-or-

Press the ON/OFF button,

-or-

Lift the handset, line is seized and number is dialed. If the user receives a busy/no answer, they may repeat the step to activate another redial.

**To cancel the operation:**

Press the preprogrammed REDIAL flexible button. A confirmation tone sounds and the Auto Redial function is cancelled.



SINGLE LINE TELEPHONE

Not applicable

**Conditions**

- » Once the user presses the preprogrammed flexible button, the timer applies when the user enters a digit. After a digit is entered, the inter-digit timer applies between the digits.

---

## Relay Programming

**Description**

There is one relay on the BKSU that can be programmed to perform certain functions. These functions are loud bell, external page control, RAN start, CO Line control, and door opener.

**Programming Steps**

1. Press **FLASH** and dial **[14]**. Button #1 is lit to indicate Relay #1 is selected. The following message displays:

RELAY 1 TYPE  
YYYYYYYYYYYY

YYYYYYYYYYYY = Ext Page Zone, LBC Sta XXX, Ran Start XX, CO Control XX

2. Enter one of the following sequences on the keypad:
  - [1] + [1] = External Page Zone
  - [2] + [01 through 16] = RAN Start (RAN Announcement Tables 1-16)
  - [3] + STA # = Loud Bell
  - [4] + CO # = CO Line Control
  - [5] = Door Opener
  - [0] = Disables Relay
3. Press HOLD to save the entry. A confirmation tone sounds and the display updates.

## Operation

To activate the Door Opener relay:

Dial feature code 665.

-or-

Press a preprogrammed flexible button that has feature code 665 assigned.

This flexible button will toggle the relay on/off. The flexible button LED will light steady when the relay is open and will be off when the relay is closed.

---

## Remote Administration

### Description

The Remote Administration feature allows authorized personnel to access the administration programming via a terminal device (portable telephone device or personal computer with communications software package).

The feature permits the review and entry of the customer database in the same manner as via the digital telephone. The terminal device can be connected directly to the RS-232C connector on the Main Board Unit (MBU) on the STSe, or can be accessed by a telephone modem linking the RS-232C connector (via a CO line) to a remote location. When entering the system remotely via a terminal device, access to the 9600 baud modem is available.



*The recommended connection rate is 4800 baud when using a modem.*

### Program Mode Entry

Refer to [“Program Mode Entry \(Data Terminal or PC\)” on page E-6](#).

### Modem Answer Timer

#### Description

The Modem Answer Timer determines how long the On Board modem provides a carrier tone to a distant modem. If a connection is not made at the end of this timer, the On Board modem hangs up.

The Modem Answer Timer setting is variable from 25-999 seconds.

#### Programming Steps

1. Press the MODEM ANSWER TIMER flexible button (**FLASH 02, Button #4**). The following message displays:

|                  |         |
|------------------|---------|
| MODEM ANSWER T/O | 025-999 |
| 25               |         |

2. Enter a valid number on the dial pad that corresponds to 025-999 seconds.
3. Press HOLD to save the entry. A confirmation tone sounds and the display updates.  
DEFAULT ... Modem Answer Timer is set for 25 seconds.

## *Database Upload/Download*

### **Description**

Database Upload/Download provides a maintenance facility which is added to the Remote Administration routine. This routine permits downloading of the database to a PC, when a software change is made or when the system must be initialized and reprogrammed.

The routine facilitates the programming of a database on an in-house system which can be downloaded to a PC, and then uploaded to a system in the field. After the system maintenance is completed, the file saved in the PC can then be uploaded to the system.

Refer to *"Database Upload/Download Routine" on page E-7* for detailed instructions.

---

## **Remote System Monitor And Maintenance**

### *Maintenance*

#### **Description**

The Remote Maintenance feature allows the Interconnects' technical staff to review the system configuration data and individual card slot configuration data. This can be done on-site using a data terminal or remotely using a modem to access a remote data terminal.

When entering the system remotely via a terminal device, access to the 9600 baud modem is available.

### *Monitor*

#### **Description**

The Remote Monitor feature provides remote access to the installed system for diagnostic purposes. These capabilities benefit Service personnel enabling them to support the end user remotely. Different levels of access, via password, allows authorized personnel to trace, monitor, and up-load critical information directly from the STSe. This provides a more accurate means of acquiring system information that leads to a quick resolution of problems that may occur. This is all done without interfering with ongoing call processing or normal system operation, and in many cases may be performed without a site visit.

Capabilities reserved for this high-level troubleshooting also include:

- Monitor Mode
- Enable and Disable Event Trace
- Dump Trace Buffer (Up-Load)

---

## Ring Down / Hot Line / Off-Hook Preference

### Description

The Off-Hook Preference feature can be used by both keyset station users and SLT station users. The next two sections describe the feature with respect to how it applies to a keyset user and then as to how it applies to the SLT user.

### Keyset Users

The Off-Hook Preference feature lets a keyset station user automatically have the function of a designated flex button applied when going off-hook or when pressing the ON/OFF button. If allowed in the following described programming, keyset station users can select and/or change their off-hook preference through the use of a dial code [691]+BB (01-24). Dialing [691]+00 disables Off-Hook Preference.

Auto Feature Access -- In addition to Auto Line Access, digital telephones have the ability to have their off-hook preference select a DSS or feature button upon going off-hook or pressing the ON/OFF button.

Auto Line Access -- Each keyset station may have their phone programmed to access a particular CO Line (such as a private line or a line from a group of CO lines) upon going off-hook. This is useful in Centrex or PBX applications when station users have dedicated lines. Outside line dial tone is received just by going off-hook, without the need to dial an access code.

Hot Line/Ring Down -- Each keyset station may be programmed to immediately call or ring down a particular station or outside number upon going off hook. This is done by programming the station's Off-Hook Preference to activate a DSS or Speed Dial feature key. This feature can be overridden if the station user selects a CO line first when going off-hook.

Intercom Access -- When Off-Hook Preference is enabled for a keyset station, that station may still obtain intercom dial tone for accessing internal stations or other system features. This is done either by pressing a DSS button or by dialing their own intercom station number prior to going off-hook.

User Programmable Preference -- Based on a station programmable option, digital telephones may be given the ability to enable, disable, or change their Off-Hook Preference by dialing a code. This option can be denied in station programming on a per key station basis.

Use Flash 50 programming when you want to modify a range of stations' attributes using **fixed** station numbers.

Use Flash 51 programming to modify a single station's attributes using a **flexible** station number.

### SLT Users

The Off-Hook Preference feature lets an SLT station user have one of the following functions applied when going off-hook or when pressing the ON/OFF button.

- |   |  |   |   |
|---|--|---|---|
| <input type="checkbox"/> CO Line Access       | <input type="checkbox"/> LCR               | <input type="checkbox"/> Call to Hunt Group | <input type="checkbox"/> Call to Voice Mail |
| <input type="checkbox"/> CO Line Group Access | <input type="checkbox"/> Call to a station | <input type="checkbox"/> Call to UCD Group  |   |

After enabling Off-Hook Preference for an SLT in the following described programming, it is necessary to program the function to be applied when going off-hook. To program this, refer to ["To assign an Off-Hook Preference function for an SLT:" on page 2-166.](#)

An SLT user can press the FLASH button and dial their own number to override Off-Hook Preference and gain intercom access.

Use Flash 50 programming when you want to modify a range of stations' attributes using **fixed** station numbers.

Use Flash 51 programming to modify a single station's attributes using a **flexible** station number.

### Programming Steps

1. Press **FLASH** and dial **[50]** or dial **[51]**. Flexible button #24 (New Range) is lit and one of the following messages displays:

#### Flash 50 - Fixed Numbers

STATION ATTRIBUTES  
SELECT A STATION RANGE

#### Flash 51 - Flexible Numbers

ENTER STATION NUMBER

2. Enter the range of **fixed** station numbers (100-149) to be programmed. If only one station is being programmed, enter that number twice, e.g., [100 100].

 **Note** If HOLD is pressed without entering a station range, all stations are selected.

-or-

Enter a valid **flexible** number (100-8999) to be programmed.

3. Press HOLD to save the entry. A confirmation tone sounds and the display updates. Flexible button #19 is lit. The display updates to reflect current programming for Page A:

#### Flash 50 - Fixed Numbers

XXX - XXX PAGE A  
ENTER BUTTON NUMBER

XXX-XXX = fixed station range

#### Flash 51 - Flexible Numbers

SXXX PAGE A  
ENTER BUTTON NUMBER

XXX = 3- or 4-digit flexible number



- Press button #20. The display updates to reflect current programming for Page B.

**Flash 50 - Fixed Numbers**

```
XXX - XXX PAGE B
ENTER BUTTON NUMBER
```

*XXX-XXX = fixed station range*

**Flash 51 - Flexible Numbers**

```
SXXX PAGE B
ENTER BUTTON NUMBER
```

*XXX = 3- or 4-digit flexible number*

- Press the OFF-HOOK PREF flexible button (**Button #10**). The following message displays:

```
OFF HOOK PREFERENCE BTN  XXY
00 ENABLED
```

- Enter a valid button number (01–24) or (00) to indicate no specific button is preferred. (SLTs use [01] to enable or [00] to disable.)
- Enter a 0 or 1 to disable/enable the Off-Hook Preference as follows:
  - [0]= Disables programmable preference so users may not change the off-hook preference as set in programming. Also use for SLT stations.
  - [1]= Enables programmable preference to key station users so that they may change the off-hook preference through a user dial code.
- Press HOLD. A confirmation tone sounds and the display updates.

DEFAULT ... The STSe telephone can change its preference, but no button is assigned (00).

**Operation**

If your phone has been programmed for Off-Hook Preference, you can access an outside line, or a feature by going off-hook or pressing the ON/OFF button. It simulates the depression of a specific button and can be programmed by a station user or a database administration programmer using code [691] + the button number.

**While Off-Hook Preference is enabled, you may access internal intercom dial tone as follows:**

- Press the preprogrammed ICM button,  
-or-  
Dial your intercom number. (Do not lift handset or press ON/OFF button before dialing intercom number.) LED lights steady and intercom dial tone sounds.
- Dial an internal station or feature access code.

**Off-Hook Preference Programming (Via a Station)**

If your phone is programmed for Off-Hook Preference and you were given the ability to enable or change the prime flexible button:

- Dial [691] on the dial pad.
- Dial the desired button number.

**To disable Off-Hook Preference:**

1. Dial [691] on the dial pad.
2. Dial [00] on the dial pad.



## SINGLE LINE TELEPHONES

After enabling Off-Hook Preference for SLT stations, it is necessary to program the function to be applied when going off-hook. To program this, refer to [“To assign an Off-Hook Preference function for an SLT:” on page 2-166](#).

An SLT user can press the FLASH button and dial their own number to override Off-Hook Preference and gain intercom access.

**Conditions**

- » Only one station at a time can be programmed when using a flexible station number.
- » When in Flash 51 programming, if you press HOLD without specifying a flexible number to be programmed, you will get the station that is in port/station 100.

---

## Save Number Redial (SNR)

**Description**

Any number dialed on an outside line can be saved permanently and used at any time. This number is saved until a new number is stored.

**Operation****To save the last number dialed, either:**

1. After placing an outside call, keep handset off-hook.
2. Press the SPEED button twice.

-or-

Use the Soft Key's STORE NO option.

**To dial a number that was saved (using the steps above), either:**

Press the SPEED button, then dial the [\*] button.

-or-

Use the Soft Key's SNR option when in an idle condition.

- System automatically selects the original line used to place the call and redials the number.
- If that line is busy, the system automatically selects another line from the same group and redials the number.
- If no lines are available in the same group, the station receives busy tone and can queue for a line.
- If the station user preselects a line before activating SNR, the preselection overrides the line originally used.



SINGLE LINE TELEPHONE

Not applicable

---

## School Zone

### Description

The School Zone feature allows a person at a station(s) specified as an Administrator to control incoming calls for all stations specified as a Classroom. The Administrator controls the type of call forwarding and the call forwarding destination. Call forwarding types include All Call Forward, No Answer Call Forward, Busy Call Forward, and Busy / No Answer Call Forward. Valid call forwarding destinations include station numbers, hunt groups, UCD groups, and Voice Mail groups.

Stations to be included as part of the School Zone feature must be assigned in Admin programming as either an Administrator station or as a Classroom station. After these assignments have been established, the Administrator can easily control call forwarding for the specified Classroom stations by using feature code 630.

School Zone call forwarding can also be controlled through the use of FLASH 09 in administrative programming.

### Programming Steps

#### SCHOOL ZONE STATION ASSIGNMENTS

1. Press **FLASH** and dial **[50]** or dial **[51]**. Flexible button #24 (New Range) is lit and one of the following messages displays:

#### Flash 50 - Fixed Numbers

STATION ATTRIBUTES  
 SELECT A STATION RANGE

#### Flash 51 - Flexible Numbers

ENTER STATION NUMBER

2. Enter the range of **fixed** station numbers (100-149) to be programmed. If only one station is being programmed, enter that number twice, e.g., [100 100].

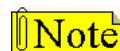

If **HOLD** is pressed without entering a station range, all stations are selected.

-or-

Enter a valid **flexible** number (100-8999) to be programmed.

---



---

*Features and Operation*

- Press HOLD to save the entry. A confirmation tone sounds and the display updates. Flexible button #19 is lit. The display updates to reflect current programming for Page A:

**Flash 50 - Fixed Numbers**

|   |
|---|
| XXX - XXX PAGE A<br>ENTER BUTTON NUMBER |
|---|

*XXX-XXX = fixed station range*

**Flash 51 - Flexible Numbers**

|                                    |
|------------------------------------|
| SXXX PAGE A<br>ENTER BUTTON NUMBER |
|------------------------------------|

*XXX = 3- or 4-digit flexible number*

- Press button #20. The display updates to reflect current programming for Page B.

**Flash 50 - Fixed Numbers**

|   |
|---|
| XXX - XXX PAGE B<br>ENTER BUTTON NUMBER |
|---|

*XXX-XXX = fixed station range*

**Flash 51 - Flexible Numbers**

|                                    |
|------------------------------------|
| SXXX PAGE B<br>ENTER BUTTON NUMBER |
|------------------------------------|

*XXX = 3- or 4-digit flexible number*

- Press the SCHOOL ZONE flexible button (**Button #7**). The following message displays:

|                         |     |
|-------------------------|-----|
| SCHOOL ZONE<br>DISABLED | 0-2 |
|-------------------------|-----|

- Dial a valid number (0-2) to assign a station as an Administrator, Classroom, or as neither.

*0 = Disabled (neither Administrator or Classroom)*

*1 = Administrator*

*2 = Classroom*

- Press [HOLD]. A confirmation tone sounds.

DEFAULT ... All stations are disabled (not assigned as an Administrator or a Classroom).

## CONTROL SCHOOL ZONE CALL FORWARDING

- Press **FLASH** and dial **[09]**.
- Press the SCHOOL MODE flexible button (**Button #10**). The following message displays:

|                         |               |
|-------------------------|---------------|
| SCHOOL MODE<br>DISABLED | 0, 6, 7, 8, 9 |
|-------------------------|---------------|

- Dial a valid call forwarding condition code (0 or 6-9).

*0 = Disabled*

*8 = Busy Call Forward*

*6 = All Call Forward*

*9 = Busy / No Answer Call Fwd*

*7 = No Answer Call Forward*

- Press [HOLD]. A confirmation tone sounds.

- Press the SCHOOL FORWARD DEST flexible button (**Button #11**). The following message displays:

SCHOOL FORWARD DEST  
####

- Enter a valid destination number. Valid entries include station numbers, hunt groups, UCD groups, and Voice Mail groups.
- Press [HOLD]. A confirmation tone sounds.

DEFAULT ... The School Mode is Disabled (0) and the School Forward Destination is not assigned (####).

### Operation

#### **To control School Zone call forwarding (at an Administrator station):**

- Dial [630] + a call forward condition code (0 or 6-9) + a valid destination number

**Call Forward Condition Codes:**

- 0 = Disabled
- 6 = All Call Forward
- 7 = No Answer Call Forward
- 8 = Busy Call Forward
- 9 = Busy / No Answer Call Fwd

**Valid Destinations:**

- Station Numbers
- Hunt Groups
- UCD Groups
- Voice Mail Groups

- Press [HOLD]. A confirmation tone sounds.

#### **To view the call forwarding status of Classroom telephones:**

- The Administrator uses a station assigned as an Administrator station and dials feature code [630] + [#]. Confirmation tone sounds and LCD shows one of the following:

CLASSROOM STATUS  
DISABLE

CLASSROOM STATUS  
BSY FWD TO XXXX

CLASSROOM STATUS  
NA FWD TO XXXX

CLASSROOM STATUS  
B/NA FWD TO XXXX

CLASSROOM STATUS  
FWD TO XXXX

- Press [ON/OFF] to return to an idle status.

### Conditions

- » A station can be assigned as an Administrator or as a Classroom, but not as both.
- » A call from an Administrator station to a Classroom station overrides any School Zone call forward settings and the call rings at the Classroom station.
- » School Zone call forwarding overrides station user call forwarding and DND.
- » If an E-911 button is programmed, both audible and visual alert indications will be provided, regardless of School Zone call forward settings.
- » The School Zone call forwarding feature does not apply to a Classroom station that is in a hunt group or a UCD group.

---

## Single Line Telephone

### Compatibility

#### Description

The STSe supports industry standard 2500-type (DTMF) single line telephone (SLT) instruments. When the Circuit Single Line Interface Board (CSIB) is installed in the STSe, a maximum of 24 single telephones can be supported.

### SLT DTMF Receiver Timer

#### Description

Single line telephones require the use of a DTMF receiver when going off-hook and dialing. When SMDR or toll restriction (via COS assignments) is enabled, a DTMF receiver monitors and screens the SLT digits for the duration of this timer. By adjusting this timer, the system administrator may free system DTMF receivers sooner if system SLT traffic is heavy, or provide a longer monitoring period if toll restriction becomes a problem.

Note that when LCR is enabled, the DTMF receivers are released when the expected number of digits are dialed as entered in the LCR database.

The SLT DTMF Receiver Timer setting is variable from 005-100 seconds.

#### Programming Steps

1. Press the SLT DTMF RECEIVER TIMER flexible button (**FLASH 01, Button #12**). The following message displays:

|                |         |
|----------------|---------|
| SLT RCVR TIMER | 005-100 |
| 020            |         |

2. Enter a valid number that corresponds to 005–100 seconds.
3. Press HOLD to save the entry. A confirmation tone sounds and the display updates.

DEFAULT ... SLT DTMF Receiver Timer is set at 20 seconds.

### SLT Hook Flash Timer

#### Description

The SLT Hook Flash Timer determines how long an SLT user presses the hook switch for it to be considered a valid on hook (disconnect) request. An on-hook shorter in duration (but longer than the Hook Switch Bounce Timer) is considered a Hook Flash (transfer) request. Refer to [Figure 2-21 on page 2-271](#).

The SLT Hook Flash Timer setting is variable from 0.5-2.0 seconds.



Some SLTs have a fixed or programmable Flash Timer (Flash or Tap button). This Hook Switch Timer must be set longer than the SLT Flash Timer to allow Hook Flash transfer.

#### Programming Steps

1. Press the SLT HOOK FLASH TIMER button (**FLASH 01, Button #14**)

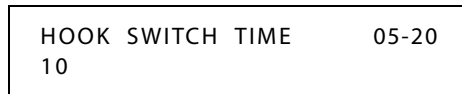

2. Enter a valid number that corresponds to 0.5-2.0 seconds in 1/10 second increments.
3. Press HOLD to save the entry. A confirmation tone sounds and the display updates.

DEFAULT ... SLT Hook Flash Timer is set at 10 (one second).

### SLT Hook Flash Bounce Timer

#### Description

The SLT Hook Flash Bounce Timer determines the time needed to determine a valid on-hook or off-hook condition for single line telephones. On-Hook or Off-Hook signals that are shorter in duration than this timer are ignored by the system. Refer to [Figure 2-21](#).

The SLT Hook Flash Bounce Timer setting is variable from 0-1 seconds in 10 ms increments. This is a 3-digit entry where 010 equals 0.1 seconds.

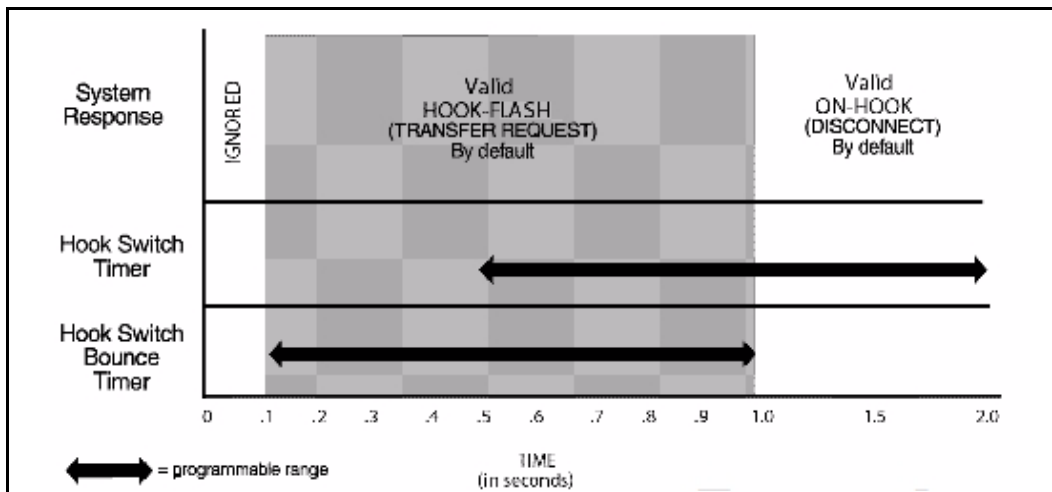

Figure 2-21: Hook Switch Activity

## Programming Steps

1. Press the SLT HOOK FLASH BOUNCE TIMER flexible button (**FLASH 01, Button #15**). The following message displays:

|                 |         |
|-----------------|---------|
| HOOK SWT BOUNCE | 000-100 |
| 030             |         |

2. Enter a valid number that corresponds to 0-1 seconds in 10 ms increments.
3. Press HOLD to save the entry. A confirmation tone sounds and the display updates.

DEFAULT ... SLT Hook Flash Bounce Timer is set to 0.30 seconds.

---

## Software Version (MBU)

### Description

The current system software version of the Main Board Unit (MBU) can be viewed. The display shows the version number and level of software.

### Operation

To view the Software Version Display:

Dial the S/W Display code [605] on the dial pad. The top line of the LCD shows the engineering version of the software. The bottom line of the LCD shows the features that are enabled for your software, e.g., BASIC.

### Conditions

- » The station must be an LCD type to view the information.

---

## Speakerphone

STSe Digital Telephones are equipped with a speakerphone.

### *Speakerphone Options*

#### Description

The speakerphone can be programmed to work in one of three ways:

- Normal speakerphone operation.
- Disabled for outgoing and incoming CO calls, but handsfree on intercom allowed.
- Headset operation allowed.

Use Flash 50 programming when you want to modify a range of stations' attributes using **fixed** station numbers.

Use Flash 51 programming to modify a single station's attributes using a **flexible** station number.



### Programming Steps

1. Press **FLASH** and dial **[50]** or dial **[51]**. Flexible button #24 (New Range) is lit and one of the following messages displays:

**Flash 50 - Fixed Numbers**

STATION ATTRIBUTES  
SELECT A STATION RANGE

**Flash 51 - Flexible Numbers**

ENTER STATION NUMBER

2. Enter the range of **fixed** station numbers (100-149) to be programmed. If only one station is being programmed, enter that number twice, e.g., [100 100].

 **Note** If **HOLD** is pressed without entering a station range, all stations are selected.

-or-

Enter a valid **flexible** number (100-8999) to be programmed.

3. Press **HOLD** to save the entry. A confirmation tone sounds and the display updates. Flexible button #19 is lit. The display updates to reflect current programming for Page A:

**Flash 50 - Fixed Numbers**

XXX - XXX PAGE A  
ENTER BUTTON NUMBER

*XXX-XXX = fixed station range*

**Flash 51 - Flexible Numbers**

SXXX PAGE A  
ENTER BUTTON NUMBER

*SXXX = 3- or 4-digit flexible number*

4. Press button #20. The display updates to reflect current programming for Page B.

**Flash 50 - Fixed Numbers**

XXX - XXX PAGE B  
ENTER BUTTON NUMBER

*XXX-XXX = fixed station range*

**Flash 51 - Flexible Numbers**

SXXX PAGE B  
ENTER BUTTON NUMBER

*SXXX = 3- or 4-digit flexible number*

5. Press the **SPEAKERPHONE** flexible button (**Button #4**). The following message displays:

SPEAKERPHONE                      0-4  
FULL SPEAKERPHONE

*Features and Operation*

6. Enter a valid number (0-4) on the dial pad to identify the speakerphone operation.
  - [0] = Works as normal speakerphone. Full speakerphone capabilities on CO lines and Intercom.
  - [1] = Speakerphone enabled for intercom calls only. Speakerphone capabilities disabled for outgoing CO line calls (monitoring and on-hook dialing are still permitted).
  - [2] = Permits toggling of speakerphone and headset operation via [634] Headset code.
  - [3] = Forces the telephone to always ring in the tone intercom mode.
  - [4] = Forces the telephone to the hand-free intercom mode always.
7. Press HOLD to save the entry. A confirmation tone sounds.

DEFAULT ... All stations are assigned an ID of 0 (Full Speakerphone).

**Conditions**

- » Only one station at a time can be programmed when using a flexible station number.
- » When in Flash 51 programming, if you press HOLD without specifying a flexible number to be programmed, you will get the station that is in port/station 100.

*Speakerphone Operation***Description**

The Speakerphone feature allows you to conduct a conversation without lifting the handset. Speakerphone volume can be adjusted as desired.

**Operation**

1. Press ON/OFF button to ON. Intercom dial tone sounds.
2. Press the Volume Bar to change the tone volume. The following message displays:

|              |          |
|--------------|----------|
| SPEAKER TONE | [#####]  |
| MMM DD YY    | HH:MM am |

3. Press the party's DSS button, or press an available outside line button and dial the number. Speakerphone is activated.
4. Press ON/OFF button to OFF to end the call.

|   |   |
|---|---|
|  <b>Note</b> | <i>Where lift handset is specified, you may also press the ON/OFF button, if the telephone is programmed as a two-way speakerphone.</i> |
|---|---|



SINGLE LINE TELEPHONE

Not applicable

---

## Speed Dial

### *Station Speed Dial Numbers*

#### **Description**

A keyset user can associate up to 20 frequently dialed numbers as Station Speed Numbers (9000-9019). Telephone numbers can be up to 24 digits including pauses, flash commands, pulse-to-tone switchover, and no-display characters. A pause is automatically inserted after a flash. There are 100 speed locations (Station/System) available in STSe systems.

#### **Operation**

##### **To use speed dial:**

1. If an outside line was not specified in programming, one can be selected now or the system assigns the line.
2. Press the SPEED button and dial speed bin location,  
-or-  
Press the preprogrammed speed bin button,  
-or-  
Use the Soft Key's SPD option and dial a speed bin location when in an idle condition.

##### **To store speed dial numbers:**

1. Press the SPEED button once.
2. Press an OUTSIDE LINE button or POOL button.  
-or-  
Select an outside line automatically by pressing the SPEED button again.
3. Dial the speed bin location.
4. Dial the desired telephone number and include these special codes:  
TRANS -- Initiates a Pulse-To-Tone switchover.  
HOLD -- Inserts a Pause.  
FLASH -- Inserts a Flash into the speed number.  
TRANS -- When used as the first entry in the speed bin, this inserts a no-display character causing numbers stored in the bin not to appear on the digital telephone's display when bin is accessed.

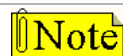

Many Centrex codes utilize a hook-flash followed by, in many cases, the digit [\*] and or [#]. The STSe allows programming of these codes as a part of system or station speed dial sequences.

5. Press the SPEED button.
6. Replace the handset or press ON/OFF to end the speed bin programming.

**To program multiple speed numbers:**

1. Press the SPEED button twice to conclude programming a number.
2. Enter the next speed number bin to program.

If the station has no line appearance for the line programmed into the speed bin, that line comes up under the LOOP button or POOL button when accessed.

**To erase an existing speed bin:**

1. Press the SPEED button twice.
2. Dial the speed bin location.
3. Press the SPEED button again. A confirmation tone sounds.



SINGLE LINE TELEPHONE

**To use speed dial:**

1. Lift handset, then dial [668] on the dial pad.
2. Dial desired station or system speed bin number (9000-9099).
3. Replace the handset to end the call.

**To store speed dial numbers:**

1. Lift handset, then dial [661] on the dial pad.
2. Dial desired station speed number (9000-9019).
3. Dial telephone number to store.
4. Press the FLASH button. A confirmation tone sounds.

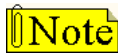

Line Group 1 is programmed along with SLT speed numbers, and thus Line Group 1 is used when activating station speed dial from an SLT.

## System Speed Dial Access

### Description

Stations can be individually allowed or denied the ability to use system speed dial numbers (9020-9099). (System speed numbers 9060-9099 are not monitored by toll restriction.) Stations cannot be prevented from using station speed dial.

The first programmed Attendant must enter the System Speed numbers. If an Attendant was not specified, system speed numbers are entered at Station 100.

Use Flash 50 programming when you want to modify a range of stations' attributes using **fixed** station numbers.

Use Flash 51 programming to modify a single station's attributes using a **flexible** station number.

## Programming Steps

1. Press **FLASH** and dial **[50]** or dial **[51]**. Flexible button #24 (New Range) is lit and one of the following messages displays:

### Flash 50 - Fixed Numbers

STATION ATTRIBUTES  
SELECT A STATION RANGE

### Flash 51 - Flexible Numbers

ENTER STATION NUMBER

2. Enter the range of **fixed** station numbers (100-149) to be programmed. If only one station is being programmed, enter that number twice, e.g., [100 100].



If **HOLD** is pressed without entering a station range, all stations are selected.

-or-

Enter a valid **flexible** number (100-8999) to be programmed.

3. Press **HOLD** to save the entry. A confirmation tone sounds and the display updates. Flexible button #19 is lit. The display updates to reflect current programming for Page A:

### Flash 50 - Fixed Numbers

XXX - XXX PAGE A  
ENTER BUTTON NUMBER

*XXX-XXX = fixed station range*

### Flash 51 - Flexible Numbers

SXXX PAGE A  
ENTER BUTTON NUMBER

*XXX = 3- or 4-digit flexible number*

4. Press the **SPEED** flexible button (**Button #6**). The following message displays:

SYSTEM SPEED                      0-1  
ENABLED

5. Enter a 0 or 1 on the dial pad to enable/disable this feature.  
[0] = Disabled  
[1] = Enabled
6. Press **HOLD** to save the entry. A confirmation tone sounds.

DEFAULT ... System Speed Dialing is enabled at all stations.

## Operation

The first programmed Attendant uses the same procedures to store system speed dial numbers, program multiple speed dial numbers, and to erase existing speed bins as described in the operation of station speed dial numbers.

**Conditions**

- » Only one station at a time can be programmed when using a flexible station number.
- » When in Flash 51 programming, if you press HOLD without specifying a flexible number to be programmed, you will get the station that is in port/station 100.

***Speed Bins - Chaining*****Description**

Speed dial bins can be chained together. This is helpful for accessing Long Distance carriers or banking services when account codes are required.

**Operation**

To chain speed bins together, simply press one speed bin and then another as required.

***Initialize System/Station Speed Numbers*****Description**

System and Station Speed bins may be initialized to reset all bins to their original default value (empty). All bins 9000-9099 are reset to their default value (empty) upon initializing.

**Programming Steps**

1. Press the SPEED NO flexible button (**FLASH 80, Button #6**). The following message displays:

INITIALIZE SYS SPEED NO  
PRESS HOLD

2. Press the HOLD button. A confirmation tone sounds.

## Print System Speed Numbers

### Description

The System Speed Numbers command dumps the entire database as a permanent record which can serve as a hardcopy of the database. The system baud rate must match that of the printer or receiving device.

```

SYSTEM SPEED NUMBERS
20                               37
21                               38
22                               39
23                               40
24                               41
25                               42
26                               43
27                               44
28                               45
29                               46
30                               47
31                               48
32                               49
33                               50
34                               51
35                               52
36                               ... and so on through Speed Number 99

```

**Figure 2-22: System Speed Numbers Printout**

### Programming Steps

1. Press the SYSTEM SPEED flexible button (**FLASH 85, Button #6**). The following message displays:

```

PRINT SYS SPEED NO
PRESS HOLD

```

2. To print the System Speed bins, press the HOLD button. The following message displays:

```

PRINTING SYS SPEED NO

```

When the system finishes sending the requested information to the printer, a confirmation tone sounds.

## Station Attributes

### Initialize Station Attributes

#### Description

The Station Parameters may be initialized setting all data fields to their original, default values. The following data fields are returned to their default value upon initializing the Station Attributes.

**Table 2-23: Station Attribute Defaults**

| Program Code          | Flexible Button | Features                                | Default Value (after initialization)     |
|-----------------------|-----------------|---|--|
| FLASH 50/51<br>PAGE A | 1               | Paging Access                           | Enabled                                  |
|                       | 2               | Do Not Disturb                          | Enabled                                  |
|                       | 3               | Conference Enable/Disable (Per Station) | Enabled                                  |
|                       | 4               | Executive Override                      | Disabled                                 |
|                       | 5               | Privacy (Per Station)                   | Enabled                                  |
|                       | 6               | System Speed Dial Access                | Enabled                                  |
|                       | 7               | Line Queuing                            | Enabled                                  |
|                       | 8               | Preferred Line Answer                   | Enabled                                  |
|                       | 9               | Off-Hook Voice Over (OHVO)              | Disabled                                 |
|                       | 10              | Call Forwarding                         | Enabled                                  |
|                       | 11              | Forced Least Cost Routing               | Disabled                                 |
|                       | 13              | Executive Override Blocking             | Disabled                                 |
|                       | 14              | CO Line Ringing Options                 | Muted Ring                               |
|                       | 15              | Name/Number Display at Idle             | Name (Enabled)                           |
|                       | 17              | CO, Loop, Pool                          | Disabled                                 |
| 18                    | Admin Access    | Disabled                                |  |
| FLASH 50/51<br>PAGE B | 1               | Station Identification                  | 0 (STSe 24-Btn Keypad)<br>6 (SLT w/o MW) |
|                       | 2               | Station Day Class of Service (COS)      | COS 1                                    |
|                       | 3               | Station Night Class of Service (COS)    | COS 1                                    |
|                       | 4               | Speakerphone/Headset Programming        | 0=Full Speakerphone                      |
|                       | 5               | Pick-Up Group(s) Programming            | Group 1                                  |
|                       | 6               | Paging Zone(s) Programming              | Zone 1                                   |
|                       | 7               | School Zone                             | Disabled                                 |
|                       | 8               | Line Group Access - Station             | Group 1                                  |
|                       | 9               | LCR Class of Service (COS)              | 0 (Unrestricted Access)                  |
|                       | 10              | Off-Hook Preference Programming         | 00=No specific button preferred; Enabled |
|                       | 11              | Flexible Button Programming             | (blank)                                  |
|                       | 12              | Keypad Mode                             | Inactive Mode                            |



Table 2-23: Station Attribute Defaults

| Program Code          | Flexible Button | Features                                  | Default Value (after initialization) |
|-----------------------|-----------------|---|--------------------------------------|
|                       | 13              | Voice Mail ID Translation                 | XXXX=Station #                       |
|                       | 14              | Display Flexible Buttons                  | None                                 |
|                       | 15              | Light Control                             | 0=None                               |
|                       | 17              | Cordless Key Telephone Unit (CKTU) Button | 00=No button assigned                |
|                       | 18              | Headset Mode                              | 1=2.5 mm jack                        |
| FLASH 50/51<br>PAGE C | 1               | Internal No Answer Forward                | None                                 |
|                       | 2               | Internal Busy/DND Forward                 | None                                 |
|                       | 3               | Day External No Answer Forward            | None                                 |
|                       | 4               | Day External Busy/DND Forward             | None                                 |
|                       | 5               | Day No Answer Timer                       | 10 sec                               |
|                       | 7               | SLT Loop Supervision                      | Enabled                              |
|                       | 13              | Distinctive Ring Tone - Station           | 00                                   |
|                       | 14              | Night External No Answer Forward          | None                                 |
|                       | 15              | Night External Busy/DND Forward           | None                                 |
|                       | 16              | Special External No Answer Forward        | None                                 |
|                       | 17              | Special External Busy Forward             | None                                 |
|                       | 18              | Call Coverage Ring Timer                  | 05 sec                               |
| FLASH 50/51<br>PAGE D | 1               | Tenant Group Assignments                  | Group 0                              |
|                       | 3               | Internal DND Forward                      | None                                 |
|                       | 4               | External DND Forward                      | None                                 |
|                       | 5               | Night No Answer Timer                     | 10 sec                               |
|                       | 6               | Special No Answer Timer                   | 10 sec                               |
|                       | 7               | Back Light Display                        | 0 = Off                              |

### Programming Steps

1. Press the STATION ATTRIBUTES flexible button (**FLASH 80, Button #3**). The following message displays:

|   |
|---|
| <p>INITIALIZE STATIONS<br/>PRESS HOLD</p> |
|---|

2. Press the HOLD button. A confirmation tone sounds.

## Print Station Attributes

### Description

The Print Station Attributes command can be used to print specific flexible station parameters or to print the entire database in fixed number order.

The Print Station Attributes command can dump the entire database as a permanent record which can serve as a hardcopy of the database. The system baud rate must match that of the printer or receiving device.

When printing the Station attributes the following data prints:

>>> All Current Station Parameters

```

STATION ATTRIBUTES
STA 100                                     STA 101

PAGE ACCESS                               ENABLED          PAGE ACCESS          ENABLED
DO NOT DISTURB                            ENABLED          DO NOT DISTURB      ENABLED
CONFERENCE                                ENABLED          CONFERENCE          ENABLED
EXEC OVERRIDE                             DISABLED         EXEC OVERRIDE       DISABLED
PRIVACY                                    ENABLED          PRIVACY             ENABLED
SYSTEM SPEED                              ENABLED          SYSTEM SPEED        ENABLED
LINE QUEUING                              ENABLED          LINE QUEUING        ENABLED
PREF LINE ANSWER                          DISABLED         PREF LINE ANSWER    DISABLED
OFF HOOK VOICE OVER                       DISABLED         OFF HOOK VOICE OVER DISABLED
CALL FORWARD                              ENABLED          CALL FORWARD        ENABLED
FORCE LCR                                  DISABLED         FORCE LCR            DISABLED
EXEC OVERRIDE BLOCK                       DISABLED         EXEC OVERRIDE BLOCK DISABLED
CO RING OPTIONS                            MUTED RING      CO RING OPTIONS     MUTED RING
NAME AT IDLE LCD                          EXT NUMBER      NAME AT IDLE LCD    EXT NUMBER
STATION ID                                 KEYSET - STSE 24BTN STATION ID          KEYSET - STSE 24BTN
CO LOOP POOL FLEX                          DISABLED         CO LOOP POOL FLEX   DISABLED
DAY COS                                    1              DAY COS             1
NIGHT COS                                  1              NIGHT COS           1
SPEAKERPHONE                              FULL SPEAKERPHONE SPEAKERPHONE        FULL SPEAKERPHONE
PICKUP GROUPS                             1              PICKUP GROUPS       1
PAGE ZONE                                   1              PAGE ZONE            1
INTERNAL NO ANSWER                        #####          INTERNAL NO ANSWER  #####
INTERNAL BUSY                              #####          INTERNAL BUSY       #####
EXTERNAL NO ANSWER                        #####          EXTERNAL NO ANSWER #####
EXTERNAL BUSY                              #####          EXTERNAL BUSY       #####
NO ANSWER TIMER                           10             NO ANSWER TIMER    10
LINE GROUP ACCESS                         1              LINE GROUP ACCESS   1
LCR CLASS OF SERVICE                      0              LCR CLASS OF SERVICE 0
OFFHOOK PREFERENCE BTN                    00 ENABLED     OFFHOOK PREFERENCE BTN 00 ENABLED
KEYSET MODE                               INACTIVE MODE 2400 KEYSET MODE          INACTIVE MODE 2400
VOICE MAIL ID                              100           VOICE MAIL ID       101
CORDLESS KEY BTN 00                       NONE           CORDLESS KEY BTN 00 NONE
BUTTONS:
01S0100 02S0101 03S0102                 BUTTONS:
04S0103 05S0104 06S0105                 01S0100 02S0101 03S0102
07S0106 08S0107 09S0108                 04S0103 05C0201 06C0202
10S0109 11S0110 12S0111                 07LOOP 08PL03 09CBAK
13L001 14L002 15L003                    10PKUP 11DND 12LINEQ
16L004 17L005 18L006                    13L001 14SPD 15UNA
19LOOP 20PL01 21CBAK                     16ICM 17VMREC 18HFREE
22PKUP 23DND 24LINEQ                     19LNR 20SLGIN 21SLOUT
25FLASH 26XFER 27SPEED                   22PKUP 23RPARK 24MUSIC
28CONF 29MSG 30FWD
31MUTE 32CAMP 33MON
34HOLD 35VOL 36VOL

... and so on through all stations

```

Figure 2-23: Station Attributes Printout

## Programming Steps

1. Press the STATION ATTRIBUTES flexible button (**FLASH 85, Button #3**). The following message displays:

PRINT STATIONS  
PRESS HOLD

2. To print data for:
  - All stations, press HOLD.
  - One station, enter the flexible station number, then press HOLD.

Then the following message displays and the requested information prints:

PRINTING STATIONS

When the system finishes sending the requested information to the printer, a confirmation tone sounds.

---

## Station Identification

### Description

Each system port must be programmed to identify the type of station that operate on that port. Each station type must be identified.



*When identifying a station as a DSS/BLF console, you must also enter the station number of the key telephone to which the DSS/BLF console is associated. To associate a DSS console with Station 100, the entry would be 1100 [HOLD].*

Use Flash 50 programming when you want to modify a range of stations' attributes using **fixed** station numbers.

Use Flash 51 programming to modify a single station's attributes using a **flexible** station number.

### Programming Steps

By default, the system auto-detects Station ID. Use the following procedure to manually program Station ID, if the Station ID Lock feature is enabled.

1. Press **FLASH** and dial **[50]** or dial **[51]**. Flexible button #24 (New Range) is lit and one of the following messages displays:

#### Flash 50 - Fixed Numbers

STATION ATTRIBUTES  
SELECT A STATION RANGE

#### Flash 51 - Flexible Numbers

ENTER STATION NUMBER

Features and Operation

- Enter the range of **fixed** station numbers (100-149) to be programmed. If only one station is being programmed, enter that number twice, e.g., [100 100].

**Note** If HOLD is pressed without entering a station range, all stations are selected.

-or-

Enter a valid **flexible** number (100-8999) to be programmed.

- Press HOLD to save the entry. A confirmation tone sounds and the display updates. Flexible button #19 is lit. The display updates to reflect current programming for Page A:

**Flash 50 - Fixed Numbers**

XXX - XXX PAGE A  
ENTER BUTTON NUMBER

XXX-XXX = fixed station range

**Flash 51 - Flexible Numbers**

SXXX PAGE A  
ENTER BUTTON NUMBER

XXX = 3- or 4-digit flexible number

- Press button #20. The display updates to reflect current programming for Page B.

**Flash 50 - Fixed Numbers**

XXX - XXX PAGE B  
ENTER BUTTON NUMBER

XXX-XXX = fixed station range

**Flash 51 - Flexible Numbers**

SXXX PAGE B  
ENTER BUTTON NUMBER

XXX = 3- or 4-digit flexible number

- Press the STATION ID flexible button (**Button #1**).

STATION ID 0-8  
KEYSET - STSE 24BTN

- Enter a valid code number on the dial pad to identify type of device:

| Code  | Device                           | Part Number              |
|---|----------------------------------|--------------------------|
| [0]   | STSe 24-Btn Phone                | 3515                     |
| [1-3]                                       | DSS Console w/map 1-3            | 3510                     |
| [6]   | SLT w/o Msg Wait                 | Vodavi SLTs w/o Msg Wait |
| [7]   | SLT w/Msg Wait (90 VDC)          | Vodavi SLTs w/Msg Wait   |
| [015]                                       | SLA                              | 3854 & 9854              |
| [9]   | Virtual Station                  | --                       |
| [019]                                       | KTS 24-Btn (Remote IP Telephone) | 3813                     |
| [020]                                       | Door Box                         | 3560                     |
| * = Codes available w/ver 1.01P05 or higher |                                  |                          |

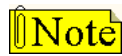

When *redesignating* a station from an SLA (identified by code 015) to an STSe 24-Btn Phone (normally identified by [0]), you must enter [000].

When designating a station as a DSS Console with map 1, map 2, or map 3, you must follow the entry with the station number for which the DSS is to be associated. Refer to ["Station ID for DSS/BLF Console With Map"](#) on page 3-21.

7. Press HOLD to save the entry. A confirmation tone sounds and the display updates.
8. If a Virtual Station is used, a system reset is required.

DEFAULT ... The system auto-detects all Vodavi telephone types, DSS console, and Door Box.

### Conditions

- » Only one station at a time can be programmed when using a flexible station number.
- » When in Flash 51 programming, if you press HOLD without specifying a flexible number to be programmed, you will get the station that is in port/station 100.
- » Auto-detect will not work if the Station ID Lock feature is enabled. Refer to ["Station ID Lock"](#) on page 2-285.

## Station ID Lock

### Description

The Station ID Lock feature provides a means for the installer/programmer to lock the station ID of all stations in the system. After locked, attempts to plug unlike devices (e.g., a DSS into a 24-button port) results in the device not working. This feature is designed to prevent loss of station programming that results when a different station type is plugged into a port already designated as another station type.

#### **To change the Station ID with the Station ID Lock feature enabled:**

1. Enter programming mode and disable the Station ID Lock feature.
2. Plug the new device type into the jack. The set is automatically identified.
3. Enter programming mode and enable the Station ID Lock feature.

-or-

Use FLASH 50, Page B, Button #1 programming to manually set station ID, without disabling Station ID Lock.

### Programming Steps

1. Press the STATION ID LOCK flexible button (**FLASH 06, Button #8**). The following message displays:

|              |     |
|--------------|-----|
| STATION LOCK | 0-1 |
| DISABLED     |     |

2. Enter a 0 or 1 on the dial pad to enable/disable the use of this feature.
    - [0] = Disabled
    - [1] = Enabled
  3. Press HOLD to save the entry. A confirmation tone sounds.
- DEFAULT ... Station ID Lock feature is disabled.

---

## Station Message Detail Recording

### Description

The STSe station message detail recording (SMDR) provides details on both incoming and outgoing calls. This feature is programmable to allow recording of all calls or just outgoing long distance calls. The system tracks calls by outside line, number dialed, time-of-day, date, station that placed the call and duration of call. Account codes may also be entered and recorded.

The SMDR Qualification Timer determines the length of time that is needed to determine a valid SMDR call for reporting purposes. By default, this timer is set to 30 seconds and is variable from 00 to 60 seconds in 1-second increments.

This feature is enabled or disabled in system programming. By default, SMDR is not enabled and is set to record long distance calls only. A printout format of 80 characters maximum or 30 characters maximum may be selected in system programming. The standard format is 80 characters on a single line. A 30 character format generates 3 lines per message. If the SMDR feature is enabled, the system starts collecting information about the call as soon as it starts and terminates when the call ends. If the call was longer than 30 seconds, the following information is printed:

|   |     |          |       |          |                        |                            |           |
|---|-----|----------|-------|----------|------------------------|----------------------------|-----------|
| 80 character format - Outbound Call to a Dialed Number:                           |     |          |       |          |                        |                            |           |
| 1   | 2   | 3        | 4     | 5        | 6                      | 7                          | 8         |
| 1234567890123456789012345678901234567890123456789012345678901234567890            |     |          |       |          |                        |                            |           |
| AAAA  | BBB | HH:MM:SS | HH:MM | MM/DD/YY | HCCCCCCCCCCCCCCCCCCCCC | GGGGGGGGGGGG               | (CR) (LF) |
| STA   | CO  | TOTAL    | START | DATE     | DIALED                 |                            |           |
| 1100  | 001 | 00:00:38 | 13:57 | 01/15/01 | O2956006               |                            |           |
| 80 character format - Outbound Call to an Extension:                              |     |          |       |          |                        |                            |           |
| 1   | 2   | 3        | 4     | 5        | 6                      | 7                          | 8         |
| 1234567890123456789012345678901234567890123456789012345678901234567890            |     |          |       |          |                        |                            |           |
| AAAA  | BBB | HH:MM:SS | HH:MM | MM/DD/YY | HCCCCCCCCCCCCCCCCCCCCC | GGGGGGGGGGGG               | (CR) (LF) |
| STA   | CO  | TOTAL    | START | DATE     | DIALED                 |                            |           |
| 1100  | 031 | 00:00:08 | 13:58 | 01/15/01 | O2108                  |                            | **        |
|   |     |          |       |          | **CALL TO HOWARD       |                            |           |
| 80 character format - Outbound Call to an Extension:                              |     |          |       |          |                        |                            |           |
| 1   | 2   | 3        | 4     | 5        | 6                      | 7                          | 8         |
| 1234567890123456789012345678901234567890123456789012345678901234567890            |     |          |       |          |                        |                            |           |
| AAAA  | BBB | HH:MM:SS | HH:MM | MM/DD/YY | HCCCCCCCCCCCCCCCCCCCCC | GGGGGGGGGGGG               | (CR) (LF) |
| STA   | CO  | TOTAL    | START | DATE     | DIALED                 |                            |           |
| 1102  | 031 | 00:00:11 | 13:59 | 01/15/01 | O2101                  |                            | **        |
|   |     |          |       |          | **CALL TO STA2101      |                            |           |
| 80 character format - Inbound Call from an Extension:                             |     |          |       |          |                        |                            |           |
| 1   | 2   | 3        | 4     | 5        | 6                      | 7                          | 8         |
| 1234567890123456789012345678901234567890123456789012345678901234567890            |     |          |       |          |                        |                            |           |
| AAAA  | BBB | HH:MM:SS | HH:MM | MM/DD/YY | HCCCCCCCCCCCCCCCCCCCCC | GGGGGGGGGGGG               | (CR) (LF) |
| STA   | CO  | TOTAL    | START | DATE     | DIALED                 |                            |           |
| 1100  | 031 | 00:00:03 | 13:59 | 01/15/01 | I2108                  |                            | **        |
|   |     |          |       |          | **HOWARD CALLING       |                            |           |
|   |     |          |       |          |                        | - continued on next page - |           |
| 80 character format - Inbound Call to a Station From CO Line 1 with No Caller ID: |     |          |       |          |                        |                            |           |
| 1   | 2   | 3        | 4     | 5        | 6                      | 7                          | 8         |
| 1234567890123456789012345678901234567890123456789012345678901234567890            |     |          |       |          |                        |                            |           |
| AAAA  | BBB | HH:MM:SS | HH:MM | MM/DD/YY | HCCCCCCCCCCCCCCCCCCCCC | GGGGGGGGGGGG               | (CR) (LF) |
| STA   | CO  | TOTAL    | START | DATE     | DIALED                 |                            |           |
| 1100  | 001 | 00:00:04 | 13:59 | 01/15/01 | I                      |                            |           |
| LEGEND:   |     |          |       |          |                        |                            |           |
| - AAAA = Station originator or Trunk on DISA and Off-Net (CO Line) calls.         |     |          |       |          |                        |                            |           |
| - BBB = Outside line number   |     |          |       |          |                        |                            |           |
| - HH:MM:SS = Duration of call in Hours, Minutes and Seconds                       |     |          |       |          |                        |                            |           |
| - HH:MM = Time of day (start time) in Hours and Minutes                           |     |          |       |          |                        |                            |           |
| - MM/DD/YY = Date of Call   |     |          |       |          |                        |                            |           |
| - H = Indicates call type:  |     |          |       |          |                        |                            |           |
| "I" = Incoming*   |     |          |       |          |                        |                            |           |
| "O" = Outgoing  |     |          |       |          |                        |                            |           |
| "T" = Transferred*  |     |          |       |          |                        |                            |           |
| "U" = Unanswered calls for ICLID SMDR call records                                |     |          |       |          |                        |                            |           |
| - CC...CC = Number dialed   |     |          |       |          |                        |                            |           |
| - GG...GG = Last Account code entered (optional)                                  |     |          |       |          |                        |                            |           |
| - (CR) = Carriage return  |     |          |       |          |                        |                            |           |
| - (LF) = Line Feed  |     |          |       |          |                        |                            |           |

Figure 2-24: SMDR Printout

The STSe system can provide SMDR output to the optional RS-232C connectors on the BKSU.

### Programming Steps

1. Press **FLASH** and dial **[21]**. The following message displays:

|     |     |     |      |      |
|-----|-----|-----|------|------|
| SDR | TPE | PNT | BAUD | PORT |
| NO  | LD  | 80  | 9600 | 1    |

2. To program SMDR features, use the flexible button(s) as defined in the following procedures.
3. The ENABLE/DISABLE, TYPE, and PRINT features toggle on and off each time the button is pressed. The display updates with each toggle.
4. After all entries are made, press HOLD to save the entry. A confirmation tone sounds.

### *SMDR Enable/Disable*

#### Description

A call accounting device can be installed allowing the system to track calls by outside line number, number dialed, time of day, date, station that placed or received the call, and duration of the call.

#### Programming Steps

1. Press the ENABLE/DISABLE flexible button (**FLASH 21, Button #1**). This feature toggles on and off each time the button is pressed. The display updates with each toggle.  
LED ON = SMDR is enabled  
LED OFF = SMDR is disabled
2. Press HOLD to save the entry. A confirmation tone sounds.

DEFAULT ... SMDR is disabled.

### *Long Distance - All Calls*

#### Description

The system can be set to record all outgoing calls or only outgoing long distance calls. Long Distance calls are defined as beginning with a 1 or 0, or containing eight or more digits. Incoming calls are only recorded if TYPE is set for all calls.

#### Programming Steps

1. Press the CALL TYPE flexible button (**FLASH 21, Button #2**) to determine the type of calls to record. This feature toggles on and off each time the button is pressed. The display updates with each toggle.  
LED ON = Long Distance is enabled  
LED OFF = All Calls is enabled
2. Press HOLD to save the entry. A confirmation tone sounds.

DEFAULT ... System records long distance (LD) calls only.



## *Character Print Assignment*

### **Description**

The system can be programmed to print individual SMDR records in either a 1-line 80-character format or a 3-line 30-character format.

### **Programming Steps**

1. Press PRINT FORMAT flexible button (**FLASH 21, Button #3**) to determine the print format of SMDR records. This feature toggles on and off each time the button is pressed. The display updates with each toggle.  
LED On = 80-Character is enabled  
LED Off = 30-Character is enabled
2. Press HOLD to save the entry. A confirmation tone sounds.  
DEFAULT ... The 1-line 80-character format is selected.

## *Baud Rate Display*

### **Description**

The STSe system provides SMDR output to the standard RS-232C connector on the optional BKSU. The baud rate is displayed as 150, 300, 600, 1200, 2400, 4800, 9600, or 19.2K baud.

### **Programming Steps**

The SMDR Baud Rate is programmed using **Flash 15**, Baud Rate Assignments. The LCD displays the current baud rate based on which port is assigned to the SMDR Port number.

## *SMDR Port Assignments*

### **Description**

PORT #1-- RS-232C port on the BKSU  
PORT #2 -- RS-232C port on the BKSU  
PORT #3 -- modem

### **Programming Steps**

1. Press the PORT flexible button (**FLASH 21, Button #5**) to determine which port to use for SMDR information.
2. Enter a valid number for the SMDR Port number:  
[1] = Port #1  
[2] = Port #2  
The LCD displays the current baud rate based on which Port number is assigned to the SMDR Port number.
3. Press HOLD to save the entry. A confirmation tone sounds and the display updates.  
DEFAULT ... Port #1.

## *SMDR Call Qualification Timer*

### **Description**

The SMDR Call Qualification Timer determines the time needed to determine a valid SMDR call for reporting purposes. The SMDR Call Qualification Timer setting is variable from 00-60 seconds in 1-second increments.

### **Programming Steps**

1. Press the SMDR CALL QUAL TIMER flexible button (**FLASH 01, Button #16**). The following message displays:

|                |       |
|----------------|-------|
| SMDR CALL QUAL | 00-60 |
| 30             |       |

2. Enter a valid number on the dial pad that corresponds to 00-60 seconds in 1-second increments.
3. Press HOLD to save the entry. A confirmation tone sounds and the display updates.

DEFAULT ... SMDR Call Qualification Timer is set to 30 seconds.

---

## Station Relocation

### Description

The Station Relocation Feature lets a user unplug their station and plug it into another location. Dialing a code followed by the old station number brings all the station attributes including extension number, button mapping, speed dial, and class of service to the new location.

### Operation

1. A station can be relocated by unplugging it, then plugging it into a new location.
2. Dial [636] on the dial pad. Then, dial the extension number of the station being relocated. Once this is done, all station attributes are copied to the current station.



*If a station is assigned to a specific port and that station user unplugs their station and plugs it in at another location, the database administration programming is updated to reflect the new port change. Station lock will prevent this feature from working correctly.*



SINGLE LINE TELEPHONE

Not applicable

### Conditions

- » The station number that is dialed as the relocated station must be unplugged.
- » The relocated station is given the station attributes of the station doing the relocating. The two stations trade station numbers and station attributes.
- » If a keyset is plugged into the relocated position it has all station attributes of the relocating station. This feature is only applicable to keysets.
- » Digital stations must be relocated to another digital port. Digital stations cannot be relocated to an SLT port.
- » Station Lock disables this feature.

## System Parameters

### Initialize System Parameters

#### Description

System Parameters may be initialized to set all data fields to their original default values. The following data fields are returned to their default values upon initializing System Parameters.

**Table 2-24: System Parameter Defaults**

| Program Code | Flexible Button          | Features                         | Default Value (after initialization) |
|--------------|--------------------------|----------------------------------|--------------------------------------|
| FLASH 01     | SYSTEM TIMERS            |                                  |                                      |
|              | 1                        | System Hold Recall Timer         | 60 sec                               |
|              | 2                        | Exclusive Hold Recall Timer      | 180 sec                              |
|              | 3                        | Attendant Recall Timer           | 1 min                                |
|              | 4                        | Transfer Recall Timer            | 45 sec                               |
|              | 5                        | Fax Timeout                      | 15 sec                               |
|              | 7                        | Pause Timer                      | 2 sec                                |
|              | 8                        | Call Park Recall Timer           | 180 sec                              |
|              | 9                        | Conference/DISA Timer            | 10 min                               |
|              | 10                       | Paging Time-out Timer            | 15 sec                               |
|              | 11                       | CO Ring Detect Timer             | 3=300 ms                             |
|              | 12                       | SLT DTMF Receiver Timer          | 020 sec                              |
|              | 13                       | Message Wait Reminder Tone Timer | 000=Disabled                         |
|              | 14                       | SLT Hook Switch Timer            | 10=1 sec                             |
|              | 15                       | SLT Hook Switch Bounce Timer     | 030=300 ms                           |
|              | 16                       | SMDR Call Qualification Timer    | 30 sec                               |
|              | 17                       | Automatic Call Back Timer        | 10 sec                               |
| 18           | Reminder Ring Timer      | 00 sec                           |                                      |
| 20           | Inter-Digit Timeout      | 5 sec                            |                                      |
| FLASH 02     | ADDITIONAL SYSTEM TIMERS |                                  |                                      |
|              | 1                        | Repeat Redial Timer              | 60 sec                               |
|              | 2                        | Attendant Display Timer          | 01 sec                               |
|              | 4                        | Modem Answer T / O               | 025 sec                              |
|              | 5                        | Pulse Dial Inter-Digit Timer     | 300 ms                               |
|              | 6                        | Programmable DTMF Time Operation | 1=100ms                              |

Table 2-24: System Parameter Defaults

| Program Code | Flexible Button                      | Features                                     | Default Value (after initialization) |
|--------------|--------------------------------------|--|--------------------------------------|
| FLASH 05     | SYSTEM FEATURES 1                    |  |                                      |
|              | 1                                    | Attendant Override                           | Disabled                             |
|              | 2                                    | Hold Preference                              | System                               |
|              | 3                                    | External Night Ring                          | Disabled                             |
|              | 4                                    | Executive Override Warning Tone              | Enabled                              |
|              | 5                                    | Page Warning Tone                            | Enabled                              |
|              | 6                                    | Background Music                             | Enabled                              |
|              | 7                                    | Least Cost Routing (LCR)                     | Disabled                             |
|              | 8                                    | Account Codes - Forced                       | Disabled                             |
|              | 9                                    | Group Listening                              | Disabled                             |
|              | 10                                   | Idle Speaker Mode                            | Disabled                             |
|              | 11                                   | Call Cost Display Feature                    | Disabled                             |
|              | 12                                   | Music-On-Hold                                | Enabled                              |
|              | 14                                   | CO Line Loop Supervision - Forced Disconnect | Disabled                             |
|              | 16                                   | Daylight Saving Time                         | Disabled                             |
| 17           | Multiple Tenant Group Enable/Disable | Disabled                                     |                                      |
| 19           | Long Fax Detect                      | Disabled                                     |                                      |
| FLASH 06     | SYSTEM FEATURES 2                    |  |                                      |
|              | 1                                    | Barge-In Warn Tone                           | Enabled                              |
|              | 2                                    | CO Ring Tones                                | Enabled                              |
|              | 3                                    | Verified Account Codes                       | Disabled                             |
|              | 4                                    | Call Forward Display                         | Enabled                              |
|              | 5                                    | External Day Ring                            | Disabled                             |
|              | 6                                    | Overflow Station Forward                     | Disabled                             |
|              | 7                                    | Direct Transfer Mode                         | Enabled                              |
|              | 8                                    | Station ID Lock                              | Disabled                             |
|              | 9                                    | LCR Call Progress                            | Enabled                              |
|              | 10                                   | One-Touch Recording Warning Tone             | Enabled                              |
|              | 11                                   | Ringback on Transfer                         | Disabled                             |
|              | 13                                   | 911 Feature                                  | Disabled                             |
|              | 14                                   | Enhanced 911                                 | Disabled                             |
|              | 15                                   | VMID Same As Station Numbers                 | STA Numbers = VMID                   |

**Table 2-24: System Parameter Defaults**

| Program Code | Flexible Button | Features                               | Default Value (after initialization) |
|--------------|-----------------|--|--------------------------------------|
| FLASH 07     | FLASH RATES     |  |                                      |
|              | 1               | Incoming CO Line Ringing               | Red 480 ipm flutter                  |
|              | 2               | Incoming Intercom Ringing              | Red 120 ipm flutter                  |
|              | 3               | Call Forward Button                    | Red Steady On                        |
|              | 4               | Message Wait/VM Button                 | Red Steady On                        |
|              | 6               | Do Not Disturb – DSS/BLF               | Red 60 ipm Dbl Wink Off              |
|              | 7               | Auto Call Back – BLF                   | Red 120 ipm flash                    |
|              | 8               | UCD Available/Unavailable – DSS/BLF    | Red 60 ipm Dbl Wink                  |
|              | 9               | Transfer CO Ringing                    | Red 120 ipm flash                    |
|              | 10              | Recall CO Ringing                      | Red 480 ipm flutter                  |
|              | 11              | Queued CO Ringing                      | Green 480 ipm flutter                |
|              | 12              | Exclusive Hold                         | Green 120 ipm flash                  |
|              | 13              | System Hold                            | Red 60 ipm Dbl Wink Off              |
|              | 14              | In Use Hold (I-Hold)                   | Green 60 ipm flash                   |
|              | 15              | Camp-On Button                         | Red 120 ipm flash                    |
|              | 16              | Call Back Button                       | Red 120 ipm flash                    |
|              | 17              | Line Queue Button                      | Red 480 ipm flutter                  |
|              | 18              | Do Not Disturb Button                  | Red Steady On                        |
|              | 20              | ACD Wrapup End Button                  | Red 120 ipm flutter                  |
|              | 21              | DND Page Block Button                  | Red 120 ipm flash                    |
|              | 22              | In & Out Button                        | Red 120 ipm flash                    |
|              | FLASH 09        | 1-6                                    | MOH Assignments (Channels 3-8)       |
| 7            |                 | E911 Power Failure Station             | None                                 |
| 9            |                 | Leading Digit                          | 0                                    |
| 10           |                 | School Mode                            | Disabled                             |
| 11           |                 | School Forward Destination             | None                                 |
| 12           |                 | Muted Ring                             | 0                                    |
| 13           |                 | Fax Route                              | STA 148                              |
| FLASH 10     | --              | Attendant Station Assignment           | STA 100                              |
|              | 1-10            | Attd Sta Assignments for Tenant Groups | STA 100 for 1st assigned in Grp 0    |
| FLASH 11     | 1               | System Time And Date                   | MMM/DD/YY, 12-hour display           |
| FLASH 12     | --              | PBX Dialing Codes                      | None                                 |
| FLASH 13     | 1-4             | Executive/Secretary Pairs              | None                                 |
| FLASH 14     | 1               | Relay Programming                      | None                                 |

Table 2-24: System Parameter Defaults

| Program Code | Flexible Button       | Features                               | Default Value (after initialization)   |
|--------------|-----------------------|--|--|
| FLASH 15     | BAUD RATE ASSIGNMENTS |  |  |
|              | 1                     | Port #1 (RS-232 on BKSU)               | 9600 Baud                              |
|              | 2                     | Port #2 (RS-232 on BKSU)               | 9600 Baud                              |
|              | 3                     | Port #3 (modem - baud auto-negotiated) | None                                   |
| FLASH 20     | 1                     | DISA Access Code                       | 100                                    |
|              | 2                     | Database Admin Password                | 3226                                   |
| FLASH 21     | 1                     | SMDR Enable/Disable                    | No                                     |
|              | 2                     | Long Distance/Local Assignment         | Long Distance                          |
|              | 3                     | Character Print Assignment             | 80                                     |
|              | 5                     | SMDR Port Assignments                  | Port #1                                |
| FLASH 22     | 1                     | Automatic/Manual Operation             | Auto = No                              |
|              | 2-8                   | Day of Week Programming                | M-F 08:00 17:00<br>Sat-Sun ###:## #:## |
| FLASH 24     | 1-14                  | Card Slot (0-13) Programming           | Slot 0, 1, 2=DTIB, LCI4, &SL02         |
| FLASH 39     | 1-24                  | CO Line Group Queuing                  | Enabled                                |
| FLASH 47     | T-1 ALARM PROGRAMMING |  |  |
|              | 1                     | Carrier Alarm Loss                     | Enabled                                |
|              | 2                     | Blue Alarm                             | Enabled                                |
|              | 3                     | Yellow Alarm                           | Enabled                                |
|              | 4                     | Red Alarm                              | Enabled                                |
|              | 5                     | Bipolar Alarm                          | Enabled                                |
|              | 6                     | Frame Slip Alarm                       | Enabled                                |
|              | 7                     | Data Errors Alarm                      | Enabled                                |
|              | 11                    | Enable/Disable (Carrier Loss Alarm)    | Enabled                                |
|              | 12                    | Clear Alarm                            | Enabled                                |
|              | 13                    | Minor Alarm                            | 15 min                                 |
|              | 14                    | Major Alarm                            | 30 min                                 |
|              | 15                    | Time Period                            | 5 min                                  |
|              | 16                    | Attendant Display                      | Enabled                                |

### Programming Steps

1. Press the SYSTEM PARAMETERS flexible button (**FLASH 80, Button #1**). The following message displays:

|  |
|--|
| <p>INITIALIZE SYS PARAM<br/>PRESS HOLD</p> |
|--|

2. Press the HOLD button. A confirmation tone sounds.

## Print System Parameters

### Description

The currently stored customer database can be printed or uploaded into a file. This command dumps the entire database as a permanent record which can serve as a hardcopy of the database. The system baud rate must match that of the printer or receiving device. When printing the System Parameters the following data prints:

- All System Timers
- All System Wide Options (External Night Ringing, Hold Preference)
- Attendant Station(s) Programming
- Other System Assignments (Page/Relay Assign, Exec/Sec, SMDR)
- Weekly Night Mode Schedule

| ----- SYSTEM PARAMETERS ----- |          | -----SYSTEM FEATURES ----- |                         |
|-------------------------------|----------|----------------------------|-------------------------|
|                               |          | CO RING TONES              | ENABLED                 |
|                               |          | VERIFIED ACCT CODES        | DISABLED                |
| SYS HOLD RECALL               | 60       | CALL FWD DISPLAY           | ENABLED                 |
| EXC HOLD RECALL               | 180      | EXTERNAL DAY RING          | DISABLED                |
| ATND RECALL TIMER             | 1        | OVERFLOW STA FWD           | DISABLED                |
| TRANSFER RECALL               | 45       | DIRECT XFER                | ENABLED                 |
| PRESET FWD TIMER              | 10       | STATION LOCK               | DISABLED                |
| CALL FWD NO ANS               | 15       | LCR CALL PROGRESS          | ENABLED                 |
| PAUSE TIMER                   | 2        | RECORDING WARN TONE        | ENABLED                 |
| CALL PARK TIMER               | 180      | MAINTENANCE                | DISABLED                |
| CONFERENCE TIMER              | 10       | RINGBACK ON XFER           | DISABLED                |
| PAGING TIMEOUT                | 15       | DID/TIE SIGNALING          | DISABLED                |
| CO RING DETECT                | 3        | 911 FEATURE                | DISABLED                |
| SLT RCVR TIMER                | 20       |                            |                         |
| M/W TONE TIMER                | 0        | -----SYSTEM                | LED                     |
| HOOK SWITCH TIME              | 10       |                            | FLASH RATES -----       |
| HOOK SWT BOUNCE               | 10       | INC CO RING                | RED 480 IPM FLUTTER     |
| SMDR CALL QUAL                | 30       | INC ICM RING               | RED 120 IPM FLUTTER     |
| AUTO CALL BACK                | 3        | CALL FORWARD BTN           | RED STEADY ON           |
| REMINDER RING                 | 0        | MSG WAIT VM BTN            | RED STEADY ON           |
| RELEASE GUARD                 | 3        | MSG CBCK DSS/BLF           | RED 120 IPM FLUTTER     |
| INTERDIGIT T/O                | 5        | DND DSS/BLF                | RED 60 IPM DBL WINK OFF |
| RPT REDIAL                    | 60       | AUTO CBCK DSS/BLF          | RED 120 IPM FLASH       |
| ATTENDANT DISPLAY             | 1        | UCD UNAVL DSS/BLF          | RED 60 IPM DBL WINK OFF |
| CALL COVERAGE RING            | 5        | TRANSFER CO RING           | RED 120 IPM FLASH       |
| MODEM ANSWER T/O              | 25       | RECALL CO RING             | RED 480 IPM FLUTTER     |
| INT DIGIT PULSE               | 300      | EXCLUSIVE HOLD             | GREEN 120 IPM FLASH     |
| DTMF ON/OFF TIME              | 1        | QUEUED CO RING             | GREEN 480 IPM FLUTTER   |
| -- SYSTEM FEATURES -----      |          | SYSTEM HOLD                | RED 60 IPM DBL WINK OFF |
|                               |          | IN USE HOLD                | GREEN 60 IPM FLASH      |
|                               |          | CAMP ON BTN                | RED 120 IPM FLASH       |
| ATTENDANT OVERRIDE            | DISABLED | CALL BACK BTN              | RED 120 IPM FLASH       |
| HOLD PREFERENCE               | SYSTEM   | LINE QUEUE BTN             | RED 480 IPM FLUTTER     |
| EXTERNAL NIGHT RING           | DISABLED | DND BTN                    | RED STEADY ON           |
| EXECUTIVE WARNING             | ENABLED  | ICM HOLD BTN               | RED 15 IPM FLASH        |
| PAGE WARNING TONE             | ENABLED  | LEADING DIGIT 1            | LEADING DIGIT           |
| BACKGROUND MUSIC              | ENABLED  | LEADING DIGIT 2            | NONE                    |
| LEAST COST ROUTING            | DISABLED | LEADING DIGIT 3            | NONE                    |
| FORCED ACCOUNT CODE           | DISABLED | LEADING DIGIT 4            | NONE                    |
| GROUP LISTENING               | DISABLED | LEADING DIGIT 5            | NONE                    |
| IDLE SPEAKER MODE             | DISABLED | LEADING DIGIT 6            | NONE                    |
| CALL COST DISPLAY             | DISABLED | LEADING DIGIT 7            | NONE                    |
| MUSIC ON HOLD                 | ENABLED  | LEADING DIGIT OPTION       | DISABLED                |
| CALL QUALIFIER TONE           | DISABLED | CENTREX DIGITS             | 4                       |
| BARGE IN WARN TONE            | ENABLED  | VM ID DIGITS               | 3                       |

Figure 2-25: System Parameters Printout



```

MUSIC CHANNEL[3..8]          CABINET  SLOT  TYPE
CO - ## #### ## ## ##      - - - - -  - - - -  - - - -
                                0      0      LCOB
ATTENDANT STATIONS          0      1      DTIB
100  ## ## ##   ## ## ##   0      2      LCOB
                                0      3      DTIB
DATE & TIME FORMAT          0      4      LCOB
MM/DD/YY, 12 HOURS         0      5      DTIB
                                0      6      LCOB
PBX DIALING CODES          0      7      DTIB
##      ##      ##      ##      ##

EXECUTIVE/SECRETARY PAIRINGS
1 =   ###   ###
2 =   ###   ###
3 =   ###   ###
4 =   ###   ###

ON BOARD RELAY ASSIGNMENTS
NONE  NONE

I/O BAUD RATE
-----
Port  1 =  9600
Port  2 =  9600
Port  3 =  9600

AUTO NIGHT MODE      N

WEEKLY NIGHT MODE SCHEDULE
-----
                END   START
DAY            TIME   TIME
M              0      0800  1700
T              1      0800  1700
W              2      0800  1700
T              3      0800  1700
F              4      0800  1700
S              5      #####  #####
S              6      #####  #####

DIAL PULSE - 60/40 10 PPS

```

Figure 12-20: System Parameters Printout

### Programming Steps

1. Press the SYSTEM PARAMETERS flexible button (**FLASH 85, Button #1**). The following message displays:

PRINT SYS PARAM  
PRESS HOLD

2. To print the System Parameters database, press the HOLD button. The following message displays:

PRINT SYS PARAM

When the system finishes sending the information to the printer, a confirmation tone sounds.

---

## System Reset

### Description

The System Reset feature provides a hard system reset from the keyset instead of the KSU. This is useful in cases where miscellaneous data errors have occurred and the system needs to be reset without initializing the entire database.

### Programming Steps

***If the System must be reset but not initialized:***

1. Press the RESET flexible button (**FLASH 80, Button #20**). The following message displays:

RESET SYSTEM  
PRESS HOLD

2. To reset the system without initializing the database, press the HOLD button. No confirmation tone sounds and the system resets.

## T-1 Alarm Programming

### Description

The T-1 Trunk card and the system software provide tools to help detect and isolate problems which may occur with the T-1 circuit. There are six LEDs mounted on the outside edge of the T-1 Trunk card which either light or flash to indicate a variety of conditions on the T-1 circuit. The Central Office Maintenance Center can send a command to place the CSU into Line Loop Back mode. If there is no CSU, the T-1 Trunk card responds to the Line Loop Back command.

The buttons on the digital telephone are defined as shown below when entering the T-1 Alarm programming area:

### Programming Steps

If the system is in the programming mode, continue using the program codes. If starting to program here, enter the programming mode.

1. Press **FLASH** and dial **[47]**. The following message displays:

|                                 |
|---------------------------------|
| T1 ALARM<br>ENTER BUTTON NUMBER |
|---------------------------------|

2. Press a button (1-7) that represents the desired alarm setting.
  - These settings govern all T-1 Trunk cards installed in the system.
  - The LED lights steady when the button is pressed.
  - Once the desired alarm is selected, the following conditions can be programmed:
    - Button #12 = Clears the alarm
    - Button #13 = Minor threshold setting
    - Button #14 = Major threshold setting
    - Button #15 = Time period for Minor/Major alarms
    - Button #16 = Sends LCD message of Major alarms to first Attendant Station

### *Enable/Disable (Carrier Loss Alarm)*

#### Description

A Receive Carrier Loss (RCL) condition is declared when no bits have been received by the T-1 Trunk card for 150ms. It causes an Out of Frame (OOF) condition, and 2.5 seconds later a RED Carrier Failure Alarm (CFA) state. During the time the RCL and RED alarm are declared, incoming and outgoing signal bits are frozen. Outgoing calls cannot be made.

#### Programming Steps

1. Press the CARRIER LOSS flexible button (**FLASH 47, Button #1**). Button #1 and Button #11 LEDs are lit steady. The following message displays:

|                         |     |
|-------------------------|-----|
| CARRIER LOSS<br>ENABLED | 0-1 |
|-------------------------|-----|

*Features and Operation*

2. Enter a 0 or 1 on the dial pad to enable/disable this feature.  
[0] = Disabled  
[1] = Enabled
3. Press the HOLD button to save the entry. A confirmation tone sounds and the display updates.

DEFAULT ... Carrier Loss Alarm is enabled on all T-1 trunks.

*Blue Alarm***Description**

The Blue Alarm signal is an unframed all ones signal. It is transmitted by a remote device (usually a CSU) and when received, indicates a transmission failure upstream of that device toward the local end. The AIS alarm signal is also known as the *keep alive* signal in that it prevents the T-1 circuit repeaters from malfunctioning when transmit from the remote end is lost.

**Programming Steps**

1. Press the BLUE ALARM flexible button (**FLASH 47, Button #2**). Button #2 and Button #11 LEDs are lit steady. The following message displays:

|            |     |
|------------|-----|
| BLUE ALARM | 0-1 |
| ENABLED    |     |

2. Enter a 0 or 1 on the dial pad to enable/disable this feature.  
[0] = Disabled  
[1] = Enabled
3. Press HOLD to save the entry. A confirmation tone sounds and the display updates.
4. Continue programming the Blue Alarm parameters using the steps provided earlier in this section for Clearing the alarm, Minor alarm, Major alarm, Time Period, and Attendant display.

DEFAULT ... Blue Alarm is enabled for all T-1 Trunks.

## *Yellow Alarm*

### **Description**

The Yellow Alarm is recorded when the T-1 Trunk card detects a yellow Carrier Failure Alarm (CFA) signal from the distant end for a minimum 335 ms. The Yellow Alarm is transmitted by the remote system because of a RED alarm condition there.

### **Programming Steps**

1. Press the YELLOW flexible button (**FLASH 47, Button #3**). Button #3 and Button #11 LEDs are lit steady. The following message displays:

|                         |     |
|-------------------------|-----|
| YELLOW ALARM<br>ENABLED | 0-1 |
|-------------------------|-----|

2. Enter a 0 or 1 on the dial pad to enable/disable this feature.  
[0] = Disabled  
[1] = Enabled
3. Press HOLD button to save entry. A confirmation tone sounds and the display updates.
4. Continue programming the Yellow Alarm parameters using steps provided in this section for Clearing the alarm, Minor alarm, Major alarm, Time Period, and Attendant display.

DEFAULT ... Yellow Alarm is enabled for all T-1 Trunks.

## *Red Alarm*

### **Description**

The Red Alarm is declared by the T-1 Trunk card when a loss of signal is detected, or an Alarm Indication Signal is received. A Red Alarm can be caused by a loss of carrier signal, a receive out of frame sync condition, or an alarm indication signal.

### **Programming Steps**

1. Press the RED ALARM flexible button (**FLASH 47, Button #4**). Button #4 and Button #11 LEDs are lit steady. The following message displays:

|                      |     |
|----------------------|-----|
| RED ALARM<br>ENABLED | 0-1 |
|----------------------|-----|

2. Enter a 0 or 1 on the dial pad to enable/disable this feature.  
[0] = Disabled  
[1] = Enabled
3. Press HOLD button to save entry. A confirmation tone sounds and the display updates.
4. Continue programming Red Alarm parameters using the steps provided in this section for Clearing the alarm, Minor alarm, Major alarm, Time Period, and Attendant display.

DEFAULT ... Red Alarm is enabled for all T-1 trunks.

## Bipolar Variations Alarm

### Description

Excessive Bipolar Violations (BPV) are declared when a T-1 Trunk card detects a BPV rate in excess of  $1 \times 10^{+6}$  errors in 1000 seconds.



This condition can exist if the Telco is providing B8ZS frame coding and the system is programmed for AMI.

### Programming Steps

1. Press the BIPOLAR VARIATIONS flexible button (**FLASH 47, Button #5**). Button #5 and Button #11 LEDs are lit steady. The following message displays:

|                    |     |
|--------------------|-----|
| BIPOLAR VARIATIONS | 0-1 |
| ENABLED            |     |

2. Enter a 0 or 1 on the dial pad to enable/disable this feature.  
[0] = Disabled  
[1] = Enabled
  3. Press HOLD to save the entry. A confirmation tone sounds and the display updates.
  4. Continue to program Bipolar Variations Alarm parameters using the steps in this section for Clearing the alarm, Minor alarm, Major alarm, Time Period, and Attendant display.
- DEFAULT ... Bipolar Variations are enabled at all T-1 trunks.

## Frame Slip Alarm

### Description

When a Frame Slip or change in frame alignment is detected, the T-1 Trunk card freezes all incoming signaling states and realigns the receive buffer. If all alarm conditions are clear, signaling states are released and normal operation resumes.

### Programming Steps

1. Press FRAME SLIP flexible button (**FLASH 47, Button #6**). Button #6 and Button #11 LEDs are lit steady. The following message displays:

|         |     |
|---------|-----|
| SLIP    | 0-1 |
| ENABLED |     |

2. Enter a 0 or 1 on the dial pad to enable/disable this feature.  
[0] = Disabled  
[1] = Enabled
3. Press HOLD button to save entry. A confirmation tone sounds and the display updates.
4. Continue to program the Frame Slip Alarm parameters using steps provided in this section for Clearing the alarm, Minor alarm, Major alarm, Time Period, and Attendant display.

DEFAULT ... Frame Slip is enabled on T-1 trunks.

## *Data Errors Alarm*

### **Description**

Data errors are illegal bit formations. If the Data Errors Alarm is enabled, an error message is sent to the Attendant when the data error limit is reached.

### **Programming Steps**

1. Press the DATA ERRORS flexible button (**FLASH 47, Button #7**). Button #7 and Button #11 LEDs are lit steady. The following message displays:

|                        |     |
|------------------------|-----|
| DATA ERRORS<br>ENABLED | 0-1 |
|------------------------|-----|

2. Enter a 0 or 1 on the dial pad to enable/disable this feature.  
[0] = Disabled  
[1] = Enabled
3. Press HOLD button to save entry. A confirmation tone sounds and the display updates.
4. Continue to program Data Error Alarm parameters using steps provided in this section for Clearing the alarm, Minor alarm, Major alarm, Time Period, and Attendant display.

DEFAULT ... Data Errors Alarm is enabled for all T-1 Trunks.

## *Clear Alarm*

### **Description**

The Clear Alarm option allows the alarm condition reported to the Attendant Display to be cleared.

### **Programming Steps**

1. Press the CLEAR ALARM flexible button (**FLASH 47, Button #12**). Button #12 LED is lit steady. The following message displays:

|                                       |
|---------------------------------------|
| DATA ERRORS<br>CLEAR ALARM PRESS HOLD |
|---------------------------------------|

2. Press the HOLD button to clear the alarm. A confirmation tone sounds.

## Minor Alarm

### Description

If the error counter for an Alarm Code reaches the number programmed as a Minor Alarm within the time (in minutes) entered in the Time Period, the system reports a Minor Alarm condition. The Minor Alarm threshold setting is variable from 00 to 99 minutes.

### Programming Steps

1. Press the MINOR ALARM flexible button (**FLASH 47, Button #13**). Button #13 LED is lit steady. The following message displays:

|                |       |
|----------------|-------|
| DATA ERRORS    | 00-99 |
| MINOR ALARM 15 |       |

2. Enter a valid number (00-99) on the dial pad which represents the threshold limit.
3. Press the HOLD button to save the entry. A confirmation tone sounds and the display updates.

DEFAULT ... Minor Alarm threshold is set for 15 minutes.

## Major Alarm

### Description

If the error counter for an Alarm Code reaches the number programmed as a Major Alarm within the time (in minutes) entered in the Time Period, the system reports a Major Alarm condition. The Major Alarm threshold setting is variable from 00 to 99 minutes.

### Programming Steps

1. Press the MAJOR ALARM flexible button (**FLASH 47, Button #14**). Button #14 LED is lit steady. The following message displays:

|                |       |
|----------------|-------|
| DATA ERRORS    | 00-99 |
| MAJOR ALARM 30 |       |

2. Enter a valid number (00-99) on the dial pad which corresponds to the time period limit.
3. Press the HOLD button to save the entry. A confirmation tone sounds and the display updates.

DEFAULT ... Major Alarm threshold is set for 30 minutes and is variable from 00 to 99 minutes.



## Time Period

### Description

The Time Period option represents the length of time set for Minor and Major alarm conditions to occur.

### Programming Steps

1. Press the TIME PERIOD flexible button (**FLASH 47, Button #15**). Button #15 LED is lit steady. The following message displays:

|                |       |
|----------------|-------|
| DATA ERRORS    | 00-99 |
| TIME PERIOD 05 |       |

2. Enter a valid number (00-99) on the dial pad which represents the time period limit.
3. Press the HOLD button to save the entry. A confirmation tone sounds and the display updates.

DEFAULT ... Time Period is set for five minutes.

## Attendant Display - T-1 Alarms

### Description

The Attendant Display option determines whether the first Attendant station should be notified of any T-1 alarm conditions when they occur.

### Programming Steps

1. Press the ATENDANT DISPLAY flexible button (**FLASH 47, Button #16**). Button #16 LED is lit steady. The following message displays:

|                     |     |
|---------------------|-----|
| DATA ERRORS         | 0-1 |
| ATT DISPLAY ENABLED |     |

2. Enter a valid number (0 or 1) on the dial pad.  
[0] = No alarm  
[1] = Alarm enabled
3. Press the HOLD button to save the entry. A confirmation tone sounds and the display updates.

DEFAULT ... All alarm conditions are enabled to be sent to the first Attendant station LCD display.

### Operation

The Attendant can dial feature code [606] to clear any T-1 alarm from the display. It will not clear the condition, just clear the display.

## T-1 Trunking

### Description

The T-1 trunk card can be used to connect 24 lines (24 channels per T-1 circuit) from a CO to the system. These lines can be any mix of inbound WATS, outbound WATS, standard DDD lines, DID lines, or TIE lines. The system also supports Fractional T-1 Service.

### T-1 Signaling Type

#### Description

The T-1 trunk card provides the STSe Systems with the ability to connect to T-1 trunk circuits. The T-1 trunk card supports either the standard D4 framing format with Alternate Mark Inversion (AMI) or Extended Superframe (ESF-B8ZS) format coding. The system can support TIE, loop start, ground start, and DID signaling per channel. The T-1 trunk card fits into one card slot.

The T-1 signaling protocols provided are: Loop Start, Ground Start, TIE. The STSe Digital Systems use the TIE signaling simulation from the Central Office to add the additional protocol of Direct Inward Dial (DID).

T-1 trunking provides services called Automatic Number Identification (ANI) and Dialed Number Identification Service (DNIS). The T-1 feature supports both of these services. The STSe Digital Systems support ANI, DNIS, or an ANI and DNIS combination on a per channel (line) basis.

#### Programming Steps

1. Press **FLASH** and dial **[40]**. The following message displays:

CO LINE ATTRIBUTES  
 SELECT A CO LINE RANGE

2. Enter a valid number for the range of lines being programmed. If only one line is being programmed, enter that number twice (001 001).

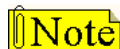

*If HOLD is pressed without entering a CO line range, all CO lines are selected.*

3. Press HOLD to save the entry. A confirmation tone sounds and the display updates. Flexible Button #19 (Page A) is lit.
4. Press the PAGE B flexible button (Button #20). The following message displays:

XXX - XXX PAGE B  
 ENTER BUTTON NUMBER

*XXX-XXX = CO Line Range*

5. Press the T-1 SIGNALING flexible button (**FLASH 40, Page B, Button #1**). The following message displays:

|                 |     |
|-----------------|-----|
| T-1 SIGNAL TYPE | 0-7 |
| LOOP START      |     |

6. Enter a valid number (0-7) on the dial pad that corresponds to one of the following types:

**Table 2-25: T-1 Signaling Options**

| Signaling Option    | Description   |
|---------------------|---|
| [0] = None          | None is used for fractional T-1 spans. All unused channels in a fractional T-1 span should be marked as None.   |
| [1] = Data (future) |   |
| [2] = Loop Start    | Disconnect supervision is not supported for Loop Start emulation of T-1 circuits.   |
| [3] = Ground Start  | Software supports disconnect supervision for ground start emulation of T-1 circuits.  |
| [4] = DID           | The DID signaling (wink, delay, and immediate) is controlled in Flash 40. DID digits from the carrier are routed via the DID table. To program the DID table, refer to Flash 44 programming on <a href="#">page 2-112</a> and to Flash 43 programming on <a href="#">page 2-112</a> .   |
| [5] = TIE           | This is used for point-to-point T-1 applications.   |
| [6] = TIE/DNIS      | The DNIS signaling (wink, delay, and immediate) is controlled in Flash 40. DNIS digits from the carrier are routed via the DID table. To program the DID table, refer to Flash 44 programming on <a href="#">page 2-112</a> and to Flash 43 programming on <a href="#">page 2-112</a> . |
| [7] = TIE/ANI       | The ANI number is treated and routed as an ICLID number. It follows the Flash 43 programming ( <a href="#">page 2-112</a> ) for routing information and Flash 55 programming ( <a href="#">page 2-233</a> ) for Name/Number Translation.  |

7. Press the HOLD button. A confirmation tone sounds and the display updates.

DEFAULT ... T-1 Signal Type option is Loop Start.

## T-1 Ringback Option

### Description

The T-1 Ringback option supports T-1 channels which require ringback tone to be transmitted to the caller while a call is ringing. Some carriers require the system to generate the ringback tone, this feature allows the system to provide this option. Ringback tone is not used with the DISA, TIE Line, or DID signal options.

### Programming Steps

1. Press the RINGBACK OPTION flexible button (**FLASH 40, Page B, Button #2**). The following message displays:

|                        |     |
|------------------------|-----|
| T-1 RINGBACK<br>ENABLE | 0-1 |
|------------------------|-----|

2. Enter a 0 or 1 on the dial pad to enable/disable this feature.  
[0] = Disabled  
[1] = Enabled
3. Press the HOLD button. A confirmation tone sounds and the display updates.

DEFAULT ... T-1 Ringback option is enabled.

## T-1 Dial Tone Option

### Description

An option has been added to support T-1 channels which do not supply dial tone. Some carriers require the system to generate dial tone to its users, while other carriers do not.

### Programming Steps

1. Press the T-1 DIAL TONE flexible button (**FLASH 40, Page B, Button #3**). The following message displays:

|                           |     |
|---------------------------|-----|
| T-1 DIAL TONE<br>DISABLED | 0-1 |
|---------------------------|-----|

2. Enter a 0 or 1 on the dial pad to enable/disable this feature.  
[0] = Disabled  
[1] = Enabled
3. Press the HOLD button to save the entry. A confirmation tone sounds and the display updates.

DEFAULT ... Dial Tone option is disabled.

## Wink Timer

### Description

When Wink signaling is programmed, this timer determines how long the STSe system keeps the T-1 TIE Line circuit reversed before any DTMF digits are sent from the Central Office. This option allows the installer a method to adjust the Wink Signal on a per CO Line basis. The Wink Signal can be used on DID and TIE-type trunks.

### Programming Steps

1. Press **FLASH** and dial **[40]**. The following message displays:

CO LINE ATTRIBUTES  
 SELECT A CO LINE RANGE

2. Enter a valid number for the range of lines being programmed. If only one line is being programmed, enter that number twice (001 001).

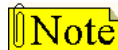

*If HOLD is pressed without entering a CO line range, all CO lines are selected.*

3. Press Button #21 to select Page C. The display updates. The following message displays to indicate current programming of that line or group of lines:

XXX - XXX PAGE C  
 ENTER BUTTON NUMBER

*XXX-XXX = CO Line Range*

4. Press the WINK TIMER Button (**FLASH 40, Page C, Button #3**) in the flexible button field. The following message displays:

|            |         |
|------------|---------|
| WINK TIMER | 100-290 |
| 140        |         |

5. Enter a valid number which corresponds to 100-290 ms.
6. Press HOLD button to save entry. A confirmation tone sounds and the display updates.

DEFAULT ... Wink Timer is set for 140 ms.

## T-1 Collect Timer

### Description

The T-1 Collect Timer is only used when the T-1 Incoming Signaling is set for dial pulse. This is a time-out timer that looks at the incoming digits one digit at a time.

If a second digit isn't detected within the 150 ms, the telephone system attempts to process that digit. If a second digit is detected, the system waits 150 ms to see if a third digit is received. Otherwise, the telephone system attempts to process the two digits already received. This process continues until no additional digits are received and the time-out timer expires.

The T-1 Collect Timer setting is variable from 100 ms to 2.0 seconds.

### Programming Steps

1. Press the T-1 COLLECT TIMER flexible button (**FLASH 40, Page C, Button #10**). The following message is shown on the display phone:

|                  |         |
|------------------|---------|
| T1 COLLECT TIMER | 010-200 |
| 015              |         |

2. Enter a valid number on the dial pad which corresponds to 010–200 (100 ms to 2.0 seconds).
3. Press the HOLD button to save the entry. A confirmation tone sounds and the display updates.

DEFAULT ... T-1 Collect Timer is set for 150 ms.

## T-1 Incoming Signaling

### Description

The T-1 Incoming Signaling option allows the installer to determine the type of incoming signaling to be used by all T-1 trunks in the system.

### Programming Steps

There are two types of T-1 Signaling available for T-1 Trunks. To change the type of signaling:

1. Press the T-1 INCOMING SIGNALING flexible button (**FLASH 41, Button #6**) for programming the type of T-1 signaling desired. The following message is shown on the display phone:

|               |     |
|---------------|-----|
| T1 INC SIGNAL | 0-1 |
| DTMF          |     |

2. Enter a 0 or 1 on the dial pad.
    - [0] = Dial Pulse
    - [1] = DTMF
  3. Press the HOLD button to save the entry. Confirmation tone sounds and display updates.
- DEFAULT ... T-1 Signaling type is set for DTMF.

## *T-1 Framing Type*

### **Description**

The T-1 board will work with D4SF-AMI or ESF-B8ZS framing. The T-1 service should be ordered from the serving company.

### **Programming Steps**

There are two types of T-1 Framing Types available. To change the framing type:

1. Press the T-1 FRAMING TYPE flexible button (**FLASH 41, Button #7**) for programming the type of T-1 Framing desired. The following message is shown on the display phone:

|                 |     |
|-----------------|-----|
| T1 FRAMING TYPE | 0-1 |
| D4SF-AMI        |     |

2. Enter a 0 or 1 on the dial pad.  
[0] = D4SF-AMI  
[1] = ESF-B8ZS
3. Press the HOLD button to save the entry. A confirmation tone sounds and the display updates.

DEFAULT ... T-1 Framing type is set for D4SF-AMI.

---

## Tenant Groups

### Description

The Tenant Groups feature allows one STSe system to be used by up to 10 different companies or agencies within a single building. Each Tenant Group can have up to 6 Attendants. By default, the first programmed station of Tenant Group 0 is an Attendant, which is station 100.

Tenant Group 0 is the only Tenant Group that can use Flash 22 programming to assign its own automatic day/night open and close schedule. Other Tenant Groups must manually change between day/night/special by pressing the DND button.

Stations can place an intercom call to a station in any Tenant Group in the system. Stations can also call an Attendant in another Tenant Group by dialing the appropriate station number; however, dialing 0 will only ring the Attendant within the same Tenant Group as the station that dials 0.

The following system features are assigned and changeable by the first programmed Attendant of any Tenant Group. Coordination is necessary between Tenant Groups to establish capability that supports the requirements of all groups.

- Numbers programmed in system speed bins
- Custom Messages (21-30)
- Directory List Programming
- Attendant CO Line External (Off-Net) Forward
- Setting Time and Date

The following subsections describe programming and operations that are unique to Tenant Groups. Refer to [Chapter 3](#) for additional information on Attendant Programming and Operations.

### *Enable/Disable the Tenant Groups Feature*

#### Programming Steps

1. Press the MULTIPLE TENANT flexible button (**FLASH 05, Button #17**). The following message displays:

|                  |     |
|------------------|-----|
| MULTIPLE TENANTS | 0-1 |
| 0                |     |

2. Enter a valid number (0 or 1) on the dial pad.  
[0] = Disabled  
[1] = Enabled
3. Press the HOLD button to save the entry. A confirmation tone sounds and the display updates.

DEFAULT ... Disabled.



## Attendant Station Assignment for Tenant Groups

### Description

Any six Digital Telephones in each Tenant Group can be assigned as Attendant stations. These stations receive recalls and can place the system into Night Service. The Attendant station must be a digital display telephone.

### Programming Steps

1. Press **FLASH** and dial **[10]**. The following message displays:

ATND STATIONS 100, ####  
####, ####, ####, ####

2. Press the desired flexible button #1-10 to select a Tenant Group 0-9 respectively.
3. Enter a valid station number (100-8999) on the dial pad, followed by a "1" to add or "0" to delete the Attendant assignment.
4. Press HOLD to save the entry. A confirmation tone sounds and the display updates.

DEFAULT ... Station 100 is assigned as the first Attendant of Tenant Group 0. There is no default station assignments for Attendants of other Tenant Groups.

## Station Assignment to a Tenant Group

### Description

A station can only be assigned to one Tenant Group.

### Programming Steps

To program stations to a specific Tenant Group:

1. Press **FLASH** and dial **[50]** or dial **[51]**. Flexible button #24 (New Range) is lit and one of the following messages displays:

#### Flash 50 - Fixed Numbers

STATION ATTRIBUTES  
SELECT A STATION RANGE

#### Flash 51 - Flexible Numbers

ENTER STATION NUMBER

2. Enter the range of **fixed** station numbers (100-149) to be programmed. If only one station is being programmed, enter that number twice, e.g., [100 100].

 *If HOLD is pressed without entering a station range, All stations are selected.*

-or-

Enter a valid **flexible** number (100-8999) to be programmed.

- Press HOLD to save the entry. A confirmation tone sounds and the display updates. Flexible button #19 is lit. The display updates to reflect current programming for Page A:

**Flash 50 - Fixed Numbers**

|   |
|---|
| XXX - XXX PAGE A<br>ENTER BUTTON NUMBER |
|---|

*XXX-XXX = fixed station range*

**Flash 51 - Flexible Numbers**

|                                    |
|------------------------------------|
| SXXX PAGE A<br>ENTER BUTTON NUMBER |
|------------------------------------|

*XXX = 3- or 4-digit flexible number*

- Press button #22. The display updates to reflect current programming for Page D.

**Flash 50 - Fixed Numbers**

|   |
|---|
| XXX - XXX PAGE D<br>ENTER BUTTON NUMBER |
|---|

*XXX-XXX = fixed station range*

**Flash 51 - Flexible Numbers**

|                                    |
|------------------------------------|
| SXXX PAGE D<br>ENTER BUTTON NUMBER |
|------------------------------------|

*XXX = 3- or 4-digit flexible number*

- Press Button #1 and the following displays:

|  |
|--|
| TENANT GROUP                      0-9<br>0 |
|--|

- Enter a valid number 0-9 to assign the station(s) to a Tenant Group 0-9 respectively.
- Press HOLD to save the entry. A confirmation tone sounds and the display updates.

DEFAULT ... All stations are assigned to Tenant Group 0.

## CO Line Assignments for Tenant Groups

### Description

When a particular Tenant Group member dials 9 to access a CO line, that member has access to CO lines based on what is programmed in this feature.

### Programming Steps

- Press **FLASH** and dial **[40]**. The following message displays:

|  |
|--|
| CO LINE ATTRIBUTES<br>SELECT A CO LINE RANGE |
|--|

- Enter a valid number for the range of lines being programmed. If only one line is being programmed, enter that number twice (001 001).

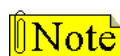

*If HOLD is pressed without entering a CO range, all CO lines are selected.*

3. Press HOLD to save the entry. A confirmation tone sounds and the display updates. Flexible button #19 (Page A) is lit. The following message displays to indicate current programming of that line or group of lines:

|   |
|---|
| XXX - XXX PAGE A<br>ENTER BUTTON NUMBER |
|---|

*XXX-XXX = CO Line Range*

4. Press the TENANT GROUP flexible button (**Button #17**).

|   |
|---|
| TENANT GROUP                      0-9<br>00 |
|---|

5. Enter a valid number 0-9 to associate the CO lines to a Tenant Group 0-9 respectively.
6. Press HOLD to save the entry. A confirmation tone sounds.

DEFAULT ... All lines are set for Tenant Group 0.

## Incoming Ring Assignments

### Description

Incoming DID or DNIS call routing for Tenent Groups is programmed in this feature.

### Programming Steps

1. Press **FLASH** and dial **[43]**. The **Button #1** LED is illuminated and the following message displays:

|                  |
|------------------|
| ROUTE 000 DDDDRR |
|------------------|

*000 = Route Number (000-251)*

*DDDD = 3- or 4-Digit Ringing Destination Number*

*R = Ringing Type*

2. Either press **Button #20** and enter a valid number for the route to be programmed or use **Buttons #18/#19** to scroll up or down to select the desired route, then press HOLD.
3. Press the TENENT GROUP flexible button (**Button #10**). The following message displays:

|  |
|--|
| TENENT GROUP                      0-9<br>0 |
|--|

4. Enter valid number on dial pad (0-9) to specify the desired group.
5. Press HOLD to save the entry. A confirmation tone sounds and the display updates.

DEFAULT ... Tenent Group 0.

## CO Line Sharing

### Description

If enabled, this feature allows all tenant groups to use the same CO Lines.

### Programming Steps

1. Press **FLASH** and dial **[41]**. The following message displays:

|                                    |
|------------------------------------|
| CO FEATURES<br>ENTER BUTTON NUMBER |
|------------------------------------|

2. Press Button #12. The following message displays:

|                   |     |
|-------------------|-----|
| SHARED TENANTS CO | 0-1 |
| DISABLED          |     |

3. Enter a valid number on the dial pad.  
[0] = Disabled  
[1] = Enabled
4. Press HOLD to save the entry. A confirmation tone sounds and the display updates.  
DEFAULT ... Disabled (0) is the default.

---

## Text Messaging (Silent Response)

### Description

The Text Messaging feature allows a station user to use text messages to respond to a caller that has either camped-on or has used the off-hook voice over (OHVO) feature to alert a busy station of a waiting call or message. The camped-on station may respond to the caller via the canned, custom, and silent response text (LCD) messages. The text messages appear on the calling party LCD display. The calling (originating) station and receiving station **MUST** be digital telephones. The receiving station **MUST** also be programmed to allow OHVO calls.

### Operation

While receiving a Camp On, or OHVO call:

The called party may press a preprogrammed Text Message button with a specific message [633+XX]. Example: [633] + [38] means a telephone calling the station receives the message WHO IS IT ?

Additional messages (with their codes listed below) can also be sent as a text response:

|                              |                                |                         |
|------------------------------|--------------------------------|-------------------------|
| [31] = I Will Take Call      | [38] =Who Is It?               | [45] = Park Call        |
| [32] = Take Message          | [39] =Is It Long Distance?     | [46] = Out Of Office    |
| [33] = Transfer To Secretary | [40] =Is It Personal?          | [47] = Put Call Through |
| [34] = Put Call On Hold      | [41] =Is It An Emergency?      | [48] = I Am Busy        |
| [35] = Call Back             | [42] = Is It Important?        | [49] = O.K.             |
| [36] = One Moment Please     | [43] = Is It Urgent?           | [50] = No               |
| [37] = I Will Call Back      | [44] = Send Call To Voice Mail | [51] = Yes              |



#### SINGLE LINE TELEPHONE

Not applicable

### Conditions

- » If the station receiving the text message response is on an OHVO call, no tone is received.
- » All canned and custom messages may be used to respond to a calling party.
- » Text response messages automatically clear when the calling station (station receiving the messages) goes on-hook.
- » A station can receive only one message at a time.
- » Text messages may be chained (i.e., multiple messages sent to one caller).
- » Text message responses appear on the calling station and the receiving station (station activating text responses) LCD displays.
- » If the calling station is a non-LCD telephone, the receiving station receives error tone when responding via text messaging.
- » The receiving station may press a flexible button programmed as a Text Message button, [633+#]. Press this flexible button and dial the 2-digit message number (31-51) to respond to the calling station. DTMF digits are not heard by either party.
- » When silent messaging is used to respond to a call, the existing call of the called station is not disconnected while the messages are sent to the calling station.
- » The calling station must remain off-hook to receive silent messages.
- » If the receiving station responds with a text message, the text message displays on the LCD.
- » Each message may be programmed onto a flexible button, including a flexible button on a DSS/BLF console.

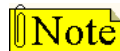

*The calling station must be a display telephone and the receiving station must be a keyset.*

## Toll Restriction

### Description

The STSe system offers a flexible means of applying toll restriction to stations or individuals. Dialing privileges (or toll restriction) is determined through assignment of station and CO line Class Of Service (COS).

Several types of restriction can be derived simply by programming COS assignments and CO line access to stations. This may, in some cases, be all that is necessary. However, when a more complex or specific type of restriction is desired the system offers two Allow and two Deny tables along with four special tables.

These tables can be programmed in a variety of ways to handle applications that are straightforward or applications that require a more complex arrangement. The Allow and Deny tables are assigned to stations based on their station Class of Service (COS) assignment. The Station COS interacts with CO Line COS assignments to provide several different types of dialing privileges.

**Table 2-26: Class of Service**

|                                 |   | CO LINE CLASS OF SERVICE |                    |                    |                    |               |
|---------------------------------|---|--------------------------|--------------------|--------------------|--------------------|---------------|
|                                 |   | 1                        | 2                  | 3                  | 4                  | 5             |
| S<br>T<br>A<br>T<br>I<br>O<br>N | 1 | Unrestricted             | Unrestricted       | Unrestricted       | Canned Restricted* | Unrestricted  |
|                                 | 2 | Table A                  | Table A            | Unrestricted       | Canned Restricted* | Unrestricted  |
|                                 | 3 | Table B                  | Unrestricted       | Table B            | Canned Restricted* | Unrestricted  |
|                                 | 4 | Table A&B                | Table A            | Table B            | Canned Restricted* | Unrestricted  |
| C<br>O<br>S                     | 5 | Canned Restricted*       | Canned Restricted* | Canned Restricted* | Canned Restricted* | Unrestricted  |
|                                 | 6 | Intercom Only            | Intercom Only      | Intercom Only      | Intercom Only      | Intercom Only |
|                                 | 7 | Canned Restricted*       | Canned Restricted* | Canned Restricted* | Canned Restricted* | Unrestricted  |

\* Canned Restriction: No [0], [1], [#], [\*] as first dialed digit, and 7-digit dialing limitation; plus 1-800, 1-866, 1-877, 1-888, 1-911, 1-611 are allowed, and 411, 976, and 555 numbers are denied. COS 7 allows all COS 5 and 10-digit local dialing.

The Allow and Deny tables enable entries of either general or specific allow and deny codes such as allowing all [1-800] type calls, and/or denying all [1]+ or [0]+ calls.

The Allow and Deny tables allow a maximum of 8 digits to be entered as allow or deny digits. This enables entry of certain area codes or office codes that can specifically be allowed or denied.

For example, the code [1-555-1212] may be entered in the Deny Table to deny local toll information calls. Each Allow Table contains 20 bins for entry of allow codes. Each Deny Table contains 10 bins for entry of deny codes.

### Rules for Setting Up Allow/Deny Tables

Rule 1--- If both tables (Allow and Deny) have no entries, no restriction is applied.

Rule 2--- If entries are made in the Allow Table and only there, then only those numbers are allowed. All other dialing is denied.

Rule 3--- If entries are made in the Deny Table and only there, then only those numbers are denied. All other dialing is allowed.

Rule 4--- If there are entries in both Allow and Deny tables, the Allow Table is searched first, and if a match is found, it is allowed. If a match is not found, the Deny Table is searched; if a match is found, the call is denied. If the number does not match an entry in either table, it is allowed.

**Table 2-27: Allow / Deny Table**

| Rules         | Allow Table | Deny Table | Conditions and Results                               |   |
|---------------|-------------|------------|--|---|
|               |             |            | Allow  | Deny  |
| <b>Rule 1</b> | No Entries  | No Entries | All calls are allowed.                               |   |
| <b>Rule 2</b> | Entries     | No Entries | If a match is found, the call is allowed.            |   |
|               |             |            | If a match is not found, the call is denied.         |   |
| <b>Rule 3</b> | No Entries  | Entries    |  | If a match is found, the call is denied.      |
|               |             |            |  | If a match is not found, the call is allowed. |
| <b>Rule 4</b> | Entries     | Entries    | If a match is found, the call is allowed.            | If a match is found, the call is denied.      |
|               |             |            | If a match is not found, the deny table is searched. | If a match is not found, the call is allowed. |

A special Do Not Care character (D) may be entered to allow or deny any digit dialed in that digit sequence.

### Special Reference Tables

The STSe system also offers four special tables that can be referenced from within the two Allow Tables.

- Three of the special tables can be assigned to specific area codes that require further toll restriction definition.
- The fourth Special Table is reserved for use as a home area code table (numbers within the same area code as the site where the system is installed). This provides expanded ability to apply toll restriction on numbers that are dialed within an area code.
- Each Special Table allows up to 800 entries (200–999). This offers the ability to allow every office code on an individual basis.

**Related Information**

| Quick Reference |        |           |   |
|-----------------|--------|-----------|---|
| ➡ Flash 40      | Page A | Button #9 | Class of Service (refer to <i>"Class of Service - CO Line"</i> on page 2-62).                 |
| ➡ Flash 50      | Page B | Button #2 | Day (Special) Class of Service (refer to <i>"Station Day Class of Service"</i> on page 2-63). |
| ➡ Flash 50      | Page B | Button #3 | Night Class of Service (refer to <i>"Station Night Class of Service"</i> on page 2-64).       |

**Entering Toll Table****Description**

All toll tables have been conveniently placed under one program code to allow entry of all toll restriction data.

When the system searches the Allow and Deny tables, the entries are checked starting with Bin 01 and proceeding sequentially through the table to the last bin. In addition the Allow Table is always searched before looking at the Deny Table. Therefore, the entry order is important. Entries that are specific (e.g., [1716]) are placed ahead of entries that are more general (usually include Do Not Care digits; e.g., [1 D 1]).

Once a match is found in the Allow Table that references a Special Table, the number dialed are checked for an allowed code in the Special Table. If a match is not found in the Special Table, the system continues to check for a match in the next Allow or Deny Table to check. The system does not return to the table that sent the call to the Special Table.

**Programming Steps**

If the system is in the programming mode, continue using the program codes. If starting to program here, enter the programming mode.

1. Press **FLASH** and dial **[70]**. The following message displays:

|                                  |
|----------------------------------|
| EX TABLES<br>ENTER BUTTON NUMBER |
|----------------------------------|

2. To program Allow/Deny tables, press the appropriate Table button and enter information as outlined in the following procedures.
3. To program Special Tables 1-3, it is necessary to associate an area code to the table. This is done by pressing the appropriate AREA CODE TABLE button and assign the area code.

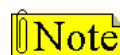

*Special Table 4 is reserved for the home area code and does not require an area code entry.*

4. To display entries in any of the tables, press the DISPLAY TABLES button (**FLASH 70, Button #12**). Entries in the Allow/Deny tables display two at a time. Entries in the Special tables display six at a time in ascending order.



## Allow Table

### Description

Each Allow Table contains 20 bin numbers. Each bin number may be up to 8 digits, including Do Not Care digits and Search Special Table commands. Entries into the Allow Table represent exceptions to numbers or codes that are to be allowed only if they would otherwise be restricted by an entry in the Deny Table.

### EXAMPLE

If [1 555 1212] is allowed but [1+] numbers are denied, by an entry into the Deny Table, [1 555 1212] is entered into the Allow Table as an allowed number.

- Allow Table A is referenced and searched first (before Deny Table A) when Station COS is 2 and CO Line COS is either 1 or 2.
- Allow Table B is referenced and looked at first (before Deny Table B) when Station COS is 3 and CO Line COS is either 1 or 3.
- When Station COS is 4 and CO Line COS is 1 both allow tables are looked at first (Allow Table A first, then Allow Table B) then both deny tables (Deny Table A first, then Deny Table B).

**Do Not Care** digits specify that the system should consider any digit dialed in that position as a match. Do Not Care digits should not be entered as the last digit in an entry, as this would be an unnecessary or meaningless command.

**Search Special Table** commands must be entered in a specific manner and should always be the last entries in the Allow Table. It is recommended that the last four bins (17–20) in the Allow Table be reserved for referencing the four special tables with the reference to the home area code (Special Table 4) always being located in bin number 20. Search Special table commands can only be entered into the allow tables.

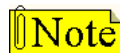

Remember to enable 911 for all Classes of Service

### Rules for entries that reference Special Tables:

For entries referencing the first three special tables a specific area code must be identified (one for each table needed). Then make note as to how the numbers are dialed when dialing numbers to this area code (i.e., with a leading digit [1] or no leading digit [1]).

The entry into the Allow Table would be entered as follows:

- Leading Digit [1]: Enter [BB] [1] [XXX] [DDD] [S]

-or-

- Non-Leading [1]: Enter [BB] [XXX] [DDD] [S]

*BB = Bin Number (Bins 17-19)*

*XXX = Area Code (must match AREA-X entry)*

*DDD = Do Not Care digit (three entries, DND button)*

*[S] = Search Special Table Command (TRANS button)*

For an entry that references the Home Area Code table (Special Table 4) the entry may also be entered to expect or not expect a leading digit [1]. In fact, in some cases it may be desirable to enter both of the following entries:

- Leading Digit [1] -- Enter [BB] [1] [DDD] {S}

and/or,

- Non-Leading [1] -- Enter [BB] [DDD] {S}

*BB = Bin number (Bin 20)*

*DDD = Do Not Care digit (three entries, MUTE button)*

*{S} = Search Special Table Command (TRANS button)*



*If both leading digit [1] and non-leading digit [1] entries are made to reference the same table, it is necessary to place the leading digit [1] entry ahead of the non-leading digit [1] entry in the Allow Table.*

### Programming Steps

1. Press the ALLOW TABLE A or ALLOW TABLE B flexible button (**FLASH 70, Button #1 or #3**). The following message is shown on the display telephone:

|               |     |
|---------------|-----|
| ALLOW TABLE A |     |
| 01E           | 02E |

The first two bin locations display.

2. Enter a valid bin number (01–20) of the bin to be programmed.

It is recommended that:

Bin 17 be reserved for an entry that references SPECIAL TABLE 1

Bin 18 be reserved for an entry that references SPECIAL TABLE 2

Bin 19 be reserved for an entry that references SPECIAL TABLE 3

Bin 20 be reserved for an entry that references Home Area Code Table, SPECIAL TABLE 4.

3. Enter the Allow Code.

*[0–9], [\*], [#] = Corresponding allow digits (numbers)*

*MUTE = Do Not Care digit (D)*

*TRANS = Search Special Table (S)*

4. Press HOLD to save the entry. A confirmation tone sounds and the display now updates.
5. When all entries for one table are complete, press the flexible button for the next table.

#### **To erase a bin number:**

1. Enter a valid bin number.
2. Press the HOLD button.

## Deny Table

### Description

Each Deny Table contains ten bin numbers. Each bin number may be up to eight-digits including {Do Not Care} digits. Entries in the Deny Table represent numbers or codes that are to be denied or restricted. Common entries would be [1] for restricting all [1+] type of calls. Exceptions to this restriction would be entered into the Allow Table.

- Deny Table A is referenced and searched only after the Allow Table A is checked when Station COS is 2 and CO Line COS is either 1 or 2.
- Deny Table B is referenced and searched only after the Allow Table B is checked when Station COS is 3 and CO Line COS is either 1 or 3.
- When Station COS is 4 and CO Line COS is 1, both allow tables are looked at first (Allow Table A first, then Allow Table B) then both deny tables (Deny Table A first, then Deny Table B).
  - Do Not Care digits specify that the system should consider any digit dialed in that position as a match. Do Not Care digits should not be entered as the last digit in an entry.
  - Search Special Table commands cannot be entered into the Deny tables.

### Programming Steps

1. Press the DENY TABLE A or DENY TABLE B flexible button (**FLASH 70, Button #2 or #4**). The following message displays:

|  |
|--|
| DENY TABLE A                               |
| 01E <span style="float: right;">02E</span> |

2. When the first two bin locations are displayed, enter the 2-digit bin number (01–10) of the bin to be programmed.
3. Enter the deny code:
  - [0–9], [\*], [#] = Corresponding deny digits numbers
  - MUTE = Do Not Care digit
4. Press HOLD to save the entry. A confirmation tone sounds and the display now updates.
5. When all entries for one table are complete, press the flexible button for the next table.

#### To erase a bin number:

1. Enter a valid bin number.
2. Press the HOLD button.

## Special Table

### Description

The Special Tables provide greater flexibility in designing a toll plan for a particular site.

- Each Special Table allows entry of up to 800 office codes (200–999).
- Three of these tables must be assigned an area code by which they are referenced. The fourth table is reserved for the home area code and requires no area code entry.
- The Special Tables are referenced through entries in the allow tables. Four area codes, including the home area code, can be referenced to these special tables for further definition. When a Special Table is referenced, entries must be made in the Special Table specifying what office codes are allowed.
- Codes can be added to the Allow list or removed from the list. When a Special Table is checked for a match to a 3-digit code and not found, the system continues to search the next Allow/Deny Table to be checked. The system does not return to the Allow Table which routed the call to the Special Table.

### Programming Steps

#### To program a special table:

(The area code must first be assigned to the table, except for the home area code.)

1. Press the appropriate AREA CODE TABLE (#1 to #3) flexible button (**FLASH 70, Buttons #9 to #11**). The following message displays:

|                 |    |
|-----------------|----|
| SPECIAL TABLE 1 | AC |
|-----------------|----|

2. Enter a valid area code.
3. Press the HOLD button to save the entry. A confirmation tone sounds and the display updates.

#### To enter office codes in a special table:

1. Press the SPECIAL TABLE (#1 to #4) flexible button (**FLASH 70, Buttons #5 to #8**) that corresponds to the area code programmed above. The following message displays:

|                 |        |
|-----------------|--------|
| SPECIAL TABLE 1 | AC XXX |
|-----------------|--------|

XXX = Area Code

2. Enter the office codes that are to be allowed or removed as follows:
  - XXX [1] = Allow Code
  - XXX [0] = Remove Code from the list  
(XXX = An office code from 200 to 999)
3. Press HOLD after every code entered. A confirmation tone sounds and the display updates. Multiple codes may be entered in a row. The display updates showing the first six codes in ascending order.

DEFAULT ... No codes are on the Allow list.

## Display Toll Table Entries

### Description

To view all entries in the toll tables using the display on the Executive telephone, press, the DISPLAY TABLES flexible button (**FLASH 70, Button #12**) multiple times to scroll through the entries.

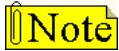

*It is recommended to view all entries in the Allow and Deny Table before leaving programming. Entries can be entered near the bottom of the list for searching the special tables or entries made in error. Viewing the entire Allow Table ensures proper entry and operation.*

### Programming Steps

Press the DISPLAY TABLES flexible button (**FLASH 70, Button #12**) while entering information into a table.

#### **To view entries in an allow or deny table:**

Two entries at a time are displayed on the bottom line of the display.

1. Press the DISPLAY TABLES button again, the next higher bins displays.
2. When the last entries are displayed, press the DISPLAY TABLES button again to show the first two entries.

```
ALLOW TABLE A
01 XXXXXXXE 02 XXXXXXXX
```

*X = Allow or Deny Code*

*E = End of Entry*

#### **To view entries in a special table:**

Six 3-digit codes allowed display in ascending order starting with the lowest entry.

Press the DISPLAY TABLES button again, the next 6 entries display. This continues until all codes are displayed.

```
SPECIAL TABLE 1 AC XXX
YYY YYY YYY YYY YYY YYY
```

*XXX = Area Code*

*YYY = Allowed Office Code*

## Initialize Exception Tables

### Description

The Exception Tables parameters, including the Allow/Deny Tables and the Special Tables, may be initialized setting all tables to their original, default values. The following Tables are cleared returning to their default value upon initializing the Exception Tables parameters:

**Table 2-28: Exception Table Defaults**

| Program Code | Flexible Button               | Features                      | Default Value (after initialization) |
|--------------|-------------------------------|-------------------------------|--------------------------------------|
| FLASH 70     | TOLL RESTRICTION              |                               |                                      |
|              | 1                             | Allow Table A Programming     | None                                 |
|              | 2                             | Deny Table A Programming      | None                                 |
|              | 3                             | Allow Table B Programming     | None                                 |
|              | 4                             | Deny Table B Programming      | None                                 |
|              | 5                             | Special Table 1 Programming   | All Codes Denied                     |
|              | 6                             | Special Table 2 Programming   | All Codes Denied                     |
|              | 7                             | Special Table 3 Programming   | All Codes Denied                     |
|              | 8                             | Special Table 4 Programming   | Home                                 |
|              | 9                             | Area Code for Special Table 1 | None                                 |
|              | 10                            | Area Code for Special Table 2 | None                                 |
|              | 11                            | Area Code for Special Table 3 | None                                 |
| 12           | Displaying Toll Table Entries | None                          |                                      |

### Programming Steps

1. Press the EXCEPTION TABLES flexible button (**FLASH 80, Button #5**). The following message displays:

|  |
|--|
| <p>INITIALIZE EX TABLES<br/>PRESS HOLD</p> |
|--|

2. Press the HOLD button. A confirmation tone sounds.

## Print Exception Tables

### Description

The Print Exception Tables command dumps the entire database as a permanent record which can serve as a hardcopy of the database. The system baud rate must match that of the printer or receiving device.

When printing information from the Exception Tables, the following data prints:

- Allow Table A and Deny Table A
- Allow Table B and Deny Table B
- Special Tables 1, 2, 3, and 4

|               |    |                                |
|---------------|----|--------------------------------|
| ALLOW TABLE A |    | SPECIAL TABLE 1 AREA CODE      |
| -----         |    | -----                          |
| 01            | 11 | ALLOWED OFFICE CODES           |
| 02            | 12 |                                |
| 03            | 13 |                                |
| 04            | 14 |                                |
| 05            | 15 | SPECIAL TABLE 2 AREA CODE      |
| 06            | 16 | -----                          |
| 07            | 17 | ALLOWED OFFICE CODES           |
| 08            | 18 |                                |
| 09            | 19 |                                |
| 10            | 20 |                                |
|               |    | SPECIAL TABLE 3 AREA CODE      |
| DENY TABLE A  |    | -----                          |
| -----         |    | ALLOWED OFFICE CODES           |
| 01            | 06 |                                |
| 02            | 07 |                                |
| 03            | 08 |                                |
| 04            | 09 | SPECIAL TABLE 4 HOME AREA CODE |
| 05            | 10 | -----                          |
|               |    | ALLOWED OFFICE CODES           |
| ALLOW TABLE B |    |                                |
| -----         |    |                                |
| 01            | 11 |                                |
| 02            | 12 |                                |
| 03            | 13 |                                |
| 04            | 14 |                                |
| 05            | 15 |                                |
| 06            | 16 |                                |
| 07            | 17 |                                |
| 08            | 18 |                                |
| 09            | 19 |                                |
| 10            | 20 |                                |
| DENY TABLE B  |    |                                |
| -----         |    |                                |
| 01            | 06 |                                |
| 02            | 07 |                                |
| 03            | 08 |                                |
| 04            | 09 |                                |
| 05            | 10 |                                |

**Figure 2-26: Exception Tables Printout**

## Programming Steps

1. Press the EXCEPT TABLES flexible button (**FLASH 85, Button #5**). The following message displays:

PRINT EX TABLES  
PRESS HOLD

2. To print the Except Tables, press the HOLD button. The following message displays:

PRINTING EX TABLES

When the system finishes sending the requested information to the printer, a confirmation tone sounds.

## *Toll Restriction Related Items*

### **CO/PBX Lines**

When CO lines are marked as PBX lines the system first checks the PBX code table for a valid match. If the first digits dialed do not match the entries in the PBX code table the call is considered an attempt to call another PBX extension and no toll restriction is applied. If the first digits dialed are found in the PBX code table (FLASH 12), toll restriction starts with the next dialed digit.

### **Forced Account Codes**

The system can be programmed to force the use of account codes on all restricted calls. When forced account codes are enabled, an account code must be entered to place a call that is otherwise restricted through toll restriction. By entering an account code, the station class of service becomes unrestricted. When account codes are forced on a system-wide basis, selected users may be instructed on how to enter account codes from any station and be allowed to dial unrestricted from a station that may otherwise be restricted. Use of account codes in this manner, as a traveling class of service, is however, not controlled by the system. Any station user with knowledge of how to enter account codes to override a station's toll restriction can do so.

### **SLT DTMF Receivers**

When Single Line Telephones are connected to the STSe system and toll restriction is enabled, the DTMF receivers located in the system monitors the call for a programmed time period. While the DTMF receiver is monitoring the digits being dialed by a single line telephone, it is considered busy and not available for monitoring another SLT attempting to dial. When all DTMF receivers are busy, an SLT attempting to go off-hook does not receive dial tone until a receiver is available.

The STSe system uses one DTMF receiver to monitor SLT dialing. If a system has heavy SLT usage, then toll restriction may inhibit dialing by SLT stations.



Two options are available to help alleviate this problem:

- Shorten the SLT receiver timer (FLASH 01, Button 12). This frees up DTMF receivers faster, but may not provide the desired toll restriction for SLT stations.
- Enable LCR and force LCR on SLT stations.

When the LCR database is set up, the 3-digit table allows entry of the number of digits to expect. When an SLT user dials the appropriate number of digits, LCR releases the DTMF receiver and then it is available for another SLT call.

### **LCR Versus Toll Restriction**

LCR is not an alternative to toll restriction nor is toll restriction an alternative to LCR. They work best when programmed together. Toll restriction specifies station dialing privileges and LCR provides call routing to appropriate lines.

LCR can enhance toll restriction by providing Store and Forward operation to analyze digits being dialed before a trunk is seized. This prevents users from by-passing toll restriction by taking advantage of the time required for a central office line to provide dial tone. LCR is recommended when toll restriction is enabled.

---

## **Uniform Call Distribution**

Eight Uniform Call Distribution (UCD) groups can be programmed, each containing up to eight three-digit station numbers. Each group is assigned a pilot number. When this number is dialed, the first available agent in that group is rung. Calls are routed to the station that has been on-hook for the longest period of time. Refer to [Chapter 4, Uniform Call Distribution](#) for additional information.

---

## **Universal Day/Night Answer**

### **Description**

Incoming CO lines can be programmed for Universal Day Answer (UDA) or Universal Night Answer (UNA). UDA/UNA assigned CO lines can also signal over the external page port(s). If External Day programming is enabled and the system is in the day mode, the assigned external page port(s) present a ringing signal. UDA/UNA is established on a per CO line basis in admin programming.

When the system is in Day or Night mode and you hear an outside line ringing at another station, and wish to answer it:

Dial [#5] on the dial pad or use the Soft Key's UDA/UNA option. The connected outside line can be transferred or disconnected.

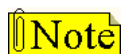

*Each telephone utilizing Universal Day/Night Answer must have a loop button appearance if the ringing outside line does not display at their phone.*

*UDA/UNA only works on direct ringing calls. It does not work for intercom or transferred calls.*

## Universal Day Answer (UDA)

### Description

UDA-assigned CO lines can signal over external page port(s). External Day ringing is programmed on a system-wide basis in administrative programming. Stations that do not have access to a line during the day can answer that line while the System is in the day mode by dialing a UDA code [#5]. To use this feature, a LOOP button or an appearance of the trunk must be present on the station.

### Programming Steps

1. Press **FLASH** and dial **[40]**. The following message displays:

CO LINE ATTRIBUTES  
 SELECT A CO LINE RANGE

2. Enter a valid number for the range of lines being programmed. If only one line is being programmed, enter that number twice (001 001).



*If HOLD is pressed without entering a CO line range, all CO lines are selected.*

3. Press HOLD to save the entry. A confirmation tone sounds and the display updates. Flexible Button #19 (Page A) is lit.
4. Press the Page B flexible button (Button #20). The following message displays:

XXX - XXX PAGE B  
 ENTER BUTTON NUMBER

*XXX-XXX = CO Line Range*

5. Press the UNIVERSAL DAY ANSWER flexible button (**Button #7**). The following displays:

UNIVERSAL DAY ANSWER    0-1  
 DISABLED

6. Enter a 0 or 1 on the dial pad to enable/disable this feature.  
 [0] = Disabled  
 [1] = Enabled
7. Press HOLD to save the entry. A confirmation tone sounds and the display updates.

DEFAULT ... Universal Day Answer feature is disabled.

### Operation

Upon hearing an incoming signal:

1. Lift handset.
2. Dial the UDA/UNA access code [#5] on the dial pad. You are connected to ringing outside line.

## Conditions

- » During the Day mode, all common CO lines ring when programmed for UDA ringing.
- » CO lines not programmed for UDA ringing do not participate in common audible ringing.
- » If External Day ring is disabled, or the system is not in the day mode, external page ringing is disabled.
- » Ringing CO lines not assigned CO line group access for a particular SLT may be answered in a UDA service. Dialing privileges are unavailable on CO lines to which an SLT does not have access. CO lines without UDA status may not be answered or accessed via UDA procedures.
- » If two single-line telephones attempt to retrieve one ringing CO line simultaneously, one user is connected to the incoming CO line, the other user receives intercom busy tone.
- » The special ring mode is treated as day mode.

## Universal Night Answer (UNA)

### Description

If a line is marked UNA, this activates night service answering of incoming calls on this line by stations not normally assigned access to the line(s) by dialing feature code [#5]. This station must have a direct CO appearance or an available loop key assigned to do this. Lines marked as UNA also activate Night Ringing over External Page when in the night mode if External Night Ringing is set to Yes.

### Programming Steps

1. Press **FLASH** and dial **[40]**. The following message displays:

CO LINE ATTRIBUTES  
SELECT A CO LINE RANGE

2. Enter a valid number for the range of lines being programmed. If only one line is being programmed, enter that number twice (001 001).



*If HOLD is pressed without entering a CO line range, all CO lines are selected.*

3. Press HOLD to save the entry. A confirmation tone sounds and the display updates. Flexible button #19 (Page A) is lit. The following message displays to indicate current programming of that line or group of lines:

XXX - XXX PAGE A  
ENTER BUTTON NUMBER

*XXX-XXX = CO Line Range*

4. Press the UNA flexible button (**Button #3**).

*Features and Operation*

5. Enter a 0 or 1 on the dial pad to enable/disable this feature.  
     [0] = Disabled  
     [1] = Enabled

|         |     |
|---------|-----|
| UNA     | 0-1 |
| ENABLED |     |

6. Press HOLD to save the entry. A confirmation tone sounds.

DEFAULT ... UNA is enabled.

### Operation

Upon hearing an incoming signal:

1. Lift handset.
2. Dial the UDA/UNA access code [#5] on the dial pad. You are connected to ringing outside line.

---

## Virtual Stations

### Description

A Virtual Station is nothing more than an extension number that does not have a physical instrument on the telephone switch. Once the extension number is designated as a Virtual Station, that Virtual Station number can then be programmed to forward intercom and incoming CO line calls to a desired destination or used as a call coverage feature.

- Virtual Stations extensions must be designated as such in ["Station Identification" on page 2-283](#).
- COs (T1, PRI, BRI, VoIP, Loop Start, and DID) can be programmed to ring virtual stations (Flash 40/43 programming).
- Calls to Virtual Stations can be forwarded using any of the Station Preset Forwards in Flash 50/51, Page C and Page D.

### Examples

An example of this feature's usefulness is a CO line, designated to ring a Virtual Station that is preset forwarded to ring at an off site location. In this manner you do not have to buy and maintain a physical keyset to use this call forwarding feature.

Another example is where two CO lines are programmed to ring to two different virtual stations. An Attendant can create two call coverage buttons to cover these two virtual stations. In this manner two co-located businesses who share a common Attendant can know that a caller is calling for company A or for company B, depending on which call coverage button illuminates.

## Voice Mail

### Description

Up to eight Voice Mail groups can be configured in the STSe system. Each group can contain up to 24 Voice Mail designated ports, each of which interfaces with a port on an SLT card (or DTIB if using a Digital Voice Mail).

An externally provided Voice Mail system or Auto Attendant must be connected to the STSe system for Voice Mail or Auto Attendant operation. Voice Mail automatically handles unanswered calls. Station user can then retrieve messages left at their stations.

Auto Attendants can handle incoming calls and route callers to station users without intervention from the systems Attendant. Direct incoming ring to Voice Mail/Auto Attendant groups can be done directly through CO Line Ringing Assignments.

### Programming Steps

1. Press FLASH and dial [65]. The following message displays.

VXXXX  
ENTER BUTTON NUMBER

*XXXX = 3- or 4-digit flexible voice mail group number*

The top left button in the flexible button field is lit for programming Voice Mail Group 440.

2. To change Voice Mail groups or enter further voice mail groups, press the appropriate flexible button 1-8 (440–447) and perform the following procedures.

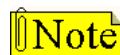

*If installing a Vodavi voice mail system (except MiniVoice), skip directly to Button 12 and enter voice mail ports.  
Certain programming is required in the Voice Mail system connected to the STSe system for proper operation.  
Tone Mode Calling option (6#) must be programmed as leading digits in transfer sequence(s) of Voice Mail system to force tone ringing to key telephones in the handsfree mode.*

DEFAULT ... No voice mail stations are assigned.

## Alternate Voice Mail Group

### Description

An Alternate Voice Mail Group may be programmed so that if all voice mail ports are in use, the call can be routed to an alternate group. This is useful when more than 24 ports are required for voice mail traffic.

### Programming Steps

1. Press the ALTERNATE VM GROUP flexible button (**FLASH 65, Button #9**).
2. Enter a valid flexible Voice Mail Group number.

|                                  |
|----------------------------------|
| VXXXX ALTERNATE VM GROUP<br>#### |
|----------------------------------|

3. Press HOLD to save the entry. A confirmation tone sounds and the display updates.

#### **To delete an alternate voice mail group assignment:**

1. Press [#].
2. Then press the HOLD button.

## Standard Leave Mail Index Entry

### Description

The Standard Leave Mail Index specifies the digits to be outpulsed when the in-band digits are sent to a Voice Mail system. These digits are required to connect a caller who is forwarded into voice mail, to the called station's mailbox.

### Programming Steps

1. Press the STANDARD LEAVE flexible button (**FLASH 65, Button #10**).
2. Enter a valid Standard Leave Mail Index number (0-7) on the dial pad.

|                                    |
|------------------------------------|
| VXXXX STANDARD LEAVE      0-7<br># |
|------------------------------------|

3. Press HOLD to save the entry. A confirmation tone sounds and the display updates.

#### **To delete a leave mail index entry:**

1. Press [#] in the desired location on the keypad.
2. Then press the HOLD button.

DEFAULT ... Voice Mail Group 1 (440) Standard Leave Mail Index is set to zero (0).

## Retrieve Mail Index Entry

### Description

The Retrieve Mail Index specifies the digits to be outpulsed when the in-band digits are sent to a Voice Mail system. These digits are required to connect a station user to their mailbox.

### Programming Steps

1. Press the RETRIEVE flexible button (**FLASH 65, Button #11**).
2. Enter a valid outpulsing table number (0-7) on the dial pad.

|                     |     |
|---------------------|-----|
| VXXXX RETRIEVE MAIL | 0-7 |
| #                   |     |

3. Press HOLD to save the entry. A confirmation tone sounds and the display updates.

### To delete a retrieve mail index entry:

1. Press the pound key [#].
2. Then press HOLD.

DEFAULT ... Voice Mail Group 1 (440) Retrieve Mail Index is set to 1.

## Station Assignments

### Description

Up to 24 extension numbers may be programmed into a voice mail group. A flexible button may be programmed with a fixed or flexible voice mail group pilot number (440-447 = fixed). This button then acts as a DSS for that voice mail group when pressed and also serves as the message waiting indication for that VM group.

### Programming Steps

1. Press the STATION ASSIGN flexible button (**FLASH 65, Button #12**).
2. Enter **SSS 1** to add a station (SSS = 3- or 4-digit flexible VM station number),  
-or-  
Enter **SSS 0** to delete a station (SSS = 3- or 4-digit flexible VM station number).

|                              |                   |
|------------------------------|-------------------|
| VXXXX STA                    | ####, ####, ####, |
| ####, ####, ####, ####, #### |                   |

3. Press HOLD to save the entry. A confirmation tone sounds and the display updates.

## No Answer Leave Mail Index Entry

### Description

The No Answer Leave Mail Index specifies the digits to be outpulsed when the in-band digits are sent to a Voice Mail system. These digits are required to connect a caller who is forwarded into voice mail in a No Answer condition, to the called station's mailbox.

### Programming Steps

1. Press the NO ANS LEAVE flexible button (**FLASH 65, Button #13**).
2. Enter a valid No Answer Leave Mail Index number (0-7) on the dial pad:

|                    |     |
|--------------------|-----|
| VXXXX NO ANS LEAVE | 0-7 |
| #                  |     |

3. Press HOLD to save the entry. A confirmation tone sounds and the display updates.

#### To delete a no answer leave mail index entry:

1. Press [#].
2. Then press HOLD.

DEFAULT ... Voice Mail Group 1 (440) No Answer Leave Mail Index is set to none (#).

## Busy Leave Mail Index Entry

### Description

The Busy Leave Mail Index specifies the digits to be outpulsed when the in-band digits are sent to a Voice Mail system. These digits are required to connect a caller who is forwarded into voice mail in a Busy condition, to the called station's mailbox.

### Programming Steps

1. Press the BUSY LEAVE flexible button (**FLASH 65, Button #14**).
2. Enter a valid Busy Leave Mail Index number (0-7) on the dial pad:

|                  |     |
|------------------|-----|
| VXXXX BUSY LEAVE | 0-7 |
| #                |     |

3. Press HOLD to save the entry. A confirmation tone sounds and the display updates.

#### To delete a busy leave mail index entry:

1. Press [#].
2. Then press HOLD.

DEFAULT ... Voice Mail Group 1 (440) Busy Leave Mail Index is set to none (#).



## VMID Station Numbers

### Description

The VMID Station Numbers feature must be used **after** changing station numbers with the Flexible Numbering feature. Voice Mail ID numbers will be changed to match current station numbers once HOLD is pressed. (Eliminates need for technician to program individual VMID numbers.)



*This feature should be accomplished after the flexible numbers are assigned. Implementing this feature could cause the VM box numbers to be re-programmed.*

### Programming Steps

1. Press VMID STATION button (**FLASH 06, Button #15**). The following message displays:

VMID SAME AS STA #  
PRESS HOLD

2. Press HOLD to save the entry. A confirmation tone sounds.

## VM Transfer with ID Digits

### Description

The Voice Mail Index feature provides an Attendant or station user a way to transfer a caller directly into a voice mail box. Station identification digits can be entered by the transferring party.

Using this feature, a caller can be transferred to a voice mail box when:

- A station user on the system is not forwarded to VM, or
- The destination voice mail box owner is not a station user.

CO trunks and internal calls may be transferred into voice mail using this feature. If no voice mail ID digits are dialed by the transferring station, the ID digits of the transferring station are sent to voice mail.

This feature permits dialing digits 000-9999 when using the VM with ID feature. On a per station basis, the ID number that is sent to voice mail can be flexible.

By default, the station number is sent to the voice mail system. In FLASH 50, Page B, Button #13 of administrative programming, there is a field to insert from 0-4 digits (0000-9999) which can be sent to the voice mail system in place of the station number. This is useful when a station user manually transfers a caller to a mailbox.

## Operation

When a caller wants to be transferred into a user's Voice Mailbox and that user's station is not forwarded into voice mail, the Attendant or a station user may initiate a Voice Mail Transfer in one of the following methods:

1. The initiating station presses the TRANS button.
2. Dial the Voice Mail Group number,  
-or-  
Press the preprogrammed VM group button.
3. Dial the desired party's VMID (Mailbox location) and go on-hook. The system makes the connection to an available Voice Mail port and sends the Leave Mail Prefix (if any) plus the digits dialed as the VMID number, then the Leave Mail Suffix digits (if any). The system then cuts through the transferred caller.



*The VMID (mail box location) can be any number between 000 through 999. If 4-digit VMID (Flash 09) is enabled, the range is between 0000 through 9999. The use of 000 or 0000 results in no voice mail ID digits being passed to the voice mail unit.*

-or-

1. The initiating station presses the TRANS button.
2. The initiating system presses the Voice Mail button.
3. Press DSS button to transfer desired party's Voice Mail ID.
4. Go on-hook.

## Conditions

- » CO Trunks and Internal Calls may be transferred into Voice Mail using this feature.
- » If no VMID digits are dialed by the transferring station, the identification digits of the transferring station are sent to VM.

## VM Tone Mode Calling Option

### Description

Voice Mails Systems and/or Automated Attendants can utilize the Calling Station Tone Mode option. This is useful when using supervised transfer or call screening options on voice mail or Auto Attendant(s) requiring ring back tone for proper call handling.

The VM Tone Mode Calling feature lets the Voice Mail system override a called station's H or P intercom settings.

### Operation

The VM system must be programmed when placing a call to a station and Tone Ringing is desired.

1. Dial [6#] on the dial pad.
2. Dial the station extension (call tone rings station).

## Voice Mail ID Translation

### Description

The Voice Mail ID Translation feature enables programming of the station number sent to the Voice Mail via In-Band integration. By default, the station number is sent to the Voice Mail system. In station programming, there is a field to insert a 4-digit entry (0000-9999) which can be sent to the Voice Mail system in place of the station number. (FLASH 67, Button #4 enables the VMID digit length.)

Use Flash 50 programming when you want to modify a range of stations' attributes using **fixed** station numbers.

Use Flash 51 programming to modify a single station's attributes using a **flexible** station number.

### Programming Steps

1. Press **FLASH** and dial **[50]** or dial **[51]**. Flexible button #24 (New Range) is lit and one of the following messages displays:

#### Flash 50 - Fixed Numbers

STATION ATTRIBUTES  
SELECT A STATION RANGE

#### Flash 51 - Flexible Numbers

ENTER STATION NUMBER

2. Enter the range of **fixed** station numbers (100-149) to be programmed. If only one station is being programmed, enter that number twice, e.g., [100 100].



If **HOLD** is pressed without entering a station range, all stations are selected.

-or-

Enter a valid **flexible** number (100-8999) to be programmed.

3. Press **HOLD** to save the entry. A confirmation tone sounds and the display updates. Flexible button #19 is lit. The display updates to reflect current programming for Page A:

#### Flash 50 - Fixed Numbers

XXX - XXX PAGE A  
ENTER BUTTON NUMBER

XXX-XXX = fixed station range

#### Flash 51 - Flexible Numbers

SXXX PAGE A  
ENTER BUTTON NUMBER

XXX = 3- or 4-digit flexible number

4. Press button #20. The display updates to reflect current programming for Page B.

**Flash 50 - Fixed Numbers**

|   |
|---|
| XXX - XXX PAGE B<br>ENTER BUTTON NUMBER |
|---|

*XXX-XXX = fixed station range*

**Flash 51 - Flexible Numbers**

|                                    |
|------------------------------------|
| SXXX PAGE B<br>ENTER BUTTON NUMBER |
|------------------------------------|

*XXX = 3- or 4-digit flexible number*

5. Press the VOICEMAIL ID flexible button (**Button #13**). The following message displays:

|                                     |
|-------------------------------------|
| VOICEMAIL ID      0000-9999<br>0100 |
|-------------------------------------|

6. Enter a VM ID number which corresponds to 0000 to 9999.  
 7. Press HOLD to update the table. A confirmation tone sounds and the display updates.

DEFAULT... Station Numbers are assigned as VMID Digits.

**Conditions**

- » Only one station at a time can be programmed when using a flexible station number.
- » When in Flash 51 programming, if you press HOLD without specifying a flexible number to be programmed, you will get the station that is in port/station 100.

## Message Waiting Indication

**Description**

When Voice Mail receives a voice message for a user who has a station on the STSe System, the VM connected to the system can leave a message indication at the VM user's station. When the station retrieves their mail, the VM system can cancel the message waiting indication left at a station via a VM port.

The message waiting indication displays on the programmed Voice Mail (group) button. If such a button was not programmed, a voice mail message waiting indication displays on the MSG WAIT button as a normal message waiting signal.

The LCD Message Indication feature presents the number of new Voice Messages to users on their LCD display. The new VM LCD message on the keyset takes priority over Forward, DND, Messages, and idle displays. Ringing, Recalling, Outgoing Calls, and current call operation displays override the VM message display for the duration of the call or operation.

## Operation

If your Message Waiting button or programmed Voice Mail Group button is flashing, you may have a voice message waiting.

### **To enter the voice mail system to check for mail:**

1. Dial the Voice Mail Group number [440-447],  
-or-  
Press the preprogrammed Voice Mail group button or flashing Message Wait button,  
-or-  
Use the Soft Key's VM1 option (group 440 only).
2. When prompted, enter the mailbox password.

## Message Wait / VM Button Flash Rate

### Description

The Message Wait/VM Button flash rate is the rate at which the Message Wait and VM flexible button(s) flashes when you receive a message/voice mail message. This flash rate can be programmed to 29 different options identified in the flash rate table. This enables the programmer to customize the key system configuration to desired flash rates.



The fixed message button should not be used as a Voice Mail button.

### Programming Steps

1. Press the MSG WAIT/VM BTN flexible button (**FLASH 07, Button #4**). The following message displays:

|                   |       |
|-------------------|-------|
| MSG WAIT / VM BTN | 00-28 |
| RED STEADY ON     |       |

2. Enter a valid number (00-28) on the dial pad to correspond to one of the 29 available options (refer to [Table 2-16 on page 2-163](#)).
3. Press HOLD to save the entry. A confirmation tone sounds and the display updates.

DEFAULT ... Message Wait/VM Button flash rate is set for a Red Steady On (01).

## *Voice Mailbox Button*

### **Description**

A correctly programmed button will receive a message-waiting indication (MWI) from the voice mail system. This allows any station with multiple voice mail buttons to receive the MWI for each of the programmed buttons.

Station feature codes 460-467 represent voice mail groups 440-447 respectively. The functions of these codes are to provide:

- Direct mailbox access for local stations. This allows an Attendant to have one-button transfer directly to a mailbox.
- Multiple MWI capability per key station. This allows one station to have MWI for multiple mailboxes.
- Multiple direct mailbox access. This allows one-button access to different mailboxes from one keyset.

### **To program a Mailbox Button:**

1. Press SPEED twice.
2. Press the desired flexible button to be programmed.
3. Dial the mailbox feature access code (460-467 = voice mail group 1-8).
4. Dial the VMID number.

For example, 4606037 represents a mailbox button (group 1) for VMID 6037.



SINGLE LINE TELEPHONE

Not applicable

## *Voice Mail Group Button*

### **Operation**

#### **To program a VM GROUP button:**

1. Press SPEED twice.
2. Press the desired flexible button to be programmed.
3. Dial a 3-digit VM Group number (440-447 = voice mail groups 1-8).

## *Voice Mail Group Access*

### **Operation**

#### **To access a VM Group:**

Dial VM Group number (440-447),

-or-

Press preprogrammed VM Group flexible button,

-or-

Use Soft Key's VM1 option when in an idle condition (to access group 440).

## Initialize Voice Mail Group Parameters

### Description

VM Group Parameters may be initialized, setting all data fields to their original default values.

**Table 2-29: Voice Mail Group Defaults**

| Program Code | Flexible Button   | Features                         | Default Value (after initialization)  |
|--------------|-------------------|----------------------------------|---|
| FLASH 65     | VOICE MAIL GROUPS |                                  |   |
|              | 1-8               | Voice Mail Groups (440-447)      | None  |
|              | 9                 | Alternate Voice Mail Group       | None  |
|              | 10                | Standard Leave Mail Index Entry  | VM Group 1 Index = 0  |
|              | 11                | Retrieve Mail Index Entry        | VM Group 1 Index = 1  |
|              | 12                | Station Assignments              | None  |
|              | 13                | No Answer Leave Mail Index Entry | VM Group 1 Index = # (none)   |
|              | 14                | Busy Leave Mail Index Entry      | VM Group 1 Index = # (none)   |
| FLASH 66     | 1-8               | Voice Mail In-Band Signaling     | Table 0: Pre=P7, Suf=None<br>Table 1: Pre=P7, Suf=✱<br>Tables 2-6: None<br>Table 7: Pre=P7, Suf=2 |
|              | 9                 | Voice Mail Disconnect Table      | None  |
| FLASH 67     | 1                 | Voice Mail In-Band Digits        | Enabled   |
|              | 2                 | Voice Mail Transfer/Forward      | Enabled   |
|              | 3                 | Voice Mail Broker                | Enabled   |
|              | 4                 | VMID Digit Length                | 3   |
|              | 6                 | VM Port                          | Disabled  |
|              | 7                 | VM Port Number                   | 3   |

### Programming Steps

1. Press the VOICE MAIL GROUPS flexible button (**FLASH 80, Button #12**). The following message displays:

|   |
|---|
| <p>INITIALIZE VM GROUP<br/>PRESS HOLD</p> |
|---|

2. Press the HOLD button. A confirmation tone sounds.

## Print Voice Mail Group Parameters

### Description

The Print Voice Mail Group command dumps the entire database as a permanent record which can serve as a hardcopy of the database. The system baud rate must match that of the printer or receiving device. When printing the VM Group Parameters, the following data prints:

- Voice Mail Group Parameters
- Voice Mail Outpulsing Table (including the disconnect table)
- Voice Mail Options

| VM  | ALT | LEV | RET | STN# | Mailbox Table |       |    |
|-----|-----|-----|-----|------|---------------|-------|----|
| 440 |     | 0## | 1   |      | Index         | Group | ID |
| 441 |     | ### | #   |      | 1             | 440   |    |
| 442 |     | ### | #   |      | 2             | 440   |    |
| 443 |     | ### | #   |      | 3             | 440   |    |
| 444 |     | ### | #   |      | 4             | 440   |    |
| 445 |     | ### | #   |      | 5             | 440   |    |
| 446 |     | ### | #   |      | 6             | 440   |    |
| 447 |     | ### | #   |      | 7             | 440   |    |
|     |     |     |     |      | 8             | 440   |    |
|     |     |     |     |      | 9             | 440   |    |
|     |     |     |     |      | 10            | 440   |    |
|     |     |     |     |      | 11            | 440   |    |
|     |     |     |     |      | 12            | 440   |    |
|     |     |     |     |      | 13            | 440   |    |
|     |     |     |     |      | 14            | 440   |    |
|     |     |     |     |      | 15            | 440   |    |
|     |     |     |     |      | 16            | 440   |    |
|     |     |     |     |      | 17            | 440   |    |
|     |     |     |     |      | 18            | 440   |    |
|     |     |     |     |      | 19            | 440   |    |
|     |     |     |     |      | 20            | 440   |    |
|     |     |     |     |      | ..            | ...   |    |
|     |     |     |     |      | ..            | ...   |    |
|     |     |     |     |      | 240           | 440   |    |
|     |     |     |     |      | 241           | 440   |    |
|     |     |     |     |      | 242           | 440   |    |
|     |     |     |     |      | 243           | 440   |    |
|     |     |     |     |      | 244           | 440   |    |
|     |     |     |     |      | 245           | 440   |    |
|     |     |     |     |      | 246           | 440   |    |
|     |     |     |     |      | ...           | ...   |    |
|     |     |     |     |      | ...           | ...   |    |
|     |     |     |     |      | 255           | 440   |    |

**Figure 2-27: Voice Mail Group Parameters Printout**



## Programming Steps

1. Press the VOICE MAIL GROUP flexible button (**FLASH 85, Button #13**). The following message displays:

```
PRINT VM GROUP  
PRESS HOLD
```

2. To print data for Voice Mail Group Parameters, press HOLD. The following displays:

```
PRINTING VM GROUP
```

When the system finishes sending the requested information to the printer, a confirmation tone sounds.

---

## Voice Mail In-Band Features

### *In-Band Signaling Integration*

#### Description

The STSe allows programming so that if a station programmed to receive incoming CO line ringing is forwarded to Voice Mail, they may have incoming callers routed directly into their station's voice mail box through the use of In-Band signaling. Alternately, incoming CO lines can be programmed to ring directly into the Voice Mail system. In this case, callers are answered by the Voice Mail or Auto Attendant Main greeting.

Incoming CO callers can be call forwarded into Voice Mail automatically, if a Preset Forward Destination is programmed for that CO line and the same CO line programmed to ring at one station. CO lines may also be programmed to ring at an Attendant station, call forward into the Voice Mail system (if programmed to ring at one Attendant station) and presented to the main greeting (not the Attendant station's mailbox - except in the case of DID. DID digits are sent to the VM) even when ID digits are enabled.

Entries into the Voice Mail In-Band Features determines the in-band signaling required for ICID Incoming ID Digits (forwards incoming CO callers directly to a Station's Voice Mailbox), and Forward to VM Groups (lets voice mail calls, upon reaching a forwarded to VM station, forward back into the voice mail system).

#### Programming Steps

Press **FLASH** and dial **[67]**. The following message displays:

```
VM FEATURES  
ENTER BUTTON NUMBER
```

## *Voice Mail In-Band Digits*

### **Description**

The Voice Mail In-Band Digits feature enables and disables station in-band signaling. Incoming CO callers can be Station Call Forwarded into voice mail only when the ringing CO line is programmed to ring at one station. CO lines programmed to ring at an Attendant station, call forward into the voice mail system (if programmed to ring only at one Attendant station). Callers are presented to the main greeting (not the Attendant station's mailbox - except in the case of DID. DID digits are sent to the VM) even when ID digits are enabled.

### **Programming Steps**

1. Press the IN-BAND DIGS CO CALL flexible button (**FLASH 67, Button #1**). The following message displays.

|                      |     |
|----------------------|-----|
| IN-BAND DIGS CO CALL | 0-1 |
| ENABLED              |     |

2. Enter a 0 or 1 to Enable/Disable this feature.  
[0] = Disabled  
[1] = Enabled
3. Press HOLD to save the entry. A confirmation tone sounds and the display updates.

DEFAULT ... ID Digits for incoming CO calls is enabled.

## *Voice Mail Transfer / Forward*

### **Description**

The Voice Mail Transfer/Forward feature forwards voice mail calls, upon reaching a forwarded to VM station, back into the voice mail unit. It is useful when VM ports are being used as both Auto Attendant and VM ports. This feature can be enabled/disabled for all VM groups.

### **Programming Steps**

1. Press the FORWARD TO VM GROUPS flexible button (**FLASH 67, Button #2**). The following message displays:

|                      |     |
|----------------------|-----|
| FORWARD TO VM GROUPS | 0-1 |
| ENABLED              |     |

2. Enter a 0 or 1 to Enable/Disable this feature.  
[0] = Disabled  
[1] = Enabled
3. Press HOLD to save the entry. A confirmation tone sounds and the display updates.

DEFAULT ... VM Transfer/Forward feature is enabled.

## Voice Mail Broker

### Description

The Voice Mail Broker Calls feature modifies the operation of voice mail ports when disabled. Broker operation is unavailable when using supervised transfers to stations. When enabled, the current broker mode operation during supervised transfers remains in effect. This means the call to the station remains as the second party in a broker mode. If disabled, the VM port disconnects the call to a station and returns to the original party.

### Programming Steps

1. Press the VM BROKER CALLS flexible button (**FLASH 67, Button #3**). The following message displays:

|                 |     |
|-----------------|-----|
| VM BROKER CALLS | 0-1 |
| ENABLED         |     |

2. Enter a 0 or 1 to Enable/Disable this feature.  
[0] = Disabled  
[1] = Enabled
3. Press HOLD to save the entry. A confirmation tone sounds and the display updates.

DEFAULT ... VM Broker feature is enabled.

## Voice Mail ID Digit Length

### Description

The Voice Mail ID Digit Length feature modifies the station and CO voice mail identification fields such that the maximum length of these fields is four digits.

### Programming Steps

1. Press the VM ID DIGITS flexible button (**FLASH 67, Button #4**). The following message displays:

|              |     |
|--------------|-----|
| VM ID DIGITS | 2-4 |
| 3            |     |

2. Enter a valid number (2, 3, or 4) that corresponds to the number of digits to be dialed.
3. Press HOLD to save the entry. A confirmation tone sounds.

DEFAULT ... VMID length is set to 3 digits.

## Voice Mail Modem Access

### Description

You can program Vodavi voice mail systems (other than MiniVoice or PathFinder) using the telephone system modem.

### Programming Steps

To enable or disable the VM port:

1. Press the VM PORT flexible button (**FLASH 67, Button #6**). The following message displays:

|                     |     |
|---------------------|-----|
| VM PORT<br>DISABLED | 0-1 |
|---------------------|-----|

2. Enter a 0 or 1 on the dial pad to enable/disable this feature.  
[0] = Disabled  
[1] = Enabled
3. Press HOLD to save the entry. A confirmation tone sounds and the display updates.

DEFAULT . . . VM Port is disabled.

To indicate which port is used to connect the voice mail system and the telephone system:

1. Press the VM PORT NUMBER flexible button (**FLASH 67, Button #7**). The following message displays:

|                      |     |
|----------------------|-----|
| VM PORT NUMBER:<br>2 | 2-2 |
|----------------------|-----|

2. Enter a valid number (2) to indicate the port to be used.
3. Press HOLD to save the entry. A confirmation tone sounds and the display updates.

DEFAULT . . . VM Port Number is Port 2.

### Operation

To access the voice mail system, you can either:

Dial [498]

-or-

Ring directly to 498

-or-

Be transferred to 498

### Conditions

- » The use of this feature requires the use of a straight-thru RS-232 cable connected from the voice mail system to Port 2 on the STSe system.

## Voice Mail One-Touch Recording

### Description

The Voice Mail One-Touch Recording feature allows the station user, while on an external call, to press a button and have the system record the conversation in the station user's mailbox. Code [649]+[VVV], where VVV=440-447 for desired VM group.

One-Touch Record uses Table 7 from the Voice Mail Outpulsing Table (refer to [page 2-351](#)).



*Use of this feature when the One-Touch Recording Warning Tone is disabled may be interpreted as a violation of federal, state or local laws, and an invasion of privacy. Check applicable laws in your area before recording calls using this feature.*

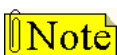

*MiniVoice does not support Voice Mail One-touch recording.*

### Operation

#### **While on an internal or external call:**

1. Press the preprogrammed VM RECORD button, or use the Soft Key's REC option (for VM Group 440 only). The LED flutters red at 240 ipm during the setup and the following message displays:

|  |
|--|
| RECORDING SETUP<br>MMM DD YY                      00:00 am |
|--|

2. Once the system connects to the station user's mailbox, the flexible button LED lights solid green and the LCD displays:

|  |
|--|
| RECORDING<br>MMM DD YY                      00:00 am |
|--|

3. When you finish recording, press the preprogrammed VM RECORD button or use the Soft Key's STOP option. The LED extinguishes and the normal LCD call information displays.



SINGLE LINE TELEPHONE

Not applicable

## Conditions

- » If you hang up without terminating the record function, the system performs the exit procedure as described in step 3 above.
- » If you press the TRANS, CAMP ON, MSG, or FWD buttons during recording, pressing the button is ignored.
- » During the recording setup, pressing the CONF button is ignored.
- » If a VM port is **not available** when you want to record, you receive the following display (lasts six seconds):

|  |
|--|
| RECORDING UNAVAILABLE<br>MMM DD YY                    00:00 am |
|--|

(You may retry after the display extinguishes.)

- » In the recording mode, pressing the CONF button lets you add members to the recording (conference). Normal conference operation/conditions apply.
- » If the FLASH or HOLD button is pressed during the recording, the recording is terminated.
- » If you press the record button while in a two-party conference, it is recorded. If you press the button a second time, the conference ends and the call returns to a two-way conversation.
- » Only one active recording per station is allowed.
- » If a conference is being recorded and the conference master exits, the recording stays active. The recording stops if the initiator re-enters the conference and ends it, removes the record function, or the conference ends on its own.
- » Only the initiator of a conference can invoke/remove the record function during a conference.
- » A conference warning tone is not given to conference members, if the initiator is recording the conference and record tone is disabled.
- » Recording is not allowed for a station that is barged in, Executive Overridden, or on an active OHVO call.
- » An Unsupervised Conference Call can be recorded.
- » One-Touch Recording uses Table 7 from the Voice Mail Outpulsing Table (refer to [page 2-351](#)).
- » Recordings made using the Soft Key are stored in VM group 440.
- » This feature only applies to digital voice mail systems.

## One-Touch Recording Warning Tone

### Description

The One-Touch Recording Warning Tone feature lets the installer enable/disable the One-Touch Recording Warning Tone on a system-wide basis.



*Use of this feature when the One-Touch Recording Warn Tone is disabled may be interpreted as a violation of federal, state, or local laws, and an invasion of privacy. Check applicable laws in your area before recording calls using this feature.*

### Programming Steps

1. Press the ONE-TOUCH RCD WARNING TONE flexible button (**FLASH 06, Button #10**). The following message displays:

|                     |     |
|---------------------|-----|
| RECORDING WARN TONE | 0-1 |
| ENABLED             |     |

2. Enter a 0 or 1 on the dial pad to enable/disable the use of this feature.
  - [0] = Disabled
  - [1] = Enabled
3. Press HOLD to save the entry. A confirmation tone sounds.

DEFAULT ... Recording Warning Tone is enabled.

---

## Voice Mail Outpulsing Table

### Voice Mail In-Band Signaling

#### Description

Entries in one of the eight Voice Mail Outpulsing Tables determine the In-Band signaling required for:

- Retrieving messages (allows stations to pick up mail).
- Leaving messages (allows stations to leave messages in voice mail).

#### Suggested Uses:

- Build a table (0 for example) for any additional digits other than the station extension number (e.g., Voice Mail Box number) needed for a caller to leave a message in a station's mailbox (Leave).
- Build another table (1 for example) for any additional digits needed for a mailbox holder to retrieve a message (Retrieve). By Default:

**Table 0** Prefix = P7 (Pause+7) Suffix = None

**Table 1** Prefix = P7 (Pause+7) Suffix = \*

**Table 7** Prefix = P7 (Pause+7) Suffix = 2 (Used for One-Touch Record)

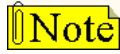

Entries are not required in the Outpulsing Table. However, a table must be referenced when setting up the Voice Mail groups for the system to send digits to the voice mail.

### Programming Steps

1. Press FLASH and dial [66]. The following message displays:

|       |     |                    |
|-------|-----|--------------------|
| VOICE | PRE | XXXXXXXXXXXXXE     |
| MAIL  | Y   | SUF XXXXXXXXXXXXXE |

Y = Table Index (0-7)

X = Entered Digits (0-9, #, \*, Pauses)

2. The TABLE 00 flexible button (Button #1) led is lit. To change tables, press the appropriate flexible button (Buttons 2-8) and perform the following procedures.
3. Dial one of the following, when required:
  - [0] = If a prefix is required
  - [1] = If a suffix is required
  - [#] = If entry is to be deleted
4. Enter up to 12 digits, including [\*] and [#], TRANS button = pause.
5. Press HOLD to save the entry. A confirmation tone sounds and the display updates.

#### **To clear entries in a table:**

Press the pound key once [#], followed by HOLD.



## Voice Mail Disconnect Table

### Description

A disconnect signal can be programmed into the STSe system to notify the VM system that a call has been abandoned. This is accomplished through in-band signaling. If a CO or Intercom disconnect signal is detected, the STSe system sends a series of DTMF digits programmed in the voice mail disconnect table to the voice mail port. This can be any digit stream up to 12 digits including [\*] and [#].

This table serves all eight voice mail groups. When no digits are programmed in the disconnect table, silence is provided to the voice mail port followed by busy tone to aid the voice mail system to recognize that the caller has abandoned the call.

The STSe system provides Loop Supervision monitoring while a CO call is connected to a port designated as voice mail and passes the Supervision to the voice mail.

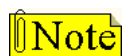

*Loop Supervision must be enabled on the CO lines (in CO Line programming) for the VM Disconnect feature to operate.*

### Programming Steps

1. Press the DISCONNECT TABLE 8 flexible button (**FLASH 66, Button #9**). This table number is used for the voice mail disconnect signal.
2. Enter up to 12 digits used for the disconnect signal, including [\*] and [#], TRANS button = pause.

|             |
|-------------|
| VOICE DIS E |
| MAIL        |

3. Press HOLD to save the entry. A confirmation tone sounds and the display updates.

DEFAULT ... There are no entries in the Disconnect Table (Table #8).

---

## Voice Mail System Message Wait Indications

### **Description**

The analog voice mail system will automatically produce message waiting indications. If there are problems with message waiting indications, a system administrator or technical support personnel can connect an SLT to the voice mail system and use the following procedures to simulate message waiting information.

### **Operation**

#### ***Enabling a Voice Mail Message Wait***

To receive a message waiting indication that one or more voice message(s) is waiting, the Voice Mail system must be programmed to provide the indication to a specific user. The system administrator does this programming using the following procedure.

1. Dial the Voice Mail Message Set code [420] on the dial pad.
2. Dial the 2- to 4-digit mailbox number of the station user who will receive voice messages.

#### ***Turning Off the Message Waiting Lamp***

The voice mail system must be programmed to go off-hook when a station user retrieves the voice messages from the voice mail system. The system administrator does this programming using the following procedure.

1. Dial the Voice Mail Message Cancel code [421] on the dial pad.
2. Dial the 2- to 4-digit mailbox number of the station user who will receive voice messages.

#### ***Enabling a Voice Mail Message Wait with Count***

To receive a message waiting indication that voice message(s) are waiting and the number of messages that are in the mailbox, the Voice Mail system must be programmed to provide these indications to a specific user. The system administrator does this programming using the following procedure.

1. Dial the Voice Mail Message Set w/Count code [422] on the dial pad.
2. Dial the 2- to 4-digit mailbox number of the station user who will receive voice messages.
3. Dial a 3-digit number (000-127) that represents the amount of voice mail messages in the mailbox.

### **Conditions**

Only VM extensions are allowed to turn ON/OFF VM message wait indications.

---

## Volume Control

### Operation

The volume control on the Digital Key Telephone controls ringing, handset, and speakerphone volumes. It also affects the receive volume of the Wanderer cordless unit.

While using these function/features, Digital Key Telephones display the following messages:

#### ***Listening to Background Music ...***

|             |          |
|-------------|----------|
| SPEAKER BGM | [#####]  |
| MMM DD YY   | HH:MM am |

#### ***Using the speakerphone on an Intercom call ...***

|              |          |
|--------------|----------|
| SPEAKER CALL | [#####]  |
| MMM DD YY    | HH:MM am |

#### ***Using the handset on an Intercom call ...***

|             |          |
|-------------|----------|
| HANDSET ICM | [#####]  |
| MMM DD YY   | HH:MM am |

#### ***Using the speakerphone on a CO call ...***

|              |          |
|--------------|----------|
| SPEAKER CALL | [#####]  |
| MMM DD YY    | HH:MM am |

#### ***Using the handset on a CO call ...***

|            |          |
|------------|----------|
| HANDSET CO | [#####]  |
| MMM DD YY  | HH:MM am |

#### ***Receiving a page announcement ...***

|              |          |
|--------------|----------|
| SPEAKER PAGE | [#####]  |
| MMM DD YY    | HH:MM am |

**Receiving an incoming tone ringing Intercom or CO call ...**

|              |          |
|--------------|----------|
| SPEAKER RING | [#####]  |
| MMM DD YY    | HH:MM am |

**SINGLE LINE TELEPHONE**

The volume control on the Vodavi Single Line Telephone is located on the right side of the telephone. The slider switch options are HI for loud volume, LO for low volume, and OFF to turn the ringer off. Two-line models have a volume switch for each line. Certain models do not have an OFF option.

Speakerphone models have a sliding volume switch to adjust speakerphone volume. Slide the switch toward you for lower volume or away from you for increased speakerphone volume.

Each model has a volume button that can be pressed to increase or decrease the handset volume.

The B/Z ringer switch of 2700-series SLTs is located on the bottom of the telephone near the line jacks. This switch should be set to the Z mode for business/hospitality applications and to the B mode for residential applications.



*The MSG light and the Line In Use (LIU) LEDs will not operate when set in the B ringer mode.*

For single line telephones that are not equipped with a volume control slider switch or to increase the volume greater than that allowed by the slider switch, use the following steps.

**While on a CO line call or an intercom call:**

1. Press the FLASH button.
2. Dial 638.
3. Dial a valid number (0-9) to select a volume level.

-or-

Use [\*] or [#] to scroll to increase or decrease volume level.

Volume selections relate to a baseline volume. The options are:

|           |           |
|-----------|-----------|
| 0 = -15DB | 5 = 0DB   |
| 1 = -12DB | 6 = 3DB   |
| 2 = -9DB  | 7 = 6DB   |
| 3 = -6DB  | 8 = 7.5DB |
| 4 = -3DB  | 9 = 9DB   |

4. Press the FLASH button to return to the call.

---

---

# 3

## Attendant Features and Operation

The Attendant and Attendant(s) with DSS/BLF features of the STSe System are listed and described in alphabetical order. Attendant features are in addition to digital station features.

The instructions in this chapter are based on the use of a digital display telephone.

» » » » » » » »

# NOTES

» » » » » » » »

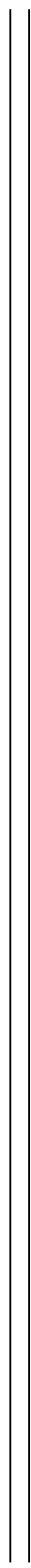
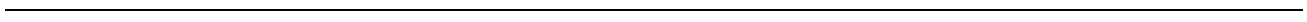

---

## Introduction

The instructions in this chapter are based on the use of a digital display telephone. The STSe System provides the following keys, indicators and features:

**Handset and Speaker** are located at the left side of the front panel. A handset is provided to allow confidential conversation when desired. Lifting the handset from its cradle (going off-hook) disengages the station's built-in speaker. The speaker is located directly below the center portion of the handset. The station may be operated with the handset on-hook. When this occurs, audio is transmitted to the station user through the station's speaker.

**Fixed Feature Buttons** function as follows:

- VOLUME BAR lets the user adjust ringer, speakerphone and handset volume.
- H-T-P lets the user select the ICM Signaling Mode, handsfree tone, or privacy.
- FLASH button terminates an outside call and restores dial tone without hanging up the handset. It also transfers calls behind a PBX or Centrex within those systems.
- CAMP ON button lets you alert a busy party to an outside line that is on hold and waiting.
- MSG (Message Wait) button lets you initiate a message waiting indication at stations that are busy, unattended, or in Do Not Disturb. Message Waiting Callback request left at your station is indicated by a flashing MSG WAIT LED.
- SPEED button gives you access to speed dialing, save number redial and last number redial. This button also accesses flexible button programming.
- TRANS (Transfer) button transfers an internal or external call from one station to another.
- CONF (Conference) button establishes and builds conference calls.
- FWD (Forward) button lets you forward your calls to another destination.
- ON/OFF button lets you make a telephone call without lifting the handset. It turns the telephone on and off when using the speakerphone.
- MUTE button lets you switch the built-in microphone on or off when using the speakerphone, or the handset microphone when using the handset.
- HOLD button lets you place an outside caller on hold.
- Interactive Soft Keys are used to work in conjunction with fixed and flexible features.

**Flexible Buttons** access idle outside lines, provide DSS/BLF for internal stations, access speed dial numbers and activate features. These buttons can be programmed by the individual station user. The default flexible feature buttons are described as follows:

- CALL BACK button lets you initiate a call back request to another busy station. As soon as that station becomes idle, the station that left the call back request is automatically signaled. A flexible button must be assigned to use this feature.
- PICK-UP button lets you pickup a tone ringing intercom call, transferred, incoming, or recall an outside line call to a specific unattended station by group or directed call pickup.
- DND (DO NOT DISTURB) button. On Attendant stations, this button becomes the system Night Mode button. A flexible button must be assigned to use this feature.
- LINE QUEUE button lets you queue onto an outside line when all lines in a group are busy. Your station is placed in queue awaiting a line in the same group to become available.

**Outside Calls** are announced by a tone signal repeated every 3.2 seconds. The corresponding outside line indicator flashes slowly.

**Intercom Calls** can be tone ringing or voice announce. If it is voice announced, the receiving station receives two bursts of tone prior to the announcement. If it is a tone ringing call, the receiving station hears a tone ring every 2.4 seconds.

---

## Attendant Features - Index

**Table 3-1: Attendant Features**

| <b>Features</b>                              | <b>Page</b>          |
|--|----------------------|
| <b>ATTENDANT FEATURES</b>                    |                      |
| 911 ALERT                                    | <a href="#">3-5</a>  |
| ATTENDANT CO LINE EXTERNAL (OFF-NET) FORWARD | <a href="#">3-6</a>  |
| ATTENDANT CUSTOM MESSAGE                     | <a href="#">3-7</a>  |
| ATTENDANT DAY/NIGHT/SPECIAL                  | <a href="#">3-8</a>  |
| ATTENDANT DIRECTORY LIST PROGRAMMING         | <a href="#">3-9</a>  |
| ATTENDANT DISABLE OUTGOING CO LINE           | <a href="#">3-12</a> |
| ATTENDANT OVERRIDE                           | <a href="#">3-13</a> |
| ATTENDANT SETTING TIME AND DATE              | <a href="#">3-14</a> |
| ATTENDANT STATION ASSIGNMENT                 | <a href="#">3-15</a> |
| ATTENDANT UNAVAILABLE                        | <a href="#">3-16</a> |
| ATTENDANT VOICE MAIL ALARM CLEAR             | <a href="#">3-17</a> |
| DISPLAY TIMER                                | <a href="#">3-21</a> |
| ICLID CALL MANAGEMENT TABLES                 | <a href="#">3-22</a> |
| RECALL                                       | <a href="#">3-24</a> |
| RELEASE BUTTON                               | <a href="#">3-24</a> |
| SPEED DIAL - SYSTEM STORING                  | <a href="#">3-25</a> |
| <b>ATTENDANT WITH DSS/BLF FEATURES</b>       |                      |
| BUSY LAMP FIELD INDICATORS                   | <a href="#">3-17</a> |
| DIRECT STATION CALLING                       | <a href="#">3-17</a> |
| MAPPING OPTIONS                              | <a href="#">3-18</a> |
| TRANSFER SEARCH                              | <a href="#">3-17</a> |
| STATION ID FOR DSS/BLF CONSOLE WITH MAP      | <a href="#">3-21</a> |



---

## 911 Alert

### Description

Any station user or Attendant who programs a flexible button for 911 ALERT (feature code 608) will be alerted of internal stations placing 911 calls. The system can store the sixteen most recent 911 calls. Calling information includes the time/date of the call, as well as the station number from which the call was placed.

The initial 911 Alert indications include:

- Audible ringing tone
- Green flashing 911 ALERT flexible button LED
- Automatic LCD display of 911 call information

|           |     |          |
|-----------|-----|----------|
| E911 CALL | XX: | STA XXXX |
| MM/DD/YY  |     | HH:MM    |

*XX = Index number (01-16)*

### Operation

Station users and Attendants can press the 911 ALERT flexible button as necessary to view additional 911 calls' information in the stored list. After a station user or Attendant views the information for all 911 calls in the system list:

- All users' LEDs change to a solid red indication.
- The audible ringing tone at all stations ceases.
- The LCDs at all stations revert to a normal display.

The list remains available for review by pressing the 911 ALERT flexible button as necessary, until after the messages are deleted.

#### **To delete logged 911 Alert messages:**

An Attendant uses the following steps to delete the messages on a system-wide basis.

1. Press the 911 ALERT flexible button to display the 911 call information for deletion.
2. Press FLASH to delete that message.

---

## Attendant CO Line External (Off-Net) Forward

### Description

The Attendant CO Line External (Off-Net) Forward feature lets the first Attendant station forward incoming CO calls to an off-net location. The Attendant must have a direct appearance of the CO line to be forwarded. Forwarding can be established on a per CO line group basis or on an all CO line groups basis. In a speed dial bin, store the number of the off-net location where calls are to forward. Follow instructions provided for storing station or system speed dial numbers.

### Operation

#### **To activate off-net forwarding:**

1. Dial [603] on the dial pad,  
-or-  
Press preprogrammed CO OFF-NET FORWARD button.
2. Dial the CO group access code of the group to be forwarded:  
[801-823] = CO Group 1-23  
[824] = All CO Groups
3. Dial the speed bin number that contains the number where calls are to forward. A confirmation tone sounds.

#### **To cancel off-net forwarding:**

1. Dial [603] on the dial pad,  
-or-  
Press preprogrammed CO OFF-NET FORWARD button.
2. Dial the CO group access code.
3. Dial [#] on the dial pad. A confirmation tone sounds.

### Conditions

- » When CO lines are off-net forwarded, these lines display unique flash rates at the Attendant station.

---

## Attendant Custom Message

### Description

The Attendant Custom Message feature allows the first programmed Attendant (system administrator) to enter up to ten custom messages for system-wide use by station users. Up to 24 characters may be entered as the custom message (this represent 48 digits entered).

A station user may store any of the available messages under a flexible button assigned as a Message Access button. These messages may be specified and customized by the customer on a system-wide basis.

Message status is stored in a battery-protected area of memory for retention in the event of a power failure or system reset (soft or hard).

### Operation

#### **Program the ten custom messages at the first Attendant station as follows:**

1. Dial the Custom Message program code [694] on the dial pad. The following message displays:

|              |          |
|--------------|----------|
| ENTER MSG NO |          |
| MMM DD YY    | HH:MM am |

2. Enter a valid message bin number [21–30]. The following message displays after the bin number has been selected.

|               |
|---------------|
| mmmmmmmmmm... |
| ENTER MSG:    |

3. Enter the custom message using the dial pad keys to enter the letters as shown in [Figure 2-19 on page 2-231](#).
  - Up to 24 alphanumeric characters may be entered for the custom message (this represents 48 digits entered). The actual characters display as the digits are being entered while programming the messages.
  - The Attendant must go idle after programming a message before another message may be programmed.
4. The Attendant then presses the HOLD button to enter the message and a confirmation tone sounds.

### Conditions

- » Key telephones and SLTs can leave a message. SLTs are notified that they left a message with a warning tone when going off-hook.
- » Incoming and outgoing calls are not inhibited with a message displayed.
- » When a message is displayed by a key telephone, the DND button LED flashes at the 15 ipm rate.
- » When DND is invoked on the telephone, the message is canceled.
- » Message Access (with desired message) may be assigned to a flexible button.
- » The Message Access function is assigned to a station flexible button in database administration.
- » A station user may store any of the available messages under a flexible button assigned as a Message Access button.
- » The ten Custom Messages display in a similar fashion as Canned messages. The idle station display shows the message that was activated at the station and a calling station receives the STA XXX or name-in-display followed by the programmed custom messages.
- » This feature is not available for use at Attendant stations.

---

## Attendant Day/Night/Special

### Description

The system's Automatic Night Mode Feature can be overridden by the Attendant station. The Attendant station user can press their DND button or use a Soft Key option to place the system into Night Mode.

Any designated Attendant can place the system into Night Service.



*The Night Service feature provides a means to put the system in night mode from any keyset or remove the system from night mode from any keyset, providing the system was put in night mode by the night service feature flexible button [604]. If the system was placed in night mode by the Attendant using the DND button or if the system was placed in night mode by the automatic schedule, the night service flexible button cannot remove the system from night mode.*

### Operation

1. Press the preprogrammed NIGHT SERVICE button (631, DND by default) once or use the Soft Key's DND option when in an idle condition to activate the Night mode (LED is lit solid).
2. Press the DND button again to activate the Special mode (LED flashes @ 240 ipm).
  - The DND button (by default) or Soft Key's DND option acts as a rotary in this manner, starting in the Day mode, Night mode, and Special mode.
  - When one Attendant activates this mode, other Attendant stations' DND buttons are lit accordingly.

## Attendant Directory List Programming

### Description

Directory Dialing enables display telephone station users to obtain a directory of station users and have the system dial the extension currently displayed. The STSe system provides locations for up to 200 names (000-199). Directory dialing also lets the Attendant program a name with a speed dial bin for use in later locating a speed dial number. When prompted, the system displays the name associated with a speed dial number so when the desired name is shown, the user may then have the system dial the number.

### Programming Steps

To access Directory List programming, dial the Directory List program code [693]. The HOLD button illuminates.

The first entry (000) in the Directory List is shown on the display.

```
DIR LST AAA BIN/ICM: XXXX
nnnnnnnnnnnnnnnnnnnnnnnnnn
```

AAA = Directory List entry number (000-199)

XXXX = Either,

A 3- or 4-digit station number (100-8999)

-or-

A 3-digit local number/name translation table number  
(600-799 minus assigned station numbers that would overlap)

-or-

A 4-digit system speed bin number (9020-9099)

nnn = Programmed Name (blank if none)

The following procedure is used to enter, edit, and erase names in the Directory List for stations or speed dial numbers.

1. Enter desired 3-digit Directory List number (000-199), or dial [\*] to scroll up (next entry) or [#] to scroll down (previous entry) through the list.  
If just changing a name associated with an existing station, skip to step 4.
2. Press TRANS.
3. Enter the 3- or 4-digit station intercom number.
4. Press MUTE.

## Attendant Features and Operation

- Enter the name (up to 24 characters may be entered) by using the keys. The display updates as the name is entered.

|                              |                      |                              | Other Codes |            |         |        |
|------------------------------|----------------------|------------------------------|-------------|------------|---------|--------|
| 1                            | A-21<br>B-22<br>C-23 | D-31<br>E-32<br>F-33         | 1 = 1#      | 8 = 8#     | " = 01  | * = *# |
| G-41<br>H-42<br>I-43         | J-51<br>K-52<br>L-53 | M-61<br>N-62<br>O-63         | 2 = 2#      | 9 = 9#     | , = 02  | ( = #1 |
| P-71<br>R-72<br>S-73<br>Q-74 | T-81<br>U-82<br>V-83 | W-91<br>X-92<br>Y-93<br>Z-94 | 3 = 3#      | 0 = 0#     | ? = 03  | ) = #2 |
| *                            | OPER<br>0            | #                            | 4 = 4#      | Space = 11 | / = 04  | + = #3 |
|                              |                      |                              | 5 = 5#      | : = 12     | ! = *1  | == #4  |
|                              |                      |                              | 6 = 6#      | - = 13     | \$ = *2 | # = ## |
|                              |                      |                              | 7 = 7#      | ' = 14     | & = *4  | . = 24 |

**Figure 3-1: Directory List Keypad Map**

- Press SPEED when finished. Confirmation tone sounds and the display shows the new or changed name.
- Press HOLD, then use [\*] or [#] to scroll to next entry.  
-or-  
Hang up to end programming.

**To clear an entry:**

- Select desired entry and press TRANS.
- Press FLASH.
- Press SPEED. Confirmation tone sounds and entry is erased.

The following procedure is used to associate names to the Local Number/Name Translation Table number only.

- Enter desired three-digit Directory List number (000-199), or dial [\*] to scroll up (next entry) or [#] to scroll down (previous entry) through the list.  
If just changing a name associated with an existing Table entry, skip to step 4.
- Press TRANS.
- Dial three-digit Local Number/Name Translation Table number (600-799) that represents the desired telephone number.
- Press MUTE.
- Use keys on the dial pad to enter the name (up to 24 characters may be entered). The display updates as the name is entered (refer to [Figure 3-1 on page 3-10](#)).

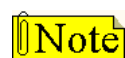

If an error is made during keystroke entry, press FLASH to clear the current name.

- Press SPEED when finished. Confirmation tone sounds and the display shows the new or changed name.
- Press HOLD, then use [\*] or [#] to scroll to next entry.  
-or-  
Hang up to end programming.

The following procedure is used to associate names to a system speed dial bin only.

1. Enter desired 3-digit Directory List number (000-199), or dial [\*] to scroll up (next entry) or [#] to scroll down (previous entry) through the list.

If changing a name associated with an existing System Speed Dial Bin entry, go to step 4.

2. Press TRANS.
3. Dial system speed dial bin location (9020-9099).
4. Press MUTE.
5. Use keys on the dial pad to enter the name (up to 24 characters may be entered). The display will update as the name is entered (refer to [Figure 3-1 on page 3-10](#)).
6. Press SPEED when finished. Confirmation tone sounds and the display updates.
7. Press HOLD, then use [\*] or [#] to scroll to next entry.

-or-

Hang up to end programming.

## Operation

### To view the directory list:

1. Dial the Directory List dial code [680] on the dial pad,

-or-

Press the flexible button programmed as a directory dialing button.

2. Press a button on the key pad, once, twice or three times, that represents the letter of the alphabet to begin viewing the list of names (e.g., when 2 is first pressed, it produces names starting with A. When 2 is pressed a second time, names that start with B display. Pressing 2 a third time displays names that start with C). The alphabet is represented on the key pad as shown below.

|                          |                   |                          |
|--------------------------|-------------------|--------------------------|
| 1                        | A-2<br>B-2<br>C-2 | D-3<br>E-3<br>F-3        |
| G-4<br>H-4<br>I-4        | J-5<br>K-5<br>L-5 | M-6<br>N-6<br>O-6        |
| P-7<br>R-7<br>S-7<br>Q-7 | T-8<br>U-8<br>V-8 | W-9<br>X-9<br>Y-9<br>Z-9 |
| *                        | OPER<br>0         | #                        |

Names beginning with the letter chosen display on the LCD display.

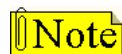

If there are no names in the Directory List beginning with the desired letter, a name with the next higher letter displays on the LCD display.

*Attendant Features and Operation*

3. Dial [\*] to scroll up (next entry) through the list,  
-or-  
Dial [#] to scroll down (previous entry) through the list,  
-or-  
Press another key to view the list for a different letter of the alphabet.
4. When the desired name displays on the LCD, press the SPEED button to automatically dial the destination station or outside phone number (via speed dial).

**To transfer a call using directory dialing while on a call:**

1. Press the TRANS button.
2. Dial the Directory Dial Code [680] on the dial pad,  
-or-  
Press the flexible button programmed for directory dialing.
3. Press the digit associated with the person's name and when it displays, press SPEED to automatically dial the destination station.
4. Hang up to complete the transfer.



*Calls may be transferred to internal stations only. An attempt to transfer a call off-net (via a speed dial bin) results in the call recalling upon going on-hook.*

**Conditions**

- » If the desired party is an intercom station, that station is signaled according to their intercom selector/H-T-P switch (SLT stations tone ring).
- » If the desired party is associated to a speed dial bin, the system selects a CO line and dials the number programmed into the speed dial bin. Call progress tones are then heard.
- » If station is in Directory Dialing mode and a CO or intercom call rings in, the station must exit Directory Dialing mode to answer the call.

---

## Attendant Disable Outgoing CO Line

**Description**

The first Attendant can disable CO lines to prevent outgoing access to those lines. This is useful for removing a faulty line from service or for reserving CO lines for important use. All stations that normally make calls on the lines are affected, but incoming calls are unaffected. A CO line may be disabled while it is being used. When the trunk becomes idle, further outgoing access is prevented.

**Operation****To disable CO Lines:**

1. Lift handset or press ON/OFF button.
2. Dial [602] on the dial pad. A confirmation tone sounds.
3. Press the line button(s) of the CO Line(s) to disable. A confirmation tone sounds and the CO Line button(s) LED flashes.

**To reactivate the CO Line(s): Repeat Steps 1-3 to disable this feature.**



---

## Attendant Override

### Description

Attendant stations may override a busy station or ring a station in DND. While busy, pressing the override key provides override tone and a five second delay before voice cut-through to the called party occurs, automatically placing any outside line call on Hold. The Attendant Override function must be programmed onto a flexible button and can be enabled or disabled.

### Programming Steps

1. Press the ATTN OVERRIDE flexible button (**FLASH 05, Button #1**).
2. Enter a valid number (0 or 1) that corresponds with the following entries:
  - [0] = Disabled
  - [1] = Enabled

|                    |     |
|--------------------|-----|
| ATTENDANT OVERRIDE | 1-0 |
| DISABLED           |     |

3. Press HOLD to save the entry. A confirmation tone sounds.



*Attendant Override functions ONLY when the Attendant station is assigned a flexible button designated as Attendant Override.*

DEFAULT ... Attendant Override is disabled.

### Operation

#### **To call a station busy on a CO call:**

Press the preprogrammed ATTN OVERRIDE button [601]. A long tone is presented to the called party.

After five seconds, the station's CO line is automatically placed on hold and the Attendant is cut-through.

#### **To call a station in Do Not Disturb mode:**

Press the preprogrammed ATTN OVERRIDE button. The station is signaled with a Camp On tone.

## Attendant Setting Time and Date

### Description

The System Time/Date must be set in admin programming or by the first programmed Attendant using feature code 692.

### Programming Steps

To set the time and date that appears on display telephones:

1. Press **FLASH** and dial **[11]**. The following message displays:

|                               |
|-------------------------------|
| DATE AND TIME                 |
| MMM DD YY            HH:MM am |

*MMM = Month*

*DD = Day*

*YY = Year*

*HH = Hour*

*MM = Minute*

2. Choose display format by pressing flexible button #1 to toggle between the standard 12-hour format or the 24-hour format (LED off = 12-hr display, LED on = 24-hr display).
3. Dial the time and date in the order shown below (2 digits for each entry, for a total of 10 digits):

Year

Month

Day

Hour

Minute



*To program a pm time after selecting the 12-hour format, use 24-hour numbering, e.g., To program a time of 5:00 pm, enter 17:00.*

4. Press HOLD to save the entry. A confirmation tone sounds and the display updates.

DEFAULT ... Time is set for 12-hour display format.

### Operation

1. Dial [692] on the dial pad. A confirmation tone sounds.
2. Enter date and time as follows: YYMMDDHHMM

YY = Year (00-99)

HH = Hour (00-23)

MM = Month (01-12)

MM = Minute (00-59)

DD = Day (01-31)

When the correct number of digits are entered, a confirmation tone sounds.

3. Press the ON/OFF button to OFF to update the display.

---

## Attendant Station Assignment

### Description

Any six Digital Telephones in the system can be assigned as Attendant stations. These stations receive recalls and can place the system into Night Service. The Attendant stations must be either Enhanced or Executive stations.

If the Tenant Groups feature is used, refer to [“Attendant Station Assignment for Tenant Groups” on page 2-313](#).

### Programming Steps

1. Press **FLASH** and dial **[10]**. The following message displays:

ATND STATIONS 100, ####  
####, ####, ####, ####

2. Enter a valid station number (100-8999) on the dial pad, followed by a “1” to add or “0” to delete the Attendant assignment.
3. Press HOLD to save the entry. A confirmation tone sounds and the display updates.

DEFAULT ... Station 100 is assigned as the first Attendant.

---

## Attendant Unavailable

### Description

The Attendant Unavailable feature lets Attendant stations have a button that places their station in an Unavailable Mode. When the station is in the Unavailable Mode, the next Attendant station receives dial "0" calls and recalls. This feature is based on having the six programmed Attendant stations.

### Operation

1. When the (first programmed) Attendant presses the preprogrammed UNAVAILABLE flexible button,  
-or-  
Dials the Attendant Unavailable code [607] on the dial pad, the following results occur:
  - The LED on the flexible button lights solid, if programmed.
  - Recalls and dial "0" calls now ring at the second Attendant.
  - If the second Attendant places their phone in unavailable, the third Attendant will receive recalls and dial "0" calls, and so forth through the sixth Attendant.
2. When the first Attendant *repeats the process* (using Unavailable button or code [607]), the following results occur:
  - The LED on the flexible button, if programmed, extinguishes.
  - The first Attendant resumes normal operation.
  - The second through sixth Attendants will not receive recalls or dial "0" calls.

### Conditions

- » This feature lets the programmed Attendant stations receive Attendant recalls only. No other Attendant type functions are given to this station when the station is in the Attendant mode.
- » If Attendant A (first programmed) is available, incoming calls and recalls are directed to this station regardless of other Attendant stations status.
- » The special ring mode can be set so the alternate Attendant does not receive an incoming CO ring until the main Attendant places their phone in special and unavailable modes.
- » If all Attendants in the system are unavailable, no Attendants are available for internal/external callers.
- » Recalls are directed to all programmed available Attendants.
- » If only one Attendant is programmed in the system, and that Attendant is unavailable, users dialing zero hear an error tone.

---

## Attendant Voice Mail Alarm Clear

### **Description**

The Attendant display shows an alarm condition when the system detects that the digital voice mail is out of service.

### **Operation**

The Attendant can dial feature code [656] to clear any alarm from the display. It will not clear the condition, just clear the display.

---

## DSS/BLF Console with Map

### **Description**

An optional Direct Station Selector (DSS) console is available which may be associated with an Attendant station to provide additional buttons for DSS/Busy Lamp Field (BLF) features.

### *Busy Lamp Field Indicators*

Each station key on the DSS console has a corresponding indicator that shows whether the station is idle or busy. The indicator is lit when the station is busy and unlit if the station is idle. A station in DND mode is shown by a flashing indicator.

### *Direct Station Calling*

Enables the Attendant to make an intercom voice call to any digital telephone in the system. You can automatically put an outside caller on hold and simultaneously make an intercom call to an internal station; also you can transfer an intercom or outside call that is on hold to another station.

### *Release Key*

Allows the Attendant to disconnect calls while off-hook, speeding up call handling time.

### *Transfer Search*

Allows the Attendant to make a series of intercom calls without hanging up the handset. An intercom connection is switched to another station whenever a DSS key is pressed. Pressing the next DSS key terminates the previous intercom call.

## Mapping Options

The DSS/BLF Console unit can access Stations, Direct Appearing CO Lines, or features that may be assigned to any of the flexible buttons (refer to [“Flexible Button Function Assignment” on page 2-163](#)). Buttons assigned as CO lines cannot be changed, buttons assigned as Stations can be changed by the user. Refer to [Figure 3-2](#) and [Figure 3-3](#).

**DSS Console Map #1** -- by default 12 CO Lines, 36 Stations (100-135). This provides a default layout of a 12 X 36 configuration.

|     |      |      |      |
|-----|------|------|------|
| CO1 | CO2  | CO3  | CO4  |
| CO5 | CO6  | CO7  | CO8  |
| CO9 | CO10 | CO11 | CO12 |
| 100 | 101  | 102  | 103  |
| 104 | 105  | 106  | 107  |
| 108 | 109  | 110  | 111  |
| 112 | 113  | 114  | 115  |
| 116 | 117  | 118  | 119  |
| 120 | 121  | 122  | 123  |
| 124 | 125  | 126  | 127  |
| 128 | 129  | 130  | 131  |
| 132 | 133  | 134  | 135  |

**Figure 3-2: DSS Console Map #1**

**DSS Console Map #2** -- by default has 48 Stations, 100–147. All buttons are flexible and can be changed by the station user. This map can be duplicated on another DSS/BLF console and assigned to the same station.

|     |     |     |     |
|-----|-----|-----|-----|
| 100 | 101 | 102 | 103 |
| 104 | 105 | 106 | 107 |
| 108 | 109 | 110 | 111 |
| 112 | 113 | 114 | 115 |
| 116 | 117 | 118 | 119 |
| 120 | 121 | 122 | 123 |
| 124 | 125 | 126 | 127 |
| 128 | 129 | 130 | 131 |
| 132 | 133 | 134 | 135 |
| 136 | 137 | 138 | 139 |
| 140 | 141 | 142 | 143 |
| 144 | 145 | 146 | 147 |

**Figure 3-3: DSS Console Map #2**

**DSS Console Map #3** -- by default, CO Lines 1-28 appear in sequential order.

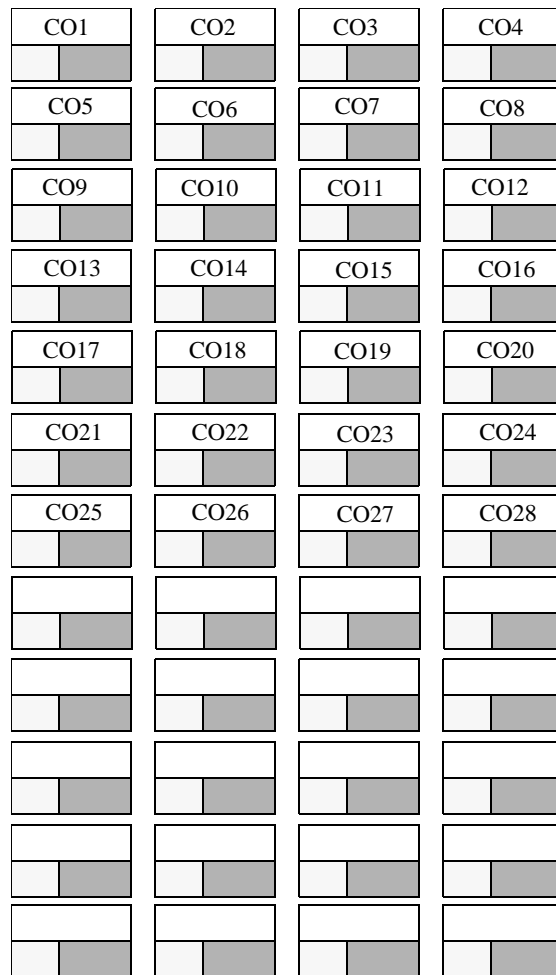

**Figure 3-4: DSS Console Map #3**



## Station ID for DSS/BLF Console With Map

### Description

Each system port must be programmed to identify the type of station that operate on that port. Each station type must be identified.

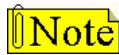

When identifying a station as a DSS/BLF console, you must also enter the station number of the key telephone to which the DSS/BLF console is associated. To associate a DSS console with Station 100, the entry would be 1100 [HOLD].

### Programming Steps

1. Press the STATION ID flexible button (**FLASH 50, Page B, Button #1**).

|                     |     |
|---------------------|-----|
| STATION ID          | 0-8 |
| KEYSET - STSE 24BTN |     |

2. Dial **[1-3]** on the dial pad to identify the desired DSS map number (refer to ["Mapping Options" on page 3-18](#)).
3. Enter a valid station number to which the DSS/BLF Console is associated.
4. Press HOLD to save the entry. A confirmation tone sounds and the display updates.

|                     |     |
|---------------------|-----|
| STATION ID          | 0-8 |
| DSS MAP X ASSOC XXX |     |

X = 1-2  
XXX = Station Number

---

## Display Timer

### Description

The Attendant Display Timer changes the way in which multiple calls ringing at the Attendant station are displayed. If two calls are ringing at an Attendant station, when the station goes off hook, the first call is answered. The LCD display then updates to show the second call that is ringing, which sometimes does not allow the station to view the current call's LCD information. The display timer keeps the current call's information on the LCD for a programmable time period before showing any other calls ringing in at the time.

The Attendant Display Timer setting is variable from 00-99 seconds.

### Programming Steps

1. Press the ATTENDANT DISPLAY TIMER flexible button (**FLASH 02, Button #2**). The following message displays:

|                   |       |
|-------------------|-------|
| ATTENDANT DISPLAY | 00-99 |
| 01                |       |

2. Enter a valid number on the dial pad that corresponds to 00-99 seconds.
3. Press HOLD to save the entry. A confirmation tone sounds and the display updates.

DEFAULT ... Attendant Display Timer is set for 1 second.

---

## ICLID Call Management Tables

### Description

Two ICLID Call Management Tables are maintained in the system. These tables consist of an Answered Call Management Table and an Unanswered Call Management Table. Each have a 100-entry capacity.

### *Answered Call Management Table*

#### Description

The Answered ICLID Table feature adds a table that captures the ICLID calls that were answered. The table can store up to 100 entries of the most recently answered ICLID calls. A station may dial a unique access code to view the entries, scroll through the entries, and dial a desired entry back. The table displays the number as well as the station that answered the call.

#### Operation

This table may be accessed from any user station display phone so the answered calls may be reviewed and handled by the end user. Any Attendant station(s) can delete a table entry, one entry at a time. Upon entering the review process, the functions available to a phone are:

**Table 3-2: ICLID Answered Call Management**

| Function                            | Button        |
|-------------------------------------|---------------|
| Go to beginning of table            | Dial Code 659 |
| Toggle between Name/Number          | MUTE          |
| Step to next table entry            | HOLD          |
| Delete table entry (Attendant only) | FLASH         |
| Exit table review function          | ON/OFF        |
| Step to previous table entry        | TRANSFER      |
| Call Back                           | SPEED         |

#### Conditions

- » Telco must activate Caller ID service.
- » Auto Attendant calls are considered answered.

## *Unanswered Call Management Table*

### **Description**

An Unanswered Call Management Table with 100-entry capacity is maintained in the system. The calling number/name information pertaining to any unanswered call is placed in this table at the time the system determines the call was abandoned.

This table may be accessed from any display telephone to review unanswered calls. Only an Attendant station(s) can delete an entry from this table.

### **Operation**

This table may be accessed from any station display phone so that the unanswered calls may be reviewed and handled by the end user. Upon entering the review process, the functions available to a phone are:

**Table 3-3: ICLID Unanswered Call Management**

| <b>Function</b>                     | <b>Button</b> |
|-------------------------------------|---------------|
| Go to beginning of table            | Dial Code 635 |
| Toggle between Name/Number          | MUTE          |
| Step to next table entry            | HOLD          |
| Delete table entry (Attendant only) | FLASH         |
| Exit table review function          | ON/OFF        |
| Step to previous table entry        | TRANSFER      |
| Call Back                           | SPEED         |

### **Conditions**

- » Telco must activate Caller ID service.
- » Auto Attendant calls are considered answered.

---

## Recall

### Description

A held CO call left unattended by a station recalls the Attendant(s) after a programmable time period elapses. A recalling CO line flashes at a distinctive rate and has an LCD display that identifies the originating station of the unanswered call.

### Operation

To answer a recall, press OUTSIDE LINE button that is flashing at a very fast rate.

### Conditions

- » Recall does not apply to intercom calls placed on hold.

## *Attendant Recall Timer*

### Description

The Attendant Recall Timer determines the time a recalling call rings at the Attendant station(s) before the system releases the line. When a CO Line recalls to the Attendant station and is still unanswered, the system releases the line at the expiration of this timer and automatically places the line to an idle condition.

The Attendant Recall Timer setting is variable from 00–60 minutes. An entry of 00 causes the Attendant(s) station to ring until answered.

### Programming Steps

1. Press the ATTENDANT RECALL TIMER flexible button (**FLASH 01, Button #3**). The following message displays:

|                   |       |
|-------------------|-------|
| ATND RECALL TIMER | 00-60 |
| 01                |       |

2. Enter a valid number on the dial pad that corresponds to 00-60 minutes.
3. Press HOLD to save the entry. A confirmation tone sounds and the display updates.

DEFAULT ... Attendant Recall Timer is set for 1 minute.

---

## Release Button

### Description

The Release Button feature lets the station user disconnect calls while off-hook (on handset, not speakerphone), speeding up call handling time. While off-hook (on handset, not speakerphone) on an intercom call, transfer sequence, page announcement, or CO call:

Press the preprogrammed RELEASE button [641] to terminate intercom call, transfer sequence, page announcement or CO call.

---

## Speed Dial - System Storing

System Speed numbers must be entered by the first programmed Attendant. If no Attendant is specified, enter at Station 100.

1. Press SPEED once, then press desired outside line key; or select an outside line automatically by pressing the SPEED button twice.
2. Dial the System Speed bin location (9020-9099).
3. Dial telephone number.
4. Press the SPEED button.
5. Hang up.
  - Pressing the TRANS button during number entry initiates a Pulse-To-Tone switchover.
  - Pressing the HOLD button during number entry inserts a Pause.
  - Pressing the FLASH key inserts a Flash into the speed number.
  - Pressing the TRANS button as the first entry in the speed bin inserts a no-display character causing the numbers stored in the bin not to display on the Digital Telephones when the bin is accessed.

Speed Bin numbers 9060-9099 are NOT monitored by Toll Restriction.



---

---

# 4

# Uniform Call Distribution

This chapter covers the topic of Uniform Call Distribution (UCD).

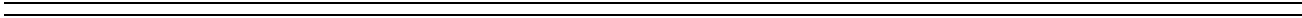



---

## Uniform Call Distribution

### Description

Sixteen Uniform Call Distribution (UCD) groups can be programmed, each containing up to eight station numbers. Each group is assigned a pilot number. When this number is dialed, the first available agent in that group is rung. Calls are routed to the station that has been on-hook for the longest period of time.

### *UCD Calls In Queue Status Display*

#### Description

The UCD Calls In Queue Status Display allows UCD agents to view information about the UCD group on their display. The display shows how many calls are in queue, how many agents are available, and the length of time the oldest call has been in queue.



*This feature cannot be used with a call in progress. The station is considered busy for incoming calls during this operation. Each time this feature is used, wrap-up is started.*

*If a UCD member is taken out of the group (e.g., DND, All Call Forward, Unavailable, etc.) they do not receive calls in queue information.*

#### Operation

There are two methods of viewing UCD group Call Queue Status.

- UCD agents and the assigned overflow station see the quantity of calls in queue on the LCD of their station for the UCD group of which they are a member. If every member of the UCD group is either busy or in an unavailable status and calls are in queue, all UCD members in that group receive a display that shows the number of calls in queue, the number of agents available, and the length of time that the oldest call has been in queue.
- A station not assigned in a UCD group can view the number of calls in queue for any given UCD Group. To use the UCD Calls In Queue Status Display, a station user of an idle display key telephone performs the following steps:
  1. Dial [567] on the dial pad,  
-or-  
Press preprogrammed flexible button.
  2. Dial the UCD group number (550-565). ON/OFF button LED lights steady.
  3. Hang up the handset or press ON/OFF button to terminate display.

## *Alternate UCD Group Assignments*

### **Description**

An Alternate UCD Group can be programmed so that if no station in a group is available, the alternate group is checked for an available station. This provides a way to chain or link UCD Groups together.

### **Programming Steps**

#### **To establish an Alternate UCD Group:**

1. Press **FLASH** and dial **[60]**.
2. Enter the UCD Group number (550-565) on the dial pad.
3. Press HOLD. A confirmation tone sounds and the display updates.
4. Press the ALTERNATE GROUP flexible button (**FLASH 60, Button #2**).

AXXXX ALTERNATE GROUP  
####

5. Enter another UCD Group number to designate the Alternate UCD Group.
6. Press HOLD to save the entry. A confirmation tone sounds and the display updates.

#### **To delete an Alternate UCD Group:**

1. Press [#].
2. Then press the HOLD button.

## *Incoming CO Direct Ringing*

### **Description**

CO Lines can be programmed to ring directly into a UCD group. When all agents are busy and RAN is enabled, the system answers the caller and presents the Primary Recorded Announcement automatically.

## Message Interval Timer

### Description

The UCD Message Interval Timer (MIT) determines the length of time a caller remains in queue (listening to MOH, if provided) between recorded announcements. The UCD Message Interval Timer setting is variable from 000 to 600 seconds.

### Programming Steps

1. Press the MIT TIMER flexible button (**FLASH 61, Button #2**). The following message displays:

|                  |         |
|------------------|---------|
| MESSAGE INTERVAL | 000-600 |
| 060              |         |

2. Enter a valid number on the dial pad which corresponds to 000-600 seconds.
3. Press HOLD to save the entry. A confirmation tone sounds and the display updates.



*The UCD Ring and Message Interval Timers only apply when RAN ports are specified. If RAN ports are not specified, incoming callers continue to receive a ringback tone.*

DEFAULT ... UCD Message Interval Timer is set for 60 seconds.

## No-Answer Recall Timer

### Description

If a call routed to a station via UCD is not answered by the UCD Agent/Station before the No-Answer Recall Timer expires, the call is returned to UCD Queue with the highest priority. In addition, the station that failed to answer the ringing UCD call is placed into an out-of-service (OOS) state. The UCD No-Answer Timer setting is variable from 000–300 seconds.

### Programming Steps

1. Press the NO-ANSWER RECALL TIMER flexible button (**FLASH 61, Button #5**). The following message displays:

|                 |         |
|-----------------|---------|
| NO - ANS RECALL | 000-300 |
| 000             |         |

2. Enter a valid number on the dial pad which corresponds to 000-300 seconds.
3. Press HOLD to save the entry. A confirmation tone sounds and the display updates.

DEFAULT ... UCD No-Answer Timer is at 000 (disabled).

## *No-Answer Retry Timer*

### **Description**

When the No-Answer Recall timer expires, a station that failed to answer the ringing UCD call is placed into an out-of-service (OOS) state. The station that was taken out-of-service (OOS) is placed back in service if the agent hits their available flexible button or dials the available flexible code. The agent is also placed back in service if the No-Answer Retry timer expires. If the agent does not answer their next UCD call, they are again taken out-of-service. This cycle continues until the station answers calls, logs out, or goes unavailable. The No-Answer Retry Timer setting is variable from 000–999 seconds.

### **Programming Steps**

1. Press the NO-ANSWER RETRY TIMER flexible button (**FLASH 61, Button #6**). The following message displays:

|                   |         |
|-------------------|---------|
| NO - ANSWER RETRY | 000-999 |
| 300               |         |

2. Enter a valid number on the dial pad which corresponds to 000-999 seconds.
3. Press HOLD to save the entry. A confirmation tone sounds and the display updates.

DEFAULT ... No-Answer Retry Timer is set for 300 seconds.

## *Overflow Station Assignment*

### **Description**

When an Overflow Station is assigned, callers that remain in queue for a specified amount of time are routed to the assigned Overflow Station. The Overflow Station MAY NOT be one of the UCD Group stations. Only CO calls transferred to a UCD Group, overflow to the Overflow Station when RAN Tables are assigned.

### **Programming Steps**

#### **To assign an UCD Overflow Station:**

1. Press **FLASH** and dial **[60]**.
2. Enter the fixed or flexible group number (550-565) on the dial pad.
3. Press HOLD.
4. Press the OVERFLOW STATION flexible button (**FLASH 60, Button #3**).
5. Enter a valid flexible station number to designate the UCD Group's Overflow Station.

|                        |
|------------------------|
| AXXXX OVERFLOW STATION |
| ####                   |

6. Press HOLD to save the entry. A confirmation tone sounds and the display updates.

#### **To delete an UCD Overflow Station:**

1. Press [#] three times.
2. Then press the HOLD button.

## Conditions

- » The caller must hear a recorded announcement before the call will overflow.

## Overflow Station Forwarding

### Description

An overflow station may be assigned to route callers in queue to a designated station after a specified time. The overflow station may not be one of the UCD group stations.

This feature allows UCD calls reaching the UCD Overflow Station to call forward to another station. This is allowed or denied on a system-wide basis. Once enabled in programming, a UCD Overflow station can Busy/No-Answer forward to Voice Mail Groups, Hunt Groups and stations. If the UCD Overflow station is busy or does not answer before the no-answer call timer expires, the UCD call forwards to the programmed destination (e.g., Voice Mail).

### Programming Steps

1. Press the OVERFLOW STA FWD flexible button (**FLASH 06, Button #6**). The following message displays:

|                  |     |
|------------------|-----|
| OVERFLOW STA FWD | 0-1 |
| DISABLED         |     |

2. Enter a 0 or 1 on the dial pad to enable/disable the use of this feature.
  - [0] = Disabled
  - [1] = Enabled
3. Press HOLD to save the entry. A confirmation tone sounds.

DEFAULT ... Overflow Station Forward is disabled.

### Operation

#### To activate Call Forwarding:

1. Lift the handset or press ON/OFF button.
2. Press the FWD button or dial [640] (or a flexible number substituted for feature code 640).
3. Dial the desired code:
  - [6] = All Calls
  - [7] = No Answer Calls
  - [8] = Busy Calls
  - [9] = Busy and No Answer Calls
4. Dial the destination number where to forward calls (Station, Voice Mail, UCD groups, or Hunt group). Confirmation tone sounds.
5. Replace handset or press ON/OFF button.

#### To remove Call Forwarding:

1. Lift handset or press ON/OFF button.
2. Press the FWD button. A confirmation tone sounds and the FWD LED extinguishes.

## Conditions

- » An overflow station may be assigned to route callers in queue to a designated station after a specified time. A queued call is one that has been answered by a recorded announcement device or transferred into the group.

## Overflow Timer

### Description

The UCD Overflow Timer determines the length of time a caller remains in queue for a UCD group. When the timer expires, the caller is routed to the designated overflow station.

The timer starts when an incoming call is answered and presented to the first recorded announcement. Transferred CO callers overflow at the expiration of the Overflow Timer. The UCD Overflow Timer setting is variable from 000–600 seconds.

### Programming Steps

1. Press the OVERFLOW TIMER flexible button (**FLASH 61, Button #3**). The following message displays:

|          |         |
|----------|---------|
| OVERFLOW | 000-600 |
| 060      |         |

2. Enter a valid number on the dial pad which corresponds to 000–600 seconds.
3. Press HOLD to save the entry. A confirmation tone sounds and the display updates.

DEFAULT ... UCD Overflow Timer is set for 60 seconds.

## Primary Agent Assignments

### Description

The Primary Agent Assignment feature allows the stations serving as primary agents to be entered into the UCD group. Up to 8 UCD Agents can be entered into a Group.

### Programming Steps

1. Press **FLASH** and dial [**60**].
2. Enter the fixed or flexible group number (550-565) on the dial pad.
3. Press HOLD.
4. Press the PRIMARY AGENT flexible button (**FLASH 60, Button #7**). The following message displays:

|                      |
|----------------------|
| AXXXX PRIMARY AGENTS |
| END                  |

5. To **add** a station as a primary agent of the UCD group, use the dial pad as follows:
  - Enter XXXX 1 (XXXX = flexible station number).
  - Press the HOLD button.

6. To **delete** a primary agent from the UCD group, use the dial pad as follows:
  - Enter XXXX 0 (XXXX = flexible station number).
  - Press HOLD to save the entry. A confirmation tone sounds and the display updates.
7. To **view** primary agents in the UCD group, press button #7 (Each depression toggles through seven agents at a time).

## *Primary Recorded Announcement*

### **Description**

A Primary Recorded Announcement (RAN) may be assigned to the group. This message is the first one presented to the caller.

### **Programming Steps**

1. Press **FLASH** and dial **[60]**.
2. Enter the UCD Group number (550-565) on the dial pad.
3. Press HOLD.
4. Press the PRIMARY RAN flexible button (**FLASH 60, Button #10**).

|                                 |
|---------------------------------|
| AXXXX PRIMARY RAN    01-16<br># |
|---------------------------------|

5. Enter a valid number (01-16) for the desired RAN Announcement Table or a (#) to remove the entry.
6. Press HOLD to save the entry. A confirmation tone sounds and the display updates.

## *Recorded Announcements*

### **Description**

Recorded announcement (RAN) devices can be assigned to provide up to 16 different messages, if all stations in a UCD group are busy. The 16 messages are available to all eight UCD groups in different configurations. A RAN table can be the answer port for unanswered incoming calls to a UCD group, while another table can provide the secondary message. Each RAN device can provide an announcement to one caller at a time. Subsequent callers are queued onto the message on a first-in basis.

The Digital Voice Mail (DVM) can be used as a RAN device for UCD groups.

## *Recorded Announcement Tables*

### **Description**

Determines the type, index (port) number and message length for the 16 available Recorded Announcements (RAN). There are 16 RAN Tables that can be programmed. Table 1 can be the answer port for unanswered incoming calls to a UCD group.

The type can be either a CO line port, an SLT port, Voice Mail, or a RAN Hunt Group port. The index number specifies which circuit for the type of interface. The message length is used to match the maximum length of the message to the device that is used.

**Voice Mail** can be used as a RAN Announcer for UCD Groups. A menu is provided to play the announcement.

### **Programming Steps**

If Recorded Announcement (RAN) devices are installed to operate with UCD, these tables must be programmed.

1. Press **FLASH** and dial **[62]**. The following message displays:

|                      |     |      |      |     |
|----------------------|-----|------|------|-----|
| ANNOUNCEMENT TABLE 1 |     |      |      |     |
| TYPE #               | IDX | #### | TIME | ### |

The top left button in the flexible button field is lit for programming UCD RAN Announcement Table #1.

2. To change to another UCD RAN Announcement Table, press **FLASH 62** and a flexible button 2-16 for Tables 2-16 respectively.

#### **To program a Table for a CO Line port:**

1. Press the TABLE X flexible button (1-16).
2. Dial [1] for CO Port Interface.
3. Dial the desired CO line number, using a 4-digit format, e.g., for CO line 1, enter 0001.
4. Enter message duration (000-300 seconds).
5. Press HOLD to save the entry. A confirmation tone sounds and the display updates.

#### **To program a Table for an SLT port:**

1. Press the TABLE X flexible button (1-16).
2. Dial [2] for SLT Port Interface.
3. Dial the desired SLT station number, using a 4-digit format, e.g., for SLT station number 120, enter 0120.
4. Enter message duration (000-300 seconds).
5. Press HOLD to save the entry. A confirmation tone sounds and the display updates.

#### **To program a Table for a RAN Hunt Group port:**

1. Press the TABLE X flexible button (1-16).
2. Dial [3] for RAN Hunt Group.
3. Dial [0458-0461] for RAN Hunt Group used.
4. Enter message duration (000-300 seconds).
5. Press HOLD to save the entry. A confirmation tone sounds and the display updates.



**To program a Table for Digital Voice Mail:**

1. Press the TABLE X flexible button (1-16).
2. Dial [4] for the Voice Mail function.
3. Dial the desired Voice Mail Group number, using a 4-digit format, e.g., for Voice Mail Group 440, enter 0440.
4. Dial (0-9).
  - 0 = No DTMF Detection, No Messages Played (Default).
  - 1 = DTMF Detection, No Message.
  - 2 = No DTMF, Place In Queue Message.
  - 3 = DTMF Detection, Place In Queue Message.
  - 4 = No DTMF, Hold Time Message.
  - 5 = DTMF Detection, Hold Time Message.
  - 6 = No DTMF, Both Messages.
  - 7 = DTMF Detection, Both Messages.
  - 8 = Not used at this time.
  - 9 = Not used at this time.
5. Dial a three-digit menu number [000-999].
6. Press HOLD to save the entry. A confirmation tone sounds and the display updates.



To program a Table for Flash-based Voice Mail, refer to ["Recorded Announcement Tables" on page C-5](#).

**To clear entries:**

1. Press the [#] button.
2. Then press HOLD.

## Ring Timer

**Description**

The UCD Ring Timer determines how long a call rings into a busy UCD group before being presented to the first recorded announcement. The UCD Ring Timer setting is variable from 000–300 seconds.



A RAN Table must be specified in UCD programming. If a RAN Table is NOT specified, incoming CO callers are not answered but continue to receive ringback.

**Programming Steps**

1. Press the RING TIMER flexible button (**FLASH 61, Button #1**). The following displays:

|      |         |
|------|---------|
| RING | 000-300 |
| 060  |         |

2. Enter a valid number on the dial pad which corresponds to 000-300 seconds.
3. Press HOLD to save the entry. A confirmation tone sounds and the display updates.

DEFAULT ... UCD Ring Timer is set for 60 seconds.

## Secondary Recorded Announcement

### Description

A Secondary Recorded Announcement (RAN) may be assigned to the group. This announcement can be used for follow-up information after the Primary message. This announcement plays after the Message Interval Timer setting expires.

### Programming Steps

1. Press **FLASH** and dial **[60]**.
2. Enter the UCD Group number (550-565) on the dial pad.
3. Press HOLD.
4. Press the SECONDARY RAN flexible button (**FLASH 60, Button #11**).

|                                 |
|---------------------------------|
| A XXXX SECONDARY RAN 01-16<br># |
|---------------------------------|

5. Enter number (01-16) for the desired RAN Announcement Table or a (#) to remove the entry.
6. Press HOLD to save the entry. A confirmation tone sounds and the display updates.

## UCD Available/Unavailable

### Description

If you are a UCD agent, you may place your station in the Available mode to receive UCD calls, or you may place your station in the Unavailable mode to block UCD calls from ringing your station.

The UCD Available/Unavailable DSS/BLF flash rate is the rate at which a DSS appearance for a station in UCD Unavailable mode flashes. This flash rate can be programmed to 29 different options identified in the flash rate table. This enables the programmer to customize the key system configuration to desired flash rates.

### Programming Steps

1. Press the UCD UNAVL – DSS/BLF flexible button (**FLASH 07, Button #8**).

|  |
|--|
| UCD UNAVL DSS / BLF 00-28<br>RED 60 IPM DBL WINK OFF |
|--|

2. Enter a valid number (00-28) on the dial pad to correspond to one of the 29 available options (refer to [Table 2-16 on page 2-163](#)).
3. Press HOLD to save the entry. A confirmation tone sounds and the display updates.

DEFAULT ... UCD Available/Unavailable DSS/BLF flash rate is set for a Red 60 ipm Double Wink Off (04).

## Operation

### **To make a station available:**

Dial [566] on the dial pad,

-or-

Press the preprogrammed Available/Unavailable button. You may now receive UCD calls.

### **To make a station unavailable:**

Dial [566] on the dial pad,

-or-

Press the preprogrammed Available/Unavailable button. You are now blocked from receiving UCD calls.



#### SINGLE LINE TELEPHONE

The SLT operation uses the same procedures as used in Digital Telephone operation described above, except there is no flexible button to program. You must dial [566] to make a station available or unavailable.

## Conditions

- » If key is programmed, it will flash at 60 ipm double wink.
- » SLTs receive a stutter dial tone when unavailable.

## Wrap-up Timer

### Description

After completion of a UCD call (on-hook) the agent is not subjected to another UCD call for the duration of the Wrap-up Timer, allowing the agent to finish call related work or access other facilities. This lets agents remove themselves from the group (e.g., DND, Call Forward) or originate another call. This timer feature is programmable for each UCD Group in the system.

An agent that wants to override the Wrap-up Timer and immediately go back into an available UCD status can use a preprogrammed WRAP-UP END flexible button.

The Wrap-up End Button flash rate is the rate at which your flexible button flashes when you end a call until the UCD Wrap-up Timer setting expires or until you press the Wrap-up End Button. This flash rate can be programmed to 29 different options identified in the Flash Rate table. This enables the programmer to customize the key system configuration to desired flash rates.

The UCD Wrap-up Timer setting is variable from 000-999 seconds.

### Programming Steps

#### **To program the UCD Wrap-up Timer setting:**

1. Press **FLASH** and dial [**61**].
2. Enter the UCD Group number (550-565) on the dial pad.
3. Press HOLD. A confirmation tone sounds and the display updates.
4. Press the WRAP-UP TIMER flexible button (**FLASH 61, Button #4**). The following message displays:

|         |         |
|---------|---------|
| WRAP-UP | 000-999 |
| 004     |         |

5. Enter a valid number on the dial pad which corresponds to 0-999 seconds (0=disable).
6. Press HOLD to save the entry. A confirmation tone sounds and the display updates.

DEFAULT ... UCD Wrap-up Timer is set for four seconds.

#### **To program the Wrap-up End Button flash rate:**

1. Press the WRAP-UP END BTN flexible button (**FLASH 07, Button #20**).

|                     |       |
|---------------------|-------|
| WRAP END BTN        | 00-28 |
| RED 120 IPM FLUTTER |       |

2. Enter a valid number (00-28) on the dial pad to correspond to one of the 29 available options (refer to [Table 2-16 on page 2-163](#)).
3. Press HOLD to save the entry. A confirmation tone sounds and the display updates.

DEFAULT ... The Wrap-up End Button flash rate is set for a Red 120 ipm Flutter (11).

## Operation

### To override the Wrap-up Timer:

1. Preprogram a WRAP-UP END flexible button using feature code 584.
2. Press the preprogrammed WRAP-UP END flexible button.

## Initialize UCD Group Parameters

### Description

UCD Group Parameters may be initialized setting all data fields to their original, default values.

**Table 4-1: UCD Group Defaults**

| Program Code | Flexible Button    | Features                                | Default Value (after initialization) |
|--------------|--------------------|---|--------------------------------------|
| FLASH 60     | UCD GROUPS 550-565 |   |                                      |
|              | 2                  | Alternate UCD Group Assignment          | None                                 |
|              | 3                  | UCD Overflow Station Assignment         | None                                 |
|              | 7                  | UCD Primary Agent Assignment            | None                                 |
|              | 10-11              | Recorded UCD Announcement Assignment(s) | None                                 |
| FLASH 61     | UCD TIMERS         |   |                                      |
|              | 1                  | UCD Ring Timer                          | 60 sec                               |
|              | 2                  | UCD Message Interval Timer              | 60 sec                               |
|              | 3                  | UCD Overflow Timer                      | 60 sec                               |
|              | 4                  | UCD Auto Wrap-up Timer                  | 004 sec                              |
|              | 5                  | UCD No-Answer Recall Timer              | 000=Disabled                         |
|              | 6                  | UCD No-Answer Retry Timer               | 300 sec                              |
| FLASH 62     | 1-16               | UCD Announcement Tables (RAN)           | None                                 |

### Programming Steps

1. Press the UCD GROUPS flexible button (**FLASH 80, Button #11**).

INITIALIZE UCD GROUP  
PRESS HOLD

2. Press the HOLD button. A confirmation tone sounds.

## *Print UCD Group Parameters*

### **Description**

The Print UCD Group command dumps the entire database as a permanent record which can serve as a hardcopy of the database. The system baud rate must match that of the printer or receiving device.

### **Programming Steps**

1. Press the UCD GROUPS flexible button (**FLASH 85, Button #12**). The following message displays:

PRINT UCD GROUP  
PRESS HOLD

2. To print data for the UCD Group Parameters, press the HOLD button. The following message displays:

PRINTING UCD GROUP

When the system finishes sending the requested information to the printer, a confirmation tone sounds.

---

---

# A

# ICLID / Caller ID

This specification provides the functional and implementation definition for the addition of the ICLID feature to the STSe Digital Key Telephone System.

» » » » » » » »

# NOTES

» » » » » » » »

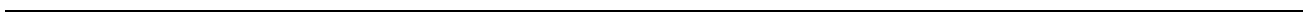



---

## Introduction

### Description

Incoming Calling Line Identification (ICLID), or Caller ID, is a service provided from the telephone company. Usually this service provides the number and name (not available in some cases) of the calling party for identification prior to answering the call. Calling party number and name are delivered in between this first and second ring using FSK (Frequency Shift Key) format.

For this feature to operate properly, it must be activated from the Central Office so the numbers or name, if available, of the calling party are delivered over the individual tip and ring of the CO lines during the first silent interval between ringing.

The following illustration depicts the configuration presumed for the implementation of the ICLID feature for the system. The phones are presumed to be in a UCD group in order to allow proper operation with the system.

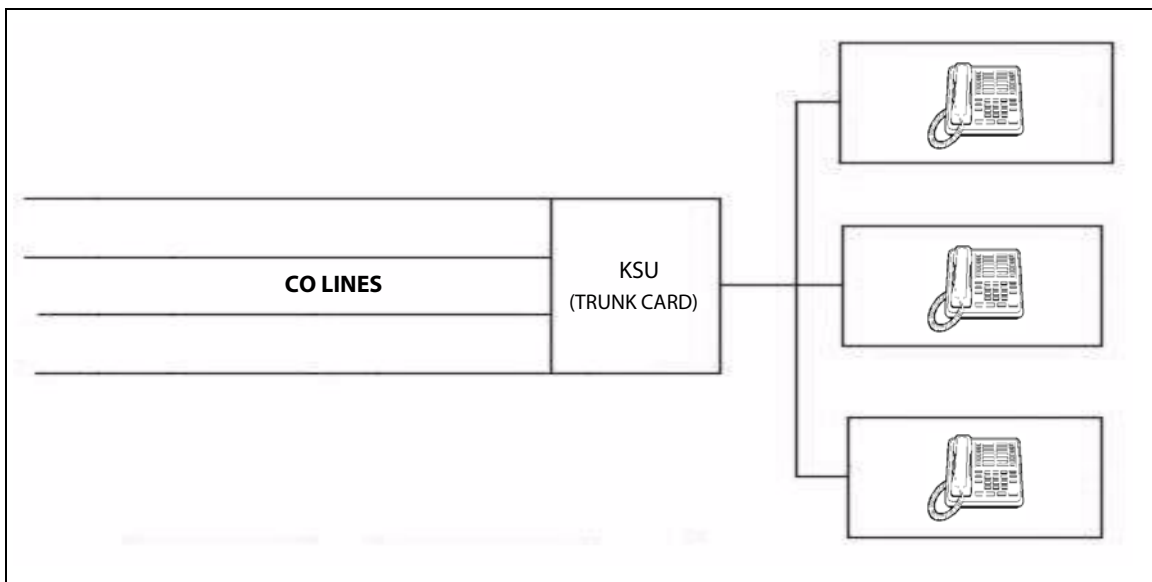

**Figure A-1: Caller ID System Configuration**

---

## Functional Performance

### Description

The key system operation of the ICLID feature is dependent on the feature first being activated from the central office so that the numbers of the calling party are delivered over the individual tip and ring of the CO lines during the first silent interval between ringing.

The features implemented are:

- Display of calling number/name on initial ring-in of a line on the display keysets.
- Recording of incoming call number/name on the SMDR printout.
- Management of an Unanswered Call table from a display phone with appropriate privilege level to allow tracking of unanswered calls for statistical information and return call management.
- Local translation of incoming numbers to names according to a table of number/name equivalences which can be administered by the system.

---

## Caller ID Name/Number

### Description

The Caller ID Name/Number feature lets a station user with a display keyset program a flexible button to view the number and name on the LCD when receiving a Caller ID CO call.

If the feature is enabled, use flexible button [653], the LED is lit solid and the name/number is displayed. During the call, the user can press the flexible button to view the normal call information. The LCD displays the number of the caller on the top line the name on the bottom line.

### Operation

To program a Caller ID Name/Number button:

1. Press [SPEED] + [SPEED].
2. Press the desired flexible button. A confirmation tone sounds.
3. Dial 653 (Caller ID Name/Number code).

DEFAULT ... No button is assigned on telephones.



SINGLE LINE TELEPHONE

The Caller ID Name/Number feature does not apply to SLTs.

### Conditions

- » When enabled, this display overrides transfer call LCD messages, Call Pickup messages, and Answer messages. If the user wishes to view the Line Number/Call Timer and the standard call information, they can press the flexible button to toggle between the name/number and normal mode.
- » A flexible button must be programmed for this feature to operate.

### Calling Number/Name Display

#### Description

The Calling Number/Name Display feature is intended as the basic offering of the ICLID service when associated with the STSe. Whenever an incoming call is received at the system, the number received along with the ringing signal is stored in the line control tables and used at various points in the processing of the call.

The primary function is that the calling number is displayed (if available) at any point at which the LINE RINGING is displayed in the system.

**Note** *If two lines are ringing in at the same time, the display shows the oldest line information. After one of the lines is answered, the display shows the information on the unanswered line.*

With the availability of the Calling Name feature, if the calling name is provided, the system delivers that to the display instead of the calling number.

The specification for this feature is that the system displays its LINE RINGING message as normally implemented and alter that display to the calling number/name if the information is made present on the line.

This allows the normal operation of the system when ICLID information is not presented or the device which intercepts it and provides the information to the KSU is missing or failed.

```
00000000011111111122222
123456789012345678901234
```

```
bbbbNAAAAAAAAAAAAAAAAAAAA
bbbb
```

-or-

```
XXXXXXXXXXXXXXXXXXXXXXXXXXXX
```

- If the Calling Name is available, the display is shown as above where X... represents the internal table storage of the calling name. Note that although the Central Office delivery of the calling name is 15 characters, the internal table used to store the name for translation of a received number is 24 characters in width.
- If the Central Office delivers a Name, it is positioned left justified in the 24-character field on the display. Note that if a number is received which matches a number/name translation, the translated name is used and the name delivered from the Central Office is effectively discarded.
- If No Name is available from the Central Office or a Translation Table, the delivered number is displayed as the repeated character N (14 characters).

## *Incoming Number/Name for SMDR Records*

### **Description**

When the Incoming Number/Name feature is implemented, the system operates normally in the absence of ICLID information or the failure of the ICLID equipment. If the information is present at the time that an SMDR record is generated for a call, it alters the content and format of the SMDR output record.

- If the calling number is available, the number is output in the SMDR record in the same location as the dialed number is located in the outgoing call record.
- If the calling name is present, an additional line is output in the SMDR identifying the name. This record immediately follows the normal SMDR record. The normal SMDR record includes an indicator that states the following record with name identification is present.

Unanswered calls are recorded in the SMDR record for incoming calls with a U indicator to provide caller identification for statistical and call-back purposes.

## *Local Name Translation*

### **Description**

An administrable table provides a local translation from a received calling number to a name. This table can be administered by the customer from the attendant console location. In cases of conflict between the name delivered from the CO and that in the local translation table, the local translation table shall rule. 200 entries are provided.

---

## **ICLID Programming**

### **Description**

The STSe system can provide ICLID input on the RS-232C connector of the BKSU. When ICLID is desired, the following system-wide parameters determine how the ICLID information is distributed.

### **Programming Steps**

1. Press **FLASH** and dial **[56]**. The following message displays:

|       |      |      |      |
|-------|------|------|------|
| ICLID | NAME | BAUD | PORT |
| NO    | YES  | 9600 | 1    |

2. To program ICLID features, use the flexible button(s) as defined in the following procedures.

Button # 1 = Disable/Enable

Button # 2 = Name In Display

Button # 3 = Baud Rate Display

Button # 4 = Port Assignment

3. After all entries are made, press HOLD to accept the data.

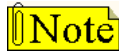

If caller ID is used in the system, you must use Flash 40, Page C, Button #2 to set the Ring Delay Timer to a setting of 05 (sec). This allows sufficient time for receipt of ICLID information from the telephone company (refer to "Ring Delay Timer" on page A-9).

## *Enable/Disable*

### **Description**

The ICLID (Incoming Calling Line Identification) feature was added to the STSe system. For this feature to operate properly, it must be activated from the Central Office so the numbers of the calling party are delivered over the individual tip and ring of the CO lines between the first and second ring cycle.

### **Programming Steps**

1. Press the DISABLE/ENABLE flexible button (**FLASH 56, Button #1**) to toggle between the options of NO for disable and YES for enable.
2. Press HOLD to save the entry. A confirmation tone sounds.

DEFAULT ... ICLID is disabled (NO option).

## *Name in Display*

### **Description**

The system can be set to display the incoming telephone number or the person's name on the LCD display.

### **Programming Steps**

1. Press the NAME flexible button (**FLASH 56, Button #2**) to toggle between the options of YES to show the name or NO to show the incoming telephone number in the LCD.
2. Press HOLD to save the entry. A confirmation tone sounds.

DEFAULT ... The system shows the name on the LCD display (YES option).

## Baud Rate Display

### Description

The STSe system can provide ICLID input on the standard RS-232C of the BKSU (also on LCOB w/CIDU). The baud rate is displayed as 150, 300, 600, 1200, 2400, 4800, 9600, or 19.2K baud.

### Programming Steps

The ICLID baud rate is programmed using **FLASH 15** Baud Rate assignments. The LCD displays the current baud rate based on which number is assigned to the ICLID Port number.

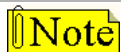

When FLASH 56, Button #3 is pressed, an error tone is received.

Baud rate does not apply to the CIDU.

DEFAULT ... Baud Rate is 9600.

## Port Assignment

### Programming Steps

1. Press the PORT flexible button (**FLASH 56, Button #4**) to specify which port to use for ICLID information.
2. Enter a valid number for one of the ICLID Ports:  
[1] = Port # 1 (RS-232C on BKSU)  
[2] = Port # 2 (RS-232C on BKSU)



Use Port 1 or 2 for ICLID. Port 3 is the modem port.

| ICLID | NAME | BAUD | PORT |
|-------|------|------|------|
| NO    | YES  | 9600 | 1    |

(LCD displays current baud rate assigned to the ICLID Port number.)

3. Press HOLD to accept the data. A confirmation tone sounds and the display updates.

DEFAULT ... Port #1.

## Ring Delay Timer

### Description

The Ring Delay timer was added to the STSe to accommodate ICLID interface requirements. The Ring Delay timer is started whenever a CO Line detects incoming ringing. When the timer expires, CO line ringing is detected by digital telephones and SLTs.

The purpose of this timer is to wait until after the first ring cycle to be detected by the digital system so the ICLID information is passed down the CO line prior to being answered. In some cases, it may be necessary to set the Ring Delay Timer to five seconds so all the ICLID information is received from the Central Office. The Ring Delay Timer setting is variable from 00-20 seconds.

### Programming Steps

1. Press **FLASH** and dial **[40]**. The following message displays:

```
CO LINE ATTRIBUTES
SELECT A CO LINE RANGE
```

2. Enter a valid number for the range of lines being programmed. If only one line is being programmed, enter that number twice (001 001).

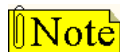

*If HOLD is pressed without entering a CO range, ALL CO lines are selected.*

3. Press Button #21 to select Page C. The display updates. The following message displays to indicate current programming of that line or group of lines:

```
XXX - XXX PAGE C
ENTER BUTTON NUMBER
```

*XXX-XXX = CO Line Range*

4. Press the RING DELAY TIMER flexible button (**FLASH 40, Page C, Button #2**). The following message displays:

```
RING DELAY TIMER      00-20
00
```

5. Enter a valid number on the dial pad (00–20) which corresponds to 00-20 seconds.
6. Press HOLD to save the entry. A confirmation tone sounds and the display updates.

DEFAULT ... Ring Delay Timer is set at 00 (disabled).

## Initialize ICLID-DID Tables

### Description

ICLID - DID Table parameters may be initialized, setting all data fields to their original default values.

**Table A-1: ICLID Table Defaults**

| Program Code | Flexible Button             | Features                               | Default Value (after initialization) |
|--------------|-----------------------------|--|--------------------------------------|
| FLASH 43     | ICLID TABLES                |  |                                      |
|              | 1                           | ICLID Ringing Assignments              | None                                 |
|              | 2                           | Preset Forward Day Destination         | None                                 |
|              | 3                           | Preset Forward Night Destination       | None                                 |
|              | 4                           | Preset Forward Special Destination     | None                                 |
|              | 5                           | Preset Forward VMID                    | None                                 |
|              | 6                           | Preset Forward Day Timer               | 10 sec                               |
|              | 7                           | MOH Channel                            | None                                 |
|              | 8                           | Universal Day Answer                   | None                                 |
|              | 9                           | Universal Night Answer                 | None                                 |
|              | 10                          | Tenant Group Incoming Ring Assignments | Group 0                              |
|              | 11                          | Preset Forward Night Timer             | 10 sec                               |
|              | 12                          | Preset Forward Special Timer           | 10 sec                               |
|              | 17                          | View ICLID Ringing Assignments         | None                                 |
|              | 18                          | Next ICLID Route Number                | None                                 |
| 19           | Previous ICLID Route Number | None                                   |                                      |
| 20           | Select Route Number         | None                                   |                                      |
| FLASH 44     | DID TABLES                  |  |                                      |
|              | 1                           | Route Number                           | refer to <a href="#">Figure A-2</a>  |
|              | 2                           | DID Phone Number                       | None                                 |
|              | 3                           | Name Assigned to Number                | None                                 |
|              | 4                           | Erasing a DID Table Entry              | None                                 |
| FLASH 55     | NAME/NUMBER TRANSLATION     |  |                                      |
|              | 1                           | Route Number                           | 1                                    |
|              | 2                           | Phone Number                           | None                                 |
|              | 3                           | Name                                   | None                                 |
|              | 4                           | Clear Entry                            | None                                 |
| FLASH 56     | 1                           | ICLID Disable/Enable                   | No=Disabled                          |
|              | 2                           | ICLID Name in Display                  | Yes=Telephone number in display      |
|              | 3                           | ICLID Baud Rate Display                | 9600                                 |
|              | 4                           | ICLID Port Assignment                  | Port #1                              |



### Programming Steps

1. Press the ICLID TABLES flexible button (**FLASH 80, Button #8**). The following message displays:

|                                    |
|------------------------------------|
| INITIALIZE ICLID-DID<br>PRESS HOLD |
|------------------------------------|

2. Press the HOLD button. A confirmation tone sounds.

## *Print ICLID - DID Tables*

### **Description**

The Print ICLID-DID Tables command dumps the entire database as a permanent record which can serve as a hardcopy of the database. The system baud rate must match that of the printer or receiving device. When printing the ICLID - DID Tables, the following data prints (an example follows the programming steps):

- ICLID Features
- ICLID Translation Table
- ICLID Unanswered Call Table
- ICLID Ringing Assignments Table
- DID Translation Table

### **Programming Steps**

1. Press the ICLID-DID TABLES flexible button (**FLASH 85, Button #9**). The following message displays:

PRINT ICLID-DID  
PRESS HOLD

2. To print the ICLID-DID Table(s), press the HOLD button. The following messages display:

PRINTING ICLID-DID

PRINTING ICLID TRANS NO

PRINTING ROUTE

PRINTING DID TRANS NO

3. When the system finishes sending the requested information to the printer, a confirmation tone sounds.

| ICLID                             | NAME  | BAUD    | PORT   |
|-----------------------------------|-------|---------|--------|
| N                                 | Y     | 9600    | 1      |
| ICLID TRANSLATION TABLE           |       |         |        |
| -----                             |       |         |        |
| ENTRY                             | ROUTE | NAME    | NUMBER |
| 600                               | ##    |         | .      |
| 601                               | ##    |         | .      |
| 602                               | ##    |         | .      |
| 603                               | ##    |         | .      |
| ... and so on through 799         |       |         |        |
| ICLID UNANSWERED CALL TABLE       |       |         |        |
| -----                             |       |         |        |
| NONE                              |       |         |        |
| ROUTE RING ASSIGNMENTS            |       |         |        |
| -----                             |       |         |        |
| 00                                | NONE  |         |        |
| 01                                | NONE  |         |        |
| ... and so on through 99 - NONE   |       |         |        |
| 100                               | S100A |         |        |
| 101                               | S101A |         |        |
| ... and so on through 149 - S149A |       |         |        |
| 150                               | NONE  |         |        |
| 151                               | NONE  |         |        |
| ... and so on through 251 - NONE  |       |         |        |
| DID TRANSLATION TABLE             |       |         |        |
| -----                             |       |         |        |
| ENTRY                             | ROUTE | NUMBER  | NAME   |
| 000                               | 100   | 0000000 |        |
| 001                               | 101   | 0000001 |        |
| ::                                | ::    | ::      |        |
| 049                               | 149   | 0000049 |        |
| 050                               | 001   | 0000050 |        |
| 051                               | 001   | 0000051 |        |
| ::                                | ::    | ::      |        |
| 098                               | 001   | 0000098 |        |
| 099                               | 199   | 0000099 |        |
| 100                               | 100   | 0000100 |        |
| 101                               | 101   | 0000101 |        |
| ::                                | ::    | ::      |        |
| 149                               | 149   | 0000149 |        |
| 150                               | 150   | 0000150 |        |
| 151                               | 001   | 0000151 |        |
| ::                                | ::    | ::      |        |
| 198                               | 001   | 0000198 |        |
| 199                               | 199   | 0000199 |        |
| 200                               | 100   | 0000200 |        |
| ... and so on through Entry 999   |       |         |        |

Figure A-2: ICLID - DID Tables Printout

---

## ICLID Call Management Tables

### Description

Two ICLID Call Management Tables are maintained in the system. These tables consist of an Answered Call Management Table and an Unanswered Call Management Table. Each have a 100-entry capacity.

### *Answered Call Management Table*

#### Description

The Answered ICLID Table feature adds a table that captures the ICLID calls that were answered. The table can store up to 100 entries of the most recently answered ICLID calls. A station may dial a unique access code to view the entries, scroll through the entries, and dial a desired entry back. The table displays the number as well as the station that answered the call.

#### Operation

This table may be accessed from any user station display phone so the answered calls may be reviewed and handled by the end user. Any Attendant station(s) can delete a table entry, one entry at a time. To enter the review process, dial [659]. The functions available to a user are:

**Table A-1: Caller ID Display (Answered Calls)**

| Function                            | Button        |
|-------------------------------------|---------------|
| Go to beginning of table            | Dial Code 659 |
| Toggle between Name/Number          | MUTE          |
| Step to next table entry            | HOLD          |
| Delete table entry (Attendant only) | FLASH         |
| Exit table review function          | ON/OFF        |
| Step to previous table entry        | TRANSFER      |
| Call Back                           | SPEED         |

#### Conditions

- » Telco must activate Caller ID service.
- » Auto Attendant calls are considered answered.

## *Unanswered Call Management Table*

### **Description**

An Unanswered Call Management Table with 100 entry capacity is maintained in the system. The calling number/name information pertaining to any unanswered call is placed in this table at the time the system determines the call was abandoned.

This table may be accessed from any display telephone to review unanswered calls. Only an Attendant station can delete an entry from this table.

### **Operation**

To enter the review process, dial [635]. The functions available to a phone are:

**Table A-2: Caller ID Display (Unanswered Calls)**

| <b>Function</b>                     | <b>Button</b> |
|-------------------------------------|---------------|
| Go to beginning of table            | Dial Code 635 |
| Toggle between Name/Number          | MUTE          |
| Step to next table entry            | HOLD          |
| Delete table entry (Attendant only) | FLASH         |
| Exit table review function          | ON/OFF        |
| Step to previous table entry        | TRANSFER      |
| Call Back                           | SPEED         |

### **Conditions**

- » Telco must activate Caller ID service.
- » Auto Attendant calls are considered answered.

*ICLID / Caller ID*

---

---

# B

## Least Cost Routing

This section describes the Least Cost Routing (LCR) feature and how to program the eight LCR Tables to monitor the digits dialed at each station and select the best route for the call.

»»

»»

»»

»»

»»

»»

»»

# NOTES

»»

»»

»»

»»

»»

»»

»»





## Introduction

The Least Cost Routing (LCR) feature allows the system to automatically select the least costly route available according to the number dialed, the time of day/day of week, the class of service (COS) assigned to the station/trunk group priority level assigned. When a station user dials an outside number, the LCR feature analyzes the number, then automatically chooses an outside line from the group that is programmed as most economical.

The LCR feature puts the responsibility of choosing the least expensive route for each area code and exchange code on the system administrator, not on the station user. In order to make a routing decision, the LCR feature is programmed in the system database. The successful operation of this feature is completely dependent on the accuracy of the programming. The STSe may be programmed on a per station basis to force the use of LCR for outgoing access. This allows the system administrator to maintain greater control over dialing patterns and the lines used for placing outgoing CO calls.

### LCR Tables

There are eight (8) different tables which are set up to monitor the dialing of digits of a station and to select the best route programmed for the call.

**3-Digit Routing Table** -- allows the system to handle call routing in areas that require a 1 before a long distance number and in areas that do not require the 1 for 7-, 8-, 10-, & 11-digit dialing.

**6-Digit Routing Table** -- is used to determine the route for one or more office codes programmed within the same area code.

**Exception Code Table** -- is used to route operator assisted calls and any other calls which would use a one or two-digit number rather than a three-digit area code.

**Route List Table** -- contains four Time Period Routing Lists that are used in conjunction with other LCR table settings.

**Insert/Delete Table** -- is used to add/remove digits from a number before or after it is dialed.

**Daily Start Time Table** -- allows the user to match the Time Periods discount structure to the carrier's rate schedule.

**Weekly Schedule Table** -- allows the user to assign the Time-of-Day and Day-of-Week to use the least costly route for a specific dialed number.

**Toll Information Table** -- allows common call routing for all toll information calls: 1-(xxx)555-1212, (xxx)555-1212, 1-555-1212, and 555-1212.

DEFAULT LCR Database -- provides basic routing for all local and long distance dialing.

### Related Information

| Quick Reference |            |   |
|-----------------|------------|---|
| ➡ Flash 05      | Button #7  | LCR function must be enabled <b>after</b> LCR Tables are programmed (refer to <a href="#">"Enable/Disable Least Cost Routing" on page B-18</a> ). |
| ➡ Flash 06      | Button #9  | LCR Call Progress feature -- To allow all users to hear digits being dialed (refer to <a href="#">"LCR Call Progress" on page B-14</a> ).         |
| ➡ Flash 01      | Button #20 | Interdigit Timeout (refer to <a href="#">"Inter-Digit Time-Out" on page 2-189</a> ).  |

### LCR Flowchart

This diagram illustrates the path of an outgoing call as it relates to the LCR feature when programmed.

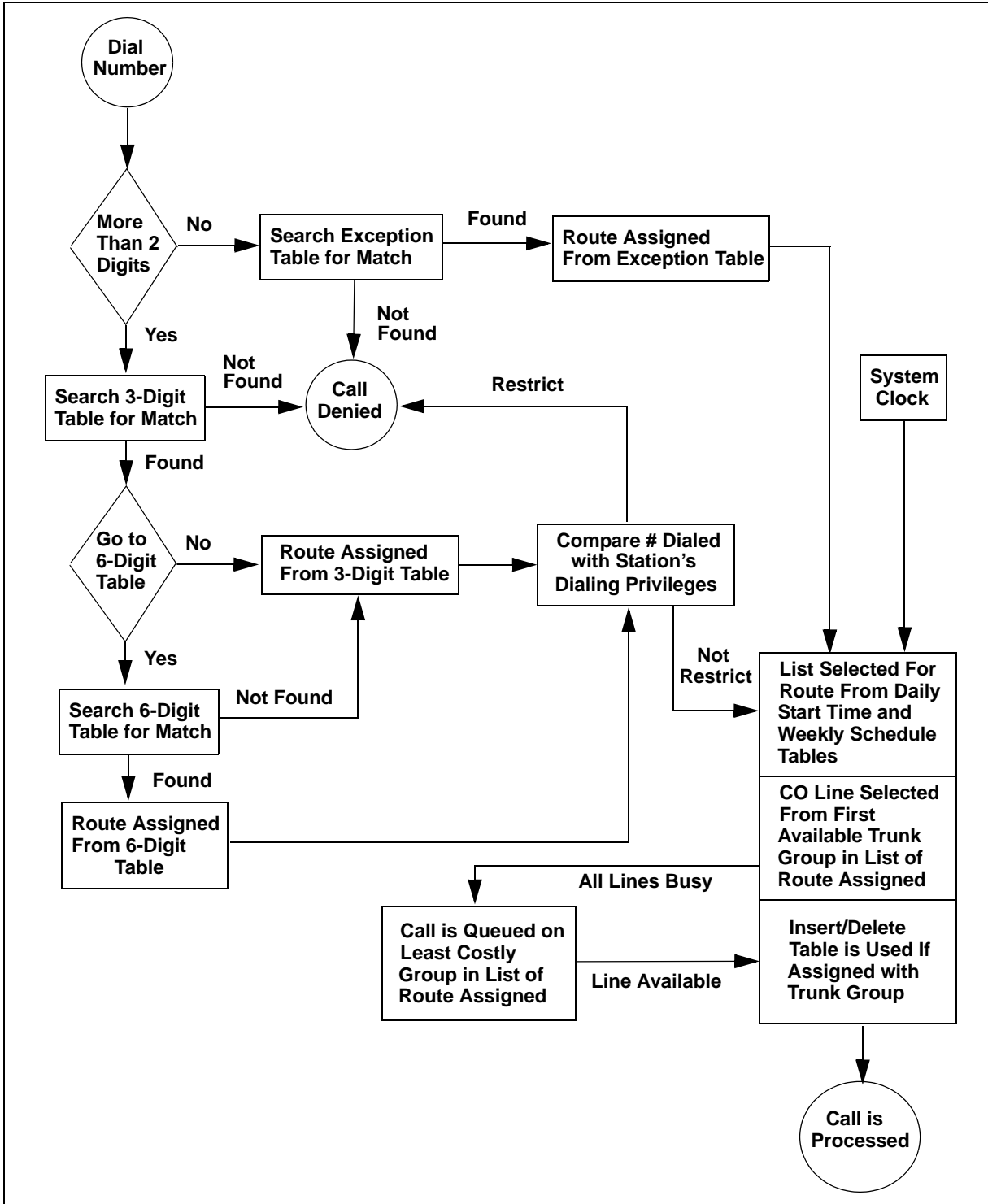

Figure B-1: LCR Flowchart

## Operation (When LCR is Enabled)

### To place an Outside Call:

1. Dial [9] on the dial pad,  
-or-

Press preprogrammed LCR button.

2. Dial the desired telephone number.
3. Wait for an answer. Lift handset or use the speakerphone to converse.

If all available lines are busy, remain off-hook for four seconds to automatically be queued onto LCR for an available line, then hang up.

### To answer an LCR Queue Call Back:

1. When telephone is signaled, answer the call.
2. Desired telephone number is automatically redialed.

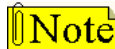

Only one LCR Queue Call Back request may be initiated by a station. When a second request is made, the first request is cancelled.  
If the 911 feature is enabled, the LCR access code is 800 instead of 9.

### CO Line Queue Cancel

To cancel a Call Back Request:

1. Dial the CO Line Queue Cancel code [626] on the dial pad.
2. Replace handset or press ON/OFF button.



SINGLE LINE TELEPHONE

The SLT operation uses the same procedures as used in Digital Telephone operation described above, except there is no LCR button.

---

## Programming LCR Tables

### Description

The Least Cost Routing (LCR) feature allows automatic selection of the most economical trunk according to the number dialed and the time of the day and day of the week. There are eight (8) different tables set up to monitor the dialing of digits of a station and to select the best route programmed for the call.



Flash 05, button #7 must be used to enable the Least Cost Routing feature.

## Programming Steps

If the system is in the programming mode, continue using the program codes. If starting to program here, enter the programming mode.

1. Press **FLASH** and dial **[75]**. The following message displays:

LCR TABLES  
 ENTER BUTTON NUMBER

2. There are eight tables which can be programmed here for LCR (you must also program LCR Class of Service in Station Programming). Use the procedures listed below to program these LCR tables.



*It is extremely important that the worksheets be completed before programming the LCR tables.*

## 3-Digit Area / Office Code Table

### Description

Both Leading 1 and Non-Leading 1 tables include all area codes (NPAs), and office codes (NXXs), from 200 to 999, including such numbers as 911, 411, etc. A complete entry into these tables include a route list table to be used, if the 6-digit table is to be checked and the number of digits likely to be dialed (Example: 7 or 10 digits). All local office codes must be entered in this table even if they do not require long distance calling.

The number of digits to expect entry aids the system in identifying when the last digit is dialed and to begin routing the call. This also helps to free SLT DTMF receivers if SLT traffic in the system is heavy.

For international calls, use 00 as number of digits to expect. This causes the system to wait five seconds (or inter-digit time-out) after user dials last digit before the system accesses a CO Line and dials out.

### Programming Steps

1. Press the 3-DIGIT TABLE flexible button (**FLASH 75, Button #1**). The following message displays:

3 DIGIT ROUTING TABLE  
 ENTER L NNN RRY PP HOLD

*L = [0] for Non-Leading 1 (1 not dialed), [1] for Leading 1 (1 is dialed)*

*NNN = Area/Office Code*

*RR = Route List Number 00-15*

*Y = [0] Do not go to 6-digit table, [1] Go to 6-digit table*

*PP = Number of digits expected to be dialed.*

2. Press the HOLD button to save the entry. A confirmation tone sounds and the display updates.

## 6-Digit Office Code Table

### Description

The 6-Digit Office Code Table determines a route for one or a group of individual office codes within an area code. Certain office codes within an area code can be given unique or special routing. If the office code dialed is not found in the 6-digit Office Code Table, the call is then routed according to the route list table as was entered in the 3-digit table.

The system allows twenty 6-digit Area/Office code tables (up to 800 entries per table) that may be used to route specific office codes within an area code. Each table routes calls for a common area code to a specified route. All entries made to a table route those office codes to the specified route list table. An area code may be entered into more than one 6-digit table with different routes specified.

### Programming Steps

1. Press the 6-DIGIT TABLE flexible button (**FLASH 75, Button #2**). The following message displays:

6 DIGIT ROUTING TABLE  
ENTER \* AAA RR NNN HOLD

\* = [0] to remove codes, [1] to add codes

AAA = Area Code

RR = Route Number 00-15

NNN = Office Code

2. Press the HOLD button to save the entry. A confirmation tone sounds and the display updates.
3. Enter additional office codes to be programmed into the same Area Code/Route Table, pressing HOLD after each office code entry.
4. Press a flexible button to program a different table.

### To Delete All Entries in an Area Code/Route Table:

Enter [0 AAA RR ###].

## Exception Code Table

### Description

The Exception Code Table is used for operator calls and any other calls that use a one- or two-digit entry, rather than a three-digit area code.

### Programming Steps

1. Press EXCEPTION TABLES flexible button (**FLASH 75, Button #3**). This message displays:

|  |
|--|
| EXCEPTION CODE TABLE<br>ENTER * XX RR HOLD |
|--|

\* = [0] to remove code from table, [1] to add code to table

XX = Exception codes for single digit codes, press MUTE button as 2nd digit.  
(The [\*] may be entered as the 1st digit only.)

RR = Route Table Number 00-15

2. Press the HOLD button to save the entry. A confirmation tone sounds and the display updates.
3. Press **FLASH 75, Button #3** again for further entries. Up to 20 Exception Codes may be programmed in this table.

## Route List Table

### Description

Each of the 16 Route List Tables available contains four Time Period Routing Lists, one for each of the 4 daily start time periods. Within each Time Period Route List up to 7 CO (outside) line groups and their corresponding Insert/Delete table, if any, and LCR Class Of Service Priority are programmed on a per line group basis.

When routing a CO call through LCR, CO Line groups are accessed in sequence so that the first line group entered represents the least costly (and first selected) and the last line group entered represents the most costly (and last selected).

The Route List Table references many other tables when processing a call for routing. First, the Daily Start Time Table is referenced to determine what start time entry should be checked in the Weekly Schedule Table. The corresponding entry in the weekly schedule table depending on the day of the week then determines which Time Period Route List should be used within the Route List Table.

The system then begins to check for idle lines in the first entered CO line group and proceeds until an idle line is found. While it is searching for an idle CO line the Station LCR COS is checked against the entries for LCR COS Priority of the specific CO line groups (see *LCR COS Priority* explanation).

- When an idle CO Line is found with a LCR priority equal to or higher than the station's LCR COS, a final check should be made to see if an Insert/Delete Table should be referenced.
- When all of the tables and entries are checked, the system then processes the call on the outside CO line.

**Note** Make sure you made entries into all Time Period Route Lists referenced in the weekly schedule table.

**LCR COS Priority**

A station should be assigned a class of service for LCR. The LCR COS can be between 0 and 6, with 0 being unrestricted and 6 being the most restrictive. Within the time period route List table, line groups are given an LCR COS Priority assignment between 0 and 6.

A station using LCR is able to use only those CO (outside) line groups with a priority assignment of equal or higher value than the station’s LCR Class of Service (e.g., a station with LCOS 3 can use line groups with a priority between 3 and 6).

**Table B-1: LCR Class of Service Table**

| Allow Access To Route  |   | LCR CO Line Group Priority |   |   |   |   |   |   |
|--|---|----------------------------|---|---|---|---|---|---|
|  |   | 0                          | 1 | 2 | 3 | 4 | 5 | 6 |
| <b>S<br/>T<br/>A<br/><br/>L<br/>C<br/>R<br/><br/>C<br/>O<br/>S</b> | 0 | Y                          | Y | Y | Y | Y | Y | Y |
|  | 1 | N                          | Y | Y | Y | Y | Y | Y |
|  | 2 | N                          | N | Y | Y | Y | Y | Y |
|  | 3 | N                          | N | N | Y | Y | Y | Y |
|  | 4 | N                          | N | N | N | Y | Y | Y |
|  | 5 | N                          | N | N | N | N | Y | Y |
|  | 6 | N                          | N | N | N | N | N | Y |

N = Cannot Use Line Group  
Y = Has Access to Line Group

**Programming Steps**

1. Press the ROUTE LIST TABLE flexible button (**FLASH 75, Button #4**). The following message displays:

ROUTE LIST TABLE  
RR T GG DD L

RR = Route List Table Number 00–15  
T = Time Period Route List 1–4  
GG = CO Line Group 00–23  
DD = Insert/Delete Table reference 00-19 (## for none)  
L = LCR Class of Service (LCOS)

2. To create an entry, dial [RR] + [T] + [GG] + [DD] + [L], then press HOLD to save the entry. A confirmation tone sounds and the display updates.
3. To enter additional CO Line groups in the same Time Period Route List number, dial [GG] + [DD] + [L], then press HOLD.

**To enter data for a different time period route list:**

1. Press program **FLASH 75, Button #4** and enter all data (RR T GG DD L).
2. Repeat the above to program a new Route Number 00 to 15 or press a flexible button to program other LCR information.
3. To advance to the next entry, use Button #18.
4. To return to a previous entry, use Button #19.

When **Call Cost** feature is enabled in FLASH 05, Button #11, the following message displays.

|                                      |
|--------------------------------------|
| ROUTE LIST TABLE<br>RR T CCC GG DD L |
|--------------------------------------|

*RR = Route List Table Number 00-15*

*T = Time Period Route List 1-4*

*CCC = Cost for one minute (\$ 0.00–\$ 9.99)*

*GG = CO Line Group 00-23*

*DD = Insert/Delete Table reference 00-19 (## for none)*

*L = LCR Class of Service (LCOS)*

## *Insert/Delete Table*

### **Description**

Digits can be either added or deleted when dialing a number. For instance, if a user dials a long distance call that should be placed on a foreign exchange (FX) line, the digit [1] and the three-digit area code (NPA) dialed by the user must be deleted before the call can be placed on that FX line. An Insert/Delete table can be programmed to do this.

Digits can also be added to a number that has been dialed by the user. For instance, Other Common Carrier (OCC) access codes and authorization (ID) codes can be automatically inserted by the system either in front of, and/or behind the number dialed.

There are twenty Insert/Delete Tables and each allows entries in a delete table and a pre- and post-insert table. Up to 40 digits (including pauses) can be inserted (20 pre and 20 post) and up to 16 digits can be deleted. Digits can be inserted before or after the number dialed, but can be deleted only from the start of the number dialed.

To ensure that a pause is inserted in LCR at default, the database programming was changed to add a pause in each of the 20 LCR Insert and Delete Tables and insert table 0 in each of the route tables.



## Programming Steps

1. Press INSERT/DELETE TABLE flexible button (**FLASH 75, Button #5**). The following message displays:

|                       |
|-----------------------|
| DIGIT INSERT / DELETE |
| ENTER TT X DDD HOLD   |

2. Enter the table information as follows:
  - TT = Insert/Delete Table Number 00–19
  - X = [0] Pre-Delete numbers (first digits dialed in the number),  
-or-  
[1] Pre-Insert numbers (insert digits in front of number dialed,  
-or-  
[2] Post-Insert numbers (insert digits behind number dialed).
  - DDD = Digits (up to 16-digits may be deleted from the beginning of the number dialed and up to 40 digits can be inserted (20 pre and 20 post).
3. Press the HOLD button to save the entry. A confirmation tone sounds and the display updates.

### **To add and delete numbers in the same table:**

1. Enter the different Insertion/Deletion tables in step 1.
2. Enter as separate entries using the same table number.
3. In the Insert Tables for LCR Programming, press the TRANS button for a pause.
  - The [\*] and [#] digits are allowed as valid digits for inserting digits dialed over the network.
  - The [\*] and [#] are valid entries for adding digits in both the pre (in front of) or post (behind the number) tables.
  - The [\*] and [#] cannot be used as delete characters in the Delete tables.

### **To delete a table:**

Enter a valid table number and press the HOLD button.

## Daily Start Time Table

### Description

The Daily Start Time Table correlates the LCR Routing Table to the time sensitive discount structure offered by the customers carrier.

*EXAMPLE* -- In the most common situation:

- The most expensive rate period is between 8:00 am and 5:00 pm, often called the day rate.
- The first discount period usually starts at 5:00 pm and runs until 11:00 pm, often called Evening Rates.
- The remaining time (from 11:00 pm until 8:00 am) is referred to as night time rates which usually have the biggest discount.

Appendix B - Least Cost Routing

**Weekly Time Table** -- With the wide selection of Common Carriers, the least costly route for a particular area code may be different at different times of the day. To accommodate this situation, this table and the Weekly Time Table work together, dividing the day into four possible time periods. By default these tables are set at the standard divisions of 8 am, 5 pm, and 11 pm. However, these times can be changed.

Entries in the Daily Start Time table are used to select the time period to reference in the weekly schedule. Based on the time a call is placed, the daily start time table selects the time period to choose in the weekly schedule. The weekly schedule is then used to determine the time period route list in the Route List Table to use for routing the call for a particular day of the week. Times are entered in the 24-hour format.

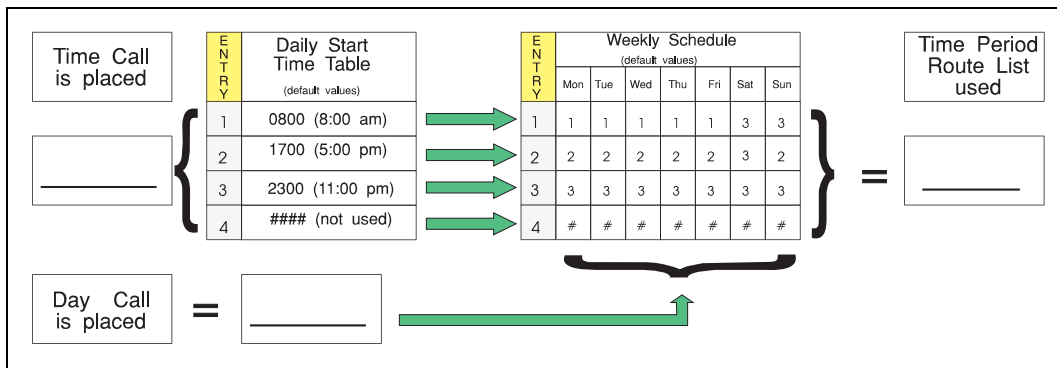

Figure B-2: Daily Start Time and Weekly Schedule Tables

**Programming Steps**

1. Press the DAILY START flexible button (**FLASH 75, Button #6**). The following message displays:

DAILY START TIME TABLE  
HHMM HHMM HHMM HHMM HOLD

2. Enter times in military format (2400 hours) in succession.
3. Press the HOLD button to save the entry. A confirmation tone sounds and the display updates.
  - Default times are 0800, 1700, 2300 (8 AM, 5 PM, and 11 PM), and the fourth time is disabled (####).
  - To change a Start Time, all times must be re-entered. Four pound signs [####] are displayed if nothing is entered for a specific time.

## Weekly Schedule Table

### Description

The Weekly Schedule Table determines what Time Period Route List to use within the Route List Table. When a call is placed and ultimately sent to a route list (call is not denied) based on the time of day the call is placed, the Daily Start Time Table selects the time period to reference in the Weekly Schedule Table.

The Time Period Route entered for the specified time period, as determined in the Daily Start Time Table and based on the day of week, is then selected and the call is routed according to the specified Time Period Route List.

EXAMPLE -- If a call is placed at 5:45 pm on a Monday, then according to the Daily Start Time Table (using default values) the entry for time period two of the weekly schedule is checked. Because it is Monday the entry for time period two on Monday is used and the result is that the Time Period Route List number two (again using default values) is used for all routes. Thus, the call is routed according to the entries in Time Period Two Route List no matter what route (00–15) is selected.

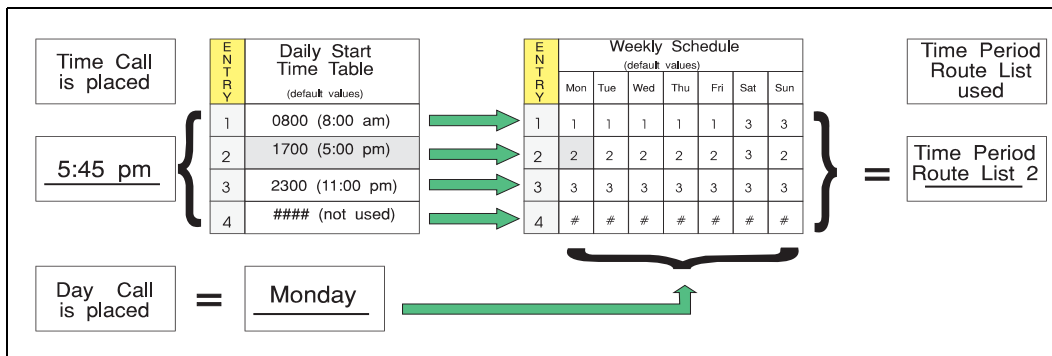

Figure B-3: Daily and Weekly Start Time Table

### Programming Steps

1. Press the WEEKLY SCHED flexible button (**FLASH 75, Button #7**). The following message displays:

WEEKLY SCHEDULE TABLE  
ENTER D T T T T HOLD

**D** = Day of the Week:

[0] thru [6] = Monday thru Sunday

**T** = Time Period Route List (1-4) to use for the time-of-day (based on the Daily Start Time table). Enter values for all time periods specified in the Daily Start Time table for that day.

1st T = Time Period Route List for first Daily Start Time (applies to all Route List tables).

2nd T = Time Period Route List for second Daily Start Time (applies to all Route List tables).

3rd T = Time Period Route List for third Daily Start Time (applies to all Route List tables).

4th T = Time Period Route List for fourth Daily Start Time (applies to all Route List tables).

2. Press the HOLD button after each complete daily entry. A confirmation tone sounds and the display updates.

## LCR Routing for Toll Information

### Description

The LCR Routing for Toll Information feature adds provisions to the LCR call processing which allows common call routing for all toll information calls. 1-(XXX) 555-1212, (XXX) 555-1212, 1-555-1212, and 555-1212 calls are intercepted and sent to a selected route in the Route List Table.

Numbers dialed are integrated and if it is determined to be a toll information call, either preceded with an area code or without or with a leading digit 1 or not, the call is sent to the route designated in programming.

By default, Toll Information Calls are sent to Route List Table Zero (0) which allows toll information calls to be placed on the system at default. A Toll Information route is chosen over a 3-digit or 6-digit route assignment if both are assigned. Entering the pound key twice [#] denies all Toll Information Calls.

### Programming Steps

1. Press the TOLL INFO flexible button (**FLASH 75, Button #8**). This message displays:

LCR ROUTE FOR 555 - 1212  
ENTER ROUTE

2. Enter a valid Route List number (00–15) for the Route referenced in the Route List table.
3. Press the HOLD button after programming the Route number. A confirmation tone sounds and the display updates.
4. Enable LCR at this point.

## LCR Call Progress

### Description

The LCR CALL PROGRESS Feature enables the installer to select, on a system-wide basis, whether users hear call progress indications.

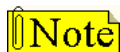

*If this feature is disabled, a confirmation tone is given after the last digit is dialed. The user does not hear the line being seized or the outpulsing of digits to the Central Office.*

### Programming Steps

1. Press LCR CALL PROGRESS flexible button (**FLASH 06, Button #9**). This message displays:

LCR CALL PROGRESS      0-1  
ENABLED

2. Enter a 0 or 1 on the dial pad to enable/disable the use of this feature.  
[0] = Disabled  
[1] = Enabled
3. Press HOLD to save the entry. A confirmation tone sounds.

DEFAULT ... LCR Call Progress feature is enabled.

## Default LCR Database

### Description

In an effort to decrease installation and set up time usually associated with LCR, a default LCR database was incorporated.

The default LCR database provides basic routing for local and long distance dialing. Default entries have been made in the 3-Digit Table for local office codes (NNXs) and all area codes (NPAs). Six routes have been established with the default database for routing of all calls under default.

## Forced Least Cost Routing (LCR)

### Description

Stations may be forced to place outgoing CO calls by use of LCR (dial [9]) to access an outside line. This lets the system administrator control dialing patterns and lines used for outgoing CO calls. This can be enabled/disabled on a per-station basis for additional flexibility and control. Forced LCR is optional (disabled) for all stations, and eliminates access to all other line groups.

Use Flash 50 programming when you want to modify a range of stations' attributes using **fixed** station numbers.

Use Flash 51 programming to modify a single station's attributes using a **flexible** station number.

### Programming Steps

1. Press **FLASH** and dial **[50]** or dial **[51]**. Flexible button #24 (New Range) is lit and one of the following messages displays:

#### Flash 50 - Fixed Numbers

STATION ATTRIBUTES  
SELECT A STATION RANGE

#### Flash 51 - Flexible Numbers

ENTER STATION NUMBER

2. Enter the range of **fixed** station numbers (100-351) to be programmed. If only one station is being programmed, enter that number twice, e.g., [100 100].



If **HOLD** is pressed without entering a station range, ALL stations are selected.

-or-

Enter a valid **flexible** number (100-8999) to be programmed.

## Appendix B - Least Cost Routing

- Press HOLD to save the entry. A confirmation tone sounds and the display updates. Flexible button #19 is lit. The display updates to reflect current programming for Page A:

**Flash 50 - Fixed Numbers**

|   |
|---|
| XXX - XXX PAGE A<br>ENTER BUTTON NUMBER |
|---|

*XXX-XXX = fixed station range*

**Flash 51 - Flexible Numbers**

|                                    |
|------------------------------------|
| SXXX PAGE A<br>ENTER BUTTON NUMBER |
|------------------------------------|

*XXX = 3- or 4-digit flexible number*

- Press the FORCE LCR flexible button (**Button #11**). The following message displays:

|                       |     |
|-----------------------|-----|
| FORCE LCR<br>DISABLED | 0-1 |
|-----------------------|-----|

- Enter a 0 or 1 on the dial pad to enable/disable this feature.  
[0] = Disabled  
[1] = Enabled
- Press HOLD to save the entry. A confirmation tone sounds.

**Conditions**

- » Only one station at a time can be programmed when using a flexible station number.
- » When in Flash 51 programming, if you press HOLD without specifying a flexible number to be programmed, you will get the station that is in port/station 100.

*LCR Class of Service (COS)***Description**

Stations can be given a class of service assignment for Least Cost Routing. The range is between 0-6, with 0 being unrestricted and 6 the most restricted. A station can use LCR routes with a priority number equal to or higher than the stations LCR COS assignment. Stations are given unrestricted access (0).

Use Flash 50 programming when you want to modify a range of stations' attributes using **fixed** station numbers.

Use Flash 51 programming to modify a single station's attributes using a **flexible** station number.

**Programming Steps**

- Press **FLASH** and dial **[50]** or dial **[51]**. Flexible button #24 (New Range) is lit and one of the following messages displays:

**Flash 50 - Fixed Numbers**

|  |
|--|
| STATION ATTRIBUTES<br>SELECT A STATION RANGE |
|--|

**Flash 51 - Flexible Numbers**

|                      |
|----------------------|
| ENTER STATION NUMBER |
|----------------------|

- Enter the range of **fixed** station numbers (100-351) to be programmed. If only one station is being programmed, enter that number twice, e.g., [100 100].

**Note** If HOLD is pressed without entering a station range, ALL stations are selected.

-or-

Enter a valid **flexible** number (100-8999) to be programmed.

- Press HOLD to save the entry. A confirmation tone sounds and the display updates. Flexible button #19 is lit. The display updates to reflect current programming for Page A:

**Flash 50 - Fixed Numbers**

XXX - XXX PAGE A  
ENTER BUTTON NUMBER

*XXX-XXX = fixed station range*

**Flash 51 - Flexible Numbers**

SXXX PAGE A  
ENTER BUTTON NUMBER

*XXX = 3- or 4-digit flexible number*

- Press button #20. The display updates to reflect current programming for Page B.

**Flash 50 - Fixed Numbers**

XXX - XXX PAGE B  
ENTER BUTTON NUMBER

*XXX-XXX = fixed station range*

**Flash 51 - Flexible Numbers**

SXXX PAGE B  
ENTER BUTTON NUMBER

*XXX = 3- or 4-digit flexible number*

- Press the LCR COS flexible button (**Button #9**). The following message displays:

LCR CLASS OF SERVICE    0-6  
0

- Enter a valid number (0–6) to correspond to the LCR Class of Service desired.
- Press HOLD to save the entry. A confirmation tone sounds and the display updates.

**Conditions**

- » Only one station at a time can be programmed when using a flexible station number.
- » When in Flash 51 programming, if you press HOLD without specifying a flexible number to be programmed, you will get the station that is in port/station 100.

## Enable/Disable Least Cost Routing

### Description

To use Least Cost Routing, it must be enabled. Before enabling LCR, refer to the Least Cost Routing programming tables.

After the tables are programmed, you may then enable LCR for the system. After system initialization, a default LCR database is loaded into the LCR section of memory.

### Programming Steps

1. Press the LCR ENABLE flexible button (**FLASH 05, Button #7**).
2. Enter a 0 or 1 that corresponds with the following entries:
  - [0] = Disabled
  - [1] = Enabled

|                    |     |
|--------------------|-----|
| LEAST COST ROUTING | 0-1 |
| DISABLED           |     |

3. Press HOLD to save the entry. A confirmation tone sounds.  
DEFAULT ... LCR is disabled.

## Call Cost Display

### Description

The Call Cost Display feature allows a user to view the approximate cost of each call made. This approximate cost is also printed as part of the SMDR record. The Call Cost Display replaces the call duration display when a call is made using LCR.

The cost information is programmable by selecting one of the 16 route list tables and one of the four time periods. This allows the user to program four separate costs based on the time of day for each of the 16 routes. The costs entered in the tables are costs for one minute, however, costs are calculated using a 1/10th of a minute value. These costs are rounded down and are based on the start time of the call, even if the call extends into a different time period. The SMDR printout contains a cost calculated using a 1/10th of a minute increment and the display updates approximately every 30 seconds.

### Programming Steps

1. Press the CALL COST DISPLAY flexible button (**FLASH 05, Button #11**).
2. Enter a 0 or 1 that corresponds with the following entries:
  - [0] = Disabled
  - [1] = Enabled

|                   |     |
|-------------------|-----|
| CALL COST DISPLAY | 0-1 |
| DISABLED          |     |

3. Press HOLD to save the entry. A confirmation tone sounds.  
DEFAULT ... Call Cost Display is disabled.



**Conditions**

- » The user must have LCR enabled to get the Call Cost Display.
- » When Call Cost Display is enabled, it changes the entry format for FLASH 75, Button #4 to include an entry of the cost for one minute.

*Initialize LCR Tables*

**Description**

The LCR Tables may be initialized to set all tables to their original, default values. The following tables are reset to their original default value after initialization of the LCR Tables:

**Table B-2: LCR Table Defaults**

| Program Code | Flexible Button | Features                         | Default Value (after initialization) |
|--------------|-----------------|----------------------------------|--------------------------------------|
| FLASH 75     | LCR TABLES      |                                  |                                      |
|              | 1               | 3-Digit Area/Office Code Table   | None                                 |
|              | 2               | 6-Digit Area/Office Code Table   |                                      |
|              | 3               | Exception Code Table             |                                      |
|              | 4               | Route List Table                 |                                      |
|              | 5               | Insert/Delete Table              |                                      |
|              | 6               | Daily Start Time Table           |                                      |
|              | 7               | Weekly Schedule Table            |                                      |
|              | 8               | LCR Routing for Toll Information | Table 0                              |

**Programming Steps**

1. Press the LCR TABLES flexible button (**FLASH 80, Button #7**). This message displays:

INITIALIZE LCR TABLES  
PRESS HOLD

2. Press the HOLD button. A confirmation tone sounds.

## *Print LCR Tables*

### **Description**

The Print LCR Tables command dumps the entire database as a permanent record which can serve as a hardcopy of the database. The system baud rate must match that of the printer or receiving device.

When printing information from the LCR Tables, the following data prints (examples follow programming steps):

- Exception Table
- Route List Table
- Insert/Delete Table
- Daily Time Table
- Weekly Time Table
- Toll Tables
- 6-Digit Table
- 3-Digit Table

### **Programming Steps**

1. Press the LCR TABLES flexible button (**FLASH 85, Button #7**). The following message displays:

PRINT LCR TABLES  
PRESS HOLD

2. To print the LCR Tables, press the HOLD button. The following message displays:

PRINTING LCR TABLES

When the system finishes sending the requested information to the printer, a confirmation tone sounds.

LCR Printout

| EXCEPTION CODE TABLE    |          |      |    |     |         |     |    | DIGIT INS/DEL TABLE           |        |        |   |   |   |   |   |
|-------------------------|----------|------|----|-----|---------|-----|----|-------------------------------|--------|--------|---|---|---|---|---|
| -----                   |          |      |    |     |         |     |    | -----                         |        |        |   |   |   |   |   |
| CODE                    | ROUTE NO |      |    |     |         |     |    | TABLE                         | DIGITS |        |   |   |   |   |   |
| -----                   |          |      |    |     |         |     |    | -----                         |        |        |   |   |   |   |   |
| <b>ROUTE LIST TABLE</b> |          |      |    |     |         |     |    | 0                             | PRE    | P      |   |   |   |   |   |
| -----                   |          |      |    |     |         |     |    | 1                             | PRE    |        |   |   |   |   |   |
| RT                      | TIME     | COST | CO | GRP | INS/DEL | GRP | PR | 2                             | PRE    | P      |   |   |   |   |   |
| 0                       | 1        | 026  | 1  |     | 0       |     | 1  | 3                             | PRE    | P      |   |   |   |   |   |
|                         | 2        | 026  | 1  |     | 0       |     | 1  | 4                             | PRE    | P      |   |   |   |   |   |
|                         | 3        | 026  | 1  |     | 0       |     | 1  | 5                             | PRE    | P      |   |   |   |   |   |
|                         | 4        | 026  | 1  |     | 0       |     | 1  | 6                             | PRE    | P      |   |   |   |   |   |
| 1                       | 1        | 000  | 1  |     | 0       |     | 1  | 7                             | PRE    | P      |   |   |   |   |   |
|                         | 2        | 000  | 1  |     | 0       |     | 1  | 8                             | PRE    | P      |   |   |   |   |   |
|                         | 3        | 000  | 1  |     | 0       |     | 1  | 9                             | PRE    | P      |   |   |   |   |   |
|                         | 4        | 000  | 1  |     | 0       |     | 1  | 10                            | PRE    | P      |   |   |   |   |   |
| 2                       | 1        | 010  | 1  |     | 0       |     | 1  | 11                            | PRE    | P      |   |   |   |   |   |
|                         | 2        | 010  | 1  |     | 0       |     | 1  | 12                            | PRE    | P      |   |   |   |   |   |
|                         | 3        | 010  | 1  |     | 0       |     | 1  | 13                            | PRE    | P      |   |   |   |   |   |
|                         | 4        | 010  | 1  |     | 0       |     | 1  | 14                            | PRE    | P      |   |   |   |   |   |
| 3                       | 1        | 072  | 1  |     | 0       |     | 1  | 15                            | PRE    | P      |   |   |   |   |   |
|                         | 2        | 072  | 1  |     | 0       |     | 1  | 16                            | PRE    | P      |   |   |   |   |   |
|                         | 3        | 072  | 1  |     | 0       |     | 1  | 17                            | PRE    | P      |   |   |   |   |   |
|                         | 4        | 072  | 1  |     | 0       |     | 1  | 18                            | PRE    | P      |   |   |   |   |   |
| 4                       | 1        | 171  | 1  |     | 0       |     | 1  | 19                            | PRE    | P      |   |   |   |   |   |
|                         | 2        | 171  | 1  |     | 0       |     | 1  |                               |        |        |   |   |   |   |   |
|                         | 3        | 171  | 1  |     | 0       |     | 1  |                               |        |        |   |   |   |   |   |
|                         | 4        | 171  | 1  |     | 0       |     | 1  |                               |        |        |   |   |   |   |   |
| 5                       | 1        | 106  | 1  |     | 0       |     | 1  |                               |        |        |   |   |   |   |   |
|                         | 2        | 106  | 1  |     | 0       |     | 1  |                               |        |        |   |   |   |   |   |
|                         | 3        | 106  | 1  |     | 0       |     | 1  |                               |        |        |   |   |   |   |   |
|                         | 4        | 106  | 1  |     | 0       |     | 1  |                               |        |        |   |   |   |   |   |
| 6                       | 1        | 277  | 1  |     | 0       |     | 1  |                               |        |        |   |   |   |   |   |
|                         | 2        | 277  | 1  |     | 0       |     | 1  |                               |        |        |   |   |   |   |   |
|                         | 3        | 277  | 1  |     | 0       |     | 1  |                               |        |        |   |   |   |   |   |
|                         | 4        | 277  | 1  |     | 0       |     | 1  |                               |        |        |   |   |   |   |   |
|                         |          |      |    |     |         |     |    | <b>DAILY START TIME TABLE</b> |        |        |   |   |   |   |   |
|                         |          |      |    |     |         |     |    | -----                         |        |        |   |   |   |   |   |
|                         |          |      |    |     |         |     |    | TABLE                         | TIME   |        |   |   |   |   |   |
|                         |          |      |    |     |         |     |    | 1                             | 800    |        |   |   |   |   |   |
|                         |          |      |    |     |         |     |    | 2                             | 1700   |        |   |   |   |   |   |
|                         |          |      |    |     |         |     |    | 3                             | 2300   |        |   |   |   |   |   |
|                         |          |      |    |     |         |     |    | 4                             | ####   |        |   |   |   |   |   |
|                         |          |      |    |     |         |     |    | <b>WEEKLY SCHEDULE TABLE</b>  |        |        |   |   |   |   |   |
|                         |          |      |    |     |         |     |    | -----                         |        |        |   |   |   |   |   |
|                         |          |      |    |     |         |     |    | START                         |        |        |   |   |   |   |   |
|                         |          |      |    |     |         |     |    | TIME                          | M      | T      | W | T | F | S | S |
|                         |          |      |    |     |         |     |    | -----                         |        |        |   |   |   |   |   |
|                         |          |      |    |     |         |     |    | 800                           | 1      | 1      | 1 | 1 | 1 | 3 | 3 |
|                         |          |      |    |     |         |     |    | 1700                          | 2      | 2      | 2 | 2 | 2 | 3 | 2 |
|                         |          |      |    |     |         |     |    | 2300                          | 3      | 3      | 3 | 3 | 3 | 3 | 3 |
|                         |          |      |    |     |         |     |    | ####                          | 3      | 3      | 3 | 3 | 3 | 3 | 3 |
|                         |          |      |    |     |         |     |    | LCR ROUTE FOR 555-1212        |        |        |   |   |   |   |   |
|                         |          |      |    |     |         |     |    | -----                         |        |        |   |   |   |   |   |
|                         |          |      |    |     |         |     |    | 0                             |        |        |   |   |   |   |   |
|                         |          |      |    |     |         |     |    | <b>6 DIGIT TABLE</b>          |        |        |   |   |   |   |   |
|                         |          |      |    |     |         |     |    | -----                         |        |        |   |   |   |   |   |
|                         |          |      |    |     |         |     |    | AREA                          | ROUTE  | OFFICE |   |   |   |   |   |
|                         |          |      |    |     |         |     |    | CODE NO                       |        | CODES  |   |   |   |   |   |

Appendix B - Least Cost Routing

| 3 DIGIT TABLE  |    |    |   |               |    |   |  |     |               |
|----------------|----|----|---|---------------|----|---|--|-----|---------------|
| CODE LEADING 1 |    |    |   | NON-LEADING 1 |    |   |  |     |               |
| RR             | PP | 6  |   | RR            | PP | 6 |  |     |               |
| 11             | ## | ## | N | 6             | ## | N |  | 261 | 0 11 N 1 7 N  |
| 200            | 0  | 11 | N | 1             | 7  | N |  | 262 | 0 11 N 1 7 N  |
| 201            | 0  | 11 | N | 1             | 7  | N |  | 263 | 0 11 N 1 7 N  |
| 202            | 0  | 11 | N | 1             | 7  | N |  | 264 | 0 11 N 1 7 N  |
| 203            | 0  | 11 | N | 1             | 7  | N |  | 265 | 0 11 N 1 7 N  |
| 204            | 3  | 11 | N | 1             | 7  | N |  | 266 | 0 11 N 1 7 N  |
| 205            | 0  | 11 | N | 1             | 7  | N |  | 267 | 0 11 N 1 7 N  |
| 206            | 0  | 11 | N | 1             | 7  | N |  | 268 | 0 11 N 1 7 N  |
| 207            | 0  | 11 | N | 1             | 7  | N |  | 269 | 0 11 N 1 7 N  |
| 208            | 0  | 11 | N | 1             | 7  | N |  | 270 | 0 11 N 1 7 N  |
| 209            | 0  | 11 | N | 1             | 7  | N |  | 271 | 0 11 N 1 7 N  |
| 210            | 0  | 11 | N | 1             | 7  | N |  | 272 | 0 11 N 1 7 N  |
| 211            | ## | ## | N | 1             | 7  | N |  | 273 | 0 11 N 1 7 N  |
| 212            | 0  | 11 | N | 1             | 7  | N |  | 274 | 0 11 N 1 7 N  |
| 213            | 0  | 11 | N | 1             | 7  | N |  | 275 | 0 11 N 1 7 N  |
| 214            | 0  | 11 | N | 1             | 7  | N |  | 276 | 0 11 N 1 7 N  |
| 215            | 0  | 11 | N | 1             | 7  | N |  | 277 | 0 11 N 1 7 N  |
| 216            | 0  | 11 | N | 1             | 7  | N |  | 278 | 0 11 N 1 7 N  |
| 217            | 0  | 11 | N | 1             | 7  | N |  | 279 | 0 11 N 1 7 N  |
| 218            | 0  | 11 | N | 1             | 7  | N |  | 280 | 0 11 N 1 7 N  |
| 219            | 0  | 11 | N | 1             | 7  | N |  | 281 | 0 11 N 1 7 N  |
| 220            | 0  | 11 | N | 1             | 7  | N |  | 282 | 0 11 N 1 7 N  |
| 221            | 0  | 11 | N | 1             | 7  | N |  | 283 | 0 11 N 1 7 N  |
| 222            | 0  | 11 | N | 1             | 7  | N |  | 284 | 0 11 N 1 7 N  |
| 223            | 0  | 11 | N | 1             | 7  | N |  | 285 | 0 11 N 1 7 N  |
| 224            | 0  | 11 | N | 1             | 7  | N |  | 286 | 0 11 N 1 7 N  |
| 225            | 0  | 11 | N | 1             | 7  | N |  | 287 | 0 11 N 1 7 N  |
| 226            | 0  | 11 | N | 1             | 7  | N |  | 288 | 0 11 N 1 7 N  |
| 227            | 0  | 11 | N | 1             | 7  | N |  | 289 | 0 11 N 1 7 N  |
| 228            | 0  | 11 | N | 1             | 7  | N |  | 290 | 0 11 N 1 7 N  |
| 229            | 0  | 11 | N | 1             | 7  | N |  | 291 | 0 11 N 1 7 N  |
| 230            | 0  | 11 | N | 1             | 7  | N |  | 292 | 0 11 N 1 7 N  |
| 231            | 0  | 11 | N | 1             | 7  | N |  | 293 | 0 11 N 1 7 N  |
| 232            | 0  | 11 | N | 1             | 7  | N |  | 294 | 0 11 N 1 7 N  |
| 233            | 0  | 11 | N | 1             | 7  | N |  | 295 | 0 11 N 1 7 N  |
| 234            | 0  | 11 | N | 1             | 7  | N |  | 296 | 0 11 N 1 7 N  |
| 235            | 0  | 11 | N | 1             | 7  | N |  | 297 | 0 11 N 1 7 N  |
| 236            | 0  | 11 | N | 1             | 7  | N |  | 298 | 0 11 N 1 7 N  |
| 237            | 0  | 11 | N | 1             | 7  | N |  | 299 | 0 11 N 1 7 N  |
| 238            | 0  | 11 | N | 1             | 7  | N |  | 300 | 0 11 N 1 7 N  |
| 239            | 0  | 11 | N | 1             | 7  | N |  | 301 | 0 11 N 1 7 N  |
| 240            | 0  | 11 | N | 1             | 7  | N |  | 302 | 0 11 N 1 7 N  |
| 241            | 0  | 11 | N | 1             | 7  | N |  | 303 | 0 11 N 1 7 N  |
| 242            | 0  | 11 | N | 1             | 7  | N |  | 304 | 0 11 N 1 7 N  |
| 243            | 0  | 11 | N | 1             | 7  | N |  | 305 | 0 11 N 1 7 N  |
| 244            | 0  | 11 | N | 1             | 7  | N |  | 306 | 3 11 N 1 7 N  |
| 245            | 0  | 11 | N | 1             | 7  | N |  | 307 | 0 11 N 1 7 N  |
| 246            | 0  | 11 | N | 1             | 7  | N |  | 308 | 0 11 N 1 7 N  |
| 247            | 0  | 11 | N | 1             | 7  | N |  | 309 | 0 11 N 1 7 N  |
| 248            | 0  | 11 | N | 1             | 7  | N |  | 310 | 0 11 N 1 7 N  |
| 249            | 0  | 11 | N | 1             | 7  | N |  | 311 | ## ## N 1 7 N |
| 250            | 0  | 11 | N | 1             | 7  | N |  | 312 | 0 11 N 1 7 N  |
| 251            | 0  | 11 | N | 1             | 7  | N |  | 313 | 0 11 N 1 7 N  |
| 252            | 0  | 11 | N | 1             | 7  | N |  | 314 | 0 11 N 1 7 N  |
| 253            | 0  | 11 | N | 1             | 7  | N |  | 315 | 0 11 N 1 7 N  |
| 254            | 0  | 11 | N | 1             | 7  | N |  | 316 | 0 11 N 1 7 N  |
| 255            | 0  | 11 | N | 1             | 7  | N |  | 317 | 0 11 N 1 7 N  |
| 256            | 0  | 11 | N | 1             | 7  | N |  | 318 | 0 11 N 1 7 N  |
| 257            | 0  | 11 | N | 1             | 7  | N |  | 319 | 0 11 N 1 7 N  |
| 258            | 0  | 11 | N | 1             | 7  | N |  | 320 | 0 11 N 1 7 N  |
| 259            | 0  | 11 | N | 1             | 7  | N |  | 321 | 0 11 N 1 7 N  |
| 260            | 0  | 11 | N | 1             | 7  | N |  | 322 | 0 11 N 1 7 N  |
|                |    |    |   |               |    |   |  | 323 | 0 11 N 1 7 N  |
|                |    |    |   |               |    |   |  | 324 | 0 11 N 1 7 N  |
|                |    |    |   |               |    |   |  | 325 | 0 11 N 1 7 N  |
|                |    |    |   |               |    |   |  | 326 | 0 11 N 1 7 N  |
|                |    |    |   |               |    |   |  | 327 | 0 11 N 1 7 N  |

Appendix B - Least Cost Routing

|     |   |    |   |   |   |   |     |   |    |   |   |   |   |
|-----|---|----|---|---|---|---|-----|---|----|---|---|---|---|
| 328 | 0 | 11 | N | 1 | 7 | N | 396 | 0 | 11 | N | 1 | 7 | N |
| 329 | 0 | 11 | N | 1 | 7 | N | 397 | 0 | 11 | N | 1 | 7 | N |
| 330 | 0 | 11 | N | 1 | 7 | N | 398 | 0 | 11 | N | 1 | 7 | N |
| 331 | 0 | 11 | N | 1 | 7 | N | 399 | 0 | 11 | N | 1 | 7 | N |
| 332 | 0 | 11 | N | 1 | 7 | N | 400 | 0 | 11 | N | 1 | 7 | N |
| 333 | 0 | 11 | N | 1 | 7 | N | 401 | 0 | 11 | N | 1 | 7 | N |
| 334 | 0 | 11 | N | 1 | 7 | N | 402 | 0 | 11 | N | 1 | 7 | N |
| 335 | 0 | 11 | N | 1 | 7 | N | 403 | 3 | 11 | N | 1 | 7 | N |
| 336 | 0 | 11 | N | 1 | 7 | N | 404 | 0 | 11 | N | 1 | 7 | N |
| 337 | 0 | 11 | N | 1 | 7 | N | 405 | 0 | 11 | N | 1 | 7 | N |
| 338 | 0 | 11 | N | 1 | 7 | N | 406 | 0 | 11 | N | 1 | 7 | N |
| 339 | 0 | 11 | N | 1 | 7 | N | 407 | 0 | 11 | N | 1 | 7 | N |
| 340 | 0 | 11 | N | 1 | 7 | N | 408 | 0 | 11 | N | 1 | 7 | N |
| 341 | 0 | 11 | N | 1 | 7 | N | 409 | 0 | 11 | N | 1 | 7 | N |
| 342 | 0 | 11 | N | 1 | 7 | N | 410 | 0 | 11 | N | 1 | 7 | N |
| 343 | 0 | 11 | N | 1 | 7 | N | 411 | 1 | 4  | N | 1 | 3 | N |
| 344 | 0 | 11 | N | 1 | 7 | N | 412 | 0 | 11 | N | 1 | 7 | N |
| 345 | 0 | 11 | N | 1 | 7 | N | 413 | 0 | 11 | N | 1 | 7 | N |
| 346 | 0 | 11 | N | 1 | 7 | N | 414 | 0 | 11 | N | 1 | 7 | N |
| 347 | 0 | 11 | N | 1 | 7 | N | 415 | 0 | 11 | N | 1 | 7 | N |
| 348 | 0 | 11 | N | 1 | 7 | N | 416 | 3 | 11 | N | 1 | 7 | N |
| 349 | 0 | 11 | N | 1 | 7 | N | 417 | 0 | 11 | N | 1 | 7 | N |
| 350 | 0 | 11 | N | 1 | 7 | N | 418 | 3 | 11 | N | 1 | 7 | N |
| 351 | 0 | 11 | N | 1 | 7 | N | 419 | 0 | 11 | N | 1 | 7 | N |
| 352 | 0 | 11 | N | 1 | 7 | N | 420 | 0 | 11 | N | 1 | 7 | N |
| 353 | 0 | 11 | N | 1 | 7 | N | 421 | 0 | 11 | N | 1 | 7 | N |
| 354 | 0 | 11 | N | 1 | 7 | N | 422 | 0 | 11 | N | 1 | 7 | N |
| 355 | 0 | 11 | N | 1 | 7 | N | 423 | 0 | 11 | N | 1 | 7 | N |
| 356 | 0 | 11 | N | 1 | 7 | N | 424 | 0 | 11 | N | 1 | 7 | N |
| 357 | 0 | 11 | N | 1 | 7 | N | 425 | 0 | 11 | N | 1 | 7 | N |
| 358 | 0 | 11 | N | 1 | 7 | N | 426 | 0 | 11 | N | 1 | 7 | N |
| 359 | 0 | 11 | N | 1 | 7 | N | 427 | 0 | 11 | N | 1 | 7 | N |
| 360 | 0 | 11 | N | 1 | 7 | N | 428 | 0 | 11 | N | 1 | 7 | N |
| 361 | 0 | 11 | N | 1 | 7 | N | 429 | 0 | 11 | N | 1 | 7 | N |
| 362 | 0 | 11 | N | 1 | 7 | N | 430 | 0 | 11 | N | 1 | 7 | N |
| 363 | 0 | 11 | N | 1 | 7 | N | 431 | 0 | 11 | N | 1 | 7 | N |
| 364 | 0 | 11 | N | 1 | 7 | N | 432 | 0 | 11 | N | 1 | 7 | N |
| 365 | 0 | 11 | N | 1 | 7 | N | 433 | 0 | 11 | N | 1 | 7 | N |
| 366 | 0 | 11 | N | 1 | 7 | N | 434 | 0 | 11 | N | 1 | 7 | N |
| 367 | 0 | 11 | N | 1 | 7 | N | 435 | 0 | 11 | N | 1 | 7 | N |
| 368 | 0 | 11 | N | 1 | 7 | N | 436 | 0 | 11 | N | 1 | 7 | N |
| 369 | 0 | 11 | N | 1 | 7 | N | 437 | 0 | 11 | N | 1 | 7 | N |
| 370 | 0 | 11 | N | 1 | 7 | N | 438 | 0 | 11 | N | 1 | 7 | N |
| 371 | 0 | 11 | N | 1 | 7 | N | 439 | 0 | 11 | N | 1 | 7 | N |
| 372 | 0 | 11 | N | 1 | 7 | N | 440 | 0 | 11 | N | 1 | 7 | N |
| 373 | 0 | 11 | N | 1 | 7 | N | 441 | 0 | 11 | N | 1 | 7 | N |
| 374 | 0 | 11 | N | 1 | 7 | N | 442 | 0 | 11 | N | 1 | 7 | N |
| 375 | 0 | 11 | N | 1 | 7 | N | 443 | 0 | 11 | N | 1 | 7 | N |
| 376 | 0 | 11 | N | 1 | 7 | N | 444 | 0 | 11 | N | 1 | 7 | N |
| 377 | 0 | 11 | N | 1 | 7 | N | 445 | 0 | 11 | N | 1 | 7 | N |
| 378 | 0 | 11 | N | 1 | 7 | N | 446 | 0 | 11 | N | 1 | 7 | N |
| 379 | 0 | 11 | N | 1 | 7 | N | 447 | 0 | 11 | N | 1 | 7 | N |
| 380 | 0 | 11 | N | 1 | 7 | N | 448 | 0 | 11 | N | 1 | 7 | N |
| 381 | 0 | 11 | N | 1 | 7 | N | 449 | 0 | 11 | N | 1 | 7 | N |
| 382 | 0 | 11 | N | 1 | 7 | N | 450 | 0 | 11 | N | 1 | 7 | N |
| 383 | 0 | 11 | N | 1 | 7 | N | 451 | 0 | 11 | N | 1 | 7 | N |
| 384 | 0 | 11 | N | 1 | 7 | N | 452 | 0 | 11 | N | 1 | 7 | N |
| 385 | 0 | 11 | N | 1 | 7 | N | 453 | 0 | 11 | N | 1 | 7 | N |
| 386 | 0 | 11 | N | 1 | 7 | N | 454 | 0 | 11 | N | 1 | 7 | N |
| 387 | 0 | 11 | N | 1 | 7 | N | 455 | 0 | 11 | N | 1 | 7 | N |
| 388 | 0 | 11 | N | 1 | 7 | N | 456 | 0 | 11 | N | 1 | 7 | N |
| 389 | 0 | 11 | N | 1 | 7 | N | 457 | 0 | 11 | N | 1 | 7 | N |
| 390 | 0 | 11 | N | 1 | 7 | N | 458 | 0 | 11 | N | 1 | 7 | N |
| 391 | 0 | 11 | N | 1 | 7 | N | 459 | 0 | 11 | N | 1 | 7 | N |
| 392 | 0 | 11 | N | 1 | 7 | N | 460 | 0 | 11 | N | 1 | 7 | N |
| 393 | 0 | 11 | N | 1 | 7 | N | 461 | 0 | 11 | N | 1 | 7 | N |
| 394 | 0 | 11 | N | 1 | 7 | N | 462 | 0 | 11 | N | 1 | 7 | N |
| 395 | 0 | 11 | N | 1 | 7 | N | 463 | 0 | 11 | N | 1 | 7 | N |

Appendix B - Least Cost Routing

|     |    |    |   |   |   |   |     |   |    |   |   |   |   |
|-----|----|----|---|---|---|---|-----|---|----|---|---|---|---|
| 464 | 0  | 11 | N | 1 | 7 | N | 532 | 0 | 11 | N | 1 | 7 | N |
| 465 | 0  | 11 | N | 1 | 7 | N | 533 | 0 | 11 | N | 1 | 7 | N |
| 466 | 0  | 11 | N | 1 | 7 | N | 534 | 0 | 11 | N | 1 | 7 | N |
| 467 | 0  | 11 | N | 1 | 7 | N | 535 | 0 | 11 | N | 1 | 7 | N |
| 468 | 0  | 11 | N | 1 | 7 | N | 536 | 0 | 11 | N | 1 | 7 | N |
| 469 | 0  | 11 | N | 1 | 7 | N | 537 | 0 | 11 | N | 1 | 7 | N |
| 470 | 0  | 11 | N | 1 | 7 | N | 538 | 0 | 11 | N | 1 | 7 | N |
| 471 | 0  | 11 | N | 1 | 7 | N | 539 | 0 | 11 | N | 1 | 7 | N |
| 472 | 0  | 11 | N | 1 | 7 | N | 540 | 0 | 11 | N | 1 | 7 | N |
| 473 | 0  | 11 | N | 1 | 7 | N | 541 | 0 | 11 | N | 1 | 7 | N |
| 474 | 0  | 11 | N | 1 | 7 | N | 542 | 0 | 11 | N | 1 | 7 | N |
| 475 | 0  | 11 | N | 1 | 7 | N | 543 | 0 | 11 | N | 1 | 7 | N |
| 476 | 0  | 11 | N | 1 | 7 | N | 544 | 0 | 11 | N | 1 | 7 | N |
| 477 | 0  | 11 | N | 1 | 7 | N | 545 | 0 | 11 | N | 1 | 7 | N |
| 478 | 0  | 11 | N | 1 | 7 | N | 546 | 0 | 11 | N | 1 | 7 | N |
| 479 | 0  | 11 | N | 1 | 7 | N | 547 | 0 | 11 | N | 1 | 7 | N |
| 480 | 0  | 11 | N | 1 | 7 | N | 548 | 0 | 11 | N | 1 | 7 | N |
| 481 | 0  | 11 | N | 1 | 7 | N | 549 | 0 | 11 | N | 1 | 7 | N |
| 482 | 0  | 11 | N | 1 | 7 | N | 550 | 0 | 11 | N | 1 | 7 | N |
| 483 | 0  | 11 | N | 1 | 7 | N | 551 | 0 | 11 | N | 1 | 7 | N |
| 484 | 0  | 11 | N | 1 | 7 | N | 552 | 0 | 11 | N | 1 | 7 | N |
| 485 | 0  | 11 | N | 1 | 7 | N | 553 | 0 | 11 | N | 1 | 7 | N |
| 486 | 0  | 11 | N | 1 | 7 | N | 554 | 0 | 11 | N | 1 | 7 | N |
| 487 | 0  | 11 | N | 1 | 7 | N | 555 | 0 | 11 | N | 1 | 7 | N |
| 488 | 0  | 11 | N | 1 | 7 | N | 556 | 0 | 11 | N | 1 | 7 | N |
| 489 | 0  | 11 | N | 1 | 7 | N | 557 | 0 | 11 | N | 1 | 7 | N |
| 490 | 0  | 11 | N | 1 | 7 | N | 558 | 0 | 11 | N | 1 | 7 | N |
| 491 | 0  | 11 | N | 1 | 7 | N | 559 | 0 | 11 | N | 1 | 7 | N |
| 492 | 0  | 11 | N | 1 | 7 | N | 560 | 0 | 11 | N | 1 | 7 | N |
| 493 | 0  | 11 | N | 1 | 7 | N | 561 | 0 | 11 | N | 1 | 7 | N |
| 494 | 0  | 11 | N | 1 | 7 | N | 562 | 0 | 11 | N | 1 | 7 | N |
| 495 | 0  | 11 | N | 1 | 7 | N | 563 | 0 | 11 | N | 1 | 7 | N |
| 496 | 0  | 11 | N | 1 | 7 | N | 564 | 0 | 11 | N | 1 | 7 | N |
| 497 | 0  | 11 | N | 1 | 7 | N | 565 | 0 | 11 | N | 1 | 7 | N |
| 498 | 0  | 11 | N | 1 | 7 | N | 566 | 0 | 11 | N | 1 | 7 | N |
| 499 | 0  | 11 | N | 1 | 7 | N | 567 | 0 | 11 | N | 1 | 7 | N |
| 500 | 0  | 11 | N | 1 | 7 | N | 568 | 0 | 11 | N | 1 | 7 | N |
| 501 | 0  | 11 | N | 1 | 7 | N | 569 | 0 | 11 | N | 1 | 7 | N |
| 502 | 0  | 11 | N | 1 | 7 | N | 570 | 0 | 11 | N | 1 | 7 | N |
| 503 | 0  | 11 | N | 1 | 7 | N | 571 | 0 | 11 | N | 1 | 7 | N |
| 504 | 0  | 11 | N | 1 | 7 | N | 572 | 0 | 11 | N | 1 | 7 | N |
| 505 | 0  | 11 | N | 1 | 7 | N | 573 | 0 | 11 | N | 1 | 7 | N |
| 506 | 3  | 11 | N | 1 | 7 | N | 574 | 0 | 11 | N | 1 | 7 | N |
| 507 | 0  | 11 | N | 1 | 7 | N | 575 | 0 | 11 | N | 1 | 7 | N |
| 508 | 0  | 11 | N | 1 | 7 | N | 576 | 0 | 11 | N | 1 | 7 | N |
| 509 | 0  | 11 | N | 1 | 7 | N | 577 | 0 | 11 | N | 1 | 7 | N |
| 510 | 0  | 11 | N | 1 | 7 | N | 578 | 0 | 11 | N | 1 | 7 | N |
| 511 | ## | ## | N | 1 | 7 | N | 579 | 0 | 11 | N | 1 | 7 | N |
| 512 | 0  | 11 | N | 1 | 7 | N | 580 | 0 | 11 | N | 1 | 7 | N |
| 513 | 0  | 11 | N | 1 | 7 | N | 581 | 0 | 11 | N | 1 | 7 | N |
| 514 | 3  | 11 | N | 1 | 7 | N | 582 | 0 | 11 | N | 1 | 7 | N |
| 515 | 0  | 11 | N | 1 | 7 | N | 583 | 0 | 11 | N | 1 | 7 | N |
| 516 | 0  | 11 | N | 1 | 7 | N | 584 | 0 | 11 | N | 1 | 7 | N |
| 517 | 0  | 11 | N | 1 | 7 | N | 585 | 0 | 11 | N | 1 | 7 | N |
| 518 | 0  | 11 | N | 1 | 7 | N | 586 | 0 | 11 | N | 1 | 7 | N |
| 519 | 3  | 11 | N | 1 | 7 | N | 587 | 0 | 11 | N | 1 | 7 | N |
| 520 | 0  | 11 | N | 1 | 7 | N | 588 | 0 | 11 | N | 1 | 7 | N |
| 521 | 0  | 11 | N | 1 | 7 | N | 589 | 0 | 11 | N | 1 | 7 | N |
| 522 | 0  | 11 | N | 1 | 7 | N | 590 | 0 | 11 | N | 1 | 7 | N |
| 523 | 0  | 11 | N | 1 | 7 | N | 591 | 0 | 11 | N | 1 | 7 | N |
| 524 | 0  | 11 | N | 1 | 7 | N | 592 | 0 | 11 | N | 1 | 7 | N |
| 525 | 0  | 11 | N | 1 | 7 | N | 593 | 0 | 11 | N | 1 | 7 | N |
| 526 | 0  | 11 | N | 1 | 7 | N | 594 | 0 | 11 | N | 1 | 7 | N |
| 527 | 0  | 11 | N | 1 | 7 | N | 595 | 0 | 11 | N | 1 | 7 | N |
| 528 | 0  | 11 | N | 1 | 7 | N | 596 | 0 | 11 | N | 1 | 7 | N |
| 529 | 0  | 11 | N | 1 | 7 | N | 597 | 0 | 11 | N | 1 | 7 | N |
| 530 | 0  | 11 | N | 1 | 7 | N | 598 | 0 | 11 | N | 1 | 7 | N |
| 531 | 0  | 11 | N | 1 | 7 | N | 599 | 0 | 11 | N | 1 | 7 | N |

Appendix B - Least Cost Routing

|     |    |    |   |   |   |   |     |    |    |   |   |   |   |
|-----|----|----|---|---|---|---|-----|----|----|---|---|---|---|
| 600 | 0  | 11 | N | 1 | 7 | N | 668 | 0  | 11 | N | 1 | 7 | N |
| 601 | 0  | 11 | N | 1 | 7 | N | 669 | 0  | 11 | N | 1 | 7 | N |
| 602 | 0  | 11 | N | 1 | 7 | N | 670 | 0  | 11 | N | 1 | 7 | N |
| 603 | 0  | 11 | N | 1 | 7 | N | 671 | 0  | 11 | N | 1 | 7 | N |
| 604 | 0  | 11 | N | 1 | 7 | N | 672 | 0  | 11 | N | 1 | 7 | N |
| 605 | 0  | 11 | N | 1 | 7 | N | 673 | 0  | 11 | N | 1 | 7 | N |
| 606 | 0  | 11 | N | 1 | 7 | N | 674 | 0  | 11 | N | 1 | 7 | N |
| 607 | 0  | 11 | N | 1 | 7 | N | 675 | 0  | 11 | N | 1 | 7 | N |
| 608 | 0  | 11 | N | 1 | 7 | N | 676 | 0  | 11 | N | 1 | 7 | N |
| 609 | 0  | 11 | N | 1 | 7 | N | 677 | 0  | 11 | N | 1 | 7 | N |
| 610 | 0  | 11 | N | 1 | 7 | N | 678 | 0  | 11 | N | 1 | 7 | N |
| 611 | ## | ## | N | 1 | 7 | N | 679 | 0  | 11 | N | 1 | 7 | N |
| 612 | 0  | 11 | N | 1 | 7 | N | 680 | 0  | 11 | N | 1 | 7 | N |
| 613 | 3  | 11 | N | 1 | 7 | N | 681 | 0  | 11 | N | 1 | 7 | N |
| 614 | 0  | 11 | N | 1 | 7 | N | 682 | 0  | 11 | N | 1 | 7 | N |
| 615 | 0  | 11 | N | 1 | 7 | N | 683 | 0  | 11 | N | 1 | 7 | N |
| 616 | 0  | 11 | N | 1 | 7 | N | 684 | 0  | 11 | N | 1 | 7 | N |
| 617 | 0  | 11 | N | 1 | 7 | N | 685 | 0  | 11 | N | 1 | 7 | N |
| 618 | 0  | 11 | N | 1 | 7 | N | 686 | 0  | 11 | N | 1 | 7 | N |
| 619 | 0  | 11 | N | 1 | 7 | N | 687 | 0  | 11 | N | 1 | 7 | N |
| 620 | 0  | 11 | N | 1 | 7 | N | 688 | 0  | 11 | N | 1 | 7 | N |
| 621 | 0  | 11 | N | 1 | 7 | N | 689 | 0  | 11 | N | 1 | 7 | N |
| 622 | 0  | 11 | N | 1 | 7 | N | 690 | 0  | 11 | N | 1 | 7 | N |
| 623 | 0  | 11 | N | 1 | 7 | N | 691 | 0  | 11 | N | 1 | 7 | N |
| 624 | 0  | 11 | N | 1 | 7 | N | 692 | 0  | 11 | N | 1 | 7 | N |
| 625 | 0  | 11 | N | 1 | 7 | N | 693 | 0  | 11 | N | 1 | 7 | N |
| 626 | 0  | 11 | N | 1 | 7 | N | 694 | 0  | 11 | N | 1 | 7 | N |
| 627 | 0  | 11 | N | 1 | 7 | N | 695 | 0  | 11 | N | 1 | 7 | N |
| 628 | 0  | 11 | N | 1 | 7 | N | 696 | 0  | 11 | N | 1 | 7 | N |
| 629 | 0  | 11 | N | 1 | 7 | N | 697 | 0  | 11 | N | 1 | 7 | N |
| 630 | 0  | 11 | N | 1 | 7 | N | 698 | 0  | 11 | N | 1 | 7 | N |
| 631 | 0  | 11 | N | 1 | 7 | N | 699 | 0  | 11 | N | 1 | 7 | N |
| 632 | 0  | 11 | N | 1 | 7 | N | 700 | 0  | 11 | N | 1 | 7 | N |
| 633 | 0  | 11 | N | 1 | 7 | N | 701 | 0  | 11 | N | 1 | 7 | N |
| 634 | 0  | 11 | N | 1 | 7 | N | 702 | 0  | 11 | N | 1 | 7 | N |
| 635 | 0  | 11 | N | 1 | 7 | N | 703 | 0  | 11 | N | 1 | 7 | N |
| 636 | 0  | 11 | N | 1 | 7 | N | 704 | 0  | 11 | N | 1 | 7 | N |
| 637 | 0  | 11 | N | 1 | 7 | N | 705 | 3  | 11 | N | 1 | 7 | N |
| 638 | 0  | 11 | N | 1 | 7 | N | 706 | 4  | 11 | N | 1 | 7 | N |
| 639 | 0  | 11 | N | 1 | 7 | N | 707 | 0  | 11 | N | 1 | 7 | N |
| 640 | 0  | 11 | N | 1 | 7 | N | 708 | 0  | 11 | N | 1 | 7 | N |
| 641 | 0  | 11 | N | 1 | 7 | N | 709 | 3  | 11 | N | 1 | 7 | N |
| 642 | 0  | 11 | N | 1 | 7 | N | 710 | 0  | 11 | N | 1 | 7 | N |
| 643 | 0  | 11 | N | 1 | 7 | N | 711 | ## | ## | N | 1 | 7 | N |
| 644 | 0  | 11 | N | 1 | 7 | N | 712 | 0  | 11 | N | 1 | 7 | N |
| 645 | 0  | 11 | N | 1 | 7 | N | 713 | 0  | 11 | N | 1 | 7 | N |
| 646 | 0  | 11 | N | 1 | 7 | N | 714 | 0  | 11 | N | 1 | 7 | N |
| 647 | 0  | 11 | N | 1 | 7 | N | 715 | 0  | 11 | N | 1 | 7 | N |
| 648 | 0  | 11 | N | 1 | 7 | N | 716 | 0  | 11 | N | 1 | 7 | N |
| 649 | 0  | 11 | N | 1 | 7 | N | 717 | 0  | 11 | N | 1 | 7 | N |
| 650 | 0  | 11 | N | 1 | 7 | N | 718 | 0  | 11 | N | 1 | 7 | N |
| 651 | 0  | 11 | N | 1 | 7 | N | 719 | 0  | 11 | N | 1 | 7 | N |
| 652 | 0  | 11 | N | 1 | 7 | N | 720 | 0  | 11 | N | 1 | 7 | N |
| 653 | 0  | 11 | N | 1 | 7 | N | 721 | 0  | 11 | N | 1 | 7 | N |
| 654 | 0  | 11 | N | 1 | 7 | N | 722 | 0  | 11 | N | 1 | 7 | N |
| 655 | 0  | 11 | N | 1 | 7 | N | 723 | 0  | 11 | N | 1 | 7 | N |
| 656 | 0  | 11 | N | 1 | 7 | N | 724 | 0  | 11 | N | 1 | 7 | N |
| 657 | 0  | 11 | N | 1 | 7 | N | 725 | 0  | 11 | N | 1 | 7 | N |
| 658 | 0  | 11 | N | 1 | 7 | N | 726 | 0  | 11 | N | 1 | 7 | N |
| 659 | 0  | 11 | N | 1 | 7 | N | 727 | 0  | 11 | N | 1 | 7 | N |
| 660 | 0  | 11 | N | 1 | 7 | N | 728 | 0  | 11 | N | 1 | 7 | N |
| 661 | 0  | 11 | N | 1 | 7 | N | 729 | 0  | 11 | N | 1 | 7 | N |
| 662 | 0  | 11 | N | 1 | 7 | N | 730 | 0  | 11 | N | 1 | 7 | N |
| 663 | 0  | 11 | N | 1 | 7 | N | 731 | 0  | 11 | N | 1 | 7 | N |
| 664 | 0  | 11 | N | 1 | 7 | N | 732 | 0  | 11 | N | 1 | 7 | N |
| 665 | 0  | 11 | N | 1 | 7 | N | 733 | 0  | 11 | N | 1 | 7 | N |
| 666 | 0  | 11 | N | 1 | 7 | N | 734 | 0  | 11 | N | 1 | 7 | N |
| 667 | 0  | 11 | N | 1 | 7 | N | 735 | 0  | 11 | N | 1 | 7 | N |

Appendix B - Least Cost Routing

|     |   |    |   |   |   |   |     |    |    |   |   |   |   |
|-----|---|----|---|---|---|---|-----|----|----|---|---|---|---|
| 736 | 0 | 11 | N | 1 | 7 | N | 804 | 0  | 11 | N | 1 | 7 | N |
| 737 | 0 | 11 | N | 1 | 7 | N | 805 | 0  | 11 | N | 1 | 7 | N |
| 738 | 0 | 11 | N | 1 | 7 | N | 806 | 0  | 11 | N | 1 | 7 | N |
| 739 | 0 | 11 | N | 1 | 7 | N | 807 | 3  | 11 | N | 1 | 7 | N |
| 740 | 0 | 11 | N | 1 | 7 | N | 808 | 0  | 11 | N | 1 | 7 | N |
| 741 | 0 | 11 | N | 1 | 7 | N | 809 | 5  | 11 | N | 1 | 7 | N |
| 742 | 0 | 11 | N | 1 | 7 | N | 810 | 0  | 11 | N | 1 | 7 | N |
| 743 | 0 | 11 | N | 1 | 7 | N | 811 | ## | ## | N | 1 | 7 | N |
| 744 | 0 | 11 | N | 1 | 7 | N | 812 | 0  | 11 | N | 1 | 7 | N |
| 745 | 0 | 11 | N | 1 | 7 | N | 813 | 0  | 11 | N | 1 | 7 | N |
| 746 | 0 | 11 | N | 1 | 7 | N | 814 | 0  | 11 | N | 1 | 7 | N |
| 747 | 0 | 11 | N | 1 | 7 | N | 815 | 0  | 11 | N | 1 | 7 | N |
| 748 | 0 | 11 | N | 1 | 7 | N | 816 | 0  | 11 | N | 1 | 7 | N |
| 749 | 0 | 11 | N | 1 | 7 | N | 817 | 0  | 11 | N | 1 | 7 | N |
| 750 | 0 | 11 | N | 1 | 7 | N | 818 | 0  | 11 | N | 1 | 7 | N |
| 751 | 0 | 11 | N | 1 | 7 | N | 819 | 0  | 11 | N | 1 | 7 | N |
| 752 | 0 | 11 | N | 1 | 7 | N | 820 | 0  | 11 | N | 1 | 7 | N |
| 753 | 0 | 11 | N | 1 | 7 | N | 821 | 0  | 11 | N | 1 | 7 | N |
| 754 | 0 | 11 | N | 1 | 7 | N | 822 | 0  | 11 | N | 1 | 7 | N |
| 755 | 0 | 11 | N | 1 | 7 | N | 823 | 0  | 11 | N | 1 | 7 | N |
| 756 | 0 | 11 | N | 1 | 7 | N | 824 | 0  | 11 | N | 1 | 7 | N |
| 757 | 0 | 11 | N | 1 | 7 | N | 825 | 0  | 11 | N | 1 | 7 | N |
| 758 | 0 | 11 | N | 1 | 7 | N | 826 | 0  | 11 | N | 1 | 7 | N |
| 759 | 0 | 11 | N | 1 | 7 | N | 827 | 0  | 11 | N | 1 | 7 | N |
| 760 | 0 | 11 | N | 1 | 7 | N | 828 | 0  | 11 | N | 1 | 7 | N |
| 761 | 0 | 11 | N | 1 | 7 | N | 829 | 0  | 11 | N | 1 | 7 | N |
| 762 | 0 | 11 | N | 1 | 7 | N | 830 | 0  | 11 | N | 1 | 7 | N |
| 763 | 0 | 11 | N | 1 | 7 | N | 831 | 0  | 11 | N | 1 | 7 | N |
| 764 | 0 | 11 | N | 1 | 7 | N | 832 | 0  | 11 | N | 1 | 7 | N |
| 765 | 0 | 11 | N | 1 | 7 | N | 833 | 0  | 11 | N | 1 | 7 | N |
| 766 | 0 | 11 | N | 1 | 7 | N | 834 | 0  | 11 | N | 1 | 7 | N |
| 767 | 0 | 11 | N | 1 | 7 | N | 835 | 0  | 11 | N | 1 | 7 | N |
| 768 | 0 | 11 | N | 1 | 7 | N | 836 | 0  | 11 | N | 1 | 7 | N |
| 769 | 0 | 11 | N | 1 | 7 | N | 837 | 0  | 11 | N | 1 | 7 | N |
| 770 | 0 | 11 | N | 1 | 7 | N | 838 | 0  | 11 | N | 1 | 7 | N |
| 771 | 0 | 11 | N | 1 | 7 | N | 839 | 0  | 11 | N | 1 | 7 | N |
| 772 | 0 | 11 | N | 1 | 7 | N | 840 | 0  | 11 | N | 1 | 7 | N |
| 773 | 0 | 11 | N | 1 | 7 | N | 841 | 0  | 11 | N | 1 | 7 | N |
| 774 | 0 | 11 | N | 1 | 7 | N | 842 | 0  | 11 | N | 1 | 7 | N |
| 775 | 0 | 11 | N | 1 | 7 | N | 843 | 0  | 11 | N | 1 | 7 | N |
| 776 | 0 | 11 | N | 1 | 7 | N | 844 | 0  | 11 | N | 1 | 7 | N |
| 777 | 0 | 11 | N | 1 | 7 | N | 845 | 0  | 11 | N | 1 | 7 | N |
| 778 | 0 | 11 | N | 1 | 7 | N | 846 | 0  | 11 | N | 1 | 7 | N |
| 779 | 0 | 11 | N | 1 | 7 | N | 847 | 0  | 11 | N | 1 | 7 | N |
| 780 | 0 | 11 | N | 1 | 7 | N | 848 | 0  | 11 | N | 1 | 7 | N |
| 781 | 0 | 11 | N | 1 | 7 | N | 849 | 0  | 11 | N | 1 | 7 | N |
| 782 | 0 | 11 | N | 1 | 7 | N | 850 | 0  | 11 | N | 1 | 7 | N |
| 783 | 0 | 11 | N | 1 | 7 | N | 851 | 0  | 11 | N | 1 | 7 | N |
| 784 | 0 | 11 | N | 1 | 7 | N | 852 | 0  | 11 | N | 1 | 7 | N |
| 785 | 0 | 11 | N | 1 | 7 | N | 853 | 0  | 11 | N | 1 | 7 | N |
| 786 | 0 | 11 | N | 1 | 7 | N | 854 | 0  | 11 | N | 1 | 7 | N |
| 787 | 0 | 11 | N | 1 | 7 | N | 855 | 0  | 11 | N | 1 | 7 | N |
| 788 | 0 | 11 | N | 1 | 7 | N | 856 | 0  | 11 | N | 1 | 7 | N |
| 789 | 0 | 11 | N | 1 | 7 | N | 857 | 0  | 11 | N | 1 | 7 | N |
| 790 | 0 | 11 | N | 1 | 7 | N | 858 | 0  | 11 | N | 1 | 7 | N |
| 791 | 0 | 11 | N | 1 | 7 | N | 859 | 0  | 11 | N | 1 | 7 | N |
| 792 | 0 | 11 | N | 1 | 7 | N | 860 | 0  | 11 | N | 1 | 7 | N |
| 793 | 0 | 11 | N | 1 | 7 | N | 861 | 0  | 11 | N | 1 | 7 | N |
| 794 | 0 | 11 | N | 1 | 7 | N | 862 | 0  | 11 | N | 1 | 7 | N |
| 795 | 0 | 11 | N | 1 | 7 | N | 863 | 0  | 11 | N | 1 | 7 | N |
| 796 | 0 | 11 | N | 1 | 7 | N | 864 | 0  | 11 | N | 1 | 7 | N |
| 797 | 0 | 11 | N | 1 | 7 | N | 865 | 0  | 11 | N | 1 | 7 | N |
| 798 | 0 | 11 | N | 1 | 7 | N | 866 | 0  | 11 | N | 1 | 7 | N |
| 799 | 0 | 11 | N | 1 | 7 | N | 867 | 0  | 11 | N | 1 | 7 | N |
| 800 | 0 | 11 | N | 1 | 7 | N | 868 | 0  | 11 | N | 1 | 7 | N |
| 801 | 0 | 11 | N | 1 | 7 | N | 869 | 0  | 11 | N | 1 | 7 | N |
| 802 | 0 | 11 | N | 1 | 7 | N | 870 | 0  | 11 | N | 1 | 7 | N |
| 803 | 0 | 11 | N | 1 | 7 | N | 871 | 0  | 11 | N | 1 | 7 | N |



Appendix B - Least Cost Routing

|     |   |    |   |   |   |   |     |   |    |   |   |   |   |
|-----|---|----|---|---|---|---|-----|---|----|---|---|---|---|
| 872 | 0 | 11 | N | 1 | 7 | N | 940 | 0 | 11 | N | 1 | 7 | N |
| 873 | 0 | 11 | N | 1 | 7 | N | 941 | 0 | 11 | N | 1 | 7 | N |
| 874 | 0 | 11 | N | 1 | 7 | N | 942 | 0 | 11 | N | 1 | 7 | N |
| 875 | 0 | 11 | N | 1 | 7 | N | 943 | 0 | 11 | N | 1 | 7 | N |
| 876 | 0 | 11 | N | 1 | 7 | N | 944 | 0 | 11 | N | 1 | 7 | N |
| 877 | 0 | 11 | N | 1 | 7 | N | 945 | 0 | 11 | N | 1 | 7 | N |
| 878 | 0 | 11 | N | 1 | 7 | N | 946 | 0 | 11 | N | 1 | 7 | N |
| 879 | 0 | 11 | N | 1 | 7 | N | 947 | 0 | 11 | N | 1 | 7 | N |
| 880 | 0 | 11 | N | 1 | 7 | N | 948 | 0 | 11 | N | 1 | 7 | N |
| 881 | 0 | 11 | N | 1 | 7 | N | 949 | 0 | 11 | N | 1 | 7 | N |
| 882 | 0 | 11 | N | 1 | 7 | N | 950 | 0 | 11 | N | 1 | 7 | N |
| 883 | 0 | 11 | N | 1 | 7 | N | 951 | 0 | 11 | N | 1 | 7 | N |
| 884 | 0 | 11 | N | 1 | 7 | N | 952 | 0 | 11 | N | 1 | 7 | N |
| 885 | 0 | 11 | N | 1 | 7 | N | 953 | 0 | 11 | N | 1 | 7 | N |
| 886 | 0 | 11 | N | 1 | 7 | N | 954 | 0 | 11 | N | 1 | 7 | N |
| 887 | 0 | 11 | N | 1 | 7 | N | 955 | 0 | 11 | N | 1 | 7 | N |
| 888 | 0 | 11 | N | 1 | 7 | N | 956 | 0 | 11 | N | 1 | 7 | N |
| 889 | 0 | 11 | N | 1 | 7 | N | 957 | 0 | 11 | N | 1 | 7 | N |
| 890 | 0 | 11 | N | 1 | 7 | N | 958 | 0 | 11 | N | 1 | 7 | N |
| 891 | 0 | 11 | N | 1 | 7 | N | 959 | 0 | 11 | N | 1 | 7 | N |
| 892 | 0 | 11 | N | 1 | 7 | N | 960 | 0 | 11 | N | 1 | 7 | N |
| 893 | 0 | 11 | N | 1 | 7 | N | 961 | 0 | 11 | N | 1 | 7 | N |
| 894 | 0 | 11 | N | 1 | 7 | N | 962 | 0 | 11 | N | 1 | 7 | N |
| 895 | 0 | 11 | N | 1 | 7 | N | 963 | 0 | 11 | N | 1 | 7 | N |
| 896 | 0 | 11 | N | 1 | 7 | N | 964 | 0 | 11 | N | 1 | 7 | N |
| 897 | 0 | 11 | N | 1 | 7 | N | 965 | 0 | 11 | N | 1 | 7 | N |
| 898 | 0 | 11 | N | 1 | 7 | N | 966 | 0 | 11 | N | 1 | 7 | N |
| 899 | 0 | 11 | N | 1 | 7 | N | 967 | 0 | 11 | N | 1 | 7 | N |
| 900 | 0 | 11 | N | 1 | 7 | N | 968 | 0 | 11 | N | 1 | 7 | N |
| 901 | 0 | 11 | N | 1 | 7 | N | 969 | 0 | 11 | N | 1 | 7 | N |
| 902 | 3 | 11 | N | 1 | 7 | N | 970 | 0 | 11 | N | 1 | 7 | N |
| 903 | 0 | 11 | N | 1 | 7 | N | 971 | 0 | 11 | N | 1 | 7 | N |
| 904 | 0 | 11 | N | 1 | 7 | N | 972 | 0 | 11 | N | 1 | 7 | N |
| 905 | 4 | 11 | N | 1 | 7 | N | 973 | 0 | 11 | N | 1 | 7 | N |
| 906 | 0 | 11 | N | 1 | 7 | N | 974 | 0 | 11 | N | 1 | 7 | N |
| 907 | 0 | 11 | N | 1 | 7 | N | 975 | 0 | 11 | N | 1 | 7 | N |
| 908 | 0 | 11 | N | 1 | 7 | N | 976 | 0 | 11 | N | 1 | 7 | N |
| 909 | 0 | 11 | N | 1 | 7 | N | 977 | 0 | 11 | N | 1 | 7 | N |
| 910 | 0 | 11 | N | 1 | 7 | N | 978 | 0 | 11 | N | 1 | 7 | N |
| 911 | 1 | 4  | N | 1 | 3 | N | 979 | 0 | 11 | N | 1 | 7 | N |
| 912 | 0 | 11 | N | 1 | 7 | N | 980 | 0 | 11 | N | 1 | 7 | N |
| 913 | 0 | 11 | N | 1 | 7 | N | 981 | 0 | 11 | N | 1 | 7 | N |
| 914 | 0 | 11 | N | 1 | 7 | N | 982 | 0 | 11 | N | 1 | 7 | N |
| 915 | 0 | 11 | N | 1 | 7 | N | 983 | 0 | 11 | N | 1 | 7 | N |
| 916 | 0 | 11 | N | 1 | 7 | N | 984 | 0 | 11 | N | 1 | 7 | N |
| 917 | 0 | 11 | N | 1 | 7 | N | 985 | 0 | 11 | N | 1 | 7 | N |
| 918 | 0 | 11 | N | 1 | 7 | N | 986 | 0 | 11 | N | 1 | 7 | N |
| 919 | 0 | 11 | N | 1 | 7 | N | 987 | 0 | 11 | N | 1 | 7 | N |
| 920 | 0 | 11 | N | 1 | 7 | N | 988 | 0 | 11 | N | 1 | 7 | N |
| 921 | 0 | 11 | N | 1 | 7 | N | 989 | 0 | 11 | N | 1 | 7 | N |
| 922 | 0 | 11 | N | 1 | 7 | N | 990 | 0 | 11 | N | 1 | 7 | N |
| 923 | 0 | 11 | N | 1 | 7 | N | 991 | 0 | 11 | N | 1 | 7 | N |
| 924 | 0 | 11 | N | 1 | 7 | N | 992 | 0 | 11 | N | 1 | 7 | N |
| 925 | 0 | 11 | N | 1 | 7 | N | 993 | 0 | 11 | N | 1 | 7 | N |
| 926 | 0 | 11 | N | 1 | 7 | N | 994 | 0 | 11 | N | 1 | 7 | N |
| 927 | 0 | 11 | N | 1 | 7 | N | 995 | 0 | 11 | N | 1 | 7 | N |
| 928 | 0 | 11 | N | 1 | 7 | N | 996 | 0 | 11 | N | 1 | 7 | N |
| 929 | 0 | 11 | N | 1 | 7 | N | 997 | 0 | 11 | N | 1 | 7 | N |
| 930 | 0 | 11 | N | 1 | 7 | N | 998 | 0 | 11 | N | 1 | 7 | N |
| 931 | 0 | 11 | N | 1 | 7 | N | 999 | 0 | 11 | N | 1 | 7 | N |
| 932 | 0 | 11 | N | 1 | 7 | N |     |   |    |   |   |   |   |
| 933 | 0 | 11 | N | 1 | 7 | N |     |   |    |   |   |   |   |
| 934 | 0 | 11 | N | 1 | 7 | N |     |   |    |   |   |   |   |
| 935 | 0 | 11 | N | 1 | 7 | N |     |   |    |   |   |   |   |
| 936 | 0 | 11 | N | 1 | 7 | N |     |   |    |   |   |   |   |
| 937 | 0 | 11 | N | 1 | 7 | N |     |   |    |   |   |   |   |
| 938 | 0 | 11 | N | 1 | 7 | N |     |   |    |   |   |   |   |
| 939 | 0 | 11 | N | 1 | 7 | N |     |   |    |   |   |   |   |



---

---

# C

## Flash-Based Voice Mail

This appendix includes an introduction, system programming procedures, and user procedures for the *Flash-based Voice Mail* system.

» » » » » » »

# NOTES

» » » » » » »

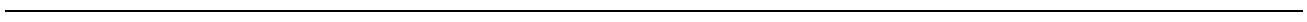

---

## Introduction

### *System Capabilities*

The *Flash-based Voice Mail* is a compact, high-performance, voice processing system. This feature-rich system will give even the smallest businesses the image of a much larger company. Productivity will increase because messages can be recorded, replied to, or forwarded to the appropriate person when necessary. Since nearly half of all telephone transactions require only one-way communications, the voice mail function streamlines business communication.

**When a message is recorded**, the voice mail system converts human speech to digital data and stores it in flash-memory.

**When the message is retrieved**, the voice mail system converts the digital data back to human speech.

**When a user is unavailable** and has forwarded their calls: the voice mail system answers the telephone, takes messages, and stores the messages for retrieval at a later time, from any location.

### *Basic Features*

This single-company basic voice mail system provides the ability to:

- Send copies of messages.
- Send messages to multiple destinations.
- Delete, reply, save, or skip a message.
- Receive message information indicating the date, time, and sender information, if available.
- Change recorded name, personal greeting, and password.
- Playback controls when sending or reviewing messages.
- Record a temporary greeting.

**8-Port System** -- More than one person can use the voice mail system features. Each port allows one user to access the voice mail system. A port is a path to the voice mail system. For example, up to eight users can be recording or reviewing messages at the same time with an 8-port voice mail system. Since not all users access the voice mail system at the same time, many users can be supported.

**Ease-of-Use** -- The *Flash-based Voice Mail* uses single digit commands, so there are no complex commands to memorize. The system constantly prompts users for the next action to be taken. Experienced users can interrupt prompts or even skip ahead several steps, if they know the digit for the desired action.

**Mailbox Functions** -- By using a Touch-Tone telephone, you can receive or send messages from any location through your voice mailbox. If you are busy in your office or away on a business trip, customers, vendors, or other employees can leave detailed messages in your voice mailbox. Protected by your password, these messages are completely confidential.

## Programming the Voice Mail System

The STSe must be programmed to recognize the slot location where the Voice Mail Interface Board is installed. Also, the voice mail's system features must be programmed using a touch tone telephone programming device and a personal computer. The following sections describe these programming requirements.

### Card Slot Programming

#### Description

The Card Slot Programming feature provides a means to assign the peripheral cards to alternative peripheral card slots. The Voice Mail Interface Board can only be installed in slot 7 of the BKSU.

#### Related Information

| Quick Reference |            |  |
|-----------------|------------|--|
| ➔ Flash 80      | Button #20 | System Reset (refer to <a href="#">"System Reset" on page 2-298</a> ). |

#### Programming Steps

1. Press **FLASH** and dial **[24]**. The following message displays:

|                                  |
|----------------------------------|
| CABINET 0<br>ENTER BUTTON NUMBER |
|----------------------------------|

2. Press flexible **Button # 8** to designate **slot 7**.

|       |         |       |
|-------|---------|-------|
| CAB 0 | SLOT XX | 00-18 |
| DTIB  |         |       |

3. Enter a valid number **[17] = VM1B (represents Flash-based VMIB)** for the type of card plugged into slot 7.
4. Press HOLD to save the entry. A confirmation tone sounds and the display updates.
5. Press the reset button on the Main Board Unit (MBU).

#### Conditions

- » After programming card slots, a system reset must be performed.

## Recorded Announcement Tables

### Description

The **Flash-based Voice Mail** can be used as a RAN Announcer for UCD Groups. A RAN mailbox is provided to play the announcement.

This feature establishes the type, index (port) number and message length for the eight available Recorded Announcements (RAN). There are eight RAN Tables that can be programmed. Table 1 can be the answer port for unanswered incoming calls to a UCD group.

### Programming Steps

If Recorded Announcement (RAN) devices are installed to operate with UCD, these tables must be programmed.

To program a Table for **Flash-based Voice Mail**:

1. Press **FLASH** and dial **[62]**. The following message displays:

|  |
|--|
| ANNOUNCEMENT TABLE 1<br>TYPE #   IDX ####   TIME ### |
|--|

The top left button in the flexible button field is lit for programming UCD RAN Announcement Table #1.

2. To change to another UCD RAN Announcement Table, press **FLASH 62** and a flexible button 2-8 for Tables 2-8 respectively.
3. Dial [4] for the Voice Mail function.
4. Dial the desired Voice Mail Group number, using a 4-digit format, e.g., for Voice Mail Group 440, enter 0440.
5. Dial a three-digit menu number [000-999].
6. Dial [0-9].
  - 0 = No DTMF Detection, No Messages Played (Default).
  - 1 = DTMF Detection, No Message.
  - 2 = No DTMF, Place In Queue Message.
  - 3 = DTMF Detection, Place In Queue Message.
  - 4 = No DTMF, Hold Time Message.
  - 5 = DTMF Detection, Hold Time Message.
  - 6 = No DTMF, Both Messages.
  - 7 = DTMF Detection, Both Messages.
  - 8 & 9 = Not used at this time.
7. Press HOLD to save the entry. A confirmation tone sounds and the display updates.

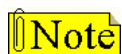

To program a Table for a Digital voice mail system, a CO Line port, an SLT port, or a RAN Hunt Group port, refer to *"Recorded Announcements"* on page 4-9.

### To clear entries:

1. Press the [#] button.
2. Then press HOLD.

## Programming Devices for *Flash-based Voice Mail System*

*Flash-based Voice Mail* programming is accomplished by using a touch-tone telephone and a personal computer. [Table C-1](#) shows the categories of programming that can be performed by each device.

**Table C-1: Programming Device Comparison**

| <b>Administration</b>                         | <b>Telephone</b> | <b>Computer</b> |
|---|------------------|-----------------|
| Class of Service                              |                  | •               |
| Date and Time                                 | •                | •               |
| Debug   |                  | •               |
| Free Sectors (message storage time remaining) |                  | •               |
| Invalid Digits                                |                  | •               |
| Mailbox Administration                        |                  |                 |
| Change Access Codes                           | •                | •               |
| Add a Mailbox                                 | •                | •               |
| Delete a Mailbox                              | •                | •               |
| Record a Mailbox Greeting                     | •                |                 |
| Reset Message Wait Indication                 | •                | •               |
| Notification                                  |                  |                 |
| Activate                                      | •                | •               |
| Edit Number                                   |                  | •               |
| New Number                                    |                  | •               |
| Numbering Plan                                |                  | •               |
| Open and Close Schedule                       |                  | •               |
| Operating Mode                                |                  |                 |
| Day   | •                | •               |
| Night   | •                | •               |
| Automatic                                     | •                | •               |
| Password (System)                             |                  | •               |
| PBX Integration (Telephone Type)              | •                | •               |
| PBX Integration parameters                    |                  | •               |
| Record Prompts                                | •                |                 |
| Review Prompts                                | •                |                 |
| Select System Greeting / per Port             |                  |                 |
| Normal  | •                | •               |
| Night   | •                | •               |
| Temporary                                     | •                | •               |
| Software Version Upgrade Procedure            |                  | •               |
| System Greeting                               |                  |                 |
| Review  | •                |                 |
| Record  | •                |                 |
| Delete  | •                |                 |
| Version Number                                |                  | •               |



The following is the recommended sequence for programming the voice mail system to perform basic operations. Perform programming in the order shown in [Table C-2](#) starting at the top of the table and continuing to the bottom of the table. This table illustrates the flow of programming; detailed programming steps are contained in following sections titled [“Programming System Functions Via Telephone”](#) and [“Programming System Functions Via Computer”](#).

**Table C-2: Basic Programming**

| <b>Using Computer Programming</b>  |  |
|------------------------------------|--|
| <b>Programming Type</b>            | <b>Description</b>   |
| PBX Integration                    | Select your telephone system from a list of possibilities. Example - selection number 00 represents Vodavi STSe 3-digit telephone systems. |
| Open & Close Schedule              | Identify the hours of your business operation.   |
| Number Plan                        | Activate the numbers that will appear as menu selections.  |
| Mailbox Assignment                 | <input type="checkbox"/> Identify mailbox and extension numbers.<br><input type="checkbox"/> Activate pager/beeper notification option.    |
| Class of Service                   | Verify COS settings.   |
| Auto Attendant Config              | Verify Auto Attendant Configuration  |
| <b>Using Telephone Programming</b> |  |
| <b>Programming Type</b>            | <b>Description</b>   |
| DTMF                               | Record system greeting (1- 9)  |
| DTMF                               | Record RAN mailboxes (801-816) for a three-digit numbering plan or (8001-8016) for a four-digit numbering plan.                            |

### *Programming System Functions Via Telephone*

To access the System Administrator Mailbox:

1. Dial into voice mail group (440-447).
2. When the system answers, dial [\*] + [#] followed by the System Administrator Mailbox number:  
 [#]+[0] = two-digit mailbox system  
 [#]+[00] = three-digit mailbox system  
 [#]+[000] = four-digit mailbox system  
 The system will announce: “Mailbox 15-00”, which is the System Administrator Mailbox number. This number does not conflict with Mailbox 15 in a two-digit mailbox system.
3. When requested, enter the System Administrator password. Default = [9]+[#]+[56].

|   |  |
|---|--|
|  <b>Note</b> | To change the System Administrator password refer to <a href="#">“Mailbox Administration”</a> on page C-9. |
|---|--|

The System Administrator Mailbox menu plays to prompt you to select one of the options listed below.

- Press:
- [1] for system greetings
  - [2] for Mailbox Administration
  - [3] for Auto Attendant configuration
  - [4] to set date and time
  - [5] to set operating mode
  - [6] to select PBX integration
  - [7] to record a prompt
  - [8] to listen to a prompt
  - [9] to change Open/Close Schedule

4. Select the appropriate button to select the desired option. Descriptions of the options are provided on the next several pages.

## **Administrator Options**

### ***System Greetings***

The programmed Day or Night greeting for each port, as programmed in the Number Plan screen, is the first announcement played to outside callers when they reach the system. Callers will either dial the system's access number directly or they might be forwarded when the dialed extension is busy or unanswered.

You have the option to record up to nine programmable greetings to provide callers with certain information and instructions upon their entering the system.

You can customize the system sign-on greetings to meet your organization's needs. When you record a customized greeting, remind subscribers to dial [#] to identify themselves to the system as subscribers. This is important for new subscribers who can get confused and end up leaving unintended messages for others rather than entering their own mailboxes.

Outside callers who have never encountered a voice message system should be given clear instructions on what to do when they reach the system. Since mailbox numbers are generally the same as the extension numbers, a caller can leave a message by just dialing a [\*] before the extension number of their intended party. By customizing the system greeting, explicit directions can be given to the outside caller.

To program system greetings:

1. Access the System Administrator Mailbox as described on [page C-7](#). The System Administrator Mailbox Menu plays.
2. Press [1] to access system greetings. The system will prompt you for the greeting number (1-9).
3. Enter the desired greeting number.

*For example:*

- 1 = Default Day greeting*
- 2 = Default Night greeting*
- 3 = Default Temporary greeting*
- 4 - 9 = Open for customized greetings*

4. You will be prompted with the following three choices:

Press [1] to Review. The greeting selected in Step 3 is played, then you are returned to Step 4.

Press [2] to Record. You will be prompted to record the greeting selected in Step 3. When you finish recording, press [#] to save the recording. Then you are returned to Step 4.

Press [3] to Delete. The system will announce that the greeting selected in Step 3 is deleted, then you are returned to Step 4.

5. When you finish work on the greeting initially selected in Step 3, you have three choices:

- Press [\*] to return to the Administrator Options Menu.
- Press [\*] + [\*] to return to the system Main Customer Call Routing (CCR) Menu.
- Press [\*] + [\*] + [\*] to exit the system completely.

### **Mailbox Administration**

Mailbox administrative functions are normally accessed using the programming terminal along with the appropriate programming screens on the system. However, for your convenience, a number of functions can be performed using your System Administrator mailbox. These include:

- Changing an unknown/forgotten mailbox access code to a new temporary access code.
- Adding new mailboxes. You may need to use the Mailbox Setup Screen to enter any additional information.
- Deleting an existing mailbox.
- Recording personal mailbox greetings.
- Resetting a Message Waiting Indicator (MWI).

These five activities are described in detail below.

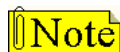

*When accessing any of these features, you are first asked to enter a mailbox number. This is the mailbox that will be acted upon.*

#### Changing a Mailbox Access Code

If a subscriber forgets their access code, you can reset it without deleting the mailbox and its messages. Once they are given the new temporary access code, the subscriber should immediately enter their mailbox and change the temporary access code to one of their own.



*This is the only method for changing the administrator mailbox access code.*

To change a Mailbox Access Code:

1. Access the System Administrator Mailbox as described on [page C-7](#). The Administrator Options Menu plays.
2. Press [2] to access mailbox administration.
3. After the prompt, enter the mailbox number for which you want to change the access code.
4. After the next prompt press [1] to change an access code.
5. Enter the new access code, then press [#] to accept. The system will announce the new access code for confirmation, then you are returned to the Administrator Options menu in Step 1.
6. When you finish changing the access code(s), you have three choices:
  - Press [1] through [9] to select another System Administrator task to perform.
  - Press [\*] to return to the system Main Customer Call Routing (CCR) Menu.
  - Press [\*] + [\*] to exit the system completely.
7. Give the new temporary access code to the subscriber. Tell the subscriber to enter their mailbox immediately to change the access code to one of their own choice.

#### Adding a Mailbox

When you add a mailbox to the system, several default values are assigned: the extension number will be the same as the mailbox number, the password will be [0] + [0] + [0] + [0], the Class of Service will default to 1, and the Outcall function will be turned OFF. If you need to change these options from the default values, you will have to use the Programming Terminal.

To add a mailbox:

1. Access the System Administrator Mailbox as described on [page C-7](#). The Administrator Options menu plays.
2. Press [2] to access mailbox administration.
3. After the prompt, enter the mailbox number for which you want to add.
4. After the next prompt, press [2] to add a mailbox. The system confirms addition of mailbox and then returns you to the Administrator Options Menu in Step 1.
5. When you finish adding a mailbox, you have four choices:
  - Enter a number to add another mailbox.
  - Press [\*] to select another System Administrator task to perform.
  - Press [\*] + [\*] to return to the system Main Customer Call Routing (CCR) Menu.
  - Press [\*] + [\*] + [\*] to exit the system completely.

### Deleting a Mailbox

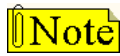

*Deleting a mailbox is a permanent action and the mailbox or its messages cannot be recovered after the delete action is confirmed by pressing [#].*

To delete a mailbox:

1. Access the System Administrator Mailbox as described on [page C-7](#). The Administrator Options menu plays.
2. Press [2] to access mailbox administration.
3. After the prompt, enter the mailbox number for which you want to delete.
4. After the next prompt, press [3] to delete the mailbox.
5. After the prompt, press [#] to confirm deletion or [\*] to cancel. You are then returned to the Administrator Options Menu in Step 1.
6. When you finish mailbox deletion activities, you have three choices:
  - Press [1] through [9] to select another System Administrator task to perform.
  - Press [\*] to return to the system Main Customer Call Routing (CCR) Menu.
  - Press [\*] + [\*] to exit the system completely.

### Recording a Mailbox Greeting

You can use the System Administrator's Mailbox to record the mailbox greeting for any system mailbox, as well as for RAN mailboxes.

To record a mailbox greeting:

1. Access the System Administrator Mailbox as described on [page C-7](#). The Administrator Options menu plays.
2. Press [2] to access mailbox administration.
3. After the prompt, enter the mailbox number for which you want to record a greeting.

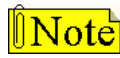

*RAN mailbox numbers are 801-816 (for 3-digit mailboxes) or 8001-8016 (for 4-digit mailboxes).*

4. After the next prompt, press [4] to record a mailbox greeting.
5. After the beep, record the mailbox greeting, then press [#] when finished.
6. After the prompt, press [#] to confirm the recording is satisfactory. You are then returned to the Administrator Options Menu in Step 1.
7. When you finish recording mailbox greeting activities, you have three choices:
  - Press [1] through [9] to select another System Administrator task to perform.
  - Press [\*] to return to the system Main Customer Call Routing (CCR) Menu.
  - Press [\*] + [\*] to exit the system completely.

### Resetting a Message Waiting Indicator

The System Administrator can reset the message waiting indicator (MWI) for a mailbox. When this option is selected, the system checks the current status of any messages stored in the mailbox. The system then dials the appropriate MWI “turn on” code if there are new messages in the mailbox and the appropriate “turn off” code if there are no new messages in the mailbox. This operation will re-synchronize the physical MWI with the mailbox message status.

To reset an MWI:

1. Access the System Administrator Mailbox as described on [page C-7](#). The Administrator Options menu plays.
2. Press [2] to access mailbox administration.
3. After the prompt, enter the mailbox number for which you need to reset the MWI.
4. After the next prompt, press [5] to reset MWI. The system confirms that the request has been processed and you are returned to the Administrator Options Menu in Step 1.
5. When you finish resetting MWI activities, you have three choices:
  - Press [1] through [9] to select another System Administrator task to perform.
  - Press [\*] to return to the system Main Customer Call Routing (CCR) Menu.
  - Press [\*] + [\*] to exit the system completely.

### **Auto Attendant Configuration**

Using this option allows you to easily change the greeting a caller will hear on a given port between the programmed Day/Night greeting and the programmed Temporary greeting. This is useful when a Temporary greeting for something like a weather-related closing needs to be activated from a remote location.

To change the Auto Attendant Configuration:

1. Access the System Administrator Mailbox as described on [page C-7](#). The Administrator Options menu plays.
2. Press [3] for Auto Attendant Configuration.
3. After the prompt, press [1] to select normal greeting or [2] to select temporary greeting.
4. After the prompt, press the appropriate port number to change [1] - [8]. You are returned to the Administrator Options Menu in Step 1.
5. When you finish Auto Attendant Configuration activities, you have three choices:
  - Press [1] through [9] to select another System Administrator task to perform.
  - Press [\*] to return to the system Main Customer Call Routing (CCR) Menu.
  - Press [\*] + [\*] to exit the system completely.

### Setting Date and Time

You may use the System Administrator Mailbox to set the system date and time. The time and date stamp is used for all envelope information and to check delivery notifications. It is important to set the system date and time accurately.

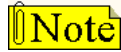

*The time and date must be reset whenever there is a local time change such as Daylight Savings Time.*

To set the system date and time:

1. Access the System Administrator Mailbox as described on [page C-7](#). The Administrator Options menu plays.
2. Press [4] to Set Date and Time.
3. After the prompt, press:
  - [1] to review data - the current date and time settings in the Voice Mail are announced, then you are returned to the Administrator Options Menu.
  - or-
  - [2] to change data - after the first prompt, enter the time in four-digit military time format e.g., 0930 for 9:30 a.m. or 1830 for 6:30 p.m. After the second prompt, enter the date as a six-digit number in MMDDYY format. You are then returned to the prompt that asks if you want to review data, change data, or exit.
  - or-
  - [\*] to exit - you are returned to the Administrator Options Menu.
4. When you finish setting Date and Time activities, you have three choices:
  - Press [1] through [9] to select another System Administrator task to perform.
  - Press [\*] to return to the system Main Customer Call Routing (CCR) Menu.
  - Press [\*] + [\*] to exit the system completely.

### Setting Operating Mode

Under normal conditions, the pre-programmed Auto Attendant screen controls the greeting that plays when the *Flash-based Voice Mail* answers a caller. This screen tells the *Flash-based Voice Mail* which greeting to play based upon the time of day, Day or Night, which is programmed in the Open & Close screen.

There may be a time when it is desirable to change the system from Day (Mode 1) to Night (Mode 2) at an other-than-normal time. The System Administrator can accomplish this by dialing into the system, rather than having to access the programming terminal.



*When the mode is changed manually to either Mode 1 or Mode 2, the **Flash-based Voice Mail** stays in that mode until the System Administrator changes the mode back to Automatic mode through the Administration Options menu. The mode cannot be changed from the programming terminal.*

The following are the System Operating Mode Numbers and their meanings.

- Mode 1 - Fixed Day Mode: the system is in Day Mode all of the time.
- Mode 2 - Fixed Night Mode: the system is in Night Mode all of the time.
- Mode 3 - Automatic Mode: the system follows the Open & Close times as programmed.

---

*Flash-Based Voice Mail*

To change the Operating Mode:

1. Access the System Administrator Mailbox as described on [page C-7](#). The Administrator Options menu plays.
2. Press [5] to Set Operating Mode.
3. After the prompt, press:
  - [1] to review data - the system will announce the current Mode and then you are returned to the prompt that asks if you want to review data, change data, or exit.
  - or-
  - [2] to change data - after the prompt, press:
    - [1] for Day Mode - choice is confirmed, then you return to prompt asking if you want to review, change, or exit.
    - or-
    - [2] for Night Mode - choice is confirmed, then you return to prompt asking if you want to review, change, or exit.
    - or-
    - [3] for Automatic Mode - choice is confirmed, then you return to prompt asking if you want to review, change, or exit.
  - or-
  - [\*] to exit - you are returned to the Administrator Options Menu.
4. When you finish Setting the Operating Mode, you have three choices:
  - Press [1] through [9] to select another System Administrator task to perform.
  - Press [\*] to return to the system Main Customer Call Routing (CCR) Menu.
  - Press [\*] + [\*] to exit the system completely.

### **Selecting PBX Integration**

The *Flash-based Voice Mail* uses a set of pre-programmed PBX Integration screens. These screens provide standard configurations for various PBX systems that might be used with the *Flash-based Voice Mail*.

The current PBX Integration may be changed from the System Administrator Mailbox.

To change the PBX Integration:

1. Access the System Administrator Mailbox as described on [page C-7](#). The Administrator Options menu plays.
2. Press [6] to Select PBX Integration.
3. After the prompt, press:
  - [1] to review data - the system will announce the current PBX Integration and then you are returned to the prompt that asks if you want to review data, change data, or exit.
  - or-
  - [2] to change data - after the prompt, enter the desired two-digit Integration Number (00 = Vodavi STSe 3 digit; 01 = Vodavi STSe 2 digit; 02 = Vodavi STSe 4 digit). You are then returned to the prompt that asks if you want to review data, change data, or exit.
  - or-
  - [\*] to exit - you are returned to the Administrator Options Menu.



4. When you finish Selecting a PBX Integration, you have three choices:
  - Press [1] through [9] to select another System Administrator task to perform.
  - Press [\*] to return to the system Main Customer Call Routing (CCR) Menu.
  - Press [\*] + [\*] to exit the system completely.

### **Recording a Prompt**

The *Flash-based Voice Mail* is shipped with a complete set of system voice prompts. These system prompts cover all system operations and functions.

There may be occasions, however, when it is desired to change the wording of a prompt to meet a specific requirement. This function allows such changes.

Refer to *"Voice Prompts"* on page C-38 for a complete listing of the system's default voice prompts.



*All of the supplied prompts are the same voice and volume level. If you desire to re-record a prompt, you should ensure that you use the same volume level and a similar tonal quality as the original.*

*You must not change any of the listed options and their activation keys. If you do, you will become confused when the options do not work as expected. There is no way to change these options in the field.*

To re-record a System Prompt:

1. Access the System Administrator Mailbox as described on [page C-7](#). The Administrator Options menu plays.
2. Press [7] to Record a Prompt.
3. After the prompt, enter the three-digit prompt number of the prompt that you want to re-record.
4. After the beep, record your new prompt, then press [#] when finished recording. You are then returned to the Administrator Options Menu.
5. When you finish Recording a Prompt, you have three choices:
  - Press [1] through [9] to select another System Administrator task to perform.
  - Press [\*] to return to the system Main Customer Call Routing (CCR) Menu.
  - Press [\*] + [\*] to exit the system completely.

### **Listening to a Prompt**

The *Flash-based Voice Mail* includes a method of listening to any or all of the recorded prompts. This may be used to determine whether it is necessary to modify a prompt.

You can listen to a single prompt, a range of prompts, or the last prompt that was recorded.

To listen to System Prompts:

1. Access the System Administrator Mailbox as described on [page C-7](#). The Administrator Options Menu plays.
2. Press [8] to Listen to a Prompt.

3. After the prompt, enter one of the following three options:
  - A three-digit prompt number, then when prompted enter the same number a second time. The selected prompt plays and then you are returned to the Administrator Options Menu.  
-or-
  - The first three-digit number of the range followed by the second three-digit number of the range. The selected prompts play and then you are then returned to the prompt that asks if you want to listen to a single prompt, listen to a range of prompts, or listen to the last prompt recorded.  
-or-
  - Press [#] to listen to the last prompt recorded. After the prompt plays you are returned to the Administrator Options Menu.
4. When you finish Listening to Prompts, you have three choices:
  - Press [1] through [9] to select another System Administrator task to perform.
  - Press [\*] to return to the system Main Customer Call Routing (CCR) Menu.
  - Press [\*] + [\*] to exit the system completely.

### ***Change Open and Close Schedule***

The *Flash-based Voice Mail* allows the system administrator to change the Opening and Closing Schedule via a DTMF telephone. This is useful for unscheduled closings or hour changes.

To change the Open & Close Schedule:

1. Access the System Administrator's Mailbox as described on [page C-7](#). The Administrator Options Menu plays.
2. Press [9] to change Open and Closing schedule. You are prompted to select the day of the week to modify.
3. Press the desired digit [1] through [7] to select a day of the week (Sun-Sat) to modify. You are prompted to select an option to either change the Closing time or the Opening time.
4. Press [2] for Closing time or [6] for Opening time. You are prompted to select an option to review, modify, or delete the time.
5. Press [1] to review, [2] to modify, or [3] to delete the selected value. A recorded announcement is provided to confirm the action you have taken.
6. Press [\*] after your changes are complete.
7. When all schedule changes are complete, you have three choices:
  - Press [1] through [9] to select another System Administrator task to perform.
  - Press [\*] to return to the system Main Customer Call Routing (CCR) Menu.
  - Press [\*] + [\*] to exit the system completely.

## Programming System Functions Via Computer

### PC Accessibility

**Cable Connection** -- The cable between the *Flash-based Voice Mail* card and the PC **must** be a straight-through cable. For information on remote programming, refer to [“Remote Programming & Maintenance Connection” on page C-43](#).

- Lift the cover of the *STSe* unit to access the programming port.
- After connecting the cable to the PC, plug the other end into the programming port on the *Flash-based Voice Mail* card.

**Desktop or Laptop** -- Programming is accomplished through the use of a laptop or standard PC desktop system. No special software is required. Any communications package that supports ANSI terminal emulation will work (e.g., HyperTerminal or ECOM). The required port speed and protocol is 9600 BAUD, 8-N-1.

If HyperTerminal is the communications package to be used, after opening HyperTerminal and the New Connection screen displays, perform the following steps before programming:

1. Type the desired name for your connection, select the desired icon, then click on OK.
2. When the “Connect To” window displays, change the setting in the “Connect using” box to: COM1 or COM2 (as required by your PC), then click on OK.
3. Once the COM1 Properties window displays, change the following settings:
  - a. Bits per second = 9600
  - b. Data bits = 8
  - c. Parity = None
  - d. Stop bits = 1
  - e. Flow control = None
4. Click on OK.
5. The HyperTerminal connection is now configured properly for programming the *Flash-based Voice Mail*.

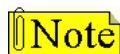

By default, HyperTerminal uses “Auto-Detect” for the terminal emulation mode. Though this does not normally cause a problem, the “Auto-Detect” setting can be changed to ANSI to avoid the terminal emulation mode changing in the process of administering the voice mail system. To change the setting, click on the HyperTerminal File>Properties option, click on the Settings tab, use the Emulation dropdown menu, then click on the ANSI option.

6. Type in the administrative password (default=0000) to access Programming Menus.

### Navigating in the System

Programming the *Flash-based Voice Mail* requires that you make entries in specific fields on several programming screens.

- These screens are accessed from the main menu by either selecting a number and pressing the <ENTER> key or by typing the number and pressing the <ENTER> key.

*Flash-Based Voice Mail*

- While working on a particular screen, use the arrow keys or the <ENTER> key to move through the fields. After you change a given field, press the <ENTER> key to save your change.

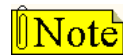

The <TAB> key **does not** provide field-to-field movement.

- If you are working in an area with multiple pages, such as the mailbox screen, press <F1> to go forward one screen and <F2> to go back one screen.
- When you finish work on a particular screen, press the <ESC> key to return to the Programming Menu.
- When you finish programming, type *exit* and press the <ENTER> key to shut down the programming interface.
- Access to the *Flash-based Voice Mail* is protected by password to prevent unauthorized changes to voice mail system parameters.

(The voice mail password must be entered each time you access the Programming area.)

## Menu Option Screens

### **Signing On**

This is the screen first shown when the programming terminal is connected.

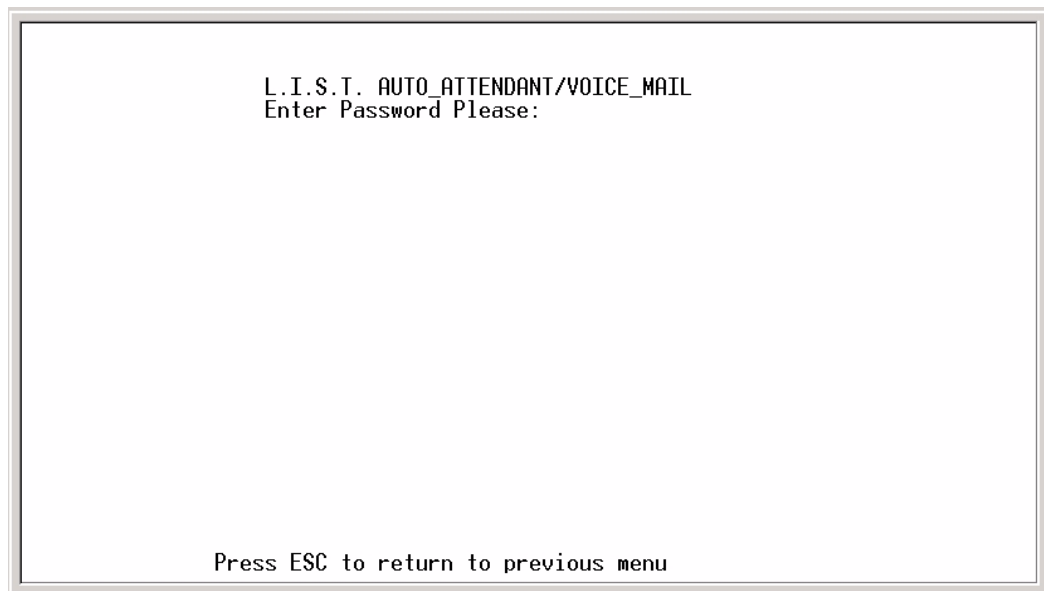

**Figure C-1: Sign-On Screen**

To enter the programming area, type in the correct password, then press <ENTER>. The default factory password is 0000. It can be changed by selecting Option 8 on the Programming Menu.

The *Flash-based Voice Mail* displays the Programming Menu shown in [Figure C-2](#).

### **Programming Menus**

The programming functions available are shown in [Figure C-2](#). Each function shown in the Programming Menus screen is linked to another screen where its parameters can be set. Each screen is described on the following pages.

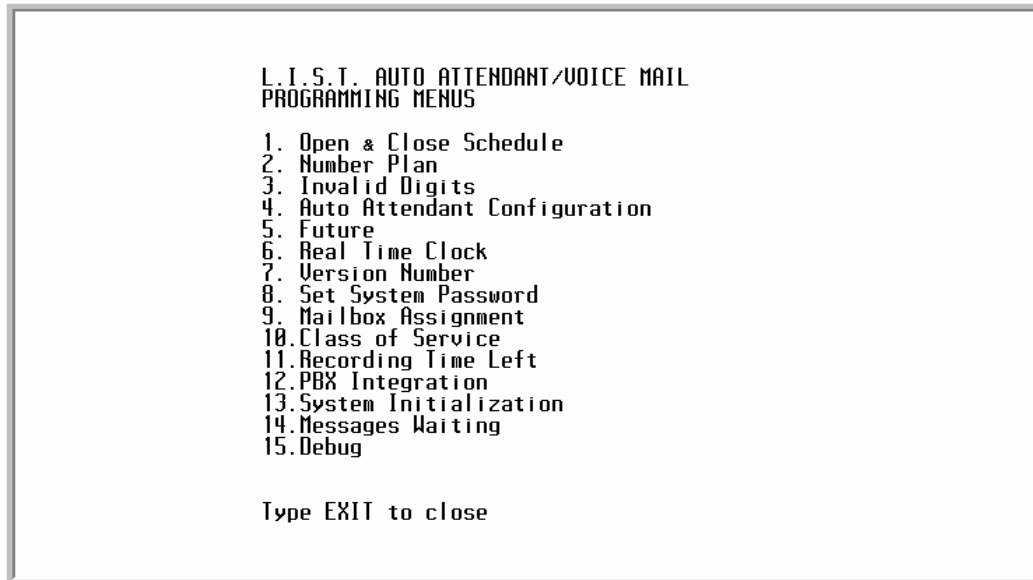

**Figure C-2: Programming Menu Screen**

1. To go to a specific screen, use the arrow keys to scroll down to your choice,  
-or-  
Type in the desired menu choice number.
2. Press the <ENTER> key to go to that screen.



*If the Programming Menu screen is left unattended for longer than five minutes, the screen will close and you will need to re-enter the System Password to gain access to the Programming Menu screen again.*

**Open and Close Schedule**

This time control screen is used to set the time when the *Flash-based Voice Mail* switches from Day to Night mode or Night to Day mode. Separate greetings are available for each mode. The greetings introduce callers to your company and tell them what digits to press to access certain departments, extensions, mailboxes, etc.

The Day/Opening greeting plays from the time you specify in the Open field until the time specified in the Close field. The Night/Close greeting plays after the time specified in the Close field until the next specified time in the Open field. For example, in [Figure C-3](#) the Day greeting is played during weekdays from 9:00 a.m. through 5:00 p.m. The Night greeting is played from 5:00 p.m. through 9:00 a.m. Monday through Friday, and from 5:00 p.m. Friday through 9:00 a.m. Monday.

| Open & Close Schedule |         |         |         |         |         |         |     |
|-----------------------|---------|---------|---------|---------|---------|---------|-----|
|                       | SUN     | MON     | TUE     | WED     | THU     | FRI     | SAT |
| Open:                 | 9:00 AM | 9:00 AM | 9:00 AM | 9:00 AM | 9:00 AM | 9:00 AM | - - |
| Close:                | 5:00 PM | 5:00 PM | 5:00 PM | 5:00 PM | 5:00 PM | 5:00 PM | - - |

Press ESC to return to previous menu

**Figure C-3: Open & Close Schedule Screen**

1. Enter the desired time schedule for each day as required. For example, Open: 9:00 AM, Close: 5:00 PM.
2. Press <ENTER> to store each entry.

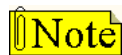

**Note** Leaving the Open and Close entries blank for a given day will represent a 24-hour period.  
Entries can be made using 24-hour notation, e.g., 18:00 represents 6:00 p.m.

To delete an entry:

1. Press the arrow key until the desired field is selected.
2. Then press <F4>.

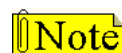

**Note** If you use the F4 key to clear all of the times, the system will continue to use the greeting that was active at the time that you cleared the entries.

**System Numbering Plan**

This menu screen is used to control how the *Flash-based Voice Mail* system processes digits entered by a caller.

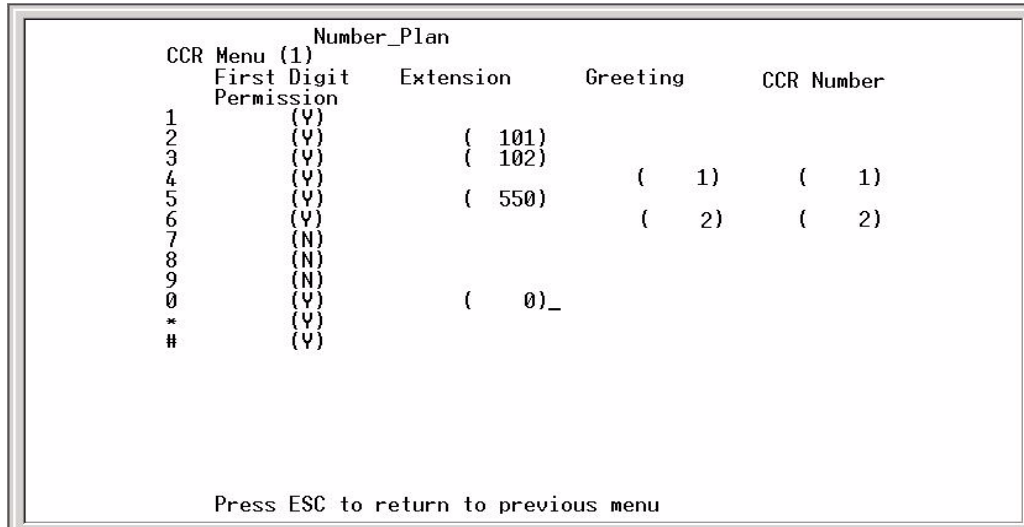

**Figure C-4: Number Plan Screen**

| Field                  | Description   |
|------------------------|---|
| FIRST DIGIT PERMISSION | <p>This field tells the system whether a given digit is allowed to process additional digits.</p> <p>For example:</p> <ul style="list-style-type: none"> <li><input type="checkbox"/> If your extension numbers start with 1, this field will contain a Y and other fields to its right will be blank. When a caller dials a 1, the system knows additional digits will follow and be acted on (Figure C-5).</li> <li><input type="checkbox"/> If this field contains a Y, the system will check the following fields and perform the actions designated in these fields:                             <ul style="list-style-type: none"> <li>EXTENSION -- dials the extension number specified and connects the caller.</li> <li>GREETING -- plays the specified greeting to the caller.</li> <li>CCR -- takes the caller to the specified one of five possible preprogrammed routing menus and plays the greeting for that menu.</li> </ul> </li> <li><input type="checkbox"/> If the field contains an N, the system will tell the caller that they have dialed an incorrect digit and they will be allowed to dial again.</li> </ul> |
| EXTENSION              | <p>This field may contain any valid extension number as the destination. For example, for Sales press [2]. Extension 101 is dialed, and the caller is connected to Sales (Figure C-5).</p>  |
| GREETING               | <p>This field contains the greeting number to be played when this digit is dialed. Active greeting numbers are 01-09 and they are recorded via telephone programming. An entry in the Greeting field requires an associated entry in the CCR Number field, even if the CCR Number is the same as the CCR Menu from which you are configuring</p>  |
| CCR                    | <p>Custom Call Routing (CCR). This field may contain a CCR menu number of 1-5 that links a to an additional number plan when the caller presses the digit in the left column. Up to five number plans can be used (Fig. C-6). CCR numbers can also be tiered, as described by the second example below. To access CCR menus for configuration, press F1 to increment ascending from CCR 1-5 or press F2 to increment descending from CCR 5-1.</p> <p>For example:</p> <ul style="list-style-type: none"> <li><input type="checkbox"/> A CCR Menu 1 entry of 2 in the CCR field could link to a number plan for Sales, 3 for Services, 4 for Tech Support, and 5 for Repairs. Figure C-7 graphically portrays this example.</li> <li><input type="checkbox"/> A CCR Menu 1 entry of 2 in the CCR field will link to CCR Menu 2 number plan (Sales). Sales can be subdivided into In-State and Out-of-State sales making two entries (3 &amp; 4) in the CCR field of CCR Menu 2. Figure C-8 graphically portrays this example.</li> </ul>   |

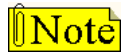

When you program a digit that will route to another CCR box, you **MUST** enter a greeting number that will be played when the caller is sent to the CCR box.



Dual-action keys have a 3-second pause prior to switching to another CCR. For example, you are prompted to dial an extension (100 series) or press 1 for Sales. After pressing [1], the system pauses until either additional digits are entered for an extension or 3 seconds elapse, whichever occurs first.

The example in [Figure C-5](#) shows that when the number 1 and additional digits of an extension are dialed, the call will be transferred to that extension. For example, if 108 is dialed, the call will transfer to extension 108. If the numbers 2, 3, or 5 are dialed, the caller will go directly to the corresponding extension or UCD/ACD group (101, 102, or 550). If number 4 is dialed, greeting 1 will be played to the caller. If number 6 is dialed, the caller will be linked to the CCR Menu 2 number plan. The system administrator has designated numbers 7, 8, and 9 as invalid numbers in this example.

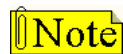

When the Dial-By-Name feature is enabled, the first dialed digit of 4 is dedicated exclusively to the Dial-By-Name function. To enable the Dial-By-Name feature, set a value of "Y" in the First Digit Permission field that is associated with the first dialed digit of 4; also the fields for Extension, Greeting, and CCR Number must be left blank.

| CCR | Menu (1)<br>First Digit<br>Permission | Extension | Greeting | CCR Number |
|-----|---------------------------------------|-----------|----------|------------|
| 1   | (Y)                                   |           |          |            |
| 2   | (Y)                                   | ( 101)    |          |            |
| 3   | (Y)                                   | ( 102)    |          |            |
| 4   | (Y)                                   |           | ( 1)     | ( 1)       |
| 5   | (Y)                                   | ( 550)    |          |            |
| 6   | (Y)                                   |           | ( 2)     | ( 2)       |
| 7   | (N)                                   |           |          |            |
| 8   | (N)                                   |           |          |            |
| 9   | (N)                                   |           |          |            |
| 0   | (Y)                                   | ( 0)_     |          |            |
| *   | (Y)                                   |           |          |            |
| #   | (Y)                                   |           |          |            |

Press ESC to return to previous menu

**Figure C-5: Number Plan Example**



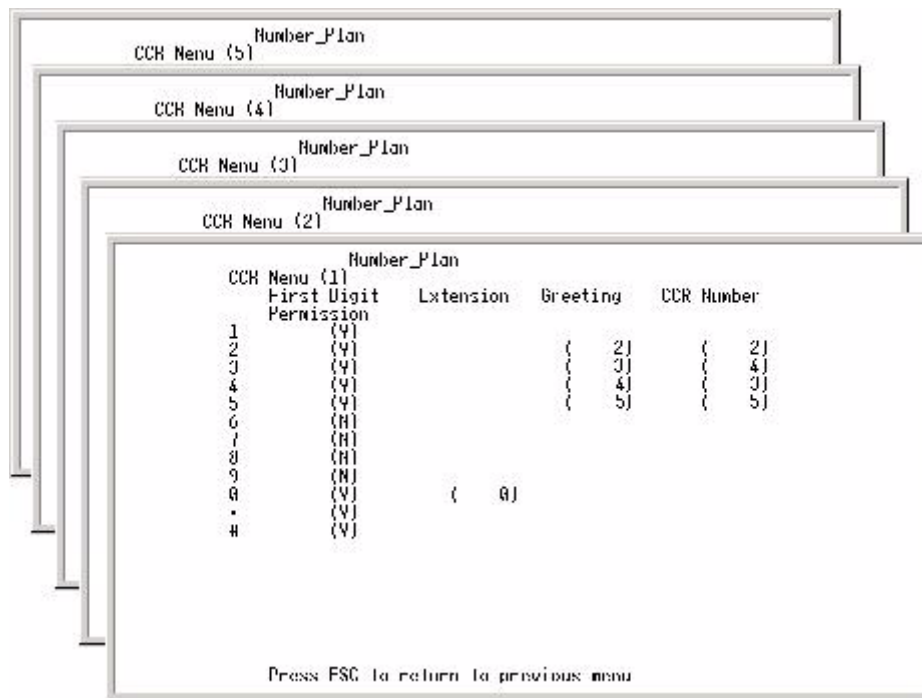

Figure C-6: Five Possible Number Plans

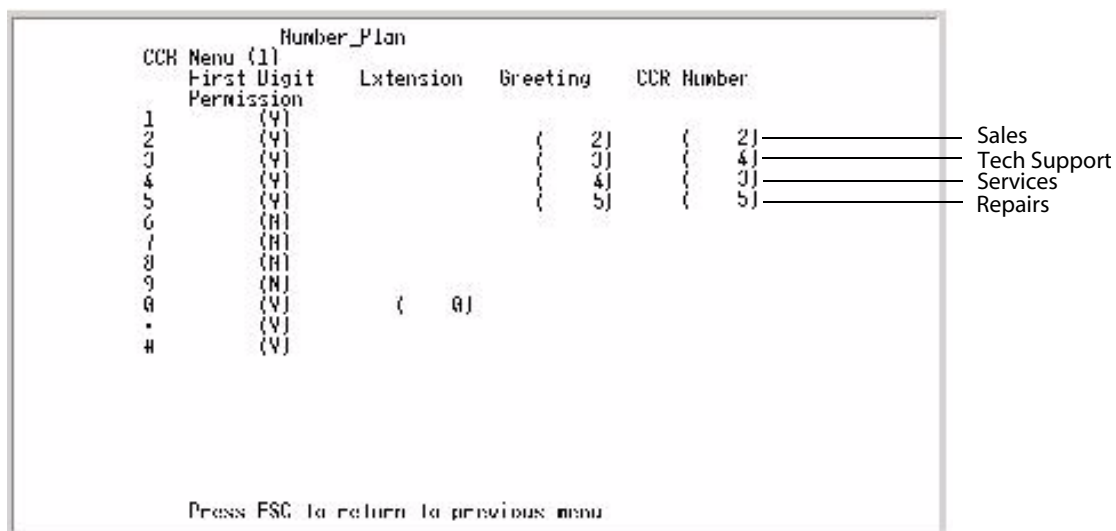

Figure C-7: CCR Menus Example

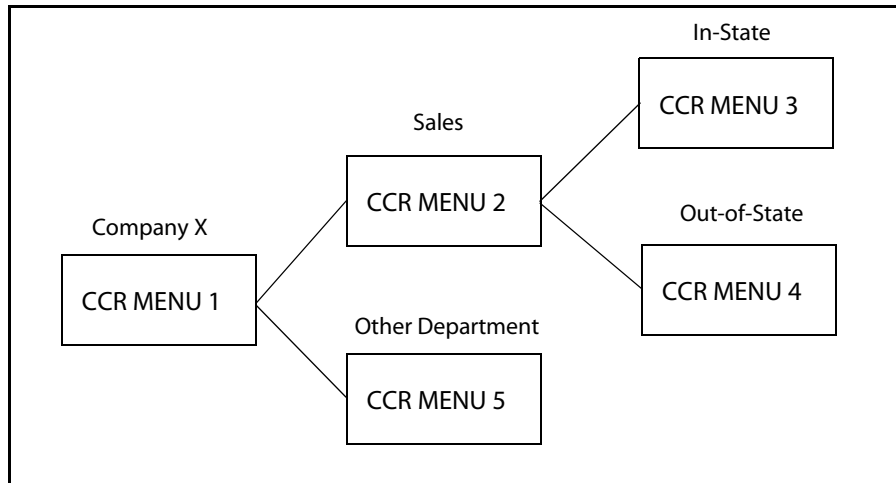

Figure C-8: CCR Menu Tiering Example

**Invalid Digits**

This screen is used to instruct the *Flash-based Voice Mail* to ignore certain digits that may be dialed. When these digits are encountered, they are ignored.

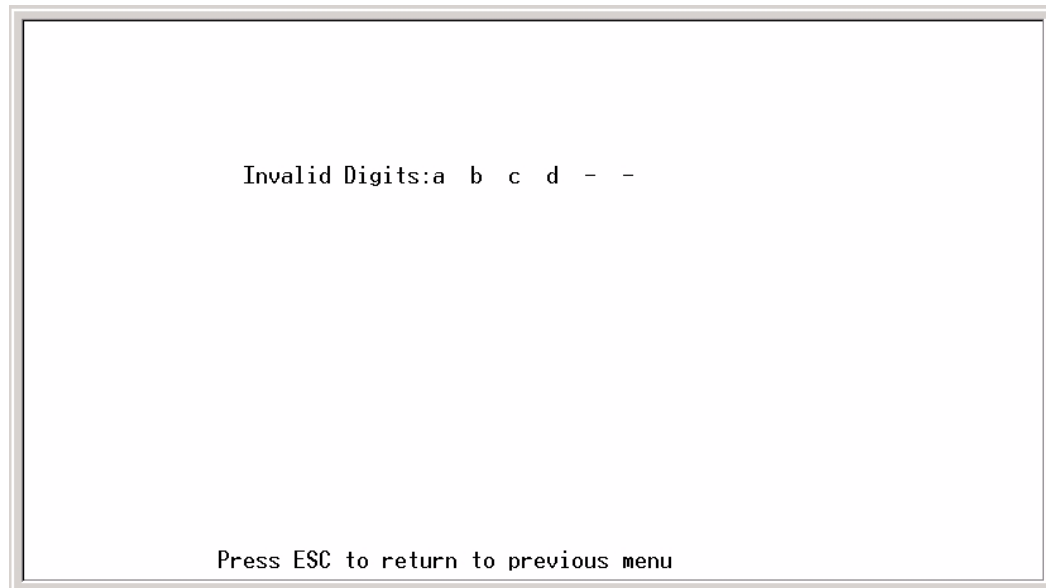
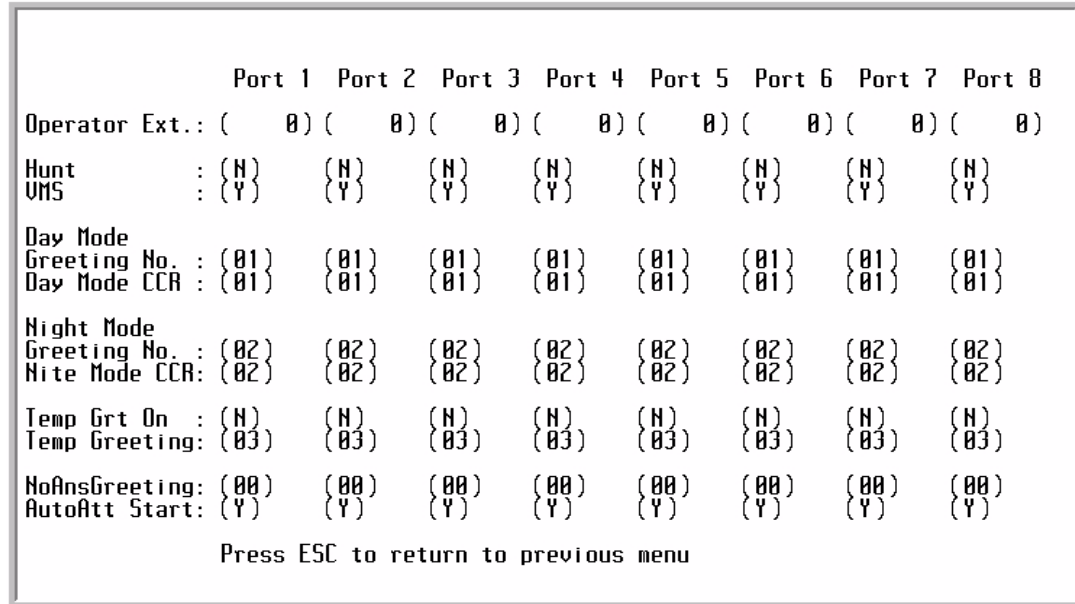

Figure C-9: Invalid Digits Screen

**Auto Attendant Configuration**

This “Voice Lines” screen is used to control what a caller will hear when a given port answers. Each port may play a different greeting.



**Figure C-10: Auto Attendant Screen**

Each column in [Figure C-10](#) represents a given port from 1- 8. Each field is explained below.

| Field             | Description   |
|-------------------|---|
| OPRERATOR EXT     | This is the extension number of the Operator’s extension for this port. When a caller dials [0], this is the destination extension. |
| HUNT              | <i>Future option - not currently active</i>   |
| VMS               | <i>Future option - not currently active</i>   |
| <b>DAY MODE</b>   |   |
| GREETING NO.      | The greeting number (01-09) that plays when this port is accessed during the day hours, as defined in the Open & Close Schedule.    |
| DAY MODE CCR      | The number (01-05) identifying the CCR menu that answers during the day hours, as defined in the Open & Close Schedule.             |
| <b>NIGHT MODE</b> |   |
| GREETING NO.      | The greeting number (01-09) that plays when this port is accessed during the night hours, as defined in the Open & Close Schedule.  |
| NITE MODE CCR     | The number (01-05) identifying the CCR menu that answers during the night hours, as defined in the Open & Close Schedule.           |

*Flash-Based Voice Mail*

| Field          | Description   |
|----------------|---|
| TEMP GRT ON    | <input type="checkbox"/> If this field is set to Y, the programmed TEMP GREETING message will be played to a caller.<br><input type="checkbox"/> If this field is set to N, the programmed GREETING NO. message will be played.<br>This message may be changed from any telephone - internal or external.   |
| TEMP GREETING  | If Temp Greeting is active (Y), this is the greeting that plays when this port answers.   |
| NOANS GREETING | <i>Future option - not currently active</i>   |
| AUTOATT START  | <input type="checkbox"/> If this option is set to Y, the system goes off-hook on an incoming call and waits for integration digits.<br><b>NOTE -- This is the default setting and it should not be changed unless necessary.</b><br><input type="checkbox"/> If this option is set to N, the system goes off-hook on an incoming call and immediately plays the programmed greeting according to the Open & Close Schedule, but does not respond to DTMF tones. |

**System Clock Adjustments**

This screen is used to adjust the Real Time Clock settings of the *Flash-based Voice Mail*. Use the arrow keys to navigate left and right, then make the desired changes.

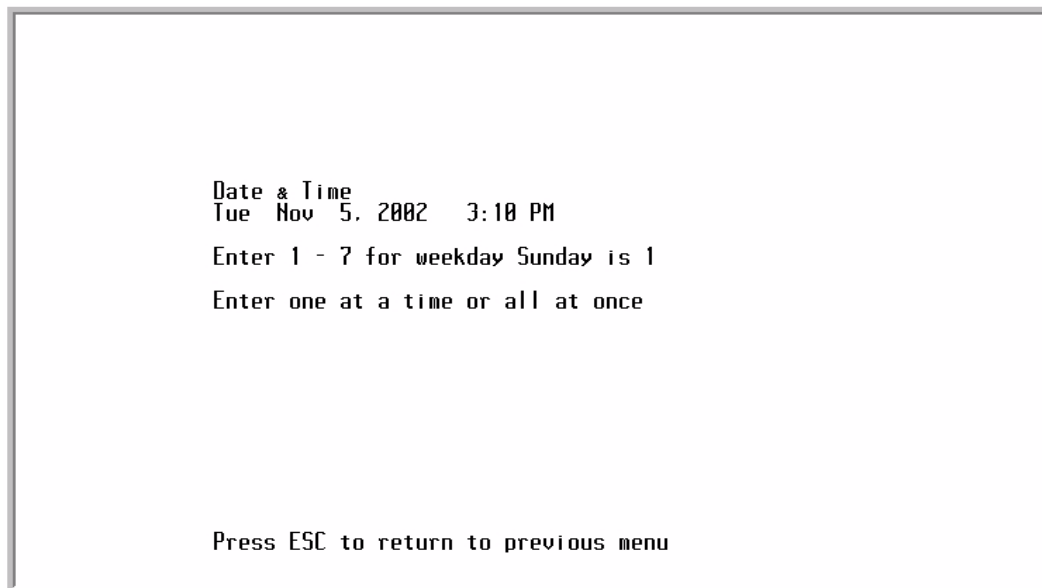
**Figure C-11: Date & Time Screen**

To enter a new date and time:

1. Enter a value of 1-7 to identify the day of the week.
 

|               |              |
|---------------|--------------|
| 1 = Sunday    | 5 = Thursday |
| 2 = Monday    | 6 = Friday   |
| 3 = Tuesday   | 7 = Saturday |
| 4 = Wednesday |              |
2. Press the right arrow key or press the <ENTER> key.
3. Enter a value of 1-12 to indicate the month.
4. Press the right arrow key or press the <ENTER> key.
5. Enter a four-digit value to indicate the year.
6. Press the right arrow key or press the <ENTER> key.

7. Enter a value of 1-24 to set the hour field.  
Use military 24-hour format to set the Time.
8. Press the right arrow key or press the <ENTER> key.
9. Enter a value of 0-59 to set the minutes field.  
*Example -- To set the time to 6 p.m., enter 18:00. The voice mail system will automatically convert the military time to standard time notation when the changes are saved.*  
Any or all settings may be changed at the same time.
10. When you finish making changes, press the <ENTER> key to save the new settings.



You can press the <Enter> key after each value entered. A shortcut is to enter a string of values separated by a <space> between each value, then pressing <Enter>. For example: an entry of 2 <space> 9 <space> 17 <space> 2004 <space> 18 <space> 30 <Enter>, will represent Monday, September 17, 2004, 6:30 p.m.

### **Version Number**

This choice will display the current Software Version and Prompts Version numbers. This information is useful when speaking with technical support personnel.

### **Set System Password**

This screen is used to change the system password. If you wish to change the voice mail system password from the default value of 0000, enter the new password here. (The password MUST be four digits.)

The new password takes effect next time you access programming menus.

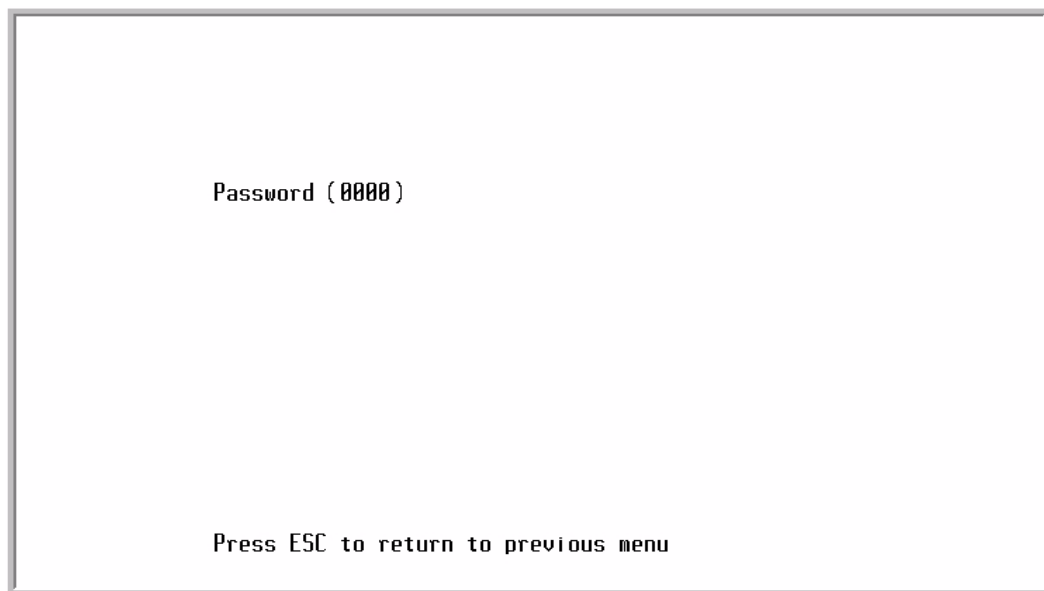

**Figure C-12: Password Screen**

### Mailbox Assignment

This screen controls mailbox user options. Each mailbox may be assigned any of the four available Classes of Service, and be allowed or denied the ability to make outcalls to a beeper. A description of the fields on the mailbox assignment screen are provided below.

| Mailbox No | Access Ext Code | Ext_No | Class of Service | Dial Out | Beeper No | Msg_Ind | Name & Name_Mode Last | Direct Xfr |
|------------|-----------------|--------|------------------|----------|-----------|---------|-----------------------|------------|
| 1          | 100             | 0000   | 100              | 1        | Off       | 0       |                       | Off        |
| 2          | 101             | 0000   | 101              | 1        | Off       | 0       |                       | Off        |
| 3          | 102             | 0000   | 102              | 1        | Off       | 0       |                       | Off        |
| 4          | 103             | 1234   | 103              | 1        | Off       | 1       |                       | Off        |
| 5          | 104             | 0000   | 104              | 1        | Off       | 0       |                       | Off        |
| 6          | 105             | 0000   | 105              | 1        | Off       | 0       |                       | Off        |
| 7          | 106             | 0000   | 106              | 1        | Off       | 0       |                       | Off        |
| 8          | 107             | 0000   | 107              | 1        | Off       | 0       |                       | Off        |
| 9          | 108             | 0000   | 108              | 1        | Off       | 0       |                       | Off        |
| 10         | 109             | 0000   | 109              | 1        | Off       | 0       |                       | Off        |
| 11         | 110             | 0000   | 110              | 1        | Off       | 0       |                       | Off        |
| 12         | 111             | 0000   | 111              | 1        | Off       | 0       |                       | Off        |
| 13         | 112             | 0000   | 112              | 1        | Off       | 0       |                       | Off        |
| 14         | 113             | 0000   | 113              | 1        | Off       | 0       |                       | Off        |
| 15         | 114             | 0000   | 114              | 1        | Off       | 0       |                       | Off        |
| 16         | 115             | 0000   | 115              | 1        | Off       | 0       |                       | Off        |
| 17         | 116             | 0000   | 116              | 1        | Off       | 0       |                       | Off        |
| 18         | 117             | 0000   | 117              | 1        | Off       | 0       |                       | Off        |
| 19         | 118             | 0000   | 118              | 1        | Off       | 0       |                       | Off        |
| 20         | 119             | 0000   | 119              | 1        | Off       | 0       |                       | Off        |
| 21         | 120             | 0000   | 120              | 1        | Off       | 0       |                       | Off        |

Press ESC to return to previous menu

Figure C-13: Mailbox Assignment Screen

| Field                    | Description  |
|--------------------------|--|
| MAILBOX<br>- NO<br>- EXT | This heading contain two fields:<br><input type="checkbox"/> Mailbox index number. This is generated automatically by the system.<br><input type="checkbox"/> Mailbox number that relates to the physical extension number. Example, 100-148.  |
| ACCESS CODE              | Password designated by the mailbox owner for accessing the mailbox.<br>(The default password is 0000. It is changeable from 0000-9999.)  |
| EXT_NO                   | Number of the physical extension for this mailbox.<br><input type="checkbox"/> This is the station that will be the destination of callers when transferred by the voice mail system.<br><input type="checkbox"/> It is also the number used when activating or deactivating MWI indicators. |
| CLASS OF SERVICE         | Number of the assigned Class of Service as programmed in Class of Service screen.  |
| DIAL OUT                 | Controls whether a given mailbox is allowed to make outcalls to a beeper/pager   |
| BEEPER NO                | Allows beeper outcalls.<br><input type="checkbox"/> Only enter the beeper/pager telephone number.<br><input type="checkbox"/> The system will verify the outdial access code entered on the PBX Integration Screen.  |
| MSG_IND                  | Shows the current status of the telephone MWI indicator according to the system.<br><input type="checkbox"/> 0 = OFF<br><input type="checkbox"/> 1 = ON  |

| Field            | Description   |
|------------------|---|
| NAME & NAME_MODE | <p>These two fields control whether the Dial-By-Name directory function uses the first or last name of the mailbox user.</p> <p>The <b>NAME</b> field allows up to 17 characters. Type the first name and the last name. Use a space between the first and last names. Capitalize the first letter of the first and last names.</p> <p>The <b>NAME_MODE</b> field tells the <i>Flash-based Voice Mail</i> whether to search using the Last or the First name. To change this value from Last to First, press the Enter key until you are in the Name field. Press the Up arrow and the cursor will highlight the "L" in Last. Type "F" and press the Enter key. The value will change to First.</p> |
| DIRECT XFR       | <p>This field indicates whether a mailbox user has set their mailbox to transfer callers directly to their mailbox or to be transferred to the programmed extension number. This is an indicator field and cannot be changed manually from the terminal.</p> <p><b>Off</b> - the caller is transferred to the extension</p> <p><b>On</b> - the caller is transferred to the mailbox to leave a message</p>  |

**Adding a Mailbox**

**Note** When the integration type is changed on screen 12, the *Flash-based Voice Mail* will automatically insert the correct mailboxes into this screen as a default condition. When there are more mailboxes than appear on the screen, press [F1] to go forward one screen and [F2] to go back one screen.

From the Main Menu:

1. Press <9> to enter Mailbox Assignments.
2. Move the cursor to the first available line, at a position left of the index number field. Press [F1] to go to the next page, if necessary.
3. Enter in order:
  - a. Next index number, then space.
  - b. Mailbox extension number, then space.

**Note** A system can use 2-digit, 3-digit, or 4-digit mailbox numbers. However, a system cannot number mailboxes using a combination of 2, 3, and 4-digit lengths. For example, if 2-digit numbering is used, then all mailboxes must be numbered with 2 digits.

- c. Access code if available, otherwise 0000 (valid codes are 0000-9999).
  - d. Press <ENTER>. To continue adding mailboxes, return to step 3a.
4. After you finish adding mailboxes, press <ESC> to save your changes and return to the Programming Menu.

An example of a valid entry is: [32] + space + [100] + space + [0000] + <ENTER> + <ESC>

**Note** When adding a mailbox, the Class of Service field automatically updates to a default value of 1 and the Dial Beeper No Out field automatically updates to Off. After the mailbox is established, these fields and the beeper/pager No can be modified as desired. If an invalid beeper/pager number is entered, a user cannot activate this type of notification remotely.

*Flash-Based Voice Mail***Deleting a Mailbox**

From the Programming Menu:

1. Press <9> to enter Mailbox Assignments.
2. Move the cursor bar down to the mailbox that is to be deleted.
3. Press <F4> to delete the mailbox.
4. Press <Y> to confirm delete.
5. When you finish, press <ESC> to save your changes and return to the Programming Menu.

**Class of Service**

The *Flash-based Voice Mail* provides four Classes of Service. Each COS has three parameters that may be specified:

| Class of Service |                     |                          |                    |
|------------------|---------------------|--------------------------|--------------------|
| Service Class    | Save Period in days | Length of Msg in minutes | Number of Messages |
| 1                | 10                  | 2                        | 15                 |
| 2                | 20                  | 5                        | 15                 |
| 3                | 30                  | 5                        | 15                 |
| 4                | 30                  | 5                        | 30                 |

Press ESC to return to previous menu

**Figure C-14: Class of Service Screen**

| Field                    | Description   |
|--------------------------|---|
| SAVE PERIOD IN DAYS      | Specifies the number of days that a message is retained before being automatically deleted. No warning is given before the message is deleted.<br><br>It is important to delete messages so that the storage space is not completely consumed.                                  |
| LENGTH OF MSG IN MINUTES | Controls the allowable recorded length of a message that may be left in a user's mailbox.   |
| NUMBER OF MESSAGES       | Controls the total number of messages that a given mailbox user may have in their mailbox at any one time. The mailbox will indicate that it is full, once this count is matched. For example, if set to 5, the 6th caller receives a message "I'm sorry, the mailbox is full". |



**Recording Time Left**

This screen is used to display the amount of voice storage space that is currently available in the *Flash-based Voice Mail*. The Memory Expansion Module increases the storage space by 360 minutes.

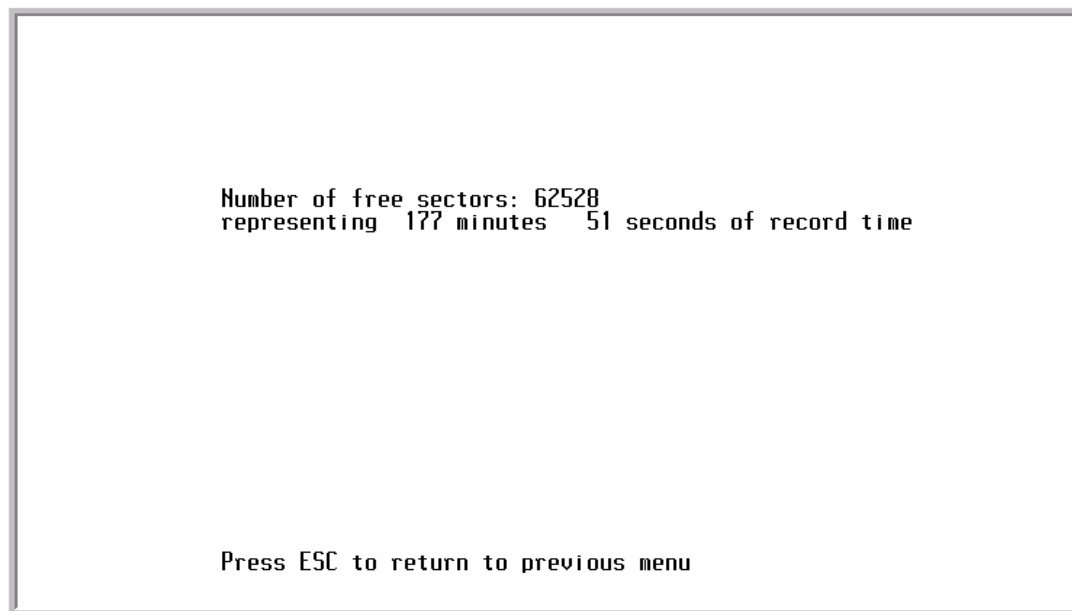
**Figure C-15: Free Sectors Screen****PBX Integration**

The *Flash-based Voice Mail* provides several preprogrammed integration modules as shown in [Figure C-16](#).

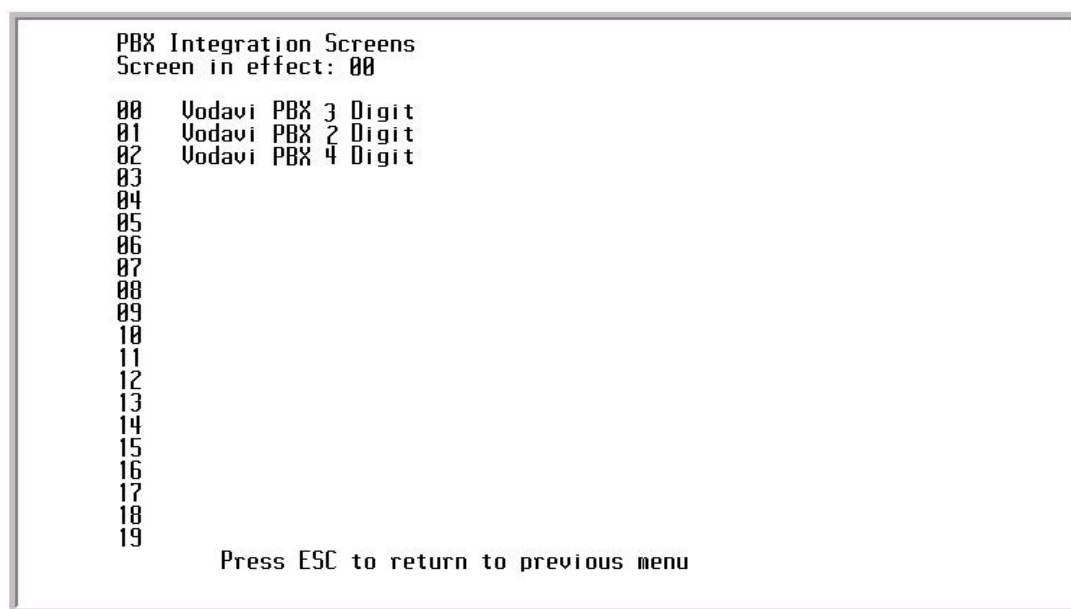
**Figure C-16: PBX Integration Screen (1 of 2)**

**Selecting an STSe Numbering Plan** -- Use the arrow keys to scroll to the desired number corresponding to the desired numbering plan, then press the <ENTER> key. Your selection is displayed in the *Screen in Effect* field.

For example, if you scroll to 00 for Vodavi STSe 3 Digit numbering plan and press <ENTER>, the *Screen In Effect* field displays 00.

**Changing a Parameter --**

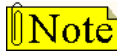

*It is only necessary to select the specific STSe numbering plan as shown in Figure C-16. Parameters for the selected STSe numbering plan (shown in Figure C-17) do not need to be modified unless under the direction of Technical Support personnel.*

In cases where you need to change a parameter used by the PBX integration screen, perform the following steps:

1. Use the arrow keys to scroll to select your PBX integration, then press the <ENTER> key.
2. Press the <ENTER> key a second time to display the next PBX Integration Screen.

**PBX Integration Programming - (Sub Menu)**



*Changing from one PBX integration to another will wipeout all of the existing mailboxes and there is no way to recover them.*

Review description in following table

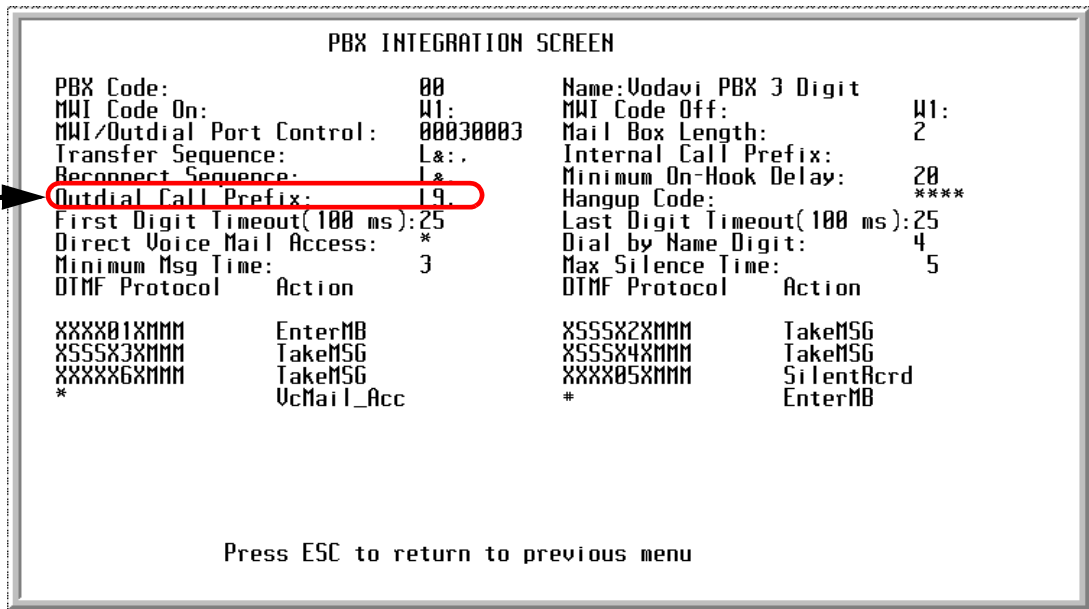

**Figure C-17: PBX Integration Screen (2 of 2)**

| Field    | Description  |
|----------|--|
| PBX CODE | Number the system uses to determine which PBX screen to reference for system parameters.<br><i>Example -- If 01 is selected as the PBX Integration, the system will use the entries located on screen 01 to determine integration patterns, MWI on &amp; off codes, etc.</i> |
| NAME     | Descriptive name used to visually identify the particular Integration Screen. This name is the one displayed in the PBX Integration Selection Menu.  |

| Field                    | Description   |
|--------------------------|---|
| MWI CODE ON              | <p>Code the system sends when a mailbox has a new message.</p> <ul style="list-style-type: none"> <li><input type="checkbox"/> This code tells the telephone system to activate the MWI indicator for that mailbox's extension.</li> <li><input type="checkbox"/> When entering the code, the colon character ":" represents the extension number.<br/><i>Example -- If your MWI On code is W1 followed by the extension number, enter the following sequence: ,W1;</i></li> <li><input type="checkbox"/> It is recommended to always end the sequence with a comma (1-second pause) to allow the telephone system enough time to accept the command.</li> </ul>              |
| MWI CODE OFF             | <p>Code the system sends when a mailbox user has checked all new messages.</p> <ul style="list-style-type: none"> <li><input type="checkbox"/> This code tells the telephone system to deactivate the MWI indicator for that mailbox's extension.</li> <li><input type="checkbox"/> When entering the code, the character ":" represents the extension number.<br/><i>Example -- If your MWI Off code is W1 followed by the extension number, enter the following sequence: ,W1;</i></li> <li><input type="checkbox"/> It is recommended to always end the sequence with a comma (1 second pause) to allow the telephone system enough time to accept the command.</li> </ul> |
| MWI/OUTDIAL PORT CONTROL | <p>Digit position tells the system which ports are allowed to make outdials. The first 4 positions correspond to ports 1 through 4 - from left to right. The last four digit positions correspond to ports 5-8.<br/><i>Default = 00030003.</i> (This tells the system to use port 4 and 8 to make all outdial calls.)</p>   |
| MAILBOX LENGTH           | <p>Tells the system how many digits are required for the mailbox numbers used in the system. The default is 3 digits. The setting is changeable between 2-4 digits.</p>   |
| TRANSFER SEQUENCE        | <p>Dialing pattern the system uses to transfer a caller from the Auto Attendant to a mailbox user's telephone. (<i>Default = L&amp;</i>)</p>  |
| INTERNAL CALL PREFIX     | <p>System dials prefix to access internal dial tone. (This field is normally blank since most telephone systems supply dial tone when the port is taken off-hook to dial.)</p>  |
| RECONNECT SEQUENCE       | <p>Dialing pattern the system will use to reconnect to a caller when there is no answer at the called telephone extension. (<i>Default = L&amp;</i>)</p>  |
| MINIMUM ON-HOOK DELAY    | <p>Period of time that a port will wait after hanging up before attempting to use that port for an outdial operation.</p> <ul style="list-style-type: none"> <li><input type="checkbox"/> This prevents collisions when a new call appears at the port right after it has released a previous caller.</li> <li><input type="checkbox"/> If no new incoming call is detected before this timer expires, the outdial request will be processed.</li> </ul>  |
| OUTDIAL CALL PREFIX      | <p>Dialing pattern used to tell the PBX an outside line is needed, such as during an outdial operation.</p> <p><i>Default = L9.</i> If your trunk access code is different, change this value as required. If your system shows "L9,T", delete the "L9,T" and reenter "L9."</p>   |
| HANG-UP CODE             | <p>Most PBX systems are either programmed or automatically send a disconnect code.</p> <ul style="list-style-type: none"> <li><input type="checkbox"/> When the PBX port is about to close (EX: an outside caller has hung up) a digit string is sent to the voice mail system.</li> <li><input type="checkbox"/> If this string matches the entry in this field, the system saves any messages being recorded and then the port closes and waits for the next call.</li> </ul>   |
| FIRST DIGIT TIMEOUT      | <p>When receiving an incoming call:</p> <ul style="list-style-type: none"> <li><input type="checkbox"/> This is the time that the system waits to see if DTMF integration strings are being sent to the system.</li> <li><input type="checkbox"/> If no digits are received during this period, the system will then play the main greeting for that port and be ready to accept caller-dialed digits. (<i>Default value = 20, which represents 2000 ms or 2 seconds</i>)</li> </ul>  |

## Flash-Based Voice Mail

| Field  | Description   |
|--|---|
| LAST DIGIT TIMEOUT   | When the system receives DTMF integration strings: <ul style="list-style-type: none"> <li><input type="checkbox"/> This is the period of time to wait after each digit to determine if more digits are coming.</li> <li><input type="checkbox"/> As each digit is received, this timer is re-started.</li> <li><input type="checkbox"/> Once this timer expires, the system assumes that all DTMF integration digits have been received.</li> <li><input type="checkbox"/> The received string is then analyzed to determine how the call must be processed.</li> </ul>   |
| DIRECT VOICE MAIL ACCESS   | This is the digit that allows a caller to bypass the recorded greetings and go directly to a mailbox user's greeting.   |
| DIAL BY NAME DIGIT   | This is the digit that, when pressed, will activate the Dial-By-Name directory search function.   |
| MINIMUM MSG TIME   | The message must be at least this amount of time before the VM considers the message to be a valid message. If the message is shorter than this time, the message is not recorded.  |
| MAX SILENCE TIME   | The VM will wait for this amount of time if no verbal input continues after the message is begun. After this amount of silent time, the VM ends the recording.  |
| PROTOCOL AREA (DTMF / ACTION)  | Area has two fields. Values are matched pairs: a DTMF Protocol and an Action to take if that protocol is found. <ul style="list-style-type: none"> <li><input type="checkbox"/> All protocol entries are compared in sequence to the inbound DTMF digits until a match is found.</li> <li><input type="checkbox"/> If no match is found, the call is directed to the main greeting for that port.</li> </ul>  |
| - DTMF PROTOCOL  | The pattern is matched against the incoming DTMF string for all call processing. After the correct pattern has been matched, then the corresponding action is taken <i>e.g.</i> , Protocol pattern MMM represents 3 digits.   |
| - ACTION<br>TAKEMSG<br>ENTERMB<br>VCMail_ACC<br><br>IGNORE<br>FAXEXT | Once a matching DTMF protocol is found, the Action column tells the system what to do with that particular call. The allowable actions are: <ul style="list-style-type: none"> <li><input type="checkbox"/> Take a message into the requested mailbox.</li> <li><input type="checkbox"/> Open the requested mailbox, ask caller for password.</li> <li><input type="checkbox"/> Signal the voice mail that a mailbox number will follow and open the corresponding mailbox to take a message.</li> <li><input type="checkbox"/> Take no action when this DTMF protocol is received.</li> <li><input type="checkbox"/> The voice mail system has built-in Fax Tone recognition. If a call is received on a port and fax tones are heard, the incoming call will be transferred to the programmed Fax Extension, if it exists and has been programmed in this section. To set up a Fax Extension (128 for this example): <ol style="list-style-type: none"> <li>1. Attach a fax machine to the dedicated single-line port 128.</li> <li>2. Type <b>128 &lt;space&gt; F</b> in any vacant field of the DTMF Protocol section.</li> <li>3. Press the &lt;ENTER&gt; key.</li> </ol> The entry will become <b>128 FaxExt</b><br/> Any time fax tones are detected, the call will be transferred to extension 128. </li> </ul> |
| PROTOCOL ENTRY ORDER   | This is the order of integration information as the telephone system sends it to the voice mail port. <p><b>Integration Examples</b></p> <p>Example 1 -- System answers a call and receives a three-digit extension number: <b>104</b> ...<br/> The system receives an entry for MMM. The Action for this protocol is TakeMsg. Once the match is made, the system opens mailbox 104, plays the mailbox greeting to the caller and records the message.</p> <p>Example 2 -- System answers a call and receives a code followed by a 3-digit extension number: <b>[*] 104</b> ...<br/> The system receives an entry for [*]MMM. The Action for this protocol is TakeMsg. Once the match is made, the system opens mailbox 104, plays the mailbox greeting to the caller and records the message.</p> <p>Example 3 -- System answers a call and receives a code followed by a 3-digit extension number: <b>[#] 104</b> ...<br/> The system receives an entry for #MMM. The Action for this protocol is EnterMB. Once the match is made, the system opens mailbox 104, plays the mailbox name to the caller and asks for their password.</p>  |

### System Initialization

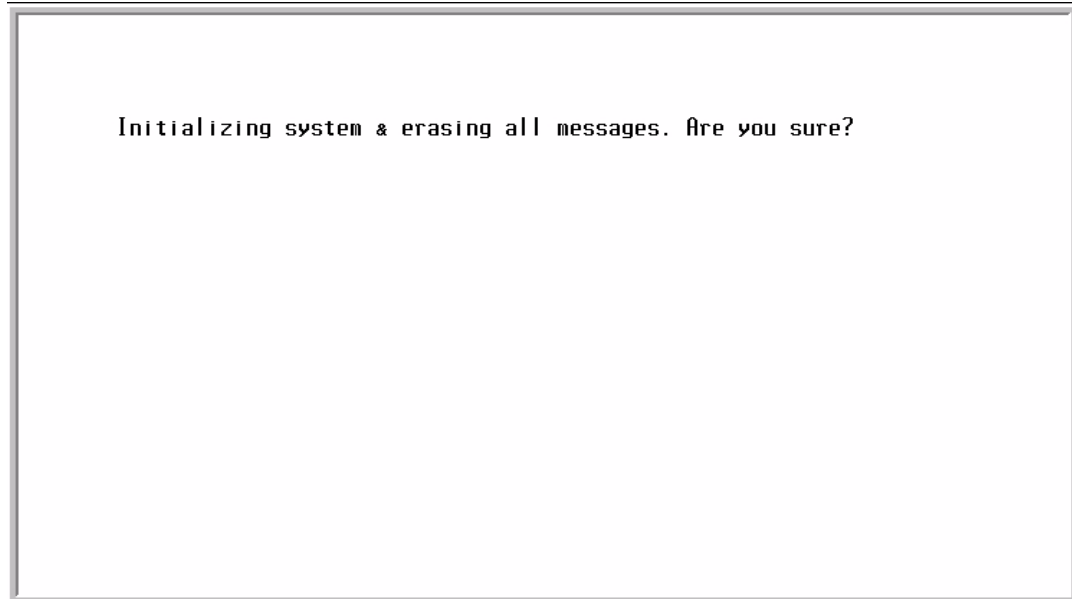

Enter [Y] to initialize the voice mail system and erase all messages. Enter [N] or press [Esc] to exit this option without initializing the voice mail system.



*This action is permanent and non-reversible once activated by entering [Y].  
Once initialized, you MUST select a new PBX integration (refer to "PBX Integration"  
on page C-31).*

### Messages Waiting Display

This screen displays how many new messages are waiting in the voice mail system and the mailboxes that own them.

- If a line has multiple mailbox numbers, this indicates that the message has been copied to other mailboxes.
- As mailbox owners listen to their messages and delete them, their numbers will be removed from the screen.

| Msg No | Mailboxes |
|--------|-----------|
| 0      | 103       |
| 2      | 101       |
| 3      | 103       |
| 14     |           |

Press ESC to return to previous menu

**Figure C-18: Messages Waiting Screen*****Debug Information Screen***

This screen shows various trouble-shooting information fields. They will usually be used in conjunction with a Vodavi technician when trying to identify a problem that may be occurring.

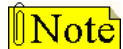

*This screen is accessible only when the Dealer Password is used to enter System Programming. Contact Technical Support for details.*

### **Programming Flashprom**

This screen is used to upload new software versions for the *Flash-based Voice Mail*. To access this area of programming, you must type the number 18 while on the Programming Menu screen. You cannot access option 18 with the arrow keys. Option number 18 is a valid option, even though it is not listed on the menu. Use the following steps to complete the upload process:

1. After typing 18, press <ENTER>. A screen will appear with the prompt "Programming Flashprom. Are you sure?"
2. Type "y", then press <ENTER>.
3. Using the pulldown menu, select Transfer>Send\_Text File.
4. Browse to the location of the upload file. The upload file is identified as V70cxx (where xx reflects the version number). The upload file is normally obtained via the Vodavi website or via Vodavi-provided 3.5 inch floppy disk.



Ensure that you select the "All Files (\*.\*)" option in the Files of Type field, so that the upload file is accessible.

5. After you select the upload file, either double-click on it or click on "Open". The HyperTerminal screen will reflect "Recording Flashprom Addr:" and numbers will appear following this label. The numbers will increment during the upgrade process. When the upgrade is complete, a second line will appear under the "Recording Flashprom Addr:" label.
6. Type "y", click on <ENTER>, then wait for the number on the second line to change momentarily.
7. After the number changes, cycle power of either the KSU or the *Flash-based Voice Mail* card off then on.
8. Select or type option 7 from the Programming Menu screen, then press <ENTER>.
9. Confirm that the software version has updated.

## Voice Prompts

The following table provides a listing of the default voice prompts that the system contains.

**Table C-3: Voice Prompts (Defaults)**

| <b>Number</b> | <b>Prompt</b>   |
|---------------|---|
| 001           | Hello, please enter the extension number of the person you are trying to reach. To reach an Operator, press 0.  |
| 002           | Enter your mailbox number   |
| 003           | I am sorry, there is no such mailbox number   |
| 004           | Enter your password   |
| 005           | Invalid password  |
| 006           | Mailbox menu...To review your messages, press 1; Send a message, press 2; Mailbox options, press 3.   |
| 007           | You have entered an incorrect digit   |
| 008           | If you are satisfied with this message, press #...; to review, press 1; re-record, press 2; append, press 3; to cancel, press *                                 |
| 009           | To replay the message, press 1...; to save this message, press 2; delete it, press 3; to send a copy, press 4; reply, press 5; for message information, press 8 |
| 010           | To deactivate ...   |
| 011           | Record a message at the tone. When you have finished , press #  |
| 012           | To activate ...   |
| 013           | Mailbox options ... Greetings, press 1; Password, press 2; Outcall notification, press 3; direct transfer, press 4  |
| 014           | Hanging up now ... goodbye  |
| 015           | Message deleted   |
| 016           | To confirm deletion of this message, press #, to cancel, press *  |
| 017           | To copy with comments, press 1, to copy without comments, press 2   |
| 018           | Enter destination number  |
| 019           | The mailbox is not empty  |
| 020           | The system is full  |
| 021           | Enter a new password  |
| 022           | Press 1   |
| 023           | No  |
| 024           | You have...   |
| 025           | new   |
| 026           | and   |
| 027           | saved   |
| 028           | message   |
| 029           | messages  |
| 030           | Zero  |
| 031           | One   |
| 032           | Two   |
| 033           | Three   |
| 034           | Four  |
| 035           | Five  |
| 036           | Six   |
| 037           | Seven   |
| 038           | Eight   |
| 039           | Nine  |
| 040           | Ten   |
| 041           | Eleven  |
| 042           | Twelve  |



Table C-3: Voice Prompts (Defaults)

| Number | Prompt  |
|--------|---|
| 043    | Thirteen  |
| 044    | Fourteen  |
| 045    | Fifteen   |
| 046    | Sixteen   |
| 047    | Seventeen   |
| 048    | Eighteen  |
| 049    | Nineteen  |
| 050    | Twenty  |
| 051    | Thirty  |
| 052    | Forty   |
| 053    | Fifty   |
| 054    | Sixty   |
| 055    | Seventy   |
| 056    | Eighty  |
| 057    | Ninety  |
| 058    | 1999  |
| 059    | Two thousand  |
| 060    | Message from  |
| 061    | Mailbox   |
| 062    | Message sent  |
| 063    | an outside party  |
| 064    | Sunday  |
| 065    | Monday  |
| 066    | Tuesday   |
| 067    | Wednesday   |
| 068    | Thursday  |
| 069    | Friday  |
| 070    | Saturday  |
| 071    | January   |
| 072    | February  |
| 073    | March   |
| 074    | April   |
| 075    | May   |
| 076    | June  |
| 077    | July  |
| 078    | August  |
| 079    | September   |
| 080    | October   |
| 081    | November  |
| 082    | December  |
| 083    | AM  |
| 084    | PM  |
| 085    | Press 1 to change an access code, 2 to add a mailbox, 3 to delete a mailbox, 4 to record a mailbox greeting, 5 to reset MWI |
| 086    | Make your selection now   |
| 087    | Dial system greeting  |

Table C-3: Voice Prompts (Defaults)

| Number | Prompt   |
|--------|--|
| 088    | This message is too short, please record a longer message  |
| 089    | Outcall notification is active   |
| 090    | Outcall notification is deactivated  |
| 091    | If you have a mailbox on this system, press #  |
| 092    | Message delivered  |
| 093    | Message saved  |
| 094    | Message deleted  |
| 095    | To send your message now, press #, to cancel, press *  |
| 096    | * if there are no other recipients or enter next recipient's mailbox number now  |
| 097    | I am sorry you are experiencing difficulties   |
| 098    | First message  |
| 099    | Next message   |
| 100    | First saved message  |
| 101    | You have entered too few digits  |
| 102    | Password   |
| 103    | At the tone, record your message. When you have finished recording, press #  |
| 104    | System prompt review: To listen to one prompt, enter the three digit prompt number twice; To listen to a range of prompts, enter the range's first three digit prompt number followed by the second three digit prompt number; To listen to the prompt that was recorded last press the # key. |
| 105    | Please enter your three-digit number   |
| 106    | Enter the extension number of the party you are calling. To dial by name, press 4.   |
| 107    | - 0.7 seconds of silence - ( <b>NO RECORDING NEEDED HERE</b> )   |
| 108    | That mailbox is full and cannot accept any new messages  |
| 109    | Remaining recording time is sixty seconds  |
| 110    | You have no messages in your mailbox   |
| 111    | Please hold, while I transfer your call  |
| 112    | Press any key to continue  |
| 113    | Greetings...Review, press 1; Record, press 2; Delete, press 3  |
| 114    | To review your name, press 1; mailbox greeting, press 2; temporary greeting, press 3   |
| 115    | To record your name, press 1; mailbox greeting, press 2; temporary greeting, press 3   |
| 116    | To delete your name, press 1; mailbox greeting, press 2; temporary greeting, press 3   |
| 117    | Greeting has not been recorded   |
| 118    | Name has not been recorded   |
| 119    | Temporary greeting has not been recorded   |
| 120    | Greeting was deleted   |
| 121    | Name was deleted   |
| 122    | Temporary greeting was deleted   |
| 123    | There is no free mailbox   |
| 124    | Is located in table entry ...  |
| 125    | Press # to confirm deletion of this mailbox, * to cancel   |
| 126    | Mailbox was deleted  |
| 127    | To select normal greeting press 1, to select temporary greeting press 2, to set greeting number, press 3.  |
| 128    | - Default Voice Menu greeting -  |
| 129    | - Welcome 1 = System Greeting 01   |
| 130    | - Welcome 2 = System Greeting 02   |
| 131    | - Greeting 3 = System Greeting 03  |
| 132    | - Greeting 4 = System Greeting 04  |

**Table C-3: Voice Prompts (Defaults)**

| <b>Number</b> | <b>Prompt</b>   |
|---------------|---|
| 133           | - Greeting 5 = System Greeting 05   |
| 134           | - (Initially empty) = System Greeting 06  |
| 135           | - (Initially empty) = System Greeting 07  |
| 136           | - (Initially empty) = System Greeting 08  |
| 137           | - (Initially empty) = System Greeting 09  |
| 138           | - (Open prompt)   |
| 139           | - (Open prompt)   |
| 140           | - (Open prompt)   |
| 141           | - (Open prompt)   |
| 142           | - (Open prompt)   |
| 143           | - (Open prompt)   |
| 144           | Select port number  |
| 145           | Port number . . .   |
| 146           | . . . Is set to . . .   |
| 147           | Normal greeting   |
| 148           | Temporary greeting  |
| 149           | Administrator options - For System greetings, press 1; Mailbox Administration, press 2; Auto Attendant configuration, press 3; Set date and time, press 4; Set operating mode, press 5; To select PBX integration, press 6; To record a prompt, press 7; To listen to a prompt, press 8; To change Opening and Closing schedule, press 9. |
| 150           | Your request has been processed   |
| 151           | Enter greeting number   |
| 152           | Greeting was recorded   |
| 153           | Greeting was erased   |
| 154           | To review data press 1; to change, press 2; to exit press *   |
| 155           | Enter time in 24-hour format  |
| 156           | Enter date in MMDDYY format   |
| 157           | Mode  |
| 158           | Select mode: for day mode, press 1; for night mode, press 2; for automatic mode, press 3  |
| 159           | Dial integration number   |
| 160           | Integration number  |
| 161           | This mailbox already exists   |
| 162           | You selected an invalid integration number  |
| 163           | The system has reached 80 percent of capacity   |
| 164           | Your mailbox is already in use  |
| 165           | Your outcall number needs to be programmed  |
| 166           | Dial extension number   |
| 167           | Dial class of service number  |
| 168           | The mailbox is now active   |
| 169           | Enter the 3-digit prompt number and record at the tone. Press # when finished   |
| 170           | Enter new value   |
| 171           | For DISA operation press 4  |
| 172           | This feature is not available   |
| 173           | This feature is currently in use, please try again later  |
| 174           | Dial destination number   |
| 175           | End of messages   |
| 176           | Playback is paused. Press 6 to resume playback.   |
| 177           | To review, press 1; To change, 2; To delete 3   |

**Table C-3: Voice Prompts (Defaults)**

| <b>Number</b> | <b>Prompt</b>   |
|---------------|---|
| 178           | The beeper number is  |
| 179           | Insert the beeper number  |
| 180           | Deleted   |
| 181           | The opening time for  |
| 182           | The closing time for  |
| 183           | Time is not set   |
| 184           | Select day of week - 1 for Sunday through 7 for Saturday                                      |
| 185           | Select opening or closing time - 2 for close and 6 for open                                   |
| 186           | Day greeting  |
| 187           | Night greeting  |
| 188           | Greeting  |
| 189           | Is selected for   |
| 190           | All ports   |
| 191           | No ports  |
| 192           | Select day, night, or temporary greeting - 3 for day, 6 for night, or 8 for temporary         |
| 193           | Port  |
| 194           | Select first letter of last name  |
| 195           | For   |
| 196           | Press   |
| 197           | Select first letter of first name   |
| 198           | Transfer options - press 1 to transfer to your extension, press 2 to transfer to your mailbox |
| 199           | Transfer is set to extension  |
| 200           | Transfer is set to mailbox  |
| 201           | To dial beeper number, press 4  |

## Remote Programming & Maintenance Connection

### STSe Site

1. Lift the cover of the STSe unit to access the programming port.
2. Connect a null cable to the RS-232 port #2 (9600 baud by default) on the outside of the KSU cabinet, then plug the other end into the programming port of the *Flash-based Voice Mail* card.



The cable between the Flash-based Voice Mail card and the KSU **must** be a null cable.

3. Enter admin programming, access FLASH 67, Button #6, and set the VM port to enabled (default = disabled).
4. Set the ring assignment for the line chosen for external voice mail to ring 498, which is the VM modem.

### Remote Site

A laptop or standard PC desktop system can be used. No special software is required. Any communications package that supports ANSI terminal emulation will work (e.g., HyperTerminal or ECOM). The required port speed is 9600 BAUD.

If HyperTerminal is the communications package to be used, after opening HyperTerminal and the New Connection screen displays, perform the following steps:

1. Type the desired name for your connection, select the desired icon, then click on OK.
2. When the "Connect To" window displays, type in the area code and telephone number for the line chosen for the external voice mail, change the setting in the "Connect using" box to: COM1 or COM2 (as required by your PC), then click on OK.
3. After the connection is established, type in the Voice Mail Password.

---

## User Operations

This section explains how to operate the *Flash-based Voice Mail* features.

### *How to Use the Voice Mail System*

- The system is programmed to respond when any of the 12 telephone keys are pressed. If no key is pressed in response to a prompt, the system assumes the caller is confused.
- The system repeats the caller's options. If there is still no response, the system automatically transfers an external caller to an attendant, or politely disconnects a user from the call.
- The system counts the number of errors (incorrect key presses) that a caller makes. If the count exceeds a certain number (usually 3) the caller is politely disconnected. The system does this to allow as many callers on the system as possible.

#### **[\*]Key**

Use the [\*] key to perform the following functions:

- Cancel what you are doing.
- Skip personal greetings and introductory prompts. (It gets you directly to the recording tone.)
- Return to the previous menu, while listening to a prompt.
- Disconnect, when at the Main Menu.

#### **[#] Key**

Use the [#] key to perform the following functions:

- Complete a step.
- Send a message.
- Skip a message.
- Denote the end of a variable-length number, such as a password (this keeps the system from having to wait to determine if you are finished entering digits).

### *Getting Started*

#### **Setting Up Your Mailbox**

You need the following information from your system administrator to set up your mailbox: the number to reach the voice mail system, your mailbox number, and your temporary password. After you have this information, follow these steps:

1. Call the voice mail system: \_\_\_\_\_ (for example, dial 440).
2. If you hear the system greeting, press [#], then enter your mailbox number.
3. When asked for your temporary password, enter \_\_\_\_ (for example, 0000).
4. Press [3] for Mailbox Options.
5. Press [2] for Passwords.

6. When prompted, enter your new password. The system will confirm the new number selected and will then take you back to the Personal Options Menu.
7. Press [1] for Greetings.
8. Press [2] to Record.
9. Press [1] to Record your Name and [2] to Record your Mailbox Greeting. Follow the prompts to record both.
10. Press [#] to stop recording.

Your mailbox is now set up and ready to use. You may wish to change your mailbox greeting from time to time. To change your mailbox greeting, refer to "[Changing Your Mailbox Greeting](#)".

### Accessing Your Mailbox

You can access your mailbox by either calling into the voice mail system or by calling directly to your telephone number / personal mailbox.

#### **When Calling to the Voice Mail System:**

1. Call the voice mail system.
2. When you hear the system greeting, press [#] and then enter your mailbox number.
3. Enter your password. The system will then tell you how many new and how many saved messages you have. The main mailbox menu is then played.

#### **When Calling to Your Telephone Number / Personal Mailbox:**

1. Call your telephone number / personal mailbox.
2. When you hear your mailbox greeting, press [\*] + [#] and then enter your mailbox number.
3. Enter your password. The system will then tell you how many new and how many saved messages you have. The main mailbox menu is then played.

### Disconnecting from the System

1. When you finish using the system, press [\*] until the system says, "Hanging up now. Goodbye."
2. If after pressing [1] you attempt to disconnect while there are new messages in your mailbox, the system plays a message, "The mailbox is not empty."  
Press [1] if you wish to listen to the new message. Press [\*] to hang up.

## Message Options

### Review Your Messages

Messages in your mailbox come from either external callers, who leave messages while in the telephone answering mode, or from other internal users. Messages are presented to you in the following order: new messages, skipped messages, and saved messages.

After the last new message has been presented to you, the system searches the mailbox to see if there are any remaining new messages to be reviewed. In particular, if new messages arrive during message review, they are presented in the same order as before but are considered "skipped".

To review the messages in your mailbox:

1. At the main menu, press [1]. The system plays your messages.
2. After each message is reviewed, the system prompts you for an action. The available options are.

|       |                     |  |
|-------|---------------------|--|
| [1]   | Replay              | repeats the entire message.  |
| [2]   | Save                | keeps the message in your mailbox for future reference.  |
| [3+#] | Delete              | allows you to discard the message and confirm deletion.  |
| [4]   | Forward/Copy        | allows you to forward a copy of the message to another user. When you send a copy, you have the option to send the copy with or without introductory comments. |
| [5]   | Reply               | allows you to record a reply to a message sent from another user's mailbox with a single keystroke.  |
| [8]   | Message Information | plays the time and date the message was sent, and where the message originated from.   |
| [*]   | Cancel              | cancels message review.  |
| [#]   | Skip                | skips to next message in the queue.  |

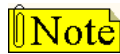

*Any message not completely reviewed and either saved or deleted remains in the new message queue. If you forget to press [\*] to cancel review and just hang up, all partially reviewed and unheard messages will remain in the new message queue.*

### Replay a Message

At the end of a message (when the system prompts with the "After Reviewing" menu) you can replay that message in its entirety.

1. At the Main Menu, press [1] to review the message.
2. When the message ends, press [1] again to replay the message.

### Save a Message

If the message needs to be acted on later, it may be saved. Saved messages are kept in a separate queue. They will be played after new messages.

1. At the Main Menu, press [1] to review the message.
2. Press [2] to save the message.

### Delete a Message

Deleting messages keeps the mailbox clear and reduces the need for system storage capacity. To delete a message:

1. At the Main Menu, press [1] to review the message.
2. Press [3] to delete the message.
3. Press [#] to confirm deletion.



*After a message has been deleted, it **cannot** be restored.*



### **Forward a Copy to Another Mailbox**

You may wish to forward a copy of a message to another user. You can record introductory remarks and send the remarks plus a copy of the message to another user or just send the message. Copies may be sent to one or more users. You may send copies of messages that are received in either voice mail or telephone answering mode. To send a copy of a message:

1. At the Main Menu, press [1] to review the message.
2. Press [4] to forward the message.
3. Select the desired option:  
Send w/ Comments = [1], then record your comments.  
-or-  
Send w/o Comments = [2].
4. Press [#], then enter destination.

### **Reply to a Message**

You can reply to a message sent from another user's mailbox by pressing one key. Therefore, users should enter their own mailbox to record a message before sending, so recipients can conveniently reply.

1. At the Main Menu, press [1] to review the message.
2. Press [5] to reply to the message.
3. Press [#] if the message is acceptable.
4. Press [#] again to send the reply.

### **Message Information**

Details about a message are available: who sent it and the time and date it was delivered. This information is called Message Information. To access message information, press [8] after listening to the message to hear the information that relates to that message.

- The time and date stamp on a new message always relates to message delivery.
- Once a message is saved, the time and date stamp refers to the time it was first saved.
- This time and date stamp allows the user to know how much longer the message can stay in the mailbox before it is automatically deleted.
- Reviewing a message and re-saving it does not change the time and date stamp or when the system automatically deletes the message.

## Options While Reviewing

As you become more experienced, you may want to control the playback of the messages you receive. The system playback controls are designed to give you that flexibility. For example, with playback controls, you can scan through a long message to find a telephone number without reviewing the entire message. After dialing [1] to review a message, you can press:

- [1]       Rewind to the beginning of the message
- [6]       Pause and restart the message
- [7]       Rewind 5 seconds
- [9]       Fast Forward 5 seconds
- [#]       Skip to the next message

## Send a Message

1. At the Main Menu, press [2] to access options to send a message.
2. Press [2] to Record a Message. The system prompts you to begin recording your message.
3. Record the message.
4. Press [#] to end the recording.

The system prompts you to send the message after giving you a chance to:

- [1] listen to the message you have just recorded,
  - [2] re-record the message,
  - or-
  - [3] append to the recording,
  - or-
  - [\*] delete the message and begin again.
5. When the message is acceptable, press [#].
  6. Enter the destination.
    - The destination is the mailbox number of the person who is to receive the message. Messages may be sent individually or in combination with other destinations.
    - Once you enter the mailbox number, the system plays back the name of the person whose mailbox you have selected.
    - If you have selected the wrong mailbox, press the [\*] key and enter a new number.
  7. Press [#] if there are no more destinations, or continue from Step 5.

## Mailbox Greeting Options

### Changing Your Mailbox Greeting

Your mailbox greeting is played to outside callers who enter a system mailbox in the telephone answering mode. This greeting enables you to give callers information about your schedule and to encourage callers to leave detailed messages.

To change your mailbox greeting:

1. At the Main Menu, press [3] to access Mailbox Options.
2. Press [1] to access Mailbox Greeting Options.
3. Press [2] to select the Record option.
4. Press [2] to record a Mailbox Greeting.
5. Record your greeting, then press [#].

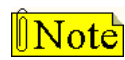

*If a mailbox greeting has not been recorded, the system uses your recorded name.*

### Reviewing Your Mailbox Greeting

You may use Personal Options to review your recorded greeting. To review your mailbox greeting:

1. At the Main Menu, press [3] to access Mailbox Options.
2. Press [1] to access Mailbox Greeting options.
3. Press [1] to select the Review option.
4. Press [2] to review the Mailbox Greeting.

### Deleting Your Mailbox Greeting

The standard system greeting (recorded name) may be selected at any time by deleting your recorded greeting without recording a new one.

To delete your mailbox greeting:

1. At the Main Menu, press [3] to access Mailbox Options.
2. Press [1] to access Mailbox Greeting options.
3. Press [3] to select the Delete option.
4. Press [2] to delete the Mailbox Greeting.

### Recording Your Name

You record your name the first time you use your mailbox. The recording of the name will be used to verify destinations, or as part of a system-generated personal greeting. You may change the way your name is recorded at any time.

To record your name:

1. At the Main Menu, press [3] to access Mailbox Options.
2. Press [1] to access Mailbox Greeting options.
3. Press [2] to select the Record option.
4. Press [1] to record your name.
5. Record your name, then press [#].

### **Reviewing Your Name**

You may use Personal Options to review your recorded name. To review your name:

1. At the Main Menu, press [3] to access Mailbox Options.
2. Press [1] to access Mailbox Greeting options.
3. Press [1] to select the Review option.
4. Press [1] to review the recording of your name.

### **Deleting Your Name**

To delete your name:

1. At the Main Menu, press [3] to access Mailbox Options.
2. Press [1] to access Mailbox Greeting options.
3. Press [3] to select the Delete option.
4. Press [1] to delete the recording of your name.

### **Recording Your Temporary Greeting**

To record a Temporary Greeting:

1. At the Main Menu, press [3] to access Mailbox Options.
2. Press [1] to access Mailbox Greeting options.
3. Press [2] to select the Record option.
4. Press [3] to record a Temporary Greeting.
5. Record the greeting, then press [#]

### **Reviewing Your Temporary Greeting**

To review your temporary greeting:

1. At the Main Menu, press [3] to access Mailbox Options.
2. Press [1] to access Mailbox Greeting options.
3. Press [1] to select the Review option.
4. Press [3] to review the Temporary Greeting.

### **Deleting Your Temporary Greeting**

To delete a temporary greeting:

1. At the Main Menu, press [3] to access Mailbox Options.
2. Press [1] to access Mailbox Greeting options.
3. Press [3] to select the Delete option.
4. Press [3] to delete the Temporary Greeting.

## Passwords

There is one password that is associated with each user mailbox. Each password is 4 numeric digits in length. A zero [0] should not be used as the first digit.

### Changing Your Password

To change your password:

1. At the Main Menu, press [3] to access Mailbox Options.
2. Press [2] for Passwords.
3. Enter the desired password.

## Outcall Notification

You can use the optional outcall notification feature to have the system call your pager and notify you that a new message has been received in your mailbox. Your system administrator will set up your notification schedule and can program your pager number. You can also program your pager number using the procedure, [“Entering An Outcall Number”](#), described below.

### Turning Outcall On/Off

Once the outcall schedules and your pager number have been programmed, outcall notification can be turned on and off whenever desired. Outcall On/Off is a toggle. If outcall notification has been turned on, this procedure will turn it off.

1. From the Main Menu, press [3] to access Mailbox Options.
2. Press [3] for Outcall Notification.
3. Press [1] to activate or deactivate this option.



If an Outcall number is not already entered (refer to [“Entering An Outcall Number”](#) on page C-51), Outcall Notification cannot be activated.

### Entering An Outcall Number

You must enter a telephone number so that the system will be able to automatically inform you of new messages via the Outcall Notification feature.

1. From the Main Menu, press [3] to access Mailbox Options.
2. Press [3] for Outcall Notification.
3. Press [4] to select the Outcall Number option.
4. Enter the Outcall telephone number - up to 18 digits ([\*] = pause).
5. Either press [1] to review, [2] to change, or [3] to delete the Outcall telephone number.

## Direct Transfer

You can program the voice mail system so that incoming calls either initially ring at your extension prior to transferring to your voice mailbox or ring directly to your voice mailbox.

1. From the Main Menu, press [3] to access Mailbox Options.
2. Press [4] for Direct Transfer.
3. Press [1] to select the Extension option or press [2] to select the Mailbox option.

*Flash-Based Voice Mail*

---

---

# D Hard Drive-Based Voice Mail

The *STSe* Key Telephone System can easily be converted to a voice processing system by simply installing a Vodavi Voice Mail Interface Board, and the PC/Laptop Administration program, also known as: *In-Skins Admin*.

Together, they will allow a System Administrator to set up voice mail parameters using a computer, or a touch-tone telephone in a local or remote setting.

This appendix describes the features, administration, and user operation of the Vodavi *STSe Hard Drive-based Voice Mail* module.





---

## Introduction

The *STSe Hard Drive-based Voice Mail* makes a voice mail system an affordable option for any small business. It plugs right into the phone system itself, eliminating the need for more expensive external equipment.

### *Basic Features*

The *STSe Hard Drive-based Voice Mail* was designed to enhance business productivity with a wide-array of system features to benefit both system administrators and the users.

### System Capabilities

|                    |  |
|--------------------|--|
| Notification       | Advanced pager, cellphone, and command file notification features  |
| System Access      | Administration access via: serial port, USB port, or ethernet port |
| Wizard Interface   | To assist with initial setup of voice mail system                  |
| Remote Programming | Via external user modem  |
| 8 Ports            | Unlimited mailboxes  |
| KSU Clock Control  | 3 different KSU time periods to answer incoming calls              |
| Message Storage    | Allows 200+ hours of storage time                                  |

### System Modules

|  |  |
|--|--|
| Auto-Attendant<br>( <i>Dial-by-Name</i> )        | Allows callers to reach appropriate person without operator assistance.                        |
| Call Forwarding                                  | Forward calls directly to a mailbox without system administrator help.                         |
| Menu Routing                                     | Route callers more efficiently. <i>Example:</i> for Sales, press 1, for Service, press 2, etc. |
| Time Controls                                    | Allows customized menus to run at specified times.   |
| RAN Announcements<br>( <i>for UCD function</i> ) | Play messages to callers while they are waiting to speak with a person.                        |

### User Options

|  |  |
|--|--|
| Call Screening<br>( <i>Ans Machine Emulation</i> ) | Listen to messages while being recorded (determine whether to pick up the phone to speak with the caller). |
| Message Forwarding                                 | Direct messages to appropriate people quickly and efficiently.   |
| Message Storage                                    | Save messages for future reference.  |
| Message Wait Light                                 | Light indicates new voice mail messages.   |
| Pager Notification                                 | Choose to be notified when system receives new messages.   |
| Remote Access                                      | Check voice mail messages from any touch-tone phone.   |

---

## Programming the Voice Mail System

The following STSe system features must be programmed using a touch tone telephone and a personal computer. This section describe these system programming requirements.

### *Card Slot Programming*

By default, slot 7 of the STSe BKSU is already configured for a Voice Mail Interface Board when it comes from the factory.

- » If this card slot setting has been changed, or you are unsure of its configuration, complete the steps in the next procedure.

#### **Description**

The Card Slot Programming feature provides a means to assign the peripheral cards to alternative peripheral card slots. The Voice Mail Interface Board can only be installed in slot 7 of the BKSU.

#### **Programming Steps**

1. Press **FLASH** and dial **[24]**. The following message displays:

|                                  |
|----------------------------------|
| CABINET 0<br>ENTER BUTTON NUMBER |
|----------------------------------|

2. Press flexible **Button #8** to designate **slot 7**.

|   |
|---|
| CAB 0    SLOT XX            00-18<br>DTIB |
|---|

3. Enter a valid number to identify the type of card plugged into slot 7:  
**[17] = VM1B** (represents Hard Drive-based VMIB).
4. Press HOLD to save the entry. A confirmation tone sounds and the display updates.
5. Press the reset button on the Main Board Unit (MBU).

#### **Conditions**

- » After programming the card slot, a system reset must be performed using **FLASH 80, Button 20**. For more details, refer to ["System Reset" on page 2-298](#).
- » If a caller ID card is used in the system, you must use **FLASH 40, Page C, Button #2** to set the Ring Delay Timer to a setting of 05 (sec). This allows sufficient time for receipt of ICLID information from the telephone company. Refer to ["Ring Delay Timer" on page A-9](#).

## Recorded Announcement Tables

### Description

The *Hard Drive-based Voice Mail* can be used as a RAN Announcer for UCD Groups. A RAN mailbox is provided to play the announcement.

This feature establishes the type, index (port) number and message length for the eight available Recorded Announcements (RAN). There are eight RAN Tables that can be programmed. Table 1 can be the answer port for unanswered incoming calls to a UCD group.

### Programming Steps

If Recorded Announcement (RAN) devices are installed to operate with UCD, these tables must be programmed.

#### **To program a Table for the Hard Drive-based Voice Mail:**

1. Press **FLASH** and dial **[62]**. The following message displays:

|   |
|---|
| ANNOUNCEMENT TABLE 1<br>TYPE #   IDX #####   TIME ### |
|---|

The top left button in the flexible button field is lit for programming UCD RAN Announcement Table #1.

2. To change to another UCD RAN Announcement Table, press **FLASH 62** and a flexible button 2-8 for Tables 2-8 respectively.
3. Dial **[4]** for the Voice Mail function.
4. Dial the desired Voice Mail Group number, using a 4-digit format, e.g., for Voice Mail Group 440, enter 0440.
5. Dial a RAN mailbox number:  
[0] + [801-816] for a three-digit numbering plan,  
-or-  
[8001-8016] for a four-digit numbering plan.
6. Press **HOLD** to save the entry. A confirmation tone sounds and the display updates.

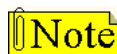

To program a Table for a **Digital Voice Mail**, a **CO Line port**, an **SLT port**, or a **RAN Hunt Group port**, refer to ["Recorded Announcements"](#) on page 4-9.

#### **To clear entries:**

1. Press the **[#]** button.
2. Then press **HOLD**.

*Hard Drive-Based Voice Mail****Programming Devices for Hard Drive-based Voice Mail System***

*Hard Drive-based Voice Mail* programming is accomplished by using a touch-tone telephone and a personal computer. This table shows how to access the various voice mail functions, and also indicates who can modify the parameter settings.

**Table D-1: Hard Drive-Based Voice Mail Functions**

| Function                              | COMPUTER        |                    | TELEPHONE    |               |
|---------------------------------------|-----------------|--------------------|--------------|---------------|
|                                       | PC/Laptop Admin | Diagnostics (ECom) | Keypad Admin | Mailbox Owner |
| <b>GENERAL</b>                        |                 |                    |              |               |
| Shutdown system                       | ●               | ●                  | ●            |               |
| Re-initialize system                  | ●               | ●                  |              |               |
| Set date and time                     | ●               |                    | ●            |               |
| Software version                      | ●               | ●                  |              |               |
| Disable system caching                | ●               |                    |              |               |
| Run Debug module                      | ●               | ●                  |              |               |
| Operator transfer settings            | ●               |                    |              |               |
| Assign function module to voice lines | ●               |                    | ●            |               |
| Command files                         | ●               | ●                  |              |               |
| View logs                             | ●               | ●                  |              |               |
| Set owner send options                | ●               |                    | ●            |               |
| Set owner edit options                | ●               |                    |              |               |
| Administer broadcast messages         |                 |                    | ●            |               |
| Set message cascading                 | ●               |                    |              |               |
| Set call options                      | ●               |                    |              |               |
| Set call screening and waiting        | ●               |                    |              | ●             |
| Set last options                      | ●               |                    |              |               |
| Administer system lists               |                 |                    | ●            |               |
| Set pager / phone number notify       | ●               |                    |              | ●             |
| <b>REGISTRY</b>                       |                 |                    |              |               |
| Reset Registry to default             | ●               | ●                  |              |               |
| Add / Edit Registry items             | ●               | ●                  |              |               |
| <b>EDIT PROMPTS</b>                   |                 |                    |              |               |
| Menu prompts                          |                 |                    | ●            |               |
| System prompts                        |                 |                    | ●            |               |
| Mailbox signature                     |                 |                    | ●            | ●             |
| <b>SUBSCRIBER PROGRAMMING</b>         |                 |                    |              |               |
| Add / Delete / Edit subscribers       | ●               |                    | ●            |               |
| COS                                   | ●               |                    | ●            |               |
| Name (for company directory)          | ●               |                    |              |               |
| Password                              | ●               |                    | ●            | ●             |
| Department                            | ●               |                    |              |               |

**Table D-1: Hard Drive-Based Voice Mail Functions**

| Function                              | COMPUTER        |                    | TELEPHONE    |               |
|---------------------------------------|-----------------|--------------------|--------------|---------------|
|                                       | PC/Laptop Admin | Diagnostics (ECom) | Keyset Admin | Mailbox Owner |
| <b>SUBSCRIBER MAILBOX</b>             |                 |                    |              |               |
| Time control                          | ●               |                    |              |               |
| Operator                              | ●               |                    |              |               |
| Cascade to mailbox                    | ●               |                    |              |               |
| Play greeting action                  | ●               |                    |              |               |
| Action                                | ●               |                    |              | ●<br>≡        |
| Record name                           |                 |                    | ●            | ●<br>≡        |
| Off premise notification              | ●               |                    |              | ●<br>≡        |
| Notification settings                 | ●               |                    |              |               |
| <b>SUBSCRIBER EXTENSION</b>           |                 |                    |              |               |
| Time control                          | ●               |                    |              |               |
| Transfer type                         | ●               |                    |              | ●             |
| Screening and holding                 | ●               |                    |              | ●<br>≡        |
| Administer personal lists             |                 |                    |              | ●             |
| Administer guest mailboxes            |                 |                    |              | ●             |
| Administer personal notepad           |                 |                    |              | ●             |
| Recover deleted messages              |                 |                    | ●            |               |
| Record greetings                      |                 |                    |              | ●             |
| Standard                              |                 |                    |              | ●             |
| Busy                                  |                 |                    |              | ●             |
| Time sensitive                        |                 |                    |              | ●             |
| Temporary                             |                 |                    |              | ●             |
| <b>CLASS OF SERVICE</b>               |                 |                    |              |               |
| Add / Delete / Edit COS               | ●               |                    |              |               |
| <b>MENUS</b>                          |                 |                    |              |               |
| Add / Delete / Edit menus             | ●               |                    |              |               |
| <b>TIME CONTROLS</b>                  |                 |                    |              |               |
| Add / Delete / Edit time controls     | ●               |                    |              |               |
| ● denotes limited programming options |                 |                    |              |               |

**Soft Keys**

Vodavi-branded telephones allow a mailbox owner to modify certain station settings using the soft programming keys. These keys also serve as navigation keys when used in conjunction with the LCD. For more detailed information ... refer to the Station User Guide.

*Main Menu (after entering password)*

|         |          |         |
|---------|----------|---------|
| New:XXX | Save:XXX | Urg:XXX |
| Play    | Send     | P. Opt  |

XXX=CallerID or internal station number

*Listening to a Message*

|              |                    |
|--------------|--------------------|
| XXX-XXX-XXXX | MM:SS-MM:SS        |
| Del          | Save      Callback |

MM:SS-MM:SS=countdown timer & message duration

## Programming System Functions Via Computer

### Before You Begin

#### PC Specifications

Consider the following specifications for the PC that will be connected to the voice mail system and running the *In-Skins Admin* program.

|                      |   |                             |  |
|----------------------|---|-----------------------------|--|
| <b>Memory</b>        | 128 MB RAM (PC133) on board -2.5" form factor   | <b>Monitor</b>              | VGA circuitry (800x600)<br>- with 15-pin connector |
| <b>Drives</b>        | EIDE (ATA100) Hard Drive<br>CD-Rom Drive  | <b>Keyboard &amp; Mouse</b> | PS2 models   |
| <b>PC Connectors</b> | PS2 keyboard connector<br>PS2 mouse connector<br>2 USB connectors<br>RS232 DB9 male connector<br>- for admin/diagnostic | <b>Operating System</b>     | Windows XP or<br>Windows 2000                      |

#### PC Accessibility

You can perform administrative functions using a laptop or PC that is connected directly to the voice mail system.

- » To connect the voice mail system to a PC, a straight-through cable is required.
- » Make sure the voice mail system is running before starting the *In-Skins Admin* program. (You can verify this by dialing a port number to see if a connection is made, or by checking the *Hard Drive-based Voice Mail* card to see if two of the three green LEDs are lit.)
- » To install the *In-Skins Admin* program, run the setup routine on the software CD provided.
- » Once the *In-Skins Admin* program is installed, the Integration wizard will help you connect to the voice mail system. You will need a mailbox number and password to log in: use mailbox **100** and password **0000**.

*Powering Up the System* -- When the STSe KSU is powered up, the *Hard Drive-based Voice Mail* system will also start. From the time the voice mail card is powered on, it will take about 4 minutes before the system is ready to process calls or to perform remote maintenance.

*Shutdown/Reset Warning* -- Before turning off the KSU or resetting the *Hard Drive-based Voice Mail* card, you should always attempt to "shutdown and park" the voice mail system using either a digital telephone or the *In-Skins Admin* program. For more details on this feature, refer to "[Shutdown Wizard](#)" on page D-12.

*Voice Mail Station Numbers* -- By default, the *Hard Drive-based Voice Mail* system uses station numbers 150-157. For best results, allow all voice mail ports to remain in **Voice Mail Group 440** as configured at the factory.

*PC/Laptop Administrator Login* -- To access the voice mail system as an administrator, ... enter the system defaults which are: mailbox number **100**, and password **0000**.

**Software Installation**

To install the *In-Skins Admin* program on the Administrator’s computer:

1. Place the *In-Skins Admin* software CD in the CD-ROM drive, it should launch automatically.
2. Once the CD loads, click the “Install” option. Certain program files will transfer to the PC.
3. When the “*In-Skins Admin Setup*” window appears:

Click on the “computer” icon to accept the default directory (c:\Program Files\IsAdmin),

-or-

Click on the “Change Directory” button to select another location.

4. After choosing the file destination, the necessary program files will be copied to the directory you selected.

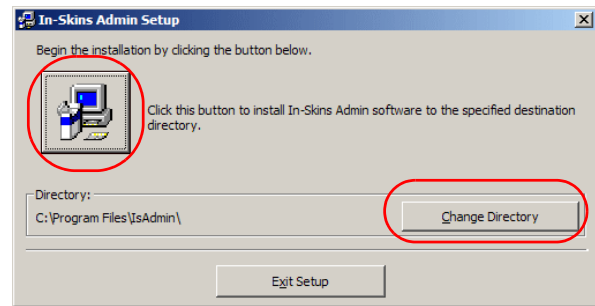

» » » When the installation is complete, restart the computer.

**Starting the In-Skins Admin Program**

During the installation routine for easy access, the *In-Skins Admin* program was placed on the administrator’s computer under *Start>Programs>Inskins Admin*. Each time you open the program, the “Connection Wizard” will display the following connection options:

- » Direct via RS232 Cable
- » Remote System via Modem Call
- » Offline - Local Data

The voice mail system can be administered locally or remotely, or you can work offline to add multiple names and station numbers.

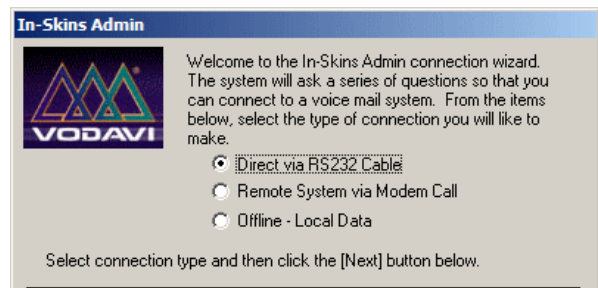

*Local STSe Site*

For a local connection, use a “straight through” cable to connect the KSU to the serial port of the laptop or PC where the *In-Skins Admin* program will be installed.

1. With the voice mail system up and running, start the *In-Skins Admin* program.
2. When the “Welcome” window displays, select **Direct via RS232 Cable** and click NEXT.
3. Type in a new system name, or select a name from the dropdown list, and click NEXT.
4. Select the appropriate COM port for your system, then choose the proper baud rate for your modem. The default baud rate is 115200.
5. Enter a valid mailbox number and password, then click FINISH to connect to host system.

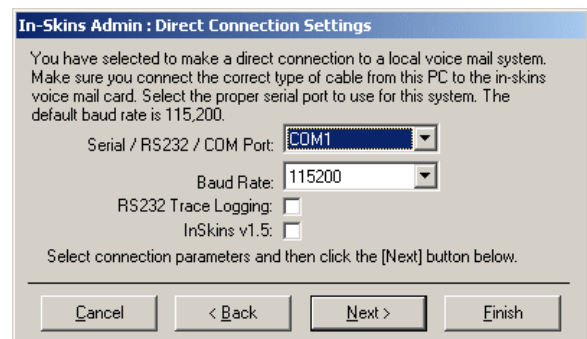

*Hard Drive-Based Voice Mail**Remote STSe Site*

If you will be connecting a laptop to the voice mail system from a remote location, then you will need to use the PC's serial port and connect it to your own external modem.

1. With the voice mail system up and running, start the *In-Skins Admin* program.
2. When the "Welcome" window displays, select the **Remote System via Modem Call** option and click NEXT.
3. Type in a new system name, or select a name from the dropdown list, and click NEXT.
4. Enter the phone number of the site to which you want to connect, select the modem device to use to make the call, then click NEXT.
5. In order to connect to the host system, enter a valid mailbox number and password and click FINISH.

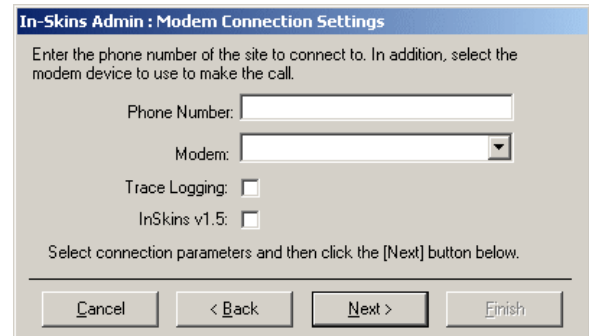
**Navigating in the System**

The sections that follow describe the system menus in the same order that they appear in the *In-Skins Admin* program window. The menu options are:

|                      |  |
|----------------------|--|
| Wizards              | help to perform system functions: backup/restore/shutdown/upgrade/logging        |
| Subscribers          | set up mailbox, notification, and station settings                               |
| Class Of Service     | define voice mail, owner, and attendant options                                  |
| Menus                | assign voice prompts and key menu actions  |
| Time Controls        | set up "time-sensitive" rules  |
| System List          | create system-wide distribution lists  |
| System Lines         | determine how lines should answer calls and what menus to run                    |
| System Configuration | modify system settings: VM, Registry, License, IP Addresses, & KSU Clock Control |
| Reports              | generate statistical reports: call activity, logs, and messages                  |
| System Status        | view line activity: call status, number of calls and their duration              |
| File Manager         | access voice mail files and directories  |

- » In the "left" window, double-click on any option to expand its related topics.
- » Select a topic and the *Property/Value* window on the "right" will show the settings available for that specific item.
- » Depending on the topic you select, you will be able to:
  - type in a specific value, or
  - choose items from a dropdown box, or
  - click an ELLIPSES button [...] to open the next option window.

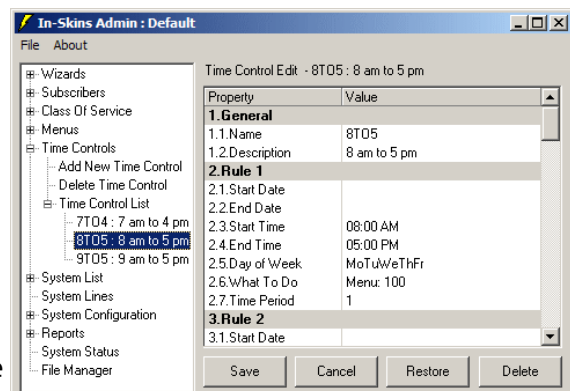

- » After making changes to the system, click one of the "action" buttons presented before selecting another menu. The available buttons are: Save | Cancel | Restore | Add | Delete.



**Program Window Options**

The **FILE** dropdown menu allows you to:

- » Close all expanded menu items at the same time by clicking on the “Collapse Menu” function. For easy viewing, this option only displays the MAIN menus.
- » Enable the “Show Confirmations” function. This option allows you to verify and/or modify your changes before updating the system. This function is TURNED ON (✓) by default.

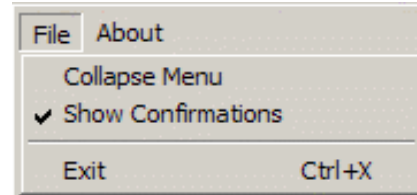

The **ABOUT** menu displays the software version of the *In-Skins Admin* program being used to run your voice mail system. This information could be helpful when working with Vodavi Technical Support.

**Wizard Applications**

**Integration Wizard**

The Integration Wizard is a program that can be used to obtain various types of information directly from the KSU to help you with the setup process.

From the items below, select the information you want to retrieve from the KSU and modify on the voice mail system.

- ✓ Add Stations to Voice Mail
- ✓ Update Names on Voice Mail (see note)
- ✓ Set Voice Mail Time to KSU Time

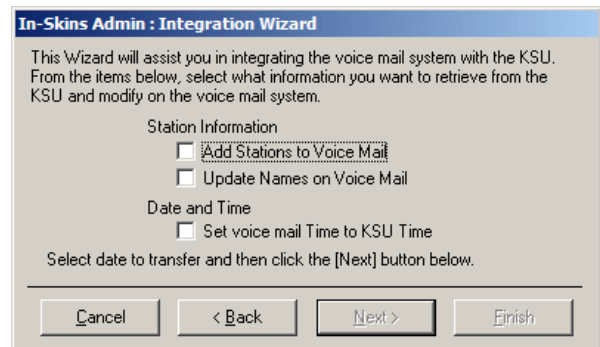

|             |   |
|-------------|---|
| <b>Note</b> | <p>To Update Names AND <u>increase response time</u> ...</p> <ol style="list-style-type: none"> <li>1) Work in “Offline Mode”.</li> <li>2) Update all names at the same time.</li> <li>3) Make sure you SAVE your entries, then Upload the changes to the KSU.</li> </ol> |
|-------------|---|

*What Will Happen:*

- ❑ Anytime the voice mail system is started or reset, the “Integration Wizard” window will appear to allow you to select the desired information you wish to download.
- ❑ The wizard settings will override any phone system integration programming that was previously entered.
- ❑ The “Integration Wizard” is accessible from the *In-Skins Admin* program menu where a user can run this program at anytime.
- ❑ The voice mail unit will build a list of mailboxes and corresponding extensions based on this information. The station name field will be used as the subscriber name.
- ❑ Mailbox numbers will be created based on the VMID field in the station number download.
- ❑ Once the download is complete, a confirmation screen will display a successful download message from the KSU.

### Backup Wizard

The Backup Wizard will create a backup file of the data generated by the voice mail system.

**FILE LOCATION** -- The backup data is stored on the computer where the program resides under the Program Files\IsAdmin\Backups directory with a "date\_time" filename for easy identification: yyyyymmdd\_hhmm.

**BACKUP CRITERIA** -- You will be able to select which items you want to backup: Subscriber Settings, Class of Service, Menus, Time Controls, and/or System Configuration data.

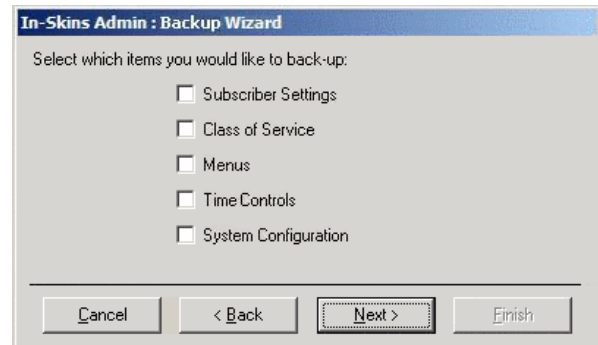

### Restore Wizard

When needed, the Restore Wizard will allow you to perform a partial or complete restore of the voice mail system settings.

**RESTORE USING BACKUP FILES** -- Choosing the "Restore from a file set on this computer" option will restore specific system files from data previously backed up and stored on the Admin computer.

You will be able to choose which items you want to restore: Subscriber Data, Class of Service, Menus, Time Controls, System Configuration, and/or data from Other Files.

**RESTORE TO DEFAULT SETTINGS** -- Selecting the "Restore system to factory settings" option will reinitialize the system to its original state. This action will cause all current data to be lost, and the system to shutdown.

**NOTE** ... Choosing either option will require the system to be shutdown and prevent it from taking any calls.

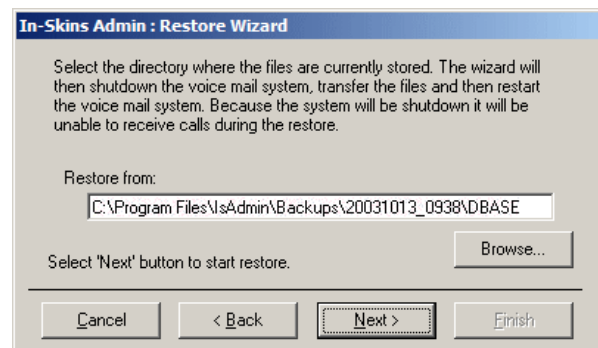

### Shutdown Wizard

The Shutdown Wizard is used to shutdown the voice mail system. You will have the option of selecting which shutdown method to use.

**SHUTDOWN AND PARK** -- If you are going to turn off the KSU (i.e., to install new hardware), then you should select to park the system.

**SHUTDOWN AND RESTART** -- If you wish to recycle the voice mail system (i.e., to change system settings), select the restart option.

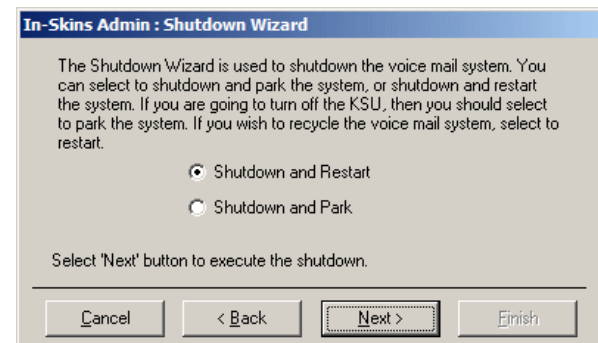

**Software Update Wizard**

The Software Update Wizard will assist you in performing periodic software upgrades to the voice mail system.

To Start the Upgrade Process:

1. Insert the voice mail upgrade software floppy disk.
2. From the *In-Skins Admin*, select the “Software Update Wizard” menu.
3. Click the BROWSE button and select the “update” file on the floppy disk.
4. Then click NEXT to have the file sent to the voice mail system.
5. When the upgrade process is complete, you will be prompted to “Reset” the voice mail system. This function is recommended during off-peak hours, as it will prevent any calls from being taken.

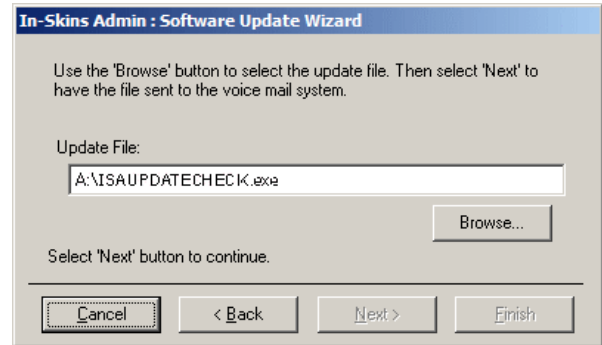

**Logging Wizard**

The Logging Wizard will create a system log based on the YES/NO value you select for each function shown in the “What to Log/Debug” list.

FILE LOCATION -- The system will automatically place the new log file on the Administrator’s PC under:  
*c:\Program Files\IsAdmin\Host\_Data*

USAGE -- By selecting only those modules you want to review, these logs will help to isolate possible system conflicts or problems.

| What to Log         | What to Debug    |
|---------------------|------------------|
| Call Start and Stop | Basic Foundation |
| Voice Mail          | Voice Mail       |
| Auto-Attendant      | Auto-Attendant   |
| Menus               | Menus            |
| Voice Mail Owner    | Voice Mail Owner |
| Directory           | Directory        |
| Track Messages      | Events           |
| Message Manager     | Message Manager  |
| Notification        | Notification     |
| Time Controls       | Time Controls    |
| Integration         | Integration      |

**Prompt Record List Wizard**

The Prompt Record List Wizard will allow you to view a list of all previously recorded voice prompts.

- » A prompt may be recorded at any time by calling into the voice mail system, accessing an administrator’s mailbox, and pressing [7] for Admin Functions.
- » Select options [1] and [2] to access the system prompt recorder. You will need to know the ID number of the prompt in order to record the new message.
- » To view a list of the default system prompts available, refer to *“Hard Drive-based Default System Prompts” on page D-43*.

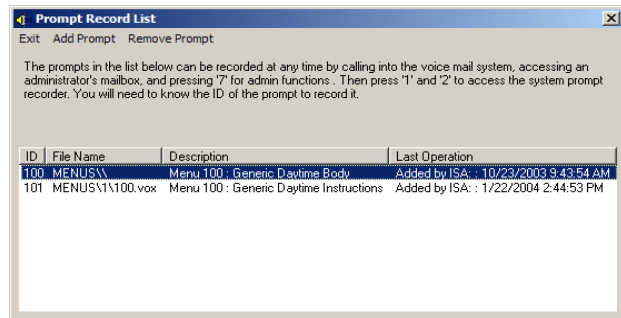

## Subscriber Menus

A Subscriber is someone who owns an extension and mailbox on the voice mail system. The "Subscribers" menu displays the mailboxes, extensions, and names associated with those subscribers.

In the left window, double-click on "Subscribers" to display related menu options. Then select one of the following action menus: Add, Delete, or Subscriber List to set up parameters.

### **To Add a New Subscriber:**

1. Click "Add New"; then enter the number for the station and mailbox you want to link to the subscriber. Typically, the mailbox number is the person's extension, or it can be different in the case of a user having more than one mailbox.
2. Type in the first and last name of the subscriber in their respective fields. (The last name entry will also be used for the Company Directory.)
3. To use another subscriber's mailbox as a TEMPLATE, select an existing mailbox number from the dropdown list. This option will copy over all mailbox and extension settings to the new subscriber for easier editing.
4. When finished, click the ADD button. A system message will confirm that the new subscriber was added.

### *Adding a RANGE of Subscribers:*

1. Click "Add Range"; then enter the starting number for the station and mailbox ranges.
2. In the "Number to Create" field, type the total of consecutive numbers you want to add to the system.
3. Then click ADD, the system will automatically update the system.  
To verify that the new numbers have been added ... click on the template dropdown arrow to actually see the new numbers.

### **To Delete a Subscriber:**

1. After selecting "Delete Subscriber"; click in the "Station" field. A current list of station numbers will display.
2. Select the station number you want to remove, then click the DELETE button.
3. When the "Delete Subscriber" window displays, click YES to confirm your action.

### *Deleting a RANGE of Subscribers:*

1. After selecting the "Delete Range" option, click in the "First Station to Delete" field.
2. Then click on the dropdown arrow and select the starting number in the range.
3. Click in the "Last Station to Delete" field, and then click on the dropdown arrow.
4. Select the ending number in the range, and click the DELETE button.
5. Click YES when the "Delete Subscriber Range" confirmation window displays.

**Editing the Subscriber List**

Double-click on “Subscriber List” and then select the desired subscriber. From this list, you can change a subscriber’s general settings (name/password/COS), and those that pertain to their specific mailbox and/or station, to include notification parameters.

| SUBSCRIBER Options                               | Description  |
|--|--|
| <b>GENERAL</b>                                   | While in the subscriber’s screen, if you click on one of the subscribers, you can edit and verify such items as passwords and user names.  |
| Station Mailbox                                  | Enter the Station and/or Mailbox number you want to add to the system, or to modify the existing information.  |
| First Name<br>Last Name                          | Change as needed. The “Last Name” field is the name used in the Company Directory.   |
| Password   | Enter the number to be entered by the mailbox user to retrieve mailbox messages. Use the default password when accessing the mailbox for the first time. Initially, it should be set to a code that is easy to remember. The user can then change the password later as needed. Default = 0000   |
| Department                                       | Enter the department or area in which the employee works.  |
| Class of Service                                 | Select the Class of Service to associate with this mailbox. Note that if the Class of Service field is left blank, the voice mail system defaults to the last COS used by the system. In a system that uses multiple COS, errors could arise. You should assign a class of service to each extension to avoid potential problems. Default = BASIC  |
| Tutorial   | Determines whether a subscriber will have access to the tutorial to help set up their mailbox. This option is typically used for new subscribers. Default = ON   |
| <b>MAILBOX SETTINGS</b>                          | Click on Mailbox Settings to edit options like Time Control, Operator Station, and Cascade Mailbox.  |
| Time Control                                     | Calls are often handled differently in the evening, during the weekend, or on holidays than they are during regular business hours. The time control function lets you define a set of alternative actions that <i>STS In-Skin</i> will perform for a given time setting. Time controls are created by selecting Time Control from the main menu. If you do not intend to use Time Controls, set to NONE. Refer to <a href="#">“Time Control Menu” on page D-29</a> for more information.  |
| - MAILBOX SETTINGS, cont’d -<br>Operator Station | Enter a personal operator for the mailbox. This is used when a caller dials [0] while connected to a mailbox. The call is transferred to an alternate extension instead of to the system-wide operator. This can be used to transfer calls to a personal assistant.  |
| Cascade Mailbox                                  | Message cascading is a feature that will copy or move messages left for the originating mailbox to another mailbox. In order to use message cascading, the originating mailbox’s Class of Service (COS) must be configured to allow the feature. Refer to <a href="#">“Class of Service Menu” on page D-18</a> for more information on the COS settings. Within the mailbox settings, you only need to enter the destination mailbox. This feature will not work until the COS settings have been properly administered. Typical uses include archiving and notification of no answer to messages left in a mailbox (i.e. for Customer Service). |

*Hard Drive-Based Voice Mail*

| <b>SUBSCRIBER Options</b> | <b>Description</b>  |
|---------------------------|---|
| <b>MAILBOX ACTION</b>     | Click "Play Greeting" if the voice mail system is to play the greeting recorded for this mailbox when the mailbox is accessed. Use the dropdown list to select the action that the mailbox will perform when a message is left.     |
| Play Greeting             | Determines whether or not the system will play a greeting when a mailbox receives a call.   |
| What to do                | <i>Select from the following options:</i><br>TAKE A MESSAGE - records messages in the mailbox for later retrieval.  |
|                           | FORWARD TO ANOTHER MAILBOX - sends caller to an alternate mailbox. Notification and MWI rules of the "forwarded to" mailbox apply.  |
|                           | FORWARD TO EXTENSION/STATION - sends the caller to an extension. Extension settings of the "forwarded to" extension apply.  |
|                           | FORWARD TO MENU - sends the call to a menu where further options may be provided to the caller. Refer to <i>"Menu Options" on page D-26</i> for details.  |
|                           | FORWARD TO TIME CONTROL - causes the voice mail system to execute the assigned time control and take the appropriate action. Refer to <i>"Time Control Menus" on page D-29</i> for details. Use caution when selecting this option. |
|                           | FORWARD TO MODULE - automatically runs another module when the mailbox is accessed. Special applications only.  |
|                           | MAILBOX IS OFF - disables the mailbox's ability to take messages. This option plays the prompt "Mailbox is off," to the caller.   |
|                           | MAILBOX IS FULL - plays a message to the mailbox owner stating that the mailbox cannot record any new messages until old ones are deleted. Plays a message to the caller saying the mailbox is full.                                |
| Forward to                | When "Forward to Mailbox" or "Forward to Extension/Station" is selected, enter the mailbox or station number where you want to forward your calls.  |
| <b>NOTIFICATION</b>       | Notification refers to external numbers (i.e., pager, mobile, etc.). MWI is handled in the Registry and/or COS. Refer to page <i>D-18</i> .   |
| Notification Type         | <i>Select from the following options:</i><br>TURNED OFF - disables message notification completely.   |
|                           | IMMEDIATE - sends notification immediately upon receiving messages.   |
|                           | TIMED - sets a time to notify mailbox owner of new messages.  |
|                           | URGENT - instructs system to only send notification if message left is marked urgent.   |
| Phone Number              | Enter the phone number to dial for notification.  |
| Phone is Pager            | When choosing any method of notification, you will see a Pager Notification checkbox. Check this if the notification number is a pager. Be sure to press the OK button before leaving this window.                                  |
| Notification Time         | To receive your messages at a specific time, enter the time using the hh:mm format.   |

| SUBSCRIBER Options      | Description  |
|-------------------------|--|
| <b>STATION SETTINGS</b> | Select Station Settings to edit the actions for mailbox numbers as well as to change transfer options and time controls.   |
| Time Control            | Calls are often handled differently in the evening, during the weekend, or on holidays than they are during regular business hours. The time control function lets you define a set of alternative actions that the voice mail system will perform for a given time setting. Time controls are created by selecting Time Control from the Setup menu. If you do not intend to use Time Controls, set to NONE.  |
| <b>STATION ACTION 1</b> | The <i>In-Skins Admin</i> program provides three action fields that determine how the system handles incoming calls. The voice mail system refers to the three options in a cascading order. That is, the first field has precedence over the second, while the second field has priority over the third.  |
| What to do              | <p>Select from the following options:</p> <p>BLIND TRANSFER - indicates an unsupervised transfer to the requested extension. This option is commonly used with phone systems that support call forwarding and inband integration.</p> <p>SUPERVISED TRANSFER - allows the system to monitor call transfers to determine whether the called extension is busy or is not being answered. If the call is not answered, the system refers to the subsequent Action entries (Action 2) for instructions on handling the call. Only 1 transfer type (Supervised or Blind) can be selected at a time.</p> <p>FORWARD TO EXTENSION/STATION - sends calls to the specific extension entered in the Extension field.</p> <p>FORWARD TO MAILBOX - forwards calls to the specific mailbox entered in the Mailbox field. Usually this is the called extension's personal mailbox.</p> <p>FORWARD TO MENU - forwards calls to the specific menu entered in the Menu field. Refer to <i>"Menu Options"</i> on page D-26 for more details.</p> <p>FORWARD TO TIME CONTROL - runs the designated time control file and takes the actions designated for the current time. Refer to <i>"Time Control Menus"</i> on page D-29 for details.</p> <p>FORWARD TO MODULE - forwards callers to a custom script module.</p> |
| Number to dial          | Enter the number that applies to the transfer and forwarding options selected.   |
| Screen Caller           | When a person dials an extension through the auto attendant, the call screening feature prompts the caller to state his name. The voice mail system plays the caller's name to the extension owner before the call is actually transferred. The extension owner can either accept or reject the call, or send it to another extension or voice mailbox. This option works only with Supervised Transfer.   |
| Holding Allowed         | Gives the caller the opportunity to hold on the line in the event the called party is busy. The caller hears the following prompt: "I'm sorry, [extension's name] is busy. If you would like to hold, press [1]. To try another extension or leave a message for this extension, press [2]." This option works only with Supervised Transfer.  |



| SUBSCRIBER Options   | Description   |
|--|---|
| <b>STATION ACTION 2 &amp; 3</b>                                  | The options available depend on the selection for Action 1.   |
| When   | <i>Select from the following options:</i><br>DO ALWAYS - means the action will always take place.<br>ONLY ON BUSY - instructs the voice mail system to use this option if the previous transfer results in a busy signal.<br>ONLY ON NO ANSWER - instructs the voice mail system to use this option if the transferred call was not answered. |
| What to do<br>Number to dial<br>Screen Caller<br>Holding Allowed | <i>Refer to Station Action 1 ...</i>  |

### Class of Service Menus

Class of Service involves features and settings applied to a group of subscribers. The Class of Service (COS) screen displays the COS name and description. To begin any COS operation, Each voice mailbox and extension is associated with a Class of Service (COS) that defines its attributes. All mailboxes and extensions with the same COS operate identically in terms of COS options available to users. Grouping mailboxes and extensions into classes of service lets you change options for all the mailboxes and extensions in the same class simultaneously.

By supporting multiple COS, the voice mail system allows you to provide users with system feature options on an as needed basis. If you create more than one COS, you can save time by creating a COS template that serves as the basis for each COS you create.

In the left window, double-click on "Class Of Service" to display the other menu choices. Then select one of the following action menus: Add, Delete, or edit COS List.

#### **To Add a New COS:**

1. Under the *Class of Service* menu, click "Add New COS".
2. Enter the name you want to link to this COS in the "Name" field.
3. Then, enter a general description that will identify the COS.
4. To use another Class of Service as a TEMPLATE, select an existing COS from the dropdown box. This option will copy over all COS settings to the new COS for easier editing.

#### **To Delete a COS:**

1. Click in the "COS Name" field, a dropdown box will appear on the right.
2. Click on the arrow to display the COS items available.
3. Select the COS you want to remove, then click the DELETE button.
4. When the "Delete COS" window displays, click YES to confirm this action.



**Editing the COS List**

Double-click on "COS List" and then select the desired class of service. From this list, you can change the general settings (Name/Time Control/User Type), and the parameters that pertain to voice mail greeting and messages, and mail box owner capabilities.

| <b>CLASS OF SERVICE Options</b>  | <b>Description</b>   |
|----------------------------------|--|
| <b>GENERAL</b>                   | The General COS section allows you to set up the values for the most common class of service settings.   |
| Name<br>Description              | Enter a brief name & description of the COS to help identify it in other operations.   |
| Time Control                     | <p>Calls are often handled differently in the evening, during the weekend, or on holidays than they are during regular business hours. The Time Control function lets you define a set of alternative actions that the voice mail system will perform for a given time setting. If you do not intend to use Time Controls, leave this setting "blank." Refer to <a href="#">"Time Control Menus" on page D-29</a> for more details.</p> <p><i>NOTE ... Use only with help from Vodavi Technical Support.</i></p> |
| User Type                        | Set user type to 99 only when granting system administrator access. For all other uses, this should be set to 10. Types 02-98 are not used.  |
| Event Counters                   | <p>Leave default parameter set to "None" if you do not want to refer to system usage.</p> <p>Select which group(s) you want to monitor access to mailboxes and extensions: Callers, Owners, or Callers and Owners.</p>   |
| Language                         | The mailbox and extension prompts will be played in the language selected: English or Spanish.   |
| Restrict OutDial, maximum digits | You can use this field to disable long distance dialing from the extension or from mailbox notification by entering the number of digits required for local calls (typically 7 or 10).   |
| <b>VOICE MAIL GREETING</b>       | This section allows you to select from pre-recorded messages or prompts to be used when greeting a caller.   |
| Greeting Type: Personal          | The personal greeting is a message played to a calling party before a message is recorded to a mailbox. If the owner does not record a personal greeting, the System (default) greeting is used.   |
| Greeting Type: System            | A generic message used when no personal greeting has been recorded. If both the Personal and System greetings are activated, the voice mail system will only play the personal greeting when one has been recorded.  |
| Greeting Type: System Add-On     | A shorter version of the System default greeting that follows a personal greeting. This greeting plays "Begin speaking at the tone. To stop recording press any key, etc." whereas the regular System greeting plays "The person you have tried to reach is unavailable, begin recording ..."  |
| Greeting Type: Class of Service  | Greeting that will play a single greeting for all mailboxes that share the same Class of Service. This is done to conserve disk space by eliminating the need for each mailbox to have its own greeting prompt. Class of Service can also be used as an add-on to a personal greeting.   |
| Greeting Type: Voice Insert      | Plays a Class of Service prefix prompt followed by a name prompt, which in turn is followed by Class of Service postfix prompt. This is often done to personalize a Class of Service greeting while limiting the amount of disk space used.  |
| Greeting Length, seconds         | Enter the amount of time, in seconds, for each greeting.   |

*Hard Drive-Based Voice Mail*

| <b>CLASS OF SERVICE Options</b>                          | <b>Description</b>  |
|--|---|
| - VOICE MAIL GREETING, cont'd -<br>Park and Page Allowed | If option enabled, the following will occur: if a call comes into a mailbox, and during the mailbox greeting the caller presses 7, the caller will be transferred to a park location and the system will initiate a company-wide broadcast page for the mailbox owner.<br><br><i>NOTES ...</i> The mailbox greeting must include instructions for dialing [7] to access Park and Page. (This option is not available on all systems.) |
| <b>VOICE MAIL MESSAGE</b>                                | This section allows you to set up the values for the VM messages used by your system.   |
| Message Type: Voice                                      | The most common message type and is typically the only option selected. Allows callers to leave a voice recording for the called party. If mailboxes using this COS wish to receive numeric page messages, then check the Page item.  |
| Message Type: Page                                       | Allows callers to leave a numeric message.<br>Note that a single mailbox can store a combination of any or all message types. Even mailboxes set for voice messages can be notified using a numeric pager. This setting only applies to inbound messages, and not to the notification type. If more than one type of message is selected, select one as the default.  |
| Default Message Type                                     | If the mailbox is set up to receive more than one type of message, and the caller does not select a message type, this Default option will determine which message type the system will record.   |
| Message Type Menu  | Leave this option set to NO if the mailbox owner should handle access to different message type options in the mailbox greeting. Select this option if you want the voice mail system to present the caller with a menu such as: To leave a voice message, press [1]; To leave a page message, press [2].   |
| Message Length, seconds                                  | This option determines the amount of time allocated to a message. After the specified number of seconds has elapsed, the caller will be presented with the normal Send Menu as if the caller had pressed a key to stop recording. The recommended length is 120 seconds.  |
| Message Count, messages                                  | This option determines the maximum number of messages that can be stored in a mailbox. When the number of messages in a mailbox exceeds this parameter, the mailbox plays a message saying it is full. No further messages will be taken until the number of messages in the mailbox is reduced. A maximum of 50 messages is recommended.   |
| Message Retention, days                                  | The voice mail system can automatically delete messages that have been stored longer than a specified amount of time. The recommended retention period is 30 days by default; this can be extended or shortened, depending on your specific needs.  |
| Record Key   | Leave this option set to NO if you want the voice mail system to automatically begin recording a voice message. When this is turned on, the caller must first press a key for recording to begin.   |
| <b>VOICE MAIL CALLER</b>                                 | --  |
| Record Stop Key; 8=Urgent                                | Select this option to activate the one-key urgent message send feature. With this option turned on, if an outside caller presses [8] to end the recording of a voice message, the message is <i>marked urgent, sent, and the caller proceeds to Last Options</i> .<br><br><i>NOTE ...</i> The mailbox greeting must include instructions for dialing [8] for urgent messages  |

| CLASS OF SERVICE Options                                       | Description  |
|--|--|
| <p>- VOICE MAIL CALLER, cont'd -<br/>Caller Record Options</p> | <p>If this option is selected and the caller presses a key after leaving a voice message, the caller will hear the following menu options:<br/>Press [1] to send the message<br/>Press [2] to play the message<br/>Press [3] to cancel<br/>Press [4] to append the message<br/>Press [5] to re-record the message</p>  |
| <p>Caller Send Option: Urgent</p>                              | <p>Urgent messages are preceded by an Urgent prompt, trigger immediate notification, are played as the first of a group of messages.</p>   |
| <p>Caller Send Option: Private</p>                             | <p>Private messages cannot be forwarded, and are preceded with a warning to pick up the phone if messages are being played on a speaker phone.</p>   |
| <p>Last Options</p>  | <p>Select according to what you want the system to do once the caller has left a message.<br/><br/>OFF - plays "thank you" and hangs up.<br/>ON - plays the default menu options. The default menu options are:<br/>    To access another mailbox, press [1].<br/>    To access an extension, press [2].<br/>    To disconnect, press [9].<br/>    To transfer to an operator, press [0].<br/><br/>RUN MENU - checks for entry in Last Options Menu field.</p> |
| <p>Last Options Menu</p>                                       | <p>If Last Options is set to "Run Menu," the Last Options Menu is played.<br/><i>NOTE</i> -- If Last Options is set to OFF, a caller's ability to navigate in the system will be limited.</p>  |
| <p><b>VOICE MAIL OWNER</b></p>                                 | <p>This section determines the modifications individual users can make to their personal mailboxes.</p>  |
| <p>First Time Help</p>   | <p>Check this option if you want to have each new user prompted to record such essential parameters as a mailbox greeting, a mailbox name, and a password.</p>   |
| <p>Message Date Time</p>                                       | <p>The voice mail system can announce the date and time that a message was received.</p>   |
|  | <p>MANUAL NATURAL - user must press a key to hear the date and time. Natural means we say the date and time in general terms; for example, saying "Monday," or "yesterday." Press [8] after the message has played.</p>  |
|  | <p>MANUAL FULL - user must press a key to hear the full date and time. An example would be "Monday, February 28, 2004, at 7:00 p.m." Press [8] after the message has played.</p>   |
|  | <p>AUTOMATIC NATURAL - date and time are played automatically at the beginning of each new message. The user does not have to press any keys.</p>  |
|  | <p>AUTOMATIC FULL - full date and time are automatically played. The user does not have to press any keys.</p>   |
| <p>Message Ordering</p>  | <p>Determines the chronological order in which messages are played.</p>  |
|  | <p>NEWEST MESSAGE FIRST - The last message left in chronological order will be the first one played.</p>   |
|  | <p>OLDEST MESSAGE FIRST - The first message left in chronological order will be the last one played.</p>   |

*Hard Drive-Based Voice Mail*

| <b>CLASS OF SERVICE Options</b> | <b>Description</b>  |
|---------------------------------|---|
| <b>OWNER PLAY OPTIONS</b>       | These parameters determine the functions available to users when playing messages in their mailbox.   |
| Allow Saving Messages           | Allows users to save messages for later retrieval. Press [2] to save messages.  |
| Require Confirming Delete       | Requires users to press the [#] key after pressing [3] to delete a message. This is used as a safeguard against accidental deletion.  |
| Allow Reply                     | Allows users to reply to the message by pressing [5].   |
| Allow Forwarding                | Allows users to forward messages to other mailboxes or to an outside number. Press [4] to forward messages.   |
| Allow Dialing Source            | Allows the user to connect to the person responsible for sending the message.   |
| Allow Skipping Messages         | Allows users to skip messages by pressing [6] then [3] while listening to a message.  |
| <b>OWNER SEND OPTIONS</b>       | These parameters determine the functions available to users when sending messages from their mailbox.   |
| Sending Not Allowed             | Is used for creating simple mailboxes which cannot send a message.  |
| Allow Urgent                    | Allows the user to assign urgent status to a message. Urgent messages are preceded by an Urgent prompt, trigger immediate notification, and are played as the first of a group of messages.   |
| Allow Confidential              | Allows the user to specify that a message cannot be forwarded and is preceded with a warning to the recipient that the message is confidential.   |
| Allow Future Sends              | Allows delivery of messages at a future time and date.  |
| Allow Sending to Outside Number | Allows the user to send a message to an outside number. This option should be used with caution since the voice mail system will try to call an outside number and play the message.  |
| Allow Sending to System List    | Allows the user to send messages to a system-wide list. The list is maintained by the administrator.  |
| Allow Confirmation              | Enables the user to request receipt information for a marked message, so that the system notifies the sender when either the message has actually been listened to or the message was not heard before the notification attempts expired.                                       |
| <b>OWNER EDIT OPTIONS</b>       | These parameters determine the mailbox customization available to users within this COS.  |
| Change Password                 | Restricts unauthorized access to the mailbox. Enables the mailbox owner to change the mailbox password. This is typically set to NO when a mailbox is for temporary use.  |
| Edit Greeting                   | Allows the mailbox owner to edit their greeting, and is typically enabled. The greeting is a message played to a calling party before a message is recorded to a mailbox.   |
| Edit Name                       | Allows the owner to change the mailbox name, which is used in prompts associated with the mailbox. Name / Signature is an identifier for a mailbox. It is used when calls are transferred, and when messages are forwarded, replied to, or sent.                                |
| Edit Notification               | Allows the owner to change such notification settings as the extension or phone number to call, and the time of notification (such as for a pager). Notification is the indication of new messages in mailboxes. This does not affect message waiting indicators on telephones. |

| <b>CLASS OF SERVICE Options</b>                      | <b>Description</b>  |
|--|---|
| - OWNER EDIT OPTIONS, cont'd -<br>Edit Mailbox State | Allows the owner to turn the mailbox off and use one of the following: greeting only, forward calls to an extension, forward calls to a mailbox, or forward calls to menu. Use the NO setting when a simple mailbox is desired and there is a possibility of activating erroneous forwarding.   |
| Edit Personal Lists                                  | Allows the user to create up to 10 personal lists and maintain them over the telephone. Personal distribution lists are numbered from 0 to 9. Each contains personalized lists of mailboxes that are addressed as a group for simplifying delivery.   |
| Edit Guest Mailboxes                                 | Allows the owner to communicate with a guest that does not have a mailbox on the system. Each system mailbox can have up to 10 guest mailboxes. Each mailbox owner administers guest mailboxes and assigns a unique number to each guest.<br><br>Owners may send messages to guest mailboxes by following the prompts for sending to other address types.<br><br>Guests retrieve messages by pressing [4] during the owner's greeting. The guest then enters their unique number (phone number or social security number, etc.), followed by [#]. The guest may then retrieve messages sent by the mailbox owner and reply back to the mailbox owner. |
| Auto-Attendant Settings                              | Allows the mailbox owner to edit extension settings. The mailbox owner can also change forwarding and transfer types.   |
| Personal Notepad                                     | Gives the mailbox owner access to a personal voice note pad. The voice note pad is referenced with an index. The index can be any 8-digit number with an associated voice file. For example, a personal note pad could be used for saving phone numbers and addresses.  |
| Allow Transferring Out                               | Allows the mailbox owner to transfer to other extensions or mailboxes. This option should be set to NO in a service bureau application or when the auto attendant is not used.<br><br>At the top level of mailbox owner, the caller can press 0. The system will respond "To access another mailbox, press [1]. To access an extension, press [2]."   |
| Deleting Unheard Messages                            | Allows the mailbox owner to pull-back messages that were sent to another local mailbox. The system will prompt the owner for the destination mailbox, and then check to see if any unheard messages from the owner are still in the destination mailbox. The system will play each message and allow the owner to selectively delete.   |
| <b>VOICE MAIL NOTIFICATION</b>                       | This menu describes the notification options used to tell mailbox owners when they have a new message.  |
| Message Waiting                                      | The voice mail system sends message waiting commands to phone systems that support message waiting lights or similar notification devices.<br><br>OFF - does not light MWI. An example would be a mailbox not having an internal telephone.<br><br>ON FIRST MESSAGE - only sends commands to phone system to notify you after the first new message.<br><br>ON EVERY MESSAGE - sends command after each new message.  |
| MWI Set Sequence                                     | String to send to phone system in order to activate MWI Lamp.   |
| MWI Clear Sequence                                   | String to send to phone system to deactivate MWI Lamp.  |

*Hard Drive-Based Voice Mail*

| <b>CLASS OF SERVICE Options</b>                    | <b>Description</b>   |
|--|--|
| - VM NOTIFICATION, cont'd -<br>Event Handler Group | Event handler groups handle notification settings like message waiting and pager notifications. On a two-line system, line two is, by default, the notification line. On all other systems, the last two lines on the system are used for notification. Note that you can program the voice mail system on a Class of Service basis (in the Notification Options dialog box) to use only pre-selected lines for outgoing notification. |
| Voice Notify: Password Required                    | Set to Password Required to force the owner to enter a password to retrieve messages.  |
| Voice Notify: Msg Pickup Allowed                   | Set to Message Pick-Up Allowed to allow message retrieval. Note that allowing message pick up without a password can undermine the privacy and security of the mailbox. Also, voice notification should not be used on systems that are using blind or release transfers.  |
| Message Cascading                                  | This option gives the voice mail system great flexibility in delivering a message. Any incoming message, depending on the cascade setting, can be redirected to other mailboxes.   |
|  | OFF - set to OFF to suppress this function.  |
|  | IMMEDIATELY - causes cascading to begin immediately, allowing duplicate messages to be stored in several mailboxes.  |
|  | WHEN NOTIFY FAILS - forwards the message to another mailbox only when the notification has failed and the mailbox owner has not retrieved the message.   |
| Cascade Only Urgent Messages                       | Set option to YES to cause only those messages marked urgent to be cascaded.   |
| Original Message                                   | These options are available when Message Cascading is set to: Immediate or When Notify Fails.  |
|  | LEAVE AS NEW - stays in mailbox as a new message.  |
|  | SAVE ORIGINAL - causes the message to be saved in the original mailbox once the forwarding is completed.   |
|  | DELETE ORIGINAL - causes the original message to be deleted from the original mailbox once the forwarding is completed.  |
| Notification Interval, minutes                     | This parameter determines the time interval between each notification attempt to the number defined in mailbox notification settings until the owner retrieves the message. The time is measured in minutes, with a maximum interval of 999 minutes.   |
| Notification Attempts                              | This parameter determines how many times the voice mail system will attempt to notify a mailbox owner of the number defined in mailbox notification settings after receiving a new message. The maximum attempts is 999.<br><br><i>NOTE ...</i> Notification attempts will continue as long as there is a new message in the mailbox.  |
| Retry Page Attempts                                | This option allows turning off pager retries while leaving all other retry options in tact. Since most pagers have memory and reminder features, the owner should not be repeatedly paged for the same message.<br><br><i>NOTE ...</i> However, since Pager Retries are directly related to Notify Attempts, you may receive a "limited" number of notifications attempts.   |

| CLASS OF SERVICE Options                           | Description   |
|--|---|
| - VM NOTIFICATION, cont'd -<br>Notification Script | This feature allows complex notification scripts to be created on a per Class of Service basis. This option can only be used if a notification script has already been written. <i>STS In-Skin</i> comes preloaded with 10 notification scripts that are similar in their function and only vary based on timers. <ul style="list-style-type: none"> <li><input type="checkbox"/> The name of the scripts are: PAGER6.CF, PAGER8.CF ... PAGER22.CF and PAGER24.CF. The number in each name represents how long after dialing the paging service, the voice mail system waits before it sends the mailbox number.</li> <li><input type="checkbox"/> After sending the mailbox number, the voice mail system's predefined scripts will send a *, urgent message count, another *, new message count, another *, followed by the saved message count.<br/> <i>FOR EXAMPLE</i> ... if mailbox 123 was being notified and had 1 urgent new message, 2 non-urgent new messages and 15 saved messages, the following would be sent: 123*1*2*15. Some pagers display "*"s as "- "s, so the display could look like: "123-1-2-15"</li> </ul> |
| <b>AUTO-ATTENDANT CALL OPTIONS</b>                 | These parameters allow a user to change their extension settings from their mailbox.  |
| Blind Transfers Allowed                            | Select this option to allow unsupervised call transfer where the voice mail system simply forwards the call to the requested extension. This option is commonly used with hunt groups or when you are certain the phone will be answered.   |
| Supervised Transfers Allowed                       | Select this option if you want the voice mail system to monitor the transfer to determine whether the called extension is busy or is not being answered.  |
| Call Screening Allowed                             | When a caller dials an extension, Call Screening prompts the caller for a name. This information is then given to the called party before the call is actually transferred. The called party can either accept or reject the call.  |
| Call Holding Allowed                               | This allows the caller to hold if the called party is busy. The caller hears: "I'm sorry, [extension's name/signature] is busy. If you would like to hold, press [1]. To try another extension or leave a message for this extension, press [2]."   |
| Extended Options Allowed                           | This option must be set to YES in order to activate any of the following auto-attendant call options that have been turned on: <ul style="list-style-type: none"> <li><input type="checkbox"/> Blind Transfers Allowed</li> <li><input type="checkbox"/> Supervised Transfers Allowed</li> <li><input type="checkbox"/> Call Screening Allowed</li> <li><input type="checkbox"/> Call Holding Allowed</li> </ul>  |
| <b>AUTO-ATTENDANT</b>                              | --  |
| Hold Type  | This setting (also related to Call Holding) determines what a caller hears if an extension is busy and the caller elects to be put on hold.   |
|  | SILENCE - keeps the call connected but the caller will hear nothing while on hold.  |
|  | FLASH HOOK - causes the voice mail system to execute a flash-hook when the caller is placed on hold (if provided by the phone system, the flash-hook will activate background music).   |
|  | PLAY HOLD FILES - caller will hear recorded messages that have been prepared for the voice mail system. Up to nine hold files can be recorded. Hold files are recorded using telephone-based administration. The first prompt file is recorded by selecting system prompt 014. The second prompt is 015. The entire range of nine files is accessed by using the numbers 014 through 022.   |



| CLASS OF SERVICE Options                          | Description  |
|---|--|
| - AUTO-ATTENDANT, cont'd -<br>Hold Interval, secs | This setting (related to Call Holding) determines how long the voice mail system will wait before retrying a busy extension. <i>For example ...</i> if the voice mail system attempts to ring a busy extension, and if the hold interval is set to 10 seconds, it will retry the extension every 10 seconds until a connection is made or until it reaches its retry limit. The time is measured in seconds, with a maximum interval of 999 seconds. |
| Call Queuing                                      | This option allows multiple calls to be placed on hold for a single extension. Turning this on causes the voice mail system to hold the calls in a queue until they are answered. Queued calls are answered in the order they are received.  |
| Screen Record Length, secs                        | This option determines the amount of time in which a caller must respond with a name when prompted to do so through Call Screening. The time is measured in seconds, with a maximum interval of 999 seconds.   |
| Play Call Source                                  | Checking this means that, if a message is left in a mailbox to where the extension was forwarded, the originally dialed extension is identified at the start of the message. Leaving this unchecked omits the identifier of the originally dialed extension.   |
| Transfer Prefix                                   | The dial sequence entered before dialing an extension number.  |
| Transfer Postfix                                  | The dial sequence entered after dialing the extension number.  |

## Menu Options

A menu is essentially a list of actions that is executed through touch-tone keys. For example, "For sales, press [4]. For support, press [5]. For administration, press [6]...". A menu can perform up to 13 actions, with each action corresponding to a key on a standard telephone keypad (including # and \*), plus 1 action as a time-out.

An action is a set of instructions selected from the Menu Action List. It tells the system how to respond when a specific key is pressed. Actions can be linked to other modules (transfer calls to extensions via auto attendant), or perform a special feature (play a pre-recorded message).

### To Add a New Menu:

1. Under the *Menus* directory, click "Add New Menu".
2. Enter the name you want to link to this Menu.
3. Then enter a general description that will identify the Menu.
4. To use another Menu as a TEMPLATE, select a menu number listed in the dropdown box. This option will copy over all Menu settings to the new Menu for easier editing.

### To Delete a Menu:

1. Under the *Menus* directory, click "Delete Menu".
2. Click in the "Menu Name" field, then click the dropdown arrow to display other Menus.
3. Select the Menu you want to remove, then click the DELETE button.
4. When the "Delete Menu" window displays, click YES to confirm this action.

### Editing the Menu List

Double-click on "Menu List" and select the desired menu. These multi-level menus are used to direct users and callers to information, assist them in performing tasks, and guide them in their use of the system.



| MENU Options  | Description  |
|---|--|
| <b>GENERAL</b>  |  |
| Name  | Indicates a 3-digit numeric name that will be used to reference the new menu. The system is preloaded with menus in the 100 range. The menus that you create should be between 200-998.  |
| Description   | Enter a brief description of the menu's function that will remind you of its purpose. Default = Generic Daytime  |
| Password  | Specify the password to protect the online recording action. This password is required when a caller accesses the Record Prompts action. Default = 2275  |
| Time Control  | Calls are often handled differently in the evening, during the weekend, or on holidays than they are during regular business hours. The time control function lets you define a set of alternative actions that the voice mail system will perform for a given time setting. Time controls are created by selecting Time Control from the Setup menu. If you do not intend to use Time Controls, set to NONE.  |
| Time Out  | Specify the length of time, if the caller presses no key, that the time-out action is to run. Default = 5  |
| Retries   | Specify the number of times the caller can initiate an invalid option. If the caller initiates another invalid action, the Max Retries key action is taken. Default = 3  |
| <b>PROMPTS</b>  |  |
| Introduction  | Enter the file name that should be played. This file name will be added to the prompt recorder list so that it can be recorded online. To see the current list of prompts, click the PROMPT LIST button.   |
| Body  | The prompts in the list below can be recorded at any time by calling into the voice mail system, accessing an administrator's mailbox, and pressing [7] for admin functions. Then press [1] and [2] to access the system prompt recorder. You will need the ID of the prompt to record it.   |
| Instructions  | Select the instructions prompt that contains the information the caller needs to choose which keys to press. Enter the filename with the VOX extension. The menu number should match the instruction filename. A typical instruction prompt would be: "Press [4] for sales."<br><br><i>NOTE</i> ... almost all menus have instruction prompt files. You can also have hidden menu options that are not described in the prompt.  |
| <b>MENU ACTIONS</b>   |  |
| Time Out Action   | Select a menu action when a caller does not press any key before the Time-Out period has elapsed. Default = Operator   |
| Retry Action  | Choose a menu action for callers that reach the maximum number of invalid Retries allowed. Default = Operator  |
| Key * Play Instructions<br>Key # Voice Mail<br>Key 0 Operator<br>Key 1 AutoAtt-Start<br>Key 2 AutoAtt-Start<br>Key 3 AutoAtt-Start<br>Key 4 Co Directory<br>Key 5 Co Directory<br>Key 6 Invalid Option<br>Key 7 Voice Mail<br>Key 8 Record Prompts<br>Key 9 Hang Up | Key actions determine the response invoked when a particular key is pressed. Each dial-pad key is associated with a key action field.<br><br>Clicking on any Key Action displays the Key X Action dialog box, where you can define the key.<br><br>By clicking on one of the items in the Action section, you can view a brief description of the action you have selected.<br><br><i>EXAMPLE</i> ... if you select the operator option, you are notified that the system will transfer the caller to the operator.<br><br>» » » The menu action modules are briefly defined on the next page. |

*Hard Drive-Based Voice Mail*

| MENU Options   | Description  |
|--|--|
| - MENU ACTIONS, cont'd -   | VOICE MAIL - sends callers to a pre-defined mailbox (if selected), or prompts the caller for a mailbox number.   |
|  | AUTO-ATTENDANT - performs several automated call transfer operations for Blind and Supervised call options.  |
|  | MENU - executes the selected menu. Enter the menu number to run.   |
|  | OWNER ACCESS - gives access to mailbox owner features. Can be used in in-band integration or to provide access through a hidden key on a menu.   |
|  | RUN MODULE - runs other modules supported by the voice mail system.  |
|  | TIME CONTROL - takes actions based on time, date, and day of the week parameters, as specified in a time control setting.<br>Refer to <i>"Time Control Menus"</i> on page D-29 .   |
|  | COMMAND FILE - runs the command file script.   |
|  | COMPANY DIRECTORY - provides a directory listing, for mailboxes or extensions.   |
|  | RUN ACTIVEX - runs an <i>ActiveVex</i> module such as: <i>AvDCC.run</i> for Desktop Call Control or <i>AVOutDial.main</i> for ChalkTalk.   |
|  | OPERATOR - transfers a caller to an operator by doing a blind transfer to [0].   |
|  | INVALID OPTION - plays the message "Invalid option" and repeats the instructions.  |
|  | DISABLED KEY - makes pressing a key with this action have no effect, as if the key were never pressed.   |
|  | PLAY PROMPT - plays the indicated voice prompt file. Alternately, you can select a prompt based on its directory location and the specific file name, such as 4:help.vox. The available directories include 1:Modules, 2:Prompts, 3:Messages, 4:VOX, 5:Mailbox, 6:Menus, 7:dBase, 10:Data, and 20:Data.<br><i>For Example ...</i> to have the system play the mailbox greeting for mailbox 123, enter the following as the prompt name: 3:123.GRS. |
|  | PLAY INSTRUCTIONS - replays the instructions prompt, such as, "To hear this menu again press...".  |
|  | RECORD PROMPTS - allows a caller to re-record prompts for a menu. The caller, after pressing the key associated with this action, is prompted for the menu password. The Instruction ( <i>Play Prompt</i> ) file attached to the key, can then be recorded or edited.  |
| HANGUP - plays the message "thank-you for calling" prior to disconnecting the caller.<br><i>For Example ...</i> a menu might include this option at the end of a list, "press [4] for sales, [5] for support, [#] to return to previous menu, and [9] to hang up". |  |

## Time Control Menus

Time Controls can be used to route calls, send callers to voice mail, and play menus based on time and day settings. Up to 10 separate time periods can be defined within a time control setting, allowing you to make a time control as simple or as complex as you wish.

Time Control searches by date, then day, then time. Time Controls can be chained together to allow more than ten day/time options. The Time Control menu displays time control names and descriptions.

### To Add a New Time Control:

1. Under the *Time Controls* directory, click "Add New Time Control".
2. Enter the name you want to link to this Time Control.
3. Then enter a general description that will further identify the Time Control.
4. To use another Time Control as a TEMPLATE, select a previously created Time Control listed in the dropdown box. This option will copy over all Time Control settings to the new Time Control for easier editing.

### To Delete a Time Control:

1. Click in the "Name" field, a dropdown box will appear on the right.
2. Click on the arrow to display the Time Controls available.
3. Select the Time Control you want to remove, then click the DELETE button.
4. When the "Delete Time Control" window displays, click YES to confirm this action.

### Editing the Time Control List

Double-click on "Time Control List" and the available time controls will display. From here you can select the time-sensitive rule parameters you want to change.

| TIME CONTROL Options   | Description   |
|------------------------|---|
| <b>GENERAL</b>         | The <i>In-Skins Admin</i> program comes preloaded with these commonly used time controls: 7TO4/8TO5/9TO5.   |
| Name                   | Enter a short name that will be used to reference the new time control.   |
| Description            | Enter a description that further identifies the time control.   |
| <b>RULES 1-10</b>      | Allows you to set up TC parameters for 10 different rules.  |
| Start Date<br>End Date | Enter a start and end date, using the MM/DD format (01/01 through 12/31), to indicate specific start and end dates to which the time control will be applied.<br><i>NOTE</i> . . . when specifying date and time, leaving either field blank means you want the option to apply to ALL dates. |
| Start Time<br>End Time | Enter a start and end time, using the 24-hour format (00:00 through 23:59), to indicate the specific times during the day that the time control will be active.   |
| Day of Week            | When the "Edit Days of Week" window displays, click on each day to which the time control item should apply, then click OK.   |
| What To Do             | When the "What to Run" window displays, select the specific action to be performed during the indicated dates, days of the week, and hours during the day from the drop-down list. Refer to " <i>Menu Options</i> " on page D-26 for a description of these actions.                          |

| TIME CONTROL Options                     | Description  |
|--|--|
| - TIME CONTROLS, cont'd -<br>Time Period | Enter a number from 1-9 to distinguish between different time-related events within a time control. The time period is most often used to control which mailbox greetings will play when a mailbox is reached. Typically, the system uses 1 for daytime, 2 for evening, and 3 for weekend. If in doubt, set Time Period to 1.<br><br><i>NOTE ... A 10th time period can be used to "chain" time controls together.</i> |

## System List Options

An administrator can create a system list for a specific group of mailboxes. The list can then be used to send certain messages of interest to only those individuals (e.g., Sales or Support).

### To Add a New System List:

1. Under the *System List* menu, click "Add New System List".
2. Enter the number you want to link to this System List.
3. Then, enter a general description that will identify the System List.

### To Delete a System List:

1. Click "Delete System List," then click in the "Number" field.
2. Click on the dropdown arrow, and select the previously created System List you want to remove from the system.
3. Click the DELETE button, then click YES when the confirmation window displays.

### Editing a System List

The "Manage List" area will not appear until you click on the newly created list in the left window pane. At that time, you will be to Add and Delete members to the list.

*For the Add a New Member area:*

1. Select the "Click to Add" field.
2. When the "Add New Members" window displays, either double-click on each mailbox you want to add to the list, or select each item and click the ADD MEMBER button.  
You can also select SHOW LISTS or SHOW MAILBOXES to display other lists or mailboxes.
3. When all members have been added, click OK. The mailboxes you selected will appear in the Members area.
4. Make sure you click the SAVE button to retain your selections.

*For the Delete Members area:*

1. Select the "Click to Select" field.
2. When the "Delete Members" window displays, you can either double-click on each mailbox you want to delete, or select an item and click the REMOVE MEMBER button.
3. When all members have been deleted, click OK. The mailboxes you selected will no longer appear in the Members area.
4. Click the SAVE button to update the system with your changes.

### Members

The "Members" area displays the mailboxes linked to the system list you selected. From this same area, you can delete a member from a list by clicking on their mailbox. To delete a member ... click OK when the system asks you to confirm your delete action.

## System Line Menus

The Voice Lines window allows you to view voice line actions. The feature defines how the voice mail system will answer incoming calls. Clicking on "How to Answer" for the appropriate line, will display the System Line options where you can specify the actions for the line you selected.

| SYSTEM LINE Options | Description  |
|---------------------|--|
| <b>DEFAULT LINE</b> |  |
| How to Answer       | Click on the ELLIPSES button [...] to open the "What to Run" window. Then select which module you want the system to follow. When available, the appropriate options will also display. Refer to "What to run, modules" on page D-27.  |
| PBX Name            | STSe system, by default  |
| <b>LINE (1-8)</b>   |  |
| How to Answer       | The Voice Lines function displays the number of voice lines for which your STSe system installation is configured.<br>Refer to description above ...   |
| Event Group         | The system allows you to group lines that can handle certain types of outbound tasks. Leave this setting blank for lines that will not handle outbound tasks. Typically, 5 is used for basic notification, paging, and MWIs. Values = 0-9  |
| Blockage Group      | This setting allows you to monitor the voice mail traffic. Each line can be placed in a "Blockage" group so that when all of those lines are busy, no new calls will be received. The information may be used to verify that voicemail has enough ports to support your company's call traffic. Values = 1-9 |
| PBX Name            | STSe system, by default  |

## System Configuration Menus

In the left window, double-click on "System Configuration" to display other menu choices. Then select the desired menu: Module, Registry, License, IP Addressing, or KSU Clock Control.

| SYSTEM CONFIGURATION   | Description   |
|------------------------|---|
| <b>MODULE SETTINGS</b> | The system uses this information to determine how many digits to expect when asking a caller for a mailbox, extension, or password. |
| Digit Lengths          | MAILBOX LENGTH - maximum digits = 7 / default = 3   |
|                        | EXTENSION LENGTH - maximum digits = 7 / default = 3   |
|                        | PASSWORD LENGTH - maximum characters = 9 / default = 4  |

*Hard Drive-Based Voice Mail*

| SYSTEM CONFIGURATION                           |                        | Description   |
|--|------------------------|---|
| - MODULE SETTINGS, cont'd -<br>Record/Playback |                        | MINIMUM RECORD LENGTH (seconds) - determines the shortest allowable length of a recorded message. If minimum message length is set too short, you may receive a disconnect tone. Range = 1-999 / Default = 2  |
|  |                        | TRUNCATE RECORDING (x10 msec) - determines how much time the system trims from the end of a mailbox message whose recording was terminated by a silence or tone detection. (0 is recommended)   |
|  |                        | RECORD TONE LENGTH - determines the duration of the beep tone that the system gives callers before recording a message. Default = 0.2 secs  |
|  |                        | FF AND REW SPEED (x1/10 sec) - determines the time intervals that are skipped in a message when the designated REW (6+7) or FF (6+8) keys on the telephone key pad are pressed. The recommended interval is 50 to 100 tenths of a second. Range = 0-999 / Default = 50  |
| Auto-Attendant                                 |                        | CALL ATTEMPT INTERVAL (seconds) - specifies the amount of time before the system retries an extension when a caller is in queue. A 10 - 20 second interval is recommended. Call Queue Interval is dependent on the extension's COS. Range = 1-999 / Default = 30  |
| Voice Mail                                     | <i>Message Cleanup</i> | TIME OF DAY - specifies when the voice mail system is to delete messages that have exceeded the retention period. Format = hh:mm AM or PM   |
|  |                        | DAY OF WEEK - performs this housekeeping function at the time specified for each day of the week selected. Message Cleanup should occur when the phone system is inactive (i.e., midnight to 3:00 a.m.)   |
|  | <i>Other Settings</i>  | MWI REFRESH TIME - should be set for a time to ensure all message waiting indicator lights are correct.   |
|  |                        | QUICK JUMP DTMF KEY - specifies the touch-tone key a caller can press to bypass leaving a message once a mailbox greeting has begun. Default = #  |
|  |                        | PAGER MAILBOX DELAY, secs - specifies the amount of time the voice mail system delays when dialing a pager number for notification. This value defines the delay after dialing the pager number and before dialing the mailbox number. If using a command file for notification, this value is not used. Default = 10 |
|  |                        | PASSWORD ATTEMPTS - number of times a caller is allowed to try entering a valid password. After this number is exceeded, the system can be programmed to take a programmable option. Default = 2  |
|  |                        | NOTIFICATION SEND KEYS - are a series of DTMF key signals that the system sends with the message notification that cancel the incoming channel and end the loop. Since the keys are sent for all voice notifications, some users may find this a nuisance, and the recommended setting is "blank."                    |

| SYSTEM CONFIGURATION                                | Description   |
|---|---|
| <p>- MODULE SETTINGS, cont'd -</p> <p>Directory</p> | <p><i>Type of Directory:</i></p> <p>LIST MODE - this default mode provides a caller with all matching entries in a complete list. The caller can enter an extension or mailbox number at any time during the list playback.</p> <p>PAGE Mode - gives the caller several matching entries, then a caller must press a key to go to the next page, or set, of entries.</p> <p>SINGLE MODE - presents the caller with a list of all matching entries, one at a time. Callers must press a key to indicate whether they want to select the most recently read name, or hear the next matching entry.</p> <p>MAXIMUM KEYS - the number of digits a caller can enter before the system begins to look up directory entries. Range = 1-999 / Default = 4</p> <p>MAXIMUM WAIT, secs - the amount of time the system waits for the Maximum Keys while a caller is entering the numbers to spell the subscriber's name on the keypad. Range = 1-999 / Default = 8</p> |
| <p>Operators</p>                                    | <p>GENERAL OPERATOR TRANSFER STRING - sends callers dialing [0] to the previously selected number as a blind transfer. (string = "&amp;, 0" (Hookflash, Pause, 0))</p> <p>VOICE MAIL OPERATOR - determines what happens when a caller presses [0] while using voice mail. If an operator is designated, a time-out or [0] key pad entry transfers the caller to the designated operator. The operator can then provide caller assistance.</p> <p>AUTO-ATTENDANT OPERATOR - determines what happens when a caller presses [0] while using the auto-attendant module. If zero is indicated, the system uses the General Operator setting for any [0] dialed.</p>  |
| <p>Logging</p>                                      | <p>These settings allow you to select which modules send information to the log files.</p> <p>WHAT TO LOG - The raw data is a chronological history of all events that occur in the STSe system and can be used to evaluate real-time activity. Data includes:</p> <ul style="list-style-type: none"> <li><input type="checkbox"/> time, date, line, module, and a description of each event.</li> <li><input type="checkbox"/> items that can be formatted into reports to help measure performance. Changing these selections may alter certain reports, refer to "<a href="#">Log Reports</a>" on page D-50 for details.</li> </ul> <p>WHAT TO DEBUG - Module debugging is a sophisticated diagnostic tool used to resolve problems with the STSe system. DO NOT run STSe with module debugging turned on, as it can slow performance. Use debugging only as needed.</p>   |
| <p>Retries &amp; Timeouts</p>                       | <p>CALLER RETRY ATTEMPTS - Number of times a caller can retry entering an option. Range = 1-999 / Default = 3</p> <p>OWNER TRY ATTEMPTS - Number of times a mailbox owner is permitted to retry entering an option. Range = 1-999 / Default = 2</p> <p>INTERDIGIT TIMEOUT, secs - Length of time between digits. Used in cases where the length of the entry is unknown. Default = 5</p> <p>SINGLE DIGIT TIMEOUT, secs - Length of time that a caller can press a digit before STSe assumes the digit is being repeated. Default = 2</p>  |

| <b>SYSTEM CONFIGURATION</b>        | <b>Description</b>   |
|------------------------------------|--|
| <b>REGISTRY SETTINGS</b>           | The Registry contains system variables that control the behavior of the voice mail system.   |
| Registry List                      | For a complete list of the registry items that come with a new <i>STSe</i> system, contact Vodavi Technical Support.   |
| <b>LICENSE VIEWER</b>              | The License Viewer displays "Read Only" information. This data cannot be changed.  |
| Language                           | When available, the system can provide language support for both English and Spanish. To use this feature, the optional multilingual module and language prompts must be purchased separately.   |
| Voice Ports                        | This field shows the total number of ports on the voice mail card (8).   |
| KSU Serial Number                  | When available, this field shows the identification number of the KSU.   |
| KSU System Type                    | This field identifies the name of the voice mail system. Default = <i>STSe</i>   |
| KSU Version                        | When available, this field shows the KSU software version.   |
| <b>IP ADDRESSING - VM SETTINGS</b> | The IP Addressing area does not need to be completed, unless you plan to use your internal Local Area Network (LAN) for faster downloads and file transfers.   |
| Network Name                       | In this area, you can enter the name of the network, and also change it as needed.   |
| New Name                           |  |
| Use DHCP Server                    | When the DHCP Server value is set to YES, a LAN server machine will automatically locate the IP Address, Subnet Mask, & Gateway Address and send it to the In-Skins Admin computer.  |
| IP Address                         |  |
| IP Subnet Mask                     |  |
| Gateway Address                    |  |
| <b>KSU CLOCK CONTROL</b>           | This setting allows you to change the application that runs, for inbound calls, whenever the KSU is put into different modes (or time periods). You will also need to set up each line that should be controlled by the KSU clock setting.                       |
| Daytime Action                     | Click on the ELLIPSES button [...], the "What to Run" window will display. Select the module you want the system to follow, when available, the appropriate options will also display.   |
| Nighttime Action                   |  |
| Special Action                     |  |
| <b>CHECK INI FILES</b>             | This wizard interface is used to check the current INI and database settings to make sure they remain consistent. First run the wizard in "Report" mode and review the modifications indicated. Then run the wizard in "Fix" mode to actually apply the changes. |



## Report Options

The *In-Skins Admin* Reports menu allows you to generate various reports and system logs to help with maintaining and troubleshooting the voice mail system. The types of reports are: Activity, Settings, Company Directory, Logs, Messages, and Greetings & Signatures. To see examples and suggested uses for these reports, refer to [“System Maintenance” on page D-44](#).

### Setup Reporting Menu

The “Setup Reporting” option will let you choose the number of lines to print per page, and if the report should have a header. By default, the *Notepad* application is used to view reports.

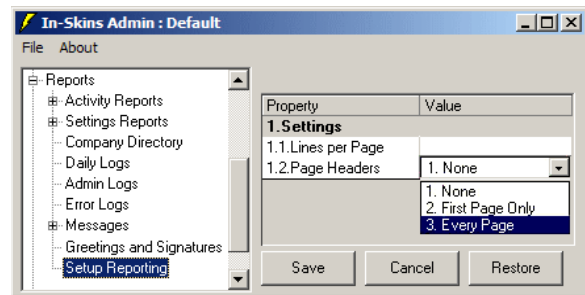

### Running a Report

After clicking the RUN REPORT button, the “Generating Report” window will display a general system message until the report is finished. Depending on the report/parameters selected, the processing time could take a few seconds or several minutes to complete.

The voice mail system will then send the report to the following directory on the *In-Skins Admin* PC ... c:\Program Files\IsAdmin\Host\_Data

## System Status

This “View Only” menu can be used to monitor the status of the active phone lines connected to the voice mail system.

The “System Status” window displays the following information:

- ❑ Each active line number and its current call status.
- ❑ Number of calls taken for that day, and the total call duration.

| Line | Status                        | Call Count | Duration |
|------|-------------------------------|------------|----------|
| 001  | Vodavi Digital: Wait for Call | 9          | 00:01:18 |
| 002  | Vodavi Digital: Wait for Call | 1          | 00:00:09 |
| 003  | Vodavi Digital: Wait for Call | 0          | 00:00:00 |
| 004  | Vodavi Digital: Wait for Call | 0          | 00:00:00 |
| 005  | Vodavi Digital: Wait for Call | 1          | 00:00:05 |
| 006  | Vodavi Digital: Wait for Call | 0          | 00:00:00 |
| 007  | Vodavi Digital: Wait for Call | 0          | 00:00:00 |
| 008  | Vodavi Digital: Wait for Call | 8          | 00:01:22 |
| 009  | MsgMan: Wait (3)              | 0          | 00:00:00 |

## File Manager

The File Manager menu is an easy way to access the voice mail system files. This menu can be used to launch a system application, or to help with troubleshooting.

*Example* ... after reporting a problem to Vodavi Technical Support, you might be asked for a particular system file for diagnostic purposes.

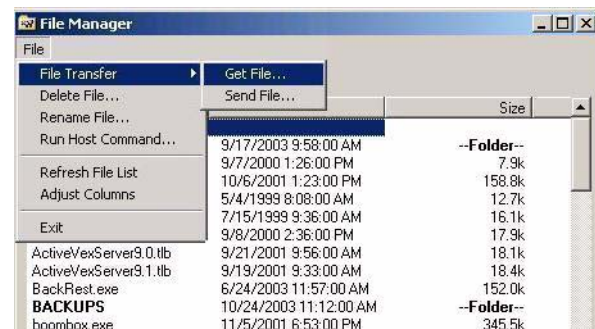

Double-click on File Manager. When the window displays, first click on the specified file. Then go to: File>File Transfer>Get File. After the requested file is downloaded, you can send it to Technical Support for review.

## Programming System Functions Via Telephone

After connections are established, the system is ready to accept calls. You can either use the Laptop Administration or Telephone Administration (*has limited access*) to configure the voice mail system. This section describes Telephone Administration.

### Administrator Login

To access the system as an Administrator, perform the following steps:

1. Dial any extension number connected to the voice mail system.
2. Once you hear the main greeting, press [7] to access the voice mail system and enter a mailbox number.
3. When prompted, press [\*] followed by the password. The default password is 0000.
4. Press [7] again to access Administrator functions. If the mailbox is not in the supervisor Class of Service, the system will prompt for the administrator password. The default administrator password is [2275]. The password must be entered within 3 seconds.



*With Telephone Administration, data is entered only through a touch-tone telephone. The Admin Password can be changed in the Registry (only by using the laptop/PC). If you have not configured your phone system, do so now. Refer to "System Configuration Menus" on page D-31 for more information.*

5. After logging in, you will be prompted to select one of the following menus:
  - [1] Record Prompts
  - [2] Administer Mailboxes
  - [4] Administer Distribution Lists
  - [5] Administer Broadcast Messages
  - [8] System Administration

### System Administrator Menus

#### Record Prompts Options [7+1]

The Record Prompts feature lets a System Administrator edit the following types of prompts:

- Menu Prompts*      instruct a caller of the keys to press for different options.
- System Prompts*    are used for basic system functions such as: instructions for the voice mail or auto-attendant module. (These prompts can be customized.)
- Mailbox Signatures* are the recorded names associated with a specific mailbox.

#### Editing Menu Prompts

1. At the Main Menu, press [7] to access the Administrator functions.
2. Press [1] for Record Prompts.
3. Press [1] to select Edit Menu Prompts.
4. Enter the desired menu number, followed by [#]. Default menus are 100-179.
5. Select the desired action, and press [#] when finished.
  - [1] to hear greeting
  - [2] to re-record
  - [3] to delete

### *Editing System Prompts*

Editing System Prompts allows re-recording of default system prompts. Refer to [Table D-2](#) for a list of the customizable prompts used while in the Record Prompts option of the Administrative functions. All prompts are located in the VOX directory. Record new information to replace the default prompt, or create a blank prompt (with one byte of data) to suppress certain prompts.

1. At the Main Menu, press [7] to access the Administrator functions.
2. Press [1] for Record Prompts.
3. Press [2] to select Edit System Prompts.
4. Enter the prompt number to re-record, followed by [#]. Default prompts are 001-023.
5. Select the desired action, and press [#] when finished.
  - [1] listen to current system prompt
  - [2] to re-record the current custom prompt
  - [3] to delete the custom system prompt

### *Editing Mailbox Signatures*

1. At the Main Menu, press [7] to access the Administrator functions.
2. Press [1] for Record Prompts.
3. Press [3] to select Edit Mailbox Signatures.
4. To record a signature, enter the mailbox or list number for a group of mailboxes, followed by [#]. The system will play the current signature for that entry.
5. Select the desired option, and press [#] when finished.
  - [1] to hear name
  - [2] to re-record
  - [3] to delete
  - [#] when finished

### **Mailbox Administration Options [7+2]**

Mailbox Administration resets mailbox passwords, creates and deletes mailboxes. With this option, the administrator controls and changes the subscriber's mailbox actions.

#### *Resetting the Mailbox Password*

1. At the Main Menu, press [7] to access the Administrator functions.
2. Press [2] to select Administrator Mailboxes.
3. Press [1] to reset the mailbox password.
4. Enter the mailbox number followed by [#]. The system will play the current password.
  - a. To leave password as entered, press [#]. The system will confirm that the password has not been changed and return to Mailbox Administration.

-or-

  - b. To change password, enter the new password followed by [#]. After the system repeats the new password, press [#] to confirm. You will return to Mailbox Administration.

### *Changing the Mailbox COS*

1. At the Main Menu, press [7] to access the Administrator functions.
2. Press [2] to select Administrator Mailboxes.
3. Press [2] to change the mailbox COS.
4. Enter the mailbox number followed by the [#] key. The system will play the current class of service.
  - a. To leave class of service as entered, press [#]. The system will confirm that the class of service has not been changed and return to Mailbox Administration.  
-or-
  - b. To change the class of service, enter the new COS followed by [#]. After the system repeats the new class of service, press [#] to confirm. You will return to Mailbox Administration.

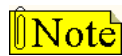

Refer to *"Class of Service Menus"* on page D-18 for more information on the available COS options.

### *Recovering Deleted Messages from a Mailbox*

1. At the Main Menu, press [7] to access the Administrator functions.
2. Press [2] to select Administrator Mailboxes.
3. Press [3] to recover a mailbox's deleted messages.
4. Enter the mailbox number followed by [#].
  - a. If the mailbox HAS NO deleted messages, the system will confirm that no deleted messages were found for that mailbox and return to Mailbox Administration.  
-or-
  - b. If the mailbox HAS deleted messages, the system will confirm the number of deleted messages found for that mailbox. Press [#] to proceed with message recovery. When finished, the system will return to Mailbox Administration.

### *Adding a Mailbox*

1. At the Main Menu, press [7] to access the Administrator functions.
2. Press [2] to select Administrator Mailboxes.
3. Press [5] to add a mailbox.
4. Enter the mailbox number to add followed by [#]. The system will confirm that the mailbox was added and return to Mailbox Administration.

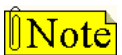

*BEFORE* you can add mailboxes via the telephone ... a template mailbox must have been defined in the Registry using PC/Laptop Administration. Refer to *"Registry Variables"* on page D-53 for more details.

### *Deleting a Mailbox*

1. At the Main Menu, press [7] to access the Administrator functions.
2. Press [2] to select Administrator Mailboxes.
3. Press [6] to delete a mailbox.
4. Enter the mailbox number to delete followed by [#].
5. After the system repeats the mailbox number you selected, press [#] to confirm. You will return to Mailbox Administration.

***Distribution List Options [7+4]***

A distribution list is a collection of mailboxes assigned a group number. A message can be sent to a group of mailboxes using one list number. Thus, distribution lists simplify sending messages to groups of subscribers.

***Adding a New Distribution List***

1. At the Main Menu, press [7] to access the Administrator functions.
2. Press [4] to select Administrator Distribution Lists.
3. Press [1] to add a new Distribution List.
4. Enter the system list number to add followed by [#]. The system will confirm the list number created. When prompted, select one of the following:
  - a. Press [\*] to access the Edit a Distribution List menu for further instructions.  
-or-
  - b. Press [#] and the system will return to Distribution List Administration.

***Deleting a Distribution List***

1. At the Main Menu, press [7] to access the Administrator functions.
2. Press [4] to select Administrator Distribution Lists.
3. Press [2] to delete a Distribution List.
4. When prompted, select one of the following options:
  - a. To delete a list ... enter the desired system list number followed by [#]. After the system confirms the list number to delete, press [#] to confirm. You will return to Distribution List Administration.  
-or-
  - b. To hear existing list numbers ... press [\*]. After selecting the desired list number, press [#] to go back, then press [2] to Delete a Distribution List.

***Editing a Distribution List (add members)***

1. At the Main Menu, press [7] to access the Administrator functions.
2. Press [4] to select Administrator Distribution Lists.
3. Press [3] to edit a Distribution List.
4. When prompted, enter one of the following options:
  - a. Enter the number of the distribution list to edit, followed by [#]. The system will confirm your selection.  
-or-
  - b. Press [\*] for a directory of system lists. Enter a list number, then press [#] to validate the number entered. The system will present these options:
    - [1] listen to a directory of members in the list
    - [2] add members to the distribution list
    - [3] delete members from the distribution list
    - [#] return to the Administration menu

**Broadcast Message Options [7+5]**

Broadcast Message Administration plays a currently recorded broadcast message or allows you to create a new one. By default, this menu option places a broadcast message into every subscriber's mailbox in the voice mail system. A system can have up to ten broadcast messages (0-9).

Broadcast messages are different from distribution lists in the following ways:

- Broadcast messages use less disk space.
- A broadcast message automatically plays when a subscriber accesses their mailbox.

*Listening to a Broadcast Message*

1. At the Main Menu, press [7] to access the Administrator functions.
2. Press [5] to select Administrator Broadcast Messages. The system will announce the number of active broadcast messages.
3. Press [1] to hear previously recorded Broadcast Messages. The system will play the active broadcast message numbers. Select the message number to play followed by [#].
4. When prompted, enter the message number you want to hear. The system will play the selected message and then return to Broadcast Message Administration.

*Creating a New Broadcast Message*

1. At the Main Menu, press [7] to access the Administrator functions.
2. Press [5] to select Administrator Broadcast Messages. The system will announce the number of active broadcast messages.
3. Press [2] to create a new broadcast message. The system will play the available broadcast slot numbers. Select which message number you want to use, followed by [#].
4. To create a new message, enter an available broadcast slot. The system will confirm your selection, and then present the following choices:

|                             |                             |
|-----------------------------|-----------------------------|
| [1] send broadcast message  | [4] append to the recording |
| [2] listen to the recording | [5] re-record the message   |
| [3] cancel                  | [#] return                  |

*Cancelling a Broadcast Message (already distributed)*

1. At the Main Menu, press [7] to access the Administrator functions.
2. Press [5] to select Administrator Broadcast Messages. The system will announce the number of broadcast messages that are active.
3. Press [3] to cancel a broadcast message.
4. After listening to the available broadcast messages, select the message number to delete and press [#] to confirm.
5. To delete a broadcast message, enter the desired message number and press [#] to confirm.
6. Press [#] to accept the delete action. The system returns to Broadcast Administration.

### **System Administration Options [7+8]**

With this option, the administrator controls and can modify the operation of the voice mail system, via the telephone.

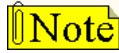

*Changing these settings from default values may cause erratic system operation and may require PC/Laptop Administration to correct.*

#### *Setting Up Voice Lines*

This option determines what functions are available on the voice lines, and determines how lines are answered. Configuring the port numbers is part of the voice line options.

1. At the Main Menu, press [7] to access the Administrator functions.
2. Press [8] for System Administration.
3. Press [1] to select Set-Up Voice Lines.
4. Enter the port number to configure, or press [0] for all ports.
  - a. If you enter the desired port number, the system will confirm the module being used and play the configuration of that line.
  - b. If you press [0] to configure all ports, select one of the following options:

Press [1] and the system will play how each line is set up.

-or-

Press [0] and the system will prompt you to enter the module number that you want to run. After entering the desired module number, press [#] to confirm the change.

The menu choices are:

[1] for Voice Mail (*uses mailbox number*)

[2] for Auto-Attendant (*uses extension number*)

[3] for Menu

[4] for Time Control

Press [#] again to return to previous level, or enter the phone system configuration file. The system will confirm that the "run code" was changed, and then reset itself.

#### *Shutting Down the System*

1. At the Main Menu, press [7] to access the Administrator functions.
2. Press [8] to select System Administration.
3. When prompted, press [3] and select one of the following options:
  - a. Press [1] to shut down and park. The system will reset itself.
  - b. Press [2] to shut down and reboot. The system will shut down and reboot itself.For more details, refer to the ["Shutdown Wizard" on page D-12](#).

#### *Resetting the System Date and Time*

1. At the Main Menu, press [7] to access the Administrator functions.
2. Press [8] to select System Administration.
3. When prompted, press [4]. The system will automatically reset itself, and you will return to System Administration.



## **Automated Attendant Options**

The Auto Attendant menu is accessed using the voice mail main menu. Press [6] for Extended Options on the main voice mail menu to change Auto Attendant functions. Features available to a voice mail owner are dependent on the configuration set by the System Administrator. This section discusses the basic features available to Mailbox Owners.

The Auto Attendant Module performs call transfers without the assistance of a live operator. The voice mail system supports two transfer methods: Direct and Requested.

### **Auto-Attendant Menus**

This shows the menus that are used by the Auto Attendant:

[6] Extended Options

[1] Extension Settings

[1] Immediate Forward to Personal Mailbox

[2] Blind Transfer

[3] Supervised Transfer

[1] Call Screening

[2] Call Holding

[3] Call Screening & Call Holding

### **System Access**

This menu allows a mailbox user to set up and edit the special features that come with the Automated Attendant. Extension features are accessed through the Voice Mail Owner menu.

1. Dial the internal extension or outside phone number.
2. Enter your mailbox number and press [\*].
3. Enter your password and press [6] at the mailbox owner prompt.

### **Call Transfer Options**

The voice mail system transfers calls using several methods. A mailbox user changes the method of transfer through Extension Maintenance.

1. Press [1] for the Extension Settings option.
2. Select the desired transfer option. When the voice mail system forwards a call to an extension the transfer types are:

*Immediate Forward* -- Press [1] ... the voice mail system forwards the call immediately to the mailbox without trying to reach the extension.

*Unsupervised (Blind)* -- Press [2] ... the voice mail system does not monitor the transfer, the call transfers immediately to the extension. In the event the call is not answered, the system does not forward the call.

*Supervised* -- Press [3] ... the voice mail system monitors the transfer. If the call is not answered, it is forwarded. If the System Administrator has allowed the Call Screening or Call Holding functions, the extension can be set to follow these options:

- Set Call Screen - Press [1]
- Set Call Hold - Press [2]
- Set Both - Press [3]
- Call transfers to the mailbox or extension of the person calling in  
(If transfer is Supervised or Immediate Forward, then select where to forward call.)



## Voice Prompts

The following table lists the voice prompts included with the voice mail system.

**Table D-2: Hard Drive-based Default System Prompts**

| Number     | Prompt  | Description  | Filename                  |
|------------|---|--|---------------------------|
| 100        | <i>You have a message to call.</i>  | Preamble prompt that plays in front of a numeric page.   | VOPGPRE.VOX               |
| 101        | <i>Enter the mailbox number of the person you are trying to reach. Press [0] for the operator. Press [*] for the directory.</i>                             | Presents the Voice Mail instructions prompt.   | VMINSTR.VOX               |
| 102        | <i>The person you have tried to reach is not available. Please leave a message after the tone.</i>  | First system greeting, plays if selected in COS.   | VMSYSGRT.VOX              |
| 103        | <i>Begin speaking at the tone. When you are finished recording, you may hang up or press any key for more options.</i>                                      | Second system greeting, plays if selected in COS.  | VMSYSGR2.VOX              |
| 104        | <i>To start recording press [1].</i>  | Replaces the <i>Record Start Key</i> prompt.   | VMRECKEY.VOX              |
| 105        | <i>To send message, press [1]; To play message, press [2]; To cancel message, press [3]; To append message, press [4]; To re-record message, press [5].</i> | Replaces the record option prompt.   | VMRECOPT.VOX              |
| 106        | <i>Enter the first four characters of the person's last name. For Q, press [7]. For Z, press [9].</i>   | Asks for lookup digits in directory.   | DIRGETDI.VOX              |
| 107        | <i>Enter the extension number of the person you are trying to reach. For the company directory press [*]. To reach an operator, press [0].</i>              | Provides auto attendant instructions.  | AAINSTR.VOX               |
| 108        | <i>You have a call.</i>   | Announces that an extension has a call.  | AAHVCALL.VOX              |
| 109        | <i>Call for ...</i>   | Announces a call for a specific extension.   | AACALLFO.VOX              |
| 110        | <i>Who may I say is calling?</i>  | Asks caller to say their name.   | AASCNASK.VOX              |
| 111        | <i>Please hold while I transfer you to ...</i>  | Tells callers they will be transferred.  | AAXFRMSG.VOX              |
| 112        | <i>Please hold. We appreciate your patience ...</i>   | First prompt played when system must place a caller on hold, if selected in COS.<br><br><i>NOTE ...</i> By default, this prompt is not active on the system. | AAHOLD.0                  |
| 113 to 121 | <i>Please continue to hold...</i>   | Hold file(s) played when system must place a caller on hold, if selected in COS.   | AAHOLD.1 through AAHOLD.9 |

## System Maintenance

The System Reports section describes the various system reports and how they might be used. These system reports can help diagnose problems, allocate resources, and improve the voice mail system's efficiency. The types of reports include: Activity, Settings, Greetings/Signatures, Logs Messages, and Company Directory.

### How to Run Reports

You can request specific data when generating a report by:

- First selecting the report type from the *Reports* menu shown on the left.
- Then choosing the report parameters that display on the right.

The fields available will depend upon the type of report being generated.

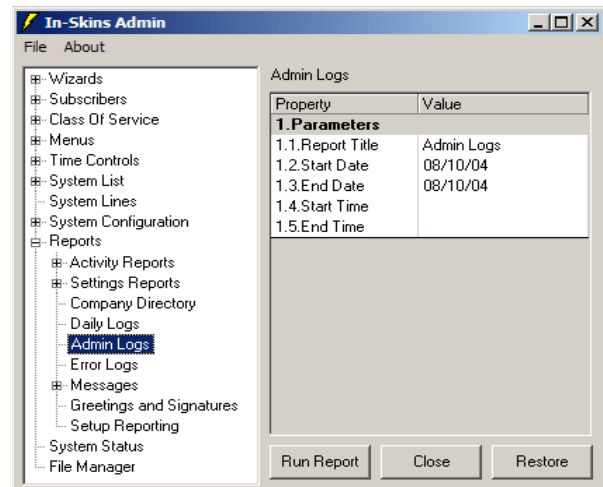

|   |   |
|---|---|
| Report Title                                  | The name of the report selected from the <i>Reports</i> menu will automatically appear in this field. If desired, the report name may be changed.             |
| Date  | Enter the start and stop dates, which must be in MM/DD/YY format. If date fields are left blank, the <i>In-Skins Admin</i> selects all records with any date. |
| Time  | Enter the complete start and stop times in 24-hour format (HH:MM:SS). If left blank, <i>In-Skins Admin</i> selects all records with any time.                 |
| Mailbox, Extension, COS Menu, or Time Control | Use the dropdown lists to select the appropriate first and last items for selection criteria.   |
| Last Name Documents                           | Enter the appropriate selection criteria range for the report you want to generate.   |
| Sort Order                                    | When this option is available, select the order you want to see for that report: Mailbox, Extension, or Name.   |

- All reports are viewed with *Notepad*. This Windows application will allow you to print or save a report.
- In the *Settings* reports, if no data is available for a particular field, that field is not shown in the report.
- When entering selection criteria for a report, the *In-Skins Admin* remembers the last criteria entered in any report and offers that as a default selection.

*For example ...* if you run a mailbox settings report, the mailbox range used in that report appears when you run a different report with a mailbox range criterion.

## Activity Reports

Activity Reports reflect voice mail use. Data for the reports are obtained from the voice mail system logs.

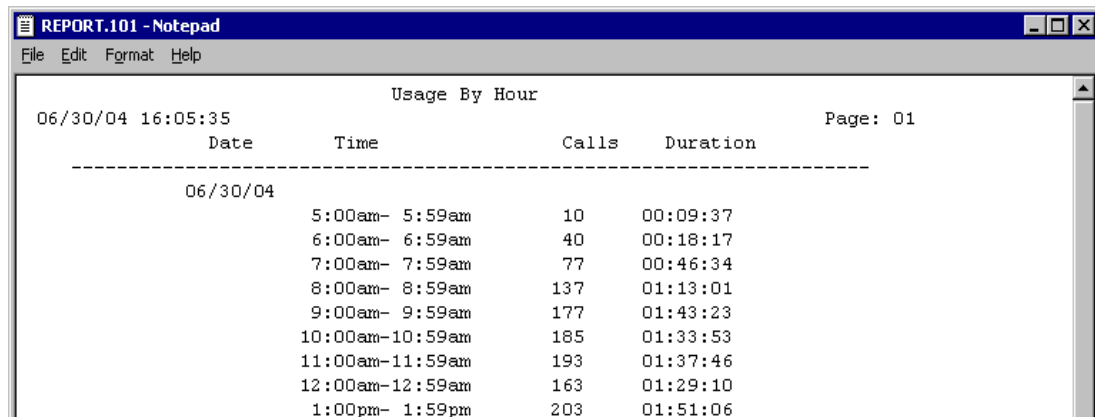

**Call Traffic Usage Report** -- displays call traffic information. You can choose the specific details you want to see by selecting from the following type of reports: Usage by Hour, Calls by Hour, Traffic by 1/4 Hour, Duration by 1/4 Hour, and Simultaneous Traffic by 1\4 Hour.

| Report Data                                | Use   |
|--|---|
| Data sorted by date and time (hour)        | This report demonstrates when the system is the most and least active, the uses include: <ul style="list-style-type: none"> <li><input type="checkbox"/> Determining staffing requirements</li> <li><input type="checkbox"/> Determining volume of after-hours calls</li> </ul> |
| Total number of inbound and outbound calls |   |
| Combined duration of all calls             |   |

**Mailbox Usage Report** -- provides the log lines related to mailbox activity. The report (sorted by date): tracks each time the mailbox was accessed, the length of the message left, and the number of times that the owner accessed the mailbox.

| Report Data  | Use  |
|--|--|
| Mailbox number and name of mailbox owner   | A review of the Mailbox Usage report reveals the amount of activity of each mailbox on the voice mail system. Owners of mailboxes with <i>low activity</i> may not fully understand how to use the voice mail system and may need more instruction. Users with <i>high activity</i> should be reminded to remove messages.<br><br>Take note of the average length of a call. When the average length approaches the maximum message length, the max message length may need to be increased.<br><br>This report can also be used in client bill-back situations (like shared tenant environments) executive suites, or hotels. The report can be output to disk, then imported into a billing program. |
| Message Length (elapsed time of recording)   |  |
| Line that a call came in on  |  |
| Number of messages recorded (Msg Left)   |  |
| Time of mailbox entry  |  |
| Out-dial/Notification events   |  |
| Number of messages retrieved   |  |
| Total Trunk Access   |  |
| Duration between the caller's initial connection, and subsequent hang-up after leaving a message or time required for mailbox owner to retrieve messages |  |

**Extension Usage Report** -- identifies inbound call activity to a specific extension, and describes the results of a call transfer initiated by the voice mail system. The call can either be connected or dropped. A dropped call (either a busy or unanswered extension) may route to a mailbox, operator, or menu. The report, sorted by date, documents inbound calls and their results. The report documents the time the call was made, as well as its duration. In addition, the report documents specific call activity.

| Report Data                              | Use   |
|--|---|
| <i>Possible data includes:</i>           | A review of the Extension Usage report can help with the following: <ul style="list-style-type: none"> <li><input type="checkbox"/> Scheduling agents or operators more effectively</li> <li><input type="checkbox"/> Determining a need for additional phone lines</li> <li><input type="checkbox"/> Identifying subscribers who miss a large number of calls</li> </ul> |
| Answered -- call was answered            |   |
| No Answer -- extension did not answer    |   |
| Busy -- extension was busy               |   |
| Connect -- call was connected            |   |
| No Ring Back - extension did not respond |   |
| Blind Transfer -- call transfer type     |   |

**Menu Usage Report** -- identifies user traffic within menus, indicating what information callers are most interested in by the number of times specific menus are accessed. This can help determine a menu's usefulness and whether the number of channels that allow access to it are sufficient to support the traffic.

| Report Data                                | Use   |
|--|---|
| Selected reporting period                  | This information may be useful to others besides the system administrator.<br><br><i>For example, with the following menu: "Press 1 for information on product X; press 2 for information on product Y ..."</i> the sales manager can determine the number of requests for each option.<br><br>The Menu Usage report includes the total number of requests for each menu key. |
| Selected menu as the subject of the report |   |
| Time of day that the menu was accessed     |   |
| Caller's key selection while in the menu   |   |

**Notification Report** -- indicates the number of times a mailbox was alerted to notification attempts.

| Report Data   | Use  |
|---|--|
| Selected reporting period                               | This information can be used to determine if notifications are being executed in a timely fashion.<br><br>The Notification activity report may be sorted by username, extension, or mailbox. |
| Selected mailbox for the report                         |  |
| Time of day the notification was executed               |  |
| Number of notification attempts                         |  |
| Line number where notification went out                 |  |
| Number of times a caller can initiate an invalid option |  |

## Setting Reports

Settings reports identify various voice mail system settings that were entered during configuration. Information is available for mailboxes, extensions, and menus.

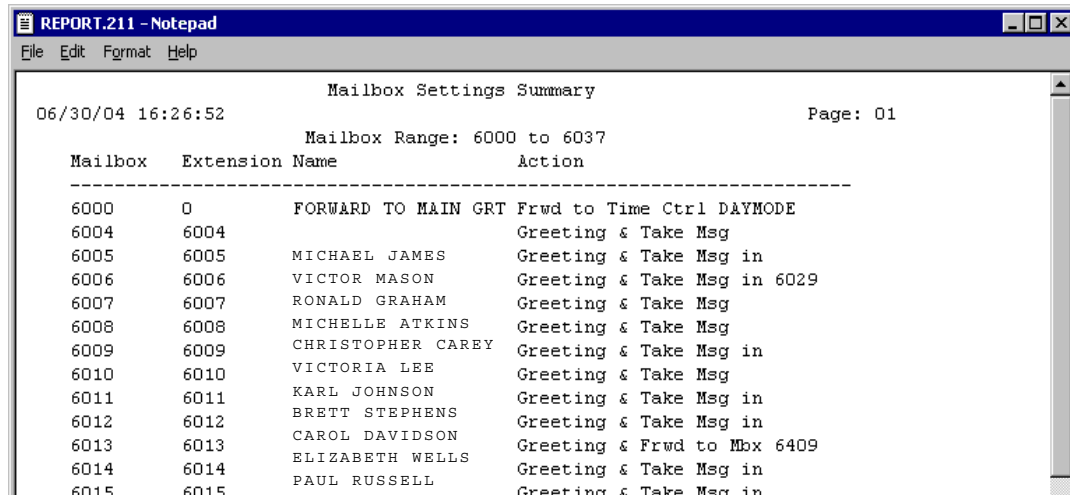

**Mailbox Settings Summary Report** -- outlines the configuration of each mailbox connected to the system.

| Report Data                 | Use   |
|-----------------------------|---|
| Mailbox number              | This information can be used to keep track of all mailboxes on the voice mail system. |
| Associated extension number |   |
| Mailbox owner's name        | The data may be helpful in maintaining mailboxes in a dynamic work environment.       |
| Mailbox state               | The Mailbox Settings Summary report may be sorted by username, extension, or mailbox. |

**Mailbox Settings Detail Report** -- provides an in-depth review of the configuration of each mailbox in the system.

| Report Data                       | Use  |
|-----------------------------------|--|
| Mailbox number                    | This information is helpful in resolving problems with mailboxes.                    |
| Associated extension number       |  |
| Mailbox owner's name              | The Mailbox Settings Detail report may be sorted by username, extension, or mailbox. |
| Mailbox state                     |  |
| Class of service of mailbox owner |  |
| Group (Department)                |  |
| Notification state                |  |
| Password                          |  |

**Extension Settings Summary Report** -- summarizes the configuration of each extension in the system.

| Report Data               | Use   |
|---------------------------|---|
| Extension owner           | This information is helpful in resolving problems with extensions, such as transfer and forwarding problems.<br><br>The Extension Settings Summary report may be sorted by username, extension, or mailbox. |
| Associated mailbox number |   |
| User name                 |   |
| Transfer options          |   |
| Action options            |   |

**Extension Settings Detail Report** -- provides more detailed information about each extension in the system.

| Report Data  | Use  |
|--|--|
| In addition to the information contained in the Extension Settings Summary report, this report also provides the class of service assigned to the extension. | This information is helpful in resolving problems with extensions, such as transfer and forwarding problems.<br><br>The Extension Settings Detail report may be sorted by username, extension, or mailbox. |

**Class of Service Settings Report** -- You can run a report for details on each defined Class of Service.

| Report Data  | Use   |
|--|---|
| Class of service name and description                                | The COS report is used to review and maintain class of service options. |
| General settings   |   |
| Voice mail and Auto-Attendant settings, including notification rules |   |

**Menu Settings Report** -- provides a complete description of each menu and the action programmed for each key.

| Report Data  | Use   |
|--|---|
| Menu name  | The purpose of this report is to describe all of the menu settings in a simple and easy format.<br><br>You can easily determine how the key actions of your menus are configured. |
| Action assigned to each key on the telephone keypad (refer to <i>"MENU ACTIONS"</i> on page D-27 for more information) |   |
| Voice mail and Auto-Attendant settings, including notification rules   |   |

**Time Control Settings Report** -- lists the options for the selected time controls.

| Report Data       | Use  |
|-------------------|--|
| Time Control name | Use this report to review the various time control settings.<br><br>It can be helpful in planning new time controls and maintaining those currently on the system. |
| Description       |  |
| Date              |  |
| Day               |  |
| Time              |  |
| Action            |  |

**Registry Settings Summary Report** -- identifies the various registry settings.

| Report Data   | Use  |
|---|--|
| This report provides a system-wide overview of current Registry settings. | This is a comprehensive report that includes all system settings.<br><br>As such, it is a powerful troubleshooting and supervisory tool for maintaining the voice mail system. |

**Registry Settings Detail Report** -- If you need more information than what is included on the Summary report, you can run a Registry Settings Detail report.

| Report Data   | Use  |
|---|--|
| The Registry Settings Detail report provides the same information as the Registry Settings Summary report, but also includes an explanation of each setting, default values, and the type of registry variable. | This is a comprehensive report that not only includes all system settings, but a description of each.<br><br>As such, it is a powerful troubleshooting and supervisory tool for maintaining the voice mail system. |

**System Distribution Lists Report** -- provides a listing of each system distribution list used on the voice mail system.

| Report Data                | Use   |
|----------------------------|---|
| List Number                | This is a comprehensive report that lists all current system lists which makes it a powerful evaluation and supervisory tool for maintaining the voice mail system. |
| Members' extension numbers |   |
| Members' names             |   |

## Directory Reports

The Directory report gives a listing of all subscribers with their first name, last name, extension number and mailbox number.

```

REPORT.300 - Notepad
File Edit Format Help
06/30/04 16:41:11 Directory Page: 01
Range: All
Name Extension Mailbox
-----
~ ~
6088 6088
6089 6089
4321 4321
5000 5000
----

```

**Directory Reports** -- Company Directory Reports can be generated for the entire directory, or specific name ranges can be designated.

| Report Data  | Use  |
|--|--|
| The <i>Company Directory</i> report associates subscribers with specific mailboxes and extensions. | Print this report regularly and reference it for maintenance.<br>The <i>Company Directory</i> report can also be used to create company telephone lists. |

## Log Reports

Log reports provide information about the voice mail system and system error messages. Logs are used as diagnostic tools to trace voice mail activity, and are primarily used for debugging and technical support functions.

```

REPORT.401 - Notepad
File Edit Format Help
06/30/04 16:42:23 Daily Log Page: 01
Date Range: 06/30/04 to 06/30/04
Time Range: All
-----
06/30/04
A 00:00:00.076 --- Start of Daily Log File 06/30/2004
C 05:41:39.532 33 H!MSGMAN Debug: Event date=<MmNo6035> from MME fil
e=<02052044303.nme>
C 05:41:39.532 33 H!MSGMAN Debug: Event Data <MmNo6035>.
C 05:41:39.532 33 Log: MsgMan No 6035
C 05:41:39.532 33 H!MSGMAN Debug: Issue Notify Mailbox <6035> Option

```

**Daily Log Report** -- provides a detailed listing of the voice mail system activity.

| Report Data  | Use   |
|--|---|
| All entries are listed by time of occurrence and by line number. | Review this report to check on daily the voice mail system activity. This report should not be confused with the Error Log.<br>There are instances, however, when both are used together for diagnostic purposes. |



**Admin Log Report** -- shows all activity resulting from the operation of the voice mail system.

| Report Data                                   | Use  |
|---|--|
| All entries are listed by time of occurrence. | Review this report to check the activity between voice mail and the STSe system, and when the actions occurred.<br><br>This information could be useful when diagnostic data is needed to help resolve program and/or system issues. |

**Error Log Report** -- lists any error messages resulting from the operation of the voice mail system.

| Report Data   | Use   |
|---|---|
| Both hardware and software malfunctions are reported. | Review this report to check on errors in the voice mail system activity.<br><br>Each line of the report shows a specific error condition that has occurred. Each error condition is listed by time of occurrence. |

### Message Reports

Message reports provide the system administrator with a means to determine the current status of messages in voice mailboxes.

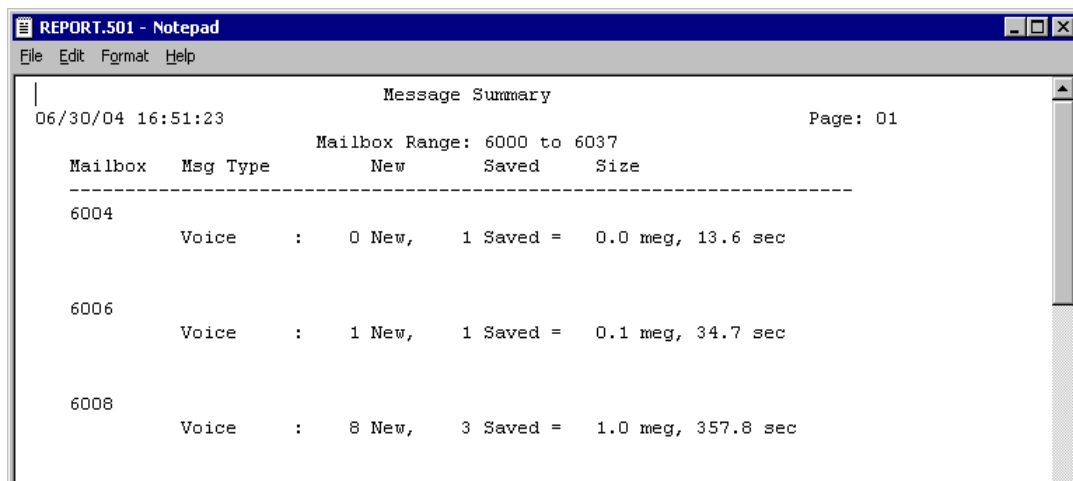

**Message Summary Report** -- summarizes various status conditions for the mailboxes on the voice mail system.

| Report Data                            | Use   |
|--|---|
| Name & mailbox number of mailbox owner | This report shows the total messages stored on the hard drive for each mailbox.<br><br>It can help determine if messages are being stored too long or if the voice mail system resources are being monopolized by any one user. |
| Total number of new messages           |   |
| Total number of saved messages         |   |
| Total time for all messages            |   |
| Total occupied disk space per owner    |   |

**Message Detail Report** -- allows the system administrator to select a mailbox and view its current status.

| Report Data                            | Use  |
|--|--|
| Name & mailbox number of mailbox owner | This report shows all messages that are stored on the hard drive. It can help determine if messages are being stored too long or if the voice mail system resources are being monopolized by any user. |
| N for new message                      |  |
| S for saved message                    |  |
| Mailbox message was sent from          |  |
| Message size in seconds                |  |
| Date and time message left             |  |
| Filename of the message                |  |

## Greetings & Signatures

The Greetings & Signatures report provides the system administrator with a means to determine the amount of time and space being used by each mailbox holder for their recorded greetings and signatures.

```

REPORT.503 - Notepad
File Edit Format Help

                          Greetings & Signatures
06/30/04 16:48:05                               Page: 01
Mailbox Range: 6000 to 6037

Mbx  Type                Seconds Bytes  Date      Time
-----
6000  FORWARD TO MAIN GRT
      Signature           1.9   5K   03/18/98 13:22:09
      Total:              1.9   5K

6004  Greeting               8.7  25K   10/24/94  7:56:04
      Signature           2.7   8K   01/09/95  8:54:05
      Total:              11.4  33K
  
```

**Greetings & Signatures Report** -- allows the system administrator to monitor the length and size of mailbox owners' greeting and signature files.

| Report Data                        | Use  |
|------------------------------------|--|
| Mailbox number or range of numbers | This report is another tool that the system administrator can use to analyze and control the proper distribution of voice mail system resources. |
| Type of mailbox greeting           |  |
| Total recorded time and file size  |  |

## Command Files



**IMPORTANT:** Before attempting to change the Command Files for your STSe system ... **Contact Vodavi Technical Support** for assistance.

Command Files are used to expand the basic system to meet the needs of special notification/paging systems, phone systems, TIE lines, and special installations. The voice mail system Command Files can be used in the following areas:

- mailbox notification
- extension forwarding
- directly from a menu

### **Pager Notification Timing**

When creating a command file for pager notification, the timing of the digits to be sent from the voice mail system to the pager is critical. The command file must be synchronized with the timing of the pager being used. You will need to take the following actions:

FIRST ... Call the paging company to determine the timing of the pager.

NEXT ... Calculate the amount of time from when you dialed the last digit to the pager company and the time the pager company asks for the digits to be sent to the pager.

THEN ... Modify Sleep time to same time you calculated for digits to be sent to the pager.

### **Pre-defined Command Files**

The self-contained voice mail unit has several pre-defined command files that are located in the \HELLO\CFFILES subdirectory.

- » The file names are: PAGER10.CF, PAGER12.CF, PAGER14.CF, PAGER16.CF, PAGER18.CF, PAGER20.CF, PAGER22.CF, PAGER24.CF, PAGER6.CF, and PAGER8.CF.
- » The numeric portion of the name indicates the number of seconds between dialing the pager number and sending the mailbox digits to the paging company.

## Registry Variables

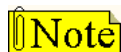

**IMPORTANT:** Before attempting to change the Registry Settings for your STSe system ... **Contact Vodavi Technical Support** for assistance.

The Registry is a database of settings that controls how the voice mail system operates. By making changes to settings in the Registry, you can affect how the system will perform.

- » You can make changes to the Registry using the *In-Skins Admin* program, or any communications package that supports ANSI terminal emulation (e.g., ECom).
- » After making changes to the Registry that affect the system, the voice mail system may need to be restarted for the changes to take effect.

## Troubleshooting

### Technical Support

#### **Running Diagnostics on the Hard Drive-based Voice Mail ...**

If you experience any problems with the voice mail system, the best way to diagnose the system is to connect a monitor and USB mouse and USB keyboard directly to the *Hard Drive-based Voice Mail* card. This will allow you to watch the the data generated by the different voice mail applications more closely, and help to isolate where the problem appears.

- » The colors and images on the PC monitor may appear blurry unless you change the monitor's resolution to: 1024 X 768.

#### **Adding a USB Modem to the In-skins Device ...**

In addition to the device you are connecting, you will also need a powered USB hub, USB mouse, USB keyboard, and VGA display. It is suggested that you use a D-Link DUB-H4 hub. You will also need a method for getting the new device's drivers to the inskins system. You can use a USB thumb-drive or a network shared drive/folder.

Complete the following steps:

1. Connect the powered hub to the Inskins card.
2. Connect a monitor to the In-skins device.
3. Connect a USB keyboard and mouse through the USB hub.
4. Make sure you have video, keyboard and mouse control of the in-skins device.
5. In this order, shutdown Process-Monitor, PathFinder and DataServer.
6. Open up a DOS window and execute the following command:

#### **ewfmgr c: -commit**

This command tells the system to retain any changes made to the operating system configuration.

7. Using a PC and a USB thumbdrive or a network share, copy the new USB device drivers or installation files to a new folder on the D: drive.
8. Follow the directions for the USB device to install it. Assume you are installing on XP Professional.

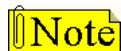

*For the USB to serial port adapters, you should connect them directly to the USB port on the InSkins card. If they are connected to the USB hub, then the system will not detect them on reboot. You should connect USB mouse, keyboard and modems to the hub.*

9. Once the device has been installed, you should restart the in-skins device so that all of the configuration changes can be written to the hard drive.
10. Once the system has rebooted, test the new device. If new changes need to be made, make sure you re-run the "ewfmgr c: -commit" command to make them permanent before rebooting.

*For more information on managing devices on in-skins, see the FAQ on device management.*

**Starting the In-Skins Admin Program ...**

If you cannot start the *In-Skins Admin* program:

- » Make sure your cable connections are secure.
- » Verify that the COM port settings in Windows "Control Panel" have a baud rate of 115,200.

**Shutting Down and Resetting the System ...**

The "reset button" on the voice mail card will allow you to reset the voice mail system, but not the KSU. This button is located between the network jack and the serial port jack.

**HyperTerminal Boot Up Messages**

During the boot up sequence (after the Windows o/s has loaded), the *PathFinder* boot steps are executed. During this time, the system will send small information messages out through the RS-232 port at a speed of 115.2k, N, 8, 1.

If you connect a PC running a terminal communications program (e.g., HyperTerminal), you will see system messages similar to the following:

```
2004.06.30 15:01:14 Starting system
2004.06.30 15:01:16 EWF Restore
2004.06.30 15:01:20 Checking for updates
2004.06.30 15:01:22 Starting DigiTalk drivers
2004.06.30 15:01:24 Registering all components
2004.06.30 15:01:26 Reindexing data files
2004.06.30 15:01:37 Creating folders and configuring IP
2004.06.30 15:02:21 Starting PathFinder
2004.06.30 15:02:22 Starting DataServer
```

---

## User Operations

This section describes how a mailbox owner can use the features of the voice mail system system.

### *How to Use the Voice Mail System*

After entering the voice mail system, you will be prompted to make selections from a list of options that will allow you to move through the system and access the desired mailbox or voice mail function.

#### **Menu Structure**

A menu is a group of features or selections that may be accessed from the dialpad of any touch-tone telephone by pressing [0-9], [#], or [\*].

*For example ...*

- When a mailbox number is entered, the system will respond: "Press [1] to retrieve messages. Press [2] to send a message. Press [8] for personal options."
- When you select [8] for personal options, the system will offer general topics such as: "Press [1] to edit greeting. Press [2] to change your password."

#### **Special Keys**

Special navigation keys can be used to perform various actions based on the function selected. The designated keys are: \*, #, 9.

##### **[\*] Key**

Pressing the [\*] key will allow you to perform the following types of functions:

- » Replay the current menu options.
- » Select other related menus when available.
- » As a new user, pressing the [\*] key multiple times will replay the menu choices in order to become more familiar with the system.

##### **[#] Key**

Pressing the [#] key will allow you to perform the following functions:

- » Complete a step (*lets the system know you are finished*).
- » Return to the previous menu.
- » Send a voice message.
- » Confirm a selection (*allows you to change an entry*).

##### **[9] Key**

Pressing the [9] key will hang up or disconnect your phone from the voice mail system.

## Getting Started

### Setting Up Your Mailbox

You will need the following information from your system administrator in order to set up your mailbox: the number to reach the voice mail system, your mailbox number, and your temporary default password.

Once you obtain this information, follow these steps:

1. Call in to the voice mail system: \_\_\_\_\_ (example ... dial 440 for the voice mail group).
2. Once connected, you will hear the system greeting.
  - a. Press [\*] and enter your mailbox number.
  - b. Then enter your default password: \_\_\_\_ (0000).
3. When prompted, press [8] for Personal Options, then press [2] to Edit Password.
  - a. Enter your new 4-digit password number followed by [#].
  - b. Press [#] again to confirm your entry.
4. When the Personal Options menu returns, press [3] to Edit Name.
  - a. Then press [2] to record your name.
  - b. Press [#] when finished recording.
5. When the Personal Options menu returns, press [1] to Record Greeting.
  - a. Press [1] again for the Standard Greeting options.
  - b. Press [2] to record your standard greeting.
  - c. Press [#] to stop recording.

Your mailbox is now set up and ready to use.

### Accessing Your Mailbox

You can access your mailbox by either calling into the voice mail system, or by calling directly to your telephone number / personal mailbox.

#### **When Calling to the Voice Mail System:**

1. Dial the internal extension or outside phone number of the voice mail system.
2. Once you hear the system greeting, enter your mailbox number.
3. When prompted, enter your password.

Upon entering your mailbox, the system will:

- a. let you know the number of new and saved messages in your mailbox.
- b. list the Main Mailbox Menu options for you to choose your next action.

#### **When Calling to Your Telephone Number / Personal Mailbox:**

1. Call your telephone number / personal mailbox.
2. When you hear your mailbox greeting, press [\*].
3. Enter your password. The system will then tell you how many new and saved messages you have, and then play the Main Mailbox Menu.

### Message Options

Voice Messaging allows users to send and receive voice messages. This eliminates “telephone tag” and increases productivity. The following drawing shows the menu structure for voice messaging.

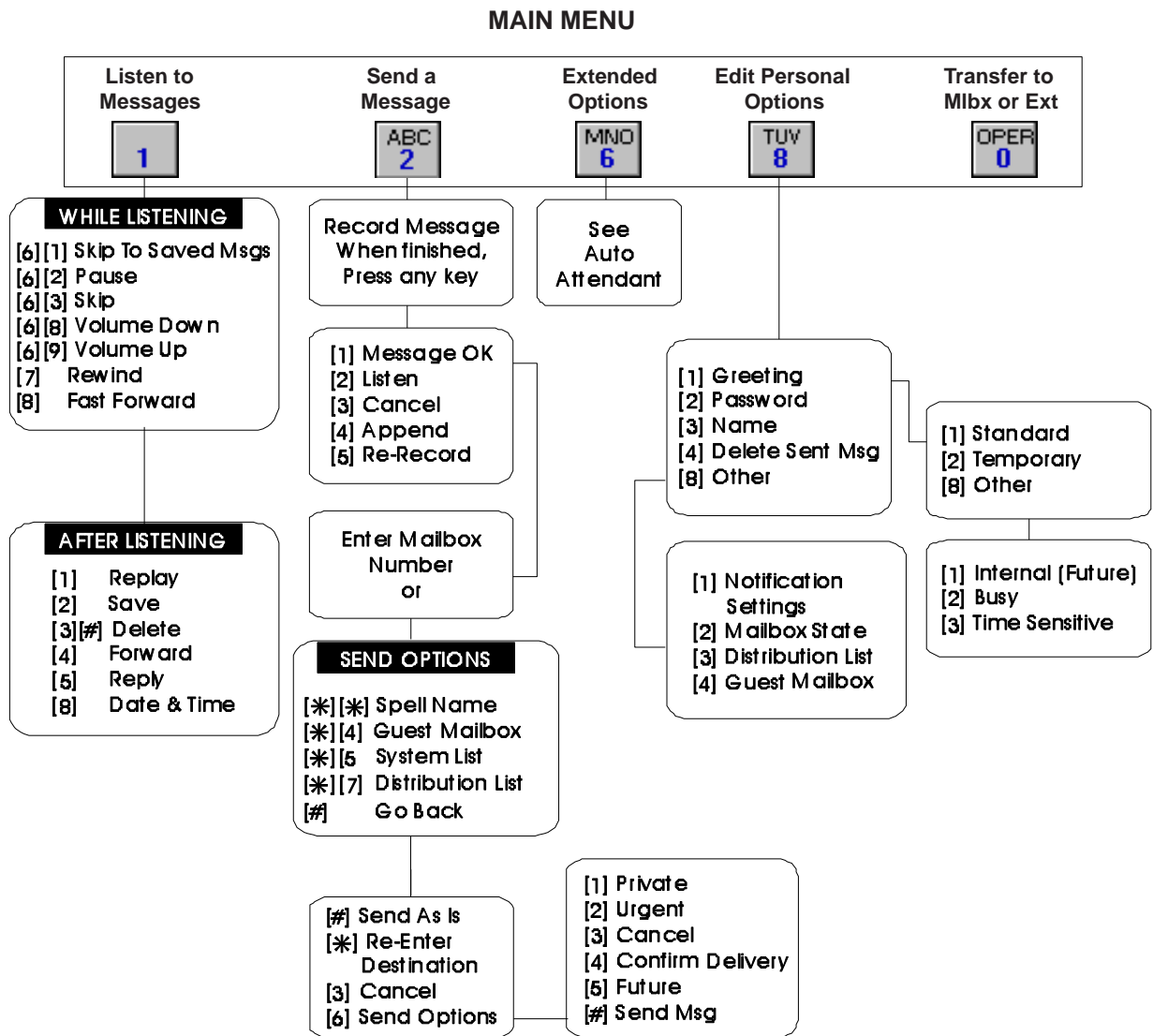

Figure D-1: Hard Drive-based Mailbox Options -- Main Menu



## Retrieving Messages [1]

Mailbox subscribers hear their messages played back in the following order: new messages first and then previously saved messages. All messages are played in the order they were received with the oldest message played first, unless programmed differently by the System Administrator. Features can be accessed at any time. It is not necessary to wait until the end of the message.

After hearing that you have a message, press [1] to listen to the message. Your options will vary depending on whether the message is currently playing, or if the message has ended.

### **While Listening to a Message:**

You will be able to select one of the following message playback options, until ... the message stops playing.

- [6] + [0] Call Back internal or external caller that left a message
- [6] + [1] Go Directly to Saved Message
- [6] + [2] Pause ... then press [2] to resume message play
- [6] + [3] Skip a Message
- [6] + [8] Decrease Volume
- [6] + [9] Increase Volume
- [7] Rewind Message
- [8] Fast Forward Message

### **After Listening to a Message:**

When a message stops playing, the system will prompt you to select one of the following message actions:

- [1] Replay Message
- [2] Save Message
- [3] + [#] Delete & Confirm Message Delete
- [4] Forward Message
  - Press [1] to Forward As Is
  - Press [4] to Leave Preamble and Forward
- [5] Reply to Message

Respond directly to the person who left the message without entering a mailbox number. This feature is available only when the message is recorded in one mailbox, then sent to another mailbox. Calling a mailbox directly and leaving a message does not record the mailbox number for a reply.
- [8] Hear Date & Time

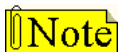

*If you hang up without saving or deleting, your messages will automatically be saved in the state they originated when you accessed the mailbox.*

## **Sending a Message [2]**

Users may send messages to other mailbox owners or to a system distribution list, a personal distribution list, or to guest mailboxes. Once a message is recorded, a mailbox user can send that message to any number of mailboxes.

1. At the Main Menu, press [2] to access the Send Message options.
2. After hearing the tone, record your message.
3. When finished, press any key to end recording.
4. Before sending the message, select the appropriate option when presented:
  - [1] if message is OK
  - [2] to listen to the message
  - [3] to cancel the message
  - [4] to append to the message
  - [5] to re-record the message
5. When the message is ready to send ... press one of the following send options and the subsequent settings that apply:
  - [#] to send message as is
  - [\*] to re-enter send destination
  - [3] to cancel
  - [6] for additional send options
    - [1] Private
    - [2] Urgent
    - [3] Cancel
    - [4] Confirmation
      - [1] Certified
      - [2] Notification of non-delivery
    - [5] Future Delivery
      - Enter MM:DD:HH:MM and press one of the following options:
        - [1] AM
        - [2] PM

## Mailbox Options

From the Personal Options Menu, you will have access to other personal mailbox options where you can perform the following functions:

[8] Other

[1] Notification Options

[2] Mailbox State

[3] Distribution List

[4] Guest Mailbox

### Message Notification

Message Notification instructs the system to contact the mailbox owner on receipt of a message by dialing an alternate phone number or activating a paging device.

#### **To Set Message Notification:**

1. At the Main Menu, press [8] for Personal Options, then press [8] for Other Options.
2. Press [1] for Notification.
3. Select a notification type:

*Immediate* -- The system dials the mailbox owner as soon as the message is left.

*Timed* -- The system waits for a set time before dialing the mailbox owner.

*On Urgent Only* -- Activates notification when messages are marked as urgent.

### Mailbox State

Mailbox State determines how the system handles a call when someone tries to leave a message. Usually, this mean playing the called party's personal greeting and then prompting the caller to leave a message. However, several other features selections allow the call to be handled differently.

#### **To set the Mailbox State:**

1. At the Main Menu, press [8] for Personal Options, then press [8] for Other options.
2. Press [2] for Mailbox State Options, and select the appropriate action:

[1] Turn Greeting Off

[2] Turn Greeting On

[4] Forward to a mailbox

[5] Forward to an extension

[6] Forward to a menu

[7] Forward to a module

[8] Mailbox off

[#] Return to previous menu

## Distribution Lists

Distribution Lists can be utilized to send a message to a large group of pre-determined mailboxes. There are both system and personal distribution lists. System lists are created and maintained by the System Administrator, whereas personal lists are created and maintained by the user. Each user can have up to 10 personal lists each containing up to 25 mailboxes. Users of the system have the following capabilities with Distribution Lists:

### **To Send a Message to a Distribution List:**

1. From the Main Menu, press [8] for Personal Options, then press [8] for Other options.
2. Press [2] to send a message.
3. Record your message after the tone. When finished, press any key.
4. Press one of the following options:
  - [1] if message is OK
  - [2] to listen to message
  - [3] to cancel
  - [4] to append
  - [5] to re-record message

*When the message is ready to send:*

5. Enter [\*] to go to address options.
6. Press one of the following list options:
  - [5] to send to System List
  - [7] to send to a Personal List
7. Enter the System List number or the Personal List number (0-9)
8. Press [#] to confirm, or [\*] to cancel
9. Then press [#] to send, or [\*] to re-enter destination



*The options in Step 6, are "smart prompts". For example: If a user does not have access, or does not have a distribution list, the system does not announce these prompts.*

### **Personal Distribution Lists**

The voice mail system allows mailbox users to create, edit or delete up to ten (10) personal distributions lists. Each list may contain up to twenty-five (25) mailboxes.

Use these instructions (if you are calling into a VM Port) to create a personal distribution list. Personal Distribution Lists are useful for sending out meeting reminders or other notices to special groups.

*To Create a Personal List:*

1. From the Main Menu, press [8] for Personal Options, then press [8] for Other options.
2. Press [3] for Distribution List.
3. Press [2] to create a list.
4. Enter the list number [0-9].
5. Enter [#] to confirm

## Guest Mailboxes [8+8+4]

The voice mail system lets users create up to ten (10) guest mailboxes. Guest mailboxes are utilized by individuals who do not have a permanent mailbox on the system. They receive messages from the mailbox owner, and can also leave a reply.

### Creating a Guest Mailbox

Follow these steps to set up a guest mailbox.

1. From the Main Menu, press [8] for Personal Options, then press [8] for Other Options.
2. Press [4] for Guest Mailbox.
3. Press [2] to create a Guest Mailbox.
4. Enter the mailbox number followed by [#]. Once a guest mailbox is created, the mailbox owner can press one of these options:
  - [1] to list mailboxes
  - [2] to create a mailbox
  - [3] to delete a mailbox
  - [4] to edit mailbox greetings

The voice mail system only uses one guest mailbox greeting for all guest mailboxes. This greeting replaces the system greeting and plays every time a guest mailbox user accesses the guest mailbox. The guest greeting should be generic. *For example ... "To see if I left you a message, enter your guest mailbox number followed by the pound [#] sign."*



The "Guest Greeting" recording must include a prompt that tells the Guest Mailbox user to enter their Guest Mailbox number followed by the [#] key.

### Leaving a Message for a Guest Mailbox

1. From the Main Menu, press [8] for Personal Options, then press [8] for Other Options.
2. Press [2] to record a message.
3. Record your message, when finished press any key.
4. If message is OK, press [1].
5. Press [\*] for Address Options.
6. Press [4] for Guest Mailbox.
7. Enter the Guest Mailbox number followed by [#].
8. Press [#] to send the message.

### Using a Guest Mailbox

1. Have the guest call into the system and access the owner's mailbox.
2. While listening to the mailbox greeting, press [4]. (4=G for guest)
3. After pressing [4], the caller hears the guest greeting recorded by the mailbox owner.
4. Guests enter the mailbox number assigned to them followed by [#].
5. The system plays any messages stored in the guest mailbox.
6. After each message, the guest can press one of the following options:
  - [1] to replay messages
  - [2] to reply to owner
  - [3] to play next message
  - [8] to timestamp

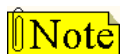

The system automatically deletes guest messages. The Guest Mailbox owner cannot save or forward the message.

*Hard Drive-Based Voice Mail*

---

---

# E

## Customer Database Programming

This appendix provides information about database programming. Use the detailed procedures contained in other chapters and appendices for actual programming via *STSe* display telephone. Use Customer Database Worksheets to help keep track of the system programming changes made for each individual system.

» » » » » » » »

# NOTES

» » » » » » » »

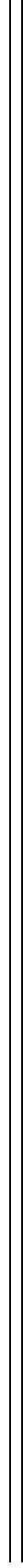
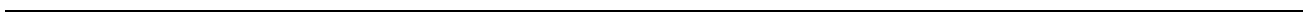



---

## Introduction

The STSe system is programmed to meet each customer's individual needs. All programming is done at any 24-button Vodavi telephone as the programming station or through an ASCII terminal or PC. The digital display model is required for programming.

When the programming mode is entered, the digital telephone being used no longer operates as a telephone but as a programming station with all of the buttons redefined. The keys on the dial pad are used to enter data fields (Program Codes) associated with system, station, and CO line features as well as specific data that requires a numeric entry. Flexible buttons toggle on or off features, or enable entry of specific data fields. LEDs and the LCD display provide a visual indication of entered data and their value.

Programming is also performed using an ASCII terminal, or a computer capable of emulating an ASCII terminal. This form of programming is done locally (on-site) by connecting the terminal directly to the RS-232C connector on the BKSU or is performed remotely (off-site) through the use of the 9600 baud modem. The method and steps to program the system via a PC are identical to those used when programming from a digital key set. A button to keyboard mapping is provided (refer to [Figure E-2 on page E-5](#)) to help minimize familiarization and training time.

The system must be initialized to load default data into memory at the time of installation. If this preprogramming is acceptable to the customer, initialization is all that is needed. Refer to [Table F-1 on page F-3](#) for a listing of all the default values.

When features are programmed, tones are provided to determine if a correct or incorrect entry has been made. A solid one second tone indicates the data was accepted. An interrupted tone means an error was made. When this occurs, re-enter the data and information.

Until new data is entered and accepted, the system continues to operate under default or previously entered values.

The system database is updated on a real-time basis as new data is entered, by pressing the Hold button. The system continues to operate with the current database and is updated with any newly entered or changed data without interruption to telephone operation or call processing in progress. However, if for example a station's attributes are changed while that station is off-hook on an active call, the newly entered data does not take effect until the station goes on-hook or becomes idle.

When using a PC to program the system, the following chart presents the data terminal characters that are equivalent to the key set buttons.

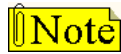

**Note**

*Some features must have more than one data field programmed for that feature to work. This information is stated in the instructions.*

```

adm>
REMOTE ADMIN KEY DEFINITION
Keyset   Term   Keyset   Term   Keyset   Term
-----
0        0      FLEX 1   Q      FLEX 13  D
1        1      FLEX 2   W      FLEX 14  F
2        2      FLEX 3   E      FLEX 15  G
3        3      FLEX 4   R      FLEX 16  H
4        4      FLEX 5   T      FLEX 17  J
5        5      FLEX 6   Y      FLEX 18  K
6        6      FLEX 7   U      FLEX 19  L
7        7      FLEX 8   I      FLEX 20  :
8        8      FLEX 9   O      FLEX 21  Z
9        9      FLEX 10  P      FLEX 22  X
*        *      FLEX 11  A      FLEX 23  C
#        #      FLEX 12  S      FLEX 24  V
TRANS   B      MUTE     N      ON-OFF   M
FLASH   ,      HOLD     CR     HELP     ?
adm>

```

**Figure E-1: Data Terminal Program Codes Cross Reference**

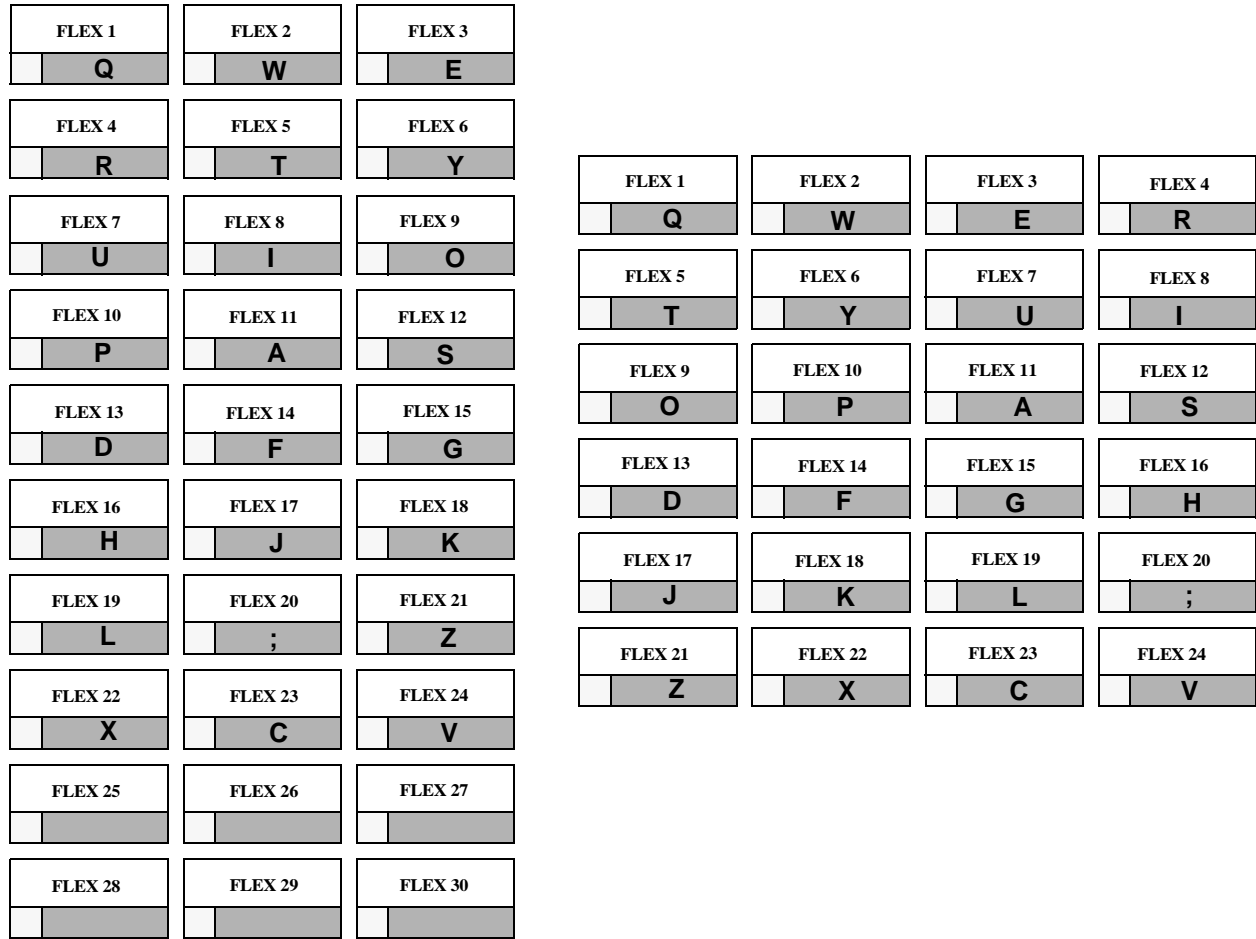

Figure E-2: Programming Button Mapping (30- & 24-Button Mapping)

---

## Program Mode Entry (Key Station)

Programming is performed at any 24-button Digital Display Terminal. Programming is always done at this type of station regardless of the class of service or which station has been assigned as the Attendant(s).

**To enter the Program Mode:**

1. Press the ON/OFF button (optional). LED lights and intercom dial tone sounds.
2. On the dial pad, press [\*][\*][3][2][2][6] (default password). A confirmation tone sounds.
3. The ON/OFF button LED is lit. The system is ready to program.

DEFAULT ... Station 100 programming only

---

## Program Mode Entry (Data Terminal or PC)

A PC terminal connected to the RS-232C port on the MBU, or remotely through the 9600 baud modem, is used for database programming. When using a data terminal (ASCII or PC capable of emulating an ASCII terminal) on-site or locally, to program the system:

1. Press <Enter> on the terminal.
2. Enter the password [default = **3226vodavi**], and press <Enter> again. Proper entry of the password results in the Adm> prompt. Proceed with programming referring to [Figure E-1 on page E-4](#) for terminal characters that represent the key set buttons. By entering [?] from the terminal, a Help screen displays.

When entering the system remotely via a PC, access to the modem is accomplished by accessing Port 499 through a direct ringing assignment or through DISA or by being transferred to Port 499.

---

## Initialization

The system has been preprogrammed with certain features called default data (refer to [Table F-1 on page F-3](#)). These features are loaded into memory when the system is initialized.



*The system should be initialized when installed or at any time the database has been corrupted.*

**To Return the Database to the System Default Values:**

1. Place Switch #8 on BKSU to the ON position.
2. Turn the power off and on to initialize the system database to the default.
3. Once database is initialized (phone displays the station number), place Switch #8 in the OFF position to protect the database.

## Database Programming Worksheets

Before attempting programming, it is strongly recommended that customer database worksheets be prepared. These worksheets should become part of the permanent record of customer programming.

## Database Upload/Download Routine

The Database Upload/Download Routine (**FLASH 86**) provides a maintenance facility which permits the user to download the database to a PC, when a software change is made or when the system needs to be initialized and reprogrammed. The Upload/Download Routine facilitates the programming of a database on an in-house system which is downloaded to a PC and then uploaded to a system in the field.

After the system maintenance is completed, the file saved in the PC can then be uploaded to the system.



All trace modes such as: SMDR (Flash 21), ICLID (Flash56), and Maintenance Event Traces **MUST** be turned off before a download is performed!  
Default telephone type = 24-button model

### Upload/Download through Remote Administration

First, connect one end of an RS-232C serial cable from the RS-232C connector on the BKSU to the desired Comm Port on the PC.

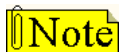

Use a straight-through DB-9 to DB-9 (female to female) cable.

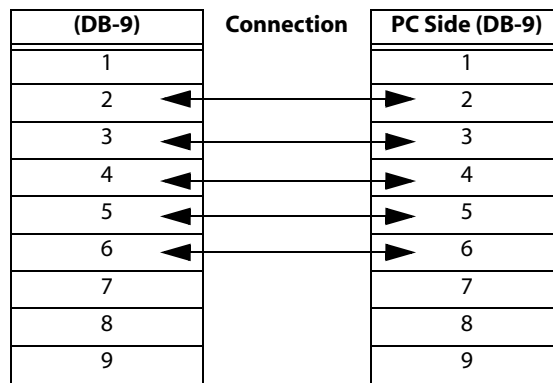

**Figure E-3: KSU to PC Connection Configuration**

Then load a communication software package (e.g., Hyperterminal) into the PC and complete the following steps to reconfigure the system.

**HYPERTERMINAL -- Uploading a Database File**

After opening HyperTerminal, and the New Connection screen displays, complete the following steps:

1. Type a connection name and select the appropriate icon, then click <OK>.
2. When the Phone Number screen displays, change the setting in the Connect Using box to: Direct to COM1, and then click <OK>.
3. Once the COM1 Properties screen displays, change the settings as shown, and then click <OK>.
  - Baud Rate = 9600
  - Parity = None
  - Data Bits = 8
  - Stop Bits = 1
  - Flow Control = Xon/Xoff or None
4. Press <Enter> and complete the following fields:

| Screen Field    | Action   |
|-----------------|--|
| ENTER PASSWORD: | Type password: XXXXVODAVI<br>(XXXX = default password for online administration) |
| ADM> ,          | Type program number.   |
| ADM>86          | Load database routine.<br>Type button number.                                    |
| ADM>Q           | Upload database.<br>Press HOLD button.   |
| ADM>            | Press <Enter> key twice.   |

5. On the tool bar, click <Transfer> and select Send File.
6. Change Protocol setting to XMODEM.
7. Click <Browse> to locate database file; double-click on the filename.
8. Click <Send>. Adm> prompt displays when file transfer is complete.

**HYPERTERMINAL -- Downloading a Database File**

**After opening HyperTerminal, and the New Connection screen displays, complete the following steps:**

1. Type connection name and select appropriate icon, then click <OK>.
2. When the Phone Number screen displays, change the setting in the Connect Using box to: Direct to COM1, and then click <OK>.
3. Once the COM1 Properties screen displays, change the settings as shown, and then click <OK>.
  - Baud Rate = 9600
  - Parity = None
  - Data Bits = 8
  - Stop Bits = 1
  - Flow Control = Xon/Xoff or None
4. Press <Enter> and complete the following fields:

| Screen Fields   | Action   |
|-----------------|--|
| ENTER PASSWORD: | Type password: XXXXVODAVI<br>(XXXX = default password for online administration) |
| ADM> ,          | Type program number.   |
| ADM>86          | Load database routine.<br>Type button number.                                    |
| ADM>W           | Download database.<br>Press HOLD button.   |
| ADM>            | Press <Enter> key twice.   |

5. On the tool bar, click <Transfer> and select Receive File.
6. Change Receive Protocol setting to XMODEM, and click <Receive>.
7. Type database filename and click <OK>. The Adm> prompt displays when the file transfer is complete.

**ECOM -- Uploading a Database File**

After opening ECOM:

1. Press <Alt> + <P> to open COM Port Options.
2. Change COM port settings as follows, and click <OK>.
  - Baud Rate = 9600
  - Parity = None
  - Data Bits = 8
  - Stop Bits = 1
  - Flow Control = no boxes checked, Xon=17, Xoff=19
3. Press <Enter> and complete the following fields:

| Screen Fields   | Action   |
|-----------------|--|
| ENTER PASSWORD: | Type password: XXXXVODAVI<br>(XXXX = default password for online administration) |
| ADM> ,          | Type program number.   |
| ADM>86          | Load database routine.<br>Type button number.                                    |
| ADM>Q           | Upload database.<br>Press HOLD button.   |
| ADM>            | Press <Enter> key twice.   |

4. Press <PgUp> on keyboard or locate file and select Upload.
5. Highlight XMODEM and click <OK>.
6. Type or select upload filename and click <OK>. The Adm> prompt displays when the file transfer is complete.



**ECOM -- Downloading a Database File**

After opening ECOM:

1. Press <Alt> + <P> to open COM Port Options.
2. Change COM port settings as follows, and click <OK>.
  - Baud Rate = 9600
  - Parity = None
  - Data Bits = 8
  - Stop Bits = 1
  - Flow Control = no boxes checked, Xon=17, Xoff=19
3. Press <Enter> and complete the following fields:

| Screen Fields   | Action   |
|-----------------|--|
| ENTER PASSWORD: | Type password: XXXXVODAVI<br>(XXXX = default password for online administration) |
| ADM>,           | Type program number.   |
| ADM>86          | Load database routine.<br>Type button number.                                    |
| ADM>W           | Download database.<br>Press HOLD button.   |
| ADM>            | Press <Enter> key twice.   |

4. Press <PgDn> on keyboard or locate file and select Download.
5. Highlight XMODEM and click <OK>.
6. Type or select download filename and click <OK>. The Adm> prompt displays when the file transfer is complete.



---

---

# F

## Quick Reference

This appendix provides quick-access tables for locating system features and their default configurations.

When using this manual in an electronic format, click on the [blue](#) hyperlinks to quickly navigate to detailed information on the subject.

- FLASH CODE INDEX - system features programming, organized in *flash code* numerical sequence.

- DEFAULT NUMBERING PLAN - system features and default access codes, organized in *alphabetical* sequence.

» » » » » » » »

# NOTES

» » » » » » » »



## Flash Code Index

**Table F-1: Feature Default Values**

| Features                         | Page #                | Program Code | Flexible Button | Default Value |
|----------------------------------|-----------------------|--------------|-----------------|---------------|
| SYSTEM TIMERS                    |                       | FLASH 01     |                 |               |
| System Hold Recall Timer         | <a href="#">2-178</a> |              | 1               | 60 sec        |
| Exclusive Hold Recall Timer      | <a href="#">2-177</a> |              | 2               | 180 sec       |
| Attendant Recall Timer           | <a href="#">3-24</a>  |              | 3               | 1 min         |
| Transfer Recall Timer            | <a href="#">2-258</a> |              | 4               | 45 sec        |
| Fax Timeout                      | <a href="#">2-161</a> |              | 5               | 15 sec        |
| Pause Timer                      | <a href="#">2-247</a> |              | 7               | 2 sec         |
| Call Park Recall Timer           | <a href="#">2-45</a>  |              | 8               | 180 sec       |
| Conference/DISA Timer            | <a href="#">2-102</a> |              | 9               | 10 min        |
| Paging Time-Out Timer            | <a href="#">2-245</a> |              | 10              | 15 sec        |
| CO Ring Detect Timer             | <a href="#">2-99</a>  |              | 11              | 3=300 ms      |
| SLT DTMF Receiver Timer          | <a href="#">2-270</a> |              | 12              | 020 sec       |
| Message Wait Reminder Tone Timer | <a href="#">2-226</a> |              | 13              | 000=Disabled  |
| SLT Hook Switch Timer            | <a href="#">2-271</a> |              | 14              | 10=1 sec      |
| SLT Hook Switch Bounce Timer     | <a href="#">2-271</a> |              | 15              | 030=300 ms    |
| SMDR Call Qualification Timer    | <a href="#">2-290</a> |              | 16              | 30 sec        |
| Automatic Call Back Timer        | <a href="#">2-21</a>  |              | 17              | 10 sec        |
| Reminder Ring Timer              | <a href="#">2-96</a>  |              | 18              | 00 sec        |
| Inter-Digit Time-Out             | <a href="#">2-189</a> |              | 20              | 5 sec         |
| ADDITIONAL SYSTEM TIMERS         |                       | FLASH 02     |                 |               |
| Repeat Redial Timer              | <a href="#">2-259</a> |              | 1               | 60 sec        |
| Attendant Display Timer          | <a href="#">3-21</a>  |              | 2               | 01 sec        |
| Modem Answer Timer               | <a href="#">2-261</a> |              | 4               | 025 sec       |
| Pulse Dial Inter-Digit Timer     | <a href="#">2-111</a> |              | 5               | 300 ms        |
| DTMF On/Off Time Operation       | <a href="#">2-72</a>  |              | 6               | 1=100ms       |
| SYSTEM FEATURES 1 PROGRAMMING    |                       | FLASH 05     |                 |               |
| Attendant Override               | <a href="#">3-13</a>  |              | 1               | Disabled      |
| Hold Preference                  | <a href="#">2-177</a> |              | 2               | System        |
| External Night Ring              | <a href="#">2-159</a> |              | 3               | Disabled      |
| Executive Override Warning Tone  | <a href="#">2-156</a> |              | 4               | Enabled       |
| Page Warning Tone                | <a href="#">2-245</a> |              | 5               | Enabled       |
| Background Music                 | <a href="#">2-16</a>  |              | 6               | Enabled       |

## Quick Reference

Table F-1: Feature Default Values

| Features                                | Page #                | Program Code | Flexible Button | Default Value           |
|---|-----------------------|--------------|-----------------|-------------------------|
| Least Cost Routing (LCR)                | <a href="#">B-18</a>  |              | 7               | Disabled                |
| Account Codes – Forced                  | <a href="#">2-9</a>   |              | 8               | Disabled                |
| Group Listening                         | <a href="#">2-172</a> |              | 9               | Disabled                |
| Idle Speaker Mode                       | <a href="#">2-183</a> |              | 10              | Disabled                |
| Call Cost Display                       | <a href="#">B-18</a>  |              | 11              | Disabled                |
| Music-On-Hold                           | <a href="#">2-227</a> |              | 12              | Enabled                 |
| CO Line Loop Superv - Forced Disconnect | <a href="#">2-89</a>  |              | 14              | Disabled                |
| Daylight Saving Time                    | <a href="#">2-110</a> |              | 16              | Disabled                |
| Multiple Tenant Group Enable/Disable    | <a href="#">2-312</a> |              | 17              | Disabled                |
| Long Fax Detect                         | <a href="#">2-161</a> |              | 19              | Disabled                |
| SYSTEM FEATURES 2 PROGRAMMING           |                       | FLASH 06     |                 |                         |
| Barge In Warn Tone                      | <a href="#">2-157</a> |              | 1               | Enabled                 |
| CO Ring Tones                           | <a href="#">2-143</a> |              | 2               | Enabled                 |
| Verified Account Codes                  | <a href="#">2-10</a>  |              | 3               | Disabled                |
| Call Forward Display                    | <a href="#">2-34</a>  |              | 4               | Enabled                 |
| External Day Ring                       | <a href="#">2-159</a> |              | 5               | Disabled                |
| Overflow Station Forward                | <a href="#">4-6</a>   |              | 6               | Disabled                |
| Direct Transfer Mode                    | <a href="#">2-133</a> |              | 7               | Enabled                 |
| Station ID Lock                         | <a href="#">2-285</a> |              | 8               | Disabled                |
| LCR Call Progress                       | <a href="#">B-14</a>  |              | 9               | Enabled                 |
| One-Touch Recording Warn Tone           | <a href="#">2-351</a> |              | 10              | Enabled                 |
| Ringback on Transfer                    | <a href="#">2-52</a>  |              | 11              | Disabled                |
| 911 Feature                             | <a href="#">2-5</a>   |              | 13              | Disabled                |
| Enhanced 911                            | <a href="#">2-7</a>   |              | 14              | Disabled                |
| VMID Same As Station Numbers            | <a href="#">2-337</a> |              | 15              | STA Numbers = VMID      |
| FLASH RATES (Programmable)              | <a href="#">2-162</a> | FLASH 07     |                 |                         |
| Incoming CO Line Ringing                | <a href="#">2-80</a>  |              | 1               | Red 480 ipm flutter     |
| Incoming Intercom Ringing               | <a href="#">2-188</a> |              | 2               | Red 120 ipm flutter     |
| Call Forward Button                     | <a href="#">2-33</a>  |              | 3               | Red Steady On           |
| Message Wait/VM Button                  | <a href="#">2-341</a> |              | 4               | Red Steady On           |
| Do Not Disturb – DSS/BLF                | <a href="#">2-150</a> |              | 6               | Red 60 ipm Dbl Wink Off |
| Auto Call Back – BLF                    | <a href="#">2-22</a>  |              | 7               | Red 120 ipm flash       |
| UCD Available/Unavailable – DSS/BLF     | <a href="#">4-12</a>  |              | 8               | Red 60 ipm Dbl Wink Off |
| Transfer CO Ringing                     | <a href="#">2-95</a>  |              | 9               | Red 120 ipm flash       |
| Recall CO Ringing                       | <a href="#">2-95</a>  |              | 10              | Red 480 ipm flutter     |

Table F-1: Feature Default Values

| Features  | Page #                | Program Code | Flexible Button | Default Value                   |
|---|-----------------------|--------------|-----------------|---------------------------------|
| Queued CO Ringing                               | <a href="#">2-96</a>  |              | 11              | Green 480 ipm flutter           |
| Exclusive Hold                                  | <a href="#">2-176</a> |              | 12              | Green 120 ipm flash             |
| System Hold                                     | <a href="#">2-178</a> |              | 13              | Red 60 ipm Dbl Wink Off         |
| In-Use Hold (I-Hold)                            | <a href="#">2-87</a>  |              | 14              | Green 60 ipm flash              |
| Camp On Button                                  | <a href="#">2-55</a>  |              | 15              | Red 120 ipm flash               |
| Call Back Button                                | <a href="#">2-20</a>  |              | 16              | Red 120 ipm flash               |
| Line Queue Button                               | <a href="#">2-93</a>  |              | 17              | Red 480 ipm flutter             |
| Do Not Disturb Button                           | <a href="#">2-150</a> |              | 18              | Red Steady On                   |
| UCD Wrap-up End Button                          | <a href="#">4-14</a>  |              | 20              | Red 120 ipm flutter             |
| Page Block (DND Button)                         | <a href="#">2-147</a> |              | 21              | Red 120 ipm flash               |
| In and Out Button                               | <a href="#">2-184</a> |              | 22              | Red 120 ipm flash               |
| SYSTEM PARAMETERS PROGRAMMING                   |                       | FLASH 09     |                 |                                 |
| MOH Assignments (Channels 3-8)                  | <a href="#">2-227</a> |              | 1-6             | None                            |
| E911 Power Failure Station                      | <a href="#">2-8</a>   |              | 7               | None                            |
| Leading Digit                                   | <a href="#">2-223</a> |              | 9               | 0                               |
| School Mode                                     | <a href="#">2-267</a> |              | 10              | Disabled                        |
| School Forward Destination                      | <a href="#">2-267</a> |              | 11              | None                            |
| Muted Ring                                      | <a href="#">2-230</a> |              | 12              | 0                               |
| Fax Route                                       | <a href="#">2-161</a> |              | 13              | 148                             |
| ATTENDANT STATION ASSIGNMENT                    | <a href="#">3-15</a>  | FLASH 10     |                 | STA 100                         |
| Attd Sta Assignments for Tenant Groups          | <a href="#">2-313</a> |              | 1-10            | STA 100 for 1st assign in Grp 0 |
| SYSTEM TIME AND DATE                            | <a href="#">3-14</a>  | FLASH 11     | 1               | MMM/DD/YY, 12-hr display        |
| PBX DIALING CODES                               | <a href="#">2-60</a>  | FLASH 12     | --              | None                            |
| EXECUTIVE/SECRETARY PAIRS                       | <a href="#">2-158</a> | FLASH 13     | 1-4             | None                            |
| RELAY PROGRAMMING                               | <a href="#">2-260</a> | FLASH 14     | 1               | None                            |
| BAUD RATE ASSIGNMENTS                           |                       | FLASH 15     |                 |                                 |
| Port #1 (RS-232C on the BKSU)                   | <a href="#">2-19</a>  |              | 1               | 9600 Baud                       |
| Port #2 (RS-232C on the BKSU)                   | <a href="#">2-19</a>  |              | 2               | 9600 Baud                       |
| Port #3 (optional modem - baud auto-negotiated) | <a href="#">2-19</a>  |              | 3               | None                            |
| ACCESS CODES                                    |                       | FLASH 20     |                 |                                 |
| DISA Access Code                                | <a href="#">2-129</a> |              | 1               | 100                             |
| Database Admin Password                         | <a href="#">2-106</a> |              | 2               | 3226                            |
| STATION MESSAGE DETAIL RECORDING                |                       | FLASH 21     |                 |                                 |
| SMDR Enable/Disable                             | <a href="#">2-288</a> |              | 1               | No                              |

## Quick Reference

Table F-1: Feature Default Values

| Features   | Page #                | Program Code | Flexible Button | Default Value                          |
|--|-----------------------|--------------|-----------------|--|
| Long Distance/All Calls                                | <a href="#">2-288</a> |              | 2               | Long Distance                          |
| Character Print Assignment                             | <a href="#">2-289</a> |              | 3               | 80                                     |
| SMDR Port Assignments                                  | <a href="#">2-289</a> |              | 5               | Port #1                                |
| WEEKLY NIGHT MODE SCHEDULE                             |                       | FLASH 22     |                 |  |
| Automatic/Manual Operation                             | <a href="#">2-235</a> |              | 1               | Manual=No                              |
| Day of Week Programming                                | <a href="#">2-236</a> |              | 2-8             | M-F 08:00 17:00,<br>Sat-Sun ##:## #:## |
| DIRECTORY DIALING                                      |                       | FLASH 23     |                 |  |
| Bin/ICM Numbering                                      | <a href="#">2-135</a> |              | 1               | None                                   |
| Name Changes   | <a href="#">2-135</a> |              | 2               | None                                   |
| Clearing An Entry                                      | <a href="#">2-136</a> |              | 3               | None                                   |
| Backspace To Correct Error                             | <a href="#">2-135</a> |              | 4               | None                                   |
| Scroll to next Entry                                   | <a href="#">2-135</a> |              | 18              | --                                     |
| Scroll to previous Entry                               | <a href="#">2-135</a> |              | 19              | --                                     |
| Select a Specific Directory List Entry                 | <a href="#">2-134</a> |              | 20              | --                                     |
| CARD SLOT PROGRAMMING                                  |                       | FLASH 24     |                 |  |
| Card Slots (0-13)                                      | <a href="#">2-55</a>  |              | 1-14            | Slot 0, 1, 2 = DTIB, LCI4, & SL02      |
| HUNT GROUPS  |                       | FLASH 30     |                 |  |
| Hunt Group Programming                                 | <a href="#">2-179</a> |              | 1-12            | None                                   |
| Station/Pilot/Pilot Ring All --<br>Hunting Assignments | <a href="#">2-180</a> |              | 13              | Pilot                                  |
| Overflow Destination - Day                             | <a href="#">2-181</a> |              | 14              | None                                   |
| Overflow Destination - Night                           | <a href="#">2-181</a> |              | 15              | None                                   |
| Overflow Destination - Special                         | <a href="#">2-181</a> |              | 16              | None                                   |
| Overflow Destination - VMID                            | <a href="#">2-181</a> |              | 17              | None                                   |
| Overflow Timer   | <a href="#">2-181</a> |              | 18              | 10 sec                                 |
| Queue  | <a href="#">2-181</a> |              | 19              | 0 (disabled)                           |
| VERIFIED ACCOUNT CODES                                 |                       | FLASH 31     |                 |  |
| Account Code   | <a href="#">2-11</a>  |              | 1               | None                                   |
| Class of Service                                       | <a href="#">2-11</a>  |              | 2               | None                                   |
| Delete Code  | <a href="#">2-11</a>  |              | 3               | None                                   |
| Erase Digits   | <a href="#">2-11</a>  |              | 4               | None                                   |
| CO LINE GROUP QUEUING                                  | <a href="#">2-75</a>  | FLASH 39     | 1-24            | Enabled                                |
| CO LINE ATTRIBUTES PAGE A PROGRAMMING                  |                       | FLASH 40     | Btn 19          |  |
| DTMF/Dial Pulse Programming                            | <a href="#">2-71</a>  | Page A       | 1               | DTMF                                   |
| CO/PBX Programming                                     | <a href="#">2-57</a>  |              | 2               | CO                                     |



Table F-1: Feature Default Values

| Features  | Page #                | Program Code | Flexible Button | Default Value     |
|---|-----------------------|--------------|-----------------|-------------------|
| Universal Night Answer (UNA)                        | <a href="#">2-237</a> |              | 3               | Enabled           |
| DISA CO-to-CO                                       | <a href="#">2-131</a> |              | 4               | Enabled           |
| Privacy   | <a href="#">2-254</a> |              | 5               | Enabled           |
| Loop Supervision Programming                        | <a href="#">2-88</a>  |              | 6               | 4=400 ms          |
| DISA Programming                                    | <a href="#">2-129</a> |              | 7               | None              |
| CO Line Group Programming                           | <a href="#">2-74</a>  |              | 8               | Group 01          |
| Class of Service (COS) Programming                  | <a href="#">2-62</a>  |              | 9               | COS 1             |
| CO Line Ringing Assignments                         | <a href="#">2-78</a>  |              | 10              | None              |
| CO Line Identification Display                      | <a href="#">2-76</a>  |              | 11              | Line XXX          |
| CO Direction  | <a href="#">2-97</a>  |              | 12              | Incoming/Outgoing |
| Display Ring Assignments                            | <a href="#">2-81</a>  |              | 13              | 100A              |
| DID/TIE Signal                                      | <a href="#">2-124</a> |              | 14              | Wink              |
| Lines for 911Use                                    | <a href="#">2-5</a>   |              | 15              | Disabled          |
| Tenant Group CO Line Programming                    | <a href="#">2-314</a> |              | 17              | All Lines Group 0 |
| Scroll to next CO Line                              | --                    |              | 22              | --                |
| Scroll to previous CO Line                          | --                    |              | 23              | --                |
| Return to Flash 40 "Select a CO Line Range" Display | --                    |              | 24              | --                |
| CO LINE ATTRIBUTES PAGE B PROGRAMMING               |                       | FLASH 40     | Btn 20          |                   |
| T-1 Signal Type                                     | <a href="#">2-306</a> | Page B       | 1               | Loop              |
| T-1 Ringback  | <a href="#">2-308</a> |              | 2               | Enabled           |
| T-1 Dial Tone                                       | <a href="#">2-308</a> |              | 3               | Disabled          |
| Transmit Volume                                     | <a href="#">2-84</a>  |              | 4               | 5=0 dB            |
| Preset Call Forward Day Destination                 | <a href="#">2-39</a>  |              | 5               | None              |
| Preset Forward Voice Mail ID                        | <a href="#">2-41</a>  |              | 6               | None              |
| Universal Day Answer (UDA)                          | <a href="#">2-330</a> |              | 7               | Disabled          |
| Music-On-Hold (per CO Line)                         | <a href="#">2-228</a> |              | 8               | Channel 1         |
| Ring Tone (per CO Line)                             | <a href="#">2-141</a> |              | 9               | Tone # 00         |
| Preset Call Forward Night Destination               | <a href="#">2-39</a>  |              | 16              | None              |
| Preset Call Forward Special Destination             | <a href="#">2-39</a>  |              | 17              | None              |
| Fax Detect Enable/Disable                           | <a href="#">2-160</a> |              | 18              | Disabled          |
| Scroll to next CO Line                              | --                    |              | 22              | --                |
| Scroll to previous CO Line                          | --                    |              | 23              | --                |
| Return to Flash 40 "Select a CO Line Range" Display | --                    |              | 24              | --                |

## Quick Reference

Table F-1: Feature Default Values

| Features  | Page # | Program Code | Flexible Button | Default Value |
|---|--------|--------------|-----------------|---------------|
| CO LINE ATTRIBUTES PAGE C PROGRAMMING               |        | FLASH 40     | Btn 21          |               |
| Flash Timer Programming                             | 2-59   | Page C       | 1               | 10=1.0 sec    |
| Ring Delay Timer                                    | A-9    |              | 2               | 00=Disabled   |
| Wink Timer  | 2-309  |              | 3               | 140 ms        |
| Release Timer                                       | 2-82   |              | 4               | 020=200 ms    |
| Reseize Timer                                       | 2-83   |              | 5               | 200=2 sec     |
| Guard Timer   | 2-83   |              | 6               | 05=0.5 sec    |
| Seize Timer   | 2-84   |              | 7               | 010=0.1 sec   |
| Preset Forward Timer                                | 2-42   |              | 8               | 10 sec        |
| DID Collect Timer                                   | 2-126  |              | 9               | 015=150 ms    |
| T-1 Collect Timer                                   | 2-310  |              | 10              | 015=150 ms    |
| Scroll to next CO Line                              | --     |              | 22              | --            |
| Scroll to previous CO Line                          | --     |              | 23              | --            |
| Return to Flash 40 "Select a CO Line Range" Display | --     |              | 24              | --            |
| DID-TIE PARAMETERS                                  |        | FLASH 41     |                 |               |
| Dial Pulse Parameters                               | 2-111  |              | 1               | 60/40, 10 pps |
| DID Digits  | 2-123  |              | 3               | 3             |
| DID Incoming Signal                                 | 2-124  |              | 5               | DTMF          |
| T-1 Incoming Signal                                 | 2-310  |              | 6               | DTMF          |
| T-1 Framing Type                                    | 2-311  |              | 7               | D4SF-AMI      |
| LCOB Loop Length                                    | 2-223  |              | 8               | 1=Long        |
| Display PRI Name                                    | 2-191  |              | 9               | 0=Disabled    |
| CO Tolerance  | 2-100  |              | 11              | Enabled       |
| CO Line Sharing - Tenent Groups                     | 2-316  |              | 12              | Disabled      |
| CO FLEXIBLE PORT ASSIGNMENT                         | 2-66   | FLASH 42     | 1-7             | CO Ports 1-28 |
| ICLID PROGRAMMING                                   |        | FLASH 43     |                 |               |
| ICLID Ringing Assignment(s)                         | 2-116  |              | 1               | None          |
| Preset Forward Day Destination                      | 2-118  |              | 2               | None          |
| Preset Forward Night Destination                    | 2-118  |              | 3               | None          |
| Preset Forward Special Destination                  | 2-118  |              | 4               | None          |
| Preset Forward VMID                                 | 2-119  |              | 5               | None          |
| Preset Forward Day Timer                            | 2-120  |              | 6               | 10 sec        |
| MOH Channel   | 2-121  |              | 7               | None          |
| Universal Day Answer                                | 2-122  |              | 8               | None          |

Table F-1: Feature Default Values

| Features                               | Page #                | Program Code | Flexible Button | Default Value  |
|--|-----------------------|--------------|-----------------|--|
| Universal Night Answer                 | <a href="#">2-122</a> |              | 9               | None   |
| Tenant Group Incoming Ring Assignments | <a href="#">2-315</a> |              | 10              | Group 0  |
| Preset Forward Night Timer             | <a href="#">2-120</a> |              | 11              | 10 sec   |
| Preset Forward Special Timer           | <a href="#">2-120</a> |              | 12              | 10 sec   |
| View ICLID Ringing Assignments         | <a href="#">2-117</a> |              | 17              |  |
| Next ICLID Route Number                | <a href="#">2-117</a> |              | 18              |  |
| Previous ICLID Route Number            | <a href="#">2-117</a> |              | 19              |  |
| Select Route Number                    | <a href="#">2-117</a> |              | 20              |  |
| DID PROGRAMMING                        |                       | FLASH 44     |                 |  |
| Route Number                           | <a href="#">2-113</a> |              | 1               | refer to <a href="#">Figure A-2</a> on <a href="#">page A-13</a> |
| DID Phone Number                       | <a href="#">2-114</a> |              | 2               | None   |
| Name Assigned to Number                | <a href="#">2-114</a> |              | 3               | None   |
| Erasing a DID Table Entry              | <a href="#">2-115</a> |              | 4               | None   |
| Scroll to next Route                   | --                    |              | 18              | --   |
| Scroll to previous Route               | --                    |              | 19              | --   |
| ISDN PAGE A PROGRAMMING                |                       | FLASH 45     | Btn 19          |  |
| PRI CO Type                            | <a href="#">2-197</a> | Page A       | 2               | NI2  |
| Framing                                | <a href="#">2-198</a> |              | 3               | ESF  |
| Power                                  | <a href="#">2-198</a> |              | 5               | Disabled   |
| Directory Number (PRI)                 | <a href="#">2-198</a> |              | 6               | None   |
| Max Out I-Frames                       | <a href="#">2-199</a> |              | 7               | K 001  |
| Leading 1                              | <a href="#">2-199</a> |              | 8               | Enabled  |
| Leading 011                            | <a href="#">2-200</a> |              | 9               | Enabled  |
| PRI 7-11 Digit Number Plan             | <a href="#">2-200</a> |              | 10              | ITU  |
| Calling Number                         | <a href="#">2-201</a> |              | 11              | Enabled  |
| Loopback                               | <a href="#">2-201</a> |              | 12              | Normal   |
| ISDN PAGE B PROGRAMMING                |                       | FLASH 45     | Btn 20          |  |
| Maximum Number Retransmission          | <a href="#">2-203</a> | Page B       | 1               | 3  |
| Maximum Octets                         | <a href="#">2-203</a> |              | 2               | 260  |
| Maximum TEI ID Request                 | <a href="#">2-204</a> |              | 3               | 003  |
| Maximum XID Retransmission             | <a href="#">2-204</a> |              | 4               | 3 sec  |
| T-200                                  | <a href="#">2-204</a> |              | 5               | 01 sec   |
| Minimum TEI ID Check Message           | <a href="#">2-205</a> |              | 6               | 01 sec   |
| Minimum TEI ID Request                 | <a href="#">2-205</a> |              | 7               | 02 sec   |

## Quick Reference

Table F-1: Feature Default Values

| Features                                | Page #                | Program Code | Flexible Button | Default Value |
|---|-----------------------|--------------|-----------------|---------------|
| Message Exchange Timer                  | <a href="#">2-205</a> |              | 8               | 15 sec        |
| Minimum XID Retransmission              | <a href="#">2-206</a> |              | 9               | 3 sec         |
| Inter Digit T/O                         | <a href="#">2-206</a> |              | 10              | 25 sec        |
| Set-up Timer                            | <a href="#">2-207</a> |              | 11              | 10 sec        |
| Disconnect Timer                        | <a href="#">2-207</a> |              | 12              | 04 sec        |
| Release Request                         | <a href="#">2-207</a> |              | 13              | 04 sec        |
| Link Disconnect                         | <a href="#">2-208</a> |              | 14              | 30 sec        |
| Call Proceeding                         | <a href="#">2-208</a> |              | 15              | 60 sec        |
| Connect Request                         | <a href="#">2-208</a> |              | 16              | 04 sec        |
| Restart Request Timer                   | <a href="#">2-209</a> |              | 17              | 120 sec       |
| T-1 ALARM PROGRAMMING                   |                       | FLASH 47     |                 |               |
| Carrier Loss Alarm                      | <a href="#">2-299</a> |              | 1               | Enabled       |
| Blue Alarm                              | <a href="#">2-300</a> |              | 2               | Enabled       |
| Yellow Alarm                            | <a href="#">2-301</a> |              | 3               | Enabled       |
| Red Alarm                               | <a href="#">2-301</a> |              | 4               | Enabled       |
| Bipolar Alarm                           | <a href="#">2-302</a> |              | 5               | Enabled       |
| Frame Slip Alarm                        | <a href="#">2-302</a> |              | 6               | Enabled       |
| Data Errors Alarm                       | <a href="#">2-303</a> |              | 7               | Enabled       |
| Enable/Disable                          | <a href="#">2-299</a> |              | 11              | Enabled       |
| Clear Alarm                             | <a href="#">2-303</a> |              | 12              | Enabled       |
| Minor Alarm                             | <a href="#">2-304</a> |              | 13              | 15 min        |
| Major Alarm                             | <a href="#">2-304</a> |              | 14              | 30 min        |
| Time Period                             | <a href="#">2-305</a> |              | 15              | 5 min         |
| Attendant Display                       | <a href="#">2-305</a> |              | 16              | Enabled       |
| STATION ATTRIBUTES PAGE A PROGRAMMING   |                       | FLASH 50/51  | Btn 19          |               |
| Paging Access                           | <a href="#">2-243</a> | Page A       | 1               | Enabled       |
| Do Not Disturb                          | <a href="#">2-147</a> |              | 2               | Enabled       |
| Conference Enable/Disable (Per Station) | <a href="#">2-101</a> |              | 3               | Enabled       |
| Executive Override                      | <a href="#">2-152</a> |              | 4               | Disabled      |
| Privacy (Per Station)                   | <a href="#">2-256</a> |              | 5               | Enabled       |
| System Speed Dial Access                | <a href="#">2-276</a> |              | 6               | Enabled       |
| Line Queuing                            | <a href="#">2-91</a>  |              | 7               | Enabled       |
| Preferred Line Answer                   | <a href="#">2-253</a> |              | 8               | Enabled       |
| Off-Hook Voice Over (OHVO)              | <a href="#">2-238</a> |              | 9               | Disabled      |
| Call Forward - Enable/Disable           | <a href="#">2-25</a>  |              | 10              | Enabled       |

Table F-1: Feature Default Values

| Features   | Page #                     | Program Code | Flexible Button | Default Value                             |
|--|----------------------------|--------------|-----------------|---|
| Forced Least Cost Routing  | <a href="#">B-15</a>       |              | 11              | Disabled                                  |
| Executive Override Blocking  | <a href="#">2-154</a>      |              | 13              | Disabled                                  |
| CO Line Ringing Options  | <a href="#">2-93</a>       |              | 14              | Muted Ring                                |
| Name/Number Display at Idle  | <a href="#">2-232</a>      |              | 15              | Name (Enabled)                            |
| CO Line, Loop, and Pool Buttons  | <a href="#">2-85</a>       |              | 17              | Disabled                                  |
| Admin Access   | <a href="#">2-106</a>      |              | 18              | Disabled                                  |
| Return to Flash 50/51 "Select a Station Range" or "Enter Station Number" Display | --                         |              | 24              | --  |
| STATION ATTRIBUTES PAGE B PROGRAMMING  |                            | FLASH 50/51  | Btn 20          |   |
| Station Identification   | <a href="#">2-283/3-21</a> | Page B       | 1               | 0 (STSe 24-Btn Key set)<br>6 (SLT w/o MW) |
| Station Day Class of Service (COS)   | <a href="#">2-63</a>       |              | 2               | COS 1                                     |
| Station Night Class of Service (COS)   | <a href="#">2-64</a>       |              | 3               | COS 1                                     |
| Speakerphone Programming   | <a href="#">2-272</a>      |              | 4               | 0<br>(Full Speakerphone)                  |
| Pickup Group(s) Programming  | <a href="#">2-47</a>       |              | 5               | Group 1                                   |
| Paging Zone(s) Programming   | <a href="#">2-246</a>      |              | 6               | Zone 1                                    |
| School Zone  | <a href="#">2-267</a>      |              | 7               | Disabled                                  |
| Line Group Access - Station  | <a href="#">2-73</a>       |              | 8               | Group 1                                   |
| LCR Class of Service (COS)   | <a href="#">B-16</a>       |              | 9               | 0 (Unrestricted Access)                   |
| Off-Hook Preference Programming  | <a href="#">2-263</a>      |              | 10              | 00=No specific button preferred; Enabled  |
| Flexible Button Programming  | <a href="#">2-163</a>      |              | 11              | (blank)                                   |
| Keypad Mode  | <a href="#">2-212</a>      |              | 12              | Inactive Mode                             |
| Voice Mail ID Translation  | <a href="#">2-339</a>      |              | 13              | XXXX=Station #                            |
| Display Flexible Buttons   | <a href="#">2-168</a>      |              | 14              | None                                      |
| Light Control  | <a href="#">2-224</a>      |              | 15              | 0=None                                    |
| Cordless Key Telephone Unit (CKTU) Button  | <a href="#">2-105</a>      |              | 17              | 00=No button assigned                     |
| Headset Mode   | <a href="#">2-173</a>      |              | 18              | 1=2.5 mm jack                             |
| Return to Flash 50/51 "Select a Station Range" or "Enter Station Number" Display | --                         |              | 24              | --  |
| STATION ATTRIBUTES PAGE C PROGRAMMING  |                            | FLASH 50/51  | Btn 21          |   |
| Internal No Answer Forward   | <a href="#">2-36</a>       | Page C       | 1               | None                                      |
| Internal Busy/DND Forward  | <a href="#">2-36</a>       |              | 2               | None                                      |
| Day External No Answer Forward   | <a href="#">2-37</a>       |              | 3               | None                                      |
| Day External Busy/DND Forward  | <a href="#">2-37</a>       |              | 4               | None                                      |
| Day No Answer Timer  | <a href="#">2-38</a>       |              | 5               | 10 sec                                    |

## Quick Reference

Table F-1: Feature Default Values

| Features   | Page #                | Program Code | Flexible Button | Default Value               |
|--|-----------------------|--------------|-----------------|-----------------------------|
| SLT Loop Supervision   | <a href="#">2-89</a>  |              | 7               | Enabled                     |
| Outbound DID Number  | <a href="#">2-195</a> |              | 8               | None                        |
| Distinctive Ring Tone - Station  | <a href="#">2-143</a> |              | 13              | 00                          |
| Night External No Answer Forward   | <a href="#">2-37</a>  |              | 14              | None                        |
| Night External Busy/DND Forward  | <a href="#">2-37</a>  |              | 15              | None                        |
| Special External No Answer Forward   | <a href="#">2-37</a>  |              | 16              | None                        |
| Special External Busy Forward  | <a href="#">2-38</a>  |              | 17              | None                        |
| Call Coverage Ring Timer   | <a href="#">2-24</a>  |              | 18              | 05 sec                      |
| Return to Flash 50/51 "Select a Station Range" or "Enter Station Number" Display | --                    |              | 24              | --                          |
| STATION ATTRIBUTES PAGE D PROGRAMMING  |                       | FLASH 50/51  | Btn 22          |                             |
| Tenant Group Assignments   | <a href="#">2-312</a> | Page D       | 1               | Group 0                     |
| Internal DND Forward   | <a href="#">2-39</a>  |              | 3               | None                        |
| External DND Forward   | <a href="#">2-39</a>  |              | 4               | None                        |
| Night No Answer Timer  | <a href="#">2-38</a>  |              | 5               | 10 sec                      |
| Special No Answer Timer  | <a href="#">2-38</a>  |              | 6               | 10 sec                      |
| Back Light Display   | <a href="#">2-17</a>  |              | 7               | 0=Off                       |
| FLEXIBLE NUMBERING ASSIGNMENT  |                       | FLASH 52     |                 |                             |
| Changing a Flexible Code   | <a href="#">2-171</a> |              | 1               | None                        |
| Erasing a Flexible Code  | <a href="#">2-171</a> |              | 2               | None                        |
| Selecting a Flexible Code  | <a href="#">2-171</a> |              | 21              | None                        |
| Next Code Entry  | <a href="#">2-171</a> |              | 22              | None                        |
| Previous Code Entry  | <a href="#">2-171</a> |              | 23              | None                        |
| Selecting a Fixed Code   | <a href="#">2-171</a> |              | 24              | None                        |
| NAME/NUMBER TRANSLATION TABLE  |                       | FLASH 55     |                 |                             |
| Route Number   | <a href="#">2-233</a> |              | 1               | 1                           |
| Phone Number   | <a href="#">2-234</a> |              | 2               | None                        |
| Name   | <a href="#">2-234</a> |              | 3               | None                        |
| Clear Entry  | <a href="#">2-234</a> |              | 4               | None                        |
| Scroll to next Table   | --                    |              | 18              | --                          |
| Scroll to previous Table   | --                    |              | 19              | --                          |
| Locate a specific Table  | --                    |              | 20              | --                          |
| ICLID FEATURES   |                       | FLASH 56     |                 |                             |
| Enable/Disable   | <a href="#">A-7</a>   |              | 1               | NO=Disabled                 |
| Name in Display  | <a href="#">A-7</a>   |              | 2               | YES=phone number in display |

Table F-1: Feature Default Values

| Features                                    | Page #       | Program Code | Flexible Button | Default Value                    |
|---|--------------|--------------|-----------------|----------------------------------|
| Baud Rate Display                           | A-8          |              | 3               | 9600 Baud                        |
| Port Assignment                             | A-8          |              | 4               | Port #1                          |
| UCD GROUP PROGRAMMING                       |              | FLASH 60     |                 |                                  |
| Alternate UCD Group Assignment              | 4-4          |              | 2               | None                             |
| UCD Overflow Station Assignment             | 4-6          |              | 3               | None                             |
| UCD Primary Agent Assignments               | 4-8          |              | 7               | None                             |
| UCD Primary RAN                             | 4-9          |              | 10              | None                             |
| UCD Secondary RAN                           | 4-12         |              | 11              | None                             |
| Scroll to next Group                        | --           |              | 22              | --                               |
| Scroll to previous Group                    | --           |              | 23              | --                               |
| Return to Flash 60 "Select a Group" Display | --           |              | 24              | --                               |
| UCD TIMERS                                  |              | FLASH 61     |                 |                                  |
| UCD Ring Timer                              | 4-11         |              | 1               | 60 sec                           |
| UCD Message Interval Timer                  | 4-5          |              | 2               | 60 sec                           |
| UCD Overflow Timer                          | 4-8          |              | 3               | 60 sec                           |
| UCD Wrap-up Timer                           | 4-14         |              | 4               | 004 sec                          |
| UCD No-Answer Recall Timer                  | 4-5          |              | 5               | 000=Disabled                     |
| UCD No-Answer Retry Timer                   | 4-6          |              | 6               | 300 sec                          |
| UCD ANNOUNCEMENT TABLES (RAN)               | 4-10,<br>C-5 | FLASH 62     | 1-8             | None                             |
| VOICE MAIL PROGRAMMING                      |              | FLASH 65     |                 |                                  |
| Voice Mail Groups (440-447)                 | 2-333        |              | 1-8             | None                             |
| Alternate Voice Mail Group                  | 2-334        |              | 9               | None                             |
| Standard Leave Mail Index Entry             | 2-334        |              | 10              | VM Group 1 Index = 0             |
| Retrieve Mail Index Entry                   | 2-335        |              | 11              | VM Group 1 Index = 1             |
| Station Assignment(s)                       | 2-335        |              | 12              | None                             |
| No Answer Leave Mail Index Entry            | 2-336        |              | 13              | VM Group 1 Index = # (none)      |
| Busy Leave Mail Index Entry                 | 2-336        |              | 14              | VM Group 1 Index = # (none)      |
| VOICE MAIL OUTPUTSING TABLE                 |              | FLASH 66     |                 |                                  |
| Voice Mail In-Band Signaling                |              |              |                 |                                  |
| (Table 0)                                   | 2-351        |              | 1               | Pre=P7 Suf=None                  |
| (Table 1)                                   | 2-351        |              | 2               | Pre=P7 Suf=*                     |
| (Tables 2-6)                                | 2-351        |              | 3-7             | None                             |
| (Table 7)                                   | 2-351        |              | 8               | Pre=P7; Suf=2 (one-touch record) |
| Voice Mail Disconnect Table                 | 2-353        |              | 9               | None                             |

## Quick Reference

Table F-1: Feature Default Values

| Features                               | Page #                | Program Code | Flexible Button | Default Value    |
|--|-----------------------|--------------|-----------------|------------------|
| VOICE MAIL IN-BAND FEATURES            |                       | FLASH 67     |                 |                  |
| Voice Mail In-Band Digits              | <a href="#">2-351</a> |              | 1               | Enabled          |
| Voice Mail Transfer/Forward            | <a href="#">2-346</a> |              | 2               | Enabled          |
| Voice Mail Broker                      | <a href="#">2-347</a> |              | 3               | Enabled          |
| VMID Digit Length                      | <a href="#">2-347</a> |              | 4               | 3                |
| VM Port                                | <a href="#">2-348</a> |              | 6               | Disabled         |
| VM Port Number                         | <a href="#">2-348</a> |              | 7               | 3                |
| TOLL RESTRICTION PROGRAMMING           |                       | FLASH 70     |                 |                  |
| Allow Table A Programming              | <a href="#">2-321</a> |              | 1               | None             |
| Deny Table A Programming               | <a href="#">2-323</a> |              | 2               | None             |
| Allow Table B Programming              | <a href="#">2-321</a> |              | 3               | None             |
| Deny Table B Programming               | <a href="#">2-323</a> |              | 4               | None             |
| Special Table 1 Programming            | <a href="#">2-324</a> |              | 5               | All Codes Denied |
| Special Table 2 Programming            | <a href="#">2-324</a> |              | 6               | All Codes Denied |
| Special Table 3 Programming            | <a href="#">2-324</a> |              | 7               | All Codes Denied |
| Special Table 4 Programming            | <a href="#">2-324</a> |              | 8               | Home             |
| Area Code for Special Table 1          | <a href="#">2-324</a> |              | 9               | None             |
| Area Code for Special Table 2          | <a href="#">2-324</a> |              | 10              | None             |
| Area Code for Special Table 3          | <a href="#">2-324</a> |              | 11              | None             |
| Displaying Toll Table Entries          | <a href="#">2-325</a> |              | 12              | None             |
| LCR TABLES PROGRAMMING                 |                       | FLASH 75     |                 | None             |
| 3-Digit Area/Office Code Table         | <a href="#">B-6</a>   |              | 1               | None             |
| 6-Digit Area/Office Code Table         | <a href="#">B-7</a>   |              | 2               | None             |
| Exception Code Table                   | <a href="#">B-8</a>   |              | 3               | None             |
| Route List Table                       | <a href="#">B-8</a>   |              | 4               | None             |
| Digit Insert/Delete Table              | <a href="#">B-10</a>  |              | 5               | None             |
| Daily Start Time Table                 | <a href="#">B-11</a>  |              | 6               | None             |
| Weekly Schedule Table                  | <a href="#">B-13</a>  |              | 7               | None             |
| LCR Routing for Toll Information       | <a href="#">B-14</a>  |              | 8               | Table 0          |
| INITIALIZE DATABASE PARAMETERS         |                       | FLASH 80     |                 |                  |
| Initialize System Parameters           | <a href="#">2-292</a> |              | 1               | Default          |
| Initialize CO Line Attributes          | <a href="#">2-68</a>  |              | 2               | Default          |
| Initialize Station Attributes          | <a href="#">2-280</a> |              | 3               | Default          |
| Initialize CO Port Assignments / Codes | <a href="#">2-98</a>  |              | 4               | Default          |
| Initialize Exception Tables            | <a href="#">2-326</a> |              | 5               | Default          |



Table F-1: Feature Default Values

| Features                                      | Page #                | Program Code | Flexible Button | Default Value |
|---|-----------------------|--------------|-----------------|---------------|
| Initialize System Speed Numbers               | <a href="#">2-278</a> |              | 6               | Default       |
| Initialize LCR Tables                         | <a href="#">B-19</a>  |              | 7               | Default       |
| Initialize ICLID - DID Tables                 | <a href="#">A-10</a>  |              | 8               | Default       |
| Initialize Directory Dialing Table Parameters | <a href="#">2-138</a> |              | 9               | Default       |
| Initialize Hunt Group Parameters              | <a href="#">2-182</a> |              | 10              | Default       |
| Initialize UCD Group Parameters               | <a href="#">4-15</a>  |              | 11              | Default       |
| Initialize Voice Mail* Group Parameters       | <a href="#">2-343</a> |              | 12              | Default       |
| Initialize DID-TIE Parameters                 | <a href="#">2-127</a> |              | 13              | Default       |
| Initialize Verified Account Code Table        | <a href="#">2-13</a>  |              | 14              | Default       |
| Initialize ISDN Parameters                    | <a href="#">2-209</a> |              | 15              | Default       |
| System Reset                                  | <a href="#">2-298</a> |              | 20              | ---           |
| PRINT SYSTEM DATABASE PARAMETERS              |                       | FLASH 85     |                 |               |
| Print System Parameters                       | <a href="#">2-296</a> |              | 1               | Default       |
| Print CO Line Attributes                      | <a href="#">2-70</a>  |              | 2               | Default       |
| Print Station Attributes                      | <a href="#">2-282</a> |              | 3               | Default       |
| Print CO Port Parameters / Codes              | <a href="#">2-98</a>  |              | 4               | Default       |
| Print Exception Tables                        | <a href="#">2-327</a> |              | 5               | Default       |
| Print System Speed Numbers                    | <a href="#">2-279</a> |              | 6               | Default       |
| Print LCR Tables                              | <a href="#">B-20</a>  |              | 7               | Default       |
| Print Entire System Database                  | <a href="#">2-109</a> |              | 8               | Default       |
| Print ICLID - DID Tables                      | <a href="#">A-12</a>  |              | 9               | Default       |
| Print Directory Dial Table Parameters         | <a href="#">2-139</a> |              | 10              | Default       |
| Print Hunt Group Parameters                   | <a href="#">2-183</a> |              | 11              | Default       |
| Print UCD Group Parameters                    | <a href="#">4-16</a>  |              | 12              | Default       |
| Print Voice Mail* Group Parameters            | <a href="#">2-344</a> |              | 13              | Default       |
| Print DID-TIE Parameters                      | <a href="#">2-128</a> |              | 14              | Default       |
| Print Verified Account Codes                  | <a href="#">2-13</a>  |              | 15              | Default       |
| Print ISDN Parameters                         | <a href="#">2-210</a> |              | 16              | Default       |
| LOAD DATABASE ROUTINE                         |                       | FLASH 86     |                 |               |
| Upload Database                               | <a href="#">E-7</a>   |              | 1               | PC Only       |
| Download Database                             | <a href="#">E-7</a>   |              | 2               | PC Only       |

*Quick Reference*

---

## Default Numbering Plan

| Function  | Code                      | Digital | Attendant | Single Line | Page                  |
|---|---------------------------|---------|-----------|-------------|-----------------------|
| 911 Alert View/Delete (requires button)         | 608/608+FLASH             | •       | •         |             | <a href="#">3-5</a>   |
| Account Code (requires button)                  | 627                       | •       | •         | •           | <a href="#">2-9</a>   |
| Answering Machine Ring                          | 654+[0]                   | •       | •         |             | <a href="#">2-15</a>  |
| Answering Machine Speaker                       | 654+[1]                   | •       | •         |             | <a href="#">2-15</a>  |
| Attendant                                       | 0                         | •       |           | •           | --                    |
| Attendant Clear Alarm                           | 606                       |         | •         |             | <a href="#">2-305</a> |
| Attendant CO Line External (Off-Net) Forward    | 603+[NNN]+[YYYY]          |         | •         |             | <a href="#">3-6</a>   |
| Attendant Custom Message                        | 694+[XX]+message          |         | •         |             | <a href="#">3-7</a>   |
| Attendant Day/Night/Special (requires button)   | 631 (DND key)             |         | •         |             | <a href="#">3-8</a>   |
| Attendant Directory List Programming            | 693                       |         | •         |             | <a href="#">3-9</a>   |
| Attendant Disable Outgoing CO Line              | 602+press CO line button  |         | •         |             | <a href="#">3-12</a>  |
| Attendant Override (requires button)            | 601                       |         | •         |             | <a href="#">3-13</a>  |
| Attendant Setting Time and Date                 | 692+date and time entry   |         | •         |             | <a href="#">3-14</a>  |
| Attendant Unavailable                           | 607                       |         | •         |             | <a href="#">3-16</a>  |
| Attendant Voice Mail Alarm Clear                | 656                       |         | •         |             | <a href="#">3-17</a>  |
| Background Music                                | 632+[0 (off), 1, or 2]    | •       | •         |             | <a href="#">2-16</a>  |
| Back Light Display                              | 637                       | •       | •         |             | <a href="#">2-17</a>  |
| Call Back                                       | 622                       |         |           | •           | <a href="#">2-20</a>  |
| Call Coverage - Non-Ringing (requires button)   | 647+[XXX]                 | •       | •         |             | <a href="#">2-23</a>  |
| Call Coverage - Ringing (requires button)       | 646+[XXX]                 | •       | •         |             | <a href="#">2-23</a>  |
| Call Forward                                    | 640+[C]                   | •       | •         | •           | <a href="#">2-25</a>  |
| Call Forward - External (Off-Net)               | [640]+[*]+[YYYY]          | •       | •         | •           | <a href="#">2-32</a>  |
| Call Forward - Follow Me                        | 642+[XXX]+[C]+destination | •       | •         | •           | <a href="#">2-30</a>  |
| Call Park (location 1-8 & 9-14)                 | 430-437 & 424-429         | •       | •         | •           | <a href="#">2-44</a>  |
| Call Park - Personal                            | 438                       | •       | •         | •           | <a href="#">2-45</a>  |
| Call Park - Station                             | 439+[XXX]                 | •       | •         |             | <a href="#">2-46</a>  |
| Call Park Pickup - Station                      | #6+[XXX]                  | •       | •         | •           | <a href="#">2-46</a>  |
| Call Park Pickup - System (location 1-8 & 9-14) | #430-#437 & #424-#429     | •       | •         | •           | <a href="#">2-44</a>  |
| Call Pickup (requires button)                   | #0                        | •       | •         | •           | <a href="#">2-49</a>  |
| Caller ID Display (Answered Calls)              | 659                       | •       | •         |             | <a href="#">A-14</a>  |
| Caller ID Display (Unanswered Calls)            | 635                       | •       | •         |             | <a href="#">A-15</a>  |
| Caller ID Name/Number (requires button)         | 653                       | •       | •         |             | <a href="#">A-4</a>   |

| Function                                  | Code             | Digital | Attendant | Single Line | Page                  |
|---|------------------|---------|-----------|-------------|-----------------------|
| Calling Forward Override                  | 5#[XXX]+press[B] | •       | •         | •           | 2-43                  |
| Calling Station Handsfree Mode Override   | 7#[XXX]          | •       | •         | •           | 2-43                  |
| Calling Station Tone Mode Override        | 6#[XXX]          | •       | •         | •           | 2-43                  |
| Clear Call Forward, DND, Personal Message | 662              | •       | •         | •           | 2-25, 2-147,<br>2-248 |
| CO Line (Idle) Direct Access              | 88+[LLL]         | •       | •         | •           | 2-67                  |
| CO Line Group Access Code (group 1-23)    | 801-823          | •       | •         | •           | 3-6                   |
| CO Line Group Access Code (all groups)    | 824              | •       | •         | •           | 3-6                   |
| CO Line Queue                             | 621              | •       | •         | •           | 2-92                  |
| CO Line Queue Cancel                      | 626              | •       | •         | •           | B-5                   |
| Dial-By-Name                              | 6*               | •       | •         |             | 2-140                 |
| Directory Dial                            | 680              | •       | •         |             | 2-136                 |
| Do Not Disturb                            | 631              | •       |           | •           | 2-148                 |
| Door Opener                               | 665              | •       | •         | •           | 2-260                 |
| DTMF Receiver Test                        | 657              | •       | •         | •           | --                    |
| Executive Override                        | 625              | •       | •         | •           | 2-153                 |
| Flash (Centrex)                           | 660              |         |           | •           | 2-59                  |
| Headset Mode                              | 634              | •       | •         |             | 2-175                 |
| Hunt Group (group 1-8)                    | 450-457          | •       | •         | •           | --                    |
| In and Out Button (requires button)       | 644              | •       | •         |             | 2-184                 |
| Intercom Button (requires button)         | 645              | •       | •         |             | 2-185                 |
| Last Number Redial                        | 650              | •       | •         |             | 2-215                 |
| LCR (E911 active on CO Line)              | 800              | •       | •         | •           | B-5                   |
| LCR (if active) or CO Line Group 1        | 9                | •       | •         | •           | B-5                   |
| Loop Key (requires button)                | 89               | •       | •         |             | 2-87                  |
| Message Wait Answer                       | 663              | •       | •         | •           | 2-225                 |
| Modem                                     | 499              |         |           | •           | 2-79                  |
| Modem - Voice Mail Access                 | 498              |         |           | •           | 2-348                 |
| Name in Display                           | 690              | •       | •         | •           | 2-231                 |
| Night Service (requires button)           | 604              | •       | •         |             | 2-235                 |
| Off Hook Voice Over (requires button)     | 628              | •       | •         |             | 2-239                 |
| Page - All Call                           | 700              | •       | •         | •           | 2-242                 |
| Page - External Zone                      | 760 or 761       | •       | •         | •           | 2-242                 |
| Page - Internal Zones 1-20, All           | 701-720, 721     | •       | •         | •           | 2-242                 |
| Page - Meet Me (Answer)                   | 770              | •       | •         | •           | 2-244                 |
| Personal Messages                         | 633+[ZZ]         | •       |           | •           | 2-248                 |
| Release Button (requires button)          | 641              | •       | •         |             | 3-24                  |

## Quick Reference

| Function   | Code           | Digital | Attendant | Single Line | Page        |
|--|----------------|---------|-----------|-------------|-------------|
| Repeat Redial                                    | 643            | •       | •         |             | 2-259       |
| Ring Down / Hot Line / Off-Hook Preference       | 691+[BB]       | •       | •         |             | 2-265       |
| Ring Tone  | 695+[RR]       | •       | •         |             | 2-145       |
| Save Number Redial                               | [SPEED]+[*]    | •       | •         |             | 2-266       |
| School Zone                                      | 630            | •       | •         | •           | 2-267       |
| SLT Conference Park                              | 664            |         |           | •           | 2-104       |
| SLT Directed Call Pickup                         | #1             |         |           | •           | 2-49        |
| SLT Message Wait                                 | 623            |         |           | •           | 2-225       |
| SLT Speed Programming                            | 661+[YYYY]     |         |           | •           | 2-276       |
| SLT Volume                                       | 638+[V]        |         |           | •           | 2-356       |
| Software Version                                 | 605            | •       | •         |             | 2-272       |
| Speed Dial                                       | [SPEED]+[YYYY] | •       | •         |             | 2-275       |
| Speed Dial for SLT; digital only for Admin Prog  | 668+[YYYY]     | •       |           | •           | 2-276/2-163 |
| Station Numbers (Fixed)                          | 100-149        | •       | •         | •           | --          |
| Station/Port Fixed Number                        | 611            | •       | •         |             | 2-162       |
| Station Relocate                                 | 636+[XXX]      | •       | •         |             | 2-291       |
| Stop Trace                                       | 658            | •       | •         |             | --          |
| UCD Available/Unavailable                        | 566            | •       | •         | •           | 4-12        |
| UCD Calls In Queue Status Display (any group)    | 567+[UUU]      | •       | •         |             | 4-3         |
| UCD Group (group 1-16)                           | 550-565        | •       | •         | •           | --          |
| UCD Wrap-up End Button                           | 584            | •       | •         |             | 4-14        |
| Unanswered CO Call Transfer                      | 639            |         | •         |             | 2-53        |
| Universal Day/Night Answer                       | #5             | •       | •         | •           | 2-329       |
| Voice Mail Group (group 1-8)                     | 440-447        | •       | •         | •           | --          |
| Voice Mail Message Cancel (VM Port only)         | 421+[MMMM]     |         |           | •           | --          |
| Voice Mail Message Set (VM Port only)            | 420+[MMMM]     |         |           | •           | --          |
| Voice Mail Message Set w/count (VM Port only)    | 422+[MMMM]     |         |           | •           | --          |
| Voice Mail One Touch Recording (requires button) | 649+[VWV]      | •       | •         |             | 2-349       |
| Voice Mailbox Button (requires button)           | 460-467+[VMID] | •       | •         |             | 2-342       |

## LEGEND --

*B* = Button w/ feature code: 622=Call Back, 620=Camp On,  
 625=Executive Override, 623=Message Wait, 628=OHVO  
*BB* = Button Number  
*C* = Call Forward Condition Code (6-9=All Calls, No Answer,  
 Busy, Busy/No Answer; \* = Off-Net)  
*LLL* = CO Line Number (001-028)  
*MMMM* = 2- to 4-digit Mailbox Number  
*NNN* = CO Line Group Access Code of group to be forwarded  
 (801-823 = CO Group 1-23, 824 = All CO Groups)

*RR* = Ring Tone Number (00-36)  
*V* = Volume Control Level (0-9)  
*VWV* = Voice Mail Group Number (440-447)  
*XX* = Custom Message Number (21-30)  
*XXX* = Intercom Station Numbers  
*YYYY* = Speed Dial Bin Numbers (9000-9099)  
*ZZ* = Personalized Messages

---

---

# Index

## Numerics

- 3-Digit Area/Office Code Table (LCR) B-6
- 6-Digit Office Code Table (LCR) B-7
- 7/11 Digit Number Plan for PRI 2-200
- 911
  - 911 Alert 2-6, 3-5
  - 911 Feature 2-5
  - Enhanced 911
    - Integration 2-7
    - Power Failure Station 2-8

## A

- Account Codes 2-8
  - Forced 2-9
  - Traveling COS (Verified) 2-10
  - Verified Account Code Table
    - Initialize 2-13
    - Print 2-13
- ACD
  - Wrapup Timer 4-14
- Administration
  - Access 2-106
  - Password 2-108
- Allow Table 2-321
- Answering a Recall 2-258
- Answering Machine Emulation 2-14
- Attendant
  - CO Line External (Off-Net) Forward 3-6
  - Custom Messages 3-7
  - Day/Night/Special 3-8
  - Directory List Programming 3-9
  - Disable Outgoing CO Line 3-12
  - Display - T-1 Alarms 2-305, 3-17
  - Display Timer 3-21
  - Override 3-13
  - Preset Forward 3-24
  - Recall Timer 3-24
  - Setting Time and Date 3-14
  - Speed Dial - System Storing 3-25
  - Station Assignment 3-15
  - Unavailable (Alternate Position) 3-16
- Auto Call Back - BLF Flash Rate 2-22

- Automatic Call Back Timer 2-21
- Automatic Privacy 2-16

## B

- Background Music 2-16
- Backlight Display 2-17
- Barge-In Warn Tone 2-157
- Battery Backup (Memory) 2-18
- Baud Rate Assignments 2-19
- Bipolar Variations Alarm 2-302
- BLF 2-132
- Blue Alarm 2-300
- Busy Lamp Field 2-132
- Busy Leave Mail Index Entry 2-336
- Button Mapping for Remote Admin Programming E-5

## C

- Call Back 2-20
- Call Cost Display B-18
- Call Coverage 2-22
  - Ring Timer 2-24
- Call Forward
  - All Calls 2-27
  - Busy 2-28
  - Busy / No Answer 2-29
  - Button Flash Rate 2-33
  - Call Forward - External (Off-Net) 2-32
  - Display 2-34
  - Enable/Disable 2-25
  - Follow Me 2-30
  - No Answer 2-31
  - Override 2-43
  - Preset 2-34
    - Call Forward - CO Line 2-39
    - Call Forward - Day/Night/Special 2-118
    - Forward Timer (Incoming Call to a Destination) 2-120
  - Preset Call Forward
    - Station 2-35
  - Preset Forward Timer (Incoming Call to a Destination) 2-42
  - Station 2-25

- 
- Call Park 2-44
    - Personal 2-45
    - Recall Timer 2-45
    - Station 2-46
    - System 2-44
  - Call Pickup 2-47
    - Directed 2-49
    - Group 2-49
  - Call Proceeding 2-208
  - Call Transfer 2-50, 2-53
  - Caller ID Name/Number 2-34, A-4
  - Calling Number 2-201
  - Calling Station
    - Handsfree Mode Override 2-43
    - Tone Mode 2-43
  - Camp On 2-54
    - Button Flash Rate 2-55
    - Recall 2-55
  - Card Slot Programming 2-55
  - Card Slot Programming (Flash-based Voice Mail) C-4
  - Centrex
    - Centrex/PBX 2-57
    - Centrex/PBX Transfer 2-59
    - CO / PBX Programming 2-57
    - Off-Hook Preference 2-58
    - PBX Dialing Codes 2-60
    - Private Line Appearance 2-58
    - Programming \*, #, and Hook-Flashes into Speed Dial 2-58
  - CKTU 2-212
    - Feature Button 2-105
  - Class of Service 2-61
    - CO Line 2-62
    - Station Day COS 2-63
    - Station Night COS 2-64
  - Clear Alarm 2-303
  - CO
    - Call Transfer 2-53
    - Direction 2-97
    - Flexible Port Assignment 2-66
    - Line
      - Access 2-67
      - Attributes 2-68
        - Initialize 2-68
        - Print 2-70
      - Button Flash Rate 2-80
      - CO Direction 2-97
      - CO Line Group Programming 2-74
      - Display Ring Assignments 2-81
      - DTMF Sending 2-71
      - Group Queuing 2-75
      - Groups 2-73
      - Guard Timer 2-83
      - Identification 2-76
      - Identification Display 2-76
      - Incoming Ringing Assignment 2-78
      - In-Use Hold (I-Hold) Flash Rate 2-87
      - Line Group Access - Station 2-73
      - Line Queuing 2-91
      - Loop and Pool Buttons 2-85
      - Queue 2-91
      - Queue Button Flash Rate 2-93
      - Queued CO Ringing Flash Rate 2-96
      - Recall CO Ringing Flash Rate 2-95
      - Release Timer 2-82
      - Reminder Ring Timer 2-96
      - Reseize Timer 2-83
      - Ringing Assignments 2-78
      - Ringing Options 2-93
      - Seize Timer 2-84
      - Transfer CO Ringing Flash Rate 2-95
      - Transmit Volume 2-84
    - Loop and Pool 2-85
    - Port Parameters and Feature Codes 2-98
      - Initialize 2-98
      - Print 2-98
      - Ring Detect Timer 2-99
  - CO/PBX Lines (Toll Restrictions) 2-328
  - Computer Telephony Integration 2-212
  - Conference 2-101
    - Combinations 2-103
    - Conference / DISA Timer 2-102
    - Enable/Disable 2-101
  - Connect Request 2-208
  - Cordless Key Telephone Unit Feature Button 2-105
  - CTI 2-212
  - Custom Messages 3-7

**D**

Daily Start Time Table (LCR) B-11  
 Data Errors Alarm 2-303  
 Data Terminal Program Codes Cross Reference E-4  
 Database  
     Administration 2-106  
         Access 2-106  
         Password 2-108  
     Initialization E-6  
     Printout (Dump) 2-109  
     Programming Worksheets E-7  
     Upload/Download 2-262  
     Upload/Download Routine E-7  
 Day Ring - External 2-159  
 Daylight Saving Time 2-110  
 Default LCR Database B-15  
 Deny Table 2-323  
 Dial By Name 2-140  
 Dial Pulse  
     Parameters 2-111  
     Sending 2-111  
 DID 2-112  
     Collect Timer 2-126  
     DID Digits 2-123  
     DID/TIE Signaling 2-124  
     DID-TIE Parameters  
         Initialize 2-127  
         Print 2-128  
     Erasing a DID Table Entry 2-115  
     Incoming Signaling 2-124  
     Name Assigned to DID Number 2-114  
     Phone Number Programming 2-114  
 DID/ICLID  
     Ringing Assignments 2-116  
     View Ringing Assignments 2-117  
 Direct Inward Dialing 2-112  
 Direct Inward System Access 2-129  
 Direct Station Selection 2-132  
 Direct Transfer Mode 2-133  
 Directed Call Pickup 2-49  
 Directory Dial Table Parameters  
     Initialize 2-138  
     Print 2-139  
 Directory Dialing 2-134  
 Directory List Programming 3-9

Directory Number  
     Primary Rate Interface (PRI) 2-198  
 DISA 2-129  
     Access Code 2-129  
     Call Forwarding 2-130  
     CO-to-CO 2-131  
     Programming 2-129  
     Timer 2-102  
 Disable Outgoing CO Line 3-12  
 Disconnect Timer 2-207  
 Distinctive Ring Tone  
     Enabling/Disabling 2-143  
 Distinctive Ring Tone - Digital Station 2-143  
 Distinctive Ringing  
     CO Line Distinctive Ring Tone 2-141  
 DND / Page Block 2-147  
 Do Not Disturb  
     Button Flash Rate 2-150  
     DSS/BLF Flash Rate 2-150  
     One Time Do Not Disturb 2-149  
 Do Not Disturb / Page Block 2-147  
 DSS 2-132  
 DSS/BLF Console with Map 3-17  
 DTMF / Dial Pulse Programming 2-71  
 DTMF On/Off Time Operation 2-72  
 DTMF Sending 2-71

**E**

ECOM E-10, E-11  
     Downloading Database E-11  
     Uploading Database E-10  
 Erasing a DID Table Entry 2-115  
 Exception Code Table (LCR) B-8  
 Exclusive Hold 2-176  
     Flash Rate 2-176  
     Recall Timer 2-177  
 Executive Override 2-152  
     Barge-In Warn Tone 2-157  
     Blocking 2-154  
     Enable/Disable 2-152  
     Warning Tone 2-156  
 Executive/Secretary Pairs 2-158  
 External  
     Day Ring 2-159  
     Night Ring 2-159

**F**

Fax Detect 2-160  
 Feature Codes  
   Initialize 2-98  
   Print 2-98  
 Fixed Station/Port Number 2-162  
 Flash 2-58  
   Rates (Programmable) 2-162  
   Timer 2-59  
 Flexible Button  
   Display Flexible Buttons 2-168  
   Function Assignment 2-163  
 Flexible Numbering 2-171  
 Forced Account Codes (Toll Restrictions) 2-328  
 Forced Least Cost Routing B-15  
 Forward Override 2-43  
 Frame Slip Alarm 2-302  
 Framing (ISDN) 2-198

**G**

Group Call Pickup 2-49  
 Group Listening 2-172  
 Guard Timer 2-83

**H**

Handsfree Mode Override 2-43  
 Headset Mode 2-173  
 Hearing Aid Compatible 2-176  
 Hold  
   Exclusive 2-176  
   Preference 2-177  
   System 2-178  
   System Hold Recall Timer 2-178  
 Hot Keypad 2-179  
 Hot Line 2-263  
 Hot Line / Ring Down 2-179  
 Hunt Group Parameters  
   Initialize 2-182  
   Print 2-183  
 Hunt Groups 2-179  
 Hunting Assignment  
   Pilot 2-180  
   Pilot All Ring 2-180  
   Station 2-180  
 HyperTerminal  
   Downloading Database E-9

Uploading Database E-8

**I**

ICLID 2-185  
   Answered Call Management Table 3-22, A-14  
   Baud Rate Display A-8  
   Call Management Tables 3-22, A-14  
   Calling Number/Name Display A-5  
   Enable/Disable A-7  
   ICLID-DID Tables  
     Initialize A-10  
     Print A-12  
   Incoming Number/Name for SMDR Records A-6  
   Local Name Translation A-6  
   Name in Display A-7  
   Port Assignment A-8  
   Programming A-6  
   Ring Delay Timer A-9  
   Unanswered Call Management Table 3-23, A-15  
 ICLID/DID Ringing Assignments 2-116  
 Idle Speaker Mode 2-183  
 In-Band Signaling (VM) 2-351  
 Initialize  
   CO Line Attributes 2-68  
   CO Port Parameters & Feature Codes 2-98  
   DID-TIE Parameters 2-127  
   Directory Dial Table Parameters 2-138  
   Hunt Group Parameters 2-182  
   ICLID-DID Tables A-10  
   ISDN/VoIP Parameters 2-209  
   LCR Tables B-19  
   Station Attributes 2-280  
   System Parameters 2-292  
   System Speed Numbers 2-278  
   Toll Restriction Exception Tables 2-326  
   UCD Group Parameters 4-15  
   Verified Account Code Table 2-13  
   Voice Mail Group Parameters 2-343  
 Insert/Delete Table (LCR) B-10  
 Intercom  
   Buttons 2-185  
   Calling 2-187



Incoming Intercom Ringing Flash Rate 2-188  
 Signaling Select 2-188  
 Transfer 2-189  
 Inter-Digit Time-Out 2-189  
 In-Use Hold (I-Hold) Flash Rate 2-87  
 ISDN 2-190  
   Call Proceeding 2-208  
   Calling Number 2-201  
   Connect Request 2-208  
   Directory Number  
     PRI 2-198  
   Disconnect Timer 2-207  
   Framing 2-198  
   Leading  
     011 2-200  
     1 2-199  
   Link Disconnect 2-208  
   Loopback 2-201  
   Max Out I-Frames 2-199  
   Maximum  
     Number Retransmission 2-203  
     Octets 2-203  
     TEI Request 2-204  
     XID Retransmission 2-204  
   Message Exchange Timer 2-205  
   Minimum  
     TEI ID Check Message 2-205  
     TEI ID Request 2-205  
     XID Retransmission 2-206  
   Power Programming 2-198  
   PRI 7/11 Digit Number Plan 2-200  
   Programming  
     Page A 2-197  
     Page B 2-202  
   Release Request 2-207  
   Restart Request Timer 2-209  
   Set-Up Timer 2-207  
   T-200 2-204  
 ISDN/VoIP Parameters  
   Initialize 2-209  
   Print 2-210

## K

Keyset Mode 2-212

## L

Last Number Redial 2-215  
 LCD Display Contrast 2-215  
 LCD Interactive Display 2-216  
 LCR B-1  
   3-Digit Area / Office Code Table B-6  
   6-Digit Office Code Table B-7  
   Call Cost Display B-18  
   Call Progress B-14  
   Daily Start Time Table B-11  
   Default Database B-15  
   Enable/Disable B-18  
   Exception Code Table B-8  
   Flowchart B-4  
   Forced Least Cost Routing B-15  
   Insert/Delete Table B-10  
   LCR Class of Service (COS) B-16  
   Operation (When LCR is Enabled) B-5  
   Printout B-21  
   Programming Tables B-5  
   Route List Table B-8  
   Routing for Toll Information B-14  
   Tables B-3  
     Initialize B-19  
     Print B-20  
   Weekly Schedule Table B-13  
 Leading  
   011 2-200  
   1 2-199  
 Leading Digit 2-223  
 Least Cost Routing B-1  
   Enable/Disable B-18  
 Light Control 2-224  
 Line Group Access - Station 2-73  
 Line Queue Button Flash Rate 2-93  
 Link Disconnect 2-208  
 LNR 2-215  
 Loop and Pool Buttons 2-85  
 Loop Supervision Programming  
   CO Line 2-88  
   CO Line - Forced Disconnect 2-89  
   SLT 2-89  
 Loopback 2-201

**M**

Mailbox Button 2-342  
 Major Alarm 2-304  
 Max Out I-Frames 2-199  
 Maximum  
   Number Retransmission 2-203  
   Octets 2-203  
   TEI Request 2-204  
   XID Retransmission 2-204  
 Meet Me Page 2-244  
 Message  
   Exchange Timer 2-205  
   Wait 2-225  
 Message Wait / VM Button Flash Rate 2-341  
 Message Waiting Indication 2-340  
 Message Waiting Reminder Tone 2-226  
 Messages - Custom 3-7  
 Minimum  
   TEI ID Check Message 2-205  
   TEI ID Request 2-205  
   XID Retransmission 2-206  
 Minor Alarm 2-304  
 Modem Answer Timer 2-261  
 Music-On-Hold 2-226  
   Assignments 2-227  
   Enable/Disable 2-227  
   Per CO Line 2-121, 2-228  
 Mute Key 2-229  
 Muted Ring 2-230

**N**

Name Assigned to DID Number 2-114  
 Name In Display 2-231  
 Name/Number Display At Idle 2-232  
 Name/Number Display When Using PRI 2-191  
 Name/Number Translation Table 2-233  
 Night Ring - External 2-159  
 Night Service 2-235  
   Automatic Night Mode Operation 2-236  
   Automatic/Manual Operation 2-235  
   Day of Week Programming 2-236  
   External Night Ringing 2-236  
   Manual Operation 2-236  
   Night Class of Service (COS) 2-236  
   Night Ringing Assignments 2-237  
   Universal Night Answer (UNA) 2-237

Weekly Night Mode Schedule 2-237  
 No Answer Leave Mail Index Entry 2-336

**O**

Off-Hook  
   Preference 2-263  
   Signaling 2-237  
   Voice Over 2-238  
 OHVO 2-238  
 One-Touch Recording 2-349  
   Warning Tone 2-351  
 Outbound DID Number on PRI 2-195  
 Outside Call 2-241  
   Answering 2-241  
   Making 2-241  
   Placing the call on hold 2-241  
 Overflow Destination - Hunt Group 2-181

**P**

Page Block 2-147  
 Paging 2-242  
   Access 2-243  
   Meet Me 2-244  
   Time-Out Timer 2-245  
   Warning Tone 2-245  
   Zone(s) 2-246  
 Pause Timer 2-247  
 PBX 2-57  
 Personal Call Park 2-45  
 Personal Messages 2-248  
   Custom Messages 2-249  
   Date and Time Entry Messages 2-250  
   Flexible Button 2-252  
   Pre-assigned Messages 2-248  
   Scrollable Canned Messages 2-251  
 Pickup Groups 2-47  
 Pool Buttons 2-85  
 Preferred Line Answer 2-253  
 Preset Call Forward  
   ACD, Voice Mail, UCD, or Hunt Groups 2-34  
   Off-Net 2-34  
   Per CO Line 2-34  
   Stations 2-35  
 PRI 7/11 Digit Number Plan 2-200  
 Primary Rate Interface (PRI) CO Type 2-197  
 Print

---

---

- CO Line Attributes 2-70
- CO Port Parameters & Feature Codes 2-98
- DID-TIE Parameters 2-128
- Directory Dial Table Parameters 2-139
- Hunt Group Parameters 2-183
- ICLID-DID Tables A-12
- ISDN/VoIP Parameters 2-210
- LCR Tables B-20
- Station Attributes 2-282
- System Parameters 2-296
- System Speed Numbers 2-279
- Toll Restriction Exception Tables 2-327
- UCD Group Parameters 4-16
- Verified Account Code Table 2-13
- Voice Mail Group Parameters 2-344
- Privacy
  - Automatic 2-16
  - Release 2-254
- Private Line 2-258
- Program Mode Entry E-6
- Programming Button Mapping E-5
- Pulse Dial Inter-Digit Timer 2-111
- Pulse-To-Tone Switchover 2-112

## Q

- Queued CO Ringing Flash Rate 2-96

## R

- Recall 2-258, 3-24
  - Answering 2-258
  - CO Ringing Flash Rate 2-95
  - Transfer Recall Timer 2-258
- Red Alarm 2-301
- Redial 2-259
- Relay Programming 2-260
- Release
  - Request 2-207
- Release Button 3-24
- Release Timer 2-82
- Reminder Ring Timer 2-96
- Remote
  - Administration 2-261
  - System Monitor And Maintenance 2-262
- Reseize Timer 2-83
- Restart Request Timer 2-209
- Ring Detect Timer 2-99

- Ring Down 2-263
- Ring Down / Hot Line / Off-Hook Preference 2-263
- Ringback on Transfer 2-52
- Ringling Assignments
  - DID/ICLID 2-116
  - Viewing 2-117
- Route List Table (LCR) B-8

## S

- Save Number Redial 2-266
- School Zone 2-267
- Seize Timer 2-84
- Setting System Time/Date 3-14
- Set-Up Timer 2-207
- Single Line Telephone (refer to SLT topic) 2-270
- SLT 2-270
  - Compatibility 2-270
  - DTMF Receiver Timer 2-270
  - DTMF Receivers (Toll Restrictions) 2-328
  - Hook Flash Bounce Timer 2-271
  - Hook Flash Timer 2-271
  - Loop Supervision Programming 2-89
- SMDR 2-286
  - Baud Rate Display 2-289
  - Call Qualification Timer 2-290
  - Character Print Assignment 2-289
  - Enable/Disable 2-288
  - Long Distance - All Calls Option 2-288
  - Port Assignments 2-289
  - Printout 2-287
- SNR 2-266
- Software
  - Identification Code 3-25
  - Version (MPB) 2-272
  - Version Upgrade of Flash-based Voice Mail System C-37
- Speakerphone 2-272
- Special Table 2-324
- Speed Bins - Chaining 2-278
- Speed Dial 2-275
  - Access - System 2-276
  - Station 2-275
  - System Storing 3-25
- Station
  - Attributes 2-280

- 
- Initialize 2-280
  - Print 2-282
  - Call Park 2-46
  - Distinctive Ring Tone 2-143
  - ID for DSS/DLS Console 3-21
  - ID Lock 2-285
  - Identification 2-283
  - Message Detail Recording 2-286
  - Port Inquiry 2-172
  - Relocation 2-291
  - System
    - Call Park 2-44
    - Hold 2-178
      - Recall Timer 2-178
    - Parameters 2-292
      - Initialize 2-292
      - Print 2-296
    - Reset 2-298
    - Speed Numbers
      - Initialize 2-278
      - Print 2-279
    - Time/Date 3-14
  - T**
  - T-1
    - Alarm Programming 2-299
    - Collect Timer 2-310
    - Dial Tone Option 2-308
    - Framing Type 2-311
    - Incoming Signaling 2-310
    - Ringback Option 2-308
    - Signaling Type 2-306
    - Trunking 2-306
  - T-1 Alarms
    - Bipolar Variations Alarm 2-302
    - Blue Alarm 2-300
    - Clear Alarm 2-303
    - Data Errors Alarm 2-303
    - Enable/Disable Carrier Loss Alarm 2-299
    - Frame Slip Alarm 2-302
    - Major Alarm 2-304
    - Minor Alarm 2-304
    - Red Alarm 2-301
    - Time Period 2-305
    - Yellow Alarm 2-301
  - T-200 2-204
  - Text Messaging 2-316
  - TIE Signaling 2-124
  - Time Period 2-305
  - Time/Date 3-14
  - Toll Information (LCR Routing) B-14
  - Toll Restriction 2-318
    - Allow Table 2-321
    - Deny Table 2-323
    - Display Toll Table Entries 2-325
    - Exception Tables
      - Initialize 2-326
      - Print 2-327
    - Related Items 2-328
    - Special Table 2-324
    - Toll Table - Entering 2-320
  - Tone Mode Override 2-43
  - Transfer 2-50
    - Ringback 2-52
  - Transmit Volume 2-84
  - U**
  - UCD 4-3
    - Alternate UCD Group Assignments 4-4
    - Available/Unavailable 4-12
    - Calls In Queue
      - Status Display 4-3
    - Group Parameters
      - Initialize 4-15
      - Print 4-16
    - Incoming CO Direct Ringing 4-4
    - Message Interval Timer 4-5
    - No-Answer
      - Recall Timer 4-5
      - Retry Timer 4-6
    - Overflow
      - Station Assignment 4-6
      - Station Forwarding 4-7
      - Timer 4-8
    - Primary Agent Assignments 4-8
    - Primary Recorded Announcement 4-9
    - Recorded Announcement Tables 4-10, C-5, D-5
    - Recorded Announcements 4-9
    - Ring Timer 4-11

Secondary Recorded Announcement 4-12  
 Wrap-up Timer 4-14  
 UDA/UNA 2-329  
 Uniform Call Distribution (refer to UCD topic)  
 4-3  
 Universal  
   Day Answer (UDA) 2-330  
   Day/Night Answer 2-329  
   Night Answer (UNA) 2-122, 2-331  
 Upgrade Procedure (Flash-based VM) C-37

## V

View DID/ICLID Ringing Assignments 2-117  
 Virtual Station 2-332  
 VM Tone Mode Calling Option 2-338  
 VM Transfer with ID Digits 2-337  
 VMID Station Numbers 2-337  
 Voice Mail 2-333  
   Alternate Voice Mail Group 2-334  
   Broker 2-347  
   Disconnect Table 2-353  
   Flash-based System  
     Programming C-4  
       Card Slot Programming C-4  
       Computer-based Programming C-17  
       Auto Attendant Config C-25  
       Class of Service C-30  
       Debug Information Screen C-36  
       Invalid Digits C-24  
       Mailbox Assignment C-28  
       Messages Waiting Display C-35  
       Open and Close Schedule C-20  
       PBX Integration C-31  
       Programming Flashprom  
         (upload new software  
         versions) C-37  
       Recording Time Left C-31  
       Set System Password C-27  
       System Clock Adjustments C-26  
       System Initialization C-35  
       System Numbering Plan C-21  
       Version Number C-27  
     Programming Devices for Flash-  
       based Voice Mail System C-6

Remote Programming & Maint  
   Connection C-43  
 Telephone-based Programming C-7  
   Access the Sys Admin MB C-7  
   Adding a Mailbox C-10  
   Auto Attendant Config C-12  
   Change Open & Close Schedule  
     C-16  
   Changing a Mailbox Access  
     Code C-9  
   Deleting a Mailbox C-11  
   Listening to a Prompt C-15  
   Mailbox Administration C-9  
   Record a Mailbox Greeting C-11  
   Recording a Prompt C-15  
   Resetting a Message Waiting  
     Indicator C-12  
   Selecting PBX Integration C-14  
   Setting Date and Time C-13  
   Setting Operating Mode C-13  
   System Greetings C-8  
 UCD Recorded Announcement  
   Tables C-5  
 User Operations C-44  
   Accessing Your Mailbox C-45  
   Basics C-44  
   Direct Transfer C-51  
   Disconnect from the System C-45  
   Mailbox Greeting Options C-49  
     Changing  
       Your Mailbox Greeting C-49  
     Deleting  
       Your Mailbox Greeting C-49  
       Your Name C-50  
       Your Temp Greeting C-50  
     Recording  
       Your Name C-49  
       Your Temp Greeting C-50  
     Reviewing  
       Your Mailbox Greeting C-49  
       Your Name C-50  
       Your Temp Greeting C-50  
   Message Options C-45  
     Delete a Message C-46  
     Forward a Copy to Another

- 
- Mailbox C-47
    - Message Information C-47
    - Options While Reviewing C-48
    - Replay a Message C-46
    - Reply to a Message C-47
    - Review Your Messages C-45
    - Save a Message C-46
    - Send a Message C-48
  - Outcall Notification C-51
  - Passwords C-51
  - Setting Up Your Mailbox C-44
  - Voice Prompts Default Listing C-38
  - Group
    - Access 2-342
    - Button 2-342
    - Parameters
      - Initialize 2-343
      - Print 2-344
  - Hard Drive-based System D-1
    - Programming D-4
      - Card Slot Programming D-4
      - Computer-based Programming D-8
        - COS Menus D-18
        - File Manager D-35
        - Menu Options D-26
        - Subscriber Menus D-14
        - System Configuration D-31
        - System Line Menus D-31
        - System List Options D-30
        - System Status D-35
        - Time Control Menus D-29
        - Wizards D-11
          - Backup D-12
          - Integration D-11
          - Logging D-13
          - Prompt Record List D-13
          - Restore D-12
          - Shutdown D-12
          - Software Update D-13
      - Programming Devices D-6
      - Telephone-based Programming D-36
        - Auto Attendant Options D-42
        - Broadcast Messages D-40
        - Default System Prompts D-43
        - Distribution List Options D-39
        - Record Prompts D-36
        - Resetting Date & Time D-41
        - Setting Up Voice Lines D-41
        - System Admin Menus D-36
        - System Admin Options D-41
        - UCD Announcement Tables D-5
    - System Maintenance D-44
      - Activity Reports D-45
      - Command Files D-53
      - Directory Reports D-50
      - Log Reports D-50
      - Messages Reports D-51
      - Registry Variables D-53
      - Settings Reports D-47
      - Troubleshooting D-54
    - User Operations D-56
      - Getting Started D-57
        - Accessing Your Mailbox D-57
        - Setting Up Your Mailbox D-57
      - Mailbox Options D-61
        - Distribution Lists D-62
        - Guest Mailboxes D-63
        - Mailbox State D-61
        - Message Notification D-61
      - Message Options D-58
        - Retrieving Messages D-59
        - Sending a Message D-60
    - ID Digit Length 2-347
    - ID Translation 2-339
    - In-Band Digits 2-346
    - Leave Mail Index Entry 2-334
    - Message Waiting Indication 2-340
    - Modem Access 2-348
    - One-Touch Recording 2-349
    - Outpulsing Table 2-351
    - Retrieve Mail Index Entry 2-335
    - Station Assignments 2-335
    - Transfer/Forward 2-346
    - VM Tone Mode Calling Option 2-338
    - VM Transfer with ID Digits 2-337
    - VMID Station Numbers 2-337
    - Voice Mail System Message Wait Indications - Analog 2-354
    - Volume Control 2-355

---

---

**W**

Wanderer 2-212

Weekly Schedule Table (LCR) B-13

Wink Timer 2-309

**Y**

Yellow Alarm 2-301

