

INTRODUCTION

Congratulations! You have purchased one of the most sophisticated **and unique** cordless telephones on the market. The VT 1511 has been designed to offer a new standard in cordless telephone technology.

Unlike most other cordless phones, the VT 1511 is a completely wireless headset telephone. The VT 1511 digitizes your voice using advanced ADPCM digital voice encoding to provide noise- and distortion-free performance. In most conditions, you will not be able to tell you are using a cordless phone. Gone are the annoyances of static, interference and having to listen to other peoples conversations on your cordless telephone.

The VT 1511 scrambles your voice before it transmits. This allows you the security of knowing that no one can eavesdrop on your conversations.

The VT 1511 uses special memory which is not susceptible to power failures. This provides permanent storage of all memory dial numbers and security codes.

When an optional battery pack is installed in the base unit, the VT 1511 uses this battery to provide operational backup in case of power failure. In this way you have access to headset functions during total power outage. Calls can still be placed and received on the headset without interruption. Up to 5 hours of backup will be possible with a fully charged battery pack in the base unit.

The VT 1511 informs you when another extension is currently in use on the same phone line. The phone will also alert you when you are Out of Range, even when you're not on the phone! The VT 1511 has a very unique space design. When using the headset, you have complete freedom of movement. There are no cords or cables to worry about, so your hands will be free to keep working. The VT 1511 Wireless Headset is a revolution in cordless telephones.

INTRODUCTION

Special Features:

- 900 MHz Operation.
- Fully digital link between headset and base.
- Corded handset on base unit.
- Remote headset charging stand.
- Infrared remote dial card for use with wireless headset.
- Digitally scrambled voice communication.
- 21 number programmable memory for up to 20-digit phone numbers.
- 10-channel operation with auto channel selection.
- Two-way Intercom between corded base unit and wireless headset.
- Out-of-Range indication while the headset is in use or in standby mode.
- Removable headset battery pack.
- Spare battery charger in base unit.
- Battery backup in case of power failure (with optional spare battery pack installed in base).
- Extension in use indicator.
- Message waiting indicator for use with voice mail service.
- Auto line drop from HOLD when an extension phone is picked up.
- 24-bit digital security code.
- Tone and Pulse dialing.
- Low battery detect and warning indicator.
- Up to 7 hours continuous talk time, or 7 days standby time.
- Volume adjustment on Base Handset and Wireless Headset.
- HOLD, FLASH, MUTE and REDIAL functions.
- Hearing-aid compatible receiver.
- Detachable power supplies.
- Non-volatile storage of security code and memory dial records.
- Wall mountable base unit.

This manual is designed to make you familiar with the VT 1511. We strongly recommend you read the entire manual before using your phone.

INTRODUCTION

Parts Checklist

1. Wireless Headset
2. Base Unit With Corded Handset
3. Wall Mounting Bracket
4. Remote Charging Stand For Headset
5. Remote Dial Card
6. AC Power Adapter
7. Battery Pack
8. Telephone Line Cord
9. Operation Manual, Speed dial label, Warranty Card.

To purchase replacement battery packs, call VTech at 1-800-595-9511.

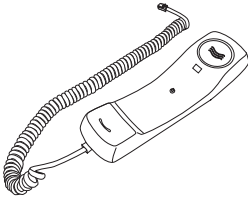

Handset Unit

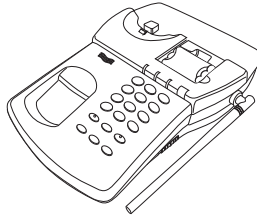

Base Unit



Wall Mounting bracket



Dial Card Remote

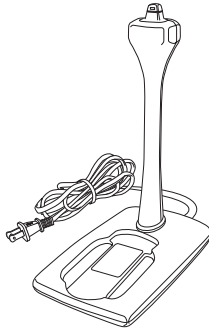

Remote Charging Stand

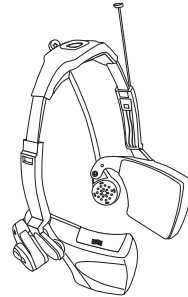

Wireless Headset



AC adaptor



Telephone Line



Rechargeable battery



Memory Dialing Card

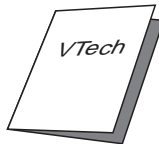

Operation Manual

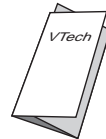

Warranty Card

FCC REGULATIONS

FCC Regulations

This equipment complies with Parts 15 and 68 of the Federal Communications Commission (FCC) rules for the United States. It also complies with regulations RSS210 and CS-03 of Industry and Science Canada. Operation is subject to the following two conditions:

1. This device may not cause interference, and
2. This device must accept any interference, including interference that may cause undesired operation of the device.

A label is located on the underside of the base unit containing either the FCC registration number and Ringer Equivalence Number (REN) or the Industry Canada (IC) registrations number and Load Number. You must, upon request, provide this information to your local telephone company.

Hearing Aid Compatibility

This equipment is compatible with inductively coupled hearing aids.

Should you experience trouble with this telephone equipment, please contact VTech at 1-800-595-9511 for warranty and/or repair information. The telephone company may ask you to disconnect this equipment from the line network until the problem has been corrected.

FCC Part 15

Warning :

Changes or modifications to this unit not expressly approved by the party responsible for compliance could void the user's authority to operate the equipment.

The equipment has been tested and found to comply with part 15 of the FCC rules. These limits are designed to provide reasonable protection against harmful interference in a residential installation. This equipment generates, uses and can radiate radio frequency energy. And, if not installed and used in accordance with the instruction, may cause harmful interference to radio or television reception, which can be determined by turning the equipment off and on, the user is encouraged to try and correct the interference by one or more of the following measures:

- Reorient or relocate the receiving antenna.
- Increase the separation between the equipment and receiver.
- Connect the equipment into an outlet or on a circuit different from that to which the receiver is connected.
- Consult the dealer or a qualified technician for help.

FCC REGULATIONS

FCC Part 68

The FCC requires that you connect your cordless telephone to nationwide telephone network through a modular telephone jack (USOC RJ11C, RJ11W or RJ14).

Your local telephone company may discontinue your service if your equipment causes harm to the telephone network. They will notify you in advance of disconnection, if possible. During notification, you will be informed of your right to file a complaint with the FCC.

Occasionally, your local telephone company may make changes in its facilities, equipment, operation, or procedures that could affect the operation of your equipment. If so, you will be given advance notice of the change to give you an opportunity to maintain uninterrupted service.

The base unit contains no user serviceable parts. The handset contains a user replaceable battery pack.

If it is determined that your telephone equipment is malfunctioning, the FCC requires that it not be used and that it be unplugged from the modular jack until the problem has been corrected. Repairs to this telephone equipment can only be made by the manufacturer or its authorized agents or by others who may be authorized by the FCC. For repair procedures, follow the instructions outlined under the manufacturer's Limited Warranty.

This equipment may not be used on coin service provided by the phone company or Party Lines.

The REN is useful in determining the number of devices you may connect to your telephone line and still enable the devices to ring when you receive a call. The general rule is that the REN value should not exceed 5.0A total; however, contact your local telephone company for the specific number in your area.

Your VT 1511 is designed to operate at the maximum power allowed by the FCC. This means your handset can communicate with the base unit only over a certain distance – which will depend on the location of the base unit and handset, weather, and the construction and layout of your home or office.

IMPORTANT SAFETY INSTRUCTIONS

When using your telephone equipment, basic safety precautions should always be followed to reduce the risk of fire, electric shock and injury to persons, including the following:

1. Read and understand all instructions.
2. Follow all warnings and instructions marked on the product.
3. Unplug this product from the wall outlet before cleaning. Do not use liquid cleaners or aerosol cleaners. Use a damp cloth for cleaning.
4. Do not use this product near water (for example, near a bathtub, kitchen sink, or swimming pool).
5. Do not place this product on an unstable cart, stand, or table. The product may fall, causing serious damage to the product.
6. Slots and openings in the cabinet and the back or bottom are provided for ventilation. To protect it from overheating, these openings must not be blocked by placing the product on a bed, sofa, rug, or similar surface. This product should never be placed near or over a radiator or heat register. This product should not be placed in a built-in installation where proper ventilation is not provided.
7. This product should be operated only from the type of power source indicated on the marking label. If you are not sure of the type of power supply to your home, consult your dealer or local Power Company.
8. Do not allow anything to rest on the power cord. Do not locate this product where persons walking on it will abuse the cord.
9. Never push objects of any kind into this product through cabinet slots as they may touch dangerous voltage points or short out parts that could result in a risk of fire or electric shock. Never spill liquid of any kind on the product.
10. To reduce the risk of electric shock, do not disassemble this product. Opening or removing cabinet parts other than specified access doors may expose you to dangerous voltages or other risks. Incorrect reassembling can cause electric shock when the appliance is subsequently used.
11. Do not overload wall outlets and extension cords as this can result in the risk of fire or electric shock.
12. Unplug this product from the wall outlet and refer servicing to VTech

IMPORTANT SAFETY INSTRUCTIONS

Communications at 1-800-595-9511, under the following conditions:

- When the power supply cord or plug is damaged or frayed.
 - If liquid has been spilled into the product.
 - If the product has been exposed to rain or water.
 - If the product does not operate normally by following the operating instructions. Adjust only those controls that are covered by the operating instructions, because improper adjustments of other controls may result in damage and will often require extensive work by an authorized technician to restore the product to normal operation.
 - If the product has been dropped and the cabinet has been damaged.
 - If the product exhibits a distinct change in performance.
13. Avoid using a telephone (other than a cordless type) during an electrical storm. There may be a remote risk of electric shock from lightning.
 14. Do not use the telephone to report a gas leak in the vicinity of the leak.

SAVE THESE INSTRUCTIONS

THE BATTERY PACK

Charging the Headset Battery Pack

The headset of your VT 1511 cordless telephone is powered by a rechargeable battery pack. It charges automatically whenever the headset is placed on the remote charging stand. You'll know the battery pack needs recharging when:

- The phone emits a warning tone when you rotate the microphone boom into the ON position.
- The phone emits a warning tone when you press PHONE on the remote dial card.
- The headset seems completely dead and does not beep when you press the keys.
- The red LOW BATTERY LED in the wireless headset flashes.

To Charge the Battery Pack

To charge the battery pack, place the headset on the remote charging stand. The two LEDs on the top of the headset will light to show the headset is seated properly and the battery pack is charging.

NOTE:

The VT 1511 uses an advanced inductive charging system. This technology allows the batteries to be recharged without the need for physical charge contacts.

It is recommended that the battery pack be charged for at least 8 hours initially, and 6-8 hours for maintenance charging. You can use your telephone before that with diminished capacity, but it is the best to charge the battery pack fully. It will take several recharge

cycles to maximize the charge capacity of your battery pack. The maximum battery life between charges is 7 hours of continuous talk time or 7 days standby time.

Alternatively, if you have purchased a spare battery pack and it has been charging in the base unit, simply exchange the drained headset battery pack with the fully charged battery pack from the base charger. Place the drained headset battery pack in the base charger.

The base spare battery charger does not charge a battery pack as quickly as the remote charging stand. A full charge requires 24 hours when using the base unit spare battery charger.

To purchase replacement battery packs, call VTech Communications at 1-800-595-9511 .
--

It is impossible to overcharge the battery

The battery pack can be recharged many times, but if you get a low battery warning even after 16 hours of charging on the remote charging stand (or 24 hours in the base spare battery charger), the battery pack(s) should be replaced.

A Word about Rechargeable Batteries

Your battery pack recharges whenever the headset is returned to the remote charging stand. You may return the headset to the remote charging stand whenever it is not in use.

THE BATTERY PACK

To Replace the Headset Battery Pack

1. Remove the battery case cover (on the left ear module of the headset).

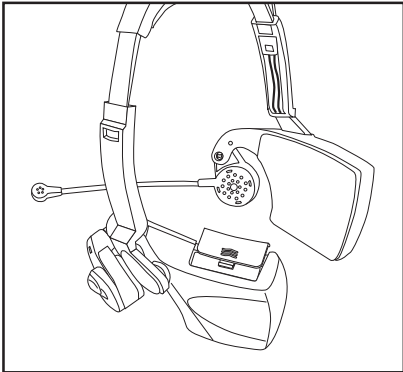

2. Remove the old battery pack. Save it for recharging in the base unit spare battery charger. Do not dispose of this battery in household garbage.
3. Place the new battery pack in the headset. Insert the battery in either way and only make sure the metal contacts on the battery are aligned with the contacts in the headset battery compartment.

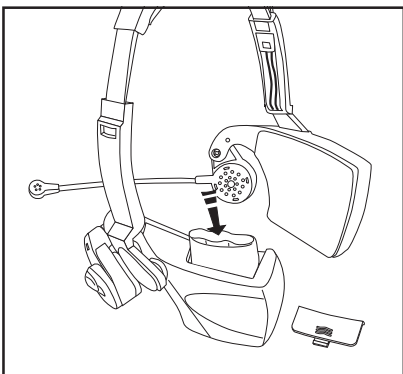

4. Replace the battery case cover.
5. If the new battery pack is not already charged, place the headset on the remote charging stand and allow it to charge for 16 hours.

CAUTION:

To reduce the risk of fire or injury to persons, read and follow the instructions below.

1. Use only VTech rechargeable battery pack.
2. Do not dispose of the battery in a fire. The cell may explode.

IMPORTANT:

Do not dispose of this battery in household garbage. For information on recycling and proper disposal, contact your local solid waste collection or disposal organization.

1. Do not open or mutilate the battery. Released electrolyte is corrosive and may cause damage to the eyes or skin. It may be toxic if swallowed.
2. Exercise care in handling batteries in order not to short the batteries with conducting materials such as rings, bracelets, and keys. The battery or conductor may overheat and cause burns.

To purchase replacement battery packs, call **VTech Communications** at **1-800-595-9511**.

THE BATTERY PACK

Spare Battery Charger

The VT 1511 has a built-in spare battery charger, which is located in the base unit.

Note:

In order to benefit from this feature, you must obtain an optional spare battery from an authorized dealer, or by contacting **VTech Communications at 1-800-595-9511**.

Installation

1. Open the spare battery charger in the base unit.
2. Place a battery pack in the spare battery charger. Make sure the metal contacts on the battery are aligned with the contacts in the spare battery charger.

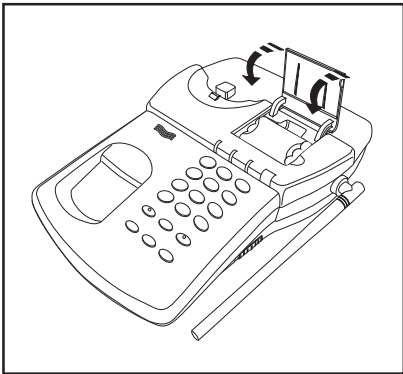

Power Backup Function

When a spare battery pack is installed in the base unit, the VT 1511 uses this battery pack to provide operational backup in case of a power failure. If you have a fully charged battery pack in the spare battery charger and there is a power outage, you will still be able to place and receive calls on the headset for up to 5 hours. When power backup mode is active, the POWER LED will flash slowly.

Replacing a Drained Headset Battery

The spare battery pack can also be used to replace a drained headset battery pack to ensure uninterrupted use. Be sure to put the drained battery pack in the spare battery charger for recharging.

Please note that the spare battery compartment charges at a slower rate than a battery pack charging in the headset (via the remote charging stand). It takes 24 hours to fully charge a battery pack in the spare battery charger.

THE BATTERY PACK

Remote Dial card Battery

The remote dial card uses a standard lithium battery (CR 2025). This battery is not rechargeable, and may need to be replaced periodically. Under normal use, the battery will provide up to 2 years of service.

If the dial card appears dead and you are no longer able to dial numbers or control the headset functions, the dial card battery may need to be replaced.

1. Purchase a replacement CR 2025 lithium battery (available from most electronics and camera dealers).
2. Remove the dial card battery cover and the old battery.
3. Place the new CR 2025 battery in the dial card. Make sure the positive (+) side is facing up.
4. Replace the battery cover.

IMPORTANT

Do not dispose of this battery in household garbage. For information on recycling and proper disposal, contact your local solid waste collection or disposal organization.

1. Do not open or mutilate the battery. Released electrolyte is corrosive and may cause damage to the eyes or skin. It may be toxic if swallowed.
2. Exercise care in handling batteries in order not to short the batteries with conducting materials such as rings, bracelets, and keys. The battery or conductor may overheat and cause burns.

GETTING STARTED

Setting up Your VT 1511

Choose an area near an electrical outlet and a telephone wall jack.

AC Power Adapter

Plug the AC power adapter into an electrical outlet and the DC connector to the back of the base unit.

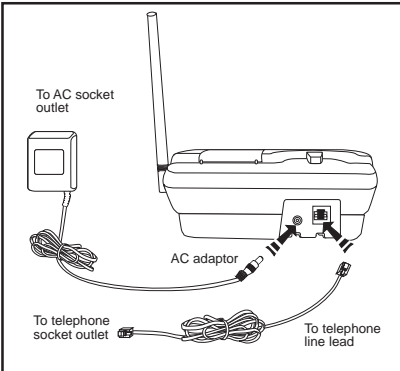

CAUTION

Use only CLASS 2 9V DC POWER SUPPLY included with your phone.

Plug the power cord of the Remote Charging Stand into an electrical outlet.

Charge the Battery

Charge the headset battery pack before use. The battery pack recharges automatically whenever the headset is on the remote charging stand. The batteries must be charged for 16 hours before using your phone for the first time.

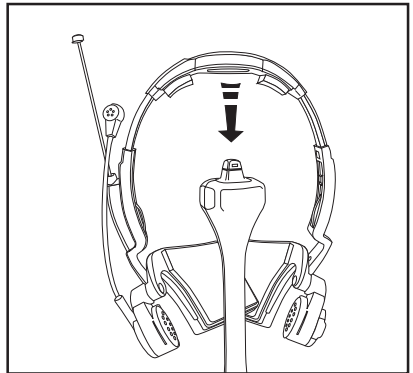
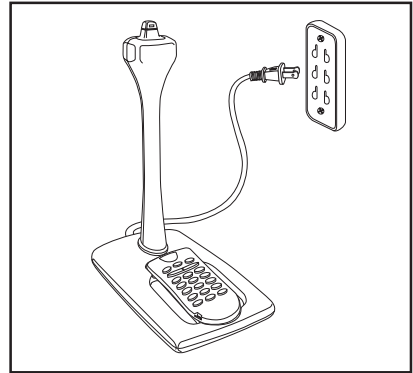

Headset and Base Ringer

The headset and base ringer are programmed ON as the factory default. Refer to **PROGRAMMING THE RINGER** for more information.

Tone / Pulse Selection

To select the desired dialing mode, set the switch on the underside of the base unit to TONE or PULSE.

GETTING STARTED

Connect Telephone Line Cord

Plug one end of the telephone cord into a wall jack and the other end into the back of the base unit.

Check for a dial tone. After the battery pack is charged, put on the headset and flip the microphone down into the ON position. You should hear dial tone.

If not, see **IN CASE OF DIFFICULTY**.

Fill in the telephone number card on the remote charging stand.

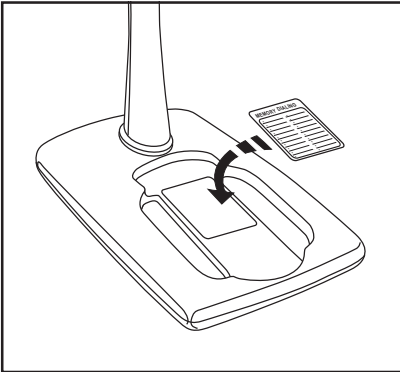

CAUTION :

1. Never install telephone wiring during a lightning storm.
2. Never install telephone jacks in wet locations unless the jack is specifically designed for wet locations.
3. Never touch uninsulated telephone wires or terminals unless the telephone line has been disconnected at the network interface.
4. Use caution when installing or modifying telephone lines.

WALL MOUNTING

The Wall Mounting bracket is designed to fit on standard Wall Mounting plates.

- 1. Choose a spot near an electrical outlet (120v AC) and a telephone jack.** Your phone requires a modular telephone jack. The power cord is six feet long; make sure there is an electrical outlet within reach of the base. A wall switch should not control the outlet. If the switch is ever turned off, your phone may not function (*unless you have a fully charged battery in the spare battery charger*).
- 2. Position the wall-mounting bracket on the base.** Line up the tabs on the wall-mounting bracket with the holes on the bottom of the base. Snap the wall-mounting bracket firmly in place.
- 3. Mount the base on the wall.** Position the base so the mounting studs will fit into the holes on the wall-mounting bracket. Slide the base down on the mounting studs until it locks into place

- 4. Connect the telephone line cord.** The telephone line cord has a snap-in plug at each end. Insert one end into the jack on the back of the base, and insert the other end of the plug into the wall jack.
- 5. Plug the AC adapter into an electrical outlet and the DC connector into the power jack located on the back of the base unit.**

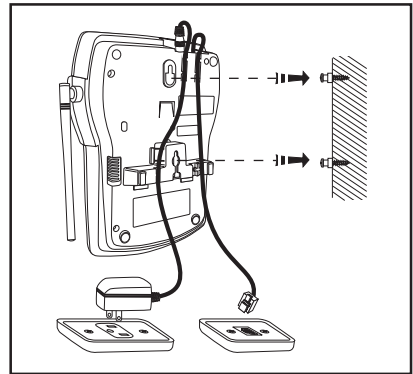

THE HEADSET LAYOUT

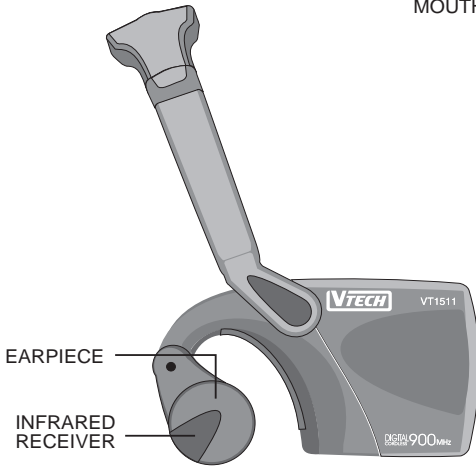
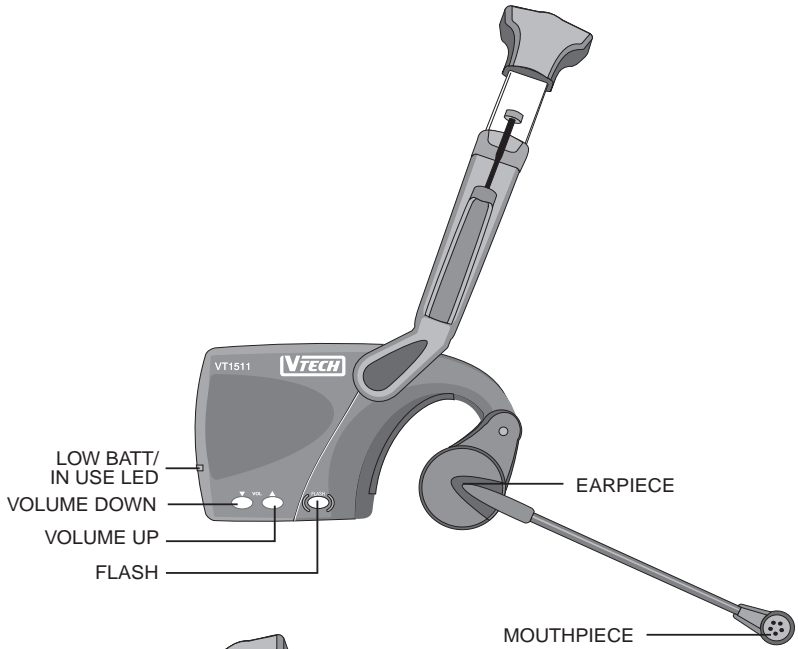

THE BASE LAYOUT

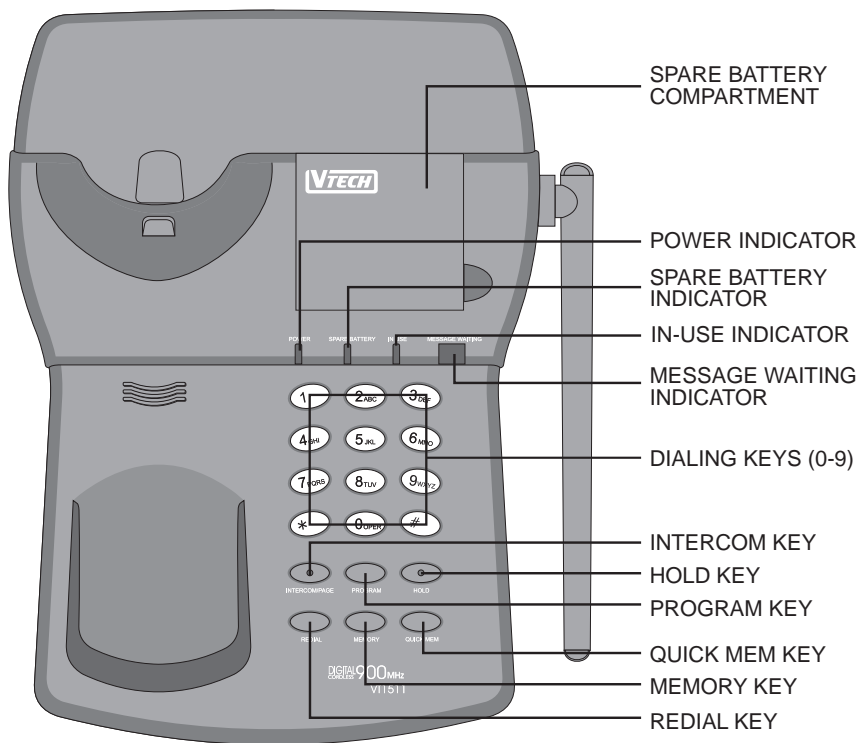

THE REMOTE LAYOUT

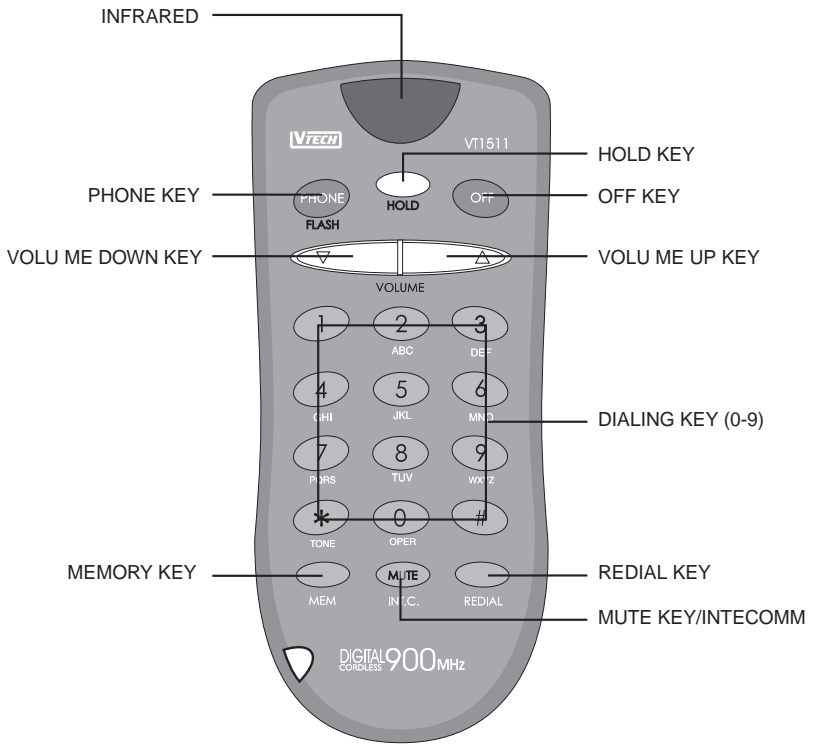

BASE UNIT FEATURES

Status Type	Description
<i>POWER</i>	<ul style="list-style-type: none"> ● When the POWER LED is lit solid GREEN, it indicates that there is power to the base unit.
<i>IN USE(off hook)</i>	<ul style="list-style-type: none"> ● When the IN USE LED is lit solid GREEN it indicates that the phone is currently IN USE. ● When the IN USE LED is flashing GREEN it indicates that either an active telephone cord is not connected to the base unit, or that an extension telephone is currently using the line.
<i>RINGING</i>	<ul style="list-style-type: none"> ● The IN USE LED flashes GREEN in cadence with an incoming call.
<i>CALL HOLD</i>	<ul style="list-style-type: none"> ● The HOLD LED flashes GREEN to indicate that the telephone line has been placed on hold.
<i>SPARE BATTERY</i>	<ul style="list-style-type: none"> ● When this LED is lit solid GREEN it indicates that a spare battery is installed in the base unit.
<i>INTERCOM</i>	<ul style="list-style-type: none"> ● When this LED is flashing GREEN, this indicates that the headset is placing an INTERCOM call to the base unit. ● When this LED is lit solid GREEN, this indicates that the base is currently on an INTERCOM call with the headset.
<i>MESSAGE</i>	<ul style="list-style-type: none"> ● When this indicator is flashing RED, it indicates that messages are waiting in your voicemail (service provided by some local telephone companies).
<i>POWER BACKUP</i>	<ul style="list-style-type: none"> ● When the POWER LED blinks GREEN, it indicates that the base is running off of the spare battery and is in POWER BACKUP mode.
Lost Link of headset	<ul style="list-style-type: none"> ● When the base lost link with the headset, both HOLD and INTERCOM LEDS will keep flashing

BASE UNIT FEATURES

The Base unit of the VT 1511 is a normally functioning telephone. To make or receive calls from the base unit, simply lift the corded handset and answer or dial normally.

DIALING Keys

Use these keys to:

- Dial numbers
- To program memory
- To program ring styles for base and headset

INTERCOM Key

- Lift the corded handset on the base unit and press this key to place (or answer) an intercom call.

PROGRAM Key

- Use this key to program Speed Dial Memory or Ringer Tones. See Speed Dial Memory and Programming Ringer Tones.

HOLD Key

- Press this key to place an active call (on the corded handset) on HOLD.
- Press again to release the HOLD and return to normal conversation.

REDIAL Key

Press this key to redial the last number dialed from the base unit.

MEMORY Key

Use this key to program and dial Speed dial Memory numbers. See Speed Dial Memory.

QUICK MEM Key

Press this key to automatically dial the Speed Dial number stored in location 00.

HOW TO PUT ON THE WIRELESS HEADSET

The VT 1511 is a unique telephone. Unlike most cordless phones, the VT 1511 is a completely wireless headset telephone.

In order to get the most use and enjoyment from your VT 1511, please carefully review the instructions below.

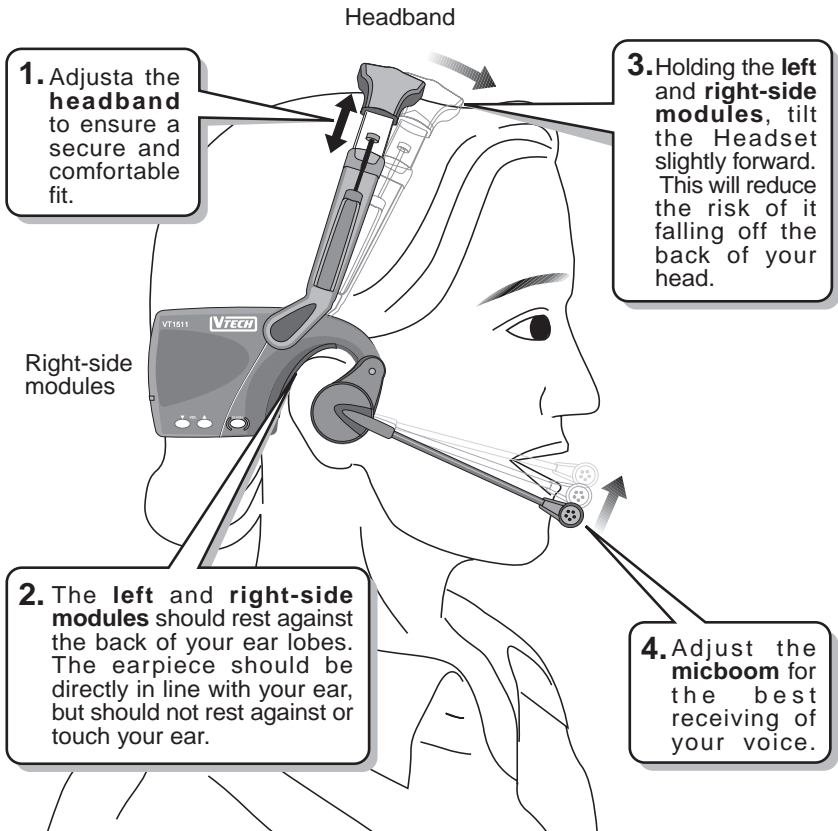

QUICK REFERENCE GUIDE

Setup

- Plug AC adapter into a standard electrical outlet and base unit.
- Plug Power cord of remote charging stand into a standard electrical outlet. Let headset battery pack charge for 16 hours before first use.
- Set TONE/PULSE switch on underside of base unit.
- Connect the telephone line cord to the base unit and telephone jack.

Making Calls

From the base unit:

- Lift the handset and dial a call normally.
- To end the call hang up

From the wireless headset:

- Put on the wireless headset.
- Flip the microphone down to the ON position. You should hear dial tone.
- Using the infrared dial card (with the keypad facing you) dial a call normally.
- To end the call, flip the microphone up to the OFF position, or using the dial card, press OFF.

Answering Calls

From the base unit:

- Lift the handset and talk.
- To end the call, hang up.

From the wireless headset

- Put on the wireless headset.
- Flip the microphone down to the ON position and talk.
- To end the call, flip the microphone up to the OFF position, or using the dial card, press OFF.

To Place a Call on Hold

From the base unit:

- During an active call, press the HOLD key. To return to the call press HOLD again.

From the wireless headset:

- During an active call, press the HOLD key on the dial card. To return to the call press HOLD again.

Making an Intercom Call

From the base unit:

- Lift the handset and press the INTERCOM key. The base unit will ring the wireless headset up to five times, unless the person using the headset answers the intercom call.
- This feature can also be used to locate the headset.

From the wireless headset:

Note: The microphone must be in the down position, and the headset must have been turned OFF using the dial card, prior to making an intercom call.

- Using the dial card (with the keypad facing you) press the INT.C key.
- The headset will ring the base unit up to five times, unless the person using the base unit answers the intercom call.

Storing Speed Dial Memory

Note: Speed Dial Memory can only be programmed from the base unit, but can be dialed from either the base unit or wireless headset.

- The phone must be OFF and the corded handset should be cradled.
- Press the PROGRAM key.
- Enter the 2 digit memory location where you want to store the number (00 to 20).

QUICK REFERENCE GUIDE

- Enter the number you wish to store (up to a maximum of 20 digits).
- Press the MEMORY key to store the number and exit.

Dialing from Memory

From the base unit:

- Lift the handset.
- Press the MEMORY key and then enter the 2 digit memory location code (00 to 20) to be dialed.
- The number stored in the selected memory location will be automatically dialed.

Or

- Lift the handset and press the QUICK MEM key to automatically dial the number stored in location '00'.

From the wireless headset:

- Put on the wireless headset.
- Flip the microphone down to the ON position. You should hear dial tone.
- Using the dial card (with keypad facing you), press the MEM key followed by the 2 digit memory location code (00 to 20) to be dialed.
- The number stored in the selected memory location will be automatically dialed.

Using Redial

From the base unit:

- Lift the handset and press the REDIAL key. The last number dialed from the base unit will be automatically dialed.

From the wireless headset:

- Put on the wireless headset.
- Flip the microphone down to the ON position. You should hear dial tone.
- Using the dial card (with the keypad facing you) press the REDIAL key. The last number dialed from the dial card will be automatically dialed.

FLASH

From the wireless headset:

- During an active call, press the FLASH key on the dial card to flash the line. This feature is commonly used with services such as Call Waiting.

Or

- During an active call, press the FLASH key located on the right side of the wireless headset. The FLASH key has is surround by () to help you locate it by touch.

ADDITIONAL OPERATION

Call Waiting

Call Waiting is a subscription service available from most local telephone service providers. Contact your provider for details.

While you are on a call, you will hear an alert signal (if you subscribe to this service), indicating that a second caller is trying to reach you. You can switch from the active call to the Call Waiting call simply by pressing the FLASH key to flash the line. To return to the original call, press the FLASH key again.

You can use either the FLASH key on the dial card, or the FLASH key on the right side of the wireless headset. Both keys have the same function.

Message Waiting

Your VT 1511 is capable of detecting a Visual Message Waiting Indication, generated by many telephone service providers. If you subscribe to Voice mail service from your local Telephone Company, and Visual Message Waiting Indication is provided, the MESSAGE WAITING LED on the base unit will light to alert you of new, unplayed Voice mail messages:

Once you play all of your new Voice mail messages, the MESSAGE WAITING indication will be automatically turned off.

Temporary TONE

If you have PULSE telephone service, this feature allows you to temporarily switch to TONE dialing for access to answering machines, bank by phone, use of calling cards and other special services.

First, dial the call normally. Then activate the Temporary Tone feature by pressing the * key (on either the base unit or dialcard). You can then press the numbers or symbols you need, and your phone will send the proper signals.

When you end the call, the phone will automatically go back to PULSE service.

Volume Adjustment

Base unit handset:

- There is a three position switch (Low, Med, Hi) on the left side of the handset. Select the volume level that you prefer.

Wireless headset:

- During an active call, you can use the volume up and down keys on the dialcard or on the right side of the wireless headset, to adjust the current volume level.
- On the right side of the wireless headset, the volume up key has a small raised bump on it to help you differentiate it from the volume down key.

ADDITIONAL OPERATION

Extension In Use Indication

When another telephone on the same line is currently in use, the IN USE LED on the base unit, and the IN USE/BAT LOW LED on the wireless headset will flash green.

Programming the Ringer Type

The ringer of the base unit and wireless headset can be independently programmed to one of four different tones or OFF.

All programming functions must be done using the base unit keypad.

Programming the Base Ringer:

- The phone must be OFF and the corded handset should be cradled.
- Press the PROGRAM key.
- Press the # key (to enter ringer program mode).
- Press the 1 key (to program the base ringer)
- Press the 1,2,3 or 4 key to review the four available ringers. After each press, the corresponding ringer will be played from the base unit.

- Once you have selected the ringer you prefer, press the PROGRAM key to confirm.
- You can also control the volume setting of the base ringer using the switch on the right side of the base. The switch has three positions, OFF, Low or High. Choose the volume setting that you prefer.

Programming the Wireless Headset Ringer:

- The phone must be OFF and the corded handset should be cradled.
- Press the PROGRAM key.
- Press the # key (to enter ringer program mode).
- Press the 2 key (to program the headset ringer)
- Press the 1,2,3 or 4 key to review the four available ringers. Or press the 0 key to turn the headset ringer OFF. After each press, the corresponding ringer will be played from the headset.
- Once you have selected the ringer you prefer, press the PROGRAM key to confirm.

MAINTENANCE

Taking Care of Your Telephone

Your VT 1511 cordless telephone contains sophisticated electronic parts, so it must be treated with care.

Avoid rough treatment

Place the headset down gently. Save the original packing material to protect your telephone if you ever need to ship it.

Avoid water

Your telephone can be damaged if it gets wet. Do not use the headset outdoors in the rain, or handle it with wet hands. Do not install your base unit near a sink, bathtub or shower.

Electrical storms

Electrical storms can sometimes cause power surges harmful to electronic equipment.

For your own safety, use caution when using electric appliances during storms.

Cleaning your telephone

Your telephone has a durable plastic casing that should retain its luster for many years. Clean it only with a soft cloth slightly dampened with water or a mild soap. Do not use excess water or cleaning solvents of any kind.

Remember that electrical appliances can cause serious injury if used when you are wet or standing in water. If your base unit should fall into water, DO NOT RETRIEVE IT UNTIL YOU UNPLUG THE POWER CORD AND TELEPHONE CORDS FROM THE WALL. Then pull the unit out by the unplugged cords.

WARRANTY

WHAT DOES OUR WARRANTY COVER?

- Any defect in material or workmanship.

FOR HOW LONG AFTER THE ORIGINAL PURCHASE?

- To the original purchaser only – ONE YEAR.

WHAT WILL VTECH DO?

- At our option, repair or replace your unit.

HOW DO I SEND MY UNIT, IN OR OUT OF WARRANTY?

- Call VTech Communications customer service for Return Authorization at:
1-800-595-9511
- Properly pack your unit. Include any cables & accessories, which were originally provided with the product. We recommend using the original carton and packing materials.
- Include in the package a copy of the sales receipt or other evidence of date of original purchase (if the unit was purchased within the last twelve months).
- Print your name and address, along with a description of the defect, and include this in the package.
- Include payment for any service or repair not covered by warranty, as determined by VTech Communications.
- Ship the unit via UPS Insured, or equivalent to:

VTECH COMMUNICATIONS
8770 SW NIMBUS AVENUE
BEAVERTON, OREGON 97008

VTech Communications assumes no responsibility for units sent without prior Return Authorization

WHAT DOES OUR WARRANTY NOT COVER?

- Batteries
- Damage from misuse, neglect, or acts of nature (lightning, floods, power surges, etc.)
- Products which may have been modified or incorporated into other products
- Products purchased and/or operated outside the USA, its territories, or Canada.
- Products serviced by the owner or a service facility not expressly authorized by VTech Communications
- Products purchased more than 12 months from current date
- Units purchased in "AS IS" condition or units purchased as "Distressed Merchandise".

HOW DOES STATE LAW RELATE TO THIS WARRANTY?

- This warranty gives you specific rights. You may also have other rights that vary from state to state.

IF YOU PURCHASED YOUR TELEPHONE IN CANADA

Please call **1-604-273-5131**

TECHNICAL SPECIFICATIONS

FREQUENCY CONTROLL

Crystal Controlled Dual POLL Synthesizer

TRANSMIT FREQUENCY

Headset : 925.05 MHz to 927.75 MHz
(all ten channels within this range)

Base : 902.3 MHz to 905.0 MHz
(all ten channels within this range)

RECEIVE FREQUENCY

Headset : 902.3 MHz to 905.0 MHz
(all ten channels within this range)

Base : 925.05 MHz to 927.75 MHz
(all ten channels within this range)

NOMINAL EFFECTIVE RANGE

Actual operating range may vary according to environmental conditions at the time of use.

SIZE

Base : 230x180x90mm
Headset : 190x165x120mm
Charger : 185x110x250mm
Remote dial card : 106x45x9mm

WEIGHT

Base : 700g
Headset (with battery) : 210g
Charger : 420g
Remote dial card (with battery) : 20g

POWER REQUIREMENTS

Headset : Self-contained nickel-metal hydride rechargeable battery supply.

Base : 9VDC, 300 mA

Charger : 120VAC

MEMORY

Speed Dial : 21 memory locations
20 digits per location

Specifications are typical and may change without notice.

TABLE OF CONTENTS

Page

INTRODUCTION	1
Special Features	2
Parts Check List	3
FCC REGULATIONS	4
IMPORTANT SAFETY INSTRUCTIONS	6
THE BATTERIES PACK	8
GETTING STARTED	12
WALL MOUNTING	14
THE HEADSET LAYOUT	15
THE BASE LAYOUT	16
THE REMOTE LAYOUT	17
BASE UNIT FEATURES	18
Dialling Keys	19
Intercom Key	19
Program key	19
Hold key	19
Redial Key	19
Memory Key	19
Quick Mem Key	19
HOW TO PUT ON THE WIRELESS HEADSET	20
QUICK REFERENCE GUIDE	21
Setup	21
Making Calls	21
Answering Calls	21
To Place A Call On Hold	21
Making An Intercom Call	21
Storing Speed Dial Memory	21
Dialling From Memory	22
Using Redial	22
Flash	22
ADDITIONAL OPERATION	23
MAINTENANCE	25
WARRANTY	26
TECHNICAL SPECIFICATIONS	27

DIGITAL 900MHZ
CORDLESS HEAD PHONE
MODEL VT 1511

VT 1511



IMPORTANT :
BEFORE USING YOUR NEW PHONE WE STRONGLY
RECOMMEND YOU READ THIS MANUAL THOROUGHLY.



VTECH COMMUNICATIONS LTD.

INSTRUCTIO
manual



VTECH COMMUNICATIONS LTD.



Is a trademark of VTECH COMMUNICATIONS LTD., a member of THE VTECH GROUP OF COMPANIES.

Distributed in the U.S.A. by VTECH Communications, 8770 SW Nimbus Avenue / Beaverton, Oregon, 97008.

Distributed in Canada by VTECH Electronics Canada Ltd., Suite 200 - 7671 Alderbridge Way Richmond, B.C. V6X 1Z9.

Copyright 1996 for VTECH COMMUNICATIONS LTD..

91-4063-10-00
ISSUE 0