



273 Branchport Avenue
 Long Branch, NJ 07740
 (800) 631-2148
 www.wheelockinc.com

Thank you for using our products.

INSTALLATION INSTRUCTIONS
SERIES AMT MULTITONE SYNCHRONIZED (SYNC) STROBE APPLIANCES

GENERAL:

The AMT Multitone Synchronized (Sync) Strobe Appliances are UL Listed under Standard 1971 for Emergency Appliances for the Hearing Impaired and UL Standard 464 for SL Audible Signal Appliances. They are listed for **indoor use only** with the backboxes specified in these instructions (See Mounting Options). Models with SL Sync Strobes are Listed for wall or ceiling mounting; models with SLM Sync Strobes are Listed for wall mounting. The SLM strobes are listed at 15 candela under UL Standard 1971 and meet 75 candela intensity on axis with low current draw. The AMT Multitone Sync Strobe Appliances use a xenon flashtube with solid state circuitry enclosed in a rugged Lexan® lens to provide maximum visibility and reliability for effective visible signaling.

Wheelock's AMT Appliances are unique multitone alarm signals with separate input terminals for each sound. They are the ideal choice for suppression systems and emergency signaling systems where distinctive multiple alarm conditions are required. Eight groups of three self-prioritized sound outputs are provided with separate electrically isolated input terminals for each sound (see Table 2 and Table 7 for sound selections). Sound output can be field set to provide either HIGH (HI) dBA or STANDARD (STD) dBA sound output level.

AMT Multitone Sync Strobe Appliances are designed to work with Wheelock's Sync Control Module (SCM-24 Series) to provide synchronized flashes when the signal are activated.

All AMT Multitone Sync Strobe models are designed for use with either filtered or unfiltered Full-Wave-Rectified (FWR) input voltage. The AMT Multitone Sync Strobe Appliances have separate input terminals for alarm tone activation and sync strobe activation. The sync strobes can be easily field programmed to operate independently or in unison with all of the audible alarms. All inputs are polarized for compatibility with standard reverse polarity supervision of circuit wiring by a Fire Alarm Control Panel (FACP).

NOTE: All CAUTIONS and WARNINGS are identified by the symbol . All warnings are printed in bold capital letters.

WARNING: PLEASE READ THESE INSTRUCTIONS CAREFULLY BEFORE USING THIS PRODUCT. FAILURE TO COMPLY WITH ANY OF THE FOLLOWING INSTRUCTIONS, CAUTIONS AND WARNINGS COULD RESULT IN IMPROPER APPLICATION, INSTALLATION AND/OR OPERATION OF THESE PRODUCTS IN AN EMERGENCY SITUATION, WHICH COULD RESULT IN PROPERTY DAMAGE, SERIOUS INJURY OR DEATH TO YOU AND/OR OTHERS.

WARNING: THE AMT MULTITONE SYNC STROBE APPLIANCES MUST BE FIELD SET TO THE DESIRED dBA SOUND OUTPUT LEVEL AND ALARM TONE BEFORE THEY ARE INSTALLED. THIS IS DONE BY PROPERLY INSERTING A JUMPER PLUG AND ADJUSTING A FOUR POSITION SWITCH IN ACCORDANCE WITH THESE INSTRUCTIONS. INCORRECT SETTINGS WILL RESULT IN IMPROPER PERFORMANCE AND MAY DAMAGE THE PRODUCT.

SPECIFICATIONS:

<i>Table 1: UL Listed Models</i>				
Model	Nominal Voltage (VDC)	Rated Voltage (VDC)	Sync Strobe Candela (CD)	Mounting Options
AMT-24-SL	24	20-31	15	A,B,C,D E,F,G
AMT-24-SLM	24	20-31	15*	

*15cd models are Listed at 15cd and meet 75cd on axis

WARNING: THESE APPLIANCES WERE TESTED TO THE OPERATING VOLTAGE LIMITS OF 20-31 VOLTS USING FILTERED (DC) OR UNFILTERED FULL-WAVE RECTIFIED (FWR). DO NOT APPLY 80% AND 110% OF THESE VOLTAGE VALUES FOR SYSTEM OPERATION.

Check the minimum and maximum output of the power supply and standby battery and subtract the voltage drop from the circuit wiring resistance to determine the applied voltage to the signaling appliance.

NOTE: THE MAXIMUM WIRE IMPEDANCE BETWEEN STROBES SHALL NOT EXCEED 35 OHMS. THE MAXIMUM NUMBER OF STROBES ON A SINGLE NOTIFICATION APPLIANCE CIRCUIT SHALL NOT EXCEED 31.

Copyright 1995, 2000 Wheelock, Inc. All rights reserved.

<i>Table 2: Current Ratings for AMT Multitone Audible Appliances</i>	
	Rated Average

Tone	Tone Description	Current (Amps)	
		24 VDC	
		HI dBA	STD dBA
Horn	Broadband Horn (Continuous)	0.040	0.023
Bell	1560 Hz Modulated (0.07 Sec. ON/Repeat)	0.016	0.012
March Time Horn	Horn (0.25 Sec. ON/0.25 Sec. OFF/Repeat)	0.040	0.023
Code 3 Horn	Horn (ANSI S3.41 Temporal Pattern)	0.040	0.023
Code 3 Tone	500 Hz (ANSI S3.41 Temporal Pattern)	0.028	0.017
Slow Whoop	500-1200Hz Sweep (4.0 Sec. ON/0.5 Sec. OFF/Repeat)	0.048	0.026
Siren	600-1200Hz Sweep (1.0 Sec. ON/Repeat)	0.036	0.023
HI/LO	1000/800 Hz (0.25 Sec. ON/Alternate)	0.020	0.015
Vibrating Chime	700Hz (1.0 Sec. Decay/Repeat)	0.017	0.012

Add 25% more input current than shown in Table 2 when operating the unit at maximum input voltage.

Add sync strobe current from Table 4 to audible signal current from Table 2 to obtain total current for each unit, if the sync strobe and audible are wired to operate in unison on a single circuit.

Table 3: dBA for AMT Multitone with Sync Strobe

Tone	Anechoic dBA @ 10'		Reverberant dBA @ 10' Per UL 464			
	Nominal Voltage		Minimum Voltage		Nominal Voltage	
	HI	STD	HI	STD	HI	STD
Horn	98	92	82	79	85	82
Bell	91	86	79	75	82	75
March Time Horn	98	92	82	75	85	79
Code 3 Horn	98	92	82	75	82	79
Code 3 Tone	94	89	82	79	85	79
Slow Whoop	98	93	79	75	82	75
Siren	97	92	79	73*	79	75
HI/LO	92	87	79	75	82	75
Vibrating Chimes	88	82	75	70*	79	73*

Anechoic dBA is measured on-axis in a non-reflective (free field) test room using fast meter response. For peak dBA (measured with peak meter response), add 5 dBA to anechoic values shown in Table 3. Reverberant dBA is a minimum UL rating based on sound power measurements in a reverberant test room.

⚠ WARNING: AMT MULTITONE SYNC STROBE MODELS SET ON "SIREN AND VIBRATING CHIME TONES" WITH STANDARD dBA DO NOT MEET THE 75 dBA MINIMUM UL REVERBERANT SOUND LEVEL REQUIRED FOR PUBLIC MODE FIRE PROTECTION SERVICE (NOTED BY * IN TABLE 3). MODELS WITH SETTINGS WHICH PRODUCE LESS THAN 75 dBA MAY NOT BE HEARD. THIS SETTING IS ACCEPTABLE ONLY FOR GENERAL SIGNALING (NON-FIRE ALARM) USE. USE THE "HIGH" dBA SETTING WITH THIS TONE OR USE A DIFFERENT TONE FOR PUBLIC MODE SERVICE.

Table 4: Sync Strobe Current Requirements (AMPS)

Voltage	Rated Average Current		Rated Peak Current		Rated Inrush Current	
	SL	SLM	SL	SLM	SL	SLM
20VDC	.096	.138	.192	.310	.252	.252
24VDC	.096	.138	.228	.320	.300	.300
31VDC	.096	.138	.252	.320	.384	.384
20VFWR	.105	.150	.252	.435	.384	.384
24VFWR	.100	.150	.260	.450	.456	.456
31VFWR	.096	.152	.288	.450	.540	.540

⚠ WARNING: MAKE SURE THAT THE TOTAL AVERAGE CURRENT, TOTAL PEAK CURRENT AND TOTAL INRUSH CURRENT REQUIRED BY ALL APPLIANCES THAT ARE CONNECTED TO THE SYSTEM'S PRIMARY AND SECONDARY POWER SOURCES, SIGNALING CIRCUITS, SM, DSM SYNC MODULES AND PS-12/24-8 DO NOT EXCEED THE POWER SOURCES' RATED CAPACITY OR THE CURRENT RATINGS OF ANY FUSES ON THE CIRCUITS TO WHICH THESE APPLIANCES ARE WIRED. OVERLOADING POWER SOURCES OR EXCEEDING FUSE RATINGS COULD RESULT IN LOSS OF POWER AND FAILURE TO ALERT OCCUPANTS DURING AN EMERGENCY, WHICH COULD RESULT IN PROPERTY DAMAGE AND SERIOUS INJURY OR DEATH TO YOU AND/OR OTHERS.

When calculating the total average, peak and inrush currents: Use Table 4 to determine the highest value of "Rated Average Current" for an individual strobe (across the expected operating voltage range of the strobe), determine the highest value of "Rated Inrush Current" or "Rated Peak Current" (whichever is higher) of an individual strobe (across the expected voltage range of the strobe), then multiply these values by the total number of strobes; be sure to add the currents for any other appliances, including audible signaling appliances, powered by the same source and include any required safety factors.

If the inrush current or peak current exceeds the power supplies' inrush capacity, the output voltage provided by the power supplies may drop below the listed voltage range of the appliances connected to the supply and the voltage may not recover in some types of power supplies. For example, an auxiliary power supply that lacks filtering at its output stage (either via lack of capacitance and/or lack of battery backup across the output) may exhibit this characteristic.

⚠ CAUTION: Strobes are not designed to be used on coded systems in which the applied voltage is cycled on and off.

⚠ WARNING: THE SYNC STROBES ARE DESIGNED TO FLASH AS SPECIFIED WITH CONTINUOUS (NON-CODED) APPLIED VOLTAGE. THE SYNC STROBES MAY NOT FLASH IF USED IN CODED SYSTEMS.

All models are UL Listed for indoor use only with a temperature range of +32°F to +120°F (0°C to +49°C) and maximum humidity of 85% RH.

⚠ CAUTION: If Multitone Strobe Appliances are operated within 15 inches of a person's ear, they can produce a sound pressure level that exceeds the maximum 120 dBA permitted by ADA and OSHA rules. Exposure to such sound levels can result in damage to a person's hearing.

NOTE: This equipment has been tested and found to comply with the limits for a Class B digital appliance, pursuant to Part 15 of the FCC Rules. These limits are designed to provide reasonable protection against harmful interference in residential installation. This equipment generates, uses and can radiate radio frequency energy and, if not installed and used in accordance with the instructions, may cause harmful interference to radio communications. However, there is no guarantee that interference will not occur in a particular installation. If this equipment does cause harmful interference to radio or television reception, which can be determined by turning the equipment off and on, the user is encouraged to try to correct the interference by one or more of the following measures: 1) Reorient or relocate the receiving antenna, 2) Increase the separation between the equipment and receiver, 3) Connect the equipment into an outlet on a circuit different from that to which the receiver is connected, and 4) Consult the dealer or an experienced radio/TV technician for help.

LIGHT DISTRIBUTION:

Table 5.

Horizontal Angle (in deg.)	15cd		15cd	Vertical Angle (in deg.)	15cd		15cd
	UL Min.	Typ. SL	Typ. SLM		UL Min.**	Typ. SL	Typ. SLM
0	15.0	28	135	0	15.0	28	135
5	13.5	27	101	5	13.5	28	135
10	13.5	27	51	10	13.5	28	135
15	13.5	27	38	15	13.5	27	135
20	13.5	27	30	20	13.5	26	135
25	13.5	27	26	25	13.5	26	132
30	11.3	26	26	30	13.5/11.3	24	130
35	11.3	23	23	35	9.8/11.3	24	127
40	11.3	23	23	40	6.9/11.3	22	124
45	11.3	20	22	45	5.1/11.3	19	122
50	8.3	14	20	50	4.0/8.3	16	113
55	6.8	11	20	55	3.3/6.8	16	104
60	6.0	11	20	60	2.7/6.0	12	95
65	5.3	11	20	65	2.4/5.3	11	85
70	5.3	11	20	70	2.3/5.3	11	76
75	4.5	11	20	75	2.0/4.5	11	68
80	4.5	9	20	80	1.8/4.5	11	41
85	3.8	9	20	85	1.8/3.8	11	27
90	3.8	8	19	90	1.8/3.8	11	11

*15cd models are Listed at 15cd and meet 75cd on axis

** Wall/Ceiling

⚠ WARNING: WHEN INSTALLING SYNC STROBES IN AN OPEN OFFICE OR OTHER AREAS CONTAINING PARTITIONS OR OTHER VIEWING OBSTRUCTIONS, SPECIAL ATTENTION SHOULD BE GIVEN TO THE LOCATION OF THE SYNC STROBES SO THAT THEIR OPERATING EFFECT CAN BE SEEN BY ALL INTENDED VIEWERS, WITH THE INTENSITY, NUMBER, AND TYPE OF SYNC STROBES BEING SUFFICIENT TO MAKE SURE THAT THE INTENDED VIEWER IS ALERTED BY PROPER ILLUMINATION, REGARDLESS OF THE VIEWER'S ORIENTATION.

FLASH RATE: When operated with Wheelock's Sync Control Module (SCM-24 Series) sync strobes flash at a constant rate across the rated voltage range (minimum 1.0 flash per second).

NOTE: Sync strobes will operate independently in Fail Safe Mode (flash approximately 54 flashes per minute) if not operated with Wheelock's Sync Control Module.

AMT MULTITONE SETTINGS:

The Jumper Plug (DP1) and Switch (SW1) of the AMT Multitone Signal, shown in Figure 1, are used to set the dBA sound output level and alarm tone. The factory settings are shown below. Read these instructions carefully before changing any of these factory settings.

Figure 1.
PC Board Layout Showing Location
of Jumper Plug (DP1) and Switch (SW1)

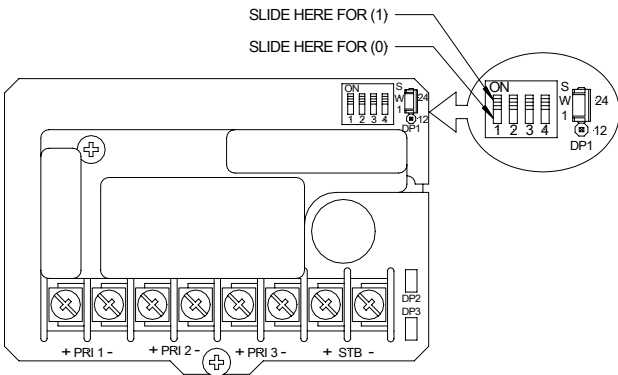

-The factory settings for 24VDC models are:

- 24VDC DP1 set on 24
- HIGH dBA SW1 POS 1 set on 1
- HORN TONE SW1 POS 2, 3, 4 set on 1, 1, 1

STEP 1:

Set desired dBA sound output level as follows (Refer to Figures 2 and 3):

AMT Multitone Sync Strobe Appliances cannot be field set for input voltage. AMT Multitone Sync Strobe Appliances are field set for dBA sound output level by inserting a Jumper Plug (DP1) and adjusting a four position Switch (SW1) as shown in Table 6 and Figures 2 and 3. Use DP1 and SW1 Position 1 to select the dBA sound output level.

Table 6: Input Voltage and dBA Sound Output Level Settings	
Input Voltage and Decibel Level	DP1 and SW1 Settings
24 VDC/HIGH dBA:	Set DP1 on 24; set SW1 POS 1 on 1
24 VDC/STD dBA:	Set DP1 on 24; set SW1 POS 1 on 0

(Factory Setting for 24VDC Models)

STEP 2:

Set desired input voltage and dBA sound output level as follows (Refer to Figures 2 and 3):

AMT Multitone Appliances cannot be field set for input voltage. AMT Multitone Sync Strobe Appliances are field set for dBA sound output level by inserting a Jumper Plug (DP1) and adjusting a four position Switch (SW1) as shown in Table 6 and Figures 2 and 3. Use DP1 and SW1 Position 1 to select the dBA sound output level.

Table 6: Input Voltage and dBA Sound Output Level Settings	
Input Voltage and Decibel Level	DP1 and SW1 Settings
24 VDC/HIGH dBA:	Set DP1 on 24; set SW1 POS 1 on 1
24 VDC/STD dBA:	Set DP1 on 24; set SW1 POS 1 on 0

(Factory Setting for 24VDC models)

Figure 3.

Figure 2.

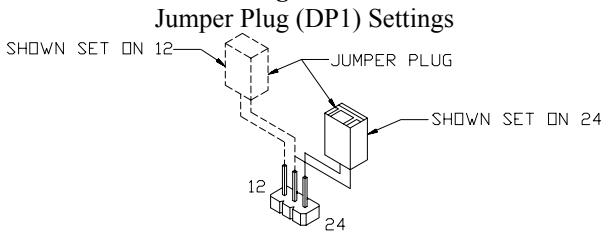

(Use Needle Nose Pliers to Lift and Properly Insert the Jumper Plug)

Switch (SW1) Settings

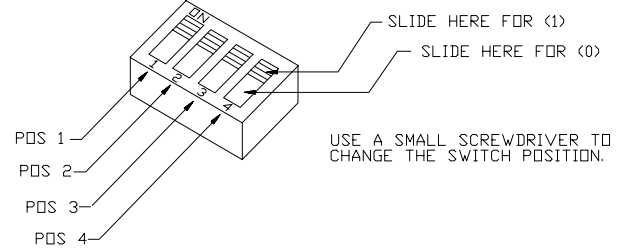

⚠ WARNING: DO NOT APPLY 24VDC INPUT IF THE JUMPER PLUG (DP1) IS SET ON 12. THIS CAN DAMAGE THE UNIT. DOUBLE CHECK THE JUMPER PLUG (DP1) AND SWITCH (SW1) SETTINGS TO MAKE SURE THEY ARE CORRECT. IMPROPER SETTINGS CAN DAMAGE THE UNIT OR RESULT IN NO SOUND OUTPUT OR A dBA SOUND OUTPUT LEVEL THAT IS BELOW THE 75dBA MINIMUM CODE REQUIREMENTS FOR PUBLIC MODE FIRE PROTECTION. THIS COULD RESULT IN PROPERTY DAMAGE, SERIOUS INJURY OR DEATH TO YOU AND/OR OTHERS.

STEP 2:

Set the desired alarm tones as follows (Refer to Figure 3 and Table 7):

AMT Multitone Sync Strobe Appliances are field set for any one of eight groups of self-prioritized tones by setting a four position switch (SW1) as shown in Figure 3 and Table 7. Use SW1 POS 2,3,4 to select the desired alarm tones.

<i>Table 7.</i>					
Tones			Switch Settings		
PRI 1	PRI 2	PRI 3	POS 2	POS 3	POS 4
Horn	Bell	Siren	1	1	1
Code 3 Horn	Siren	Vibrating Chime	1	0	1
Slow Whoop	March Time Horn	HI/LO	0	0	1
March Time Horn	HI/LO	Vibrating Chimes	1	1	0
Code 3 Horn	Bell	Siren	0	1	1
Siren	Horn	Vibrating Chime	0	1	0
Bell	March Time Horn	Siren	1	0	0
Code 3 Tone	HI/LO	Siren	0	0	0

Note: The prioritized tones contained in each group is factory pre-set which can not be changed.

Note: The Code 3 Horn and Code 3 Tone (set on HIGH dBA) incorporate the temporal pattern specified by ANSI/NFPA for standard emergency evacuation signaling. They should be used only for fire evacuation signaling and not for any other purpose.

The Horn and Bell Tones can be used on coded systems with a minimum On-Time of 1/4 second if the audible and Sync Strobe are wired to operate independently. All other tones are recommended for use only on continuous (non-coded) systems.

SYNC STROBE SETTINGS:

The jumper plugs (DP2 and DP3), shown in Figure 4, are used to set for simultaneous actuation of the sync strobe with all 3 of the audible inputs or for independent actuation of the sync strobe.

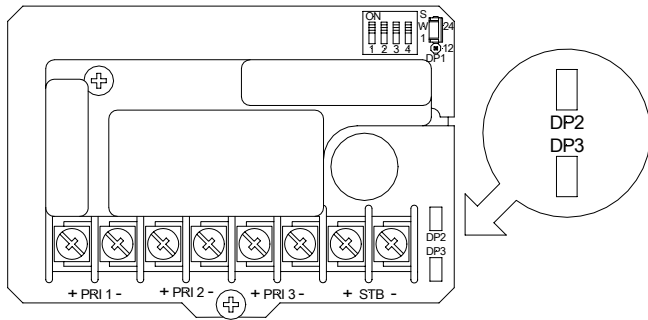

- The factory setting is for simultaneous actuation of the sync strobe with all 3 audible inputs.
- For independent sync strobe actuation set the jumper plugs DP2 and DP3 as shown in Figure 5.

Figure 4: PCB Layout Showing Location Of Jumper Plugs DP2 & DP3

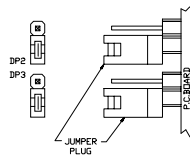
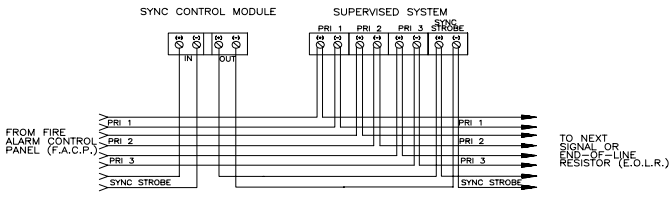
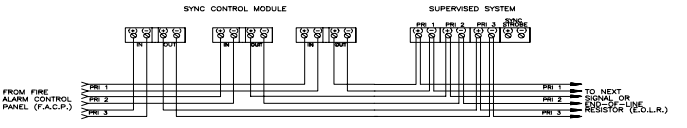
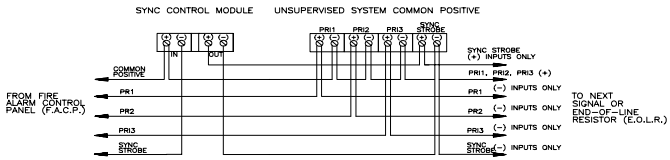
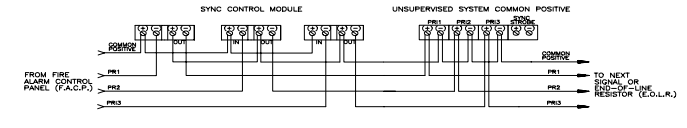
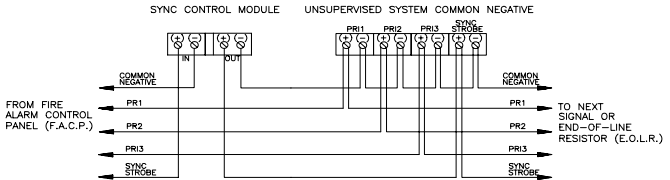
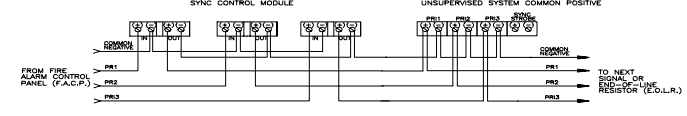

Figure 5: Independent Sync Strobe Actuation Setting

Note: The sync strobe input is required only for independent actuation of the sync strobe.

WIRING DIAGRAMS:

Independent Sync Strobe and Audible Actuation	Simultaneous Sync Strobes And Audible Actuation
 <p>Isolated inputs are provided for independent supervision and actuation of the three audible inputs and sync strobe</p>	 <p>Isolated inputs are provided for independent supervision and actuation of the three audible inputs and sync strobe.</p>
 <p>For applications not requiring supervision: connect all positive (+) terminals to the power source. The negative (-) terminal for each signal will actuate the appliance.</p>	 <p>For applications not requiring supervision: connect all positive (+) terminals to the power source. The negative (-) terminal for each signal will actuate the appliance.</p>
 <p>For applications not requiring supervision: connect all positive (-) terminals to the power source. The negative (+) terminal for each signal will actuate the appliance.</p>	 <p>For applications not requiring supervision: connect all positive (-) terminals to the power source. The negative (+) terminal for each signal will actuate the appliance.</p>

In case of simultaneous audible inputs, the three audible outputs are self-prioritized as follows: 1st priority = PRI 1; 2nd priority = PRI 2; 3rd priority = PRI 3.

Leave any unused inputs disconnected.

⚠ WARNING: NFPA CODES REQUIRE SIGNALING APPLIANCES TO BE SUPERVISED. CHECK TO BE CERTAIN THAT UNSUPERVISED SIGNALING APPLIANCES DO NOT VIOLATE ANY APPLICABLE CODES.

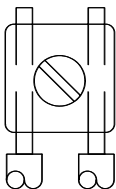

1. AMT Multitone Sync Strobe models have in-out wiring terminals that accept two #12 to #18 American Wire Gauge (AWG) wires at each screw terminal. Strip leads 3/8 inches and connect to screw terminals.
2. Break all in-out wire runs on supervised circuits to assure integrity of circuit supervision as shown on left. The polarity shown in the wiring diagrams is for operation of the signals. The polarity is reversed by the F.A.C.P. during supervision.

MOUNTING OPTIONS:

⚠ CAUTION: The following figures show the maximum number of field wires (conductors) that can enter the backbox used with each mounting option. If these limits are exceeded, there may be insufficient space in the backbox to accommodate the field wires and stresses from the wires could damage the product.

Although the limits shown for each mounting option comply with the National Electrical Code (NEC), Wheelock recommends use of the largest backbox option shown and the use of approved stranded field wires, whenever possible, to provide additional wiring room for easy installation and minimum stress on the product from wiring.

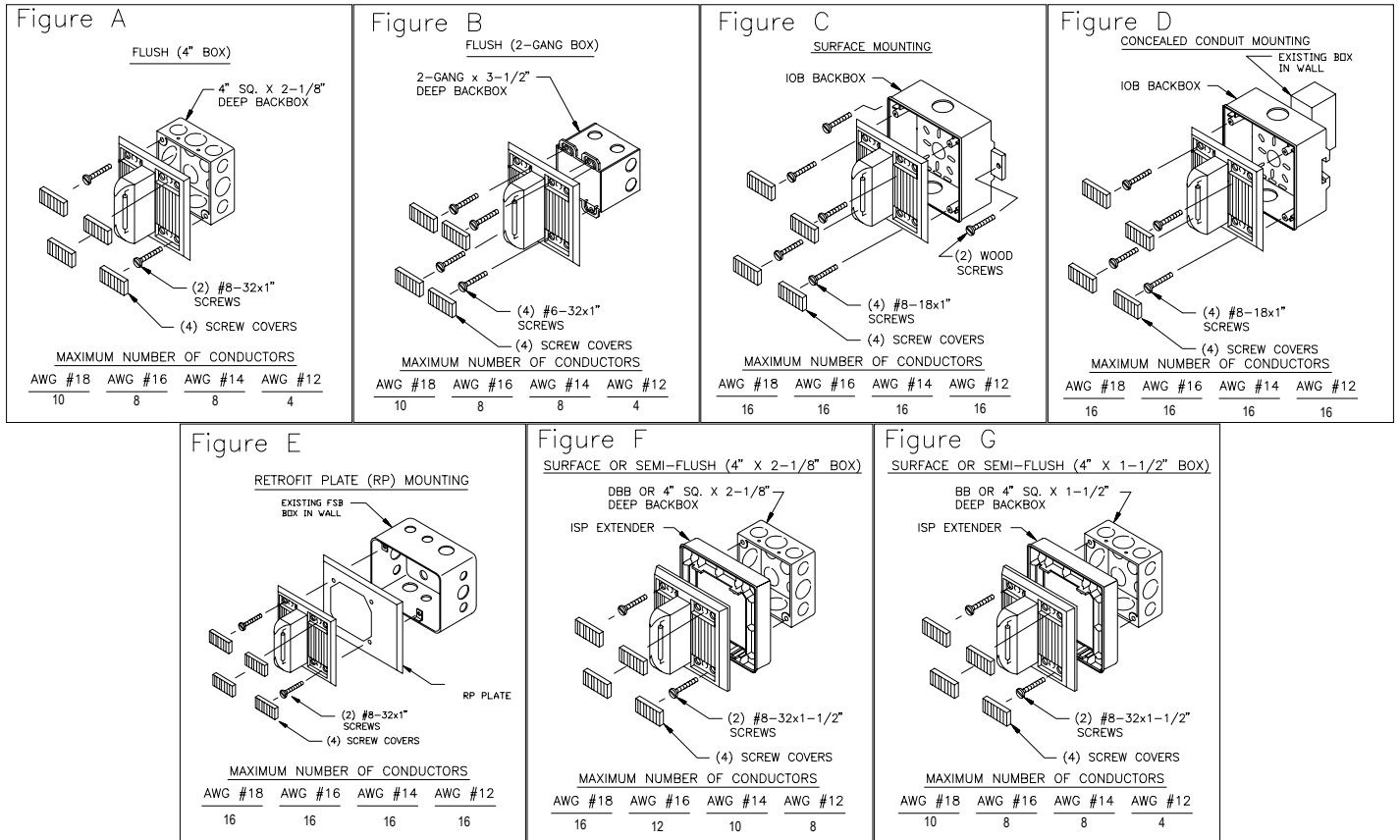

MOUNTING NOTES:

⚠ CAUTION: Check that the installed product will have sufficient clearance and wiring room prior to installing backboxes and conduit, especially if sheathed multiconductor cable or 3/4" conduit fittings are used.

1. AMT Multitone Sync Strobe models can be flush mounted to a standard 4 inch square by 2-1/8 inch deep electrical box (Figure A) or a standard 2-gang by 3-1/2 inch minimum deep electrical box (Figure B).
2. All models can also be surface mounted to Wheelock's model IOB backbox (Figure C or D) or to a 4" square backbox (model DBB or BB) with Wheelock's model ISP extender (Figure F and G).
3. AMT Multitone Sync Strobe models can also be retrofitted to an existing FSB backbox to replace Wheelock's model 7001 Sync Strobe Horn when used with Wheelock adaptor plate model RP (Figure E).
4. All models are supplied with four snap-in covers to hide the mounting holes and provide an attractive installation. The snap-in covers are interchangeable and have slots on each end so they can be removed if necessary (by prying them up with a thin blade screwdriver). To insert snap-in cover, slide the outside edge of the cover (furthest edge from the sync strobe lens) partially into the mounting hole recess; then align the cover so it is parallel to the grille (not tilted) and snap cover into place.
5. The IOB surface backbox has 1/2 inch conduit knockouts on two sides. It has a variety of knockouts on the back for mounting it to recessed electrical boxes and for wire entrances (Figure D). It can also be mounted to a surface with the two mounting ears that are supplied. The ears slide into slots on the back of the box (Figure C). Use appropriate anchors for the wood screws that are supplied with the box (if necessary).
6. The IOB includes a prefastened gasket and four hole plugs. Make sure the condensation drain holes on the box face down and that the box is vertical to permit drainage of any moisture. Use the mounting ears to secure the box (do not use the back

knockouts). Use the hole plugs to seal the unused mounting holes on the AMT Multitone grille (press them in securely from the back side of the grille). Mount the unit to the IOB with the four #8-18 screws supplied with the box.

7. Mounting hardware for each mounting option is supplied.
8. Conduit entrances to the backbox should be selected to provide sufficient wiring clearance for the installed product. When extension rings are required, conduit should enter through the backbox, not the extension ring. Use Steel City #53151 (1-1/2" deep) or #53171 (2-1/8" deep) extension rings (as noted in the mounting options) or equal with the same cut-out area.
9. When terminating field wires, do not use more lead length than required. Excess lead length could result in insufficient wiring space for the signaling appliance.
10. Use care and proper techniques to position the field wires in the backbox so that they use minimum space and produce minimum stress on the product. This is especially important for stiff, heavy gauge wires and wires with thick insulation or sheathing.
11. Do not pass additional wires (used for other than the signaling appliance) through the backbox. Such additional wires could result in insufficient wiring space for the signaling appliance.

⚠ WARNING: A SMALL POSSIBILITY EXISTS THAT THE USE OF MULTIPLE SYNC STROBES WITHIN A PERSON'S FIELD OF VIEW, UNDER CERTAIN CIRCUMSTANCES, MIGHT INDUCE A PHOTO-SENSITIVE RESPONSE IN PERSONS WITH EPILEPSY. SYNC STROBE REFLECTIONS IN A GLASS OR MIRRORED SURFACE MIGHT ALSO INDUCE SUCH A RESPONSE. TO MINIMIZE THIS POSSIBLE HAZARD, WHEELLOCK STRONGLY RECOMMENDS THAT THE SYNC STROBES INSTALLED SHOULD NOT PRESENT A COMPOSITE FLASH RATE IN THE FIELD OF VIEW WHICH EXCEEDS FIVE (5) Hz AT THE OPERATING VOLTAGE OF THE SYNC STROBES (SEE TABLE 6). WHEELLOCK ALSO STRONGLY RECOMMENDS THAT THE INTENSITY AND COMPOSITE FLASH RATE OF INSTALLED SYNC STROBES COMPLY WITH LEVELS ESTABLISHED BY APPLICABLE LAWS, STANDARDS, REGULATIONS, CODES AND GUIDELINES.

⚠ WARNING: WHEN INSTALLING STROBES IN AN OPEN OFFICE OR OTHER AREAS CONTAINING PARTITIONS OR OTHER VIEWING OBSTRUCTIONS, SPECIAL ATTENTION SHOULD BE GIVEN TO THE LOCATION OF THE STROBES SO THAT THEIR OPERATING EFFECT CAN BE SEEN BY ALL INTENDED VIEWERS, WITH THE INTENSITY, NUMBER, AND TYPE OF STROBES BEING SUFFICIENT TO MAKE SURE THAT THE INTENDED VIEWER IS ALTERED BY PROPER ILLUMINATION, REGARDLESS OF THE VIEWER'S ORIENTATION. FAILURE TO DO SO COULD RESULT IN PROPERTY DAMAGE AND SERIOUS INJURY OR DEATH TO YOU AND/OR OTHERS.

NOTE: NFPA 72/ANSI 117.1 conform to AADAAG Equivalent Facilitation Guidelines in using fewer, higher intensity strobes within the same protected area.

These appliances can produce a distinctive three pulse Temporal Pattern Fire Alarm Evacuation Signal. For total evacuation in accordance with NFPA 72 1999 Edition.

⚠ CAUTION: Check the installation instructions of the manufacturers of other equipment used in the system for any guidelines or restrictions on wiring and/or locating Notification Appliance Circuits (NAC) and notification appliances. Some system communication circuits and/or audio circuits, for example, may require special precautions to assure electrical noise immunity (e.g. audio crosstalk).

The AMT Multitone Sync Strobe products and these instructions are copyrighted by Wheelock and the AMT Multitone Sync Strobe products contain proprietary, confidential and trade secrets of Wheelock. No part of the AMT Multitone Sync Strobe products and these instructions may be photocopied, printed or reproduced in any form or modified, adapted, changed or enhanced, or converted to another programming language, or used to create updated, related or derivative works, without the prior written consent of Wheelock. No part of the AMT Multitone Sync Strobe products shall be decompiled, disassembled or reverse engineered.

ANY MATERIAL EXTRAPOLATED FROM THIS DOCUMENT OR FROM WHEELLOCK MANUALS OR OTHER DOCUMENTS DESCRIBING THE PRODUCT FOR USE IN PROMOTIONAL OR ADVERTISING CLAIMS, OR FOR ANY OTHER USE, INCLUDING DESCRIPTION OF THE PRODUCT'S APPLICATION, OPERATION, INSTALLATION AND TESTING IS USED AT THE SOLE RISK OF THE USER AND WHEELLOCK WILL NOT HAVE ANY LIABILITY FOR SUCH USE.

IMPORTANT: READ SEPARATE "GENERAL INFORMATION" SHEET FOR INFORMATION ON THE PLACEMENT, LIMITATIONS, INSTALLATION, FINAL CHECKOUT, AND PERIODIC TESTING OF NOTIFICATION APPLIANCES.

Limited Warranty

These products must be used within their published specifications and must be PROPERLY specified, applied, installed, operated, maintained and operationally tested in accordance with these instructions at the time of installation and at least twice a year or more often and in accordance with local, state and federal codes, regulations and laws. Specification, application, installation, operation, maintenance and testing must be performed by qualified personnel for proper operation in accordance with all of the latest National Fire Protection Association (NFPA), Underwriters' Laboratories (UL), Underwriters' Laboratories of Canada (ULC), National Electrical Code (NEC), Occupational Safety and Health Administration (OSHA), local, state, county, province, district, federal and other applicable building and fire standards, guidelines, regulations, laws and codes including, but not limited to, all appendices and amendments and the requirements of the local authority having jurisdiction (AHJ). These products when properly specified, applied, installed, operated, maintained and operationally tested as provided above are warranted against mechanical and electrical defects for a period of three years from date of manufacture (as determined by date code). Correction of defects by repair or replacement shall be at manufacturer's sole discretion and shall constitute fulfillment of all obligations under this warranty. THE FOREGOING LIMITED WARRANTY SHALL IMMEDIATELY TERMINATE IN THE EVENT ANY PART NOT FURNISHED BY THE MANUFACTURER IS INSTALLED IN THE PRODUCT. THE FOREGOING LIMITED WARRANTY SPECIFICALLY EXCLUDES ANY SOFTWARE REQUIRED FOR THE OPERATION OF OR INCLUDED IN A PRODUCT. THE MANUFACTURER MAKES NO REPRESENTATION OR WARRANTY OF ANY OTHER KIND, EXPRESS, IMPLIED OR STATUTORY WHETHER AS TO MERCHANTABILITY, FITNESS FOR A PARTICULAR PURPOSE OR ANY OTHER MATTER.

USERS ARE SOLELY RESPONSIBLE FOR DETERMINING WHETHER A PRODUCT IS SUITABLE FOR THE USER'S PURPOSES, OR WHETHER IT WILL ACHIEVE THE USER'S INTENDED RESULTS. THERE IS NO WARRANTY AGAINST DAMAGE RESULTING FROM MISAPPLICATION, IMPROPER SPECIFICATION, ABUSE, ACCIDENT OR OTHER OPERATING CONDITIONS BEYOND MANUFACTURER'S CONTROL.

SOME OF THE MANUFACTURER'S PRODUCTS CONTAIN SOFTWARE. WITH RESPECT TO THOSE PRODUCTS, THE MANUFACTURER DOES NOT WARRANTY THAT THE OPERATION OF THE SOFTWARE WILL BE UNINTERRUPTED OR ERROR-FREE OR THAT THE SOFTWARE WILL MEET ANY OTHER STANDARD OF PERFORMANCE, OR THAT THE FUNCTIONS OR PERFORMANCE OF THE SOFTWARE WILL MEET THE USER'S REQUIREMENTS. THE MANUFACTURER SHALL NOT BE LIABLE FOR ANY DELAYS, BREAKDOWNS, INTERRUPTIONS, LOSS, DESTRUCTION, ALTERATION, OR OTHER PROBLEMS IN THE USE OF A PRODUCT ARISING OUT OF OR CAUSED BY THE SOFTWARE.

THE LIABILITY OF THE MANUFACTURER ARISING OUT OF THE SUPPLYING OF A PRODUCT, OR ITS USE, WHETHER ON WARRANTIES, NEGLIGENCE, OR OTHERWISE, SHALL NOT IN ANY CASE EXCEED THE COST OF CORRECTING DEFECTS AS STATED IN THE LIMITED WARRANTY AND UPON EXPIRATION OF THE WARRANTY PERIOD ALL SUCH LIABILITY SHALL TERMINATE. THE MANUFACTURER IS NOT LIABLE FOR LABOR COSTS INCURRED IN REMOVAL, REINSTALLATION OR REPAIR OF THE PRODUCT BY ANYONE OTHER THAN THE MANUFACTURER OR FOR DAMAGE OF ANY TYPE WHATSOEVER, INCLUDING BUT NOT LIMITED TO, LOSS OF PROFIT OR INCIDENTAL OR CONSEQUENTIAL DAMAGES. THE FOREGOING SHALL CONSTITUTE THE SOLE REMEDY OF THE PURCHASER AND THE EXCLUSIVE LIABILITY OF THE MANUFACTURER.

IN NO CASE WILL THE MANUFACTURER'S LIABILITY EXCEED THE PURCHASE PRICE PAID FOR A PRODUCT.

Limitation of Liability

THE MANUFACTURER'S LIABILITY ON ANY CLAIM OF ANY KIND, INCLUDING NEGLIGENCE AND BREACH OF WARRANTY, FOR ANY LOSS OR DAMAGE RESULTING FROM, ARISING OUT OF, OR CONNECTED WITH THIS CONTRACT, OR FROM THE MANUFACTURE, SALE, DELIVERY, RESALE, REPAIR OR USE OF ANY PRODUCT COVERED BY THIS ORDER SHALL BE LIMITED TO THE PRICE APPLICABLE TO THE PRODUCT OR PART THEREOF WHICH GIVES RISE TO THE CLAIM. THE MANUFACTURER'S LIABILITY ON ANY CLAIM OF ANY KIND SHALL CEASE IMMEDIATELY UPON THE INSTALLATION IN THE PRODUCT OF ANY PART NOT FURNISHED BY THE MANUFACTURER. IN NO EVENT SHALL THE MANUFACTURER BE LIABLE FOR ANY CLAIM OF ANY KIND UNLESS IT IS PROVEN THAT OUR PRODUCT WAS A DIRECT CAUSE OF SUCH CLAIM. FURTHER, IN NO EVENT, INCLUDING IN THE CASE OF A CLAIM OF NEGLIGENCE, SHALL THE MANUFACTURER BE LIABLE FOR INCIDENTAL OR CONSEQUENTIAL DAMAGES. SOME STATES DO NOT ALLOW THE EXCLUSION OR LIMITATION OF INCIDENTAL OR CONSEQUENTIAL DAMAGES, SO THE PRECEDING LIMITATION MAY NOT APPLY TO ALL PURCHASERS.