

Series DV-200 VoiceLink Operation and Installation Manual

wheelock

INC.

273 Branchport Avenue
Long Branch, NJ 07740
Telephone: (800) 631-2148
Fax: 732-222-8707

Part Number P82632 Revision G

Assembly Number A82633 Revision E

THANK YOU FOR PURCHASING OUR PRODUCTS. USE THIS PRODUCT ACCORDING TO THIS INSTRUCTION MANUAL. PLEASE KEEP THIS INSTRUCTION MANUAL FOR FUTURE REFERENCE.

ANY MATERIAL EXTRAPOLATED FROM THIS DOCUMENT OR FROM WHEELLOCK MANUALS OR OTHER DOCUMENTS DESCRIBING THE PRODUCT FOR USE IN PROMOTIONAL OR ADVERTISING CLAIMS, OR FOR ANY OTHER USE, INCLUDING DESCRIPTION OF THE PRODUCT'S APPLICATION, OPERATION, INSTALLATION AND TESTING IS USED AT THE SOLE RISK OF THE USER AND WHEELLOCK WILL NOT HAVE ANY LIABILITY FOR SUCH USE.

Conventions Used in This Manual

This manual uses the following conventions for notes, cautions, and warnings.



CAUTION: Indicates a potentially hazardous situation which, if not avoided, could result in minor or moderate injury. It may also be used to alert against unsafe practices.



WARNING: INDICATES A POTENTIALLY HAZARDOUS SITUATION WHICH, IF NOT AVOIDED, COULD RESULT IN PROPERTY DAMAGE AND SERIOUS PERSONAL INJURY OR DEATH.

Copyright 1993-2000 Wheelock, Inc. All rights reserved.

Preface

In this manual, the family of the DV-200 and DV-EM VoiceLink products are referred to as the Series DV-200.

The Series DV-200 provides record and playback capability. The Series DV-200 does not sense an emergency condition or hazardous fires, but is only a part of a system that does sense such conditions. The Series DV-200, when activated by a control panel, provides a pre-recorded tone and/or voice message to an audio system. When used as part of a protective signaling system, the Series DV-200 must be properly connected to a compatible control panel that has been approved by a nationally recognized testing laboratory ("LISTED") and/or a LISTED compatible audio system with LISTED compatible notification appliances for proper operation.

PERSONNEL PROPERLY QUALIFIED IN THE APPLICATION AND USE OF LIFE SAFETY EQUIPMENT ("QUALIFIED PERSONNEL") MUST READ THIS MANUAL CAREFULLY BEFORE PERFORMING ACTIONS TO SPECIFY, APPLY, INSTALL, MAINTAIN AND OPERATIONALLY TEST SERIES DV-200 PRODUCTS IN ACCORDANCE WITH THE INSTRUCTIONS IN THIS MANUAL.

 **WARNING:** IF SAFETY PRECAUTIONS, INSTALLATION AND TESTING INSTRUCTIONS ARE NOT PERFORMED PROPERLY, THE SERIES DV-200 MAY NOT OPERATE IN AN EMERGENCY SITUATION WHICH COULD RESULT IN PROPERTY DAMAGE, SERIOUS INJURY OR DEATH TO YOU AND/OR OTHERS.

- **DO NOT** assume any installation, operation and testing details not shown in this manual.
- The Series DV-200 should only be operated with **covers** properly **in place**.
- **KEEP** this manual **WITH THE SERIES DV-200 FOR FUTURE REFERENCE** for the life of the system and make it available to all qualified personnel who operate, test, maintain, or service the Series DV-200. We strongly recommend that such personnel read and understand the entire manual.

The Series DV-200 WILL NOT WORK WITHOUT POWER. The Series DV-200 is powered by the protective signaling system. If power is cut off for any reason, the Series DV-200 will not provide the desired tone and/or voice warning. Backup power supplies are recommended for protective signaling systems.

WHEELLOCK EXPRESSLY DISCLAIMS ALL LIABILITY FOR THE CONTENT, CLARITY AND LANGUAGES OF, AND OUTPUT CHANNEL AND PRIORITY LEVEL ASSIGNED TO, ANY AND ALL MESSAGES. IT IS ESSENTIAL THAT YOU HAVE MESSAGE CONTENT AND LANGUAGE, SEQUENCE, OUTPUT CHANNEL AND PRIORITY ASSIGNMENTS REVIEWED AND APPROVED BY QUALIFIED LEGAL AND SAFETY ADVISORS, QUALIFIED REPRESENTATIVE(S) OF OWNER(S) AND USER(S), AND AUTHORITIES HAVING JURISDICTION.

 **CAUTION:** The Series DV-200 printed circuit boards are sensitive to static electricity and have delicate components mounted on them. Before handling either a board or any component on a board, discharge any static electricity from your body by touching a grounded object such as a metal screw which is connected to earth ground. Handle the board by its edges, and be careful not to twist or flex it. The Series DV-200 is to be installed in a static free area and the user is to properly attach grounded wrist straps before touching any static sensitive areas. After handling Series DV-200 printed circuit boards, the Series DV-200 should be tested in accordance with the "System Checkout" section to verify that the printed circuit boards are undamaged and functioning properly.

COMPLY WITH ALL OF THE LATEST APPLICABLE CODES, REGULATIONS, LAWS, STANDARDS, GUIDELINES:

For emergency, hazardous, security, life safety and fire protective signaling system applications, the Series DV-200 must be used within their published specifications and only with a LISTED compatible control panel and LISTED compatible audio system in accordance with sound engineering judgment and the instructions of the manufacturer and in accordance with local, state and federal codes, regulations and laws. The Series DV-200 must be PROPERLY specified, applied, installed, operated, maintained and operationally tested in accordance with these instructions at the time of installation and at least twice a year or more often as required by local, state and federal codes, regulations and laws. Installation, testing and maintenance must be performed by qualified personnel for proper operation in accordance with all of the latest National Fire Protection Association (NFPA), Underwriters' Laboratories (UL), National Electrical Code (NEC), Occupational Safety and Health Administration (OSHA), local, state, county, province, district, federal and other applicable building and fire standards, guidelines, regulations, laws and codes including, but not limited to, all appendices and amendments and the requirements of the local authority having jurisdiction (AHJ).
--

 **WARNING:** IF THE PROTECTIVE SIGNALING SYSTEM SOUNDS AND/OR FLASHES, IT IS A WARNING OF A POSSIBLY SERIOUS SITUATION AND REQUIRES YOUR IMMEDIATE ATTENTION.

NOTE: This equipment has been tested and found to comply with the limits for a Class B digital device, pursuant to Part 15 of the FCC Rules. These limits are designed to provide reasonable protection against harmful interference in residential installation. This equipment generates, uses and can radiate radio frequency energy and, if not installed and used in accordance with the instructions, may cause harmful interference to radio communications. However, there is no guarantee that interference will not occur in a particular installation. If this equipment does cause harmful interference to radio or television reception, which can be determined by turning the equipment off and on, the user is encouraged to try to correct the interference by one or more of the following measures: 1) Reorient or relocate the receiving antenna; 2) Increase the separation between the equipment and receiver; 3) Connect the equipment into an outlet on a circuit different from that to which the receiver is connected; 4) Consult the dealer or an experienced radio/TV technician for help.

For the Series DV-200 to properly operate it must be properly connected to a listed compatible and properly operating control panel and audio system, or to a listed compatible and properly operating audio system, that controls its activation and provides proper voltage and current. The operation and electrical ratings of such control panel and audio system, or such audio system, must be compatible with the Series DV-200, and all equipment must be properly interconnected and operating. The installer must check compatibility before installation; otherwise, the Series DV-200 and/or the control panel and/or the audio system may be damaged and/or fail to operate in an emergency situation.

Each manufacturer's fire alarm control panel, audio system, and notification appliance operates differently and has different features. Before specifying, installing, operating, testing, maintaining or servicing a system, carefully read the installation, operation and testing manual for each piece of equipment and applicable codes.

Request that the local authority having jurisdiction inspect the proposed placement of the notification appliances and receive their approval.

The output of the audio system may not be heard in all cases. Sound can be blocked or reduced by walls, doors, carpeting, wall covering, furniture, insulation, bed coverings, and other obstacles that may temporarily or permanently impede the output of the audio system. Sound is also reduced by distance and masked by background noise. The output of the audio system may not be sufficient to alert all occupants, especially those who are asleep, those who are hearing-impaired, those who are wearing devices that plug or cover the ears, and those who have recently used drugs or alcohol. The output of the audio system may not be heard by an alert person if the output device is placed in an area which is isolated by a closed door, or is located on a different floor from the person in a hazardous situation or is placed too far away to be heard over ambient noise such as, but not limited to, running water, traffic, air conditioners, machinery or musical appliances.



WARNING: AUDIBLE SIGNALS MAY MASK MEDICAL EQUIPMENT MONITORING ALARMS. WHERE MEDICAL EQUIPMENT MONITORING ALARMS ARE IN USE, DO NOT USE AUDIBLE SIGNALS; PROVIDE VISUAL NOTIFICATION APPLIANCES IN HIGHLY VISIBLE LOCATIONS.

If audible tones and/or voice messages cannot be readily heard and understood clearly within the protected areas as intended, it is necessary to increase the number and/or sound output intensity of speakers within those areas so that they are heard and understood clearly when activated.

Notification equipment cannot last forever. Even though the Series DV-200 is expected to last up to ten years, any of its parts or components could fail before then. Therefore testing of the entire protective signaling system, including the SAFEPATH panel, all notification equipment, as well as all messages and their output channel, and priority assignment, must be conducted at least twice each year, or more often as required by local, state and federal codes, regulations and laws, by qualified personnel. If the notification equipment is not working properly, immediately contact the installer and have all/any problems corrected immediately. Malfunctioning components should be replaced immediately. Do not attempt to repair malfunctioning components. Malfunctioning components should be returned for factory repair or replacement. In the event you cannot contact the installer, contact the manufacturer.



WARNING: THERE ARE CERTAIN HARDWARE FUNCTIONS ON THE DV-200 WHICH ARE NOT SUPERVISED. IF ANY SUCH HARDWARE FUNCTIONS FAIL, THE DV-200 MAY NOT PROVIDE THE INTENDED WARNING AND/OR NOT INDICATE A TROUBLE CONDITION.

THE FOLLOWING HARDWARE FAILURES WOULD PREVENT THE SERIES DV-200 FROM PROVIDING THE INTENDED WARNING:

1. THE "SHORT CIRCUIT" DETECTION CIRCUITRY FOR ANY ONE OR ALL OF THE EIGHT CONTACT INPUTS.
2. THE SERIAL PORT RECEIVER.
3. THE PLAY CONTACT FOR EACH OF THE FOUR OUTPUT CHANNELS.

THE FOLLOWING HARDWARE FAILURES WOULD PREVENT THE SERIES DV-200 FROM INDICATING A TROUBLE CONDITION.

1. THE "OPEN CIRCUIT" DETECTION CIRCUITRY FOR ANY ONE OR ALL OF THE EIGHT CONTACT INPUTS.
2. THE AUDIO SUPERVISION CIRCUITRY FOR EACH OF THE FOUR OUTPUT CHANNELS.
3. THE STATUS CONTACT.

THESE HARDWARE FUNCTIONS MUST BE PERIODICALLY CHECKED FOR PROPER OPERATION. REFER TO PERIODIC TESTING SECTION FOR RECOMMENDED TESTS.

Additional copies of this manual may be obtained from manufacturer.

CONTENTS

	Page
Introduction.....	8
Operation.....	10
Message Memory.....	10
Input and Output Options.....	10
Message Files.....	11
Output Channels.....	12
File Priority.....	12
Acknowledge Playing Files.....	12
Reset Playing Files.....	13
Playing Files.....	13
System Pause.....	13
Supervision.....	13
Standby Battery Calculations.....	15
Access Key and Password Protection.....	15
Memory Retention Battery.....	15
Message Recording.....	16
Setting Volume Control.....	16
Recording a Voice File.....	17
Creating a String File.....	17
Transferring Data.....	18
Installation.....	21
Wiring Guidelines.....	22
Mounting.....	22
Grounding.....	23
Field Wiring.....	24
Field Wiring Checkout.....	29
System Checkout.....	30
Ground Fault Detection Sensitivity Adjustment.....	30
Troubleshooting.....	31
Procedures A, B, C.....	32
Procedures D, E.....	33
Procedure F, G.....	34
Procedure H, I, J.....	35
Periodic Testing.....	36
Technical Specifications.....	37
Glossary.....	40
Limited Warranty.....	41
Limitation of Liability.....	41
Appendix A. Standard Protocol Description (RS-232).....	A-1
Appendix B. Standard Protocol Description (RS-485).....	B-1
Appendix C. Display and Keypad Operation.....	C-1

List of Figures

Figure 1	Basic Capabilities Of The Series DV-200 Products.....	9
Figure 2	Series DV-200 Interior View.....	20
Figure 3	Series DV-200 Mounting.....	23
Figure 4	File Input Wiring.....	25
Figure 5	Audio Output/Music Input/Channel Playing Wiring.....	26
Figure 6	Input Voltage and Status Contact Wiring.....	26
Figure 7	Typical System Block Diagram.....	27
Figure 8	Series DV-200 Main Board Layout.....	28
Figure 9	RS-232 Port Pin Out.....	29
Figure 10	RS-485 Port Pin Out.....	29

Introduction

Wheelock's VoiceLink products provide unique digital recording, programming, storage, and playback capabilities to create versatile and automated announcement systems. Figure 1 illustrates the basic capabilities of the Series DV-200.

The Series DV-200 can record voice, tones, and other sounds. The Series DV-200 can then playback the recorded voice, tones, and other sounds through amplification equipment (not supplied with the Series DV-200) when instructed to do so by a contact closure or an instruction over a serial link from other equipment. The Series DV-200 may also be used for programming message files into a Series DV-100.

This manual describes the Series DV-200 which features:

- Up to 16 minutes of audio storage in volatile PSRAM (see "PSRAM" definition in glossary) memory integrated circuits ("IC's") and a memory retention battery to power the memory IC's during power failure conditions.
- Selective activation of up to 8 message files using contact closures or open collector transistor switching (expandable to 256 message files using optional Series DV-EM's).
- Selective activation of up to 999 message files through the serial port.
- Keypad and menu driven LCD display with password protection.
- Field upgradable.
- Record using microphone or high impedance input.
- Up to 5 levels of message file priority assignments with the two least significant priority levels being acknowledgeable.
- Up to 4 audio output channels.
- Supervision of input lines and many internal operations with trouble diagnosis and notification.
- Serial communication supervision and optional verification of serial commands with a trouble indication if an error is detected.
- An optional telephone interface.
- An RS-232 interface and an optional RS-485.

A SERIES DV-200 MUST BE PROPERLY INSTALLED, PROGRAMMED AND CONNECTED TO A COMPATIBLE CONTROL PANEL AND AUDIO SYSTEM, AND A POWER SUPPLY, TO FUNCTION IN A VOICE ANNOUNCEMENT SYSTEM. THE SERIES DV-200 OPERATES ONLY WITH REGULATED AND FILTERED DC VOLTAGE, NOT FULL-WAVE-RECTIFIED VOLTAGE.

The control panel can range from simple push-buttons or detectors that provide contact closures to activate Series DV-200 files to sophisticated, computer-based control panels that address Series DV-200 files through a serial port. Similarly, the audio system can range from a simple amplified speaker to a large, multi-channel audio distribution system that may also be integrated with a zoned telephone paging system. Wheelock offers a wide line of audio equipment to configure such systems.

Wheelock models; DV-100, DV-200, MDV-2, DX-100, DX-200, MDX-2 and DV-EM are UL 864 approved for use with Fire Alarm Control Panels (FACP). The above models are used as accessory control units in UL 864 listed protective signaling systems. All models have an operating voltage range of 11.0-29.0VDC. All are operated by a serial port or contact closure with an adjustable output from 0.5-2.0VRMS.



WARNING: THE OPTIONAL TELEPHONE INTERFACE SHALL NOT BE USED FOR PRIMARY NOTIFICATION OF AN EMERGENCY SITUATION, EVENT, ACTION, OR CAUSE.

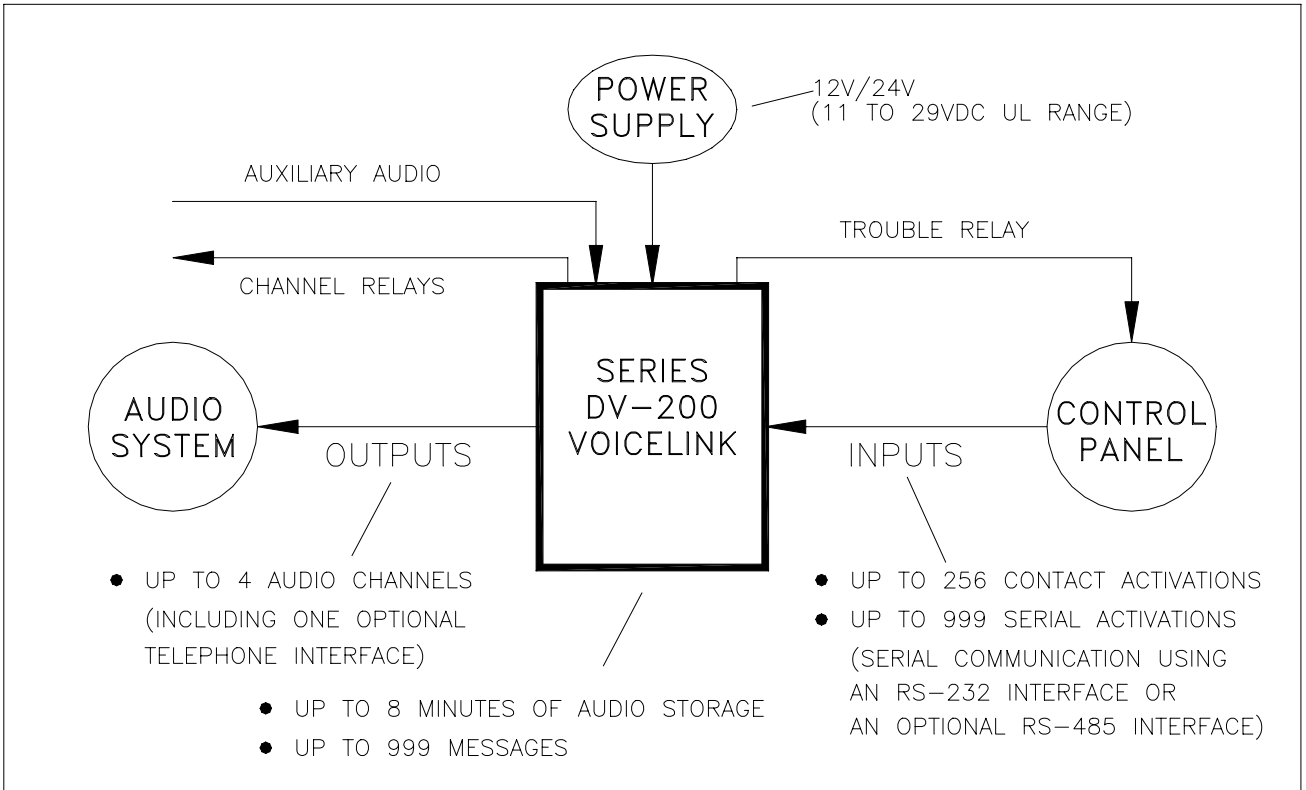

Figure 1.
Basic Capabilities Of The Series DV-200 Products

Operation

This chapter describes the operating characteristics of the Series DV-200. Included is information about the following Series DV-200 features:

- Message Memory
- Input and Output Options
- Message Files
- Output Channels
- File Priority
- Playing Files
- System Pause
- Supervision
- Standby Battery Calculations
- Access Key Password Protection
- Memory Retention Battery

Message Memory

The Series DV-200 has the ability to store up to sixteen minutes of audio. The audio is stored digitally on up to eight memory IC's. Each memory IC can store up to two minutes of audio messages. See Figure 8 for the socket locations S63 thru S70 on the Series DV-200 printed circuit board into which the eight memory IC's, U63 thru U70, are inserted.

These memory IC's are commonly referred to as pseudo static random access memories ("PSRAM's"). If the input power is disconnected and the memory retention battery is or has been disconnected or discharged, the PSRAM IC's will be erased.

 **WARNING:** IF THE INPUT POWER IS DISCONNECTED AND THE MEMORY RETENTION BATTERY IS OR HAS BEEN DISCONNECTED OR DISCHARGED, ALL MESSAGES IN THE PSRAM IC'S WILL BE ERASED. IF STORED MESSAGES ARE ERASED, THEY WILL NOT BE DELIVERED TO THE AUDIO SYSTEM WHEN INPUT POWER IS RESTORED. THIS COULD RESULT IN PROPERTY DAMAGE AND SERIOUS INJURY OR DEATH TO YOU AND/OR OTHERS.

Input and Output Options

Each Series DV-200 model includes 8 inputs that can be used to activate file numbers 1 through 8 with a contact closure or a transistor switch across the corresponding input terminals. The optional digital voice expansion modules ("DV-EM") can provide 32 inputs. When a Series DV-EM module is used, the 8 inputs in the Series DV-200 unit cannot be used. Up to 8 DV-EM's can be connected to a Series DV-200 for a total of 256 inputs.

 **WARNING:** MAKE SURE THAT SERIES DV-200 OUTPUTS ARE CONNECTED TO A PROPERLY OPERATING, LISTED COMPATIBLE AUDIO SYSTEM SO THAT MESSAGE FILES ASSIGNED TO THAT CHANNEL CAN BE PLAYED.

The Series DV-200 is provided with a serial port, through which up to 999 files can be activated with digital commands. The contact inputs in the Series DV-200 or Series DV-EM modules can be used along with the serial port. A command is required to start a message, and a second command is required to stop the message. The operation is similar to closing an input contact (start) and then reopening the contact (stop).

Up to four audio output channels are available with the Series DV-200. The audio output from each channel of the Series DV-200 is through a 600 Ohm transformer and is designed to drive a load impedance of 600 Ohms or higher. The audio level of each channel can be adjusted by a potentiometer on the PC board from -3.8 dBm to +8.2 dBm (0.5 to 2.0 Vrms). All Series DV-200 output channels can be active simultaneously.

Message Files

All messages are stored in files within the Series DV-200 memory. Up to 999 message files can be stored. There is no limit on the length of a message file (except for the limit imposed by total memory in the unit). There are two types of message files: voice files and string files. Voice files are created by storing audio directly into the selected file number. String files are created by storing file numbers of other message files into the selected file number. (See "file" and "string" definitions in glossary.) Each message file must be assigned a priority level from 1 to 5 (1 is highest, 5 is lowest) and an output channel from 1 to 4. See "Output Channels", "File Priority", and "Playing Files" sections for additional information.

 **WARNING: EACH MESSAGE MUST BE ASSIGNED ITS INTENDED OUTPUT CHANNEL AND PRIORITY LEVEL DURING PROGRAMMING OR THE MESSAGE WILL NOT BE PLAYED WHEN AND WHERE REQUIRED. THIS COULD RESULT IN PROPERTY DAMAGE AND SERIOUS INJURY OR DEATH TO YOU AND/OR OTHERS.**

String files reduce the message memory requirements by allowing many different message files to be created with a relatively small library of voice files that contain custom words or phrases and using one or more of the six string file commands. The string file commands are ADD, PAUSE, COMMON REPEAT, FILE REPEAT, TELEPHONE, and END. ADD is used to add a previously created message file to the string. PAUSE is used to add a period of silence to the string. COMMON REPEAT is used to play the next entered file number multiple times. FILE REPEAT is used to play the entire file again a specified number of times after the file has been de-activated. TELEPHONE is used to add telephone numbers to a string file. END is used to finalize the string.

The following is an example of creating string files from a small library of voice files using the ADD command.

The following voice messages are recorded into the indicated file numbers:

"There is a fire on the"	into file number 100
"First"	into file number 101
"Second"	into file number 102
"Third"	into file number 103
"Floor"	into file number 104

Create three string files as indicated:

File 1:	ADD 100, ADD 101, ADD 104, END
File 2:	ADD 100, ADD 102, ADD 104, END
File 3:	ADD 100, ADD 103, ADD 104, END

When file number 1 is selected to play, "There is a fire on the first floor" will be played. When file number 2 is selected to play, "There is a fire on the second floor" will be played. When file number 3 is selected to play, "There is a fire on the third floor" will be played.

The following is an example of creating string files using the ADD command and the PAUSE command.

The following voice messages are recorded into the indicated file numbers:

"Welcome to Herbie's"	into file number 100
"Our fish are the freshest in town"	into file number 101

Create a string file as follows:

File 1:	ADD 100, PAUSE 10 seconds, ADD 101, END
---------	---

When file number 1 is selected to play, "Welcome to Herbie's".....(10 seconds of silence)....."Our fish are the freshest in town" will be played.

The following is an example of creating string files using the ADD command and the COMMON REPEAT command.

The following voice messages are recorded into the indicated file numbers:

"Run"	into file number 100
"to the nearest salesman"	into file number 101

Create a string file as follows:

File 1:	COMMON REPEAT 3 times, file number 100, ADD 101, END
---------	--

When file number 1 is selected to play, "Run, Run, Run to the nearest salesman" will be played.

The following is an example of creating string files using the ADD command and the FILE REPEAT command.

The following voice message is recorded into the indicated file number:

"Thank you for buying Wheelock voice products"	into file number 100
--	----------------------

Create a string file as follows:

File 1:	ADD 100, FILE REPEAT 3 times
---------	------------------------------

When file number 1 is selected to play, "Thank you for buying Wheelock voice products" will be played. The file will play continuously as long as the file is activated. After the file is de-activated, the file will play three additional times. A momentary activation will play the message four times. The FILE REPEAT command must be the last item in the string.

The following is an example of creating string files using the ADD command and the TELEPHONE command.

The following voice message is recorded into the indicated file number:

"A fire has been detected at 101 Main Street"	into file number 100
---	----------------------

Create a string file as follows:

File 1: TELEPHONE 555-0100, TELEPHONE 555-1212
TELEPHONE 555-4949, ADD 100, END

When file number 1 is selected to play, the phone number 555-0100 is called. If the line is busy or the call is unanswered, the phone number will be tried two more times. After the third attempt, the next number in the string file is called. If three attempts to that number fail, the next number in the string file is called, and so on. If the last phone number in the string file also fails three times, the process starts over with the first phone number.

If at any point the called phone number is answered, the message "A fire has been detected at 101 Main Street" is played. Within 30 seconds of the end of the message, the digital voice module expects to hear an acknowledge code from the person receiving the message. If the acknowledge code is not received, the digital voice module treats the call the same as a line busy or an unanswered call. The acknowledge code expected is a "1-2-3" dialed from a touch-tone phone. When the acknowledge code is received, the digital voice terminates the file, and no other calls are made.

The TELEPHONE command is only available to use in string files programmed for channel 1 with no secondary channels. TELEPHONE commands must be the first commands entered into the string. Once any other command has been selected when creating a string file, the TELEPHONE command is prohibited from being used.

Output Channels

The Series DV-200 may be configured with between one and four output channels. Installed output channels are labeled consecutively 1 to 4, as necessary. Message files may be programmed to play out any combination of the four output channels. When a message file is programmed to play out multiple output channels, the message will not necessarily play simultaneously on all selected output channels.

File Priority

The priority of a file playing on one channel will not affect the priority of files playing on any other channel. Priority levels are 1 thru 5, 1 being highest, 5 being lowest.

Priority 1 and Priority 2 files WILL interrupt any file with a lower priority that is playing through the same output channel. Priority 3 and Priority 4 files will NOT interrupt lower priority files but will begin playing immediately upon completion of any lower priority file. Any file that is interrupted by a higher priority file before it has completed playing will remain on the channel queue until it is allowed to replay completely.

If two or more files of equal priority are activated, the files will play sequentially as long as the files are activated.

Priority 4 and Priority 5 files may be acknowledged. Files are acknowledged by the reception of an acknowledge command on the serial port or activation of the acknowledge input. Acknowledged files will play one more time and then be removed from the queue. Dry contact activated files must have their input released and then reactivated to play again. Serial command activated files must have another serial start command transmitted to play again.

Files of all priority levels may be reset. Files are reset by the reception of a reset command on the serial port or activation of the reset input. Reset files will stop immediately and are removed from the queue. Dry contact activated files must have their input released and then reactivated to play again. Serial command activated files must have another serial start command transmitted to play again.

Note: In the United States the latest NFPA guidelines and standards provide that life safety/fire notification alarm tone(s) and voice message(s) are the only alarm tone(s) and message(s) that shall be assigned priority 1 for all Series DV-200 output channel(s) assigned to either a dedicated life safety/fire alarm protective signaling system or the life safety/fire alarm system portion of an integrated multi-function system.

Acknowledge Playing Files

All priority 4 and priority 5 files may be acknowledged. Files activated by a dry contact input may be acknowledged by activating the acknowledge dry contact input. Files activated by a serial command may be acknowledged by the serial acknowledge command. Files which have been acknowledged will play one more time and then be removed from the queue. String files which have been programmed with a file repeat will play the number of times selected by the file repeat option and then be removed from the queue. Dry contact activated files which have been acknowledged must have their input released and then reactivated to play again. Serial command activated files which have been acknowledged must have another serial start command transmitted to play again.

Any dry contact input may be selected to be the acknowledge input. An input selected to be the acknowledge input may not be used to activate files to play. The acknowledge input feature may be disabled by selecting input 0 to be the acknowledge input. The acknowledge input selection is located in the SETUP procedure from the main menu.

Reset Playing Files

Files of all priority levels may be reset. Files activated by a dry contact input may be reset by activating the reset dry contact input. Files activated by a serial command may be reset by the serial reset command. Files which have been reset will stop playing immediately and be removed from the queue. Dry contact activated files which have been reset must have their input released and then reactivated to play again. Serial command activated files which have been reset must have another serial start command transmitted to play again.

Any dry contact input may be selected to be the reset input. An input selected to be the reset input may not be used to activate files to play or to be the acknowledge input. The reset input feature may be disabled by selecting input 0 to be the reset input. The reset input selection is located in the SETUP procedure from the main menu.

Note: The reset switch must be located within a locked enclosure.

Playing Files

The Series DV-200 stores message file activation's in a separate queue (see "queue" definition in glossary) for each output channel. Files can be added to the queue by a contact activation or a serial port start command. Files in each queue are played in the order of file priority. Equal priority files are played in the order of activation.

When a contact activation is detected, the programmed message file is placed on the programmed queue. The contact input is then not checked for activation again until the message file completes playing. Therefore, a momentary contact closure will only play a message file once and a maintained contact closure will continuously repeat a message file as long as its input is held activated (unless it is interrupted by a higher priority file, played alternately with other equal priority files, acknowledged, or reset). (See "acknowledge" definition in Glossary.)

When a valid serial port start command is received, the programmed message file is placed on the programmed queue. Each time the file completes playing, the Series DV-200 checks to see if a valid serial port stop command has been received. If one has been received, the message file is removed from the queue. As long as the file is on the queue, it will repeat continuously (unless it is interrupted by a higher priority file, played alternately with other equal priority files, acknowledged, or reset).

System Pause

The ability to have a pause between messages is provided. Having a pause between all playing messages prevents messages from "running together" and then being misunderstood. The system pause may be any value from 1 to 999 seconds.

Supervision

A trouble condition indicates that the supervision functions have detected a malfunction in the Series DV-200. When a trouble condition is detected, the Series DV-200 may not be able to receive and/or remember message requests from the control panel. The installer and/or user must make sure that any message requests to the Series DV-200 during a trouble condition are reactivated if necessary when the Series DV-200 returns to normal.

If a trouble condition is detected by any of the supervision functions, the Series DV-200 Form C status relay (normally energized) will change state, the green system normal LED will turn off, and the amber trouble LED will turn on. The status relay contact closure must be properly connected to and used by the control panel to indicate a system trouble. At the same time, the amber trouble LED will identify if: (1) The Series DV-200 unit is inoperative (steady light) or (2) Troubleshooting is required (coded blinking light). If a trouble condition is indicated, follow the procedures in the "Troubleshooting and Servicing" section.

 **WARNING:** DO NOT LEAVE THE SERIES DV-200 IN A TROUBLE CONDITION, AS IT MAY NOT PLAY WARNING MESSAGES WHICH COULD RESULT IN PROPERTY DAMAGE AND SERIOUS INJURY OR DEATH TO YOU AND/OR OTHERS. IF THE SERIES DV-200 INDICATES A TROUBLE CONDITION: (1) PROVIDE UL REQUIRED ALTERNATIVE SIGNALING AND (2) HAVE QUALIFIED SERVICE PERSONS IMMEDIATELY REPLACE UNIT(S) THAT HAVE MALFUNCTIONED.

 **WARNING:** MESSAGES REQUESTED BEFORE AND DURING A TROUBLE CONDITION MAY NOT BE HEARD, WHICH COULD RESULT IN PROPERTY DAMAGE AND SERIOUS INJURY OR DEATH TO YOU AND/OR OTHERS. IF MESSAGES REQUESTED BEFORE AND DURING A TROUBLE CONDITION ARE STILL NECESSARY, THEY SHOULD BE REPEATED WHEN THE SERIES DV-200 IS RETURNED TO NORMAL.

Input Voltage Supervision

Input voltage is supervised, and if the input voltage drops below the operating minimum voltage, the Series DV-200 will stop operating and indicate a trouble condition. The input voltage is also supervised for ground faults.

Program Memory Supervision

The Series DV-200's program memory is supervised using sumcheck error techniques to detect any changes in EPROM data storage. If an error is detected, the Series DV-200 will stop operating and indicate a trouble condition.

Message Memory Supervision

The Series DV-200's message memory is supervised using sumcheck error techniques to detect any changes in PSRAM data storage. If an error is detected, the Series DV-200 will stop operating and indicate a trouble condition.

Microprocessor Supervision

The Series DV-200 has a watchdog circuit that supervises the processor and resets it (if necessary) or maintains a trouble condition if the processor cannot be restarted. The watchdog circuit constantly monitors the execution of the processor program, and if the processor program fails to function properly, will attempt to reset and restart the processor.

Expansion Module Supervision

If there are any Series DV-EM modules connected to the Series DV-200, the Series DV-200 will automatically detect their presence. It will then monitor these modules. Thereafter, if any module is disconnected, the Series DV-200 will indicate a trouble condition.

Input Line Supervision

All input lines (for contact closure or transistor activation) are supervised for open circuits and ground faults. Input line supervision requires a LISTED 10K end-of-line resistor to be installed on each input including all unused and unsupervised inputs. Internal Series DV-200/DV-EM circuitry is also supervised.

To comply with NFPA requirements for interconnection of fire alarm control equipment, the Series DV-200/DV-EM units must be located in the same room as, and within 20 feet of, a listed compatible fire alarm control panel and a listed compatible audio system, or a listed compatible audio system, with the wiring enclosed in conduit and properly connected to such panel.

 **WARNING:** THE INPUT LINE SUPERVISION DETECTS ONLY OPEN CIRCUITS AND GROUND FAULTS. IF THE INPUT LINE SUPERVISION IS NOT INSTALLED AS INDICATED, THE SERIES DV-200 WILL BE UNABLE TO DETECT OPEN CIRCUITS AND GROUND FAULTS ON THE INPUT LINE WHICH COULD RESULT IN PROPERTY DAMAGE AND SERIOUS INJURY OR DEATH TO YOU AND/OR OTHERS. A SHORT ON ANY INPUT LINE WILL BE INTERPRETED AS AN UNINTERRUPTED ACTIVATION OF THAT FILE.

Audio Supervision

The audio circuitry of each output channel is supervised up to the secondary of the output transformer. When a message is playing, a trouble condition is indicated if an audio signal is not detected for more than 3 seconds or a low impedance load (less than 600 Ohms) is connected to the output. An audio signal not detected or low impedance load detected trouble condition will clear automatically as soon as audio is detected or the low impedance load is no longer detected, respectively. When no messages are playing, the circuitry is continuously supervised for functionality. If a circuitry failed condition is detected, a trouble condition is indicated.

 **CAUTION:** External audio wiring is NOT supervised by the Series DV-200. Wheelock strongly recommends that the control panel be designed to supervise the audio wiring.

Serial Port Supervision

The Series DV-200 can receive instructions over a serial port. The protocol used on the serial port is described in Appendix A. If a second, optional protocol is provided on the serial port, it is described in Appendix B.

The serial port is supervised for communication errors and ground faults. A trouble condition will be indicated if a communication error is detected, the Series DV-200 does not select a file, or the received command is not understood. The trouble condition will return to normal with the next valid command received. See Appendix A (and B, if applicable) for additional serial port information.

The Series DV-200 also provides a response for each command received through the serial port. If so programmed, the control panel can supervise the serial port by receiving and comparing the response of each transmitted command. The control panel can both verify the integrity of the physical connection of the serial communication line and the integrity of the commands received by the Series DV-200.

 **CAUTION:** External wiring to/from the serial port of the Series DV-200 is NOT supervised by the Series DV-200. Wheelock strongly recommends that the control panel be programmed to use the Series DV-200's serial response capability (described in Appendix A or B if applicable) to verify the integrity of the serial communications link and to record any communication errors for corrective action.

Ground Fault Supervision

The Series DV-200 has the ability to supervise for ground fault conditions on field wiring that is not electrically isolated. The supervised wiring includes contact inputs and serial port wiring. All other wiring is electrically isolated. Ground fault supervision may be enabled and disabled by placing the "GROUND FAULT ENABLE/DISABLE" jumper (JP2) on the digital voice module in the desired position. See Figure 8 for the location of the jumper JP2 on the digital voice module.

Memory Retention Battery Supervision

The memory retention battery is supervised for correct placement and functionality. The battery is not supervised for level of charge. The battery is checked by the circuitry once every 5 minutes.

Telephone Line Supervision

When a telephone string file is selected to play out channel 1, channel 1's line out is supervised for connection to a telephone line. The telephone line is supervised by monitoring the telephone line's DC voltage and by detecting the proper call progress tones. If either of these two parameters are not correct, the Series DV-200 will indicate a trouble condition.

Telephone string files are also supervised for correct reception by the intended party. If three consecutive call attempts to the same phone number go unanswered and/or unacknowledged, the Series DV-200 will indicate a trouble condition.

Standby Battery Calculations

To calculate standby battery ampere-hour capacity needed to back-up the Series DV-200 system power based on maximum input current and number of output channels utilized, refer to the "Technical Specifications" section of this manual.

Note the indicated "stand-by" and "alarm" currents for the channel options supplied with your Series DV-200 model. Calculate the battery capacity needed for the Series DV-200 equipment based on the required hours of standby and alarm operation for your control system. Add this Series DV-200 capacity requirement to the capacity required for the rest of your control system.

Access Key and Password Protection

The Series DV-200 incorporates access key and password protection to prevent unauthorized use of the keypad. Passwords may be any number from 0 to 999. The password must be entered correctly to access any system functions.

The initial password is 111. It is strongly recommended that this password be changed. Instructions for changing passwords are given in the "Setup" section of Appendix C.

Once the password is entered correctly, the user has access to all system functions. If at any time the user has accessed a system function, but failed to utilize it for at least five minutes, the accessed system function will cease and the enter password screen will be displayed. The password then must be re-entered and the system function reaccessed.

Note: The access key and password should only be given to authorized and properly trained personnel who are responsible for the operation, testing, and maintenance of the Series DV-200.

Memory Retention Battery

The Series DV-200 contains a memory retention battery to power the PSRAM IC's during periods when input power has been disconnected from the Series DV-200. The battery's only function is to prevent the message files stored in the PSRAM IC's from being lost. The memory retention battery powers no other circuitry.

The Series DV-200 contains battery charging circuitry to maintain the battery at full charge. The charging circuitry has two charging rates, fast charge and trickle charge. The fast charge cycle is initiated whenever input power is connected to the Series DV-200 and lasts for 24 hours. After 24 hours the fast charge cycle is terminated and the trickle charge cycle is initiated and will remain on as long as input power remains connected to the Series DV-200.

The memory retention battery duration times for new fully charged batteries during periods of power loss, is shown in Table 1 below.

Note: The memory retention battery in the Series DV-200 is shipped in a completely discharged state.

 **CAUTION:** As batteries age, they lose their ability to charge completely. The memory retention battery should be replaced at least once per year to ensure optimum battery performance.

Memory Retention Battery Backup Duration for New Fully Charged Batteries During Periods of Power loss		
Number of Memory IC's	Minimum (Hrs)	Typical (Hrs)
1	3000	6000
2	1500	3000
3	1000	2000
4	750	1500
5	600	1200
6	500	1000
7	428	857
8	375	750

Table 1.

 **WARNING:** IF THE INPUT POWER IS DISCONNECTED AND THE MEMORY RETENTION BATTERY IS OR HAS BEEN DISCONNECTED OR DISCHARGED, ALL MESSAGES IN THE PSRAM IC'S WILL BE ERASED. IF STORED MESSAGES ARE ERASED, THEY WILL NOT BE DELIVERED TO THE AUDIO SYSTEM WHEN INPUT POWER IS RESTORED. THIS COULD RESULT IN PROPERTY DAMAGE, SERIOUS INJURY, OR DEATH TO YOU AND/OR OTHERS.

If for any reason the input power is disconnected and the memory retention battery is or has been disconnected or discharged and all messages in the PSRAM IC's are erased, all messages will have to be reprogrammed into the Series DV-200 once input power is reconnected.

Message Recording

 **WARNING:** PROVIDE ALTERNATIVE SIGNALING MEANS WHILE REPROGRAMMING MESSAGES TO ASSURE ADEQUATE PROTECTION OF PEOPLE AND PROPERTY. FAILURE TO PROVIDE ALTERNATIVE SIGNALING MAY CAUSE PEOPLE TO NOT BE WARNED OF AN EMERGENCY CONDITION, WHICH COULD RESULT IN PROPERTY DAMAGE AND SERIOUS INJURY OR DEATH TO YOU AND/OR OTHERS.

WHEELLOCK EXPRESSLY DISCLAIMS ALL LIABILITY FOR THE CONTENT, CLARITY AND LANGUAGES OF, AND OUTPUT CHANNEL AND PRIORITY LEVEL ASSIGNED TO, ANY AND ALL MESSAGES. IT IS ESSENTIAL THAT YOU HAVE MESSAGE CONTENT AND LANGUAGE, SEQUENCE, OUTPUT CHANNEL AND PRIORITY ASSIGNMENTS REVIEWED AND APPROVED BY QUALIFIED LEGAL AND SAFETY ADVISORS, QUALIFIED REPRESENTATIVE(S) OF OWNER(S) AND USER(S), AND AUTHORITIES HAVING JURISDICTION.

To aid qualified personnel in performing necessary operational testing procedures, a script, listing all messages programmed in the SAFEPATH panel, must be kept with the SAFEPATH panel.

This chapter describes the message recording procedures for the Series DV-200. Included is information about the following Series DV-200 capabilities:

- Setting Volume Controls
- Recording a Voice File
- Creating a String File
- Transferring Data

Performing the following procedures requires a knowledge of the display and keypad operation. Operation of the display and keypad is explained in Appendix C. Appendix C must be read and understood before proceeding.

Setting Volume Controls

The Series DV-200's record circuit has one microphone input volume control and one auxiliary input volume control. The playback circuit contains one volume control for each of the four output channels. The locations of the six volume controls on the Series DV-200 are shown in Figure 2. Note that all volume controls can be accessed without removing the printed circuit board cover.

The two input volume controls determine the record level of messages from each of the two sources. If the input volume controls are set too high the Analog-to-Digital converter circuit will be overdriven and/or the input preamps will have clipped outputs. Either of these two conditions will cause distortion. If the input volume controls are set too low the Analog-to-Digital converter circuit will be underdriven. This will cause distortion and louder than normal background noise.

The four output channel volume controls determine the playback level of messages on each of the output channels. If the output channel volume controls are set too high, the output channel amplifiers will have clipped outputs causing distortion. If the output channel volume controls are set too low, the Series DV-200 may not detect the audio level properly.

Before recording messages the input volume controls and the output channel volume controls should be set according to the procedures set forth below.

Input Volume Control Adjustment Procedure

1. Set output channel volume control to minimum.
2. Set input volume control to maximum.
3. Record a message.
4. Play message. If message sounds distorted, decrease the input volume control. Repeat from step 3.

Output Channel Volume Control Adjustment Procedure

1. Set output channel volume control to minimum.
2. Play a message. If message volume is too low, or if an output channel error is detected, increase the output volume control. Repeat from step 2.

Recording a Voice File



WARNING: IF THE USER EXCEEDS THE AMOUNT OF AVAILABLE MESSAGE MEMORY WHILE RECORDING A VOICE FILE, PART OR ALL OF THE VOICE FILE WILL NOT BE RECORDED. IF PART OR ALL OF THE VOICE FILE IS NOT RECORDED, THE INTENDED MESSAGE WILL NOT BE PLAYED WHEN AND WHERE REQUIRED. THIS COULD RESULT IN PROPERTY DAMAGE AND SERIOUS INJURY OR DEATH TO YOU AND/OR OTHERS.

The following instructions will enable the user to record a voice, tone, or other sound message, play the message back to verify its content, clarity, and output channel assignment, and view file data to verify priority.

1. Select "PROGRAM FILE" from the main menu.
2. Select "RECORD" from the program file menu.
3. Enter file number.
4. Enter priority level. If no priority level is entered, the Series DV-200 will default to the lowest priority level (5).
5. Enter primary channel number. If no channel number is entered, the Series DV-200 will default to the last selected primary channel number.
6. If the file is to play out multiple channels when activated, select "YES" at the first secondary channel menu. If the file is to play out only a single channel when activated, select "NO" at the first secondary channel menu.
7. Enter secondary channel numbers, if necessary.
8. Record message. Press "1" to start recording. Press "1" a second time to stop recording. While recording, a countdown timer appears on the display indicating the remaining available memory.
9. Select "PLAY FILE" from the main menu.
10. Enter file number.
11. Listen to the message as it is being played to verify message content, clarity, and output channel assignment. If the message clarity is unacceptable or the message content or output channel assignment is incorrect, the message must be re-recorded.
12. Observe the trouble LED's while the message is being played. If an output channel error is indicated, the channel's volume control must be adjusted higher and/or the message re-recorded at a higher level.

NOTE: A voice file must not contain 3 or more consecutive seconds of silence. The Series DV-200 will indicate an output channel error whenever audio is not detected for 3 or more seconds while a voice file is playing. If silence is required as part of a message, the silence should be the result of a pause command in a string file to prevent indication of a trouble condition.

13. Select "DIAGNOSTICS" from the main menu.
14. Select "VIEW FILE DATA" from the diagnostics menu.
15. Enter file number.
16. Check priority level.

Creating a String File

The following instructions will enable the user to create a non-telephone string file, play the file back to verify its content, clarity, and output channel assignment, and view file data to verify priority.

1. Select "PROGRAM FILE" from the main menu.
2. Select "STRING" from the program file menu.
3. Enter file number.
4. Enter priority level. If no priority level is entered, the Series DV-200 will default to the lowest priority level (5).
5. Enter primary channel number. If no channel number is entered, the Series DV-200 will default to the last selected primary channel number.
6. If the file is to play out multiple channels when activated, select "YES" at the first secondary channel menu. If the file is to play out only a single channel when activated, select "NO" at the first secondary channel menu.
7. Enter secondary channel numbers, if necessary.
8. Files (voice and non-telephone string), pauses and repeats may be added to string file from string file menu.
9. Select "PLAY FILE" from the main menu.
10. Enter file number.
11. Listen to the message as it is being played to verify message content, clarity, and output channel assignment. If the message clarity is unacceptable or the message content or output channel assignment is incorrect, the message must be re-recorded.
12. Observe the trouble LED's while the message is being played. If an output channel error is indicated, the channel's volume control must be adjusted higher and/or the problem voice file(s) re-recorded at a higher level.

NOTE: A string file must not play voice files in an order which would allow 3 or more consecutive seconds of silence. The Series DV-200 will indicate an output channel error whenever audio is not detected for 3 or more seconds while voice files are playing. If silence is required as part of a message, the silence should be the result of a pause command in the string file to prevent indication of a trouble condition.

13. Select "DIAGNOSTICS" from the main menu.
14. Select "VIEW FILE DATA" from the diagnostics menu.
15. Enter file number.
16. Check priority level.

The following instructions will enable the user to create a telephone string file, play the file back to verify its content, clarity, output channel assignment, and telephone numbers, and view file data to verify priority.

1. Select "PROGRAM FILE" from the main menu.
2. Select "STRING" from the program file menu.

3. Enter file number.
4. Enter priority level. If no priority level is entered, the Series DV-200 will default to the lowest priority level (5).
5. Enter channel number 1.
6. Select "NO" at the first secondary channel menu.
7. Enter all telephone numbers which are to be called from the string file menu. Telephone numbers must be the first items added to the string file. Once a file, pause, or repeat has been added, telephone numbers can not be added.
8. Files (voice and non-telephone string), pauses, and repeats may be added to the string file from the string file menu.
9. Select "PLAY FILE" from the main menu.
10. Enter file number.
11. Verify which telephone numbers are being dialed and then listen to the message as it is being played to verify message content, clarity, and output channel assignment. If the message clarity is unacceptable or the message content or output channel assignment is incorrect, the message must be re-recorded.
12. Observe the trouble LED's while the message is being played. If an output channel error is indicated, the channel's volume control must be adjusted higher and/or the problem voice file(s) re-recorded at a higher level.

NOTE: A string file must not play voice files in an order which would allow 3 or more consecutive seconds of silence. The Series DV-200 will indicate an output channel error whenever audio is not detected for 3 or more seconds while voice files are playing. If silence is required as part of a message, the silence should be the result of a pause command in the string file to prevent indication of a trouble condition.

13. Select "DIAGNOSTICS" from the main menu.
14. Select "VIEW FILE DATA" from the diagnostics menu.
15. Enter file number.
16. Check priority level.

Transferring Data

The Series DV-200 is capable of downloading files and system configuration data from itself to a Series DV-100 or another Series DV-200. Files may be either voice files or string files. System configuration data includes system pause information.

The Series DV-200 containing the data to be downloaded is referred to as the source Series DV-200. The digital voice panel (Series DV-100 or Series DV-200) that is to receive the downloaded data is referred to as the destination digital voice panel. To download data, the source Series DV-200 and destination digital voice panel must be setup and connected as follows:

1. Connect the J2 (see Figure 8) connectors on both digital voice panels using Wheelock Model Number CAB-P cable (not supplied with the digital voice panels, must be ordered separately).
2. Place the communication mode jumpers (JP1) on each of the digital voice panels in position A. See Figure 8 for the location of the jumper (JP1) on the Series DV-200 printed circuit board and Figure 8 in the Series DV-100 VoiceLink Operation and Installation Manual for the location of the jumper JP1 on the Series DV-100 printed circuit board.

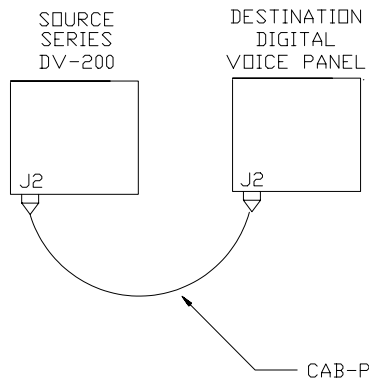

NOTE: When downloading to a Series DV-100 the input voltage to the Series DV-100 must exceed 15VDC. If the voltage does not exceed 15VDC, the Series DV-100 will not be able to program its EPROM's and will indicate a trouble condition.

Single File Download Procedure

1. Select "TRANSFER FILE" from the main menu on the source Series DV-200.
2. Select "MESSAGE/STRING" from the next menu.
3. Select "FILE" from the next menu.
4. Enter file number of the file to be transferred.
5. Repeat step 3 for all files which need to be downloaded.
6. Test the destination digital voice panel to ensure that all files (messages, output channel assignments, and priority assignments) were transferred properly by activating all transferred files on the destination digital voice panel.

The length of time required to download each file will vary depending upon the length of the file. String files are typically very short and should be downloaded within several seconds. Voice files are typically very long. When downloading voice files, a good rule of thumb is that downloading will require 30 seconds for every second of recorded time.

If for any reason the downloading sequence is interrupted (due to power loss, a disconnected cable, etc.), disconnect input power to the destination digital voice panel for a minimum of two seconds and then reconnect. If downloading to a Series DV-200, the partially transmitted file must be re-downloaded, according to the procedures set forth below. If downloading to a Series DV-100, the partially transmitted file must be either disabled or re-downloaded, according to the procedures set forth below. A disabled file may not be played or re-used without erasing all EPROM's in the Series DV-100 with an ultraviolet (UV) light source.

All Files Download Procedure

1. Select "TRANSFER FILE" from the main menu on the source Series DV-200.
2. Select "MESSAGE/STRING" from the next menu.
3. Select "ALL" from the next menu.

The length of time required to download each file will vary depending on the number, types, and sizes of the files to be downloaded. A good rule of thumb is that downloading will require 30 seconds for every second of recorded time.

If for any reason the downloading sequence is interrupted (due to power loss, a disconnected cable, etc.), disconnect input power to the destination digital voice panel for a minimum of two seconds and then reconnect. If downloading to a Series DV-200, the partially transmitted file must be re-downloaded, according to the procedures set forth below. If downloading to a Series DV-100, the partially transmitted file must be either disabled or re-downloaded, according to the procedures set forth below. A disabled file may not be played or re-used without erasing all EPROM's in the Series DV-100 with an ultraviolet (UV) light source.

 **CAUTION:** Never disable a file on the Series DV-200. Disabling a file on a Series DV-200 will cause a trouble condition to be indicated.

File Disable Procedure (Series DV-100 Only)

1. Select "TRANSFER FILE" from the main menu.
2. Select "REMOVE" from the incomplete file menu.

File Re-Download Procedure

1. Select "TRANSFER FILE" from the main menu.
2. Select "REXMIT" from the incomplete file menu.

If the re-download attempt fails, when re-downloading to a Series DV-100, the file must be disabled.

System Configuration Data Download Procedure

1. Select "TRANSFER FILE" from the main menu on the source Series DV-200.
2. Select "CONFIGURATION" from the next menu.

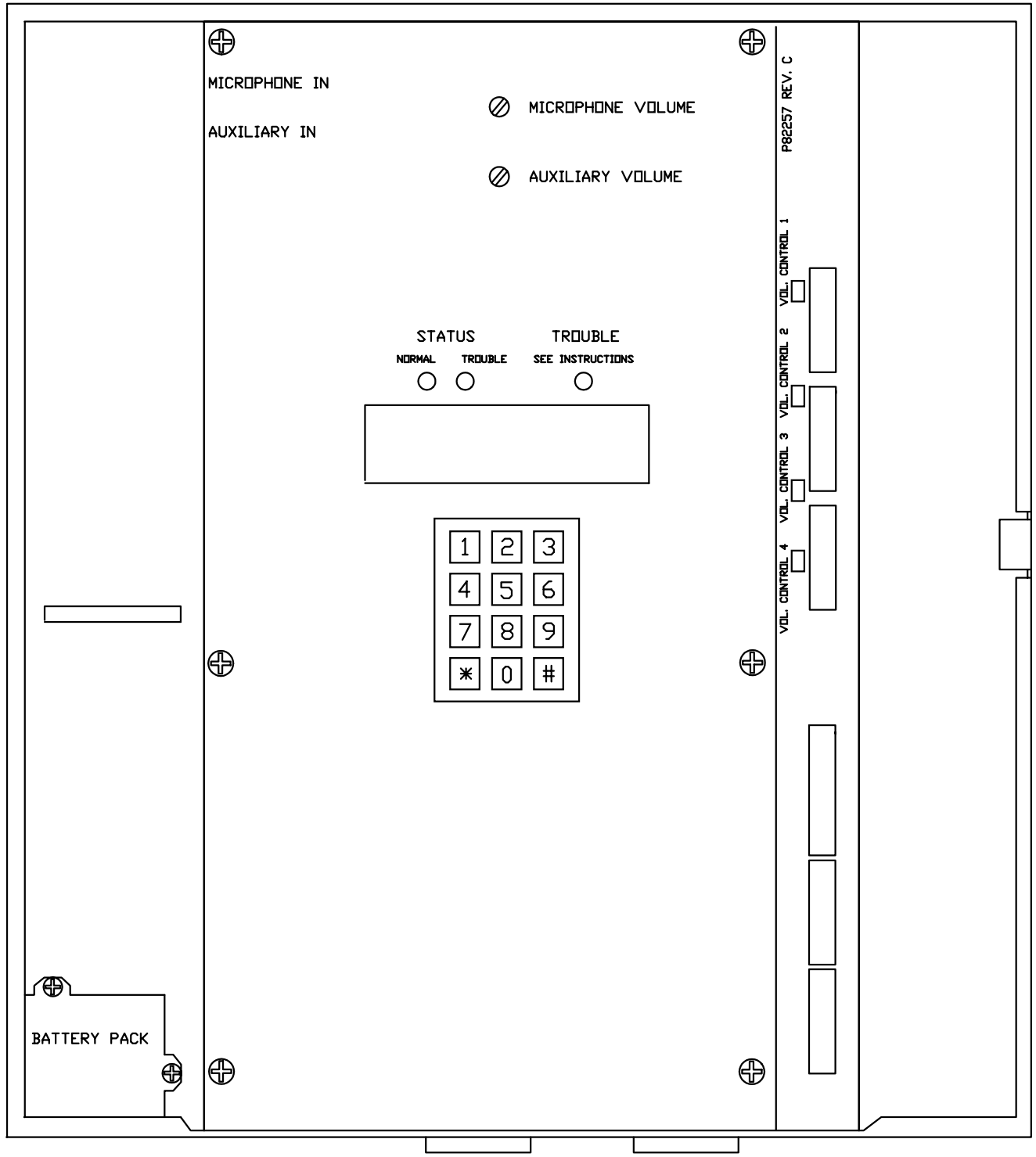



Figure 2.
Series DV-200 Interior View

Installation

The lives of people depend upon your safe installation of the Series DV-200. Please read, understand and follow the specific installation instructions set forth below to avoid damage to the Series DV-200 and equipment connected to it. Installation should be conducted only by qualified persons in accordance with the procedure in this manual.

 **WARNING:** **SHUT OFF ALL POWER BEFORE STARTING THE INSTALLATION. ELECTRICAL SHOCK CAN CAUSE DEATH OR SERIOUS INJURY.**

 **CAUTION:** The Series DV-200 printed circuit boards are sensitive to static electricity and have delicate components mounted on them. Before handling either a board or any component on a board, discharge any static electricity from your body by touching a grounded object such as a metal screw which is connected to earth ground. Handle the board by its edges, and be careful not to twist or flex it. The Series DV-200 is to be installed in a static free area and the user is to properly attach grounded wrist straps before touching any static sensitive areas. After handling Series DV-200 printed circuit boards, the Series DV-200 should be tested in accordance with the "System Checkout" section to verify that the printed circuit boards are undamaged and functioning properly.

 **CAUTION:** The Authorities Having Jurisdiction (AHJ) should be consulted by the installer prior to installation.

1. Prepare a drawing of the complete system wiring. (Keep a copy of the system wiring drawing with the Series DV-200 manual as a permanent record of the system wiring.) See the "Wiring Guidelines" and the "Field Wiring" sections to help develop this drawing.
2. Carefully unpack the Series DV-200 and make sure each item described on the packing slip is present and undamaged.
3. Mount the Series DV-200 (and optional Series DV-EM modules) in the desired location as described in the "Mounting" section.
4. Mount any additional wiring boxes or junction boxes needed to interconnect field wiring.
5. Connect conduit fittings or bushings as needed using knockouts provided on the top and bottom of the Series DV-200/DV-EM units.
6. Install field wiring in conduit when necessary, following the National Electrical Code and local codes for the type of system being installed. Make all necessary connections at any additional wiring or junction boxes.

 **CAUTION:** Provide proper strain relief for all wiring not in conduit.

7. Connect the Series DV-200 to earth ground, following the National Electrical Code and local codes for the type of system being installed, as described in the "Grounding" section.
8. Check the integrity of all field wiring following the directions in the "Field Wiring Checkout" section. Confirm that the specified cable is installed and that there is continuity between required points (no open circuits), with no unwanted connections (shorts) to other conductors, chassis, or earth ground.
9. Connect the wiring to the appropriate terminals of the Series DV-200/DV-EM modules following the directions in the "Field Wiring" section and the system wiring drawing you created in Step 1.
10. Apply power and perform the operational tests described in the "System Checkout" section.

Wiring Guidelines

Although the Series DV-200 incorporates signal verification and noise filtering circuitry on its input, induced voltages or noise on the input wiring can cause improper operation. Therefore, use shielded twisted pair wire for all fire input wiring. The audio output lines (and the auxiliary music input lines) should also be wired with shielded twisted pair to minimize noise pick-up. For all other connections, twisted pair is recommended to reject common mode noise, but shielding is optional.

The shield of each cable should be connected only at one end. Each shield of each cable that connects to the Series DV-200 is to connect to the grounding points provided near the knockout locations on the chassis (see Figure 3).

 **WARNING:** ALL SERIES DV-200 DRY CONTACT INPUT WIRING AND AUDIO WIRING SHOULD BE ROUTED AWAY FROM ANY HIGH VOLTAGE OR HIGH CURRENT LINES (SUCH AS AC OR DC POWER LINE, AUDIO POWER LINES, AND MOTOR OR RELAY ACTUATION LINES) AND SHOULD BE INSTALLED IN SEPARATE CONDUIT FROM HIGH VOLTAGE OR HIGH CURRENT LINES. FAILURE TO DO SO MAY CAUSE ELECTRICAL SHOCK RESULTING IN PROPERTY DAMAGE AND SERIOUS INJURY OR DEATH TO YOU AND/OR OTHERS.

The National Electrical Code defines two types of circuits for protective signaling systems: **power limited** circuits and **non-power limited** circuits. Series DV-200/DV-EM dry contact input circuits and Series DV-200 audio output circuits and power inputs have been designed as **power limited circuits**.

 **CAUTION:** The National Electric Code limits the maximum number of conductors that can be installed in conduit and wiring boxes depending on the size of the conduit, the volume of the boxes, and the gauge of the wire used. Make sure that wiring used for Series DV-200/DV-EM installation complies with the latest NEC requirements for power limited circuits.

See the "Field Wiring" section for recommended wire sizes and wire type to use for all Series DV-200 input and output lines.

Mounting

The Series DV-200 shall be mounted in a location within the environmental limits specified in the latest UL Standard for indoor control panels. The Series DV-200 shall not be located in a hazardous location. Refer to the "Technical Specifications" section.

 **CAUTION:** In order to comply with the latest NFPA and UL requirements for interconnection of fire alarm control equipment, the Series DV-200 units must be located in the same room as, and within 20 feet of, a LISTED compatible fire alarm control panel and LISTED compatible audio system, or a LISTED compatible audio system, with the wiring enclosed in conduit and properly connected to such control panel and/or audio system.

Refer to Figure 3 for Series DV-200 mounting hole layout. Drill mounting holes for appropriate screws and anchors to ensure secure mounting to the type of surface at the selected location. Keep out dust and dirt during installation. Dust and dirt can interfere with the operation and reduce the life of the equipment.

Remove the door and mount the Series DV-200 at the selected location. It is NOT necessary to remove the PC board cover from the chassis. **Use care to avoid damage to the PC board during installation.** Do not apply excessive pressure to the PC board or its components, including field wiring terminals and connectors.

Refer to Series DV-EM operations and installation manual for Series DV-EM mounting instructions.

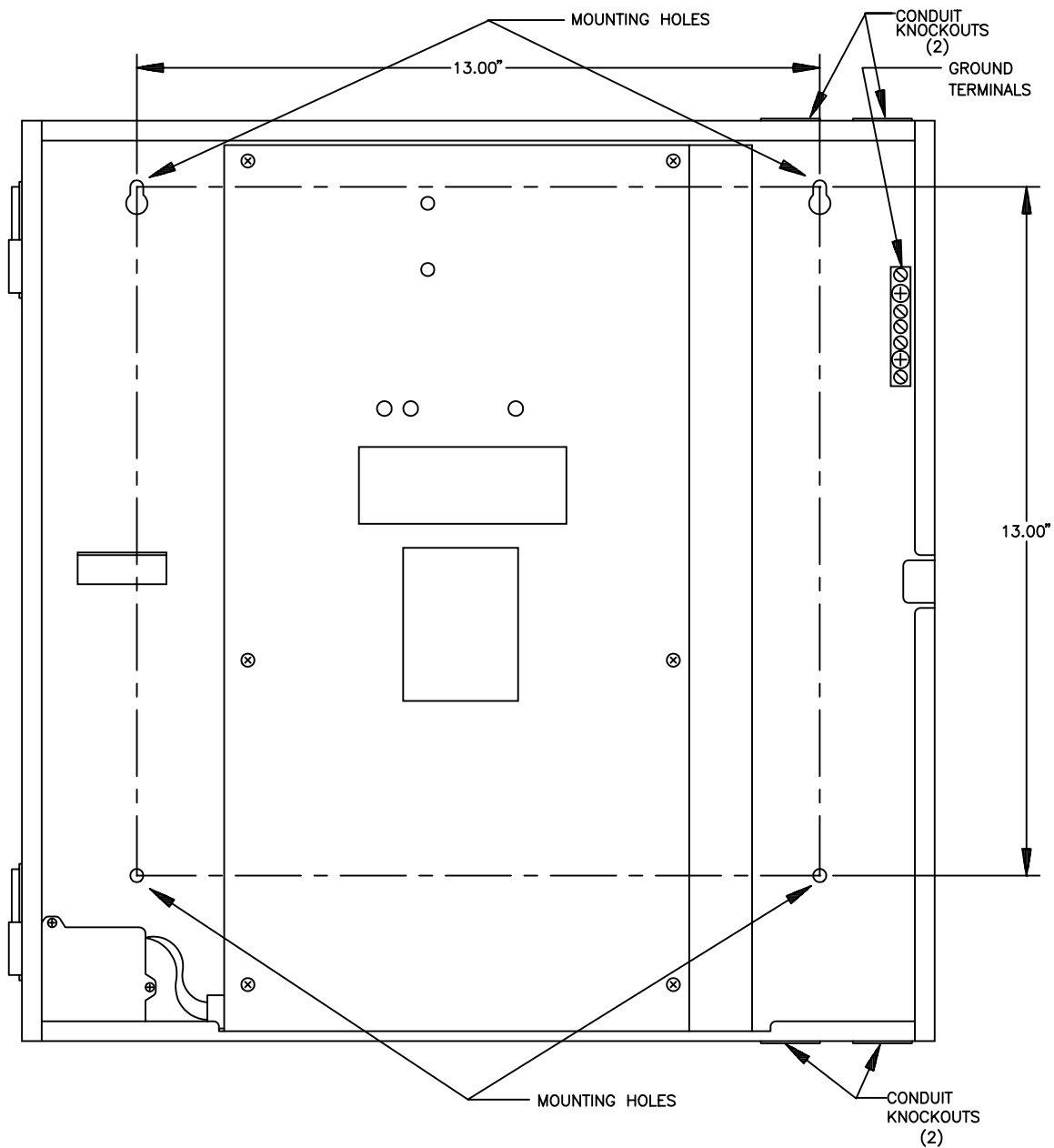

Figure 3.
Series DV-200 Mounting

Grounding

The Series DV-200 should be connected to earth ground in accordance with the National Electrical Code. Connecting the Series DV-200 to earth ground will reduce the static discharge failures (which can include PSRAM memory failure), improve transient protection, and reduce the chance of electrical shock. The Series DV-200 should be grounded as follows:

- 1) Connect a wire between the ground screw on the printed circuit board and the ground terminals on the enclosure. See Figure 8 for location of the ground screw (labeled "EARTH GND") on the printed circuit board and Figure 3 for the location of the ground terminals on the enclosure.
- 2) Connect a wire between the ground terminals on the enclosure and earth ground.

Field Wiring

Before installation, the system specifier must determine the proper wire gauge for all field wiring. The field wiring is broken down into six categories: dry contact input, audio output, music input, channel playing contact, status contact, and input voltage.

Note: All field wiring shall conform to applicable codes and standards including NFPA, UL, local, state, county, province, district and federal codes and standards.

Series DV-200 Field Wiring Connection

All Series DV-200 wiring terminals are designed to accept #22 AWG to #16 AWG wiring (one wire per terminal). Connect the field wiring to the Series DV-200 terminals while referring to the following sections.

Check the integrity of all field wiring following directions in the "Field Wiring Checkout" section. Confirm that the specified cable is installed and there is continuity between required points (no "opened circuits"), with no unwanted connections ("shorts") to other conductors, chassis, or earth ground). **Perform the field wiring checkout before continuing with any connections to the Series DV-200/DV-EM wiring terminals.**

 **WARNING: TO REDUCE THE RISK OF ELECTRICAL SHOCK, NEVER CONNECT OR DISCONNECT FIELD WIRING WHEN INPUT VOLTAGE IS CONNECTED TO THE SERIES DV-200.**

Dry Contact Input Wiring

The dry contact inputs shall be dry contacts or open collector devices. Dry contacts or open collectors from multiple devices may be connected in parallel as shown in Hook-up A in Figure 4. If multiple inputs are located at the same location, the (-) input leg may be commoned to reduce wiring requirements as shown in Hook-up B in Figure 4. Each input circuit must have a LISTED 10K end-of-line resistor across the last input contact. All unused or unsupervised inputs must have a LISTED 10K end-of-line resistor installed across input terminals. The LISTED 10K end-of-line resistors must have a 1/8W minimum power rating and 5% maximum tolerance.

Series DV-200 dry contact inputs meet the requirements for power limited fire protective signaling circuits as defined in the National Electrical Code. Each input meets Class B, Style B supervision requirements for initiating device circuits.

The gauge of the wire necessary for dry contact input wiring may vary for each dry contact input. The field wiring for each dry contact input shall not exceed 100 ohms of resistance and 0.050 microfarads of capacitance.

Audio Output Wiring

One audio output is provided per zone. A detail of the audio output terminal connections is shown in Figure 5. Determination of wire gauge should consider all factors including loop length, audio output level, amplifier input sensitivity, audio output impedance, and amplifier input impedance.

Music Input Wiring

One music input is provided per zone. A detail of the music input terminal connections is shown in Figure 5. Determination of wire gauge should consider all factors including music input loop length, audio output loop length, music source output level, amplifier input sensitivity, music source output impedance, and amplifier input impedance.

Channel Playing Contact Wiring

One channel play contact is provided per zone. It is normally open and is rated for 0.5 Amps at 24VDC resistive load. A detail of the channel play contact terminal connections is shown in Figure 5. Determination of wire gauge should consider all factors, including loop length, maximum current capacity and maximum voltage drop allowable.

Status Contact Wiring

One status contact is provided. It is Form C and is rated for 0.5 Amps at 24VDC, resistive load. A detail of the status contact terminal connections is shown in Figure 6. The contact in Figure 6 is shown in the trouble position. Determination of wire gauge for the status contact wiring should consider all factors, including loop length, maximum current capacity, and maximum voltage drop allowable.

Input Voltage Wiring

A detail of the input voltage terminal connections is shown in Figure 6. Determination of wire gauge for the input voltage wiring should consider all factors, including loop length, power supply voltage, maximum Series DV-200 current consumption, and input voltage range of Series DV-200.

IT IS IMPORTANT THAT THE WIRING USED FOR INPUT VOLTAGE WIRING IS LARGE ENOUGH TO CARRY THE MAXIMUM CURRENT REQUIRED BY THE SERIES DV-200 WITHOUT EXCESSIVE VOLTAGE DROP. IF VOLTAGE DROPS FROM POWER SUPPLY LOADING AND WIRING RESISTANCE ARE NOT WITHIN THE SPECIFIED OPERATING VOLTAGE RANGE, THE SERIES DV-200 WILL NOT FUNCTION PROPERLY.

Series DV-EM Wiring

One Series DV-EM port is provided. This port allows up to eight Series DV-EM's to be connected to the Series DV-200. Attach the first Series DV-EM (J1, male plug) to the Series DV-200 (J1, female socket) with cable assembly CAB-EM. See Figure 8 for the location of J1 on the Series DV-200 printed circuit board and Figure 1 in the Series DV-EM VoiceLink Operation and Installation Manual for the location of connectors on the Series DV-EM printed circuit board. Connect the cable's male plug to the J1 female socket on the right-side bottom of the Series DV-200. Connect the cable's female socket to the J1 male plug on the left-side of the Series DV-EM. To install additional Series DV-EMs, attach the next Series DV-EM (J1, male plug) to the previous Series DV-EM (J2, female socket). Optionally, the Series DV-EMs can also be interconnected using the CAB-EM cable assembly.

Do not substitute alternate cables or connect field wiring to the eight series DV-200 dry contact inputs when any DV-EM modules are used, as the series DV-200 may fail to operate properly.

RS-232 Port Wiring

One RS-232 port is provided. It is a ten wire interface. The pin out of the RS-232 port is shown in Figure 9. The field wiring required will be a function of the protocol implemented. See Figure A (and B, if applicable) for protocol information.

For RS-232 wiring, connect an RS-232 cable (not supplied) from the control panel to the J2 female socket on the left-side bottom of the Series DV-200. See Figure 8 for location of J2 on Series DV-200.

Current RS-232 specifications limit RS-232 communication paths to 50 feet in length. A particular installation may be limited to shorter paths depending on factors such as wire gauge and wire capacitance.

RS-485 Port Wiring

One RS-485 port is optional. It is a four wire interface. The pin out of the RS-485 port is shown in Figure 10. The field wiring required will be a function of the protocol implemented. See Appendix B, if applicable, for protocol information.

Current RS-485 specifications limit RS-485 communication paths to 200 feet in length. A particular installation may be limited to shorter paths depending on factors such as wire gauge and wire capacitance.

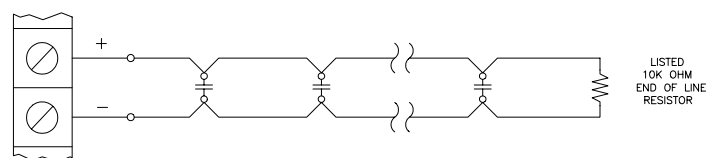

Hook-Up A

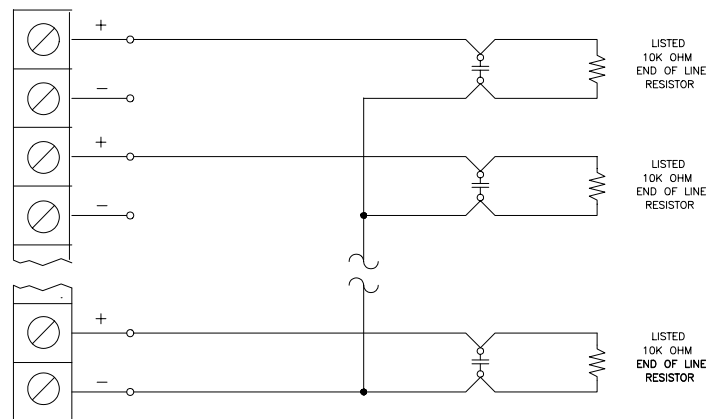

Hook-Up B

Figure 4.
Dry Contact Input Wiring

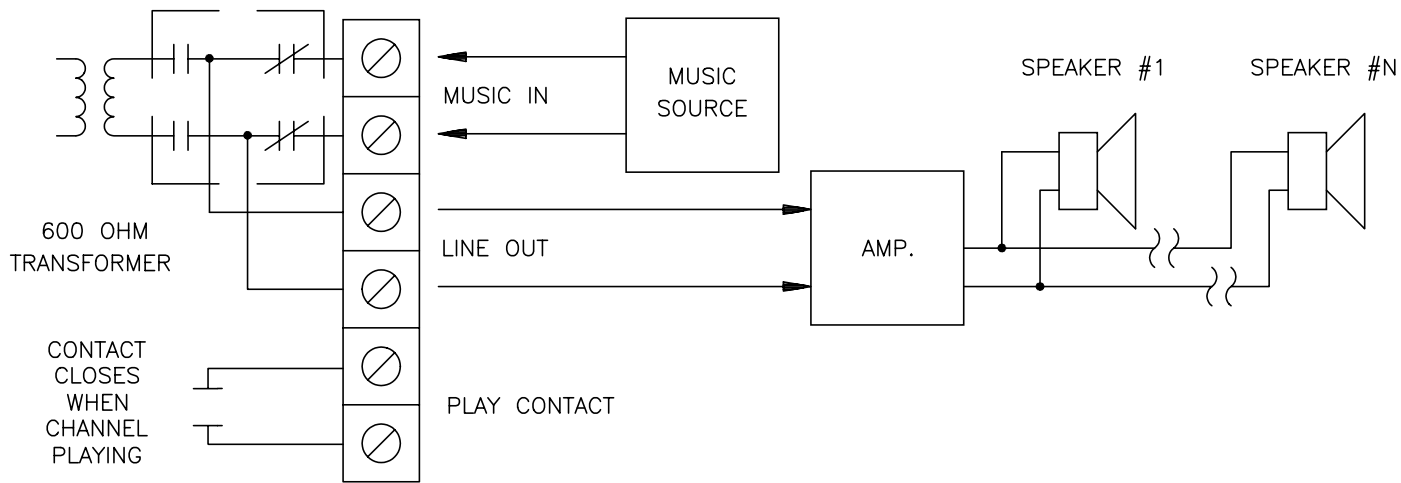

Figure 5.
Audio Output/Music Input/Channel Playing Wiring

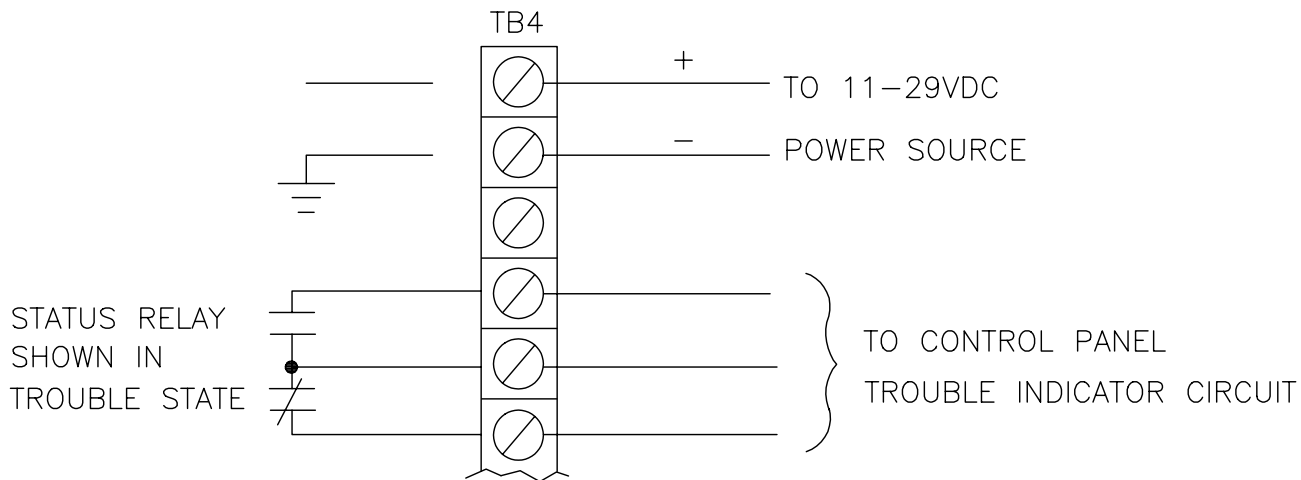

Figure 6.
Input Voltage And Status Contact Wiring

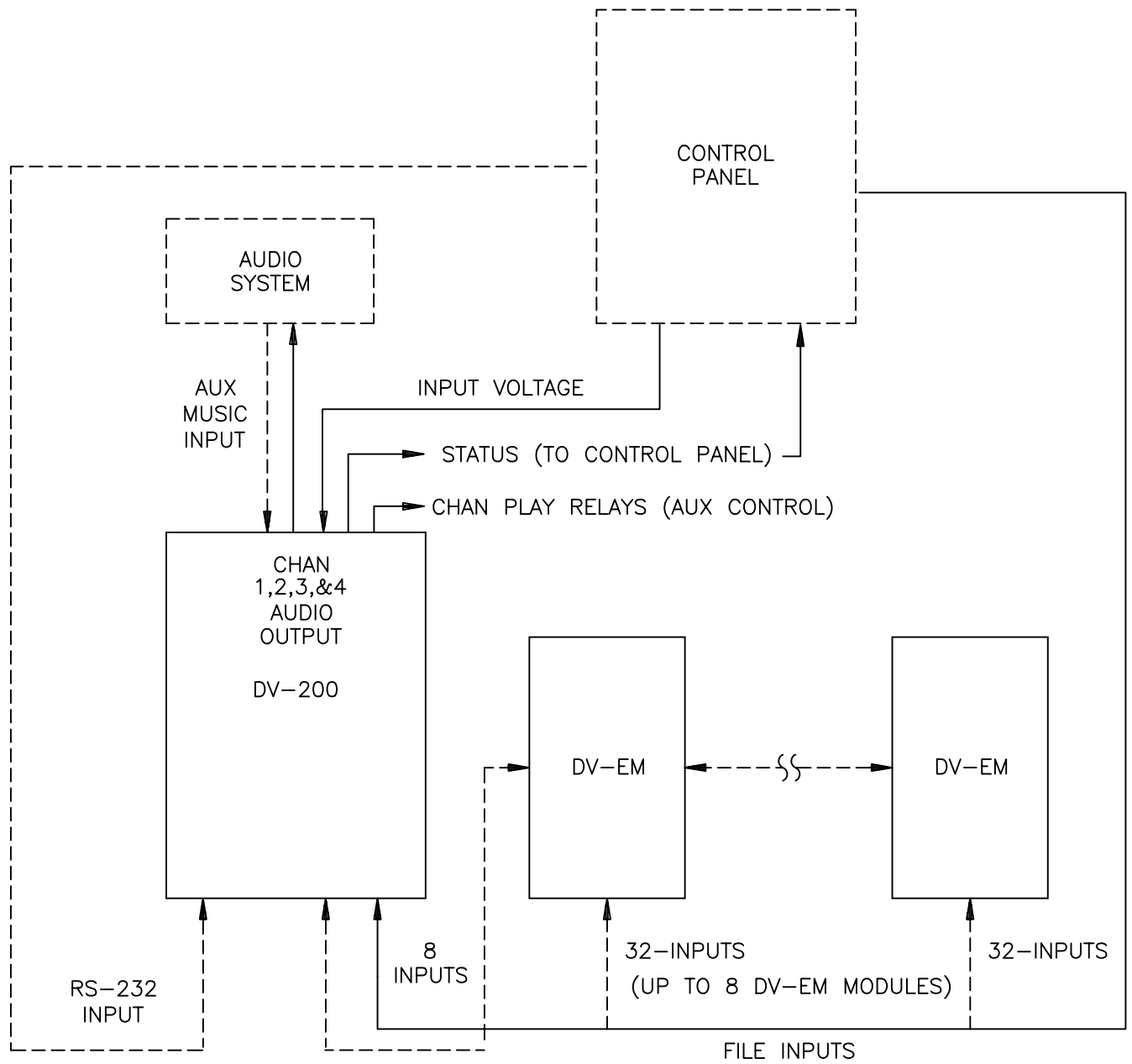

Figure 7.
Typical System Block Diagram

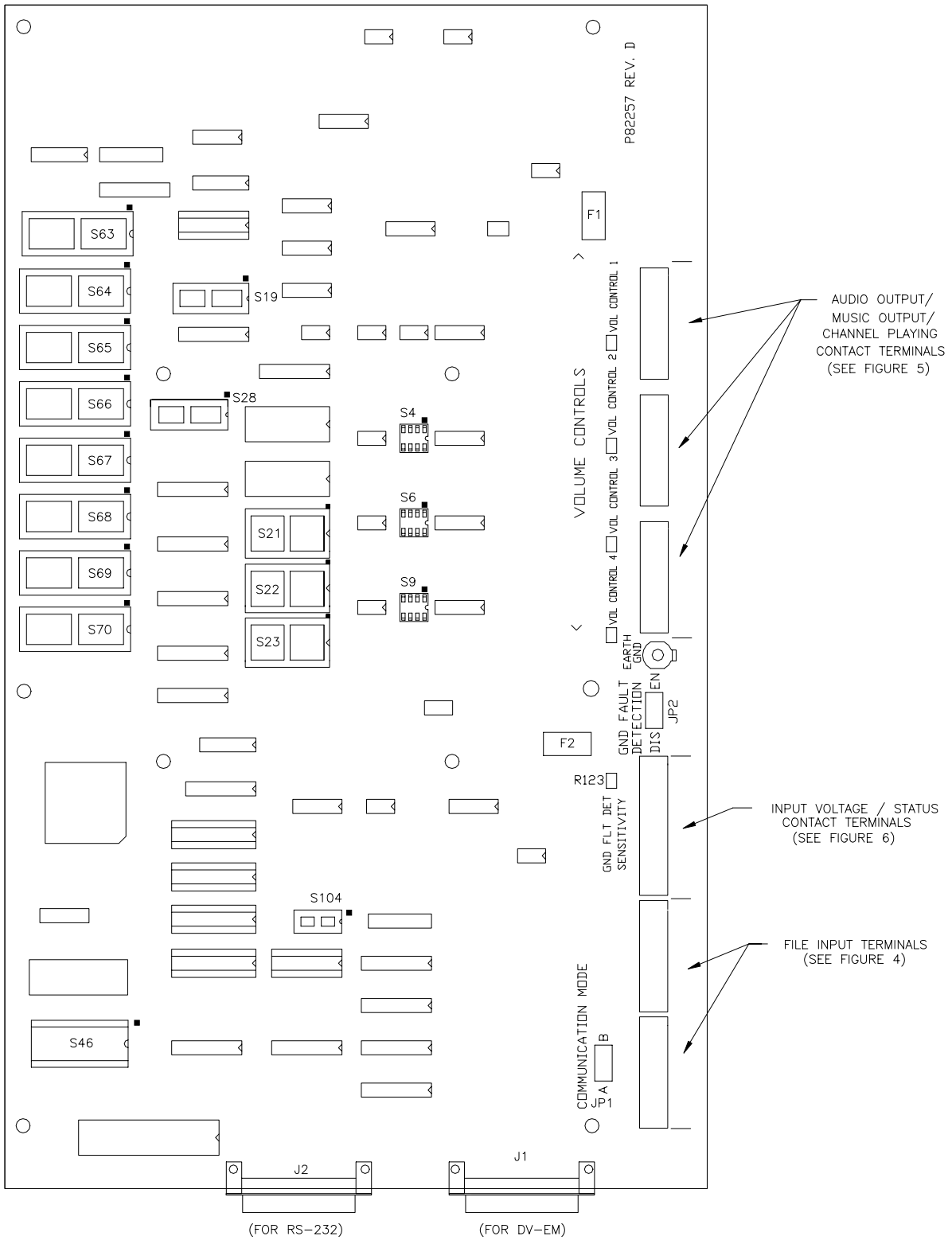
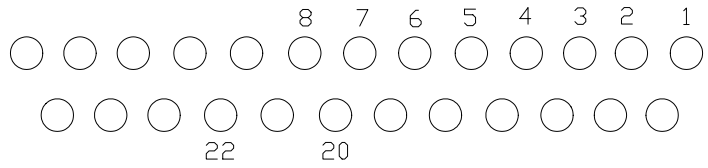

Figure 8.
Series DV-200 Main Board Layout

Pin	
1	** Chassis Ground
2	TD (Transmit Date)
3	RD (Receive Data)
4	* RTS (Request To Send)
5	* CTS (Clear To Send)
6	* DSR (Data Set Ready)
7	COM (Signal Ground)
8	* DCD (Data Carrier Detect)
20	* DTR (Data Terminal Ready)
22	* RI (Ring Indicator)

* Optional (Not used with standard protocol)
 ** Not Connected Internally to Signal Ground

RS-232D CONNECTOR



VIEWED FROM FRONT OF FEMALE CONNECTOR

Figure 9.
RS-232 Port Pin Out

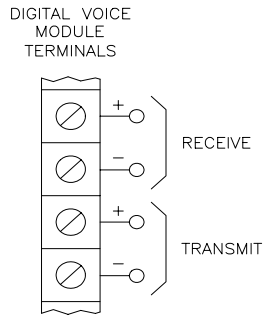

Figure 10.
RS-485 Port Pin Out

Field Wiring Checkout

Refer to NFPA for guidelines on testing signaling system wiring.

CAUTION: Do not connect input voltage to any equipment until the field wiring has been inspected and approved.

Verify that the field wiring is in full agreement with this manual and with the detailed wiring layout prepared for this installation.

Ensure that no unwanted voltages are present on circuit conductors and ground. Test all ungrounded connectors for electrical isolation from ground. Test all wires that are not intentionally connected for electrical isolation from each other. Measure and record the resistance of each circuit pair (this can be done by temporarily short circuiting one end of the circuit).

System Checkout

Refer to NFPA for guidelines on testing signaling systems.

When rated input voltage is applied to the Series DV-200, the unit initializes its program and broadcasts a tone signal through each output channel for several seconds. The green system normal LED indicator should be on to indicate normal operation. If the amber system trouble LED is on, a trouble condition is indicated. Refer to the "Troubleshooting and Servicing" section to diagnose and correct the trouble condition.

The system checkout should include:

1. Testing all inputs and outputs.
2. Testing all connections to equipment that is interconnected with the Series DV-200.
3. Testing all message files for proper audibility, intelligibility, content and priority.

If a malfunction is discovered during testing, the problem should be corrected immediately before continuing with testing.

 **WARNING:** ALL PROTECTIVE SIGNALING SYSTEMS REQUIRE PERIODIC TESTING. ALL PROTECTIVE SIGNALING SYSTEM EQUIPMENT SHALL BE TESTED BY QUALIFIED PERSONNEL AT LEAST TWICE A YEAR FOR PROPER OPERATION, OR MORE OFTEN IF REQUIRED BY CODES, REGULATIONS AND LAWS. FAILURE TO MAINTAIN AND TEST PROTECTIVE SIGNALING SYSTEM EQUIPMENT CAN RESULT IN NOT DETECTING EQUIPMENT FAILURE THAT CAN CAUSE PROPERTY DAMAGE AND SERIOUS PERSONAL INJURY OR DEATH TO YOU AND/OR OTHERS DURING AN EMERGENCY SITUATION.

Ground Fault Detection Sensitivity Adjustment

The resistance at which a ground fault will be detectable is adjustable. The Series DV-200 ground fault detection sensitivity can be adjusted between 40K and 500K Ohms. Selecting a high sensitivity (high resistance) will have a fast response to ground fault conditions, but may also cause a high number of false trouble conditions. Selecting a low sensitivity (low resistance) will greatly reduce the susceptibility to false trouble conditions, but will slow the response to ground fault conditions.

Before the following adjustment procedure is performed, all trouble conditions must be corrected (cleared) and the "GROUND FAULT ENABLE ("EN")/DISABLE ("DIS") jumper placed in the enable position.

NOTE: The ground fault detection sensitivity setpoint must be approved by the authorities having jurisdiction.

Adjustment Procedure

1. Disconnect the wire between the earth ground terminal on the printed circuit board (see Figure 8) and earth ground.
2. Rotate the shaft of the Ground Fault Detection Sensitivity potentiometer (R123) fully counter clockwise (See Figure 8). The potentiometer is a twelve turn device, so the shaft will probably have to be rotated a number of times. The potentiometer will make a clicking sound as it is rotated past its end point.
3. Place a resistor with the desired setpoint value between the positive side of the input voltage and the earth ground terminal on the printed circuit board.
4. Slowly rotate the shaft of the Ground Fault Detection Sensitivity potentiometer clockwise. When a ground fault is indicated by the trouble LED's, the sensitivity setpoint is set correctly.
5. Disconnect the resistor used to set the sensitivity level.
6. Reconnect the wire between the earth ground terminal on the printed circuit board and earth ground.

Troubleshooting

 **WARNING:** SOME ELECTRONIC COMPONENTS STORE A HIGH VOLTAGE CHARGE, EVEN THOUGH POWER IS NOT CONNECTED, AND CAN CAUSE A DANGEROUS SHOCK IF TOUCHED. DO NOT TOUCH EXPOSED CIRCUITRY ON THE SERIES DV-200 UNLESS THE CIRCUITRY HAS DISCHARGED FOR ONE HOUR AND A SAFE DISCHARGE PROCEDURE IS USED.

 **WARNING:** PROVIDE ALTERNATIVE SIGNALING MEANS DURING TROUBLE CONDITIONS AND SERVICING TO ASSURE ADEQUATE PROTECTION OF PEOPLE AND PROPERTY. HAVE QUALIFIED SERVICE PERSONS IMMEDIATELY REPLACE ANY UNIT(S) THAT HAVE MALFUNCTIONED.

 **CAUTION:** Troubleshooting and servicing should be conducted only by qualified persons in accordance with the procedures in this manual. Do not attempt to make other adjustments, modifications, or repairs. Never use water, steam, cleaning liquids or sprays on the Series DV-200.

 **CAUTION:** User servicing of the Series DV-200 is limited to the following:

- Field wiring changes following the instructions in the "Installation" section.
- Reprogramming voice messages following the instructions in the "Message Recording" section.
- Procedures set forth in this section.

 **CAUTION:** Do not paint or in any way cover LED's.

AFTER ANY TROUBLESHOOTING PROCEDURE IS COMPLETED, PERFORM A COMPLETE SYSTEM CHECKOUT.

When a trouble condition is detected by the Series DV-200 the Form C status relay (normally energized) will change state, the green system normal LED will turn off and the amber system trouble LED will turn on. At the same time, the amber trouble indicator LED will indicate a Series DV-200 inoperative condition (steady on) or troubleshooting required condition (coded blinking).

Use Table 2 to determine the trouble condition and the correct troubleshooting procedure to follow.

System Normal LED (Green)	System Trouble LED (Amber)	Trouble Indicator LED (Amber)	What it Means	Troubleshooting Procedure
On	Off	Off	Normal	----
Off	Off	Off	Power Loss	A
Off	On	Off	Series DV-200 Inoperative	B
Off	On	Steady-On	Series DV-200 Inoperative	C
Off	On	1 Blink Pattern	Battery Trouble	I
Off	On	2 Blink Pattern	Message Memory PSRAM Error	D
Off	On	3 Blink Pattern	Input Error	E
Off	On	4 Blink Pattern	Output Channel Error	F
Off	On	5 Blink Pattern	Serial Port Communication error	G
Off	On	6 Blink Pattern	Ground Fault Detected	H
Off	On	7 Blink Pattern	Telephone Trouble Error	J

Table 2.

Replacement Procedure

Return any units that are malfunctioning, after all troubleshooting operations have been performed, for factory repair or replacement. If it is necessary to return a Series DV-200 or Series DV-EM, replace the malfunctioning unit(s) immediately in the following manner:

1. Make sure that alternative signaling means are in place and that the proper replacement units are available.
2. Disconnect power from the power source to the Series DV-200.
3. Identify all wiring connections to make sure they will be reconnected identically on the replacement.
4. Disconnect all wiring connections and any conduit or cable connections to the malfunctioning unit.
5. Remove the malfunctioning unit(s) and install the replacement unit(s) following the instructions in the "Installation" section of this manual. Perform all checkout procedures described in that section to make sure the replacement unit(s) are operating properly.

Procedure A

If the green system normal LED, the amber system trouble LED, and the amber trouble indicator LED are off, the Series DV-200 may be completely inoperative due to power loss. This condition is caused by:

1. Input voltage is not within proper range or polarity is incorrect.
2. Blown fuse (F2) on Series DV-200.
3. One or more LED's are broken.

Perform the following:

1. Verify that input voltage is within proper range and that polarity is correct.
2. Check fuse (F2) on Series DV-200.

If, after the above procedure is completed, the trouble condition persists, the trouble condition is caused by broken LED's on the Series DV-200. The LED's on the Series DV-200 are not field replaceable. Series DV-200's with broken LED's shall be replaced immediately, following the Replacement Procedure, set forth previously in this section.

Procedure B

If the green system normal LED is off, the amber system trouble LED is on, and the amber trouble indicator LED is off, the Series DV-200 may be completely inoperative. This condition is caused by:

1. Too low input voltage on the Series DV-200.
2. Missing or improperly inserted program memory EPROM.
3. Broken amber trouble indicator LED (Series DV-200 is operative if this is the cause).
4. Failed circuitry on the Series DV-200.

Perform the following:

1. Verify that the input voltage exceeds the minimum operating voltage.
2. Verify that the program memory EPROM is present and inserted into S46 properly.
3. Attempt to play a message file. If the file plays then the amber trouble indicator LED is broken.

If, after the above procedure is completed, the trouble condition persists, the trouble condition is caused by failed circuitry on the Series DV-200. There are no field correctable failed circuitry problems on the Series DV-200. Series DV-200's with failed circuitry shall be replaced immediately, following the Replacement Procedure, set forth previously in this section.

Procedure C

If the green system normal LED is off, the amber system trouble LED is on, and the amber trouble indicator LED is steady on, the Series DV-200 is partially or completely inoperative. The Series DV-200 can be rendered inoperative by:

1. Too low input voltage on the Series DV-200.
2. Failed audio channel on the Series DV-200.
3. Other failed circuitry on the Series DV-200.

If the error was either due to the first or third cause, the Series DV-200 will not play messages. If the error was due to the third cause, the serial port might be functioning properly, depending on what circuitry failed. If the error was due to the second cause, the Series DV-200 might play messages and the serial port will function properly.

When the Series DV-200 is rendered inoperative, perform the following:

1. Verify that the input voltage exceeds the minimum operating voltage.
2. Attempt to play messages on all installed audio channels.

If, after the above procedure is completed, the trouble condition persists, the trouble condition is caused by failed circuitry on the Series DV-200. There are no field correctable failed circuitry problems on the Series DV-200. Series DV-200's with failed circuitry shall be replaced immediately, following the Replacement Procedure, set forth previously in this section.

Procedure D

If the green system normal LED is off, the amber system trouble LED is on, and the amber trouble indicator LED flashes a 2-blink pattern, a message memory PSRAM error has occurred. A message memory PSRAM error may be caused by:

1. No messages programmed into message memory PSRAM's.
2. Missing or improperly installed message memory PSRAM's
3. One or more of the messages were not programmed completely.
4. Failed circuitry on the Series DV-200.

If the error was due to one of the first three causes, the trouble will clear automatically when the cause is corrected. The first three causes should only occur when power is first turned on to the Series DV-200.

When a message memory error is indicated, perform the following:

1. Verify that there is at least one message programmed into the message memory PSRAM's.
2. Verify that all message memory PSRAM's are inserted into their sockets properly.
3. Verify that new blank PSRAM's were installed into the Series DV-200 in the correct order. Example: A PSRAM must be installed in S64 before a PSRAM can be installed in S65; PSRAM's must be installed in S64 and S65 before a PSRAM can be installed in S66, etc. Note that a PSRAM must always be installed in S63.
4. Verify that there are no partially programmed messages on the message memory PSRAM's. This must be done using commands on the serial port.

If, after the above procedure is completed, the trouble condition persists, the trouble condition is caused by failed circuitry on the Series DV-200. There are no field correctable failed circuitry problems on the Series DV-200. Series DV-200's with failed circuitry shall be replaced immediately, following the Replacement Procedure, set forth previously in this section.

Procedure E

If the green system normal LED is off, the amber system trouble LED is on, and the amber trouble indicator LED flashes 3-blink pattern, an input error has occurred. An input error may be caused by:

1. Open field wiring.
2. No end-of-line resistor on an input line.
3. Inputs on Series DV-200 are also being used when Series DV-EM's are being used.
4. Previously installed Series DV-EM is no longer detected by Series DV-200.
5. Failed circuitry on Series DV-200 or Series DV-EM.

If the error was due to one of the first four causes, the trouble will clear automatically when the cause is corrected.

When an input error is indicated, perform the following:

1. Check all input wiring for open circuits.
2. Verify that all supervised input wiring has a 10K end-of-line resistor across last input device.
3. Verify that all unsupervised inputs or unused inputs have 10K resistors mounted at terminal blocks. (If Series DV-EM's are used, the eight unused Series DV-200 inputs shall not have 10K resistors installed. Note that DV-EM's have these 10K resistors mounted on the printed circuit board.)
4. If Series DV-EM's are installed, remove any field wiring from eight Series DV-200 inputs.
5. A previously installed Series DV-EM is no longer detected. Note that once a Series DV-EM has been installed, the Series DV-200 will always check for it and give a trouble condition if it doesn't detect it.

If, after the above procedure is completed, the trouble condition persists, the trouble condition is caused by failed circuitry on the Series DV-200. There are no field correctable failed circuitry problems on the Series DV-200. Series DV-200's with failed circuitry shall be replaced immediately, following the Replacement Procedure, set forth previously in this section.

Procedure F

If the green system normal LED is off, the amber system trouble LED is on, and the amber trouble indicator LED flashes a 4-blink pattern, an audio channel error has occurred. An audio channel error may be caused by:

1. Too low audio level while playing a message.
2. Pause in message while playing a message.
3. The audio output is loaded down by a low impedance input device.
4. Additional output channel IC(s) not installed in sequence.
5. Missing or improperly replaced audio channel.
6. Failed audio channel on Series DV-200.

If the error occurs while playing a file, the error was due to one of the first three possible causes. If the error occurs immediately after turning on power to the Series DV-200, the error was due to one of the last three possible causes.

If the error was due to too low of an audio level or a pause while playing a message, the trouble will clear automatically when audio is again detected while a message is playing. If the error was due to the audio output being loaded down, the trouble will clear automatically when the output is no longer loaded down while a message is playing. If the error was due to a missing or improperly replaced output channel IC, the trouble will clear automatically when the IC is correctly in place and input power is cycled off and on.

When an audio channel error is indicated, perform the following:

1. Turn up volume on Series DV-200.
2. Re-record message, shortening duration of the pause.
3. Check impedance of line output wiring and impedance of input device.
4. Verify that output channel IC's were installed in proper sequence. Example: IC's must be installed in S21 and S4 before IC's can be installed in S22 and S6; IC's must be installed in S21, S4, S22, and S6 before ICs can be installed in S23 and S9.
5. Check for properly inserted output channel IC's (in sockets S21, S4, S22, S6, S23, and S9). Note that once an IC has been inserted into sockets S21, S22, and S23 the Series DV-200 will always check for it and give a trouble condition if it doesn't see it.

If, after the above procedure is completed, the trouble condition persists, the trouble condition is caused by failed circuitry on the Series DV-200. There are no field correctable failed circuitry problems on the Series DV-200. Series DV-200's with failed circuitry shall be replaced immediately, following the Replacement Procedure, set forth previously in this section.

Procedure G

If the green system normal LED is off, the amber system trouble LED is on, and the amber trouble indicator LED flashes a 5-blink pattern, a serial port communication error has occurred. A serial port communication error may be part caused by:

1. Invalid command received.
2. Incorrect baud rate.
3. Incorrect data format.
4. Parity error.
5. Framing error.

If the error was due to an invalid command received, the trouble will clear automatically on the next valid command received. If the error was due to an incorrect baud rate or data format, the trouble will clear automatically after first valid data byte is received with correct baud rate and data format. If the error was due to a parity or framing error, the trouble will clear automatically after the next valid data byte is received.

When a serial communication error is indicated, perform the following:

1. Verify that the Series DV-200 is connected to a system which supports the Wheelock serial port protocol and provides the correct data format.
2. Transmit a valid command to the Series DV-200 through the serial port.

If, after the above procedure is completed, the trouble condition persists, the trouble condition is caused by failed circuitry on the Series DV-200. There are no field correctable failed circuitry problems on the Series DV-200. Series DV-200's with failed circuitry shall be replaced immediately, following the Replacement Procedure, set forth previously in this section.

Procedure H

If the green system normal LED is off, the amber system trouble LED is on, and the amber trouble indicator LED flashes a 6-blink pattern, a ground fault has been detected. A ground fault detected error may be caused by:

1. Contact input wiring shorted to earth ground.
2. DV-EM cable wiring shorted to earth ground.
3. RS-232 or RS-485 wiring shorted to earth ground.
4. Input power wiring shorted to earth ground.
5. Ground fault detection sensitivity is set too high.
6. Failed ground fault detection circuitry on Series DV-200.

If the error was due to one of the first five causes, the trouble will clear automatically when the cause is corrected.

When a ground fault detected error is indicated, perform the following:

1. Check all contact input wiring for ground faults.
2. Check all DV-EM cabling for ground faults.
3. Check all RS-232 and RS-485 wiring for ground faults.
4. Check all input power wiring for ground faults.
5. Decrease the ground fault detection sensitivity level, following the adjustment procedure set forth in the Ground Fault Detection Sensitivity Adjustment section of this manual.

If, after the above procedure is completed, the trouble condition persists, the trouble condition is caused by failed circuitry on the Series DV-200. There are no field correctable failed circuitry problems on the Series DV-200. Series DV-200's with failed circuitry shall be replaced immediately, following the Replacement Procedure, set forth previously in this section.

Procedure I

If the green system normal LED is off, the amber system trouble LED is on, and the amber trouble indicator LED flashes a 1-blink pattern, a battery trouble has been detected. A battery trouble error may be caused by:

1. Disconnected memory retention battery.
2. Failed memory retention battery.
3. Failed battery charging or supervision circuitry on the Series DV-200.

If the error was due to one of the first two causes, the trouble will clear the first time the battery is checked after the cause is corrected. Note that the battery is checked by the circuitry once every five minutes.

When a battery trouble error is indicated, perform the following:

1. Check connection of memory retention battery.
2. Replace memory retention battery.

If after the above procedure is completed, the trouble condition persists, the trouble condition is caused by failed circuitry on the Series DV-200. There are no field correctable failed circuitry problems on the Series DV-200. Series DV-200's with failed circuitry shall be replaced immediately, following the Replacement Procedure, set forth previously in this section.

Procedure J

If the green system normal LED is off, the amber system trouble LED is on, and the amber trouble indicator LED flashes a 7-blink pattern, a telephone trouble has been detected. A telephone trouble error may be caused by:

1. Blown Fuse (F1).
2. Incorrect call progress tones on telephone line.
3. Insufficient off hook voltage on telephone line.
4. Disconnect telephone line.
5. Missing or improperly installed Telephone Interface Kit integrated circuits.
6. A telephone message has gone unacknowledged for three consecutive times to one telephone number.
7. Failed circuitry on the digital voice module.

When a telephone trouble error is indicated, perform the following:

1. Check fuse (F1) on digital voice module.
2. Verify that the telephone line is connected properly.
3. Verify that the two Telephone Interface Kit integrated circuits have been installed properly.
4. Verify that all activated telephone messages have been acknowledged and are no longer playing.
5. Verify that there is voltage across the telephone line when a telephone message is selected to play.
6. Verify that the telephone provides a standard dial tone when off hook and a standard ring when dialing.

If after the above procedure is completed, the trouble condition persists, reset the digital voice announcer. Activate one telephone message and verify that it executes correctly. If the telephone message fails to play correctly and there are no problems with the telephone line, the telephone trouble condition is caused by failed circuitry on the digital voice module.

There are no field correctable failed circuitry problems on the digital voice module. Digital voice modules with failed circuitry shall be replaced immediately, following the Replacement Procedure, set forth previously in this section.

Periodic Testing

PERIODIC SYSTEM TESTING, INCLUDING THE SERIES DV-200, ALL NOTIFICATION EQUIPMENT AND ALL MESSAGES, INCLUDING THEIR CONTENT AND LANGUAGE, SEQUENCE, OUTPUT CHANNEL, AND PRIORITY ASSIGNMENT, MUST BE CONDUCTED FREQUENTLY, AT LEAST TWICE EACH YEAR, OR MORE OFTEN AS REQUIRED BY LOCAL, STATE AND FEDERAL CODES, REGULATIONS AND LAWS, BY QUALIFIED PERSONNEL TO ENSURE PROPER OPERATION OF ALL EQUIPMENT. If the notification equipment is not working properly, immediately contact the installer and have all/any problems corrected immediately. Malfunctioning units should be replaced immediately. Do not attempt to repair malfunctioning units. Malfunctioning units should be returned for factory repair or replacement. In the event you cannot contact the installer, contact the manufacturer.

To aid qualified personnel in performing necessary operational testing procedures, a script, listing all messages programmed in the digital voice module, must be kept with the digital voice module.

 **WARNING:** **PROVIDE ALTERNATIVE SIGNALING MEANS DURING PERIODIC TESTING TO ASSURE ADEQUATE PROTECTION OF PEOPLE AND PROPERTY. FAILURE TO PROVIDE ALTERNATIVE SIGNALING MAY CAUSE PEOPLE TO NOT BE WARNED OF AN EMERGENCY CONDITION, WHICH COULD RESULT IN PROPERTY DAMAGE AND SERIOUS INJURY OR DEATH TO YOU AND/OR OTHERS.**

In addition to testing required by relevant fire codes, regulations and laws, several hardware functions should also be tested. The hardware functions that should be tested are as follows:

1. The "short circuit" detection circuitry for any one or all of the eight contact inputs.
2. The serial port receiver.
3. The play contact for each of the four output channels.
4. The "open circuit" detection circuitry for any one or all of the eight contact inputs.
5. The audio supervision circuitry for each of the four audio channels.
6. The status contact.

These hardware functions may be tested as follows:

1. Activate (short circuit) each contact input and verify that proper message plays.
2. Transmit a serial port command to the digital voice module and check for a valid acknowledge response.
3. Monitor the play contact for each channel to verify proper operation while alternately playing and not playing files on the output channel.
4. Disconnect (open) each contact input and verify that the proper trouble condition is indicated.
5. Listen to each message and check for audibility of each message.
6. Monitor the status contact while causing the digital voice module to alternate between trouble and normal states to verify proper operation.

If the digital voice module fails to perform any of the above tests correctly, immediately replace it following the replacement procedure given in the troubleshooting section.

Technical Specifications

Mechanical

Dimensions (H x W x D)	18" by 18" x 2-1/2"
Weight	16 pounds
Enclosure	0.050" Steel
Finish	Black
Mounting	Indoor Surface Mount Top and Bottom Wiring Entry

Environmental

(Meets UL requirements)	
Operating Temperature	0° to +49° C
Storage Temperature	-20° to 70° C
Humidity	85±5% @ 30±2° C Non-condensing

Playback

Memory Type	PSRAM
Memory Time	2 to 16 Minutes
Bandwidth	70 Hz to 4000 Hz
Maximum Files	999
Signal to Noise Ratio	51 dB
THD 1 KHz (full scale)	5.5 %

Power Limited Wiring

All Series DV-200 circuits are power limited. Therefore, to maintain power limited ratings, circuits connected to power supply, auxiliary music input, and relay contact terminals must be power limited.

Electrical

Input Voltage

Operating: 11 - 29 VDC

Ripple: 500 mV

Maximum Input Current

		Input Voltage		
		11VDC	24VDC	29VDC
Trickle Charge Mode	No Messages Playing	333mA	233mA	225mA
	Messages Playing In One Channel	368mA	248mA	239mA
	Messages Playing In Two Channels	403mA	263mA	253mA
	Messages Playing In Three Channels	440mA	279mA	267mA
	Messages Playing In Four Channels	478mA	295mA	282mA
Fast Charge Mode	No Messages Playing	390mA	290mA	282mA
	Messages Playing In One Channel	425mA	305mA	296mA
	Messages Playing In Two Channels	460mA	320mA	310mA
	Messages Playing In Three Channels	497mA	336mA	324mA
	Messages Playing In Four Channels	535mA	352mA	339mA

Inrush Current

Voltage	11VDC	24VDC	29VDC
Current	12A	27A	35A

The inrush current draw settles to a steady-state current draw in 6 to 8 milliseconds.

Fuse

F1 (Telephone) 500 mA
(5 x 20 mm "Slo-Blo" Type Littlefuse Cat. No. 239.500)

F2 (Power Input) 500 mA
(same as power input fuse)

Inputs

Programming

Microphone Input:
Impedance 2.0K Ohms
Sensitivity 7.5m V_{RMS}

Auxiliary Input:
Impedance 50K Ohms
Sensitivity 190m V_{RMS}

Message File Activation

File Input Terminals	Input terminals for 8 message files on each DV-200. Activate files for 300 millisecond minimum with a short across input (to sink up to 10 mA current with maximum 2 VDC drop)
Expansion Terminal	DV-EM module has input terminals for 32 message files (same activation as above).
Digital Command	Through serial port, RS-232.
Music Input	Provided for each output channel. Requires 0.5 to 2.0 Vrms music source. Switched out when file is played.

Outputs

Audio Output	1 to 4 output channels optionally provided; each through 600W isolation transformer. Output level adjustable from 0.5 to 2.0 Vrms. Minimum Load Impedance 600W.
Status Contact	Form C contacts normally energized. Contacts transfer during trouble. Rated 0.5 Amps at 30 VDC max, resistive load.

 **WARNING:** DO NOT EXCEED THE RATINGS OF THE STATUS CONTACT. EXCEEDING THE RATINGS MAY CAUSE THE RELAY TO FAIL. IF THE RELAY FAILS, THE SERIES DV-200 MAY NOT BE ABLE TO INDICATE A TROUBLE CONDITION.

Channel Playing Contact	One for each channel. Normally open contacts closed when channel is playing. Rated 0.5 Amps at 30VDC max, resistive load.
-------------------------	---

 **WARNING:** DO NOT EXCEED THE RATINGS OF THE CHANNEL PLAYING CONTACTS. EXCEEDING THE RATINGS MAY CAUSE THE RELAY TO FAIL. IF THE RELAY FAILS, THE SERIES DV-200 MAY NOT BE ABLE TO PROVIDE THE INTENDED WARNING.

Wiring Connections

Screw Terminals	Each terminal accepts one conductor from #22 to #16 AWG.
Series DV-EM Port	25 pin D connector (DB25S) on bottom right.
RS-232 Port	25 pin D connector (DB25S) on bottom left.

End-of-Line Resistor

Resistance	10K
Tolerance	5% Maximum
Power Dissipation	1/8W Minimum

Glossary

A

acknowledge. A serial port command or a dry contact input which will cause a message file of priority level 4 or 5 that is continuously activated to stop repeating after having played at least once.

activation. An input that causes a file to be selected and processed.

C

channel. An audio output path through which the Series DV-200 transmits message files to the audio system. Each Series DV-200 can have up to four channels.

D

DV-100. Voicelink playback series described in separate manual. A DV-200 model is needed to program DV-100 models.

DV-200. Voicelink record/playback series described in this manual.

DV-EM. Digital Voice Expansion Module, 32 file input selections per module.

E

EPROM. Erasable Programmable Read Only Memory. Non-volatile semiconductor memory used to store DV-200 program.

F

file. DV-200 files are created either by storing audio directly into a selected file number or by storing the numbers of other files that contain audio into the selected file number. Every file is assigned an output channel and a priority level. Up to 999 files can be created in the DV-200 model. A file becomes a message file if it is selected to be played by a contact closure or by a command through the serial port. Some files are never intended to become message files; they merely contain words or phrases that can be strung together to create new files that will become message files. The new files will be assigned channel and priority designations that supersede previous channel and priority designations for the individual files in the new string.

M

message. An audio output generated and played through an assigned channel when a file number is selected by a contact closure or command on the serial port.

P

priority. The order by which files are designated to be played. All files are assigned a priority from 1 to 5, with 1 as the highest priority.

PSRAM. Pseudo Static Random Access Memory. Volatile semiconductor memory used to store DV-200 messages.

Q

queue. A sequence of message files that have been selected to be played through a particular channel. Each file is positioned according to its pre-assigned priority. Equal priority files are positioned in the order they were selected. A file cannot be included in this queue more than once. However, after a file has completed playing, it can be re-added to the queue.

R

reset. A serial port command or a dry contact input which will cause the file presently playing to stop immediately and remove all files from the queue.

S

string. A combination of file numbers (with optional delay or repeat commands) stored in a file and arranged to form a desired message.

Limited Warranty

Wheelock products must be used within their published specifications and must be PROPERLY specified, applied, installed, operated, maintained and operationally tested in accordance with these instructions at the time of installation and at least twice a year or more often and in accordance with local, state and federal codes, regulations and laws. Specification, application, installation, operation, maintenance and testing must be performed by qualified personnel for proper operation in accordance with all of the latest National Fire Protection Association (NFPA), Underwriters' Laboratories (UL), Underwriters' Laboratories of Canada (ULC), National Electrical Code (NEC), Occupational Safety and Health Administration (OSHA), local, state, county, province, district, federal and other applicable building and fire standards, guidelines, regulations, laws and codes including, but not limited to, all appendices and amendments and the requirements of the local authority having jurisdiction (AHJ). Wheelock products when properly specified, applied, installed, operated, maintained and operationally tested as provided above are warranted against mechanical and electrical defects for a period of three years from date of manufacture (as determined by date code). Correction of defects by repair or replacement shall be at Wheelock's sole discretion and shall constitute fulfillment of all obligations under this warranty. THE FOREGOING LIMITED WARRANTY SHALL IMMEDIATELY TERMINATE IN THE EVENT ANY PART NOT FURNISHED BY WHEELOCK IS INSTALLED IN THE PRODUCT. THE FOREGOING LIMITED WARRANTY SPECIFICALLY EXCLUDES ANY SOFTWARE REQUIRED FOR THE OPERATION OF OR INCLUDED IN A PRODUCT. WHEELOCK MAKES NO REPRESENTATION OR WARRANTY OF ANY OTHER KIND, EXPRESS, IMPLIED OR STATUTORY WHETHER AS TO MERCHANTABILITY, FITNESS FOR A PARTICULAR PURPOSE OR ANY OTHER MATTER.

USERS ARE SOLELY RESPONSIBLE FOR DETERMINING WHETHER A PRODUCT IS SUITABLE FOR THE USER'S PURPOSES, OR WHETHER IT WILL ACHIEVE THE USER'S INTENDED RESULTS. THERE IS NO WARRANTY AGAINST DAMAGE RESULTING FROM MISAPPLICATION, IMPROPER SPECIFICATION, ABUSE, ACCIDENT OR OTHER OPERATING CONDITIONS BEYOND WHEELOCK'S CONTROL.

SOME WHEELOCK PRODUCTS CONTAIN SOFTWARE. WITH RESPECT TO THOSE PRODUCTS, WHEELOCK DOES NOT WARRANTY THAT THE OPERATION OF THE SOFTWARE WILL BE UNINTERRUPTED OR ERROR-FREE OR THAT THE SOFTWARE WILL MEET ANY OTHER STANDARD OF PERFORMANCE, OR THAT THE FUNCTIONS OR PERFORMANCE OF THE SOFTWARE WILL MEET THE USER'S REQUIREMENTS. WHEELOCK SHALL NOT BE LIABLE FOR ANY DELAYS, BREAKDOWNS, INTERRUPTIONS, LOSS, DESTRUCTION, ALTERATION, OR OTHER PROBLEMS IN THE USE OF A PRODUCT ARISING OUT OF OR CAUSED BY THE SOFTWARE.

THE LIABILITY OF WHEELOCK ARISING OUT OF THE SUPPLYING OF A PRODUCT, OR ITS USE, WHETHER ON WARRANTIES, NEGLIGENCE, OR OTHERWISE, SHALL NOT IN ANY CASE EXCEED THE COST OF CORRECTING DEFECTS AS STATED IN THE LIMITED WARRANTY AND UPON EXPIRATION OF THE WARRANTY PERIOD ALL SUCH LIABILITY SHALL TERMINATE. WHEELOCK IS NOT LIABLE FOR LABOR COSTS INCURRED IN REMOVAL, REINSTALLATION OR REPAIR OF THE PRODUCT BY ANYONE OTHER THAN WHEELOCK OR FOR DAMAGE OF ANY TYPE WHATSOEVER, INCLUDING BUT NOT LIMITED TO, LOSS OF PROFIT OR INCIDENTAL OR CONSEQUENTIAL DAMAGES. THE FOREGOING SHALL CONSTITUTE THE SOLE REMEDY OF THE PURCHASER AND THE EXCLUSIVE LIABILITY OF WHEELOCK.

IN NO CASE WILL WHEELOCK'S LIABILITY EXCEED THE PURCHASE PRICE PAID FOR A PRODUCT.

Limitation of Liability

WHEELOCK'S LIABILITY ON ANY CLAIM OF ANY KIND, INCLUDING NEGLIGENCE AND BREACH OF WARRANTY, FOR ANY LOSS OR DAMAGE RESULTING FROM, ARISING OUT OF, OR CONNECTED WITH THIS CONTRACT, OR FROM THE MANUFACTURE, SALE, DELIVERY, RESALE, REPAIR OR USE OF ANY PRODUCT COVERED BY THIS ORDER SHALL BE LIMITED TO THE PRICE APPLICABLE TO THE PRODUCT OR PART THEREOF WHICH GIVES RISE TO THE CLAIM. WHEELOCK'S LIABILITY ON ANY CLAIM OF ANY KIND SHALL CEASE IMMEDIATELY UPON THE INSTALLATION IN THE PRODUCT OF ANY PART NOT FURNISHED BY WHEELOCK. IN NO EVENT SHALL WHEELOCK BE LIABLE FOR ANY CLAIM OF ANY KIND UNLESS IT IS PROVEN THAT OUR PRODUCT WAS A DIRECT CAUSE OF SUCH CLAIM. FURTHER, IN NO EVENT, INCLUDING IN THE CASE OF A CLAIM OF NEGLIGENCE, SHALL WHEELOCK BE LIABLE FOR INCIDENTAL OR CONSEQUENTIAL DAMAGES. SOME STATES DO NOT ALLOW THE EXCLUSION OR LIMITATION OF INCIDENTAL OR CONSEQUENTIAL DAMAGES, SO THE PRECEDING LIMITATION MAY NOT APPLY TO ALL PURCHASERS.