

Series SM and DSM Sync Modules



Series SM or DSM

Description

The Wheelock Series SM and DSM Sync Modules are utilized with the Series AS/AH, Series NS/NS4/NH, Series RSS, Series RSSP, Series SLM and selected strobe applications with other Wheelock combination appliances.

When used with Series AS Audible Strobes and/or Series NS Horn Strobes, the SM and DSM Sync Modules provide independent operation of synchronized temporal pattern (code 3) horn and synchronized strobe flash, as well as the ability to silence the horn while maintaining the strobe flash, while using only a single pair of wires. The sync modules are available in two versions; the SM-12/24 for control of a Class B NAC circuit; and a dual output version, the DSM-12/24 for control of either a Class A or two (2) Class B NAC circuits.

Features

- Approvals include: UL Standard 1971, ULC, New York City (MEA), California State Fire Marshal (CSFM) and Chicago (BFP)
- Uniquely designed to accept an independent strobe and audible input from the FACP and convert to a single output that connects to Wheelock's Series AS or Series NS family of audible strobes
- Series SM and DSM Sync Modules can also be used to synchronize Wheelock's Series RSS, RSSP and SLM Sync Strobes
- 3 ampere per circuit current handling at 12 or 24 VDC
- Low operating current draw
- Compatible with all standard fire alarm control panels
- Meets the NFPA-72 requirement for Temporal Pattern when used with the Series AS/AH and/or Series NS/NS4/NH
- 3 year warranty

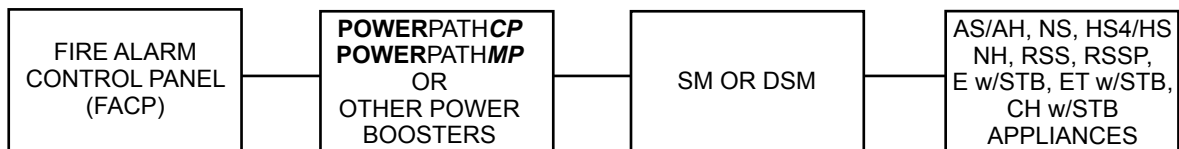

SM or DSM Connection Diagram with Power Booster

Table 1: Sync Module (SM) Current Requirements (AMPS)								Table 2: Sync Module (DSM) Current Requirements (AMPS)							
UL Voltage	ULC Voltage	Rated Average Current		Rated Peak Current		Rated Inrush Current		UL Voltage	ULC Voltage	Rated Average Current		Rated Peak Current		Rated Inrush Current	
		In1	Audible	In1	Audible	In1	Audible			In1/In2	Audible	In1/In2	Audible	In1/In2	Audible
8.0 VDC	10.5 VDC	0.017	0.004	0.055	0.004	0.140	0.016	8.0 VDC	10.5 VDC	0.019	0.004	0.055	0.004	0.150	0.016
12.0 VDC	12.0 VDC	0.017	0.004	0.060	0.004	0.160	0.019	12.0 VDC	12.0 VDC	0.020	0.004	0.064	0.004	0.170	0.019
24.0 VDC	24.0 VDC	0.028	0.008	0.070	0.008	0.320	0.030	24.0 VDC	24.0 VDC	0.035	0.008	0.080	0.008	0.342	0.030
33.0 VDC	33.0 VDC	0.038	0.010	0.080	0.010	0.440	0.040	33.0 VDC	33.0 VDC	0.045	0.010	0.090	0.010	0.470	0.040
8.0 VRMS	8.0 VRMS	0.026	0.006	0.085	0.008	0.210	0.016	8.0 VRMS	8.0 VRMS	0.028	0.005	0.107	0.008	0.210	0.016
12.0 VRMS	12.0 VRMS	0.028	0.006	0.090	0.009	0.225	0.019	12.0 VRMS	12.0 VRMS	0.030	0.006	0.103	0.009	0.240	0.019
24.0 VRMS	24.0 VRMS	0.040	0.010	0.120	0.015	0.446	0.033	24.0 VRMS	24.0 VRMS	0.048	0.010	0.145	0.015	0.480	0.033
33.0 VRMS	31.0 VRMS	0.055	0.012	0.150	0.022	0.645	0.056	33.0 VRMS	31.0 VRMS	0.062	0.012	0.175	0.022	0.685	0.056

NOTE: All CAUTIONS and WARNINGS are identified by the symbol **▲**. All warnings are printed in bold capital letters.

▲ WARNING: PLEASE READ THESE SPECIFICATIONS AND INSTALLATION INSTRUCTIONS CAREFULLY BEFORE USING, SPECIFYING OR APPLYING THIS PRODUCT. FAILURE TO COMPLY WITH ANY OF THESE INSTRUCTIONS, CAUTIONS AND WARNINGS COULD RESULT IN IMPROPER APPLICATION, INSTALLATION AND/OR OPERATION OF THESE PRODUCTS IN AN EMERGENCY SITUATION, WHICH COULD RESULT IN PROPERTY DAMAGE, AND SERIOUS INJURY OR DEATH TO YOU AND/OR OTHERS.

▲ WARNING: MAKE SURE THAT THE TOTAL CURRENT REQUIRED BY ALL APPLIANCES THAT ARE CONNECTED TO A SM OR DSM DOES NOT EXCEED 3.0A OR EXCEED THE RATING OF THE FIRE ALARM CONTROL PANEL'S PRIMARY AND SECONDARY POWER SOURCES AND NAC CIRCUITS. OVERLOADING THESE SOURCES COULD RESULT IN LOSS OF POWER AND FAILURE TO ALERT OCCUPANTS DURING AN EMERGENCY, WHICH COULD RESULT IN PROPERTY DAMAGE AND SERIOUS INJURY OR DEATH TO YOU AND/OR OTHERS.

When calculating the total current, use Tables 1 & 2 to determine the highest value of "Rated Average Current" for the SM or DSM (across the listed voltage range), then add this value to the total current for any other appliances powered by the same source and include any required safety factors. Refer to Instruction Sheet for additional information.

▲ WARNING: MAKE SURE THAT ALL FUSES USED ON NAC CIRCUITS ARE RATED TO HANDLE THE MAXIMUM INRUSH OR PEAK CURRENT FROM ALL APPLIANCES ON THOSE CIRCUITS. FAILURE TO DO THIS MAY RESULT IN LOSS OF POWER TO THE NAC CIRCUIT AND THE FAILURE OF ALL APPLIANCES ON THAT CIRCUIT TO OPERATE, WHICH COULD RESULT IN PROPERTY DAMAGE AND SERIOUS INJURY OR DEATH TO YOU AND/OR OTHERS.

Table 3: Current Consumption of the SM and DSM Modules				
Output Circuit Description of SM/DSM Module		SM Module	DSM Module	Ref. Fig.
Class "B" with Audible Silence	(single circuit)	Y		1
Class "B" with No Audible Silence	(single circuit)	Y		2
Class "B" with Audible Silence	(dual circuit)		Y	3
Class "B" with No Audible Silence	(dual circuit)		Y	4
Class "A" with Audible Silence	(single circuit)		Y	5
Class "A" with No Audible Silence	(single circuit)		Y	6

Note: SM Sync Modules are rated for 3.0 amperes at 12/24 VDC; DSM Dual Sync Modules are rated for 3.0 amperes per circuit. **The maximum number of interconnected DSM modules is twenty (20).**

▲ CAUTION: Use SM or DSM Sync Modules only on NAC circuits with continuously applied voltage. Do not use SM or DSM Sync Modules on coded or interrupted NAC circuits in which the applied voltage is cycled on and off.

▲ CAUTION: Power Boosters may be used in conjunction with the SM or DSM Sync Modules only in the order shown below. Only one SM or DSM Sync Module shall be allowed on a NAC circuit. Do not connect Power Booster to the NAC circuit after the one SM or DSM Sync Module. **Exception:** The Wheelock PS-24-8MC Power Booster can be connected either before or after the SM or DSM Sync Module. Refer to Power Booster instruction manual for proper application and installation.

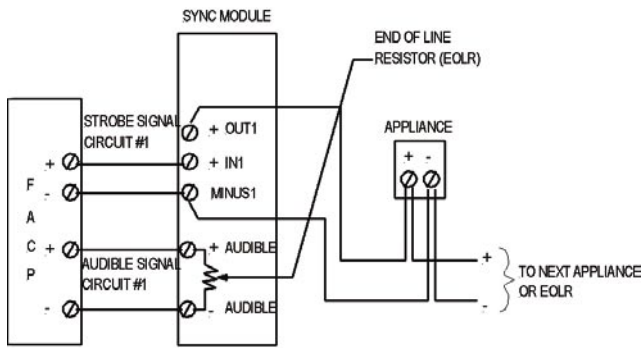

FIG. 1 SINGLE CLASS "B" CIRCUIT WITH AUDIBLE SILENCE FEATURE

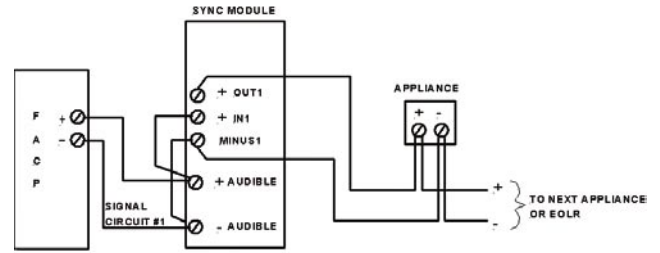

FIG. 2 SINGLE CLASS "B" CIRCUIT WITH NO AUDIBLE SILENCE FEATURE

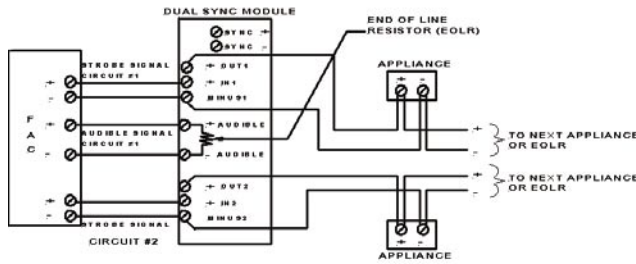

FIG. 3 DUAL CLASS "B" CIRCUIT WITH AUDIBLE SILENCE FEATURE

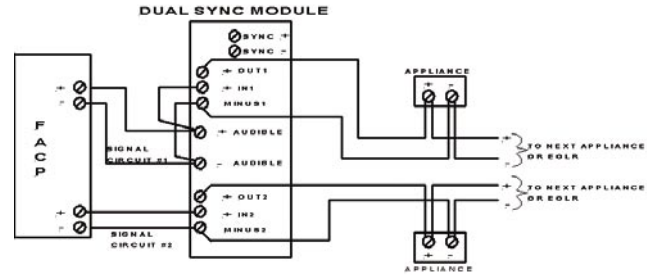

FIG. 4 DUAL CLASS "B" CIRCUIT WITH NO AUDIBLE SILENCE FEATURE

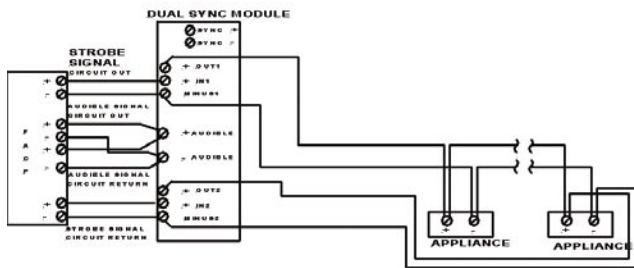

FIG. 5 SINGLE CLASS "A" CIRCUIT WITH AUDIBLE SILENCE FEATURE

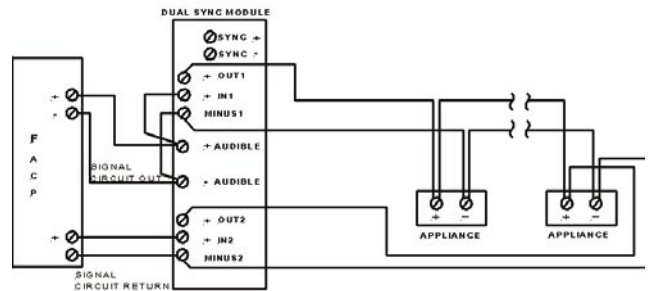

FIG. 6 SINGLE CLASS "A" CIRCUIT WITHOUT AUDIBLE SILENCE FEATURE

Notes

1. Non-Sync Appliances can be installed before or after a SM or DSM. If the Non-Sync appliance requires audible silence, four wire connection is necessary with the strobe circuit connected before the SM or DSM NAC circuit, and the audible leads connected to a silenceable NAC circuit from the FACP.
2. The audible appliance produces a momentary interruption (approximately 25ms) each time the strobes flash.
3. Circuit #2 may be omitted if only 1 circuit is required when using the DSM.
4. Non-Sync Audible Appliances can be installed on the audible NAC. Be aware of the current requirement for the SM or DSM module. See table 3.

Specifications and Ordering Information

Model	Order Code	Input Voltage VDC	Average Current @ 12 or 24 VDC	UL Max*	Mounting Options**
SM-12/24-R	6369	12	0.017	0.023	W
		24	0.028	0.038	W
DSM-12/24-R***	6374	12	0.020	0.026	W
		24	0.035	0.055	W

R = Red

* RMS current ratings are per UL average RMS method. UL max current rating is the maximum RMS current within the listed voltage range (16-33v for 24v units). For strobes the UL max current is usually at the minimum listed voltage (16v for 24v units). For audibles the max current is usually at the maximum listed voltage (33v for 24v units). For unfiltered FWR ratings, see installation instructions.

** Refer to Data sheet # S7000 for Mounting Options.

*** The maximum number of interconnected DSM modules is twenty (20).

The total distance from the first to the last DSM shall not exceed 1,000 feet of #18 AWG wire. Use only #18 AWG wire.

⚠ WARNING: THESE APPLIANCES WERE TESTED TO THE OPERATING VOLTAGE LIMITS OF 8-33 VOLTS USING FILTERED DC OR UNFILTERED FULL-WAVE RECTIFIED (FWR). DO NOT APPLY 80% AND 110% OF THESE VOLTAGE VALUES FOR SYSTEM OPERATION. THE APPLICATION OF IMPROPER VOLTAGE MAY RESULT IN DEGRADED OPERATION OR DAMAGE TO THESE PRODUCTS, WHICH COULD RESULT IN PROPERTY DAMAGE AND SERIOUS INJURY OR DEATH TO YOU AND/OR OTHERS.

Wheelock products must be used within their published specifications and must be PROPERLY specified, applied, installed, operated, maintained and operationally tested in accordance with their installation instructions at the time of installation and at least twice a year or more often and in accordance with local, state and federal codes, regulations and laws. Specification, application, installation, operation, maintenance and testing must be performed by qualified personnel for proper operation in accordance with all of the latest National Fire Protection Association (NFPA), Underwriters' Laboratories (UL), National Electrical Code (NEC), Occupational Safety and Health Administration (OSHA), local, state, county, province, district, federal and other applicable building and fire standards, guidelines, regulations, laws and codes including, but not limited to, all appendices and amendments and the requirements of the local authority having jurisdiction (AHJ).

⚠ WARNING: CONTACT WHEELOCK FOR "INSTALLATION INSTRUCTIONS" (P83123-SM & P83177-DSM) AND "GENERAL INFORMATION" SHEET ON THESE PRODUCTS. These documents do undergo periodic changes. It is important that you have current information on these products. These materials contain important information that should be read prior to specifying or installing these products including:

- **TOTAL CURRENT REQUIRED BY ALL APPLIANCES CONNECTED TO SYSTEM SECONDARY POWER SOURCES.**
- **FUSE RATINGS ON NAC CIRCUITS TO HANDLE MAXIMUM INRUSH OR PEAK CURRENTS FROM ALL APPLIANCES ON THOSE NAC CIRCUITS.**
- **COMPOSITE FLASH RATE FROM MULTIPLE STROBES WITHIN A PERSON'S FIELD OF VIEW.**
- **THE VOLTAGE APPLIED TO THESE PRODUCTS MUST BE WITHIN THEIR RATED IN PUT VOLTAGE RANGE.**
- **INSTALLATION IN OFFICE AREAS AND OTHER SPECIFICATION AND INSTALLATION ISSUES.**
- **USE STROBES ONLY ON NAC CIRCUITS WITH CONTINUOUSLY APPLIED OPERATING VOLTAGE. DO NOT USE STROBE ON CODED OR INTERRUPTED NAC CIRCUITS IN WHICH THE APPLIED VOLTAGE IS CYCLED ON AND OFF AS THE STROBE MAY NOT FLASH.**

Architects and Engineers Specifications

The sync modules shall be Wheelock Series SM or DSM Sync Modules. Series SM or DSM Sync Modules shall be the master controllers for Wheelock Series AS/AH, NS/NS4/NH, RSS, RSSP and appliances where a synchronized audible/visual audible or visual only appliance is specified. All modules shall be UL listed under Standard 464. Series SM and DSM modules shall be designed to interface with Series AS Audible Strobe Appliances and NS Horn Strobe Appliances to produce a synchronized temporal (Code 3) horn as well as synchronized strobe flash on a two-wire alarm circuit. Other synchronized products are the Wheelock Series RSS, RSSP, SLM visual only appliances and Series AH and NH Horn Appliances.

SM Sync Module shall incorporate two input NAC circuits for power connection from the Fire Alarm Control Panel; one for the strobe NAC circuit and one for the audible NAC circuit. DSM modules shall provide an additional strobe circuit input/output for control of either two Class "B" NAC circuits or a single Class "A" NAC circuit. Upon activation of the audible silence function at the Fire Alarm Control Panel, the audible signal component of Series AS Audible Strobe and/or the Series NS Horn Strobe may be silenced while maintaining strobe activation.

Series SM or DSM module shall be designed and available in two versions; the SM-12/24 for control of a single Class B NAC circuit and a dual output version, the DSM-12/24 for control of either Class A two (2) Class B NAC circuits. The DSM dual circuit version shall provide the additional capability of "daisy-chaining", that is, the ability to interconnect multiple DSM's for synchronous horn and strobe operation on multiple NAC circuits. Interconnection capability shall be for a maximum of 40 NAC circuits. All modules shall operate on either 12 or 24 VDC. Rated average current requirement for the SM 12/24 shall be .017 amperes @ 12 VDC and .028 amperes @ 24 VDC. The DSM 12/24 shall be .020 amperes @ 12 VDC and .035 amperes @ 24 VDC. A single circuit SM Sync Module shall be capable of handling a 3 ampere load at 12 or 24 VDC and the dual circuit DSM Sync Module shall be capable of handling a load of 3 amperes per NAC circuit at 12 or 24 VDC.

All versions shall be polarized for DC supervision and shall incorporate screw terminals for in/out field wiring of #18 to #12 AWG wire size. The SM and DSM Sync modules shall mount to a 4-11/16" x 2-1/8" deep backbox.

NOTE: Due to continuous development of our products, specifications and offerings are subject to change without notice in accordance with Wheelock Inc. standard terms and conditions.

 **COOPER** Wheelock

273 Branchport Avenue
Long Branch, NJ 07740
Phone: (800) 631-2148
Fax: (732) 222-2588
www.cooperwheelock.com



WE ENCOURAGE AND SUPPORT NICET CERTIFICATION
3 YEAR WARRANTY
Made in USA

S3000 SM/DSM 06/06