

Building a Traditional Workbench



By Keith S. Rucker

 e-mail: krucker@friendlycity.net

This work can be found on the Internet at: <http://pages.friendlycity.net/~krucker/Bench/index.htm>

Copyright © 2000 by Keith S. Rucker, All rights reserved.

This work may be freely reproduced for personal and or educational purposes as long as it is reproduced in its entirety and nothing, including this copyright, is omitted. However, this work may not be published (in any media) without the written consent of the author.

Table of Contents

Table of Contents	2
Introduction	3
The Design	4
<i>The Top Design</i>	5
<i>Bill of Materials - Top</i>	6
The Base Design.....	7
The Lumber	8
Milling the Lumber.....	9
The Top Slab.....	11
The Dog-Hole Back.....	12
<i>Mathematical Calculations:</i>	14
Making the Dog-Hole Strip.....	16
<i>Making the Dog-Holes</i>	17
<i>Cutting the Notch</i>	19
<i>Cutting the Dovetail Pin</i>	19
<i>Gluing the Dog-Hole Strip to the Top</i>	20
<i>The Dog Hole Slot Cover</i>	21
The End Caps	22
<i>The Left End-Cap</i>	22
<i>The Right End Cap</i>	23
<i>Mounting the End Caps</i>	24
The Tool Till	25
<i>The Tool Till Apron</i>	25
<i>Tool Till Bottom</i>	26
<i>The Ramps</i>	27
The Bottom Spacers	28
The Front Vise.....	29
<i>Front Vise Spacer Block</i>	29
<i>The Front Vise Face Block</i>	30
<i>Boring the holes in the Face Block</i>	30
<i>Boring the holes in the bench</i>	31
<i>Preparing the Bench Face</i>	32
<i>Installing the Vise Hardware</i>	33
The End Vise.....	35
<i>The Face Piece</i>	35
<i>The Front Jaw</i>	36
<i>The Rear Jaw</i>	38
<i>The Back Runner</i>	38
<i>Assembling the End Vise</i>	38
<i>Fitting it up</i>	39
<i>The Dog-Hole Cover</i>	41
<i>The Guide Block</i>	42
<i>The Bench Runner</i>	44
<i>The Front Guide Block</i>	44
<i>Mounting the Top Caps</i>	47
The Base	51
Flattening the Top	55
Finishing the Top.....	56
Details	57

Introduction

If you are going to use hand tools in your woodworking, perhaps the most important tool to have is not the tools themselves but a good bench to do your work on. When I first started to set up my shop, I had only been out of school for a little over a year, been married a little less than a year and had just bought a new home. To help spell my situation out, we were poor. Even though the finances were not the best in the world, I began to accumulate a few basic tools and began making some of the much needed furniture in my new home. My first workbench was pretty simple. When we first moved into our new home, the previous owners had left behind a crudely made puppet stage, which was actually just several 2x4's screwed together and painted white. Having no need for a puppet stage in my new "shop" (the two car garage on the front of my house), I disassembled the puppet stage and reassembled the lumber into the frame of a bench. Nothing fancy here mind you, I just made a basic frame and put it all together with screws. The top was made from some scrap 2x6's that were in the burn pile of a new house that was being built down the street from mine (I did ask the contractor before taking them). The 2x6's were again screwed down top and presto, I had a bench. A couple of scrap pieces of plywood made a shelf underneath to stack junk on. A couple of years later, a front vise was bought and added to the bench.

It was not a pretty bench and it was not really a great bench, but it was the only bench I had. As my woodworking improved and I started using more and more hand tools, I started to realize that my thrown together bench was not good enough. Planing was particularly a pain. First, there was no good way to hold a board while planing. I screwed a couple of stops on the end of the bench for boards to hold against while planing but there was nothing on the other side to hold it tight. And, when I was planing, the whole bench racked back and forth resulting in much wasted energy. The more work I did on this bench the more I realized I needed a new one.

Shortly before my daughter was born (July 1997), I ordered a copy of "The Workbench Book" by Scott Landis. The book arrived just a few days before my daughter did so as I was spending a lot of time in the hospital waiting to go home with my new little bundle of joy, I spent many an hour reading my new book (Hannah, my newborn daughter, spent most of this time sleeping anyway so I had to do something to keep my busy). I must have read that entire book cover to cover at least twice before going home.

I spent the next three years thinking about my bench and saving what I could so that I could build one right. After three years of planning, I finally came up with a bench I think I will like. During that time, I had the opportunity to actually do work on several different types of benches to see what I liked and didn't like. The result of all of my pondering on the subject was to build a pretty traditional bench. The following collection of pages is a continuing saga of the step by step process I went through to get it done. As I go along, I will discuss what I have learned along the way so that if you ever decide to build a bench, hopefully you can learn from my mistakes.

The Design

After many years of using a totally inadequate bench for hand tools, I finally decided that the time had come to build a "real" bench. After not telling how many hours of thinking and sketching, I finally decided on a pretty traditional design. My bench, will basically be pretty close in design to the Frank Klausz bench that has been well documented in both "The Workbench Book" by Scott Landis as well as in Fine Woodworking issue 53 (July/August 1985).

The main difference between my bench and Frank's is the front vise. Everything I have ever read that Frank has written about his bench as well as what he told me while personally talking with him about it at a weekend workshop, Frank is adamant that the front vise should be of the "Dog-Leg" style. While it may work great for Frank, I just do not like that kind of vise. I have had the opportunity to work on one for a while and it just did not suite my work habits. Perhaps that greatest thing I do not like about the Dog-Leg vise is that it sticks out of the front of the bench, always getting in the way. It is also weaker by design. I decided instead to go with a plain front vise, where the front of the bench actually serves as the back of the vise. The only other differences in my bench and Frank's is the dimensions. The only reason I changed them was to better fit my shop. While I would love to have a bench that is 7' or 8' long, 6' was the maximum length that would work in my space. I also made my bench a little wider than Frank's, about three inches wider - not sure if this is good or bad, only time will tell.

The Top Design

Here is the plan for the Bench Top. Also below is a copy of the bill of materials for the workbench top. Again, this bill of materials is a bit rough right now but final dimensions should not change much.

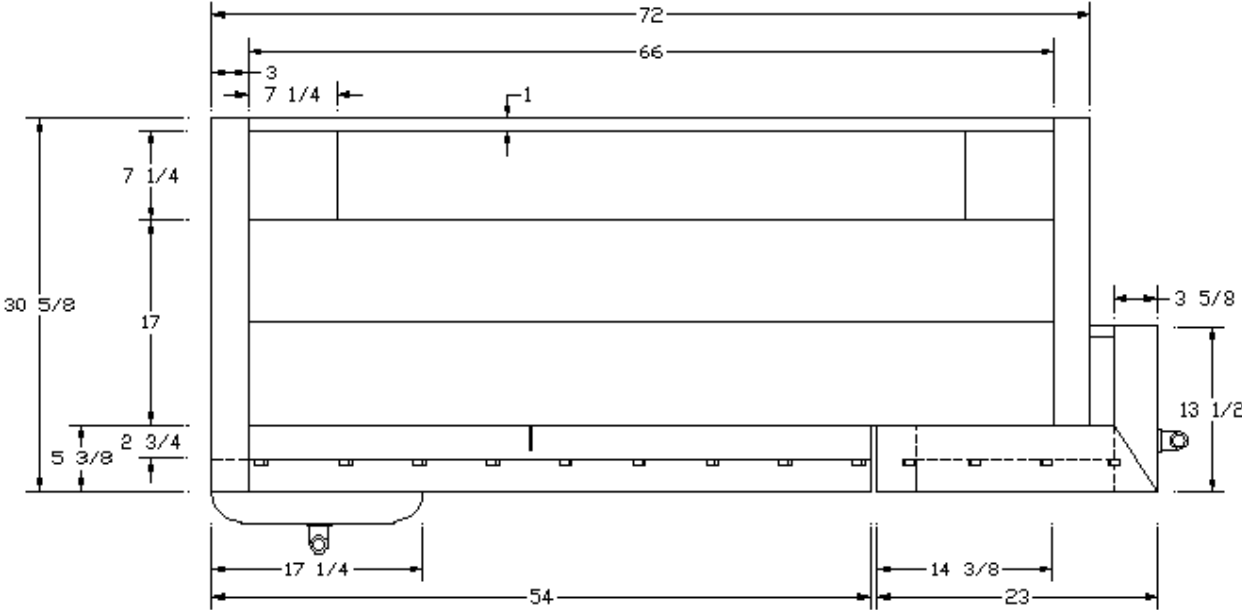

Bill of Materials - Top

Top

Part	Name	Qty	Thickness	Width	Length
A	Dog-Hole Strip	1	2 5/8	4	51
B	Dog-Hole Back	1	2 1/2	2 3/4	51
C	Top Slab	3	2 1/2	5 3/4	66
D	Dog-Hole Slot Cover	1	1	1 1/2	51
E	Apron	1	1	4	69
F	Left Endcap	1	3	4	30 5/8
G	Right Endcap	1	3	4	28
H	Tray Bottom	1	1/2	8 1/2	66
I	Ramps	2	1/2	7 1/4	8
J	Left Spacer	1	1 1/2	2 3/4	25 1/8
K	Right Spacer	1	1 1/4	2 3/4	26 1/2
L	Front Guide Block	1	3	3	22 1/4
M	Guide Block	1	2 1/4	3 1/4	18
O	Front Vise	1	2 5/8	5	17 1/4
P	Vise Spacer Block	1	1 1/2	2 1/2	17 1/4

Tail Vise

R	Rear Jaw	1	3 3/8	4	13 1/2
S	Front Jaw	1	3 3/8	4	13 1/2
T	Back Runner	1	1 1/2	1 1/2	23
U	Face Piece	1	2 5/8	4	23
V	Runner	1	1	1	19
W	Bench Runner	1	1 1/2	1 1/2	25
X	Front Top Cap	1	1	5 3/8	23
Y	End Top Cap	1	1	3 3/8	13 1/2

The Base Design

Here is the basic plan for the bench base as well as the Bill of Materials. I built my base out of Southern Yellow Pine simply due economics. It would be better to build the base out of hardwood. You can easily get by with lumber that has knots in it for the base as long it does not have any structural defects.

Drawing

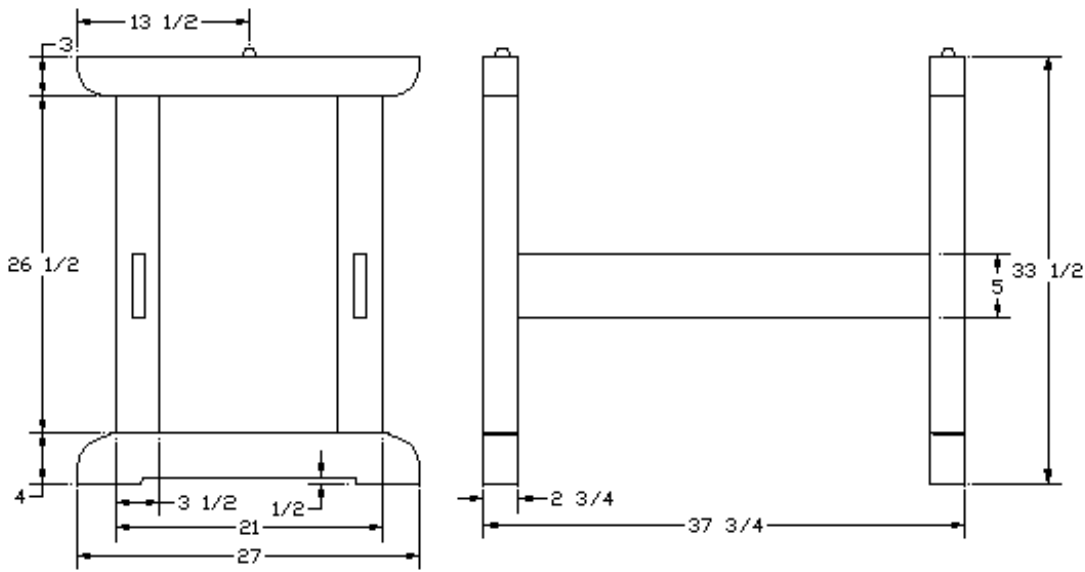

Base

Part	Name	Qty	Thickness	Width	Length
A	Foot	2	2 3/4	4	27
B	Top	2	2 3/4	3	27
C	Uprights	4	2 3/4	3 1/2	30
D	Front Tenons	2	1 1/2	5	34

The Lumber

The first step in making my bench was to obtain the lumber for it. This in itself was no easy matter. Workbenches are traditionally made from either beech or hard maple. While this is all good and well, neither of the two species grow in large enough quantities in my area (South Georgia) to be found at local sawmills or lumber yards. I tried just about every lumber source I knew of but hardly any of them carried hard maple in thickness greater than 8/4 and none carried beech. For most of my top, I needed thickness at least 16/4. I did find one supplier that had some 16/4 but it was so expensive I would need to take out a second mortgage on my house to pay for it.

I next considered alternative materials for my top. One lumber species that first came to mind was Longleaf Pine (Southern Yellow Pine). This is the prominent tree species native to my area and was probably what local craftsman would have made their benches out of. I tossed and turned on this topic but finally decided to go with hard maple. Southern Yellow Pine would have worked just fine but heck, most people only build one bench in a lifetime and I wanted to go all out. Due to the price, I also decided to get my hard maple somewhere besides the South East. It was suggested to me from the OldTools list to give Paul Taran a try at [MapleLeaf Hardwoods](#). I could not have made a better choice. Paul went out of his way to get just exactly what I needed. He even went so far as to ask for a copy of my Bill of Materials so he could better select boards for me since I could not do it myself. And the kicker was that even with the added expense of having the lumber trucked down from PA, it was still considerably cheaper than what I would have paid for it in Atlanta, not counting the 400 mile round trip to haul it from Atlanta myself. I placed my order and about a week later my bench lumber arrived. Now, I was in business!



The lumber before any milling

Milling the Lumber

The next step was to start milling my lumber to the proper dimensions. I begun my bench by making the top slab. The slab consisted of two boards, 2 1/2 inches thick, that when glued together would be 17" wide. Now, the main reason I am building this bench is to use hand tools on. I love old hand tools, both their beauty as well as the superior job they can do when properly used. As much as I love these old tools, I also believe that their is a place in the shop for power tools, particularly when doing the rough milling work in a project. So, if you are one of those who can't stand power tools (or hand tools for that matter), I will try to discuss alternative methods of getting the job done as I go.

The lumber I received was rough cut lumber. The boards were great but they did have some slight cupping and twist to them. The first step in any project is to get a squared up piece of stock, which first means getting one side of the lumber truly flat. The traditional way of accomplishing this task is to use a Scrub Plane (like the Stanley #40) to remove wood quickly and get a rough flat surface. To determine if the face is truly flat, one would use winding sticks, two long boards placed across the face that when eyed down from the end, any twisting is easily detected.

While the scrub plane would have worked just fine, I decided to go with the more modern approach. Rough milling is one place that I feel that power tools are a better option since you can get the same job done more quickly and with a lot less effort. And since the milling process usually does not leave the final surface on your lumber, you cannot really tell if the milling was done by hand or not.

Because of the widths I was working with, getting that flat face to start working with was a challenge. Usually the standard approach to taking cupping and twist out of a board before planning is to run a face across the jointer. While this is all good and well, my power jointer is only 6" wide but the boards I was working with were a little over 10" wide. I finally decided that the best option was to send the boards through my planner. To take care of the cupping and twist that would have come out the other side of the planner the same way they went in, I needed a flat side on the board to work with. Instead of actually milling one side of the board flat, I simply nailed a board that I knew was flat on one side of my stock and then using small wedges to firm up the rough board. In my case, I used a piece of 1x12 pine that I checked for flatness, but a better option would have been a piece of 3/4" plywood. The result was a flat reference side on my board. I used [Winding Sticks](#) to make sure the flat board stayed flat as I was driving the wedges to tighten up the cup and twist. Once I was sure the bottom board was flat, I ran it all through the planner until the top of the rough board cleaned up. I then checked the top of the board with winding sticks again, and sure enough, it was flat. The toughest part of the whole process was man-handling those huge timbers by myself.



The Winding Sticks on the flat top of my board after planing. Notice the "flat" board which is nailed onto the bottom with wedges to keep it from rocking.

Once I had the one flat side, I then used the jointer to get a square edge on the board. Next, I ripped the board to a little wider than it's final width on the table saw. I had a little trouble with the ripping part as my Craftsman table saw just did not have enough horsepower to handle the 3" thick hard maple. I had to feed the lumber extremely slow and even then, I was running back and forth to the electrical panel to reset tripped circuit breakers.

With the two square sides on my boards, I then ran the boards through the planer with the flat sides down to square up the other two sides and to get the board to it's proper dimensions.

The Top Slab

Once I had some squared up timbers for the top, I next got the two main pieces for the top slab ready to glue up. The top slab on my bench is 2 1/2" thick by 17" wide. Because I had 16/4 lumber (3" thick) that was about 10" wide, I decided to just edge glue two pieces together to form the slab. The ideal situation would be to have the slab made from quartersawn lumber to help keep down wood movement. However, since I was not able to find any quartersawn lumber in these dimensions, I just opted to go with the flatsawn faces. Another alternative would have been to rip several boards, turned them with the quarter sawn side up and glued it all together. Using this method, 8/4 lumber could have been used instead of 16/4, perhaps saving a little money as well.

To help align the boards together, I cut a 1/2" groove on the two mating surfaces and then used 1/2" thick plywood splines for alignment. To cut the groove, I had several options. The hand tool method would be to use a plow plane. I seriously considered using my Stanley 45 but it was already too hot in the shop and getting late (I was dead tired). Another option would be to make the slot on the table saw using a dado head. While this would have perhaps been the easiest method, I decided against it for one major reason - if there had been any bowing in the board, the resulting groove may not have been perfectly parallel to the top of the board. The main reason I was using a spline in the first place was to help align the boards together to the boards would be flush on the top with one another. So, I opted to use the router. By using a fence on the router, the groove was always the same distance from the top and if there was any bowing, the boards should have come out at least flush on the top.

Once the groove was made, I then made a spline out of 1/2 plywood. I cut a slight chamfer on both sides of the groove as well as on the spline with a block plane to help the spline fit into the groove. I spread a little glue on the spline and tapped it in. I then spread some glue on the mating boards and clamped it all together. You can never have too many clamps!



Top slab being glued up. Notice the plywood spline to help in alignment.

Once the glue had dried, I cut the top to length being extremely careful to make square cuts. I made my square cuts on the table saw using a cutoff sled.

The Dog-Hole Back

To close the back of the dog-hole strip, there is another piece of the top called the Dog-Hole Back. This piece also serves another function in that there is a slot milled into it to hold a hardwood stop. The hardwood stop is simply a 1/4" thick by 2" wide strip of hardwood that can be extended up from the bench top to serve as a stop. It comes in handy for several jobs on the bench including planing or anytime you need a stop to hold a board in place without clamping it.

The Dog-Hole back is a piece of maple 2 1/2" thick (same as the top slab) and 2 3/4" wide. It mates up to the slab but does not go all of the way to the end of the end vise. It is necessary to leave a notch on the end for the end-vise to fit into.

The most difficult part of milling the Dog-Hole Back is cutting the slot for the Hardwood Stop. I considered several ways to make this slot but the best way I came up with was on the table saw. The slot is 1/4" wide so you would at first think of using the dado head on the table saw to cut it. My dado head, however, is only a 6" dado head and would not stick up through the table saw far enough to cut to the necessary 2" depth. So, I just decided to use a regular table saw blade, moving the stock over a little at a time until the slot was 1/4" thick.

The other trick to the Hardwood Stop is that like the dog-holes, it is at a 88° angle. To accommodate this angle, I needed to cut the board at a angle across the table saw blade. I could have used my miter gage to do this however, I did not feel that the miter gauge would give me enough support for such a large timber.

Some time back, I made a cross-cut sled for my table saw. If you have not ever made one, now is the time - it is one of the most handy accessories in my shop. Now the crosscut sled cuts at a perfect 90° angle. To make the 88° angle, I simple shimmed one side of the back fence and clamped the board in at the proper angle.

After making the cut, here is the resulting slot:



Once the slot was cut, the Dog-Hole Back was cut to its proper length and prepared to glue to the top slab. As with the two pieces on the top slab, I milled a 1/2" groove and installed a 1/2" plywood spline to help in alignment. Here is a picture of the grooves before glue up:



Mathematical Calculations:

To determine the size of the shim, I used some Trigonometry (and you always told your math teacher that you would NEVER need that stuff in the real world). Here is what I knew: I knew that the angle I needed on one side was 2° (90-88). I also knew the length from one end of my sled to the other end. What I needed to know was how far to shim the other end. Now, if you think about it, what we have is a right triangle where we know the angles of the corners (2°, and 90 degrees) and the length of the bottom leg.

To solve for the side, we use the following equation:

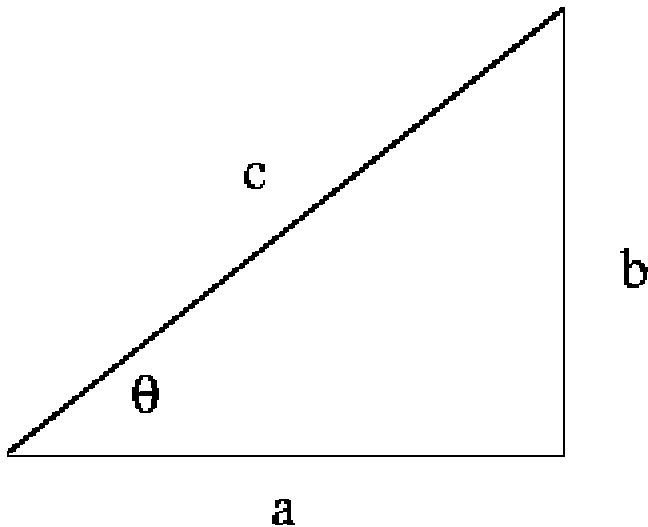

For the angle θ pictured in the figure, we see that

$$\tan \theta = \frac{b}{a} = \frac{\text{opposite}}{\text{adjacent}}$$

In our example, we have the following:

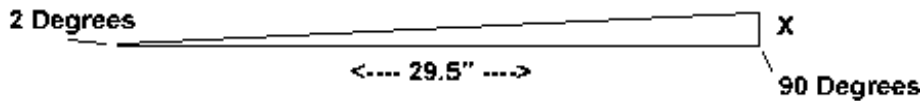

So:

$$\tan 2 = X/29.5$$

or to simplify:

$$(\tan 2) \cdot 29.5$$

Which equals 1.03". I just rounded it to 1" to shim the end. Here is a picture of the board set up to cut the angle:

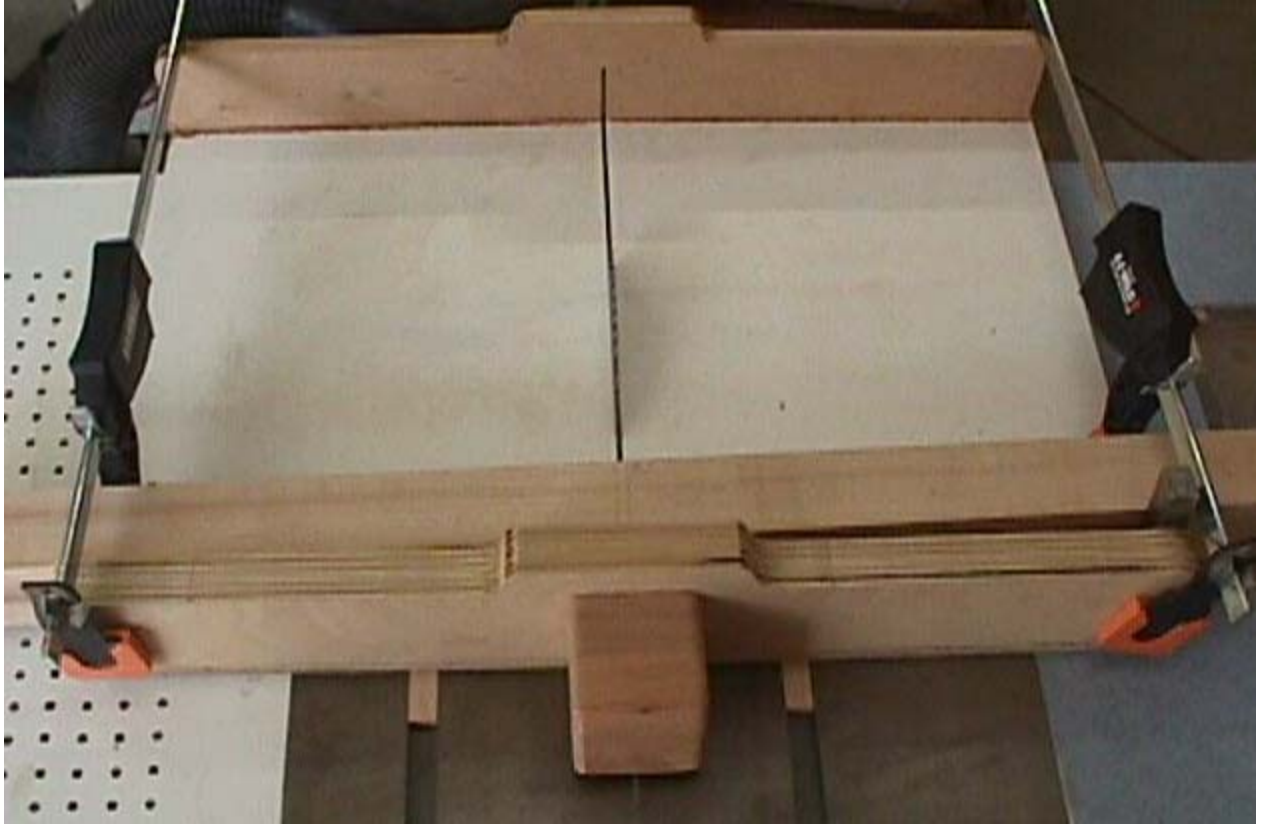

The board set up to cut the slot

Making the Dog-Hole Strip

One of the most important features of a good bench, in my opinion, is the dog-holes that allow you to clamp a piece of wood to the top of the bench. The dog-holes are square holes in the top of the bench that allow you to slip a square "Dog" into the hole. The Dog's can be lifted up so that they protrude from the top enough to clamp a board to the top. Two dogs are usually used, one that stays stationary and another in the end vise that when the end vice is tightened, clamping pressure is applied to between the dogs.

Some people use round dogs instead of square. The main reason that they do is because round holes are easy to make - just drill some holes in the top. I like square dogs for several reasons. First, a square dog will not rotate in its hole, twisting loose when you least need it to. And second, most round dog holes are drilled at a 90 degree angle to the top which can mean they can slip up under a load.

Square dogs, on the other hand cannot twist. Also, square dogs are cut at a slight angle (about 88° instead of 90°). The result of this slight angle is that when clamping pressure is applied to the dog, it actually presses the board down toward the bench.

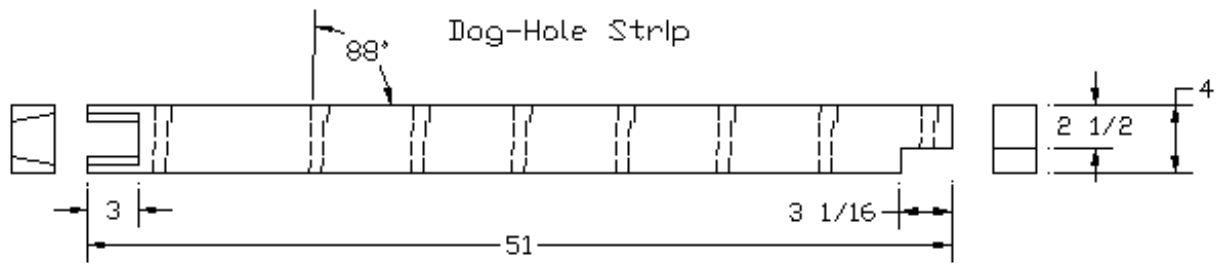

The secret to cutting square dog holes is to cut them into the side of a board (the dog-hole strip) and then face glue a second board to the side to close the square hole.

Making the Dog-Holes

There are three methods that I have come up with to cut the dog-holes into the dog-hole strip. First, you could use hand tools. To do it this way, you could use a back saw to cut the two sides of the slot and then use a chisel to remove the waste. Second, you could use a dado head on a radial arm saw. Of course the saw would have to be set to 88° rather than 90°. Alternatively, you could use a dado head in your table saw and slide the dog-hole strip over the top with the miter gage or some other holding jig set to the proper angle. And third, you could use a router to remove the waste. With the router, method, a simple jig could be used get the desired angle and shape.

One thing to remember when making a dog-hole slot is that the slot is not a simple groove. In order for the dog to be able to slide all the way down into the bench so that it will be out of the way or to have only a portion of the dog sticking up from the bench, you have to remove an extra area to the front of the dog-hole slot. Once the slot is cut, the extra area could easily be chopped out with a chisel.

After studying the several possible methods of cutting the dog-hole slot, I finally decided to use the router method. With the router, I could make a jig that would cut a uniform angle as well as remove the extra area in the front of the dog-hole all at the same time. To use the jig, you will need a guide bushing for your router which is nothing but a collar that the router bit fit through on the under side of the router. You then simply slide the guide bushing up against the side of the template and remove all of the waste in between. I made my template out of 3/4" plywood, cutting the piece in half at 88° and then removing the extra area for the dog-hole to slide into. A wooden fence was screwed to the bottom of the jig to hold the two pieces at the proper distance apart as well as to hold the jig squarely to the top of the dog hole strip.

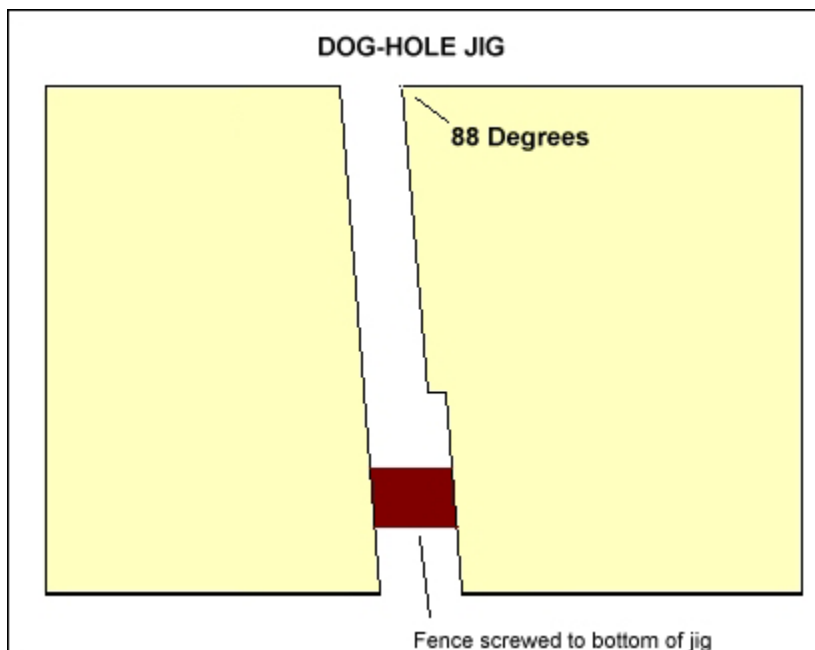

I set the depth of my router bit to the proper depth of the slot and then clamped the jig onto the dog-hole strip in the proper location. The router then made quick work of waste removal.



Jig clamped to strip ready to be routed.

One word of caution. Before cutting any dog-holes, be sure to think things through completely. One thing to remember is that around the front vise, you may have to alter the dog-hole spacing in order for the dog-holes to avoid the hardware in the vise. Lay everything out and think things through. You can't put that wood back in once it is gone.



The finished dog-holes.

Cutting the Notch

On the tail vise end of the dog-hole strip, it is necessary to cut a notch on the bottom to allow a board to fit into. There are several ways to cut the notch, one would be with hand tools where you could use a back saw to cut out the waste. I however, chose to use the table saw to help assure that I got a perfectly straight and square cut. I did this operation using my cross cut sled, raising the height of the blade to just shallow of the depth of the cut. I made the shoulder cut first, being extremely careful to make it right on the line. Once the first cut was made, I then just nibbled out the rest of the waste by moving the board over a little at a time until the waste was gone. To clean up the bottom of the cut (which was jagged), I first used a wide chisel and then used a shoulder plane to get a smooth bottom.

Cutting the Dovetail Pin

On the other end of the dog-hole strip (the front vise end), there is a large dovetail which helps hold the end-cap in place. As with making conventional dovetails, I chose to cut the pins first, which in this case is the part on the dog-hole strip. Now, when it comes to dovetails, I am pretty much a strong believer in doing them by hand - I own no dovetail jigs in my shop. Once I did the lay out on the dovetail pin however, I quickly noticed one big problem with doing this by hand - my dovetail saw, and even my only back saw, did not have a blade deep enough to make the huge dovetail pin. I could have spent some time to try to find a larger saw to buy but down here in South Georgia, I had about as much of a chance in finding a good user back saw as we do in seeing snow in the winter (maybe once ever decade or so!). So, I went the next best choice which was my band saw. This is the way that Frank Klausz cut his dovetails on his bench so I did not feel to bad in doing so.

I decided on a angle on my dovetail of about 10° just simply because that is what Frank did on his. I used my bevel square to mark the angle on the wood and then adjusted the table on my band saw to match the angel again using my bevel square. I again quickly noticed a small problem - my band saw table only tilted one way and in order to make the two angles of the dovetail, I would have to tilt it both ways. I scratched my head and decided to just make a tilt table out of wood that would do the trick. I could simply turn it around to make the opposite cut. The angel table, shown in the picture below, only took about 10 minuets to make out of come scrap plywood and a scrap 2x4. I put the widest blade I had on the band saw (1/2") and made the cuts. I then switched to 1/4" blade and cut the majority of the waste out instead of even trying to chisel it all (3" thick would have taken forever). To remove the waste in the corners of the dovetail, I used a coping saw. A chisel was then used to clean up the bottom, cutting it right to the line. My dog-hole strip was now complete and ready for gluing.

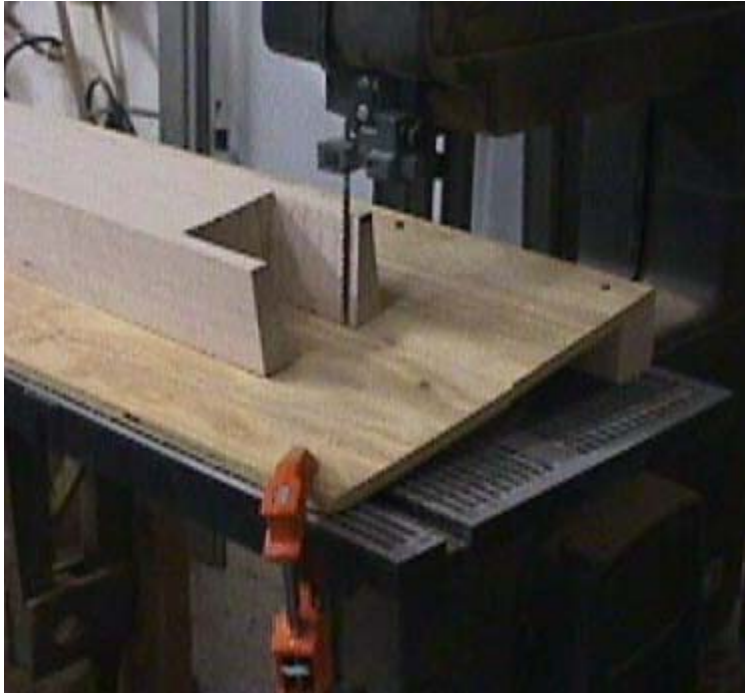

Cutting the dovetail pins on the band saw.

Gluing the Dog-Hole Strip to the Top

Once the dog-hole strip was completed, it was ready to glue to the top. The dog-hole back had previously been glued to the top. Since I could not use a plywood strip to help align the dog-hole strip (the slot and spline would have interfered with the dog-holes), I decided to use a few biscuits to help in alignment. I did not feel that the biscuits would give much if any extra strength to the glue joint, but they would come in handy in helping to align the tops flush with one another. After cutting the biscuits, I carefully lined up the ends to be sure they were flush and glued and clamped the dog-hole strip in place.



The Dog-Hole Strip glued into place.



The Dog-Hole Strip Dovetail.

The Dog Hole Slot Cover

Because the front Dog Hole Strip is thicker than the rest of the bench top, the dog hole slots are not covered on the back of the dog hole strip on the bottom of the bench. To fix this, a 1" x 1" strip is cut and glued to the back of the dog hole strip.



The Dog Hole Slot Cover being glued into place.

The End Caps

The next step on the bench top is to put the end-caps into place. There are two end-caps on the bench, one on the front-wise end and one on the end-wise end. Both are different in design and will be covered separately in discussion.

Some people consider end-caps to be a weak design point in the traditional woodworkers bench. Because the end-cap is running perpendicular in grain to the rest of the top, there is concern that as the top moves with changes in temperature and humidity, the end-caps could actually force a failure in the top. While this is a legitimate concern, this style of bench has been made for centuries and most hold up well as long as some care is taken in design as the bench is made. As long as you do not glue then entire length of the end-cap to the top, you are in essence allowing the top to move without trying to hold it down with glue. As with other parts of the top, plywood splines are used on the end-caps, but without glue so they can move with seasonal dimensional changes without causing a failure.

The Left End-Cap

The first step in making the end-caps is to mill the lumber to dimension and square. After rough milling, you are ready to make the special features of the end-caps.

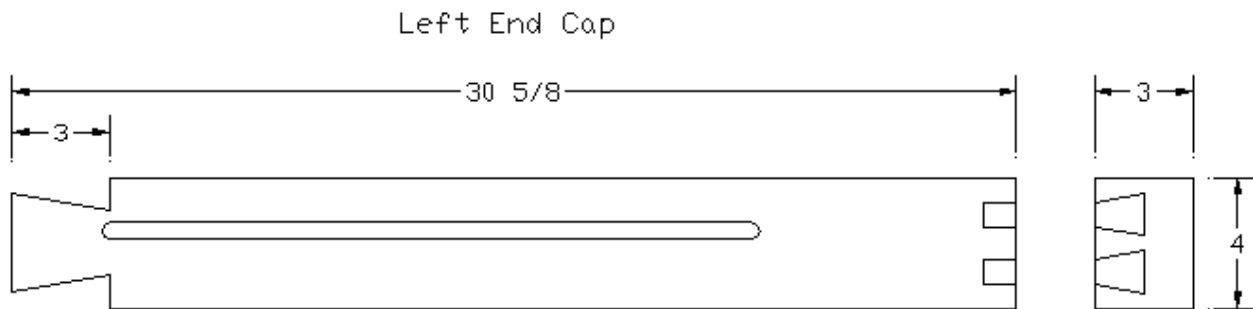

The main design feature of the left end-cap (the front vise end of the bench), is the large dovetail that will fit into the pins of the dog-hole strip. The tail was cut out on the band saw, being sure to leave the line marked from the pins. After the waste was removed, I then cleaned up the tail and cut it to fit using sharp chisels. After a couple of test fits and removing a little more waste, it fit satisfactory.

The next step was to cut the groove for the plywood spline as in the other parts of the top. Care was taken not to cut the slot where it would show in the tool till. A plywood spline was inserted into the groove and glue was spread ONLY on the dovetail end of the end-cap and it was clamped into place.

And Finally, the half blind dovetail pins were cut on the back of the end-cap to fit the tool till tray back. These pins were cut using traditional methods of first laying out the pins and then sawing as much waste as possible with a dovetail saw. The waste was then removed by chopping it out with a chisel.

The Right End Cap

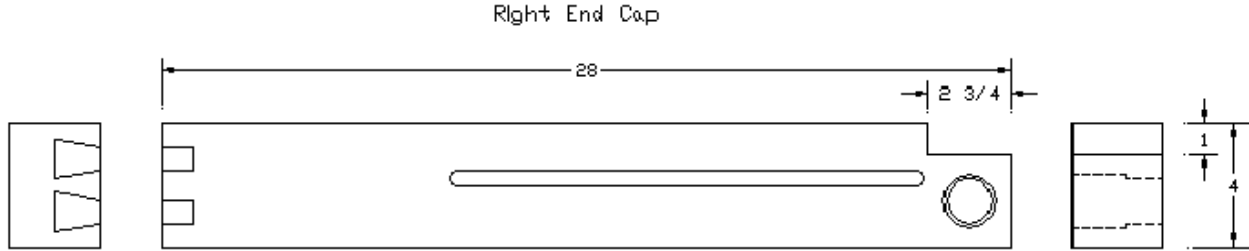

The right end cap is totally different from the one on the left. The main feature of the left end cap is the hole bored through the front end to receive the nut for the end vise. In order to bore the correct size hole, you must first obtain your vise screw and measure the diameter that will be necessary for your hardware. Once the correct size is determined, bore a hole just large enough that the nut will slip inside. On mine, I first bored the larger hole for the nut to the correct depth and then finished the hole by boring a smaller hole just slightly larger in diameter than the screw diameter. The result was a stepped hole.



The mounted right end cap.

It is also necessary to cut away a notch of the front of the end cap to allow the 1" thick tail vise cap to slide over.

As with the left end cap, dovetail pins were cut on the back side to accommodate the tool till back.



The half blind dovetail pins being cut on the end caps.

Mounting the End Caps

Since spreading glue over the entire face of the end cap would result in a weak joint against the end grain of the top, not to mention the chance of a joint failure as the top expands and contracts, a bolt was used to help hold the end cap in place. I used a drill to bore a 3/8" hole into the end caps, deep enough to go well into the top. In my case, I used 7" long bolts. Once the holes were drilled, I then used the router to cut a slot on the bottom of the bench that would allow me access to the end of the hole.



Notice the slot cut into the bottom of the bench to allow the nut to fit into. Also notice the screw nut for the tail vise.

A small amount of glue was applied to the front of the end caps to be sure that even as the top expanded and contracted that the front of the end cap would always remain flush with the front of the bench. I then inserted the bolt into the hole and put a washer and nut into the slot on the bottom. A couple of turns with a pair of wrenches, the end cap was clamped into place.

The Tool Till

The Tool Till on a bench is a very handy accessory. Many people choose to not put a tool till on their bench, opting for more bench top space instead. The way I see it, the tool till really does not give you any less real estate on your top at all. If you are working on a large piece, it will still rest on the till back board resulting in no lost space. The advantage of the tool till is that any tools on the bench can be kept in the till when moving a large piece on the bench top. As a result, the tools do not fall to the floor, possibly damaging them and they are still within arms reach when needed. Of course, the best reason to have a tool till is that it just would not be a traditional workbench if it did not have one.

The Tool Till Apron

The tool till is a relatively easy step in the building of the bench. Its main piece is the back apron, which is held in place by half blind dovetails cut into the back of the end caps. On my bench, I chose to dress things up a bit by using a piece of curly maple for the back apron. When I ordered the lumber for my bench, I also ordered some extra lumber for future use including some nice figured stock. Since I had it on my lumber rack, I decided this would be an appropriate use for it.

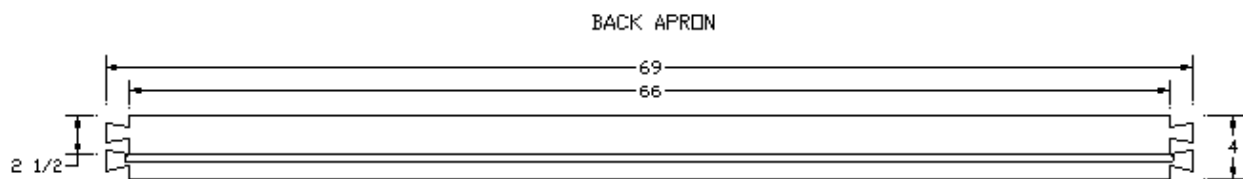

To make the back apron, first mill the lumber to the appropriate dimensions. Then, cut the tails for the dovetails. In my case, I almost always cut the pins first when making dovetails. In this case, the pins were cut into the end caps before mounting them to the bench. I temporarily clamped the back apron into where it would eventually fit and used a pencil to mark the tails. I then unclamped the back apron from the bench and cut the tails of the dovetail using traditional methods, cut the waste with my dovetail saw and then chop out the waste.

Then next step in making the back apron was to cut a dado for the tool till bottom to fit into. This could be accomplished with a plow plane, a power router or on the table saw with a dado head. Since the dovetail tails are going into half blind dovetail pins, you can cut the groove all the way through the ends - they will not show from the ends after glue-up. The tool till bottom is 1/2" thick so make your dado 1/2" thick and around 1/4" deep. Be sure to cut the dado where the installed bottom will be flush with the bottom of the bench.

Once the back apron is finished, spread some glue and clamp it into place.



The dovetails on the back apron and back of the end caps.

Tool Till Bottom

The next step is to make the tool till bottom. On Frank's bench, he used 1/2" plywood for his bottom. While I can see the advantage of using plywood for the bottom (it will not contract and expand like solid wood), I did not happen to have a sheet of nice 1/2" plywood in my shop (I did have some rough construction grade stuff but that would never work on my bench) and the only supplier was about three hours away. So, I decided to just glue up some maple boards to make the bottom instead. Once I had the proper width needed, I planed the board down until it would fit into the dado I had cut into the back apron. I then turned the bench upside down, spread a small amount of glue into the dado and clamped the bottom into place.

Once the glue had dried, I then prepared to screw the tool till bottom down to the bottom of the bench. Instead of just drilling the bottom right down, I instead first drilled pilot holes for all of my screws. I then took a drill and made the hole in the 1/2" thick tool till bottom into slots by moving the drill back and forth. By making slots, I at least in theory gave the tool till bottom the ability to slip a little as the bench top moved in width with the changing of seasons. I then screwed the tool till bottom into place.



The bottom of the bench after the tool till tray was installed.

The Ramps

The last step in completing the tool till is to put the ramps on each end. The purpose of the ramps is to help in brushing shavings out of the till. Without the ramps, it would be difficult to remove the waste, however, with the ramps, a brush can easily be used to clean the till by brushing up the ramps.

Frank made his ramps out of plywood. Again, I did not have any maple plywood to match the bench so I used solid wood. Actually, mine were made from some scrap strips that I had laying around the shop that I glued up to get a wide enough board. I then planed the boards to about 1/2" thick (thickness is not really an issue on this part) and cut them to widths that fit the inside of tool tray. I then determined the correct angle that needed to be cut on each end of the ramp and adjusted my table saw blade angle to that angle and then cut the two angles on the board. The final step was to glue the ramps into place.



Clamping the ramp into place as it is glued.

The Bottom Spacers

Now that the top is getting pretty well along, it is time to put the bottom spacers on the bottom of the bench top. The purpose of the bottom spacers is to give the bench top something to rest on the base. The bottom spacers are pretty simple to make, just a simple spacer that is screwed to the bottom of the bench. Before screwing the bottom spacers into place, be sure to have both the front and end vises laid out so you know where all of your hardware will go and the spacers will not be in the way. Cut the spacers length about 1/4" shorter than the width of the top bottom in which they will fit. This will allow for any wood movement in the top. A notch will have to be cut out on the back side where the spacer will fit over the tool till bottom.

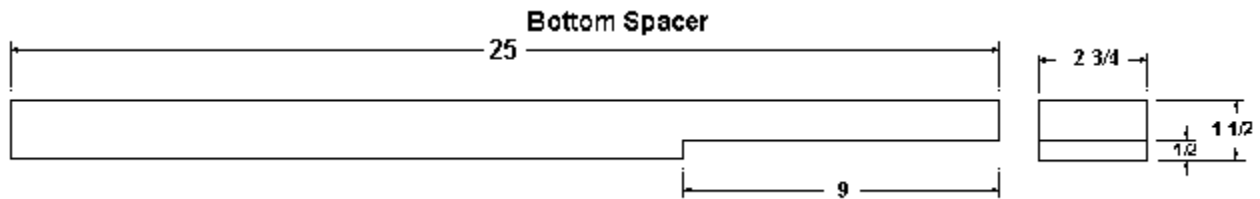

Once the spacers are made, attach them to the bottom of the bench top with two large screws. Do not use any glue since you would be gluing the spacers across the grain of the top. As the top moves, there would be a failure somewhere on the bench top resulting in split wood.



A bottom spacer mounted.

The Front Vice

Since I have uploaded this site, several people have e-mailed me wanting more information on where to purchase vise hardware.

Vise hardware is readily available from most major suppliers of woodworking supplies. If I remember correctly, I purchased my hardware from Woodworker Supply. They don't have a web site but do have one of the best catalogs in the industry. If you do not already receive this catalog, you need it. You can request a catalog by calling 1-800-645-9292. The main reason I purchased my hardware from there was the price. It is quality stuff but I did not like the fact that it was painted blue - if I had it to do over again, would have rather had a more traditional black even if it cost a few dollars more.

Other suppliers that I know have the hardware are:

Woodcraft: <http://www.woodcraft.com/>

You can do a search for "vise" and then look at their Front Vise Hardware for the Front Vise and their Bench Screws for the end vise.

Highland Hardware: <http://www.highland-hardware.com/>

This is by no means the only suppliers of vise hardware but should give you a good start.

Front Vise Spacer Block

Because of the height of the vise carriage, it is necessary to put a spacer on the front of the bench to allow the guide rods and screw to have support as they go through the front of the bench. The spacer block should be the same length that the length of your front vise will be. The actual height will depend on the vise carriage you have purchased so dimensions may need to be adjusted from what I have in my diagram. You will also need to drill clearance holes for the dogs to pass through. The spacing of your holes will again depend on the dog hole spacing on your bench.

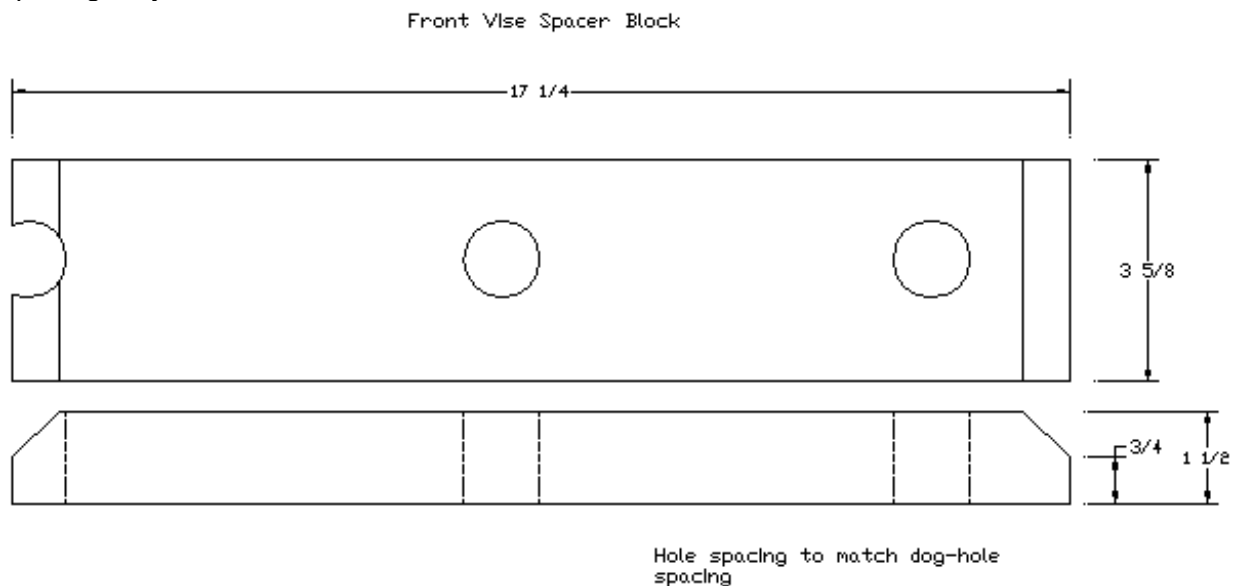

Once you have the spacer block made, attach it to the bottom of the dog hole strip by gluing it and then screwing it into place. Be sure that your screws will not be in a position to interfere with the guide rods and vise screw holes that will be bored through the spacer block in a later step.



The Front Vise Spacer Block mounted on my bench

The Front Vise Face Block

The next step is to make the piece of wood that will become the actual front vise. I wanted mine to be pretty massive, about 3 1/2 inches thick. Now, the thickest lumber I had was the 3" thick hard maple. To get it a little thicker, I needed to glue a second piece onto one side. I could have used another piece of hard maple, but to add some contrast to the vise, I instead decided to glue on a piece of 4/4 walnut to the face. I then used a jointer plane to get a smooth and perfectly flat face on both the front and back. The finished block was 17 1/4" long, 3 1/2" thick and 5 1/4" wide.

Boring the holes in the Face Block

Next, I needed to drill the holes in the face block that the vise guide rods and screw would go through. On my vise hardware, the guide rods were 3/4" in diameter and the screw was 1" in diameter. To lay out the correct position for the holes, I first marked a center line across the length of the block and a second line that represented the thickness of the top, measured from what would become the top of the face block. I then laid the vise carriage onto the vise block, flush with the line that represented the thickness of the bench and centered on the center line. A drill bit of the same diameter as the guide rod holes and of the screw holes was slid down into their respective holes to mark the correct drill locations. The holes were then bored on the drill press to assure a perfect perpendicular hole. The holes for the guide rods were drilled to the same size as the guide rods (on mine 3/4") and the screw hole was drilled 1/4" larger than the screw size to allow for easy turning (1 1/4" hole on my vise).

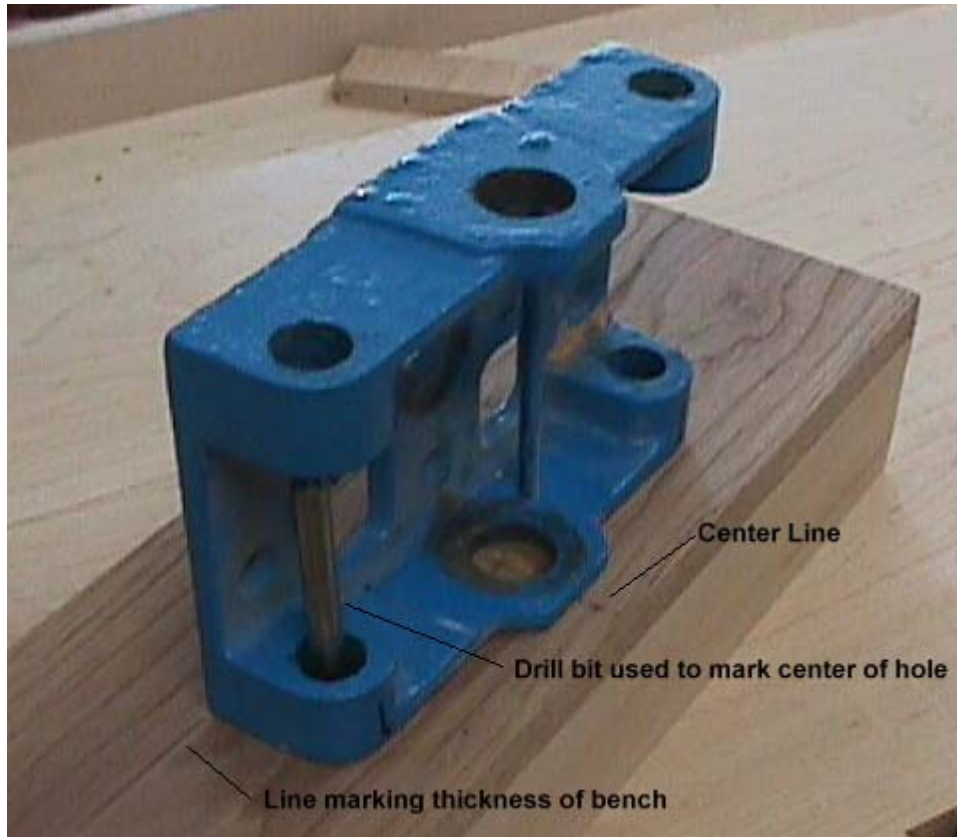

After the holes in the face block were drilled, I took it to the band saw to cut the rounded edge. I used a woodworking rasp to help remove the saw marks and put the final shaping on the round over.

Boring the holes in the bench

Next, I needed to drill the guide rod and screw holes through the bench. To help layout the correct hole position, I used the holes in the vise block as a template. I took the vise block and clamped it to the bench in the exact position I wanted it end up at. I next used drill bits of the same size as the holes already drilled into the vise block to mark the center of the holes in the bench. After marking the correct position, I removed the front vise from the bench and bored the holes through the bench. These holes all needed to be drilled 1/4" over size to allow both the guide rods and the vise screw to go through the bench without actually touching the bench. On my vise, this meant a 1" hole for the guide rods and a 1 1/4" hole again for the vise screw. Be extremely careful to drill the holes square to the face of the bench.



Using drill bits to mark the center of holes on the bench.



The Finished Holes.

Preparing the Bench Face

It is important to remember that once you install the bench hardware, you will not have a chance to go back and work on the surface of face of the bench or vise block - the guide rods and vise screw will be in the way. To make sure that both the face of the bench and the vise block are perfectly flat and meet together without any gaps, I next took a jointer plane (my Stanley #8) and planed both surfaces until they met together perfectly.

Installing the Vise Hardware

Next, I attached the vise hardware to the face block. To help the guide rods slide through the tight fit of the face block holes, I first rubbed the rods down with a coat of paste wax. I then inserted the guide rods into the face block holes and using a dead blow hammer, tapped the hardware all the way down. A couple of screws then secured the hardware to the face block.



The Vise Hardware attached to the Face Block

Next, slide the guide rods and screw through the face of the bench. Then slide the vise carriage onto the guide rods and slide it up flush to the back of the bench dog hole strip. Tighten the screw on the vise, being careful to position the face block where you want it to be at completion. Once you are sure everything is positioned correctly, screw the carriage to the bench. You may have to remove the face block from the bench and carriage to expose all of the carriage screw holes.

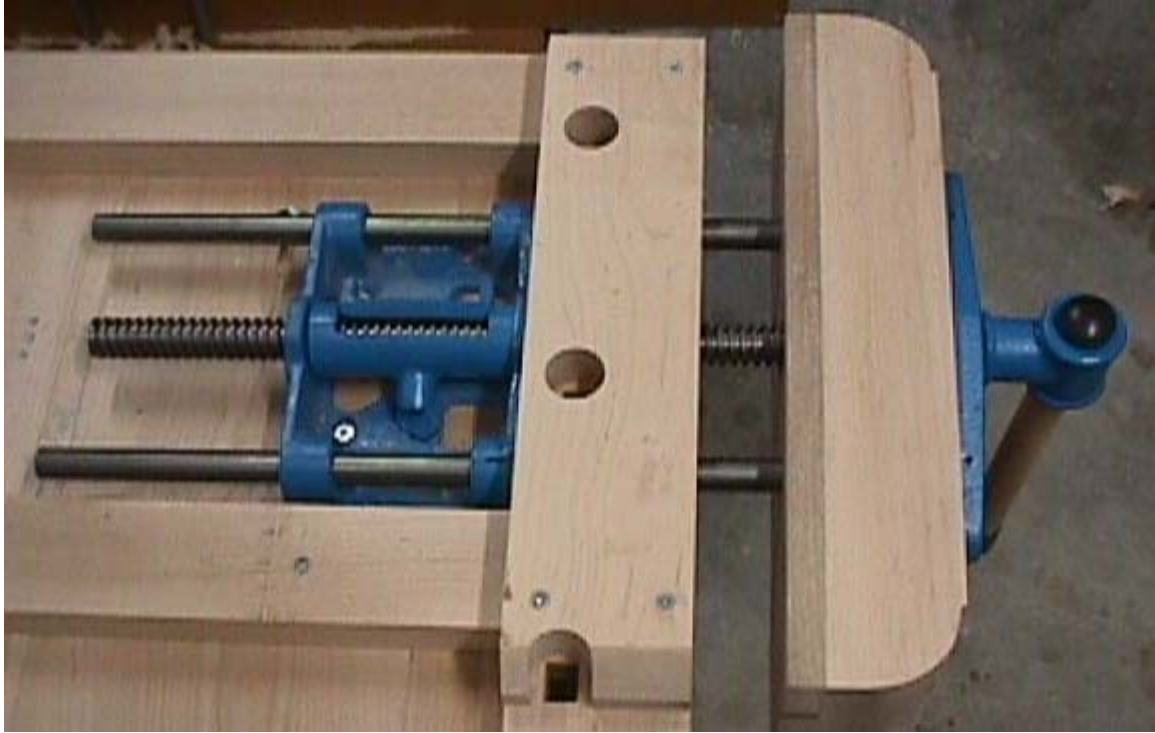

Bottom view of the installed Front Vise.



Top view of the installed Front Vise.

The End Vise

Of the entire bench, perhaps the most complicated part to build was the end vise. For me, I think I was a little frightened to even begin the process. Before beginning this step, I would do what I did, study everything you can find on how to complete this portion of your bench. I can't tell you how many times I read the chapter in "The Workbench Book" on Frank's bench. I also spent a fair amount of time sketching out how it would go together and even making drawings in AutoCAD to help my understanding. I guess the only thing I didn't do was make a mock up first, and it wouldn't have been a bad idea.

I can say that once I got started on the end vise, it actually went together much better than I had anticipated. Just take it one step at a time and try not to get ahead of yourself.

The Face Piece

The first piece I worked on was the Face Piece.

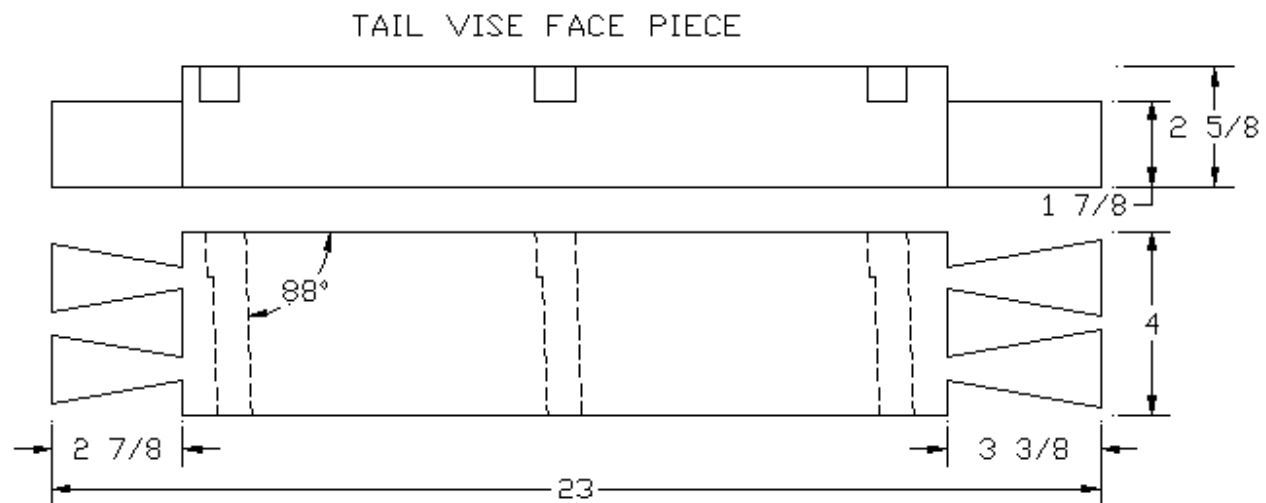

After working the stock down to its final dimensions, I next made the dog-hole slots. I used the same procedure to do this as in the dog-hole strip, except that the slots on the face piece are cut in the opposite direction so that as the vise is tightened, the pressure on the dogs will be working to your advantage. I used the same router jig as before but to cut the strips at the opposite direction, I had to turn the jig over and reposition the fence. Also, since there will be a top cap on the top the face piece, the notch on the front side of the slot did not have to be as deep as the ones in the dog-hole strip.

Next, I cut the dovetail tails. Remember that the left dovetail will be a half blind dovetail and the right one will be a through dovetail. For this reason, the depth of the right dovetails needs to be deeper than those on the left. I used a 10° angle on these dovetails just as elsewhere in the bench. I made my cuts on the band saw simply because of the depth of cut, which was deeper than my dovetail saw would cut.

Once the waste on the dovetails was removed, I cut the step on the back side of the face piece. The main reason I did this was to cut down on the amount of waste I would need to remove on the jaw pieces. Again, I used the band saw to remove this waste.

The Front Jaw

The most complex part to mill on the end vise was the front jaw.

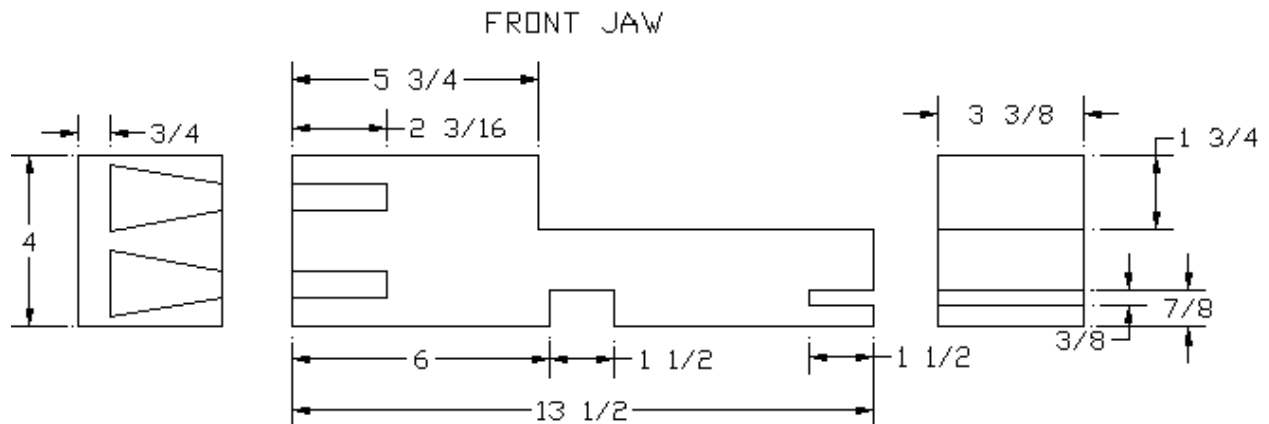

Due to the width of the front and rear jaws (3 3/8") and the maximum width of my lumber (12/4), I needed to laminate a second piece of lumber to get the width. As with the front vise, I chose to use a contrasting color of wood for this piece to add some character to the bench - I chose to use walnut.

Once the stock was milled to final dimensions, I next cut the dovetail half-blind pins. This was done in pretty traditional methods. First, I cut the slots with a back saw (too deep for my dovetail saw) and then removed the waste with a chisel.



Sawing the half-blind pins

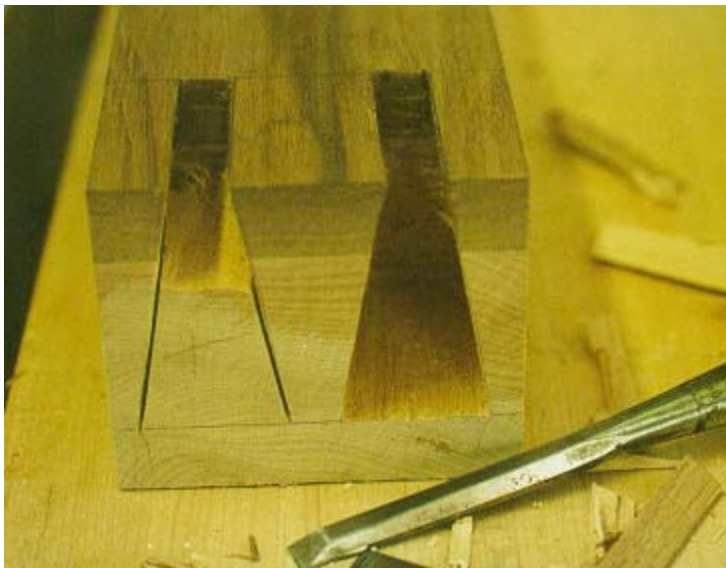

Removing the waste

After cutting the dovetails, I next cut the slots for the two runners. The runner in the middle of the bench was 1 1/2" by 1 1/2", which was cut on the table saw using the crosscut sled to assure a square cut. Next, I cut the slot for the back runner. This slot will fit the rear runner with a finger joint. The last step was to cut the large step on the top of the jaw, which was cut out on the band saw.

The Rear Jaw

The Rear Jaw is similar to the front jaw except that it is not near as complex. The first step was to cut the dovetail pins. I made the cuts on the band saw using the 10° table jig that I made in a earlier step. The waste was then removed by chiseling.

On the Rear Jaw, there is only a need to cut a slot for the back runner, which will be finger jointed to the back just like with the Front Jaw.

The Back Runner

The Back Runner is perhaps the easiest part of the end vise to make. It is simply a 1 1/2" square strip. At this point, to make sure you cut the finger joints in the correct position, I first put the rest of the vise together dry and clamped it into position on the bench. I then marked where the runner should be positioned and marked on it where the slots needed to be cut. I made the cuts on the band saw and removed the waste with a chisel.

Assembling the End Vise

At this point, I again dry fit everything together, taking care to fine tune all joints to fit together tightly but smoothly.

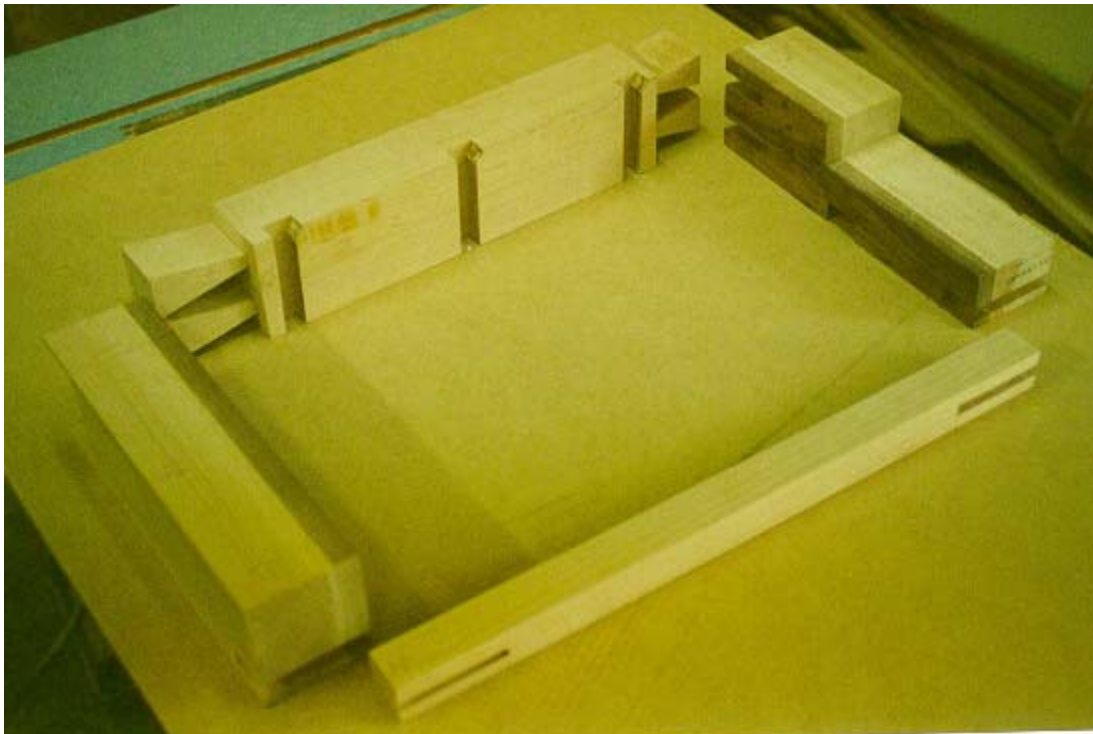

All of the parts laid out ready to glue and clamp

I next spread some glue and clamped it all together, taking care to be sure everything was square and tightly clamped into place.

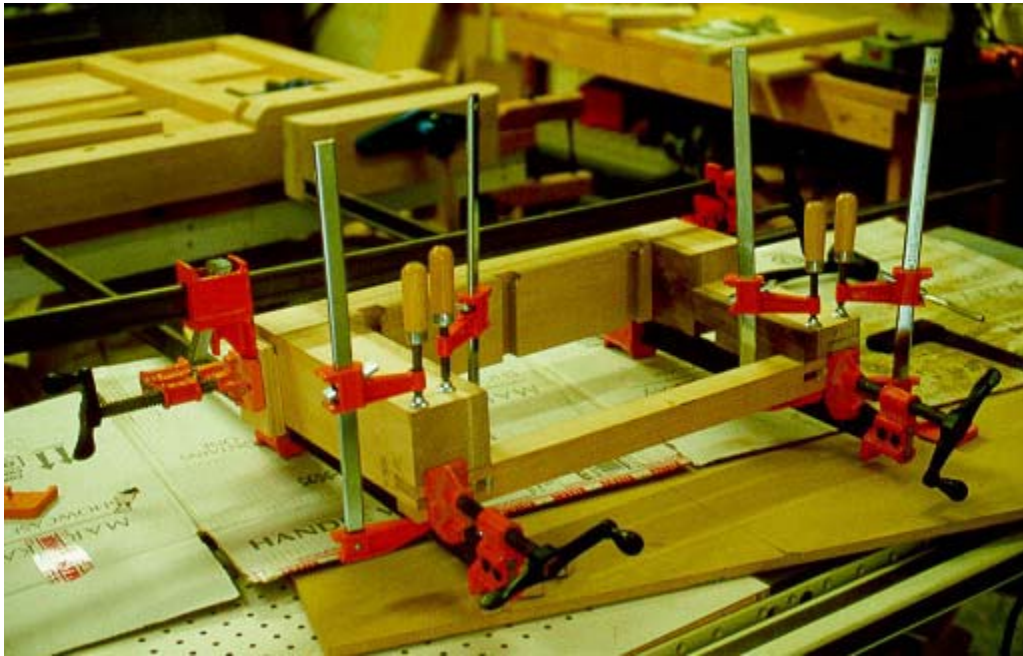

Clamping it all together

Fitting it up

Once the glue was dry, I next did some finishing work to the end vise assembly. First, I worked on the four corners where the joinery was exposed. I took a low angle block plane to trim the joints flush and square. Next, I used a jointer plane to get the top of the face piece perfectly flat for the top caps to fit on top of.

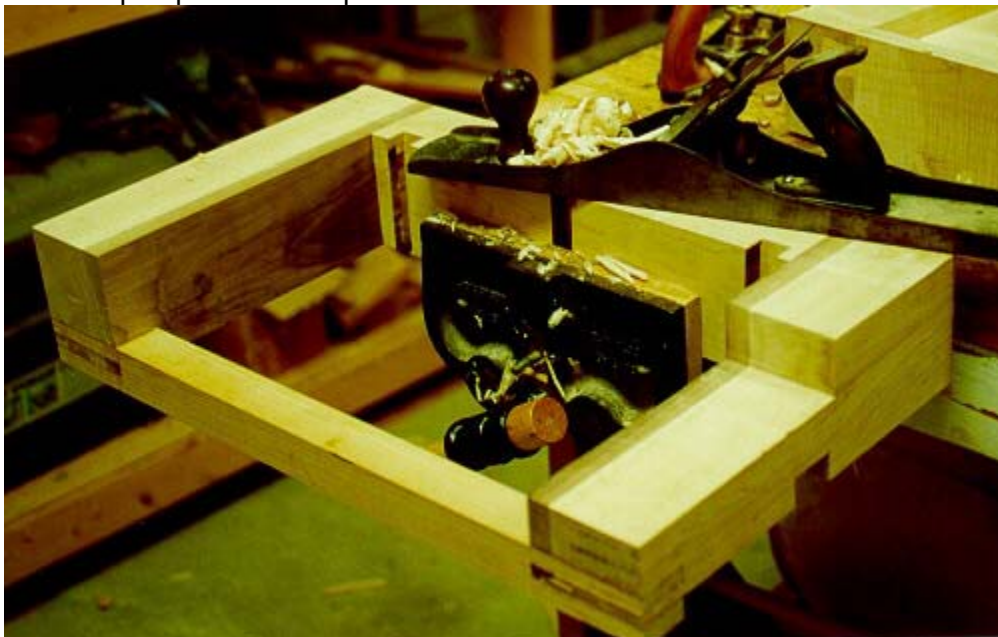

Jointing the top flat

Next I took some extra steps to permanently secure the back runner into place. On Frank's bench, he used a dovetail joint on the back runner instead of a finger joint to assure that it did not slip. While a dovetail would have made a beautiful joint, I just decided it was not worth all of the extra worry to make one. A finger joint would be plenty strong and where joints are located, it is hardly noticeable from a aesthetic consideration. To make sure that the finger joint never slipped, I pinned it with two wooden dowels on each end.



Pinning the finger joint with dowels

The Dog-Hole Cover

The last step in finishing the End Vise assembly was to cover the back of the dog-holes. To do this, a 1/8" piece of plywood was cut and glued into place.



Clamping the Dog-Hole Cover

And finally, I cut and screwed the front runner to the back of dog-hole cover. The front runner is a piece of maple 3/4" by 7/8" that runs on top of the end cap.

The Guide Block

Now that the End-Vise assembly is complete, we need to get ready to mount it to the bench. The first step in mounting is to make and attach the Guide Block.

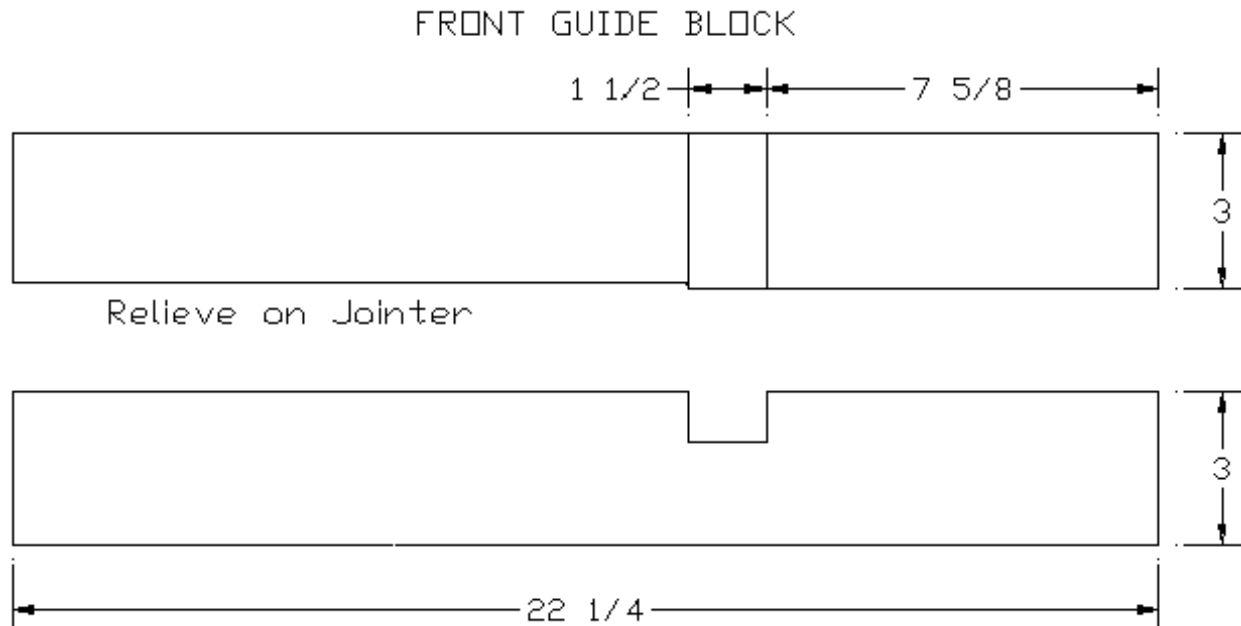

The Guide Block serves several functions. First, it will be the bottom part of the clamping jaw on the bench side of the End Vise. Second, it supports the bench runner which will help assure that the vise opens and closes square and without racking. While I show dimensions as to where the notch for the bench runner was positioned on my bench, you will need to locate the best place for your bench.

To locate the proper position for the bench runner, clamp the End Vise assembly into place on the bottom of your bench, taking care to be sure it is exactly where you will want it to be after construction - make sure it is square.

Next, position the bench runner where it will be mounted and mark the proper position on the guide block.



Marking the position of the bench runner

After marking the position, remove the waste for the notch. Be sure to remove it to a depth that fits the notch that is already cut in the front jaw of the end vise. I removed the waste on the table saw using the cross cut sled to assure a square cut. I then cut a relief from the end of the notch to the back of the guide block on the jointer. The purpose of the relief is to make sure that the back of the end vise does not come in contact with the guide block when clamping, perhaps resulting in an un-square closure of the vise.

Next, I took 3/8" by 4" long lag bolts and bolted the guide block to the bench. Take extra care to be sure the guide block is being bolted down square to the front of the bench! No glue was used for two reasons, first I did not want to glue it to the bench bottom due to cross grain construction, which could cause problems as the bench top moved, and second, I did not glue it in case I ever needed to remove the guide block in the future to make adjustments in the vise as it wears.

Also notice that I had to cut a hole in the guide block for a dog hole that was located beneath it. If I had the bench to build over again, I would have located the first dog-hole in the dog-hole strip behind where the guide block would be mounted. Live and learn...

The Bench Runner

I next put the bench runner into both slots and marked the correct position it will be attached on the end cap. Take special care in finding this position. I clamped the bench runner to the end cap and slid the vise back and forth several times to make sure that it would slide without binding and being sure it was square.



The Bench Runner clamped into final position

The Front Guide Block

The next step is to make and mount the front guide block.

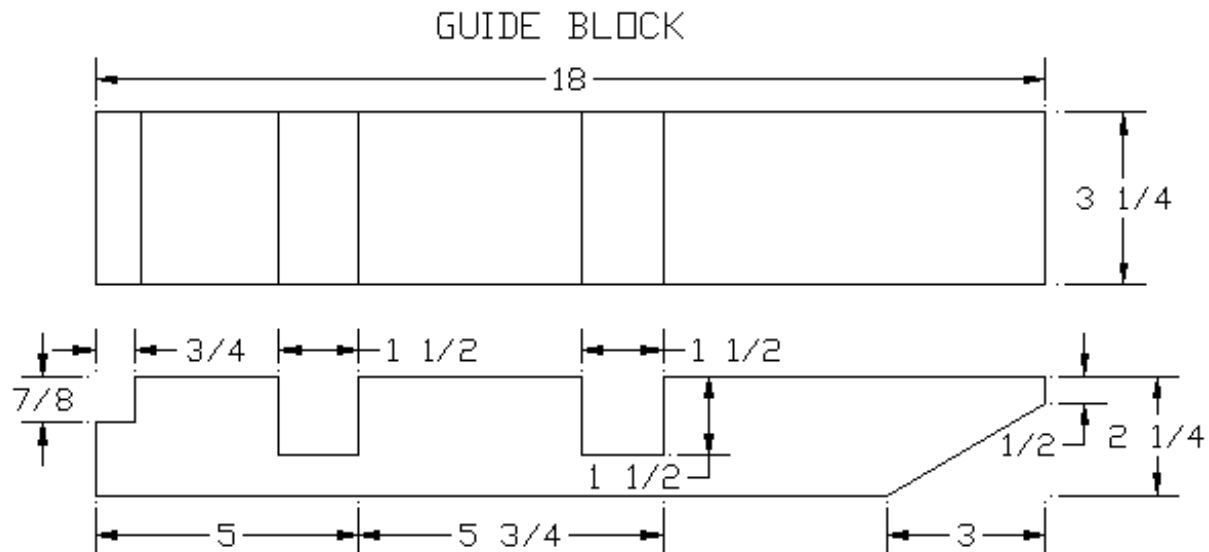

The purpose of the Front Guide Block is to simply hold the three runners in place. While there are dimensions for the location of the three notches for the runners, you will need to carefully mill them in the correct position for your vise, these dimensions are just roughly where they will be.

Once everything has been milled, clamp the front guide block into position and move the vise back and forth to be sure it moves smoothly and without binding. If any fine tuning needs to be done, now is the time to do it.

The next step is to drill a hole in the rear jaw for the bench screw. To locate the position for the screw, take a 1" dowel rod (or whatever size fits snugly into the screw nut on your hardware) and slide it through the screw nut up to the rear jaw. Take a pencil and mark all of the way around the dowel rod. This mark will determine the center of the hole. On my bench, the screw had a 1 1/4" outside diameter. To be sure that the bench screw does not rub anywhere on the hole and to compensate for any error in drilling, I bored a 1 1/2" hole through the rear jaw. Once you are satisfied with everything, blot the front guide block into place with lag bolts as with the other guide block. As with the other guide block, do not use any glue so that you can take the end vise apart in the future for any needed repairs or adjusting. Next screw the bench screw all of the way into the end vise and mount it in place using large screws.

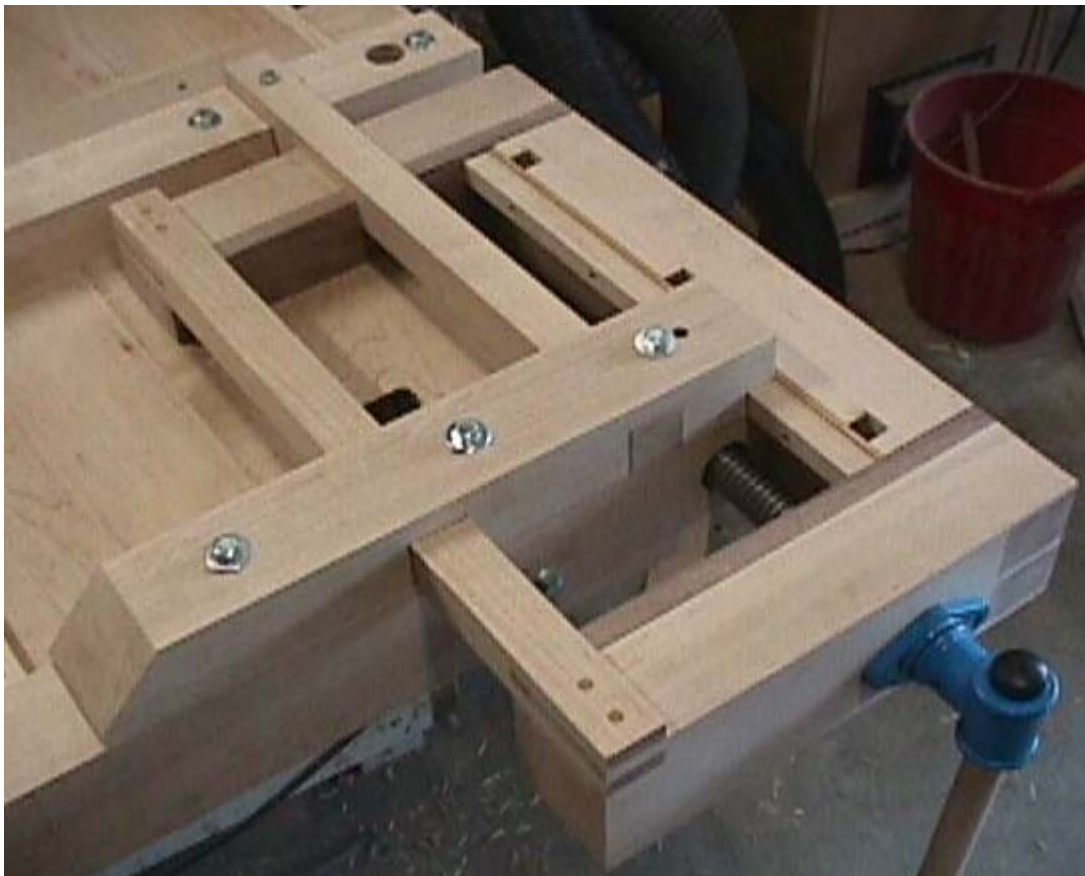

The Front Guide Block mounted with the bench screw in place



The bottom view of the bench will both vises mounted

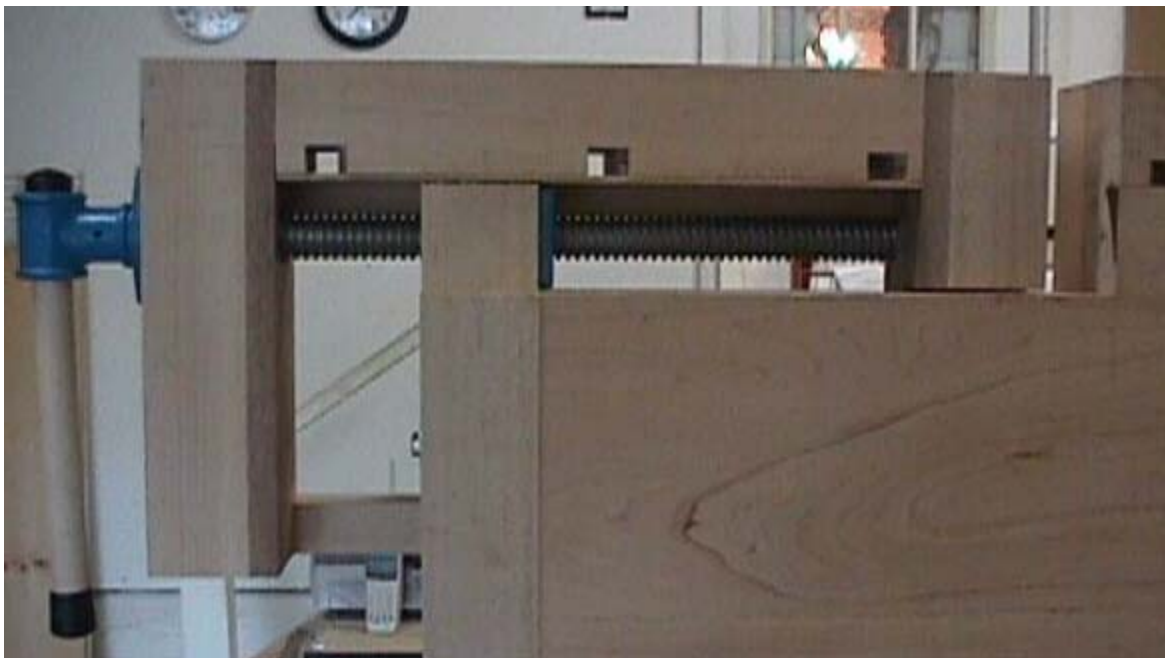

Top View of vise before top caps are installed

Mounting the Top Caps

The final step in completing the end vise is mounting the top caps. The first step was to mill two pieces of maple to rough size. I planned the top caps to a thickness just a little bit thicker than was needed to be flush with the top. The final thickness will be planed off later when I plane the top flat.

Once the stock was cut to approximate size, I then placed them on top of the end vise. The next step is to cut the rectangular holes for the dog holes. As easy as that sounds, this actually turned out to be the most trying part of making the end vise.

The first step is to mark where the holes will be. To do this, I simply held the board flush with the ends and marked the spacing on the edges of the board. The marks were then transferred across the face using a pencil and square. I then set a marking gauge to mark the thickness of the square holes.



The marks for the square dog holes

To cut the holes, I first decided to just chisel out the waste similar to cutting a mortise. My first attempt failed miserably, the holes were anything but square. One board wasted.

I then seriously considered using my mortising attachment for my drill press. While I am certain that this would have worked, it is just such a pain to set that thing up that I figured there had to be a easier way.

I finally decided to try chiseling again, but this time remove most of my waste first and then just chisel to the final size. To remove the waste, I drilled a series of small holes around the inside perimeter of the marks. I then used a chisel to "connect the dots" and the waste was easily removed. I then used a sharp chisel to clean up the hole to cut it to size and make is square. This worked like a charm.



The holes drilled to help remove the waste



Cleaning up the holes with a chisel

Because there are actually two separate boards used to make the top cap, and they meet at a miter joint, the next step is to determine the angle needed for the miter. Unfortunately, the width of the two top cap boards are not the same width so the angle is not a standard 90 degrees. To determine the correct angle, I laid the top cap into place and using a bevel gauge, marked the correct angle. The angle was then cut and a complementary angle was cut on the second top cap piece to make a perpendicular fit.



Marking the angle on the top cap

When all of the pieces were cut to fit, I then glued and clamped the two top cap pieces into place. With the clamps still in place and before the glue had a chance to set, I screwed the end vise all the way in and out to its extremes to be sure there was no interference in this operations from the top caps. Satisfied with the fit, I left the parts for the glue to dry.



Clamping and gluing the top caps into place

Once the glue dried, I removed the clamps and using a hand plane, planed all of the edges of the top cap flush with the end vise assembly.

I then did something I had been wanting to do for quite a long time now - I clamped a board to the top and did some hand planing. How did I ever get by without an end vise and dog holes?



My first shavings on my new bench!

The Base

The base of my workbench is pretty straight forward - nothing fancy at all. The basic design is more like timber frame construction or the base to a trestle table. Here is the plan for the base:

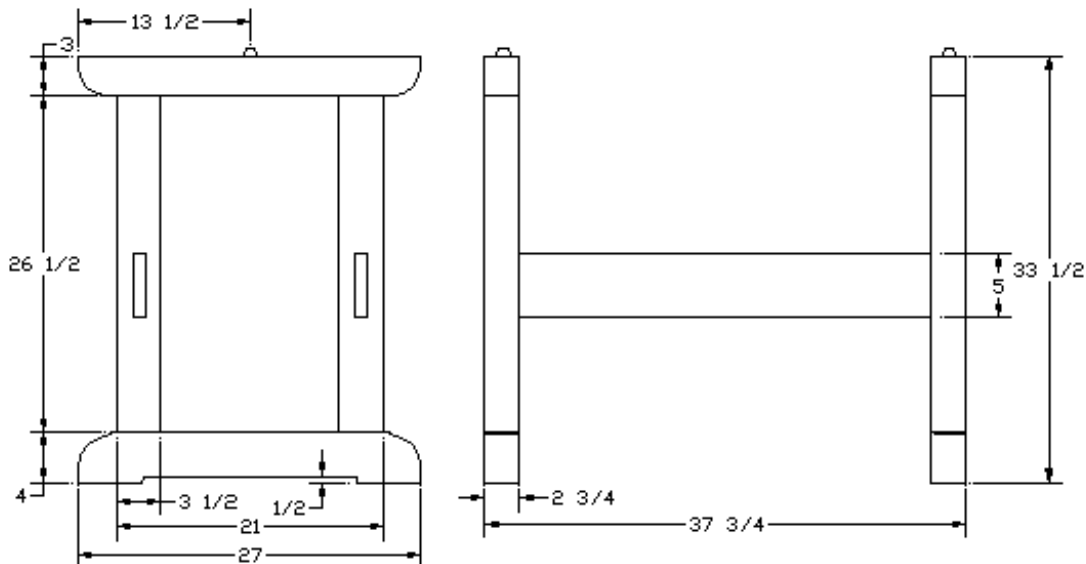

Ideally, the base should be made out of some kind of hardwood. The nice thing is that you don't need the best lumber in the world for the base. Knots are perfectly acceptable as long as they do not jeopardize the stability of the lumber. On my base, I took things one step further - instead of using hardwood, I decided to use Southern Yellow Pine. The decision was purely an economic one. I did not have access to any thick hardwood locally and to get some was going to just cost too much. Southern Yellow Pine was available at the local lumber yard as construction grade lumber - cost of materials, about \$30.00.

With all things said and done, I can say two things about my base. First, structurally, it is just fine. Plenty of stability and no racking, the characteristics of a good bench base. Second, I wish I had made it out of hardwood. Why? Well, the pine base just looks out of place under such a nice top. It is completely functional but I just do not like it. I already have plans tucked away in the back of my head for a new base when time and money permit. It will be of similar construction but made of hardwood and will probably have some cabinets or drawers built into it for extra storage - something like the shaker benches in *The Workbench Book*.

One other note on the base. In an ideal situation, you should probably build the base first and then build the top using the base to support it. While this is the ideal situation, I did not have room in my shop for the base and my existing bench. Since I wanted to be able to use my old bench to help in the construction of the new one, I built the top first and then the base. If you do not have a bench at all in your shop or if you have the room, it would probably make more sense to build the base first and then the top.

Well, enough on that, lets get to how I built the base.

The first step was to get all of the pieces milled down to rough dimensions. Since I was working with pine, I left everything a little over sized and let it sit for about a week before I did any finish milling. Good thing that I did since the lumber did a little twisting while it acclimated itself to my shop. A little time getting everything square again and I was ready to get to work.

The first thing that I did was cut the arcs on the end pieces of both the base feet and top pieces. This was done on the band saw. Once the ends were cut to their shape, I took some files to get a nice smooth profile.

The next step was to cut the mortise and tenons for the base parts. I guess cutting mortise and tenons is kind of like cutting dovetails, which do you cut first. Well, when you get down to it, it probably does not matter but I like to cut my tenons first just like I like to cut my pins first with my dovetails. To save time, I rough cut the tenons to size on the band saw and then using a block plane, shaved them down to their final dimensions.

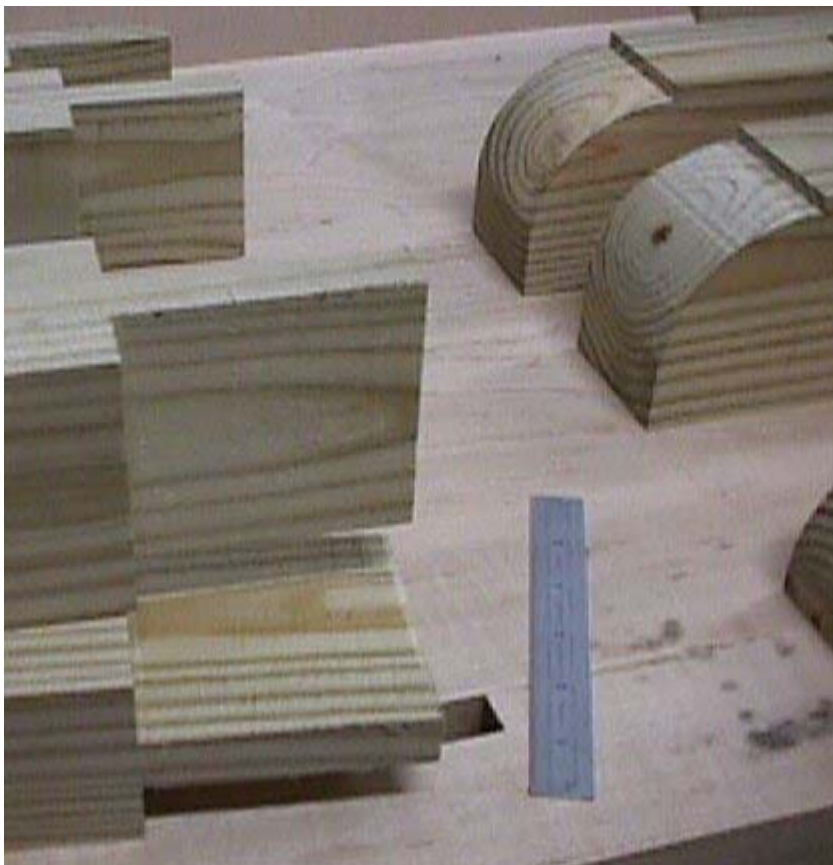

The finished tenons. Also notice the arcs cut on the end of the feet.

Once the tenons are cut, the next step is to cut the mortises to fit. There are several methods of cutting mortises. Traditional method is to use mortising chisels, a special kind of chisel that is much thicker than a regular chisel. While this method of cutting mortises is quite fun, I don't happen to own a set of mortising chisels (yet). Another options would be to use a mortising attachment on a drill press. The mortising attachment will basically allow the user to cut a square hole. I do own a mortising attachment for my drill press but I find it quite a pain to set up and chose not to use it. Some people like to use a router to make mortises. Again, works just fine, but I chose yet one other method. To cut my mortises, I decided to remove the majority of

the waste with a drill and then use a regular chisel to make the hole square. The process is straight forward, just drill a bunch of holes and then chop out the remainder of the waste. Best thing is that this method employs tools that almost any craftsman will have in their shop without having to go out and buy a new kind of gadget.



The holes drilled ready for cleaning up into mortises.



A finished mortise

Once all of the mortise and tenons are cut, you are ready to assemble the base. Spread some glue on the joints and use a clamp to pull the tenon into the mortise. Assemble an entire leg at a time. Work quickly as you will want to get the entire leg put together and clamped as one finished piece. If you let the glue dry before you finish, the result may be that you can't quite fit the other side in place or the leg is out of square.

Once the two legs are glued up and had a chance to dry, install the two stretchers that connect the two legs together. At this stage you will want to be sure that the entire base is sitting flat on all four legs. If it rocks back and forth, you will need to use clamps to pull it square and without rocking. One thing to remember here is that all floors are not perfectly level - particularly concrete floors. This is the case in my shop as well. For this reason, I put the base on the floor where the completed bench would fit and made sure that all four legs sat without rocking on that part of my floor, even though they were not perfectly square.

The final step in building the base is to install two buttons on the base top. The purpose of these buttons is to fit into two holes drilled on the bottom spacers of the bench top. Once the bench top sits on top of the base with these buttons fitting into their holes, the top will not move on the base.

The buttons are made of 1" dia. dowel rods. Drilled two 1" dia. holes on the center of the base top and glued the dowel rods into place. I made the buttons where they would stick up 3/4" from the base top and also rounded over the buttons so that they would be easier to align into the top. Once the buttons were installed, I carefully measured their positions and then drilled matching holes in the bottom spacers on the bench top. Take special care here to get a perfect alignment so that the top will fit onto these buttons without any modifications.



The finished base

Flattening the Top

Once the bench top is mounted on its base, it time to do one of the most important steps in the entire bench building process - flattening the top.

To flatten my bench top, I began by taking down any obvious high spots and mis-aligned joints with a belt sander. The belt sander is handy at this point because it removes material fairly quickly without a lot of effort. Be extremely careful with the belt sander to not make any gouges in the table that cannot be removed with a little planing.

Once you do the rough flattening, it is time to get out your hand planes to be sure everything is truly flat. I began with a jack or smooth plane to once again take down any small high spots. Once the bench had pretty much cleaned up everywhere with the smoother, I switched to the biggest jointer plane I had - my Stanley No. 8. The long flat sole of my jointer plane was just the thing to get a truly flat surface. It was really surprising how quickly my bench top began flat once I went through the hand planes.



Flattening the bench top

Finishing the Top

Almost there. Now, all that is left to do is put a finish on the top. There are lots of opinions out there as to what kind of finish to put on a workbench. I guess the most traditional finish out there is just plain boiled linseed oil. I remember hearing somewhere that the recipe for finishing a workbench went like this.

Rub in Boiled Linseed Oil as follows:

Once a day for a week.

Once a week for a month.

Once a month for a year.

Once a year for life.

That all sounds good but there are other options out there. You could easily use shellac for a traditional finish. A more modern approach would be polyurethane. For my bench, I chose to use my favorite of all oil finishes - Waterlox.

[Waterlox](#) is a specially processed Tung Oil that dries hard but is still elastic, allowing it to move with the wood. It gets its name from the fact that it "Locks out Water" and is hence a waterproof finish as well. Once I first used Waterlox on some of my projects, I was hooked. You can simply wipe the product on with a paper towel or cloth rag and after a couple of coats, you got a great finish.

On my bench, I first wiped on a heavy coat on the bottom of the bench before mounting it on the base. Once on the base and after the top was flattened, I wiped on a light coat on the entire bench top. After the first coat, I lightly sanded and then built up six more coats to get a great finish that will not only look good but help protect the bench top. The results were great!



The Finished Bench

Details

Here are some detail photos of the finished bench...





