

PACKAGING FOODS IN GLASS

Introduction

This technical brief is intended to advise small-scale producers on the methods and equipment needed to package foods in glass jars and bottles. For a more detailed account of the types of foods that can be packaged in glass, the properties of glass containers, label design and production and the economic implications of introducing glass packaging the reader is advised to consult 'Appropriate Food Packaging' by P J Fellows and B L Axtell, ILO Technical Memorandum, Published by TOOL Publications, Sarphatistraat 650, 1018 AV Amsterdam, The Netherlands, 1993 (ISBN 90 70857 28 6).

General outline of procedures

Process summary

New jars or bottles	Reused jars or bottles
---------------------	------------------------

Inspect

Rinse

Wash

Inspect

Sterilise ~ For hot filling and cold filling

Fill ~ Liquid fillers or solids fillers

Seal ~ Caps for bottles, lids for jars

Process ~ Some products are heat processed

Cool

Label ~ Glued paper or self-adhesive labels

Collate into shipping container ~ Cardboard boxes, shrinkwrap or stretchwrap films

Inspection and preparation of containers

All incoming glass containers must be inspected for cracks, chips and small bubbles in the glass. New jars and bottles should be rinsed in clean water, chlorinated if necessary by adding 2-3 drops of household bleach per litre of water.

Second hand bottles must be thoroughly inspected, both by looking for chips etc and also by smelling the containers to make sure that they have not been used for storing kerosene or

Knowledge and Information Services, The Schumacher Centre for Technology & Development

Bourton Hall, Bourton-on-Dunsmore, Rugby, Warwickshire CV23 9QZ, UK

Tel +44 (0)1826 634400 Fax +44 (0)1826 634401 E-mail info@nfdg.org.uk Web <http://www.nfdg.org>

**Intermediate Technology Development Group Ltd Patent HRH - The Prince of Wales, KG, KT, GCB
Company Reg. No 071854, England Reg. Charity No 247267 VAT No 241 8184 52**

technical brief

poisonous chemicals (insecticides etc). All contaminated containers should be removed and not used for foods.

Second hand containers should be soaked in a 1% solution of caustic soda with detergent to remove old labels. The interior should be cleaned with a bottle brush (Figure 1) and then rinsed thoroughly. Rinsing is time consuming and can be speeded up using a bottle rinser (Figure 2).

Many foods that are packaged in glass are then heat processed and for these it is usual to hot-fill the containers (fill at 80°C or above). Glass has to be heated and cooled carefully to avoid the risk of breakage and therefore it is usual to pre-sterilise containers before hot filling. This can be done by placing bottles/jars in a large pan of warm water and heating it to boiling. The containers are boiled for 10 minutes and then removed for immediate filling and sealing.

Alternatively a steamer (Figure 3) can be constructed and bottles/jars steamed for 1-2 minutes. This uses less energy

and saves considerable amounts of time compared to using boiling water. However, care is needed to make sure that the containers are not heated too quickly, as they will break. Any weak containers will also break at this stage and bottle sterilisation should therefore be carried out away from the food production area to avoid the risk of contamination by broken glass.

Tongs as shown in Figure 3 should be used in all cases when handling hot containers.

For foods that are cold filled and then heat processed it is not necessary to pre-sterilise the container. For cold filled foods that are not subsequently heated it is essential to make sure that the



jar or bottle is sterilised by one of these methods to prevent contamination of the product by any micro-organisms on the glass.

Filling

Most foods that are packaged in glass are either liquids, such as drinks and syrups or thicker pastes such as sauces, chutneys etc.

There are basically two types of filling equipment: those used for solid foods and others for liquid foods.

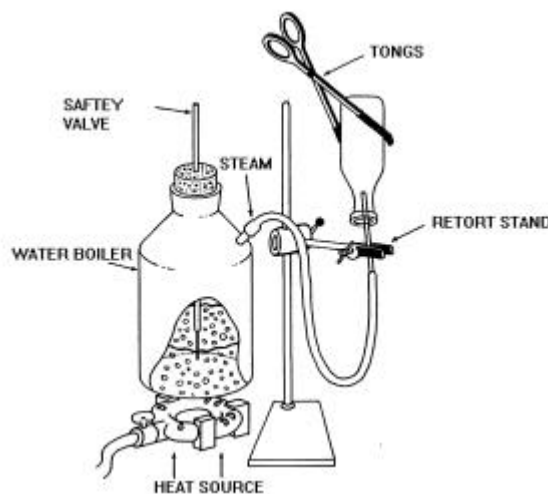

technical brief

Solids fillers

There are few paste filling machines that are cheap enough for small-scale processors but an example of one type (a piston filler) is shown in Figure 4. Most producers fill by hand and although this is slow it can be speeded up by the use of a simple funnel and rod (Figure 5).

In the case of solids such as fruit that is packed in syrup, the solid pieces are first placed in the jar by hand and the liquid is then filled using a liquids filler.

Liquids fillers

The simplest method is to fill containers from a jug that is calibrated for the correct volume. A funnel can be used to assist filling narrow necked bottles. A simple frame to tilt jars so that the correct filling level is achieved is shown in Figure 6, this will also speed up the filling operation.

At a larger scale of production, a filler can be made by fixing taps into a 50 litre stainless steel bucket (Figure 7). Food grade plastic is acceptable for cold filling.

However, these methods are relatively slow and therefore only suitable for small production rates (eg up to 1000 packs per day). They also give some variation in the filled volume, even

with careful training of the operators.

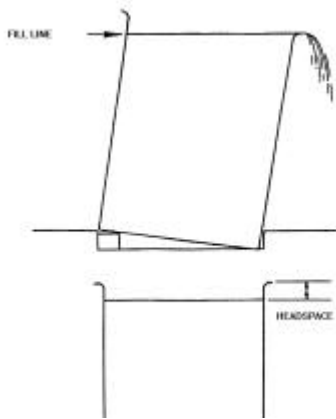

At higher production rates a piston filler gives a uniform fill-volume and can be adjusted to fill different containers from 25-800 ml. Typical outputs are 15-30 packs per minute.

A different approach is to use a vacuum filler. These are available commercially but can also be made locally. The principle of operation is shown in Figure 8. A venturi pump, obtained from a laboratory supplier, is attached to a water tap to create the vacuum. This then sucks liquid from a

product tank into the bottle until it fills to a pre-set level.

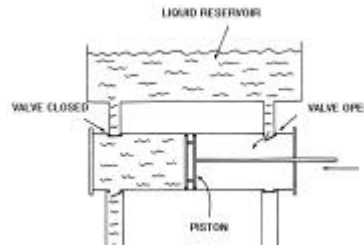
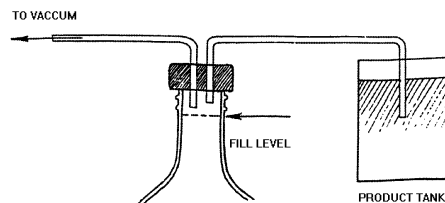

technical brief

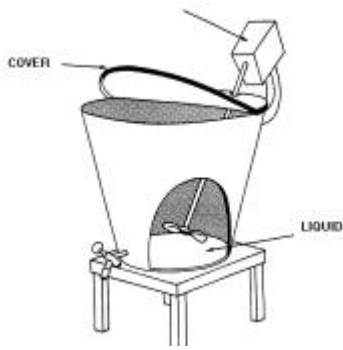

Sealing

Most caps for bottles and jars have a ring of plastic material (sometimes waxed card or cork) which forms a tight seal against the glass. During hot filling and heat processing this plastic softens and beds itself around the glass to make an hermetic seal. However, before this happens there is a risk that small amounts of air can be sucked into a container and cause contamination of the product. The risk of contamination can be reduced by laying a filled container on its side for about 10 minutes to ensure that the seal is perfectly formed.

Specific types of equipment are used for sealing the different caps that are used for glass containers.

For bottles the main types are:

- crown caps
- roll-on-pilfer-proof (ROPP) caps
- snap-on caps
- corks

For jars the main types are:

- twist-on-twist-off (TOTO) lids
- push on lids

All lids and caps should neither affect the product nor be affected by it and they should seal the container for its expected shelf life. This is usually found by testing trial containers with the product to be packaged to make sure that there is no interaction between the pack and the product. Expert advice should also be sought from the packaging suppliers when selecting the type of closure to be used.

Bottles

Crown caps are commonly used for beer bottles and fruit juices. Hand-operated equipment is available in a number of sizes from a simple former that is placed over the cap and hit with a mallet, to the hand-held lever type shown in Figure 9 and table mounted model shown in Figure 10.

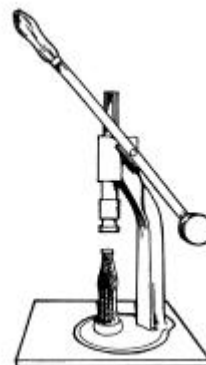
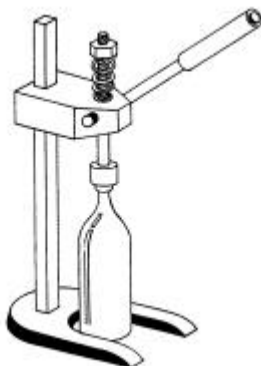

Roll-on-pilfer-proof (ROPP) caps are fitted by placing a blank cap on the bottle and then pressing the metal into the screw thread of the glass. Finally a ring of perforated metal is formed at the base of the cap which shows evidence of tampering or pilfering. Hand operated ROPP machines can be constructed locally (Figure 11) and small motorised version are

available commercially (Figure 12). A simpler cap which does not incorporate the pilferproof feature is known as a 'Roll-on (RO) cap and this can be fitted by similar types of equipment.

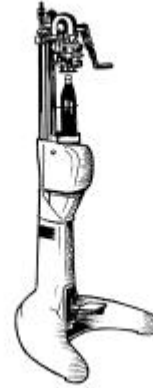
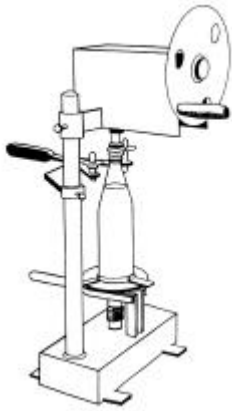

Plastic snap-on caps are fitted over the neck of the bottle and sealed by a capping machine (Figure 13).

Corks are mostly used to seal wine bottles and hand operated corkers which both squeeze the cork and insert it into the bottle are available (Figure 14). Corks are first wetted to make them slip more easily into the bottle and they then expand to give an airtight, waterproof seal. As corks may be contaminated by micro-organisms it is important that the soaking water contains either a few drops of bleach per litre or sodium metabisulphite at approximately one teaspoonful per 5 litres.



Jars

Push-on lids are still used for sealing jars (Figure 15) although these are increasingly being replaced by twist-on-twist-off (TOTO) lids. Small equipment is available for each of these types of closure.

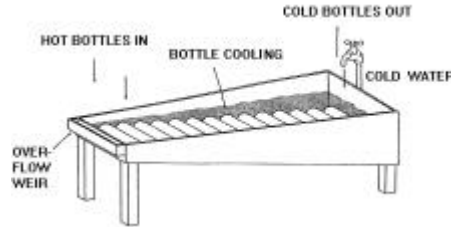

Processing

Some products are heat processed after packing into glass containers. They should be heated and cooled gently in order to avoid breaking the glass. One method of controlled cooling of containers after processing is shown in Figure (16). Cold water enters at the deep end of the trough and overflows at the shallow end. Hot bottles are placed in at the shallow end and roll down to the deep end. The temperature is cool at the deep end and gets hotter along the trough, so minimising the shock to the hot containers.

Labelling

Paper labels are the most common type used on glass containers. They can be plain paper that is glued onto the glass or alternatively self-adhesive types. Figure 17 shows a simple frame which can be used to hold plain labels, wipe glue over top of label in stack, roll jar along guide rail over label, roll and press jar and label into rubber mat. Small labelling machines (Figure 18) can be used to apply strips of glue to labels. A typical powered labeller has an output of about 40 labels per minute.

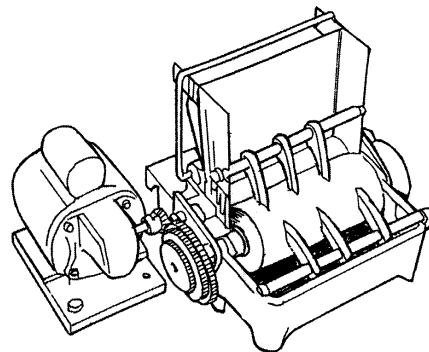
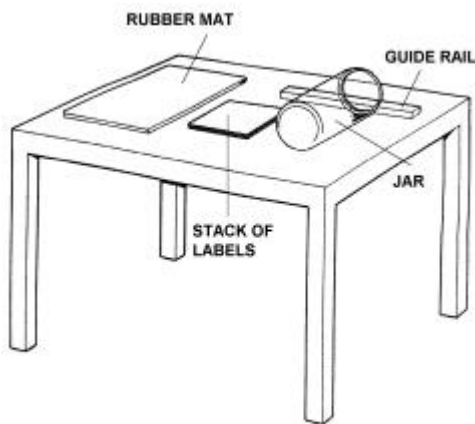

Water soluble glues such as starch or cellulose based glues are best if containers are returnable, so that labels can be easily removed. However, these glues may loose adhesion in

technical brief

humid climates. Non water-soluble glues, based on plastic polymers, are available and advice on the correct type should be sought from the suppliers.

Self-adhesive labels can be bought, fixed to a backing (or 'release') paper in rolls or sheets. They can be applied by hand, by small hand held machines or by powered labellers. The type shown in Figure 19 can apply 30-40 labels per minute.

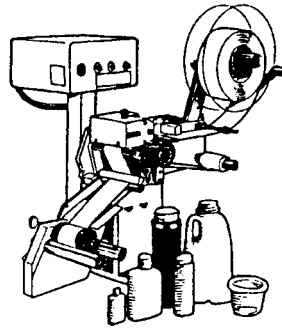

Figure 19

Quality control

This should be seen as a method of saving money and ensuring good quality products and not as an unnecessary expense. The time and effort put into quality control should therefore be related to the types of problems experienced or expected. For example, glass splinters in a food are very serious and every effort should be made to prevent them, whereas a misaligned label may not look attractive but will not harm the customers.

Faults can be classified as:

Critical

likely to harm the customer or operator or make the food unsafe (eg glass splinters)

Major

likely to make the package unsuitable for use in the process or result in a serious loss of money to the business (eg non-vertical bottles that would break in a filling machine)

Minor

likely to affect the appearance of a pack (eg ink smudges on the label)

Critical faults should always be checked for, whereas others may be examined, if they are causing problems.

For glass containers the critical faults are broken, cracked, or chipped glass, strands of glass stretched across the inside of new packs, or bubbles in the glass that make it very thin in places. Major faults are variations in the size and shape of containers and minor faults include uneven surfaces, off colours in the glass, rough mould lines and faults with the label.

One further quality control measure that is important with glass containers is to check variations in the weight of jars and bottles as these variations will affect the fill-weight. Random samples should be taken from the delivery of containers (eg 1 in 50 containers) and weighed. The heaviest pack should then be used to calculate the final filled weight required.

Quality control needs trained staff, an established procedure and some equipment and facilities. Staff are the most important and all operators should be trained to look out for faults in the product or package. One staff member should have responsibility for checking the packaging.

All glass jars and bottles should be checked for critical faults and if second-hand, checked for contamination before washing. Other quality control checks include:

- the filled weight (to ensure that the net weight is the same as that declared on the label)
- the appearance of the pack

- a proper seal formed by the cap
- the presence and position of the correct label.

Filled weight can be checked using a scale that has the package plus a known weight on one side and samples of filled product placed on the other side (Figure 20). The number of samples required to be checked depends on the amount of food produced and the method of filling. In general hand filling is more variable than machines and therefore more samples are required. As a rough guide one in every twenty packs should be checked.

Collation for transport/distribution

Once the containers have been filled, sealed and labelled they are grouped together to make transport and handling easier. Cardboard boxes are most commonly used and these can be bought or made up on site. A paper label can be used to cover existing printing on reused boxes and also advertise the product during distribution.

The required size of a box can be found by placing together the containers to be packed, together with dividers, and measuring the size to find the minimum internal dimensions (see Figure 21).

Newer methods of collating containers include shrinkwrap or stretchwrap films which hold the bottles or jars together on card trays (Figures 22 & 23).

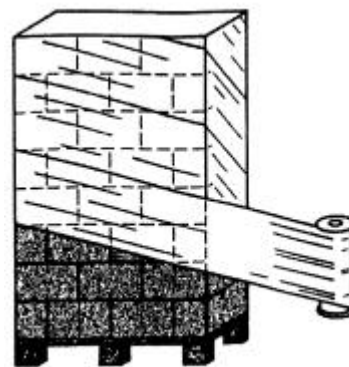
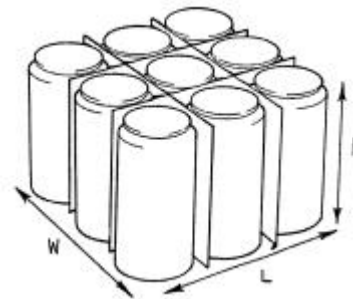

technical brief

Equipment suppliers

Bottle/cap sealers

Master Mechanical Works Pvt Limited
Pushpanjali SV Road
Santa Cruz (W)
Bombay 400 054
India

Thomas Hunter Limited
Mill Road
Omnia Works
Rugby
United Kingdom

J T Jagtiani
National House
Tulloch Road
Apollo Bunder
Bombay 400 039
India

Liquid fillers

Primodan Food Machinery A/S
Oesterled 20-26
P O Box 177
DK-4300 Holbaek
Denmark

Master Mechanical Works Pvt Limited
Pushpanjali SV Road
Santa Cruz (W)
Bombay 400 054
India

Yunan General Machine Works
24 Dadi Lu
Duncheng Zheng
Yunan County
Guangdong Province
China

Bottle brushes

The Northern Media Supply Limited
Sainsbury Way
Hessle
HU13 9NX
United Kingdom

Narangs Corporation
25/90 Connaught Place
Below Madras Hotel
New Delhi 110 001
India

Rajan Universal Exports (MFRS) P Limited
Raj Buildings 162
Linghi
Chetty Street
P Bag No 250
Madras 600 001
India

Raylons Metal Works
Kondivitta Lane
Andheri-Kurla Road
Bombay 400 059
India

Panchal Workshop
P B No 62
Anand Sojitra Road
Anand 388 001
India

Raylons Metal Works
Kondivitta Lane
Andheri-Kurla Road
Bombay 400 059
India

FMC Corporation
Machinery International Div
P O Box 1178
San Jose
California 95108
USA

Master Mechanical Works Pvt Limited
Pushpanjali SV Road
Santa Cruz (W)
Bombay 400 054
India

technical brief

Packaging Foods in Glass

Intermediate Technology Development Group

Dairy Udyog
Ghatkopar Industrial Estate
LBS Marge
Ghatkopar
Bombay 400 086
India

Labelling machines

FMC Corporation
Machinery International Div
P O Box 1178
San Jose
California 95108
USA

J T Jagtiani
National House
Tulloch Road
Apollo Bunder
Bombay 400 039
India

Master Mechanical Works Pvt Limited
Pushpanjali SV Road
Santa Cruz (W)
Bombay 400 054
India

Narangs Corporation
25/90 Connaught Place
Below Madras Hotel
New Delhi 110 001
India

Acknowledgements

Some of the diagrams and text used in this technical brief come from a variety of sources. We would there like to thank the following for allowing us to reproduce: TOOL, ILO, ITDG and PRODEC.

technical brief