

PVMaT Improvements in the Manufacturing of the PVI Powergrid

**Final Technical Report
27 October 1997 — 31 October 1998**

N.R. Kaminar, T. Alexander, J. Amaya,
W.R. Bottenberg, P. Carrie, K. Chen, P. Hobden,
G. Lawyer, J. Zimmermann, and C. Sherring
Photovoltaics International, LLC (PVI)
Sunnyvale, California



NREL

National Renewable Energy Laboratory

1617 Cole Boulevard
Golden, Colorado 80401-3393

NREL is a U.S. Department of Energy Laboratory
Operated by Midwest Research Institute • Battelle • Bechtel

Contract No. DE-AC36-98-GO10337

PVMaT Improvements in the Manufacturing of the PVI Powergrid

**Final Technical Report
27 October 1997 — 31 October 1998**

N.R. Kaminar, T. Alexander, J. Amaya,
W.R. Bottenberg, P. Carrie, K. Chen, P. Hobden,
G. Lawyer, J. Zimmermann, and C. Sherring
Photovoltaics International, LLC (PVI)
Sunnyvale, California

NREL Technical Monitor: R.L. Mitchell

Prepared under Subcontract No. ZAF-6-14271-11



NREL

National Renewable Energy Laboratory

1617 Cole Boulevard
Golden, Colorado 80401-3393

NREL is a U.S. Department of Energy Laboratory
Operated by Midwest Research Institute • Battelle • Bechtel

Contract No. DE-AC36-98-GO10337

NOTICE

This report was prepared as an account of work sponsored by an agency of the United States government. Neither the United States government nor any agency thereof, nor any of their employees, makes any warranty, express or implied, or assumes any legal liability or responsibility for the accuracy, completeness, or usefulness of any information, apparatus, product, or process disclosed, or represents that its use would not infringe privately owned rights. Reference herein to any specific commercial product, process, or service by trade name, trademark, manufacturer, or otherwise does not necessarily constitute or imply its endorsement, recommendation, or favoring by the United States government or any agency thereof. The views and opinions of authors expressed herein do not necessarily state or reflect those of the United States government or any agency thereof.

Available to DOE and DOE contractors from:
Office of Scientific and Technical Information (OSTI)
P.O. Box 62
Oak Ridge, TN 37831
Prices available by calling 423-576-8401

Available to the public from:
National Technical Information Service (NTIS)
U.S. Department of Commerce
5285 Port Royal Road
Springfield, VA 22161
703-605-6000 or 800-553-6847
or
DOE Information Bridge
<http://www.doe.gov/bridge/home.html>



PREFACE

This is the Final Technical Progress Report for a three phase effort to improve the manufacturing of the PVI Powergrid concentrator. It covers the work done from October 27, 1995 to October 26, 1998 under DOE/NREL Subcontract #ZAF-6-14271-11.

The following personnel at PVI have significantly contributed to the efforts covered in this report.

Gary Allen, Clayton Briscoe, Joanie Bunch, Dennis Gilbert, Paul Guzman, Anthony Kilaita, Hrayr Malakian, Rick Nuessle, Dan Rodriques, Jim Sahagian, Bruce Shand

In addition, PVI has been supported by the following non-PVI personnel.

Phil Argebrite, Gordon Armstrong, Gerd Bode, Alex Dadiomov, Mike Davis, Dr. Chris Rauwendaal, Phil Rockwell, Aram Soghikian, Scott Unruh

SUMMARY

PVI is improving the manufacturing of the Powergrid™ under the PVMaT program in five basic areas.

Development of an advanced, state-of-the-art lens extrusion system

Development of an advanced, state-of-the-art module side extrusion system

Development of a second generation automated receiver assembly station

Development of low-cost roll-formed steel panel frame members

Development of an automated module assembly process with low usage of volatile organic compounds and hazardous materials

As conceived, Phase 1 of the PVI PVMaT program was basically a design phase, Phase 2 was basically an implementation phase, and Phase 3 was basically a demonstration phase.

Phase 1 effort was covered in Annual Technical Progress Report for Phase 1.

Phase 2 effort was covered in Annual Technical Progress Report for Phase II.

Phase 3 effort is covered in this report along with an overview of the entire program.

The results of the program were as follows:

- Manufacturing improvements have led to dramatic improvements in performance, quality durability, and cost
- The first ever EVA encapsulation system for photovoltaic concentrators was developed, thereby eliminating volatile organic compounds and hazardous materials in our encapsulation process
- An in-house extrusion system was developed that produces the highest quality extruded lenses ever obtained
- An advanced automated cell assembly station was developed that produces quality cell assemblies at low labor cost
- Solvents have been eliminated in the module assembly eliminating volatile organic compounds and hazardous materials
- Roll formed steel panel frame members have been introduced to production which have dramatically reduced cost
- A snap together module assembly has been developed that provides low-cost field assembly of components and thereby also greatly reduced shipping cost

The Powergrid has the potential to be very low cost in the short term. The PVI PVMaT program should allow PVI to reach the cost goals set by the company. This in turn will allow PVI to become a substantial player in the PV market and will allow the DOE goals of increased application of PV to become a reality.

TABLE OF CONTENTS

PREFACE.....	ii
SUMMARY.....	iii
TABLE OF CONTENTS.....	iv
LIST OF FIGURES.....	v
1.0 INTRODUCTION.....	1
2.0 BASELINE MANUFACTURING PROCESS.....	8
2.1 LENS EXTRUSION.....	8
2.2 MODULE SIDE EXTRUSION.....	9
2.3 RECEIVER ASSEMBLY.....	9
2.4 MODULE ASSEMBLY.....	10
2.4 FRAME MANUFACTURING.....	10
2.5 FINAL TESTING AND SHIPPING.....	10
2.6 SITE INSTALLATION.....	10
3.0 PVMaT PROGRAM EFFORTS.....	11
3.1 LENS EXTRUSION.....	11
3.2 CELL ASSEMBLY MANUFACTURING.....	31
3.3 EVA ENCAPSULATION.....	45
3.4 SOLVENTLESS ASSEMBLY.....	51
3.5 ROLL-FORMED STEEL PANEL FRAME.....	65
4.0 CONCLUSIONS.....	69

LIST OF FIGURES

Figure 1, New PVI Powergrid on PVI Roof.....	1
Figure 2, Powergrid 20" Module.....	4
Figure 3, Powergrid Panels on the Roof of the PVI Building.....	5
Figure 4, Module Sides with Reinforcing Features.....	6
Figure 5, Module End Caps, Bottom Outside and Top Inside.....	7
Figure 6, Extrusion Control System Block Diagram.....	14
Figure 7, Process Variability Over Time.....	15
Figure 8, PVI Extruder in Operation.....	17
Figure 9, Puller.....	19
Figure 10, Flying Cut-Off Saw.....	20
Figure 11, Finished Lenses.....	20
Figure 12, Lens End Re-Forming Machine.....	22
Figure 13, Re-Formed Lens End Cross Section.....	22
Figure 14, Material Drying Hopper.....	23
Figure 15, Lens Cold Shoes (three) With Lens Sagging Into Required Radius.....	25
Figure 16, Air Rack.....	25
Figure 17, Lens Profile.....	27
Figure 18, Module Response vs. Tracking Error.....	29
Figure 19, Module Response vs. Apparent Declination Angle.....	29
Figure 20, Apparent Declination On Module.....	30
Figure 21, Powergrid Cell Assembly.....	31
Figure 22, Lead Configuration.....	31
Figure 23, Solder Dispenser.....	35
Figure 24, Seiko Robot Arm.....	36
Figure 25, End Effector.....	37
Figure 26, Nests and Rotary Table.....	38
Figure 27, Nest Actuation System.....	39
Figure 28, Lead Forming Progressive Punch.....	40
Figure 29, Tape Dispenser.....	41
Figure 30, Computer Robot Control.....	42
Figure 31, Operator Interface on Computer Screen.....	43
Figure 32, Pull Strength.....	44
Figure 33, Early EVA Oven.....	46
Figure 34, Spectral Transmission of PVI Lens in the Ultraviolet Range.....	50
Figure 35, Joints at the Top of the Receiver.....	53
Figure 36, Lens to Module Side Joint.....	54
Figure 37, Rolling Machine for Rolling Sides.....	55
Figure 38, Rolled Aluminum Sides and Box of Sides.....	56
Figure 39, End Caps, Outside of Bottom and inside of Top.....	57
Figure 40, Tubbed Modules.....	58
Figure 41, Sample of Cosmos Finite element Analysis Program Output.....	60
Figure 42, Prototype Module Static Test.....	61
Figure 43, Wind Tunnel Powergrid Test Module.....	62
Figure 44, Outdoor Test of a Module.....	63
Figure 45, Rolled Frame Member.....	66

1.0 INTRODUCTION

The PVI Powergrid is a linear focus concentrator which uses low-cost components and manufacturing techniques that are intended to reduce the price of a photovoltaic system to a level required for broad level deployment of PV. The Powergrid uses a linear-focus Fresnel lens made by a plastic extrusion process, the lowest cost method of manufacturing. The Powergrid uses solar cells manufactured using the low-cost methods used for one-sun cells. Twelve modules are mounted on a stationary panel frame to move in unison for single-axis tracking, see Figure 1.



Figure 1, New PVI Powergrid on PVI Roof

1.1 PROJECT OVERVIEW

The NREL PVMaT program at PVI focuses on four areas that were identified to be critical to our low-cost manufacturing:

1. Lens and side manufacturing
2. Receiver assembly
3. Module assembly
4. Frame manufacturing

Lens extrusion is a core part of our manufacturing. We identified the plastic extrusion process to be the lowest cost method to manufacture linear Fresnel lenses. The PVMaT program brought this process in-house to enable PVI to make quality lenses, unobtainable from contract extruders using standard equipment. Under the PVMaT program, PVI developed an advanced extrusion system and installed this system in our facility. PVI is now capable of extruding lenses with optical transmission approaching that of high-quality cast lenses, at a fraction of the cost.

Receiver assembly has also been identified as a critical manufacturing process. Manual soldering is the most labor intensive process in manufacturing the PVI Powergrid module. Under the PVMaT program, PVI developed a second-generation automated receiver assembly station. The station solders the cell leads to the cell. The PVMaT program enabled PVI to significantly reduce the cost of this process while improving the quality of the solder joints.

Under the PVMaT program, PVI eliminated the volatile organic compounds emitted and hazardous materials used in the manufacture of our modules. Volatile organic compounds and hazardous materials significantly add to the financial and environmental cost of the product.

Frame manufacturing was also identified as a high-cost process. Under the PVMaT program, PVI switched from an extruded aluminum frame to a low-cost steel frame, manufactured using low-cost roll-forming.

The PVI PVMaT program has been very successful. We met every milestone and deliverable in the contract and have succeeded in halving the cost of our product. Our manufacturing processes have been vastly improved. We anticipate increasing sales of the new Powergrid over the coming years.

1.2 PVMAT PROJECT GUIDELINES AND TASKS

The PVI PVMaT program was in three phases: design, implement, and demonstrate, each phase taking one year. The tasks under the three phases were as follows:

Phase I

- Task 1 Development of High-volume Lens Extrusion Manufacturing Technology with Flying Cutoff
- Task 2 Development of High-volume Module Side Extrusion Manufacturing Technology with Flying Cutoff
- Task 3 Design of Automated Parallel Receiver Assembly Station

- Task 4 Design and Specification of Roll Forming Equipment for Panel Frame Member Manufacturing
- Task 5 Design and Specification of Automated Solventless Bonding of Collector Components

Phase II

- Task 6 Continued Development of Lens Roll-Forming Post-extrusion Tooling
- Task 7 Continued Development, Installation and Testing of Automated Parallel Receiver Assembly Station
- Task 8 Continued Development, Installation and Testing of Roll Forming Machine for Panel Frame Member Manufacturing
- Task 9 Continued Development, Installation of High-volume Automated Solventless Bonding Equipment

Phase III

- Task 10 Continued Development of Closed-Loop Process Control for Lens Extrusion
- Task 11 Continued Development of Closed-Loop Process Control for Module Side Extrusion
- Task 12 One-month Demonstration of 50 MW/yr Production Rate

The PVMaT tasks were designed to satisfy basic guidelines as follows:

- Concentrate on essential manufacturing areas
- Reduce manufacturing costs to meet the DOE goals
- Remain flexible to new developments during the project
- Put in place high-volume equipment and procedures
- Demonstrate successful completion

1.3 THE PVI POWERGRID 2000 LINEAR FOCUS, FRESNEL LENS CONCENTRATOR

The new PVI Powergrid incorporates the following features:

- Linear-focus extruded-acrylic Fresnel lens
- Rolled aluminum module sides
- Reflective skirts for improved on- and off-axis performance
- Die-cast, single-piece, recycled aluminum end caps
- Pivoting modules that are ganged together and mounted on a stationary frame for single-axis tracking
- Passive cooling using an extruded aluminum heat sink
- Solar cells manufactured using low-cost techniques
- Low concentration (approximately 10 to 1)

The low concentration design was pioneered by PVI. It enables the use of extruded lenses, low-cost cells, single-axis tracking, and low-tolerance manufacturing and assembly techniques. PVI believes that this approach leads to the lowest cost PV-generated power using technology available today. With low concentration, the acceptance angle is wide, leading to a lower cost tracking system and wider acceptable tolerances in manufacturing. Also, low concentration enables the efficient use of extruded lens.

The module is 20 inches wide and 13 feet long, see Figure 2. Twelve modules are mounted on a stationary frame that is 40 feet long, see Figure 3. The modules are spaced 40 inches apart. The tilt angle of the frame is set to the local latitude, facing toward the equator. The modules rotate east to west to follow the sun. They stow at night and under dark clouds with the lenses facing up. The tracker can be powered by external sources or by the panel itself by using diffuse radiation until the direct beam is acquired.

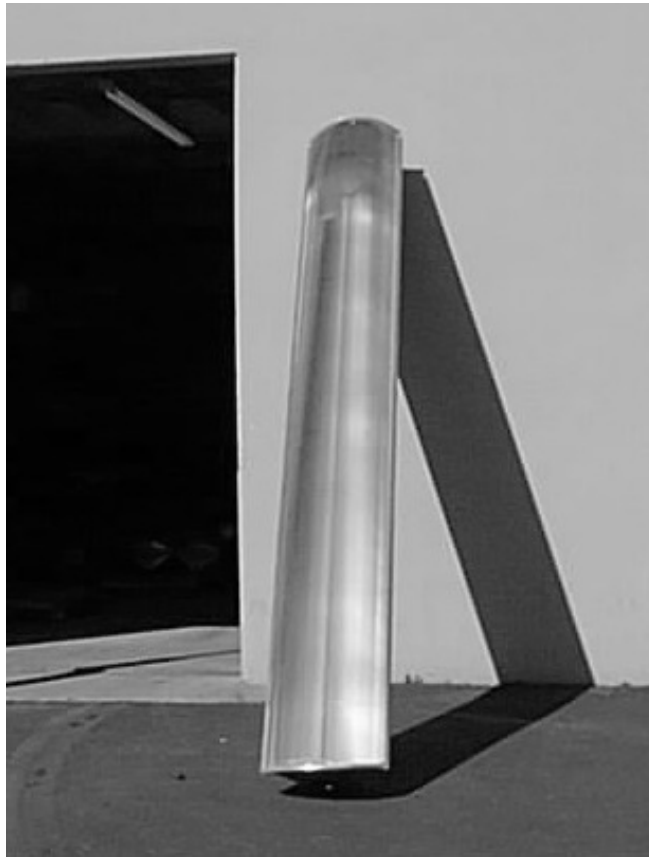

Figure 2, Powergrid 20" Module



Figure 3, Powergrid Panel on the Roof of the PVI Building

The extruded lens is arched to a constant radius and is smooth on the outside. The facets are on the inside and are flat (not curved). They are approximately 0.15 inch wide and from zero to 0.15 inch tall. The base thickness is approximately 0.08 inch. Prototype lenses are extruded from 100% polymethyl methacrylate (PMMA) (acrylic) with lubricants added, but production lenses can have up to 20% impact modifier in them. The lenses are held to the module sides using aluminum clips.

The module sides are made from aluminum using roll forming, see Figure 4. Strengthening ribs are rolled into the sides to provide added stiffness. The sides have a feature that allows them to be joined to the receiver in a snap action. This allows factory or field assembly of the module sides to the receiver without tools. The aluminum sides also improve the heat dissipation of the module by conducting heat away from the receiver and transferring this heat to the surrounding air.

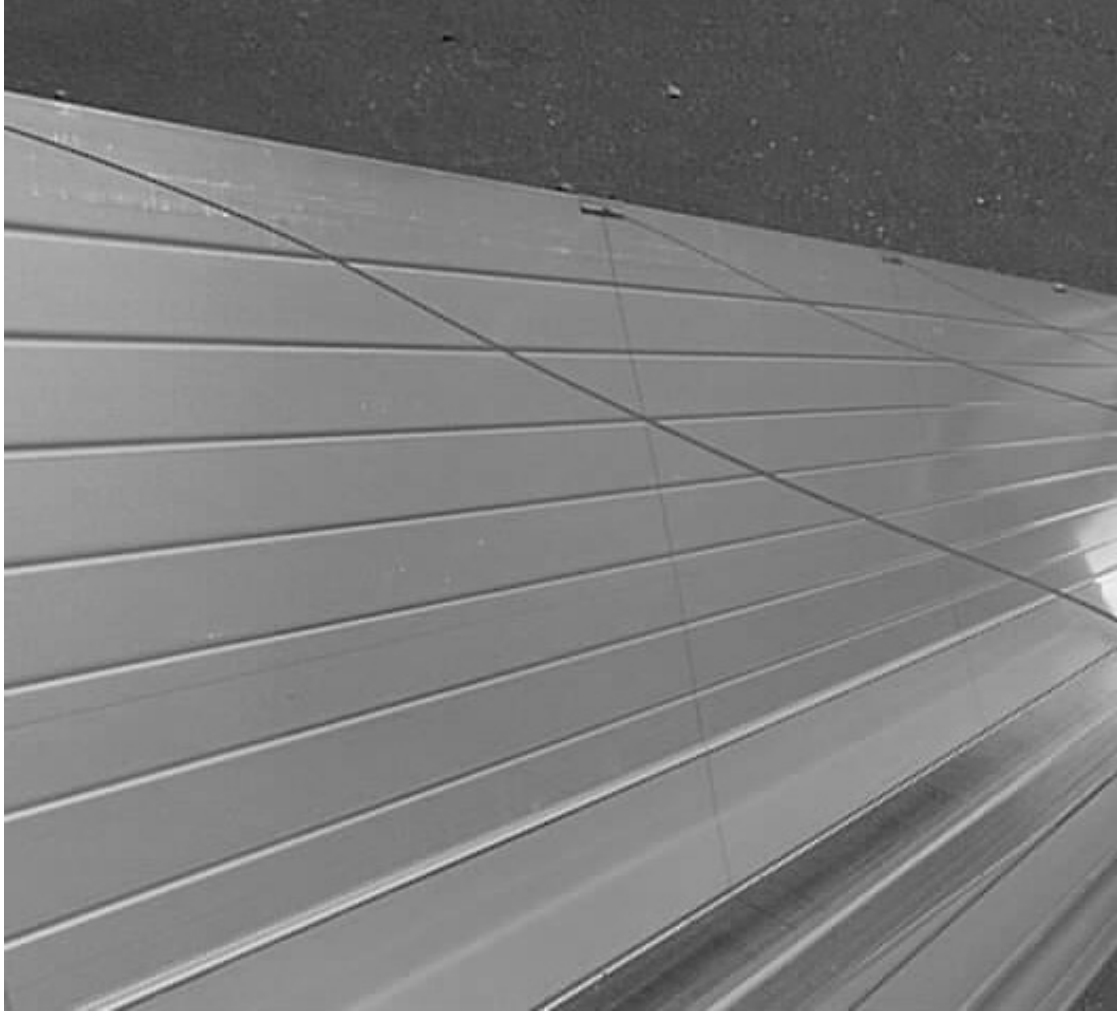

Figure 4, Module Sides with Reinforcing Features

PVI has changed from the previous plastic sides to aluminum sides to reduce cost, add strength, add stiffness, improve heat dissipation, and eliminate warpage. Further, replacing the plastic sides eliminates the volatile organic compounds and hazardous materials associated with the adhesives used in the previous assembly technique. Although plastic is lower cost than aluminum, the overall cost of the module is reduced when aluminum sides are used by eliminating extra structural components required by the plastic sides.

The one-piece end cap is die-cast from recycled aluminum, see Figure 5. A pivot bearing and tracking pin are inserted into the top end cap. A pivot bearing, a clean out plug, and four drain valves are inserted into the bottom end cap. The appropriate holes are selectively cast into the top and bottom end caps by adding or removing inserts in the mold. The module is supported by the plastic pivot bearings that are designed to accommodate any misalignment. The tracking pins connect to a tracker drag link and are adjustable to allow individual alignment of each module.

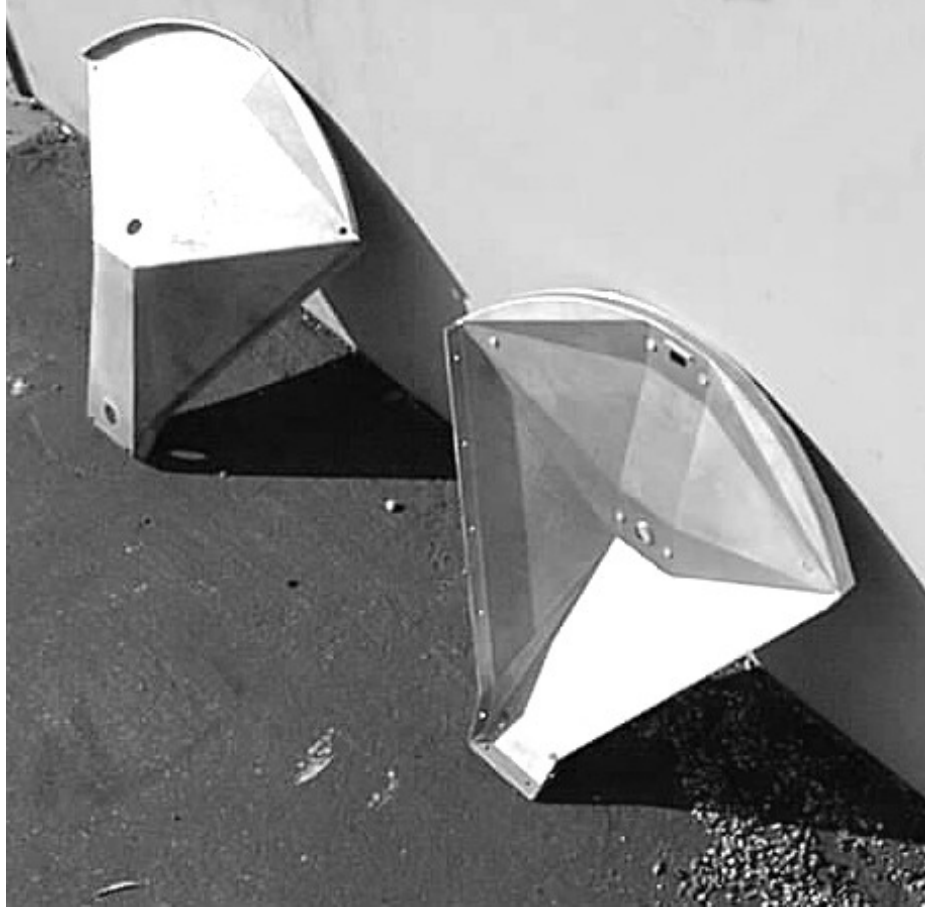

Figure 5, Module End Caps, Bottom Outside and Top Inside

The new end caps eliminate several parts used in the previous pivot brackets, thus significantly reducing cost. They also are much stiffer and stronger than the previous design. Assembly of the end caps to the module sides and receiver is accomplished using self-tapping screws. The new end caps can be assembled in the factory or in the field using simple tools.

The new panel frame consists of rolled galvanized steel members. The frame is assembled using galvanized steel joiners and self tapping screws. Rolled galvanized steel members are also used for the rear legs. The angle of the frame is fixed by the length of the legs. The angle can be adjusted for different latitudes, or peak output for different times of the year, by substituting legs of different lengths. Hand-crank or automatic adjustable tilt options are planned for the future. The new panel frame is anchored in eight places, four in the front and four in the rear, which is twice the number of anchors used in the previous panel. The increase in anchors allows lower-cost members and foundations. This more than compensates for the increased numbers of anchors. In addition, the doubled anchors allows the use of a half panel in applications that only require 1 kilowatt output.

The anchoring for the panel depends on the site. For roof sites, we have used structural elements that tie into the building frame and are then waterproofed using standard roofing technology, similar to other roof penetrations. For ground mounted systems, we have used cast-in-place concrete piers with galvanized steel bolts cast into them, and we have also used

screw anchors. Screw anchors are twisted into the ground like wood screws. They are used in the construction and utility industries for such things as building foundations and guy wires for utility poles. The screw anchor is installed using a hydraulic motor mounted on a tractor and leaves a galvanized bolt sticking out of the ground to which the panel frame is bolted.

The tracker consists of a direct-current gear motor controlled by a digital circuit. An active sensor controls the tracker drive. The sensor contains two infrared photocells that are shadowed by a shadow-bar. When the output of the photocells is equal, the panel is on track. Sensing the sun's infrared output is used to remove the effect of clouds. The tracker moves the panel to the stow position, (lenses facing up), when the overall light level falls below a threshold, such as at night or under dark clouds. When the tracker is powered by the panel, and when there are panels wired in series so that the panel is operating at a high voltage, a direct-current to direct-current converter is used to isolate the tracker electronics and gear motor. The programmable digital circuit allows easy changes to the tracker operation. For example the stow threshold can be set by changing the constants of the programmable read-only-memory chip.

1.4 KEY RESULTS

- Reduction by half in the manufacturing cost for the PVI Powergrid
- Dramatic improvement in the output and quality of the product
- In-house production extrusion of quality lenses
- Elimination of volatile organic compounds and hazardous materials in module manufacturing
- Development and deployment of a second generation automated cell assembly station
- Development of lower cost frame manufacturing

2.0 BASELINE MANUFACTURING PROCESS AND RATIONALE FOR THE IMPROVEMENTS

This section describes the manufacturing technologies in place at the start of the PVI PVMaT program and the problems associated with these technologies. It also describes the logic for improvements being done.

2.1 LENS EXTRUSION

At the beginning of the PVI PVMaT program, lens extrusion was done at an outside company that specialized in custom profile extrusion of acrylic parts. PVI carried out the lens design which was then given to the extrusion company as a computer file.

Accurate measurements and control of the extrusion parameters is absolutely necessary to obtain high efficiency extruded lenses. The normal instrumentation and controls found on commercial extruders are fine for most industrial extrusion parts but are not sophisticated enough for the high quality lens we require.

A major problem with the previous die design was that changes took too long. Modifications to the lens die required cooling down the entire assembly, disassembling it, and machining of the die, which often took several weeks. With the tooling developed by PVI for use in-house, turn around times for changes have been reduced to a matter of hours.

The problems experienced in the past could only really be solved by bringing the extrusion process in house. PVI has acquired the expertise, through years of experience with the former suppliers, by hiring qualified individuals, and by hiring expert consultants, to design an extrusion system capable of making the needed accurate lenses.

2.2 MODULE SIDE EXTRUSION

Similar problems to the extruded lens development were experienced with the extruded module sides. Although optical transmission is not one of the required properties for the module sides, accurate forming of the sides does influence the module output. Because of all the reasons described above, the only real path to extrusion of accurate module sides was to bring the extrusion process in house.

It was discovered through the course of the PVMaT program, that there were inherent problems with extruding plastic sides. The extrusion process builds in internal stresses into the plastic. These stresses make it difficult to make flat sides. Even if flat sides were obtained, the built-in stresses would relax which make the sides warp after the modules were in service for some time. In addition, the plastic sides were found to require additional structural support, that adds to the manufacturing cost and complexity. One additional problem with plastic sides is that they are flammable, so that in the unlikely event that the receivers got extremely hot, for instance if there was a short to ground and a bypass diode failure, the sides could catch fire. The rolled aluminum sides eliminate all these problems and have the additional advantage of improving heat dissipation.

2.3 RECEIVER ASSEMBLY

The first version of the automated receiver assembly station, built before the PVI PVMaT program, attempted to assemble the cells in-situ on the heat sink. The major problem with this machine was the quality of the soldering. Soldering on a heat sink was difficult because of the heat dissipating properties of the heat sink. The rate of heat transfer to the heat sink depended on the bond in the pressure sensitive adhesive used to join the cell to the heat sink. This bond was variable depending on a number of factors. Further, we found that the mechanics of the station itself were unreliable. Although the mechanical problems could have been fixed, the basic concept of in-situ soldering was flawed.

To eliminate the unreliable performance of the first automatic receiver assembly station, manual soldering and receiver assembly was adopted. This added extensive labor in receiver assembly and made this part of the Powergrid manufacturing the most expensive part.

A second generation automated receiver assembly station was required to eliminate hand soldering and the associated labor cost. Also, the new automated station would have to provide quality solder joints without performance degradation.

At the beginning of this program, receivers were encapsulated with a silicone material. This material contained considerable quantities of volatile organic compounds and was a hazardous material. We used a custom hood to evacuate the fumes from the encapsulation process. The silicone material was also very expensive. In the past we had used a tape encapsulation system, but this proved to be unsatisfactory due to voids and trapped air.

A better encapsulation system was needed. This encapsulation system would have to be low-cost, trouble free, and not contain volatile organic compounds and hazardous materials.

2.4 MODULE ASSEMBLY

Modules were assembled in a fixture using solvent adhesives. These adhesives also contained considerable quantities of volatile organic compounds and were hazardous materials. Some of the adhesives proved to not be stable under ultraviolet light.

The module sides were joined to the receiver using a crimp type joint. This process was difficult and the resultant joints were not reliable. Special tools were needed. Because of the special tools and equipment needed, the module could not practically be assembled in the field. Better joining methods were needed that did not require special tools, did not use solvent adhesives, and that could be assembled easily in the factory or in the field.

2.5 FRAME MANUFACTURING

The PVI Powergrid is sold as a complete direct-current power supply system, including the frame and electrical wiring. The previous manufacturing method for the frame members was expensive. The frame members were custom extruded aluminum tubes. Because of the supported length of the frame members, additional brackets and structural elements were needed, trebling the part count. The old frame was expensive to manufacture and assemble. A lower cost frame assembly was needed.

2.6 FINAL TESTING AND SHIPPING

Final testing of assembled modules has always been done outdoors. This is due to the requirement for highly collimated light source to properly characterize module output. The modules were then placed in wooden shipping containers to be trucked to the installation site. The frame members and miscellaneous parts are shipped in a separate container. Final testing is presently limited to sunny days. Also, shipping is expensive because of the volume of the completed modules.

Some way to characterize module output using an indoor test facility was needed. A better shipping technique was also needed, one where modules could be shipped broken down so that they took up less volume.

2.7 SITE INSTALLATION

The panels have always been erected on site. The frames were assembled on the ground or saw horses and then tilted to the proper angle. The frames were shipped with most of the internal wiring installed. A minor amount of field hookup was required for the wiring inside the frames, which was done when the frames were assembled. After the frame was in place,

the modules were added and connected. The tracker was then installed and the system was ready to be used. Any wiring from the panel to the point of use was installed after the panels were in place. No basic changes to this procedure were contemplated under the PVI PVMaT program.

3.0 PVMAT PROGRAM EFFORTS

This section describes the effort expended under the PVI PVMaT program.

3.1 LENS EXTRUSION

Overview

Under the PVI PVMaT program, PVI developed a state-of-the-art extrusion system dedicated to lens manufacturing. The extrusion system needed for quality lenses could not be bought off-the-shelf. We designed our own extrusion system with the help of several outside consultants and contractors. The design brought together components from various sources and also original equipment made specifically for this system. The PVI extrusion system pushed the state-of-the-art for profile extrusion and lens manufacturing and incorporated some never before tried concepts. To get a head start, initial development of some of the components was done off-site at an established profile extrusion house. We then installed our system at PVI. After the equipment was installed development continued. Lens quality steadily improved and at the end of the PVI PVMaT program, production runs of lenses with over 86% transmission were obtained

Rationale

Initial lens production at PVI was done out-of-house at contract profile extrusion companies. This presented several difficulties. For one thing, the equipment available was not capable of manufacturing quality lenses. Also, the extrusion companies were geared towards production runs and not development. The development work that we needed to do was not profitable for them. Delays of several months between tests was common. However, there was a positive result in that PVI gained valuable experience about the extrusion process and equipment.

The decision to develop our own system was based in part on input from Dr. Chris Rauwendaal, a renowned extrusion consultant, who we hired at the beginning of the PVI PVMaT program. We initially considered purchasing a used extrusion system and then modifying it for our purposes. Dr. Rauwendaal pointed out that the used system, or even a new off-the-shelf system would not suit our purposes. With the custom system, we were able to design exactly what was required and save valuable time that would have been spent redesigning and reworking a non-custom system.

To help design the new extrusion system, PVI hired Fermentation Engineering, a small firm that specializes in the development of custom extrusion systems for the medical industry. An example of an extruded medical device is catheter tubes. These tubes have to be extruded to exacting dimensions and standards and even with varying compositions throughout the length so that a soft portion can be fed into an artery while the stiff portion is being held by the medical technician. The medical extruders are computer controlled which is the only way to

get the required accuracy. We decided to adopt computer control for our extruder to enable us to obtain our required quality.

Features

Our extrusion system has the following features:

- Computer control with integral data acquisition, logging, and display
- Graphic user interface
- Proportional power to heaters and fans
- 75 horsepower stepper motor with variable frequency power supply for the screw
- Custom screw and barrel designed for acrylic plastic
- Custom tractor type puller with stepper motor and variable frequency power supply
- Custom flying cutoff saw with capability of angle cuts of two different angles
- On-line lens end re-forming
- Vacuum material handling system with 5,000-pound desiccant drying hopper
- Regrinder capable of grinding full length lenses
- On-line optical testing of the lenses
- Air cooling-rack with cold-shoe after-formers
- Automatic part take off
- Unique manifold and die system

Advantages

These features, which are discussed in detail below, give the PVI extrusion system the following advantages:

- Computer control allows custom control algorithms to be used, convenient single point interface, integral data acquisition and logging, real time and historic data display, and automatic feedback tuning.
- The graphic user interface provides ease of use by the operator.
- The proportional power to heaters and fans eliminates temperature cycling that is characteristic of on-off type controls.
- The 75 horsepower stepper motor with variable frequency power supply provides constant screw speed regardless of load, temperature, or speed setting.
- The screw and barrel design are optimized for lens production from acrylic.
- The tractor type puller provides consistent grip, and the stepper motor and variable frequency power supply provide constant speed regardless of load or line speed.
- The flying cutoff saw cuts the two different bevel cuts in the lens without disrupting the line.
- The lens end re-forming machine provides interchangeable, stronger lenses
- Our material handling system is capable of keeping 8 hours of material available at a constant temperature of 150°F and dried to a dew point of -70°F, thus eliminating any problems associated with moisture in the material.

- The regrinder allows us to utilize all material without appreciable waste.
- The on-line optical testing of the lenses is crucial to manufacturing quality lenses and is a PVI exclusive.
- The cold-shoes and air rack allow us to use a straight die to produce a curved lens thus allowing our unique manifold and die system and accurate control of lens radius.
- The automatic part takeoff system was designed to automatically store up to five lenses in queue, waiting for the operator to remove them, thus freeing up the operator to run the machine.
- The unique manifold and die system allows on-line adjustment, uniform material distribution, and easy changing and modification of the die.

Detailed system description

Extrusion Computer Control System

The most important feature of the PVI extruder is the sophisticated control system. Without this advanced system, extruding quality lenses and sides would be impossible. A block diagram of the control system is shown in Figure 6. The heart of the system is an industrial quality personal computer. It is powered by an uninterruptable power supply to assure control of the extruder at all times. The computer runs several programs concurrently, acquiring information from various sensors, and controlling various pieces of equipment. There is an additional computer which is off to the side that concurrently runs lower level control programs. These programs are under control of the main computer. In addition, there are microprocessor based blocks at various places that have immediate control over specific items, such as heaters. There are similar blocks that acquire information from sensors and send that information to the main computer. In addition, there are autonomous control systems for peripheral equipment such as the material handling system and the chiller. These autonomous control systems report their status to the main computer. If there is a problem with any of the peripheral equipment, the main computer will warn the operator.

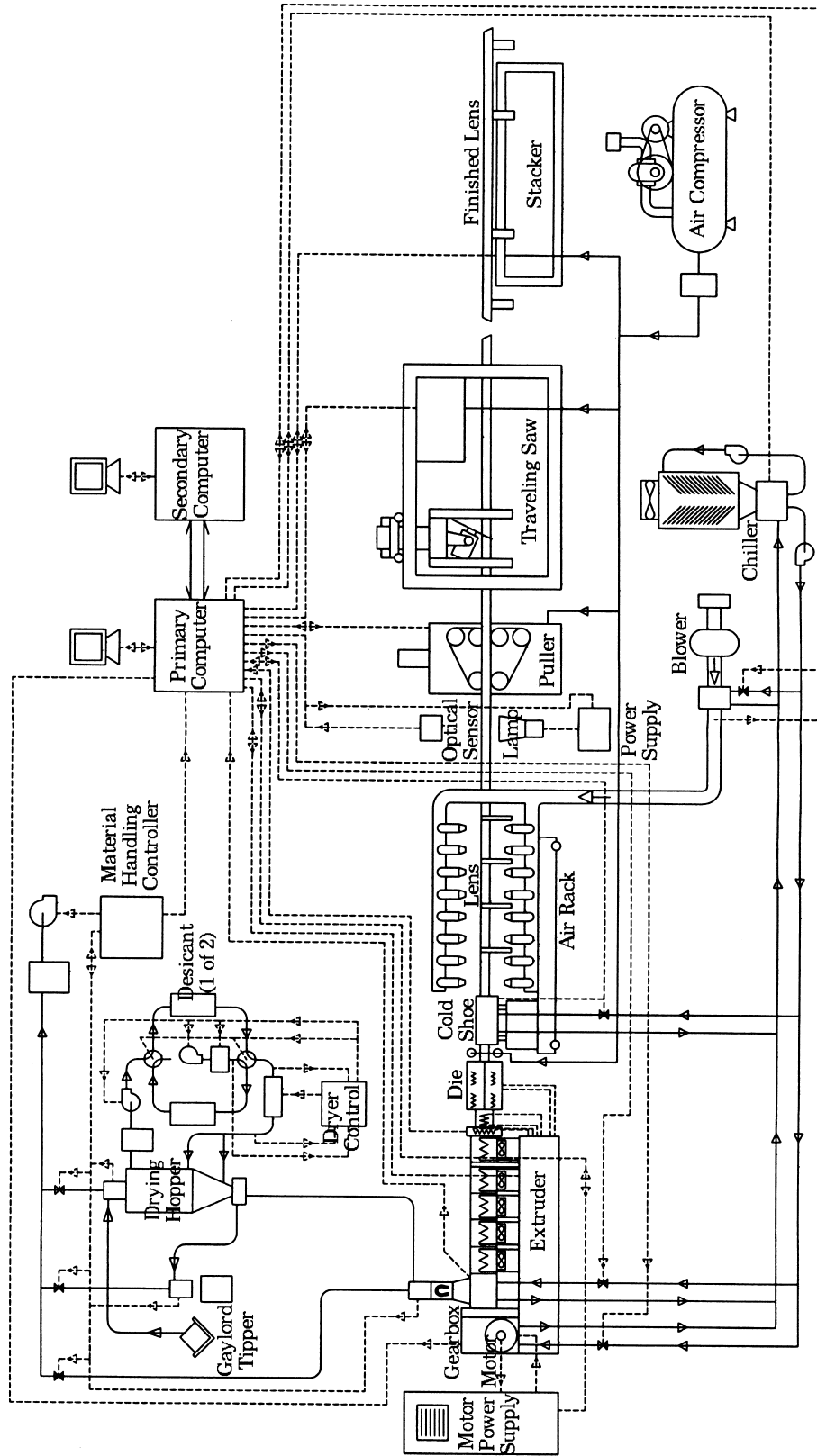

Figure 6, Extrusion Control System Block Diagram

The computer uses control algorithms that are designed for stable steady-state operation. As new algorithms are developed, the system can be updated. The computer system handles the tasks of data acquisition, logging, display, and analysis; variable display, adjustment, storage, and retrieval; various control programs; fault analysis; and graphic user interface.

Set points and process variables are recorded at regular intervals set by the operator so that a record of cause and effect can be reviewed by the operator. These data are stored on the main computer hard disk. The change in set points and process variables over time can be seen using one of the graphical window displays, see Figure 7.

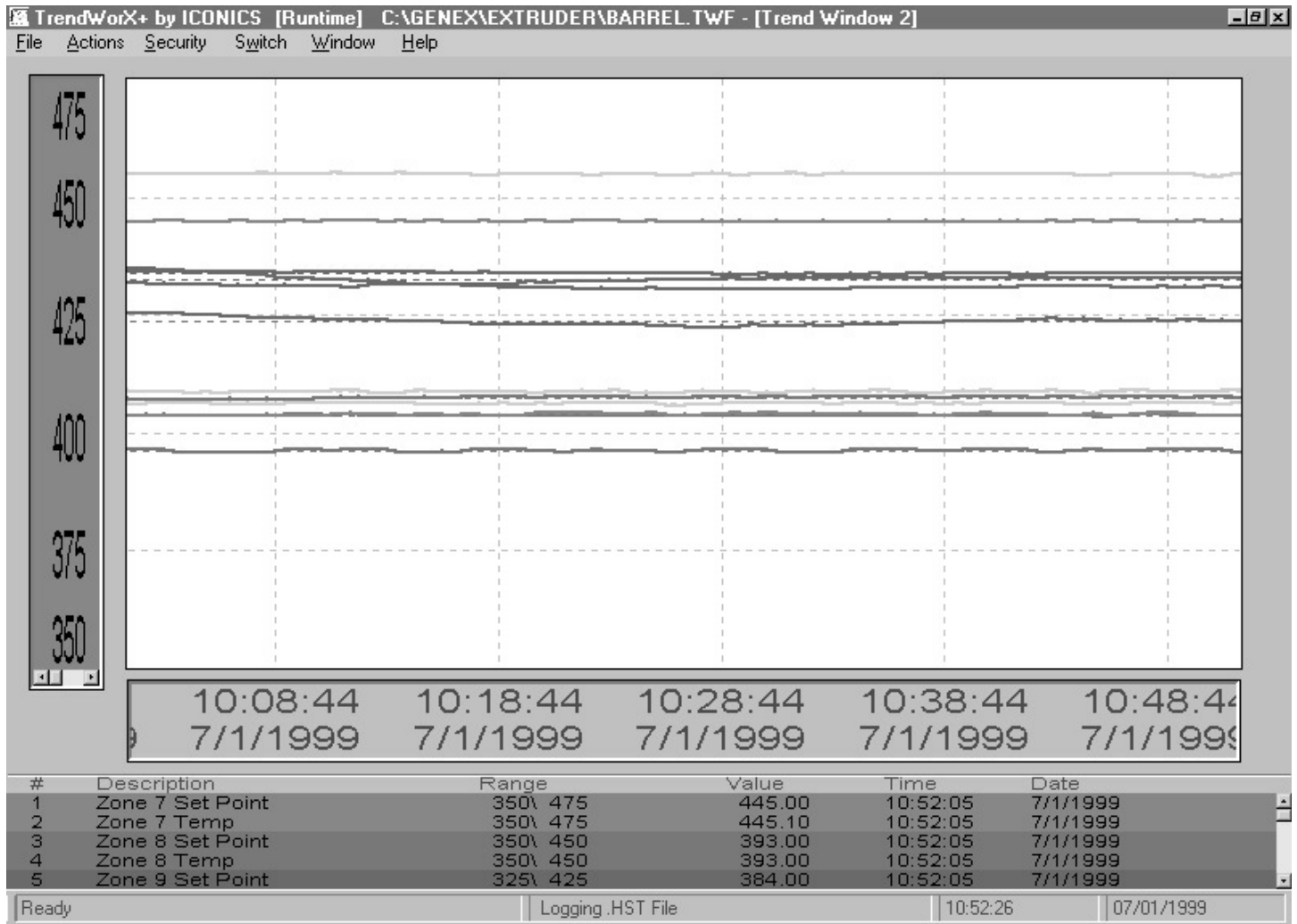

Figure 7, Process Variability Over Time

We plan to add automatic feedback to the extrusion system at some time in the future. The system was designed to accommodate this feature. It will automatically adjust the set points for certain key parameters based on lens performance. For now, the operator is in this loop and adjusts parameters to obtain the highest lens transmission.

Graphics user interface

The system uses a graphical interface. Data is displayed on various windows that represent different aspects of the system. The "Extruder" window displays a graphical representation of the extruder with set points and process variables shown at their appropriate locations. The "Die" window shows set points and process variables for the die and manifold. A "Traveling Saw" window shows variables for the saw. There are also windows that graph certain process variables over time so that the effect of changes can be seen. There are also various windows for overhead functions such as file handling and setup.

In each control window where set points and process variables are displayed, the operator can change the set point variable by typing in a number or using scroll arrows. The display will also show the amount of current going into a heater to raise a temperature. If there is a problem with the heater, or cooling fan, the process variable will not follow the set point and the display will also indicate the fault by using a different color for that zone.

Proportional power to heaters and fans

A common control system used on commercial extruders is the on-off type where power to the heaters, or fans, is either on or off. This works acceptably for non-critical profiles because of the large thermal mass, but for lenses the temperature fluctuations over several seconds can cause regular, periodic changes in the optical transmission and physical dimensions. For this reason, we use proportional power to the heaters and fans. This means that the power is smoothly varied from low to high depending on the need. At constant steady-state operation, the power is unvarying, eliminating any fluctuations in the lens. Proportional power is accomplished through phase-angle-firing of silicon-controlled-rectifiers, similar to a typical dimmer switch used to control a light bulb.

Stepper motor screw drive

Melting of the plastic is done by friction in the screw and the motor supplies the power for this work. Typical commercial extruders use DC motors or AC motors with variable frequency power supplies. The DC motor does not hold its speed with different loads. The AC motor is better but still can slip, causing the speed to vary. To assure absolute steady screw speed, we use a stepper motor.

A large, 75 horsepower stepper motor drives the screw through a large worm gear transmission. The stepper motor is powered by a variable frequency power supply. The rotational speed of the motor is sensed by an encoder on the motor.

This system gives several advantages. Speed control is very accurate. There is no slippage in the rotating magnetic field and the motor rotor: the motor turns at the exact speed determined by the variable frequency power supply. Also, the torque is not a function of rotational speed: maximum torque is available at zero speed.

The transmission oil temperature is monitored and displayed on the computer screen. The transmission oil temperature is controlled by the computer using a heat exchanger and chilled recirculating water.

The motor torque and speed are also displayed. There are two modes of operation. The operator can set the speed of the screw or set the extrudate pressure and have the screw speed vary automatically to keep the pressure constant. We normally run with a constant screw speed and with the automatic-speed, constant-pressure function disabled.

Extruder screw and barrel

A custom barrel and screw were designed and installed on a custom machine base, see Figure 8. They were designed specifically for extruding acrylic without variation in extrudate pressure and/or temperature, called surging. The screw includes two mixing sections to assure uniform material temperature. This 3.5-inch diameter screw was designed to deliver 500 pounds of extrudate per hour at 1,500 psi. It is 10 feet in length. The compression ratio of the screw was carefully chosen to eliminate surging.

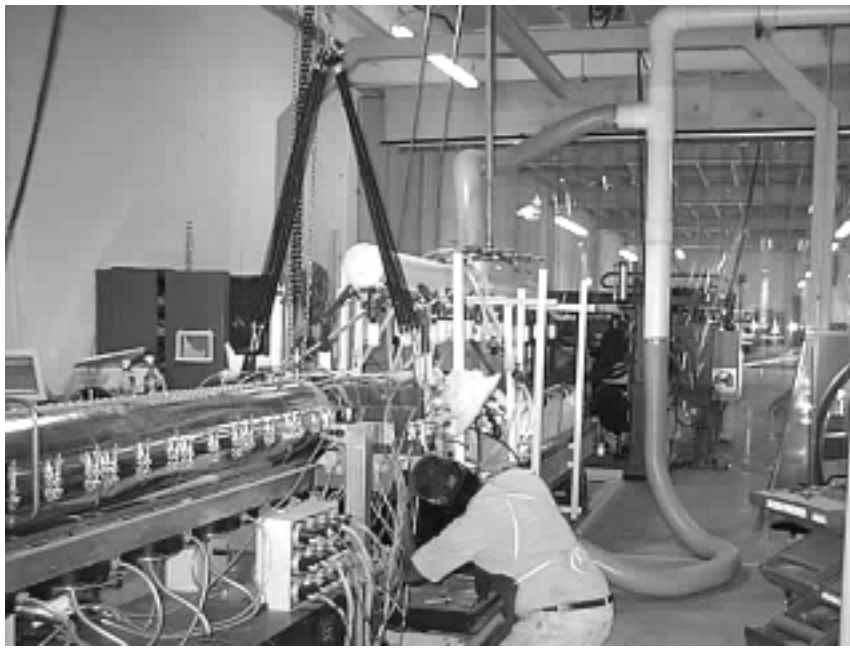

Figure 8, PVI Extruder in Operation

The barrel has six temperature zones. Each zone has an electric heater and a cooling fan. Temperatures of each zone are sensed with resistance temperature devices (RTDs). When the screw is stopped, the heaters are used to bring the barrel up to operating temperature. In operation, the fans remove excess heat generated in the screw by friction in the plastic. The barrel has a hopper at one end that is fed by the material handling system. A magnet trap in the hopper removes tramp iron that may come through the system. A guillotine type valve shuts off the material flow to allow the system to be shut down. The hopper temperature is sensed by an RTD and controlled by recirculating chilled water to control the temperature of the plastic pellets as they enter the barrel.

An adapter is mounted on the other end of the barrel. The die manifold is joined to this adapter using a clamp. The temperature of the clamp is maintained by a series of cartridge heaters and sensed by RTDs. A disk with a series of holes drilled in it, called a breaker plate, is clamped between the end of the barrel and the die manifold. The breaker plate supports a

number of steel screens up stream, called a screen pack. The screen pack and breaker plate trap any foreign particles and also add back pressure to the outlet of the screw. The screw needs back pressure to operate effectively. The pressure and temperature of the extrudate is measured upstream and downstream of the breaker plate.

Puller

The puller is an important part of the extrusion system. It has to be accurate and not slip. We designed a tractor type puller which is in contact with the extruded part for several feet rather than a point contact that would be the case with the more common wheel type puller, see Figure 9. The puller has a stepper motor and variable-frequency power supply which gives very accurate control over the speed range and constant torque regardless of speed. The puller is controlled from the main computer console. A pneumatic actuator allows the puller to be opened for startup and allows adjustment of the pinch force.

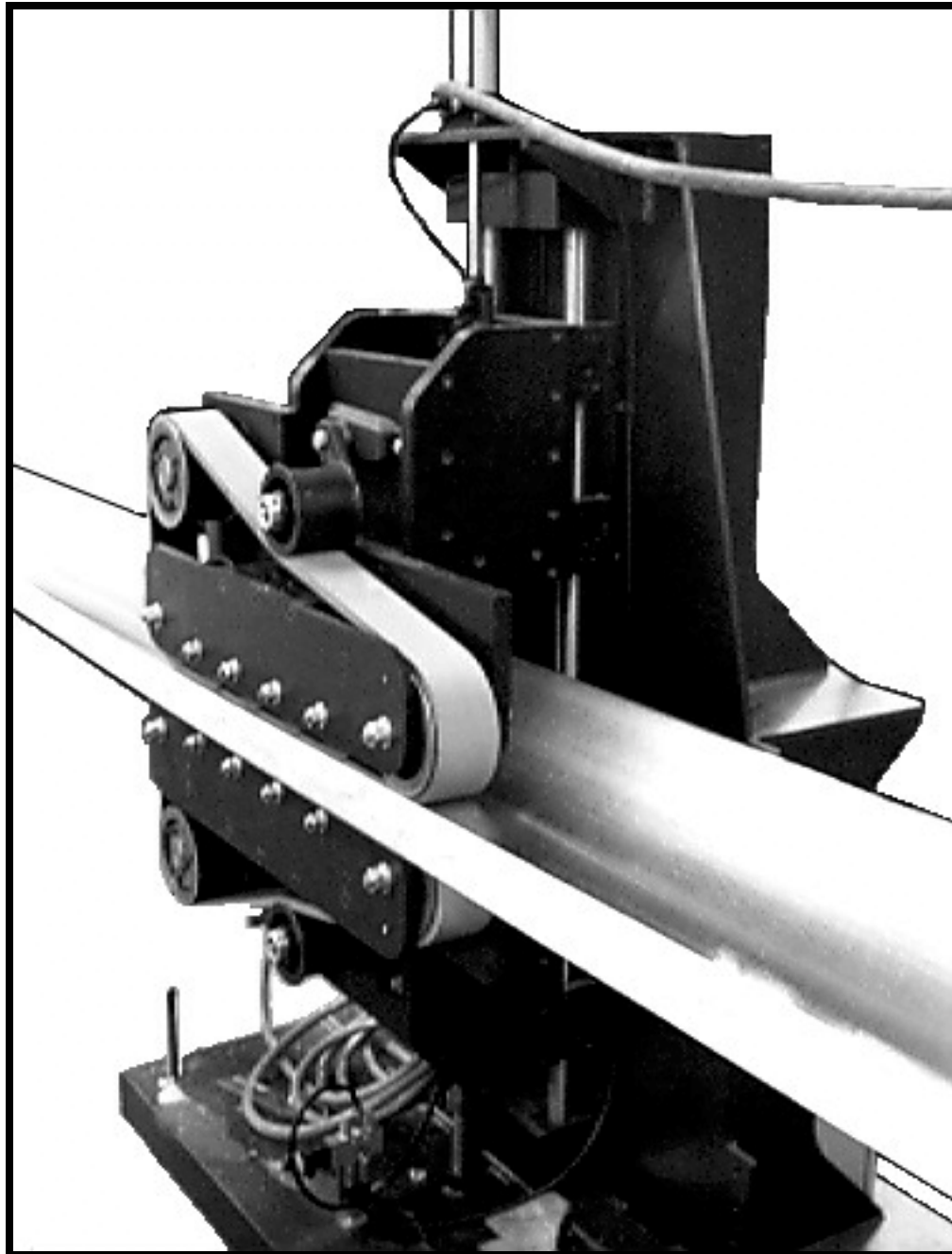

Figure 9, Puller

Flying Cut-off Saw

The flying cut-off saw allows the parts to be cut to length on the fly, see Figure 10. The computer determines when the part is to be cut based on the part length set by the operator. The saw blade and clamps then synchronize their speed with the part. The part is then clamped and sawed. The lens is sawed twice to provide the required angles at the ends. After sawing is completed, the part is unclamped and the saw blade moves back to its home position.



Figure 10, Flying Cut-Off Saw

We are able to cut the parts to their final length using the saw. We use a blade with a large number of carbide teeth and cut at a slow rate to minimize the number of micro cracks. A finished lens is shown in Figure 11.



Figure 11, Finished Lenses

On-line lens end re-forming machine

During the course of the PVI PVMaT program we switched to die-cast aluminum end caps as a cost saving measure, and to improve overall module strength. An alternative method to fasten the lens to the end cap was developed, since we no longer were using an adhesive. The fastening system depends on forming the ends of the lenses to an exact shape so that an edge sealant could be used and so that accurate mating to the end cap was assured. To achieve the desired forms for the ends of the lenses, PVI developed a secondary molding process and machine that was placed on the end of the extrusion line.

The lens end forming machine uses infrared lamps to heat the ends of the lens. When the acrylic is plastic, a die molds the ends of the lens to a precise shape, see Figure 12. The infrared lamps heat the bulk of the material and not just the surface. The molding imparts a groove for the butyl rubber used for sealing, and a lip for locating the lens on the end cap, see Figure 13. The sides of the lens are held in proper position by the machine so that the molding provides consistent ends. The machine also trims the end of the lens at the same time. The acrylic is rubbery when hot and can be sheared like pie dough. The machine uses a set of shears. No micro cracks develop when the acrylic is sheared while hot, and the micro cracks generated in the sawing process are removed.

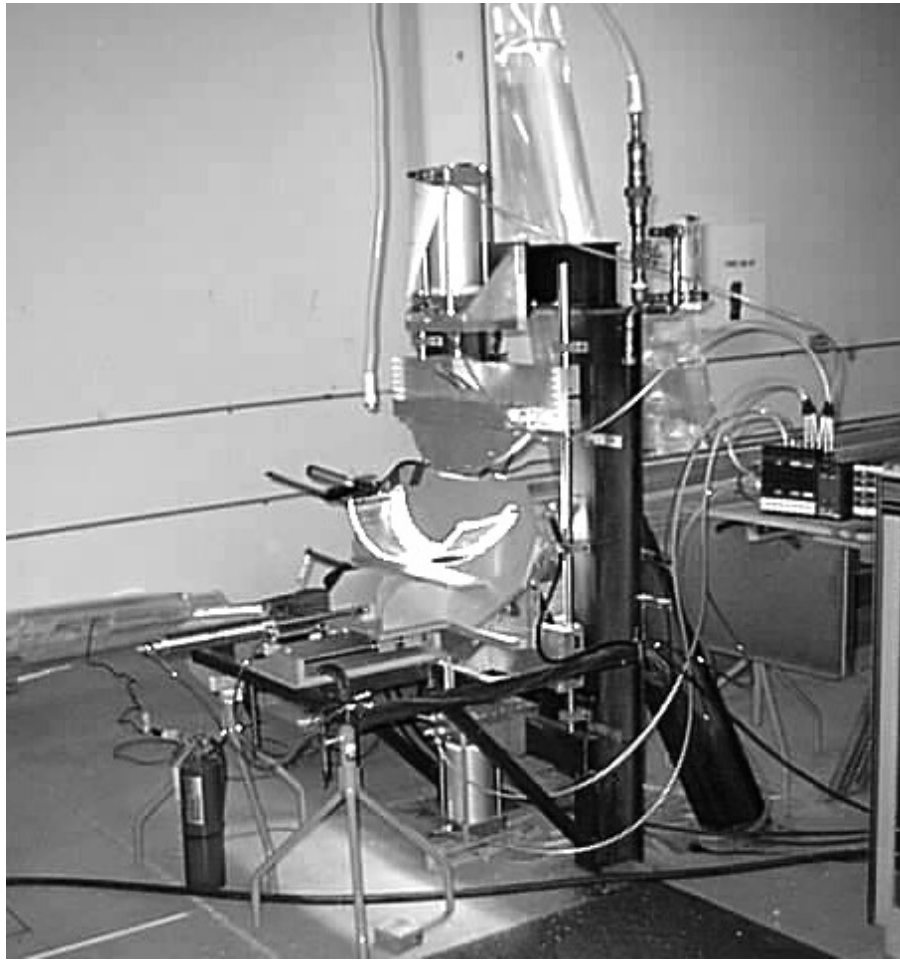

Figure 12, Lens End Re-Forming Machine

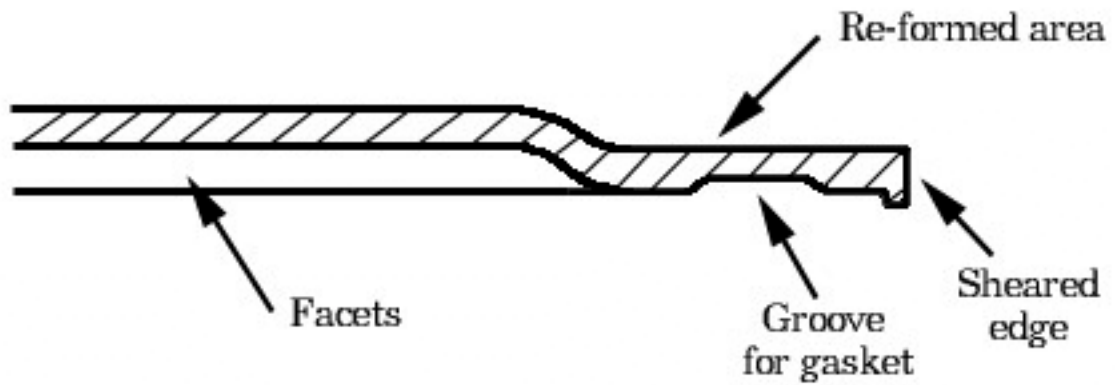

Figure 13, Re-Formed Lens End Cross Section

As far as we know, this is the only case where extruded parts are re-molded and hot sheared in a secondary operation. This manufacturing process produces stronger lenses that are also shaped consistently and are interchangeable. Since the lenses are now fastened to the module with clips, they can be replaced if broken. Previous PVI modules did not have replaceable lenses.

Material Handling System

The material handling system consists of all the equipment necessary to deliver dry, warm pellets of plastic to the extruder hopper. The material handling system uses a vacuum transfer system to move material. Raw acrylic pellets are moved from incoming gaylords to a drying hopper, see Figure 14. The hopper stores approximately 8 hours worth of material and dries this material to a -70°F dew point. It also warms the pellets to 150°F . The warm, dry pellets are conveyed from the dryer into the extruder hopper in small batches. There are also provisions for emptying the drying hopper and conveying re-grind plastic. As production increases, an outdoor silo will be added to provide bulk storage. In that case, the plastic will be delivered in bulk rather than gaylords.



Figure 14, Material Drying Hopper

The material handling system has its own control system which operates independently from the main extrusion control system. There are settable alarms to warn the operator of malfunctions or low material levels.

Regrinder

During die or process development, 100% regrind is used. The parts are reground and fed into the drying hopper. It is not unusual for the plastic to go through the extruder five times or more. This significantly reduces the material cost for development. However, for production lenses, only virgin plastic is used. The plastic degrades after successive heating cycles, although acrylic is less susceptible to heat damage than other plastics.

On-line Optical Tester

The lens performance is measured on line by a system of collimated lights and a solar cell. This system is key to achieving good lenses. In the past we had no way of knowing when the extrusion parameters were correct without measuring the transmission while the lens is extruded.

The in-line transmission measurement system is very simple but also very effective. Short circuit current from a solar cell is used as the measurement of lens transmission. Relative transmission from different parts of the lens can be judged by blocking off sections of the lens. The focal length can be set by changing the height of the solar cell. Acceptance angle can be judged by moving the cell from side to side. In the future, we plan to revise the system to show flux distribution and relative transmission from different parts of the lens on the system computer.

The lens tester is mounted on the air rack just down stream of the cold shoes. In this way, the lens is tested as soon as possible after it is extruded. This reduces the feed back loop time. The tester is mounted on a slide so that it can be moved off-line for calibration.

Cold-shoes and Air Rack

The air rack is an assembly to cool the part in a controlled way after it is extruded. We use cold shoes to control the geometry of the parts during the initial cooling when the part is solidifying. A cold shoe is an aluminum form over which the part travels that can be cooled by air or water.

For the lens extrusion process, the cold shoes consist of semi-cylinders, see Figure 15. The flat lens exiting the die sags into the cold shoes where the final radius is formed. Additional parts form the attachment features.



Figure 15, Lens Cold Shoes (three) With Lens Sagging Into Required Radius

The rest of the air rack consists of a series of nozzles that blow chilled air onto the part, see Figure 16. This completes the cooling of the part. The blower with heat exchanger are outside the building. Chilled recirculating water is supplied to the heat exchanger.

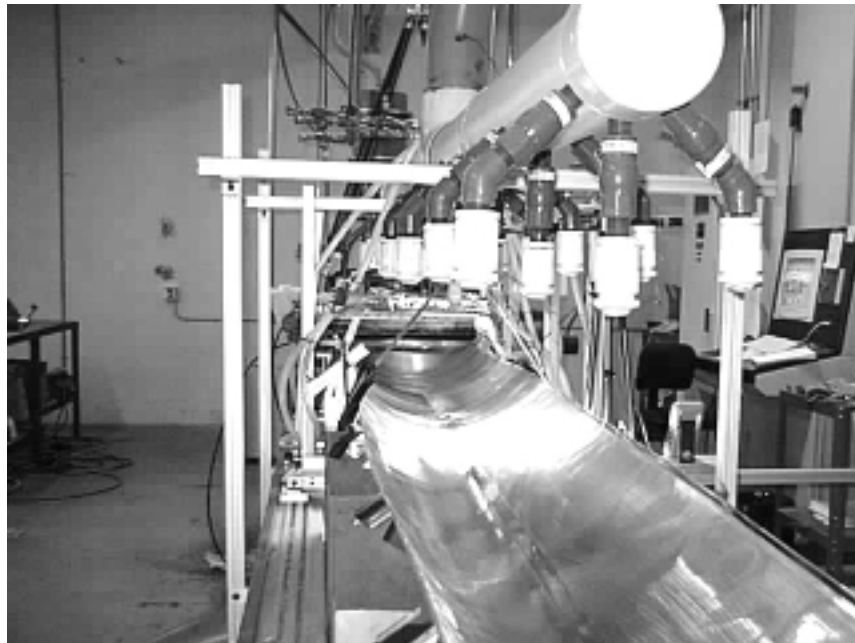

Figure 16, Air Rack

The air rack with cold shoes is mounted on wheels that move on a track mounted to the floor. The air rack can be moved out of the way for maintenance. Also, the various elements, such as

the cold shoes and lens tester, are mounted on a track on the frame of the air rack. In this way, the elements can be moved, removed, replaced, or adjusted easily.

Part Takeoff System

A takeoff system was built that receives the lenses from the saw and moves them horizontally to be removed and stacked. In this manner, in theory, up to 5 parts could be stored on the system before an operator needed to be involved.

There were a number of mechanical problems with the part takeoff system. Lenses were getting jammed and constant operator assistance was required. Also, the lens end reformer took the physical location of the part takeoff system in the extrusion line. For these reasons, the part takeoff system was abandoned and removed from the extrusion line.

Manifold and Die

The manifold uniformly distributes the plastic to the die. We use a "coat hanger" type manifold that is normally used for extruding sheet material. The "coat hanger" manifold has a passageway that is roughly in the shape of a coat hanger with the plastic entering at the top and proceeding to the wide part. The dynamics of this type of manifold is well understood and it can be made without too much guess work.

The die determines the part shape and also the final distribution of the plastic across the part. We use a flat die for our lens and then curve the lens to its final shape in the cold shoes. This allows use of a "flex lip" which is a flexible shelf opposite the die that can be adjusted to change the opening through which the plastic flows. In this way we can restrict flow in certain sections of the part to change plastic distribution. A "flex lip" is only practical on a flat die.

The geometry of the die indirectly determines the shape of the part. The part is reduced in cross section by the action of the puller. Also, due to flow dynamics in the die, the part profile changes shape after extrusion. The geometry of the die is adjusted to give the desired part after it cools. Figure 17 shows the lens profile. Obtaining the proper die geometry is a trial and error process. Experience and theory are used to design a new die. Then it is run, taken off the extruder, modified, and run again until the desired part is obtained. This process can take several weeks and is made much easier on our extruder by the way the die is designed to be easily removed. Different extrusion parameters also affect the part shape. Once the die is modified and the correct extrusion parameters determined, assuming good control, identical parts can be extruded day after day. Also, if an identical die is manufactured, it can produce the same parts as the first die. The die is designed so that small changes in extrusion parameters do not greatly affect the part.

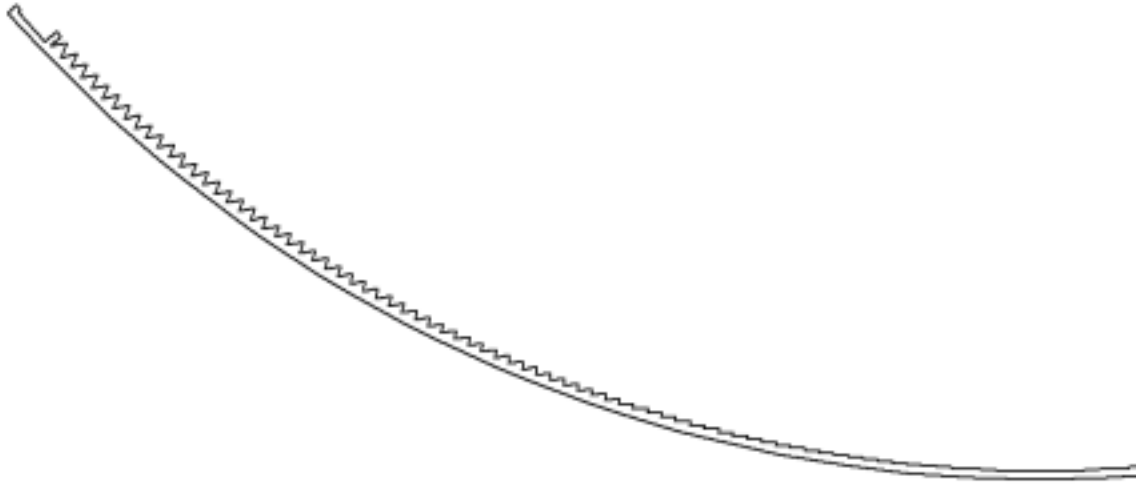

Figure 17, Lens Profile

Incidental Equipment

Incidental equipment consists of an air compressor, an air blower, and a chiller. These pieces of equipment all have autonomous control systems that report faults to the main computer. The air compressor supplies compressed air to the pneumatic systems, such as the puller and material control system, and also is a source of cooling air that is used as needed on the air rack in addition to the normal cooling air. The blower supplies cool air at low pressure to the air rack. The chiller supplies chilled water to cool the cold shoes, gear box, and feed throat. It also supplies chilled water to cool the air discharged from the blower.

Results

Equipment

The extrusion system is fully operational. The pellets are usually dried overnight before a run, although they are dry enough for use in 4 hours. The extruder takes about 4 hours to warm up to operating temperature, but again, it is usually left to warm up overnight. It takes about two hours to start up the extruder and stabilize the process. Lenses are produced during startup but they are not usable and are reground. After the process is stabilized, the extruder is run continuously until the production requirements are fulfilled or until the end of the third shift at the end of the week. One shift of maintenance is required for each week of running.

The extrusion system is capable of extruding good quality lenses at 3 feet per minute. However, we usually extrude at half this speed because it is easier to do and there are not extreme production pressures at this time. At 3 feet per minute, assuming 250 days production per year, three shift operation, this is equivalent to about 14 MW per year per extruder. To meet our production capacity goal of 50 MW/yr, we will install two additional extrusion systems and up the line speed slightly.

Lenses

Because of the low concentration ratio, some of the diffuse solar radiation adds to the output of the Powergrid module. The lower the concentration ratio, the wider the acceptance angle and the more sky the system is "looking at." The theoretical relationship for a single axis (linear focus) concentrator is:

$$Cr = 1/\sin(A/2)$$

Where:

Cr is the maximum concentration ratio possible in one axis

A is the acceptance angle in one axis

Rearranging:

$$A = 2(\arcsin 1/CR)$$

The module responds to the direct normal insolation plus any diffuse radiation that the acceptance angle allows.

$$I_r = DNI + F(TNI-DNI)$$

Where:

I_r = Irradiance accepted by the system

DNI = Direct Normal Insolation

TNI = Total Normal Insolation

F = Fraction of the sky that the system "sees"

$$F = A/2\pi$$

In our case the exact geometric concentration ratio is 11.9:1. This yields an F value of 5.57%. So the theoretical value for irradiance accepted by our system is

$$I_r = DNI + 0.0557(TNI-DNI)$$

This formula is used in calculating lens transmission using the method of short circuit current. It gives slightly lower transmission than when only direct normal insolation is used. However, it is more accurate. When system performance is calculated for varying conditions of direct and diffuse radiation, more accurate predictions are obtained.

Using this formula then, the following curve was obtained. Figure 18 shows module response as a function of tracking error, and Figure 19 shows module response as a function of apparent declination angle. The transmission falls off to 90% at a tracking error of 1.5 degrees. An apparent declination angle of 23.4 degrees will reduce the lens transmission to 65% of the transmission at a normal angle.

Module Response vs. Tracking Error

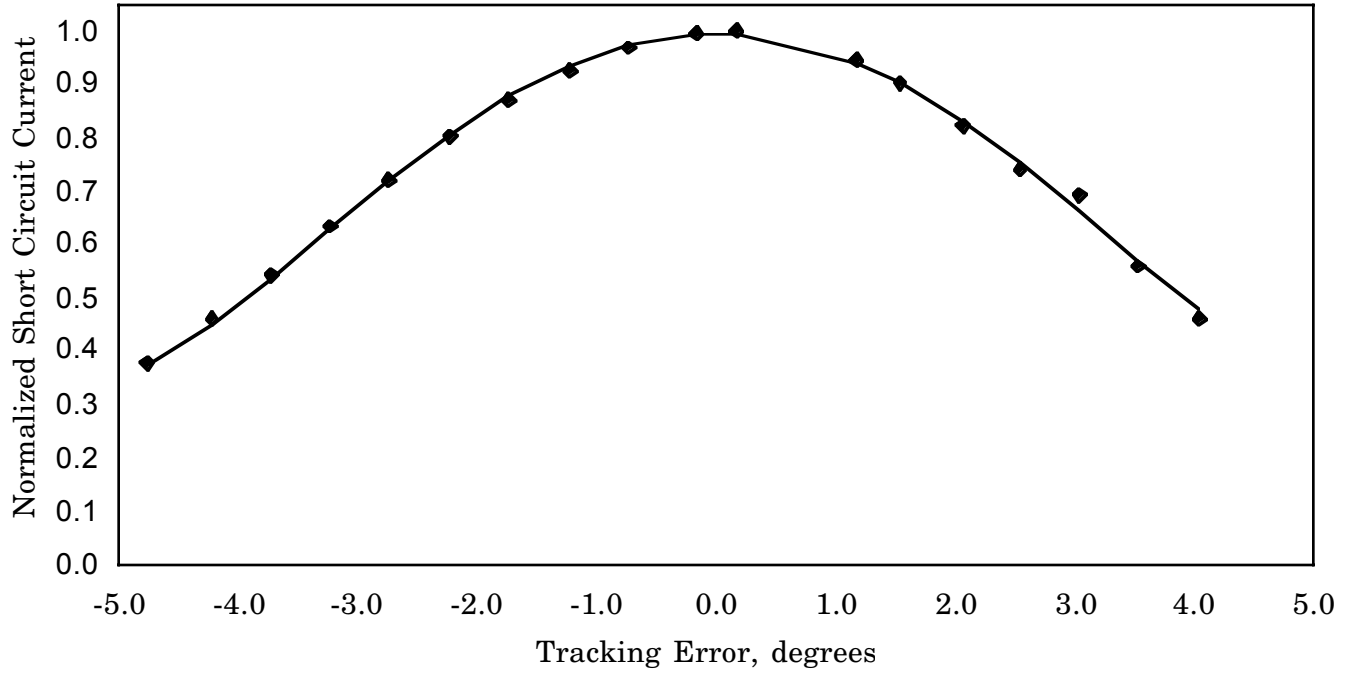

Figure 18, Module Response vs. Tracking Error

Module Response vs. Apparent Declination Angle

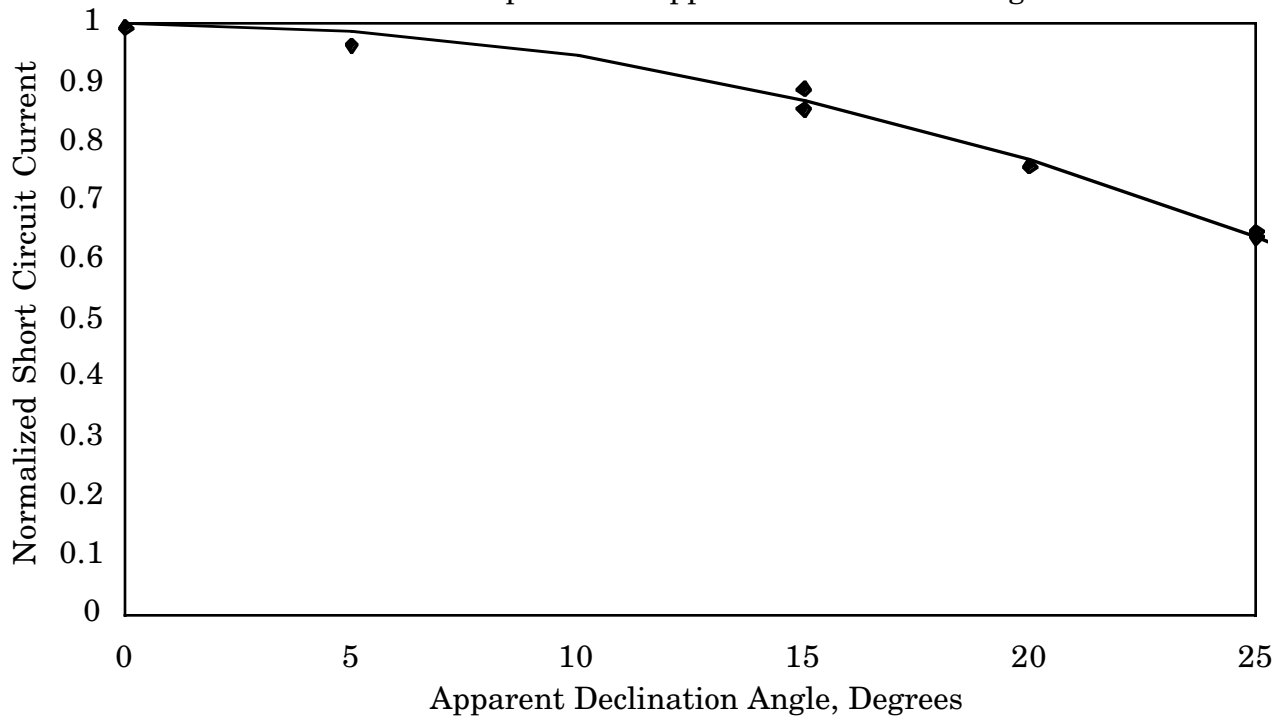

Figure 19, Module Response vs. Apparent Declination Angle

At first glance it would seem that the fall off with apparent declination angle would dramatically reduce panel output. However, the apparent declination angle on the module varies throughout the day and this tends to mitigate the effect, see Figure 20. Variable tilt will increase the output of the PVI panel and is planned as an option in the future.

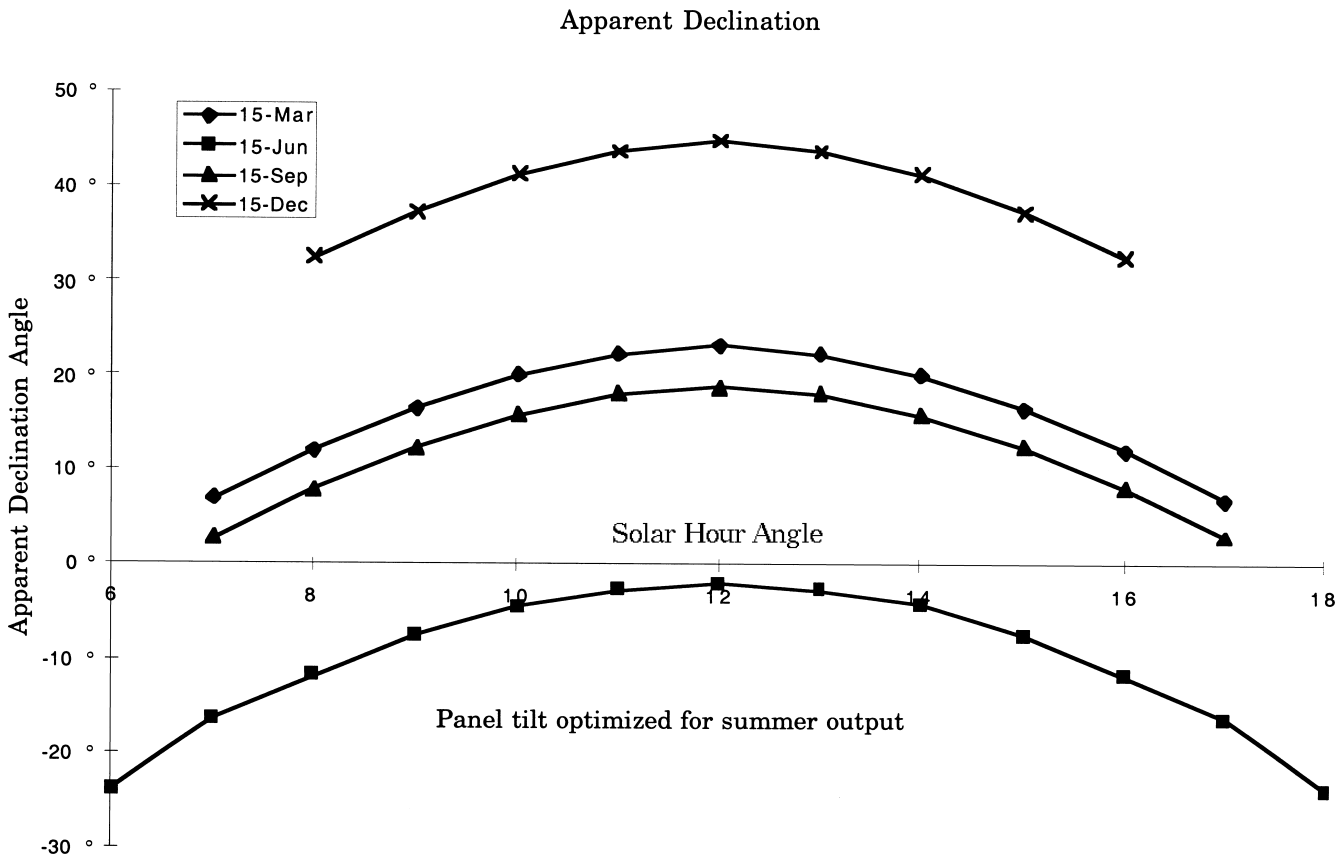

Figure 20, Apparent Declination On Module

We have calculated yearly output for the panel using different lens curves. The lens curve shown in Figure 19 gives the best yearly output when compared to other possible lens curves.

Conclusions

The extrusion system is fully operational and gives lenses with 86% transmission in a production environment. The system has a production capacity of 14 MW/yr. This aspect of the PVI PVMaT program has been very valuable to the company. It has enabled us to obtain quality lenses at a low cost and has led to high output panels.

3.2 CELL ASSEMBLY MANUFACTURING

Overview

The Powergrid cell assembly consists of the cell and two sets of tin-plated copper leads: two leads that contact the bus areas on the top of the cell, and two leads that contact the bottom of the cell, see Figure 21. The leads have fingers that span from the lead bus to the cell. The ends of the fingers have pads that provide an area for solder bonding, see Figure 22. The fingers are designed to flex due to differential thermal expansion between the copper and the silicon. Dead soft copper is used to minimize stresses during the flexing.

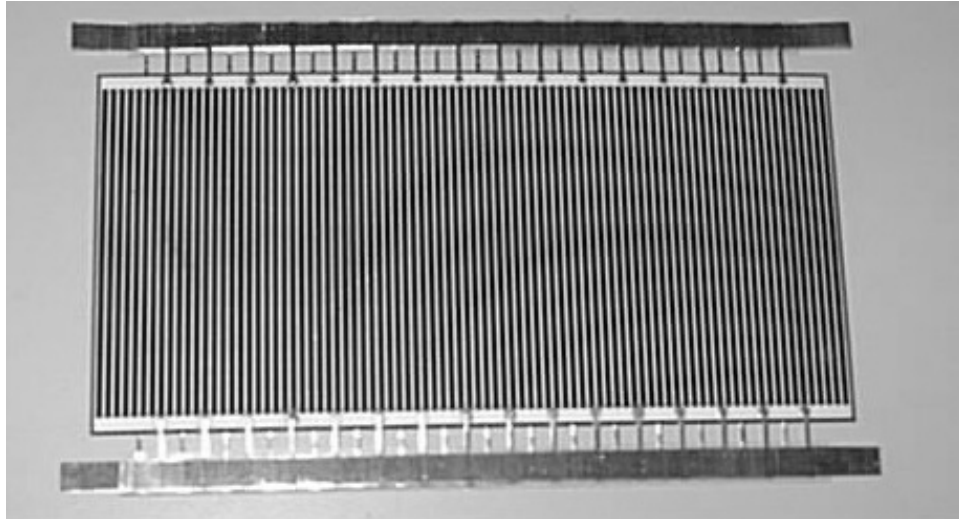

Figure 21, Powergrid Cell Assembly



Figure 22, Lead Configuration

The top and bottom sets of leads are electrically isolated from each other by strips of insulating tape. This tape is designed to withstand the soldering temperature and the environment in use in the receiver for 30 years or more.

The second generation automated receiver assembly station solders the cell leads to the cell while the parts are held in a nest. The parts and completed cell assemblies are manipulated by a robotic arm. The cell leads are stamped from tinned sheet copper on the machine. The insulating tape is also applied on the machine. The original concept was to place the completed cell assemblies directly on the receiver, and although this feature has not been added to date, we plan to add it later. For now the cell assemblies are placed on a conveyor belt that moves them out of the machine to a point where the operator can remove them.

Soldering is done by infrared lamps that heat the lead fingers and cell bus bar area. A eutectic lead-tin-silver solder is used to minimize leaching of the silver metallization on the cell. A no-clean, low-residue flux is used to eliminate any after-processing clean up. The solder and flux are supplied in paste form by a dispensing system.

Rationale

We were looking for a process that was consistent, providing the same dimensions and quality cell after cell. We believed that we could improve the strength of the solder joints and improve cell performance over hand soldering and over the previous station. We also wanted to reduce the high labor content of the hand soldering.

The machine had to be flexible enough so that if there were changes in the cell geometry we could accommodate them. (In fact, the cell size did change during the project.) We also wanted to be able to change out sections of the station in case these sections did not work. The station had to be fast, reliable, and work with minimal operator interaction. It also had to use low-cost materials, such as raw copper instead of pre-formed lead strips.

We developed a team of experts for the different portions of the station, including in-house employees and consultants. For instance, we hired a punch design expert to design the lead punch section of the station. Coordination meetings were held once a week or more.

We tested each concept before committing to it. This added time to the design process but assured us that the whole machine would work as planned. The tests were usually very prototypical, using simple setups. This philosophy was followed during construction by using temporary parts to get the system up and running so that the concept could be verified quickly and cheaply before full commitment to that concept.

Features

- Cell assembly is done at a separate station and not on the heat sink
- Infrared soldering
- Lead/tin/silver eutectic solder with no-clean, low-residue flux
- Temperature-controlled cartridge-applied solder paste
- Adept robot arm for manipulating parts
- Five degrees of freedom robot end effector
- Two position nest for part assembly
- Remote plunger actuated nest
- On-machine lead stamping
- On-machine insulating tape application
- Computer based operator interface

Advantages

- Cell assembly off the heat sink allows 100% inspection of the cell assembly before it is placed on the receiver. The bottom lead solder joints can be examined and tested. The cells can be individually electrically tested and inspected for cracks. There are far less receivers scrapped because of a bad cell.
- The infrared soldering was chosen because it causes less degradation in the cell metallization, it is faster, variable thermal contact is eliminated, no cleaning of the equipment is necessary, and there is no large component that needs to be kept hot or thermally cycled.
- The lead/tin/silver eutectic solder with no-clean, low-residue flux was chosen because it has been proven to be fatigue resistant, minimizes silver scavenging of the cell metallization, has a fairly low melting point, and does not require cleaning after soldering.
- A temperature-controlled cartridge application of paste solder provides accurate placement of solder and flux droplets at exactly where they are needed.
- The Sieke® robot arm provides flexibility that cannot be achieved with dedicated specialized machinery. It also does not require any development in itself.
- The end effector has five degrees of freedom to allow complete manipulation of the components and finished cell assembly.
- The two position nest keeps up with the rest of the station. While one position is in the soldering dock being soldered, the other position is being loaded with components.
- The remote plunger system halves the number of necessary pneumatic components, reduces rotational inertia, and eliminates complicated and unreliable rotating air lines.
- On-machine stamping reduces the cost of the leads while providing accurate registration for the robot.
- On-machine insulating tape application also reduces component cost and in addition allows it to be used only where necessary.
- The computer based operator interface provides multitasking, flexibility, diagnostics, full sensor interface, full control, and ease of operation for the operator.

Detailed description

General

Cell assembly is completed before the cells are mounted to the receivers. Conceptually, either the cell assemblies can be mounted to the receivers directly by the cell assembly station or the cells can be placed in cartridges for mounting later. At the present, the cells are put in cartridges for later mounting to the receivers by hand. We are planning an automated receiver assembly station that can be either integrated to the cell assembly station or operated autonomously.

Full inspection and testing can be done for both the top and bottom of the cell. The cells can be checked for dimensional accuracy of lead placement. The solder joints can be visually inspected. Each pad of the cell lead can be individually pull-tested to destruction. Each cell can be fully electrically tested. They can also be checked for cracks. Destructive tests are done to perfect the materials and process. Non-destructive electrical tests and dimensional and visual inspections are now done on selected cells. These tests and inspections will be automated in

the future. For instance, the electrical test can be done while the cell is in the nest and the robot used to place the cell in the appropriate cartridge.

The present automated cell assembly station has eliminated rejected receivers due to bad cells. An occasional bad cell is caught before being bonded to the receiver. The present yield on the automated cell assembly station is greater than 92% and 96% after rework.

Infrared soldering

Infrared soldering is done at one position of the two-position nest carousel. Four linear focus infrared lamps are arranged in a double V configuration. The focal lines are arranged to impinge on the lead fingers. The nest parts are masked off so that they are not heated by the infrared radiation. The infrared lamps are water cooled and contain linear quartz bulbs. Quartz Windows protect the lamps from smoke and splatter which keeps the reflectors and bulbs clean and the lamps working at a constant intensity. An exhaust system carries away any smoke which also helps to keep the lamps clean. The space behind the quartz Windows has a slight positive air pressure to prevent smoke contamination.

We have found the infrared soldering process to be very consistent. The lamps are controlled by the computer. No temperature feed back was found to be necessary. The computer controls the current ramp, the maximum current, and the soldering time and cool down time. An air knife beneath the nest is used to assist the cool down. Total cycle time is approximately four seconds.

Lead/tin/silver eutectic solder and no-clean flux

We experimented with different types of solders and fluxes. We found that the eutectic lead/tin/silver solder gave the best results. Leaching of the silver metallization on the cell was minimized. Fatigue life of the solder was found to be good.

High soldering temperature, long soldering times, and silver leaching will degrade the cell metallization. The degradation is in the form of dewetting, reduced bond strength, and increased contact resistance.

The no-clean, low-residue flux eliminates any type of cleaning of the completed cell assemblies. Most of the flux evaporates during the soldering process. From our environmental testing, any small amount of residue from the flux does not appear to interfere with the encapsulation or long term performance of the receiver. No-clean flux has become a well accepted material in industry. The flux is part of the solder paste as described above.

Cartridge solder application

The solder paste is supplied in syringe style cartridges. We use eight cartridges mounted to a holder. The solder paste is dispensed using pneumatic pressure. The amount of the pressure and the timing of the pressure determines the size of the solder droplets. The solder droplets are placed on the ends of the fingers of the lower leads and on the cell where the fingers of the upper leads are later placed. Each syringe places four droplets for a total of 32 depositions per cell assembly. The up and down movement of the syringes is controlled pneumatically and the position by a stepper motor. The entire package slides in and out of the nest area so that it is

out of the way during part placement. The room that the machine is in is air conditioned to stabilize the viscosity of the solder paste, and thus the amount of solder dispensed. The solder dispenser is shown in Figure 23.



Figure 23, Solder Dispenser

Robot arm

We employed a precision robot arm, the Seiko® TT8550, see Figure 24. The robot arm allowed us complete flexibility in the assembly process. It can be programmed for any sequence of tasks, unlike dedicated machinery. The end effector can be changed to accommodate any change in the materials, such as a different cell size. The Seiko robot arm offered the best balance between price, payload, speed, precision and flexible development environment.



Figure 24, Seiko Robot Arm

The TT8550 consists of the AC servo robot arm and a separate SRC-310 microprocessor controller. The controller can communicate with an IBM®-compatible PC and provides expansion slots to increase the I/O capability as required. The programmable language is "SPEL for Windows®" an environment and style similar to Visual Basic™.

The robot arm can be taught where to go. Rough positions and movements are taught by moving the arm by hand. Final positions are taught by jogging the arm through software control.

End effector

The leads, cells, and finished cell assemblies are moved about by a robot arm and an end effector, see Figure 25. The end effector is mounted to the quill of the robot arm, through which filtered shop air, DC power and DC control signals pass via a cable festoon. Each side of the end effector contains three fingers that are air-operated and spring-returned and that are used to pick up the leads. One set of fingers can rotate 180%, allowing for two of the asymmetrical leads to be located correctly. PVI incorporated sensors into the end effector to track the position

of the rotating fingers and the proximity of nearby objects that may cause collision damage. Two suction cups are mounted to the bottom surface of the tool to pick up the cell and the completed cell assembly.

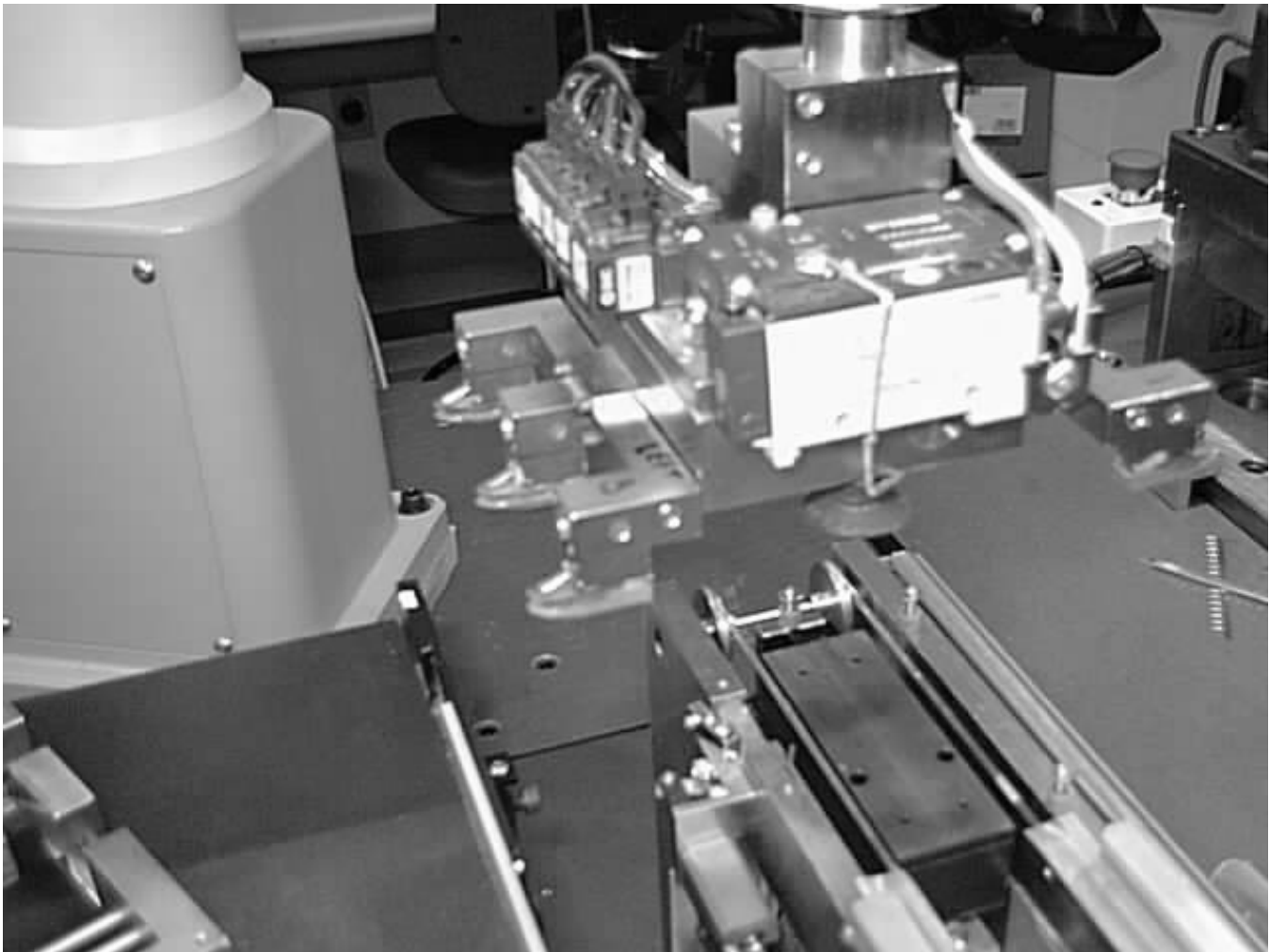

Figure 25, End Effector

For teaching the robot, we add a dial indicator to the end effector. The dial indicator can also be used to align the assembly station components, such as the nests.

Two position nest

The number of nests was determined by the timing of the assembly station and by the number of steps required. There are four main steps that are done in the nests. The main steps are loading the parts, placing the solder, soldering, and unloading the finished cell assembly. In order to keep up with the rest of the assembly station, two nests were required. The sequence of events is:

1. Bottom leads loaded
2. Solder paste droplets applied to bottom lead fingers

3. Cell loaded
4. Solder paste droplets applied to cell where top lead fingers will go
5. Top leads loaded (next moves to the soldering position)
6. Infrared soldering (nest moves back to load/unload position)
7. Completed cell assembly removed

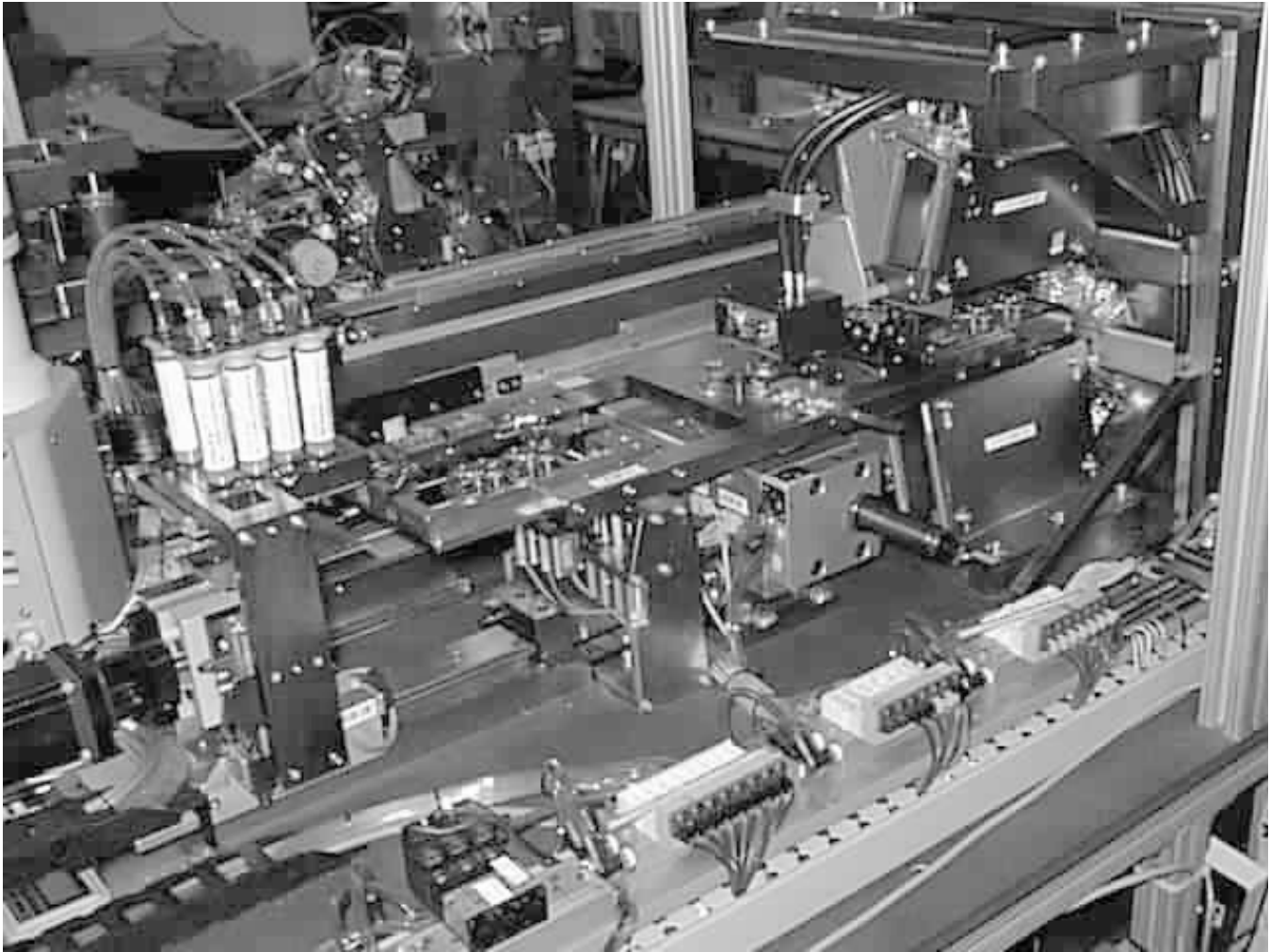

Figure 26, Nests and Rotary Table

Remote plunger system

The clamps are actuated by pneumatic plungers that are held stationary under the nest position where the loading and unloading is done, see Figure 27. This way, the plungers, and associated pneumatic tubing do not have to move, thereby increasing reliability and decreasing the inertia of the rotary blade. Also, there are half the number of actuation parts, thereby reducing cost.

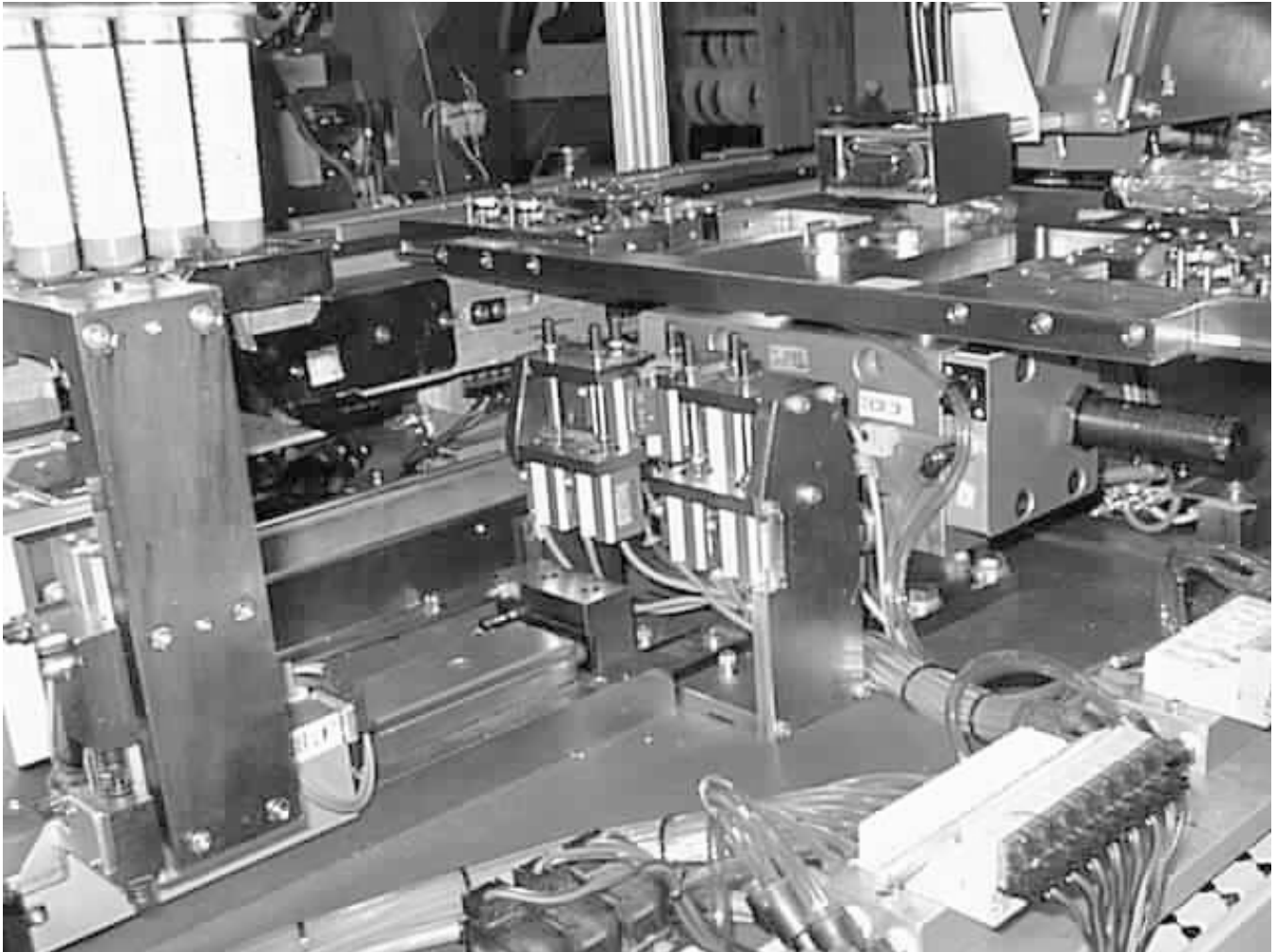

Figure 27, Nest Actuation System

Lead stamping

Leads are formed in a progressive punch press from a coil of copper that is fed off of a de-reeler, see Figure 28. The de-reeler utilizes a dancer arm to meter out the copper ribbon to the feed mechanism of the punch. The feeder advances the copper through the progressive punches, successively knocking out rectangular holes, thus forming the lead. A shear attached to the "nose" of the press cuts off one lead each time the punch is activated. The robot and effector grabs the lead before the final cutoff, thereby assuring accurate registration.

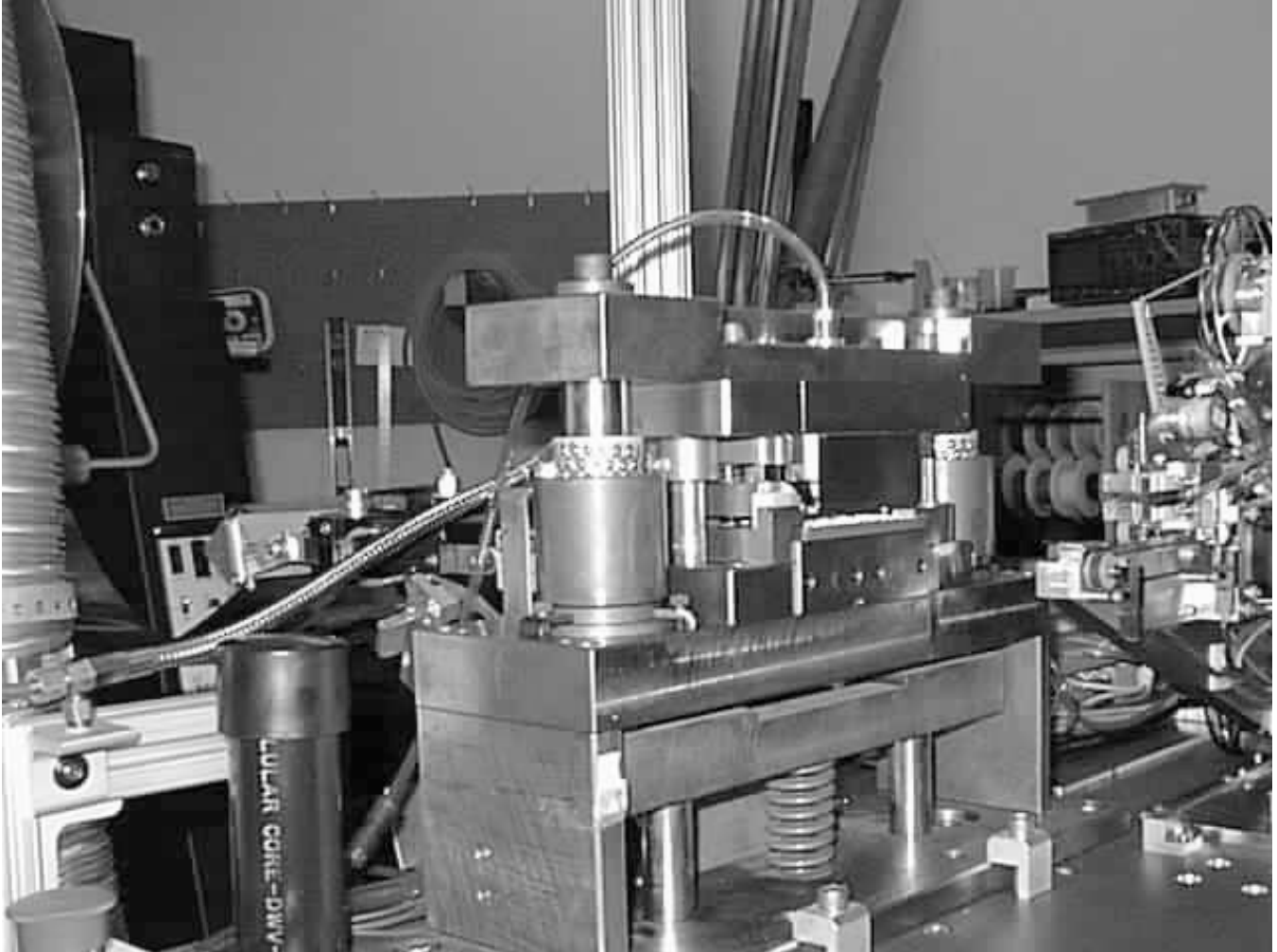

Figure 28, Lead Forming Progressive Punch

Insulating tape applicator

Insulating tape is placed on the bottom of the top leads. The tape is purchased in rolls of the required width. It has pressure sensitive adhesive applied to the top and bottom. The tape is applied to the leads before they are cut off of the punch by a tape dispenser, see Figure 29. The tape is dispensed from two supply reels and is applied to the lead using a series of rollers that are mounted on slides. A brake controls the tape feed and cutters cut it off at the right length. The release liner on the tape is re-spoiled on take-up reels. The mechanism is run by stepper motors and pneumatic actuators. The lead with the tape installed is grabbed by an end effector before the final cut off of the lead. Because of the way the leads are installed in the cell assembly, one of the two leads has the tape installed on the top, and one has the tape installed on the bottom. Hence the need for two supply and two take-up reels.

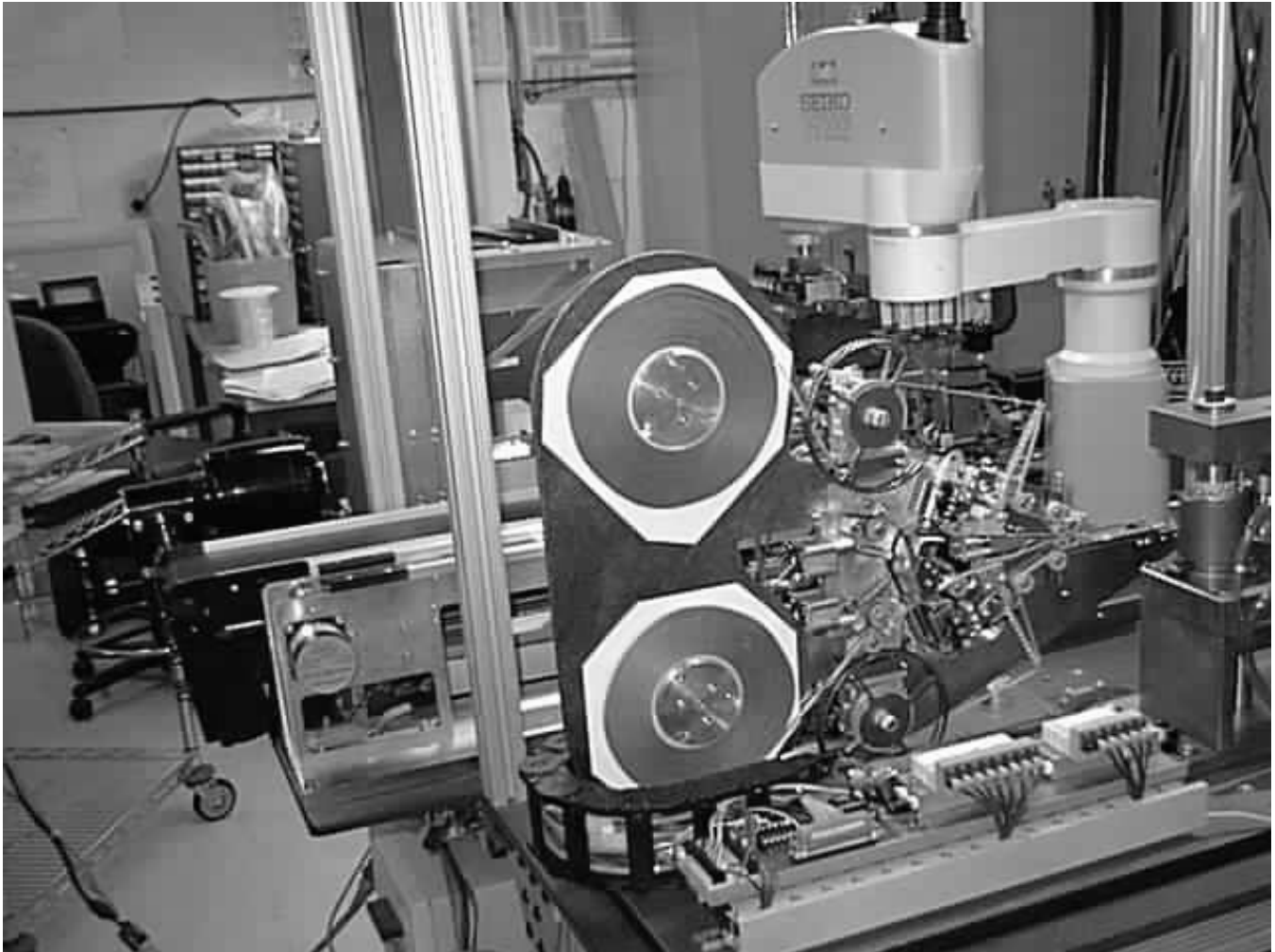

Figure 29, Tape Dispenser

Computer based operator interface

The cell assembly station is controlled using a multitasking multiprocessor systems. An IBM-compatible PC with the Microsoft Windows 95™ operating system communicates back and forth with the Seiko robot controller, see Figure 30. The functions of the robot and some of the I/O for the station are controlled by "SPEL", the software environment for the Seiko robot. The majority of the processes and the remaining I/O for the machine are operated using software written in Microsoft Visual Basic™. Tasks or processes can occur in parallel in either environment, allowing a high degree of flexibility and speed in the control system. While presenting a number of programming challenges, we have found that both software tools have provided a reasonable amount of flexibility and common functionality.



Figure 30, Computer Robot Control

The machine operator interface takes advantage of the software "buttons" tools available to Microsoft Visual Basic, providing operators a push-button interface on both the screen and, via mechanical buttons, on the machine itself. Figure 31 shows the operator interface when a "Home" sequence is required. The "Home" button turns to a "Run" button once the home sequence is completed. The PVI software development effort also included a maintenance and engineering interface that takes advantage of the GUI environment, allowing parameters in each of the processes to be altered at will, with manual subsystem control when needed.

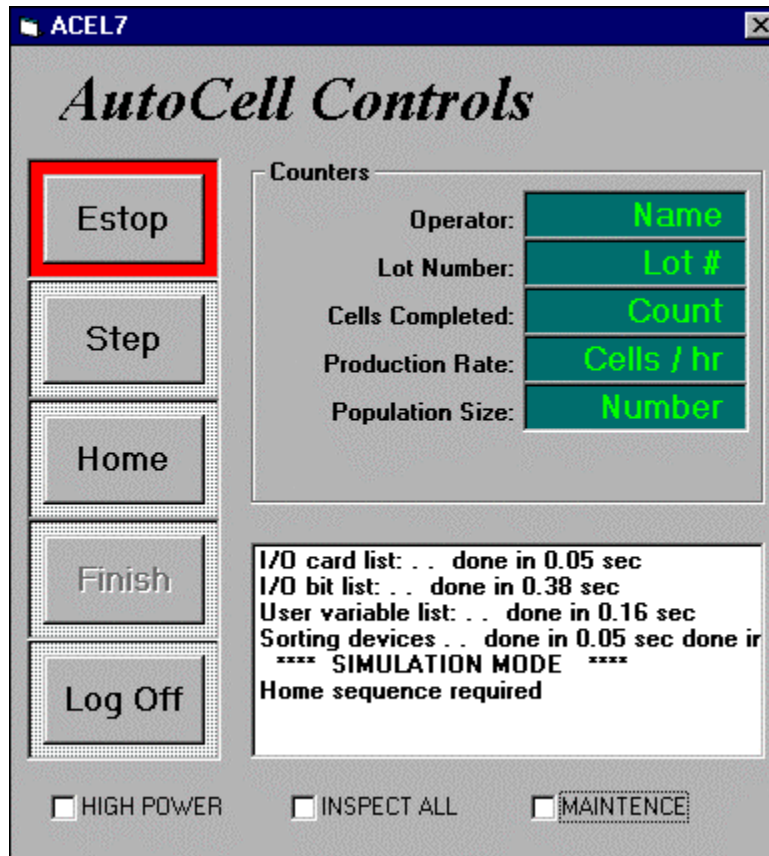

Figure 31, Operator Interface on Computer Screen

Tests

To test production capacity and function of the automated cell assembly station, 5,000 cell assemblies were made on the machine over 90 days in a single shift operation. Our flash tester was used to evaluate the electrical performance before and after soldering. Contact resistance was estimated by electrical performance tests. Solder joint strength was measured by pull tests. The cells were inspected for dimensional accuracy. The cell assemblies were also tested in our environment chambers per the Sandia Qualification Test procedures.

Results

Average assembly time per cell assembly was 55 seconds at the end of the test. The overall yield was 96% after rework. This equates to a production capacity of 1.7 MW/year with a three shift operation.

Assembly failures were tallied in the following way:

- 3.1% cells developed cracks during assembly, soldering, or handling
- 0.4% cells did not pass dimensional inspection
- 3.5% cells had misplaced tape
- 0.5% cells had one or more leads detached

- 0.0% cells did not pass visual inspection of the solder joints

In all 7.6% cells were rejected, leading to the 92.4% overall process yield before rework.

Weaker joints occurred on the backs of cells, built both by hand and by the automated cell assembly station. We believe this is due to differences in the metallization. After process optimization, all solder joints were able to withstand the minimum force specified by the cell manufacturer for use in flat-plate modules and up to over 7 times this minimum value. Typical test results are shown in Figure 32.

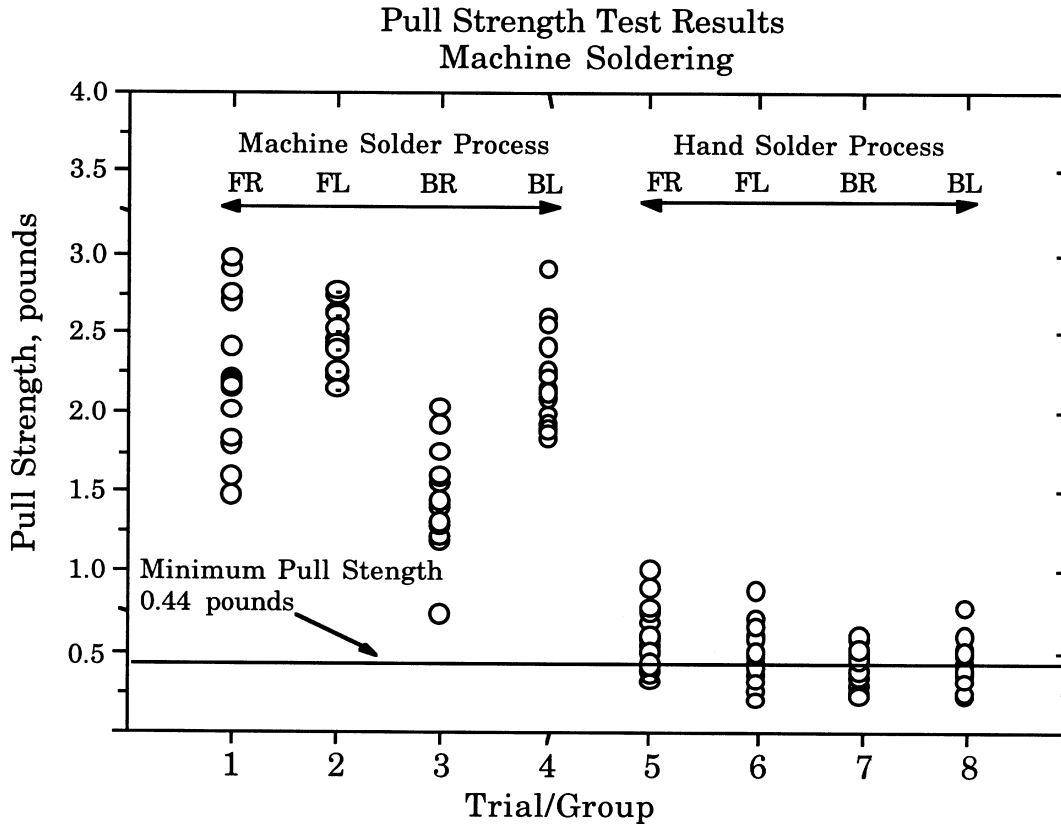

Figure 32, Pull Strength

The average series resistance was found to be 66% of the average series resistance found in hand soldered cells. The lower contact resistance in the automated soldering has led to better performance of the modules. We believe that the lower contact resistance is due to the shorter soldering times.

Measured dimensions indicate that the variation in placement of the leads is ± 0.015 inch maximum. Average variation was ± 0.005 inch.

Conclusions

We are working to reduce the cell assembly time to 30 seconds. This will result in a capacity of 2.5 MW/yr per machine with a three shift operation. We anticipate further improvements to

the present machine during its life. We are planning to build a second machine within two years, when we feel we will need additional capacity.

The second machine will copy the first machine except that various improvements are planned. We no longer need complete flexibility because the major development work has been done. This will simplify most parts and make the machine more reliable.

Because of the short soldering time, automated soldering provides improved strength in the solder joints and reduced contact resistance. Since the machine is not subject to human errors, it provides consistent, accurate cell assemblies. And, the labor cost is significantly reduced.

3.3 EVA ENCAPSULATION

Overview

To the best of our knowledge, the PVI receiver is the first concentrator receiver to use EVA encapsulation. EVA has been used for years for flat plate modules. Arco Solar attempted to use an EVA encapsulated flat plate module at two suns concentration. The encapsulation turned brown causing lower module output. EVA encapsulation works in the ten-suns-concentration PVI receiver for the following reasons.

1. New EVA formulations have been developed that are highly resistant to browning
2. The acrylic lens filters the high energy ultraviolet spectrum
3. The PVI receiver uses a polymer film over the cells that allows gas exchange which has been shown to help prevent browning
4. The PVI receiver does not exceed the maximum recommended temperature for EVA

PVI developed specialized machinery for encapsulating the receiver. A patent is pending on this design.

Rationale

EVA is a low cost, proven material for encapsulating solar cells. It does not release volatile organic compounds or hazardous materials during encapsulation. The previous encapsulation method that PVI used contained volatile organic compounds.

The EVA materials and process variables are the same as used by flat plate module manufacturers, but the equipment is very different. In flat plate module manufacturing the module is placed in a laminator that consists of a platen, the module, a diaphragm, and a cover. The space that the module occupies and the space above the diaphragm are evacuated, then heated, and then air is introduced above the diaphragm. After cooling, the encapsulated module is removed. The laminator has an air tight seal around the edge.

In Phase I of the contract, we developed an oven that was completely sealed and evacuated, see Figure 33. This proved to be not suited for high volume production. The fixture contained a large thermal mass that required a great deal of energy to heat up and cool each time. The oven configuration had a large volume that required a long evacuation time.

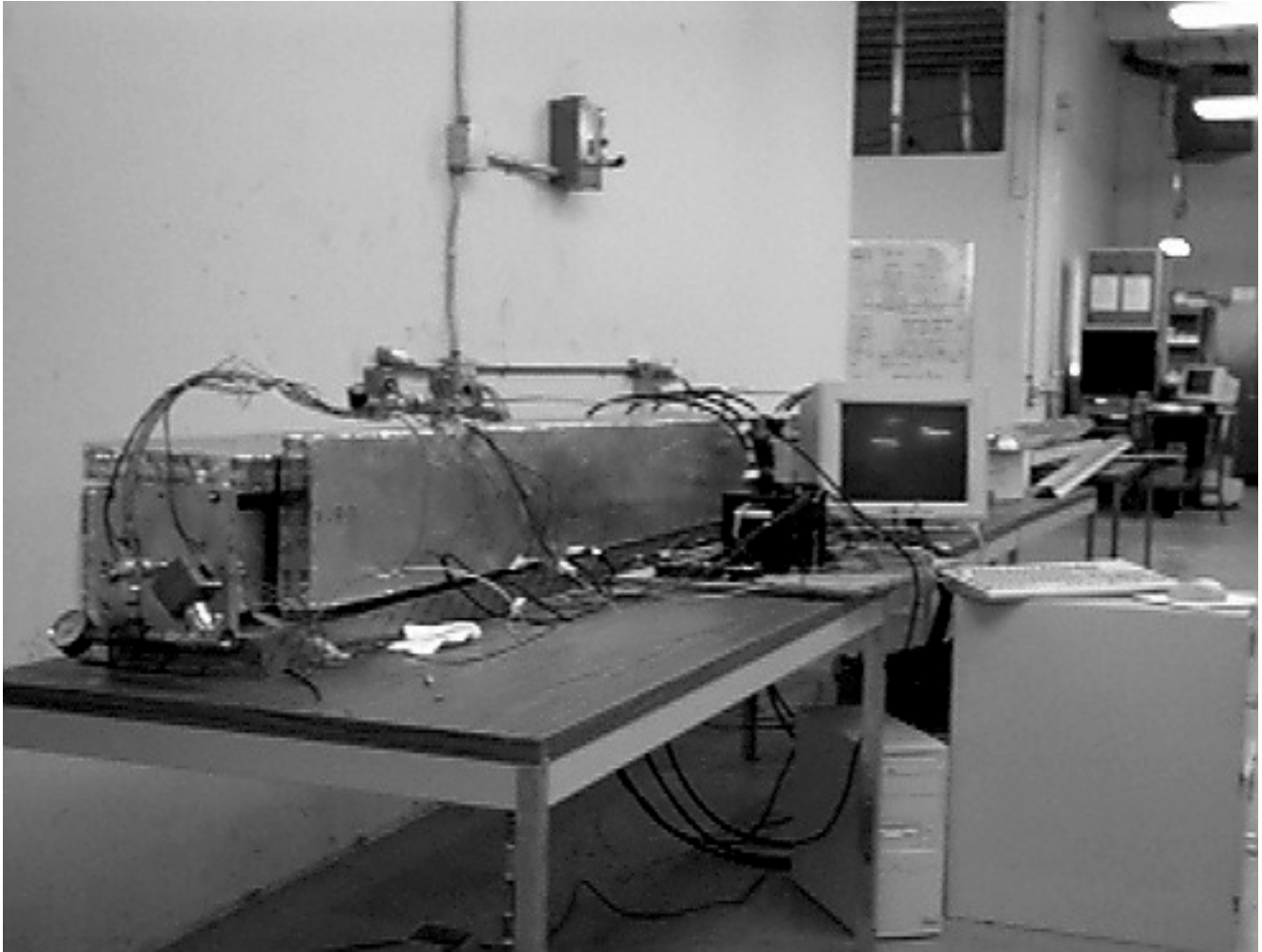

Figure 33, Early EVA Oven

The present design was arrived at in the course of the last phase of this contract. It is an energy efficient method of encapsulating. And the equipment is low cost.

Features

The EVA encapsulation process, and the PVI encapsulator, have the following features:

- Thermal melting and then thermal setting with a chemical cure
- Thoroughly tested material
- Film covering
- Distributed microprocessor control
- Special encapsulator configuration
- Pneumatic actuated machinery
- Uniform heating of receiver along entire length
- Pressurized diaphragm
- Dual encapsulation processing station

Advantages

- The EVA melts to flow into all areas in the receiver to give void free encapsulation and then becomes polymerized to prevent further movement.
- A large body of knowledge exists about EVA and its performance as an encapsulant for solar cells, eliminating any guess work.
- The film covering over the EVA provides a surface that is resistant to dust accumulation and water while providing gas exchange to prevent browning.
- Distributed microprocessor control provides repeatable, consistent process control at a low cost.
- The special encapsulator configuration simplifies the process and reduces the amount of energy consumed.
- Pneumatic operation eliminates operator strain.
- Uniform heating of the receiver along the entire length provides uniform temperatures.
- With the pressurized diaphragm we can supply higher than atmospheric pressure to assure void free encapsulation.
- The dual encapsulation processing station means that one operator can be readying one receiver while the other receiver is being encapsulated and that common components reduced the cost of the station.

Detailed description

EVA characteristics

Uncured EVA is a gel which softens at moderately low temperature and liquefies at about 80°C. It is melted under a vacuum to evaporate contaminants and allow the EVA to flow without restriction into all areas of the receiver, such as into the lead areas. After 10 minutes at curing temperature, the EVA polymerizes to a high "gel" content (greater than 85%). After polymerization it will not re-melt and remains in place for the life of the receiver.

EVA experience in the solar industry

EVA has been used to encapsulate flat plate modules for 25 years. Early experience indicated problems with browning. Recently, there has been research into the cause of the browning and ways to prevent it. Browning is caused by ultraviolet radiation with wave lengths shorter than about 350 μm . It was found that by reformulating the EVA, the browning could be greatly reduced. It was also found that by providing a way for gas exchange to take place, the browning could be eliminated. The current hypothesis is that oxygen bleaches the EVA if it can be transported from the air into the region exposed to ultraviolet radiation. Because of the almost exclusive use of EVA as an encapsulant in flat plate modules, research and development of EVA is well supported. Use in our receivers takes advantage of this support.

Film cover

PVI used a film cover over the EVA to provide protection from dust and water. The film is a fluorocarbon. It is bonded to the EVA, after surface treatment, and supplied laminated and slit to PVI's width requirement. The film allows gas exchange as stated above.

Distributed microprocessor control

The encapsulator is governed by three controllers. There are two programmable controllers for temperature. A separate controller is used for the vacuum system, and is used to signal the temperature controllers to begin their cycles. These controllers are simple off-the-shelf components and are inexpensive and easy to program. Each controller may be supplied with digital outputs to permit process data logging features in future.

Special vacuum encapsulator configuration

PVI has developed special vacuum equipment that encapsulates our concentrator receiver. We are applying for a patent for this equipment. The special configuration is needed because of the shape of the PVI receiver.

Pneumatic operation

The equipment is operated pneumatically. The operator actuates a valve that actuates the equipment. The equipment would be difficult to operate by hand.

Heating

The receiver is heated by four heaters. They provide a uniform temperature in the receiver. The present method is very energy efficient.

Pressurized diaphragm

The encapsulator has the capability of introducing air pressure greater than atmospheric pressure to the top side of the diaphragm. We found this to be very helpful in forcing the EVA into areas that would otherwise contain a void, especially in the lead area. Normally, in flat plate modules, the tabbing is relatively simple and easy to fill with EVA. For our receiver, with multiple fingers, it is more difficult. The pressurized diaphragm eliminates any voids.

Dual station

The encapsulator contains two stations that are set parallel to each other on either side of the table. The operator can load one receiver for encapsulation while the other is processing. The commonality of parts reduces equipment cost. Reserve equipment assemblies are held in inventory so that periodic servicing may be completed with minimal process disruption.

Tests

A number of different tests were run to determine if the concept of EVA encapsulation was valid for concentrator receivers and also to determine the best process. Early in the PVI

PVMatn program we made a number of test receivers in a small prototype encapsulation oven. These small receivers were tested in various ways. We then made a larger oven and full size receivers. The larger receivers were also tested. We used the experience gained with these early prototype ovens to design a prototype encapsulator along the lines of the final production version. A production encapsulator was finally built.

Receiver tests consisted of the Sandia Qualification Tests and ultraviolet radiation testing. We also measured the transmission through the plastic used for our lenses. We also performed long-term outdoor tests on our roof at one-sun and under concentration. EVA samples were tested under ultraviolet radiation with and without acrylic sheets over them. The Sandia Qualification Tests consisted of subjecting sample receivers to thermal cycling and humidity/freeze cycling to simulate aging and to test adhesion.

The spectral distribution from our lens was tested at NREL. The intensity at different wavelengths was determined for different locations at the focal plane.

The prototype encapsulation ovens were used to conduct process evaluations. Different temperatures, pressures, and times were tried. We started with the process variables recommended by the EVA manufacturers, but soon found that because of our unusual configuration (not flat plate) that we had to experiment beyond the normal range. We also experimented with EVA from different manufacturers.

Results

No degradation or delamination of the EVA was found during the thermal cycling and/or freeze humidity cycling prescribed by the Sandia Qualification Tests. We did experience some delamination of the top film. This delamination was traced to a manufacturing flaw in the film. The film surface has to be treated to stick to the EVA. These samples were not treated correctly. Production versions of the film are supplied under specification control.

Samples tested in the ultraviolet light without the acrylic cover performed as expected. They showed slight yellowing at the end of the test. The samples under the acrylic cover did not show yellowing.

Results of measuring the spectral transmission of our lens in the ultraviolet range can be seen in Figure 34. The figure show the flux distribution across the focal plane for different wavelengths of light. The maximum ultraviolet radiation at 350 μm is approximately the same as flat plate modules.

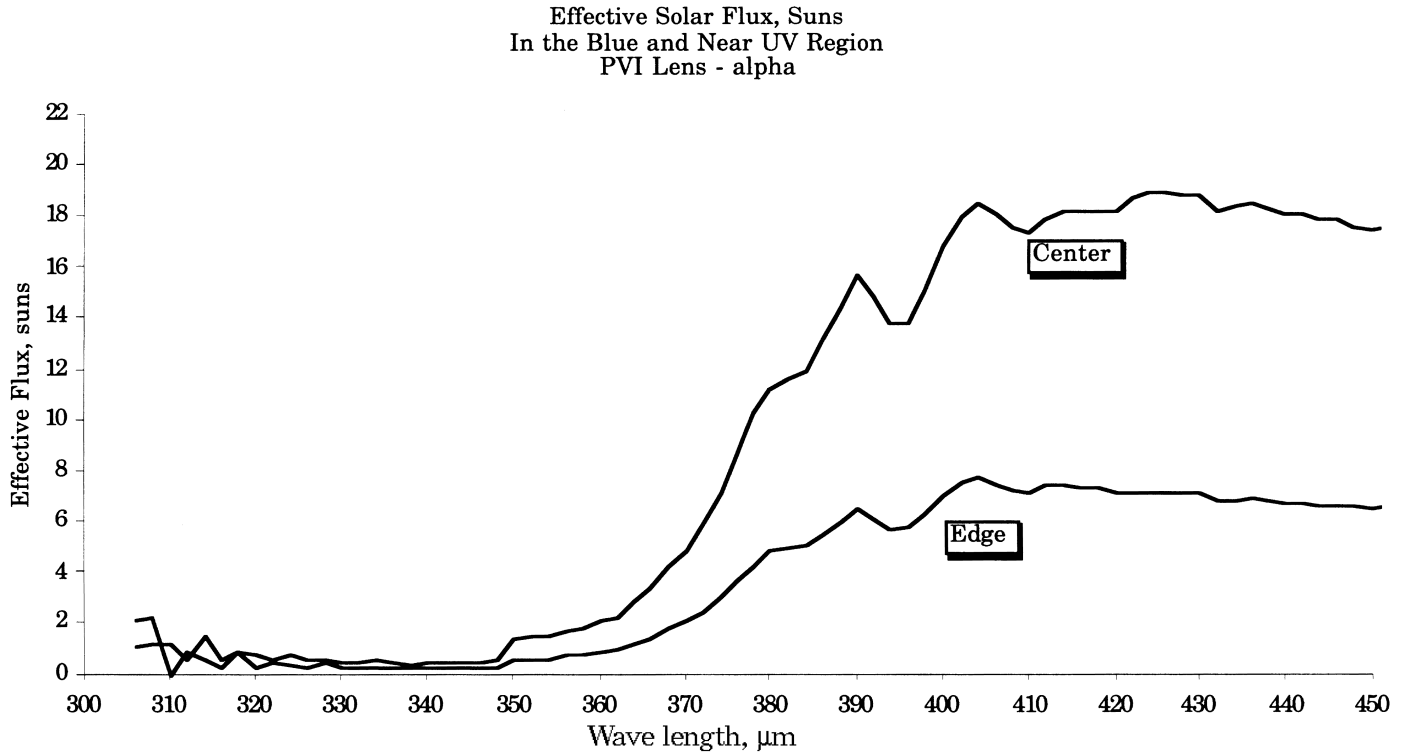

Figure 34, Spectral Transmission of PVI Lens in the Ultraviolet Range

Our first attempts at void free encapsulation were not successful. We developed a proprietary "platen" and bladder pressure controls. We also found the best temperature schedule. Slight modifications to the receiver were also necessary to provide a void free area around the leads.

Early experiments resulted in cracked cells. This was solved by a combination of using the correct receiver mechanical design to support the cells, the correct temperature schedule, and the correct pressure.

None of the receiver sample that have been on long-term outdoor testing have shown any signs of delamination, yellowing, or other degradation.

Production time for the encapsulator is approximately one hour. Since there are two stations per encapsulator, one encapsulator can produce 48 receivers per three-shift day. This is equivalent to 1.6 MW/yr per station.

Conclusions

EVA can be used in our concentrator receiver. The special filtering by the lens and the film over the cells allows EVA to be used.

We have developed special equipment that is necessary for EVA encapsulation of our receivers. The equipment provides quality receivers at low cost and low energy consumption.

Each encapsulator produces approximately 1.6 MW/yr. Additional capacity can be added easily by adding more encapsulators. We are currently producing a second encapsulator.

3.4 SOLVENTLESS ASSEMBLY

Overview

All solvent containing adhesives have been eliminated from our module assembly. We no longer use adhesives to bond the various plastic parts together. This is because the plastic parts, except the lens, have been replaced by aluminum parts. This has resulted in a much stronger, lighter, and less expensive module. Plastic is in itself less expensive than aluminum. But, as our module grew in size over the years, the plastic could no longer be self-supporting. This required additional structure that significantly increased the cost and weight.

The new module sides are made from roll formed, recycled aluminum. They come complete and ready to install, eliminating extra labor that was present with the previous plastic sides. The sides snap to the receiver and are screwed to the end cap. The lens is clipped onto the top of the sides. A butyl rubber gasket is used in the lens-to-side joint and the side-to-end-cap joint. No gasket is necessary where the sides join to the receiver. That joint is designed to be water shedding.

The new end caps are die-cast, recycled aluminum pieces. They are one piece and replace a complicated assembly of steel and plastic parts used in the previous design. The end caps are screwed to the receiver and to the module sides. Butyl rubber gaskets are used.

The module components can be shipped disassembled or can be shipped assembled into a tub (a module without a lens). The tubs stack inside each other for compact shipping. The advantage of tubing the modules is that less labor is done on site when that labor is relatively expensive. When field assembly is inexpensive, completely disassembled modules can be shipped. Also, when local content is desired, or if there is a tariff advantage, the modules can be shipped disassembled.

Rationale

Various manufacturing solutions to eliminating volatile organic compounds and hazardous materials were considered. We looked at a wide range of options from ultrasonic welding of the plastic parts to production of a reinforced plastic molding for the module housing. Total cost, manufacturing plus parts, was the primary determining criteria. Other determining criteria were durability and strength.

The design life for our module is 20 years, but we expect the module to last longer. We felt that we could not guarantee the plastic sides and end caps to last the 20 years because they had become load bearing members. Since the lens is not stressed, it should easily last longer than 20 years.

The module structure is basically a tube. The sides are a structural component. The most economical use of structural material would be at the largest diameter (largest moment per unit weight). With the plastic sides, we tried to add additional structural components to make

up for the low strength of the plastic, but these components still relied on the plastic for the backbone strength of the module. If the plastic failed, it was like having an I beam without the web. A higher strength material was needed for the sides.

In the previous design, we added reflective film to the inside surface of the plastic module sides to make them fully reflective. This added considerable cost. Testing revealed that there was diminishing advantage in reflectivity further than 4 inches away from the bottom of the module. If a way could be found to make the sides reflective only near the bottom, the cost per Watt could be reduced.

Features

- No volatile organic compounds or hazardous materials
- Snap together assembly
- Roll formed recycled aluminum sides
- Die cast recycled aluminum end caps
- Removable lens
- Separate reflective element
- Extruded aluminum heat sink

Advantages

- Elimination of volatile organic compounds and hazardous materials eliminates environmental, health, and monetary costs.
- Snap together assembly reduces cost of assembling modules in the factory and allows field assembly that can further reduce cost in assembly and shipping.
- Roll forming of the aluminum sides is a low cost fabrication method.
- The die cast aluminum end caps are strong, low cost, and one piece.
- The removable lens allows replacement in case of damage and field assembly of tubed modules.
- The separate reflective elements allows the use of smaller, less costly elements.
- The extruded aluminum heat sink provides good heat dissipation, strength, and necessary geometric details at low cost.

Detailed description

Elimination of volatile organic compounds and hazardous materials

Volatile organic compounds are a major contributor to smog. They combine with nitrogen oxides to form harmful ground-level ozone. A volatile organic compound is any volatile compound which contains the element carbon, excluding methane, carbon monoxide, carbon dioxide, carbonic acid, metallic carbides or carbonates, and ammonium carbonate. Most air quality management boards severely limit the allowable volatile organic compounds and the rules are getting progressively stricter as time goes on. PVI has eliminated the plastic adhesives that were the major cause of volatile organic compounds in the module assembly.

Hazardous materials are a major cause of health problems in industrial workers, including birth defects, cancer, dermatosis, and breathing difficulties. Hazardous and toxic substances are any chemicals present in the workplace which are capable of causing harm, including dusts, mixtures, and common materials such as paints, fuels, and solvents. The United States Occupational Safety and Health Administration currently regulates exposure to approximately 400 substances. There are hundreds of thousands of products that have Material Safety Data Sheets. By eliminating the plastic adhesive, PVI has eliminated all hazardous materials in its module manufacturing.

Eliminating volatile organic compounds and hazardous materials not only is good for the environment and the workers, but reduces cost. We have eliminated special handling equipment that was used in the past. We have also eliminated the cost of reporting and compliance to the government regulations controlling these substances.

Snap together assembly

The snap together joints consist of the joint between the receiver and module side, the reflector and receiver, and the side and lens. Each joint is designed for a specific function.

At the top of the receiver are the joints to the sides and reflector, see Figure 35. The module side is formed at the bottom in a shape that wraps around the joint at the top of the receiver. The matching part on the receiver has catches and a ramp. When the side is installed, it is placed in the bottom catch and sprung into the top catch by rotating it along the ramp.

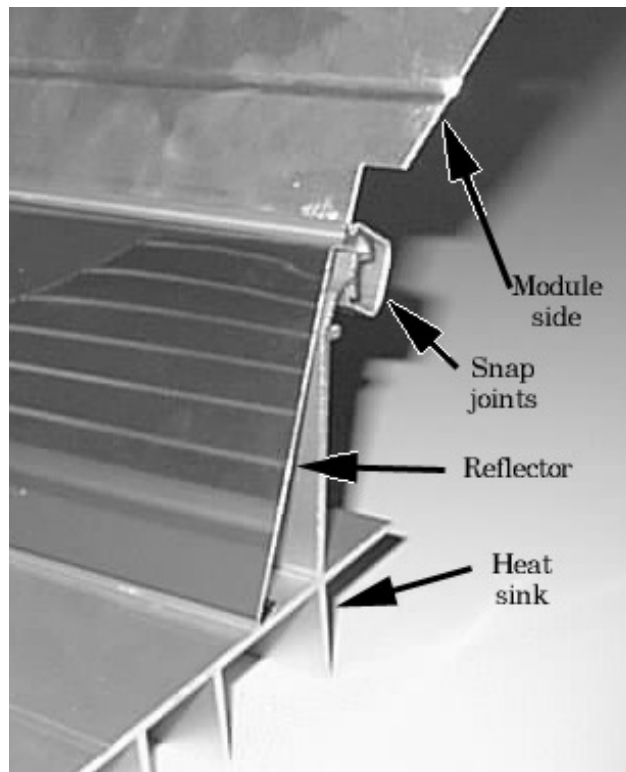

Figure 35, Joints at the Top of the Receiver

The reflector is also snapped into the top of the receiver but on the inside. When installed, reflector is parallel with the module side. During assembly, the reflector is pushed into the matching part on the receiver where it encounters a ramp. The corner bend in the reflector is pushed home where it snaps into a matching corner on the receiver.

Both the module sides and the reflectors can be installed without tools. A shelf on the receiver is provided in case the assembly person wants to use a pry lever. In our factory, a simple roller is used to facilitate pushing the reflectors into the receiver, but it is not necessary.

The lens sits on the top of the module sides. A groove in the lens fits over a flange on the top of the side, see Figure 36. There is a gasket between the lens and the side. An aluminum clip is placed over the lens and flange. It is held on by spring pressure in the clip. The clip is installed by hand without any tools. The lens can be removed by removing the clips.

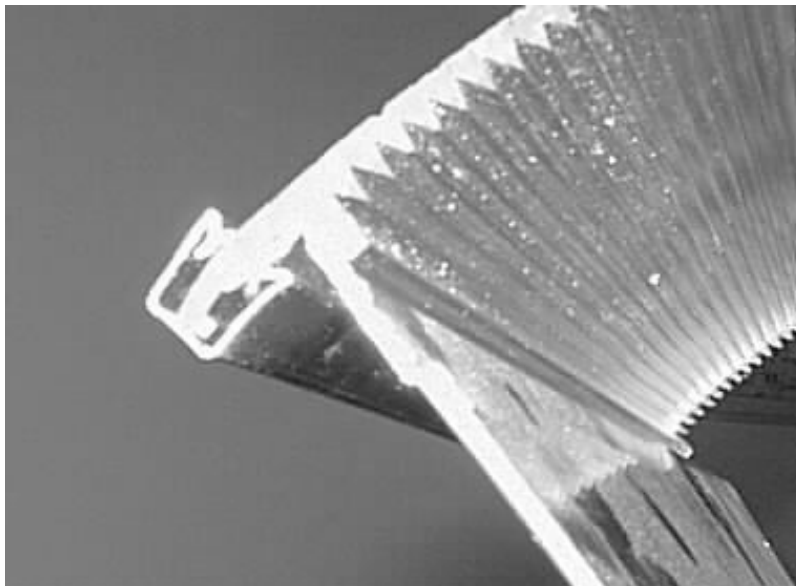

Figure 36, Lens to Module Side Joint

These assembly procedures can be done in the field if desired. Shipping the modules disassembled saves shipping costs and allows local content, which is very important in some foreign countries.

Roll formed aluminum sides

Roll forming is a low-cost method of forming linear parts from sheet aluminum, see Figure 37. Tooling is more expensive than extrusion, but piece part cost is lower. Also, it was impossible to extrude aluminum in the dimensions needed for the module sides. We looked at roll formed sheet steel sides, but the finishing required for long life brought the overall cost up over that of aluminum.

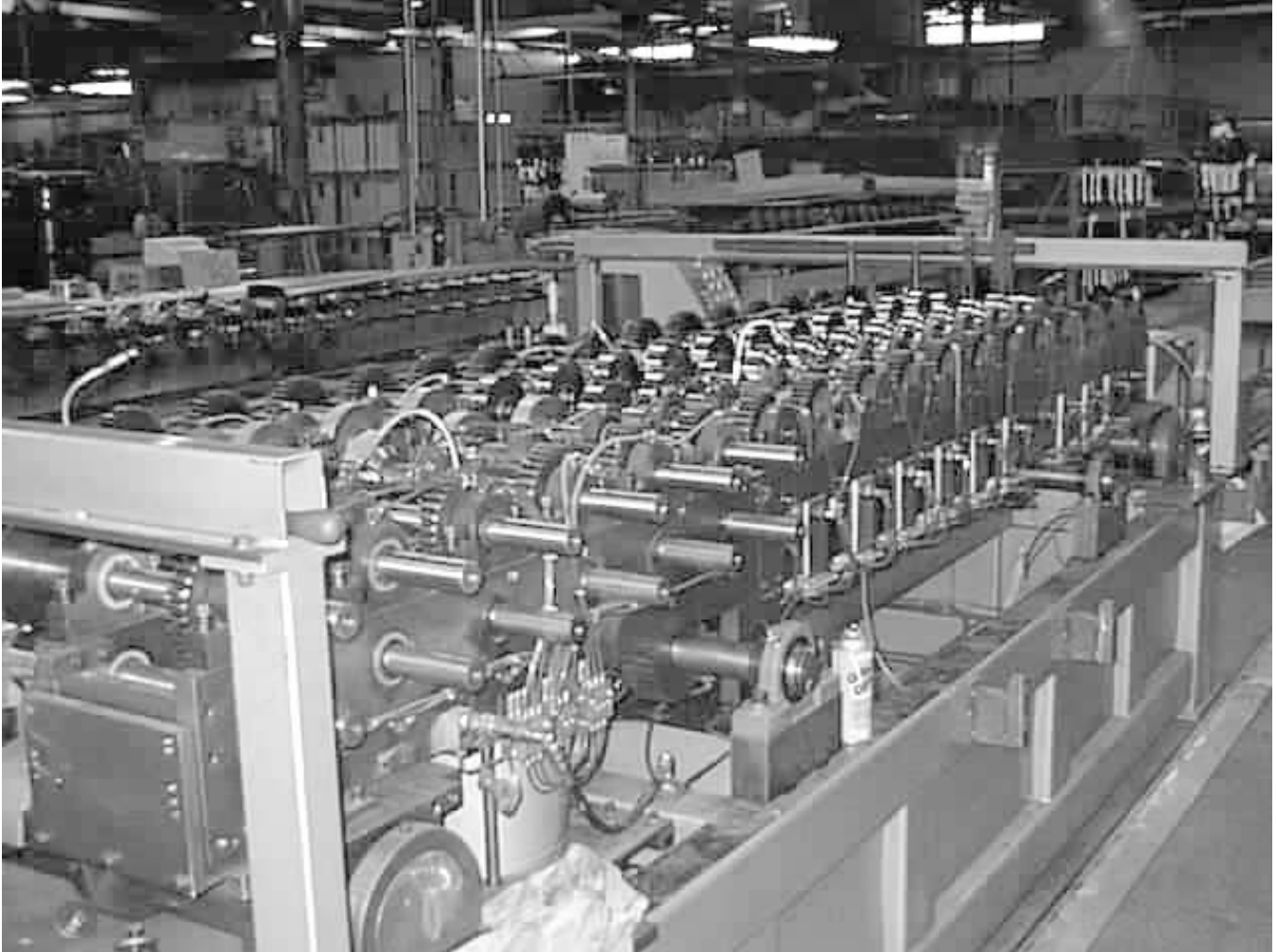

Figure 37, Rolling Machine for Rolling Sides

The sides have stiffening ribs rolled into them, see Figure 38. These ribs eliminate any tendency for the sides to "oil can" (Flex in a bi-stable state).



Figure 38, Rolled Aluminum Side and Box of Sides

Die cast aluminum end caps

The end caps were designed to be stamped, see Figure 39. This is the lowest cost method of forming the end caps in very high volume. However, for initial production, die casting is lower cost. We anticipate that we will switch to a stamped version in three to four years.



Figure 39, End Caps, Outside of Bottom and Inside of Top

The end cap dies have inserts in them that can be installed or removed. These inserts provide the holes for drains, access, or tracker pins. During manufacturing, the inserts are selectively installed to make top end caps or bottom end caps. The top end caps have the tracker pin but not the drains or access hole. The bottom end caps do not have the tracker pin but do have the drain holes and the access holes. Rubber valves are placed in the four drain holes to prevent insects and dust from entering while allowing any water from internal condensation out. The access hole is closed with a plastic plug. The access hole can be used to clean out the inside of the module, if necessary, using a water spray.

Removable lens, tubbed modules

If the lenses are damaged by vandalism or accidents, they can be replaced. This saves the cost of the entire module. The lenses are installed with clips as described above. The ends of the lenses are formed in a secondary operation as described in Section 3.1 to provide an accurate seal at the end caps and to allow the use of the clips.

The modules nest inside each other without the lens attached. This allows dense packing and reduced shipping costs. The packing is not as dense as separate pieces, however. The use of tubing instead of completely disassembled modules is justified under certain conditions of field labor cost and shipping distance. The tubs can still be shipped six to a crate with the

lenses stacked in the same crate. Placing the lenses on the tubs can be done in a relatively short time. Figure 40 shows tubed modules with transverse tension members temporarily installed.

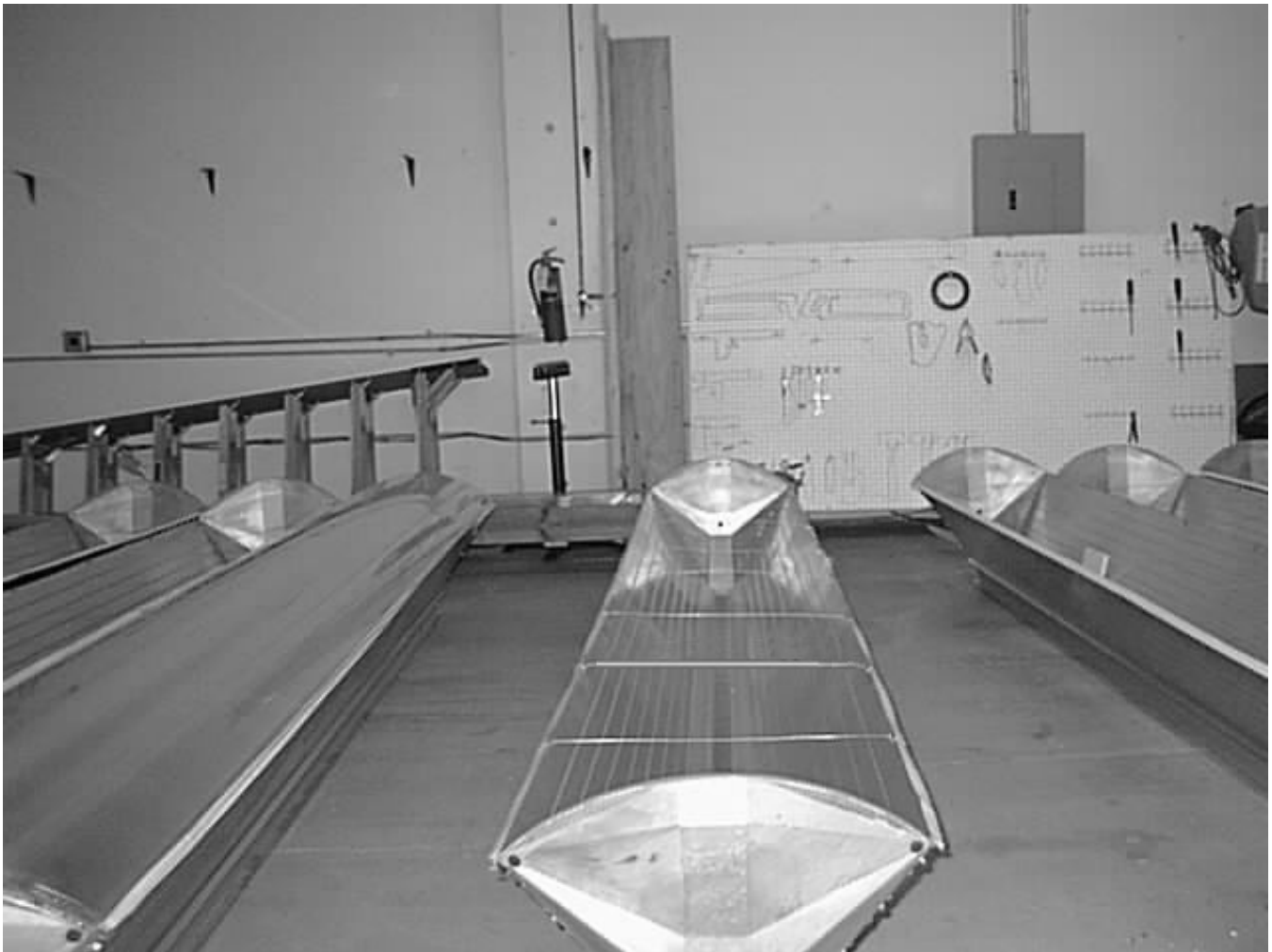

Figure 40, Tubed Modules

Separate reflective elements

The fully reflective sides have been replaced by a small reflector at the bottom of the module and the factory finish aluminum sides further up. We found that there is an economic tradeoff between the cost of the reflectivity and increased performance. The present reflectors are four inches high and represent less than 20% of the total side height. The heat sink wall has been extended up to provide a common point to join the sides and the reflector, see Figure 38 above.

Extruded aluminum heat sink

The receiver is extruded from aluminum. This is the best manufacturing method for this part. Intricate geometric details such as needed for the snap joints, can be easily added. Fins

also can be easily added as needed. Aluminum gives the best combination of cost, heat conduction, strength, and durability.

The heat sink was designed on a computer using a finite element program. Tests were done to verify the program results and then the program was used to further refine the heat sink. The extended sides used to fasten the module sides and the module sides have the added advantages of increased heat transfer, especially in still air, and increased strength and stiffness of the receiver. In the heat sink design, we not only considered the cell junction temperature at one meter per second wind speed (standard operating temperature), but also the maximum temperature under absolutely still air and high insolation. The vertical extensions of the heat sink significantly contributed to the natural convection heat transfer under these extreme conditions, allowing us to use the lower cost EVA encapsulant and extending the life of the receiver.

Tests

Finite element design

The Powergrid design was done using SolidWorks[®], a solid-modeling computer-aided design program. Where appropriate, the models created in SolidWorks[®] were then analyzed using Cosmos/Works, a finite element analysis program. Cosmos/Works plugs into SolidWorks[®] to work within SolidWorks[®] in a seamless manner. Figure 41 shows a typical output for the Cosmos program. In this case stress is represented in our pivot pin design when there is a load on the end of pin at 45° from vertical. The computer screen representation is in color. The picture shows maximum stress, as expected, where the pin diameter changes. Finite element analysis was done on all critical parts of the design.

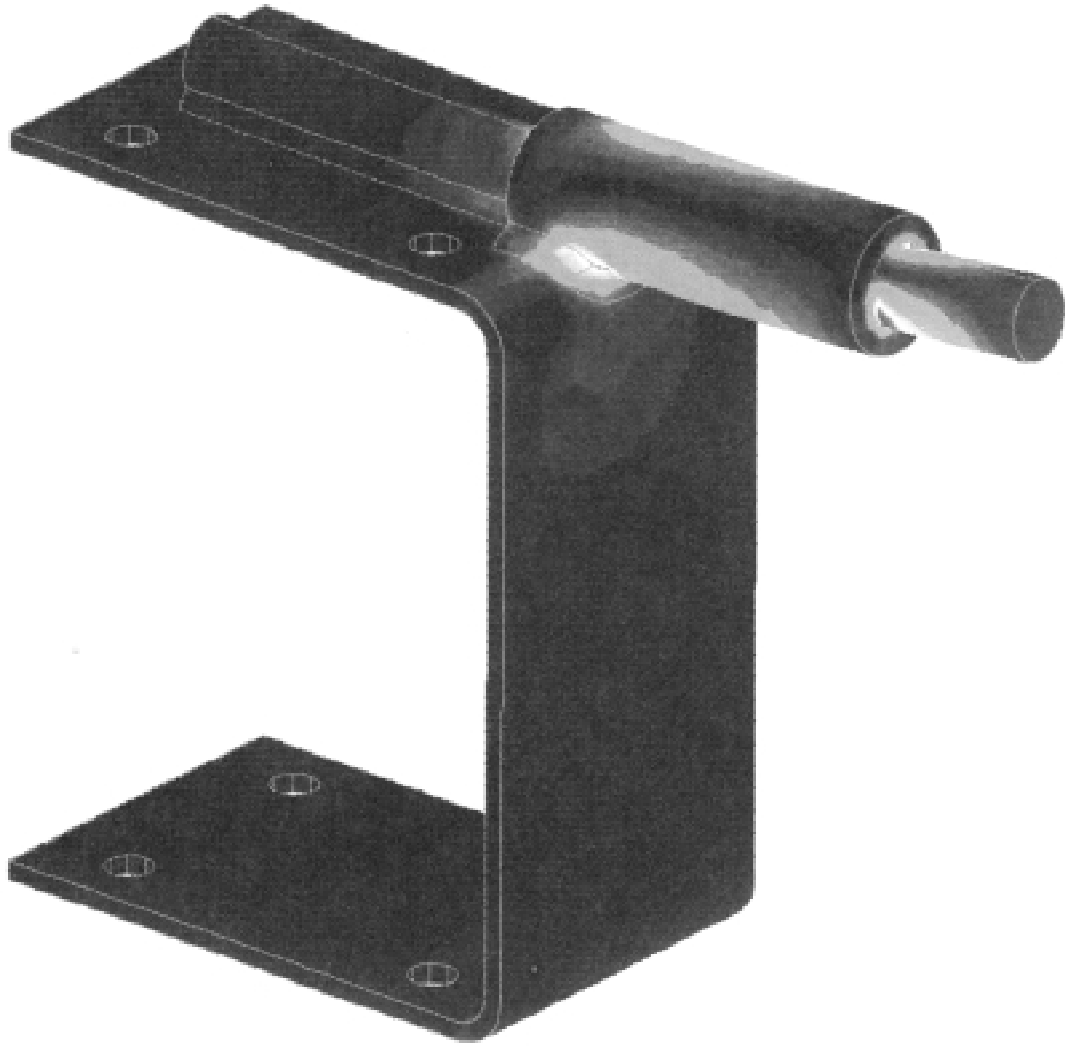

Figure 41, Sample of Cosmos Finite Element Analysis Program Output

In every case the yield stress was used as the design criteria. Maximum loads are due to wind pressure. We used 50 pounds per square foot as the design wind pressure which is conservatively equivalent to 100 miles per hour. The wind was assumed to act in the worse case, even though that case was unlikely.

Loading tests

The prototype module was statically loaded to simulate wind load at 100 miles per hour wind speed. For these tests we assumed a coefficient of drag on the module and standard air. These assumptions resulted in a wind pressure at 100 miles per hour of 50 pounds per square foot. From our later wind tunnel tests, see below, the wind pressure at 100 miles per hour is more like 45 pounds per square foot.

The static loading consisted of stacks of newspapers draped over the lens, see Figure 42. The newspapers were obtained from a recycling center and returned to the center after the tests. The module was supported at the pivot bearings and restrained from rotating by the tracker

pin. The load was applied uniformly over the lens and gradually. Prototype transverse tension members were used.



Figure 42, Prototype Module Static Test

Tests were also done on the lens alone. The sides of the lens were blocked from moving and newspaper was applied as above.

Wind tunnel tests

PVI contracted with the Boundary Layer Wind Tunnel at the University of Western Ontario to perform wind tunnel tests on a 1/6 scale model of the Powergrid, see Figure 43. The model was complete with 6 modules and a frame. The model was capable of rotating along the tracking axis and was fully instrumented with 504 pressure taps. The objectives of the test was to determine the wind pressure (drag coefficient) and the torque produced on the module in the tracking rotation by the wind. The torque produced has a direct bearing on the tracker design.



Figure 43, Wind Tunnel Powergrid Test Model

PVI also conducted internal tests on full size modules with a number of large fans producing wind across the module. These tests were very simple and were only designed to determine the torque values as discussed above.

Heat sink tests

Tests were conducted on prototype heat sinks using heat tape to represent the solar heat load. The tests were done in quiescent air with the heat sinks tilted at different angles. The object of these tests were to calibrate the finite element heat transfer computer model for quiescent air.

Outdoor module tests

Outdoor tests were performed on the heat sink to determine the thermal performance. The tests were done using complete modules mounted on a two-axis tracker, see Figure 44. Measurements were taken of solar insolation, both direct and global, and ambient and heat sink temperatures. These tests were used to determine the heat sink performance under actual conditions.



Figure 44, Outdoor Test of a Module

Results

The module assembly takes 30 minutes. A jig is necessary to get the proper alignment of the end caps. The assembly time is about 4% of the previous module assembly time. Part cost saving is substantial too.

Results of finite element analysis

From the finite element analysis, maximum stress in the module occurs in the end cap where the pivot pin bearing installs. Another stressed area is where the tracker pin installs in the end cap. We have added material to reinforce these areas. A third stressed area in the module is the transverse tension members that bond the module sides together. Without these members, the lens flattens and collapses under frontal wind loads. The remainder of the module, including the aluminum sides and lenses have low stress levels.

Again from the finite element analysis, maximum stresses in the frame is where the loads are concentrated, namely the pivot pins and the frame brackets. Maximum bending load in the frame members is comparatively low with a factor of safety of approximately 2.

Results of loading tests

The prototype module was loaded to 23 pounds per square foot before failure. The cause of failure was the prototype transverse tension members. These members had bent over ends that straightened out under load. After the transverse tension members let go, the lens flattened out and caved in. We plan to repeat the test under a full Institute of Electrical and Electronics Engineers qualification test scheduled for spring of 1999 using a production module. When the lens is adequately supported at the sides it can withstand 50 or more pounds per square foot. With the production transverse tension member design the module is able to withstand at least 45 pounds per square foot.

The production versions of the transverse tension members are placed in the module before the lens is installed. They remain in the module. From our testing they do not measurably decrease the module output.

Results of wind tunnel tests

The wind tunnel tests indicated that the module coefficient of drag changes depending on the rotation angle of the module. Using this coefficient of drag, the maximum wind load on the module is approximately 45 pounds per square foot at 100 miles per hour wind speed.

From the tests performed at PVI, the module has three angles of rotation that are stable relative to the wind due to vortex shedding. At other angles, there is a torque developed. For a complete panel, the torque is approximately 1800 foot-pounds at 100 miles per hour and 450 foot-pounds at 50 miles per hour. The panel does not have a wind stowing position, although under dark clouds the panel is designed to stow with the lenses facing upwards.

Cell junction temperature

Cell junction temperature under standard operating conditions of 850 Watts per square meter direct normal insolation, 20°C ambient temperature, and 1 meter per second wind speed is approximately 57°C. Under these conditions, heat sink temperature is 10°C lower than the cell temperature.

Conclusions

The PVI PVMaT program has been very successful in the module assembly area. Volatile organic compounds and hazardous materials have been eliminated. Assembly time has been reduced. Piece part count and cost have been reduced. Lower cost manufacturing processes have been introduced. The strength and quality of the module have been substantially improved. And the output has been greatly increased. All of this leads to a reduction in half of the cost per Watt to produce the Powergrid.

Calculated stresses will have to be verified under actual loading. We feel confident that there is sufficient conservativeness in the calculations to account for any errors. However, we plan to monitor early deployment of the new Powergrid to verify the design.

The transverse tension members are an important structural element. The module can withstand 50 pounds per square foot static load with the tension members.

Cell junction temperature is roughly equivalent to that of flat plate modules at standard operating conditions.

The maximum torque on the tracker gearmotor, as indicated by our wind tunnel testing, was beyond the recommended value from the manufacturer. We solved this problem by adding a clutch to the output shaft of the gear motor. In severe winds the modules will slip to limit the torque on the gear motor. The sensor arm is not affected by this slippage. Once the wind subsides, the panel can resume tracking without any adjustment. To date, we have not had any problems with the new tracker motor with the clutch installed.

3.5 ROLL-FORMED STEEL PANEL FRAME

Overview

The extruded aluminum frame members have been replaced by rolled galvanized steel members. The new frame members are 3.5 inches by 4 inches in section. The horizontal members are approximately 20 feet long and the vertical frame members are approximately 14 feet long. There are two half panels that make up a full panel. Each half panel has two horizontal frame members and two vertical frame members. Six modules are mounted on each half panel. The tracker bracket connects the two top horizontal frame members from the two half panels. There are other connectors that connect the bottom horizontal members and, in multiple panel arrays, the panel frames in each row.

There are two legs at the back of each half frame. These legs are also made of rolled galvanized steel and are 2 inches by 4 inches. The legs are different lengths depending on the latitude of the site and other factors. Generally, the panel is tilted equivalent to the local latitude. However, if there is a preference for output in the summer, the tilt angle is lowered. For winter output, the tilt angle is raised. PVI maintains a computer program to optimize the tilt according to the customer's needs.

Most of the connections are done using self-drilling, self-tapping #12 sheet metal screws. These screws are galvanized too. The screws are installed using powered nut drivers such as a portable battery powered electric drill motor. Normal building construction practices are used to assemble the frame.

The frame members are manufactured using a series of rollers to form pre-galvanized sheet steel into a C shaped section, see Figure 45. Holes are punched in the sheet steel and it is cut to length before it is rolled.



Figure 45, Rolled Frame Member

Rationale

A closed frame member is needed so that the frame is stiff in torsion. We did some early tests with open frames and found that they could rotate causing the module bearings to move and fall out. We initially looked for a roll forming company that could do a closed form with a lock. Typical examples of this kind of roll forming are galvanized steel down spouts for rain gutters. This type of roll forming is specialized and of limited gauge and size. We found some companies that could do this type of forming and we even designed our own set of rollers. However, the cost was expensive and success was not assured.

A more common type of roll forming is the open type as shown above. These structural shapes are used as purlins in building construction. Several companies make these shapes to order and they are available in several sizes. The rolling machine is quickly adjusted to provide the required size and a computer controlled punch can place holes at almost any location.

Because of the ready availability and the low cost, we elected to use the open type of construction. To obtain the required torsional stiffness we added a cover plate that is adhesive bonded and screwed to the frame member. This technique has the added advantage of allowing access to the inside of the frame member so that wiring harnesses could be installed.

At the same time we examined the economics of increasing the number of attachment feet. Our previous frame had numerous braces and other parts added to allow a 20-foot span and only four feet per panel. With eight feet and a 10-foot span, the frame size, part count, and overall cost were all drastically reduced. We were also concerned with shipping costs and ease of erection. The larger steel frame members would have been almost 40 feet long.

Features

- Roll formed frame members using standard metal building construction C-sections
- Sheet galvanized sheet steel closure for frame members
- Galvanized steel material
- Panel frame is in two sections

Advantages

- Use of standard C-sections used in the construction industry allows the use of various vendors, reduces the cost of the piece parts, eliminates tooling cost, and eliminates risk associated with a custom part.
- The galvanized sheet steel closure allows the use of the low cost standard components and allows access to the inside of the frame members while providing the required torsional stiffness.
- Galvanized steel is a durable, strong, low-cost material.
- While having the frame in two sections adds footings, the overall cost is reduced, the frame is erected easier, and it allows the use of a half panel for some applications.

Detailed description

Rolling process

The frame material is stored at the rolling plant in 2,000-pound coils. These coils feed the rolling mill as flat sheets. The sheets are cut to length on the fly by a computer-controlled shear. Any desired holes are also put into the flat sheets on the fly by a computer-controlled punch. Most rolling plants have only 5/8-inch diameter holes available at set distances from the center line of the sheet. The holes can be placed at any distance along the length of the part by the computer control. After the holes are punched, the sheets go through the rolling machine. The machine bends the sheet to the desired shape in a number of steps.

The depth of the shape can be changed easily by setting the rollers. The machine is stopped and then the rollers are unclamped, slid on the shafts, and re-clamped. Different width feed stock is used for different depths.

The width of the part is harder to change and requires a different set of rollers. To avoid the cost of changing rollers all the time, the rolling plant usually has several rolling machines, one for each width part.

Rolling frame members happens very fast and one rolling machine can make many hundreds of megawatts worth of frames per year. The cost is low and there are a number of factories that make these C-sections for the construction industry.

Wiring harness

A wiring harness is installed in the frame member. The frame member is not an approved electrical conduit. It also has sharps on the inside. For this reason, we consider the frame

member as an electrical tray and we have sheet metal inserts that protect the wires from the internal sharps.

The harnesses are made up and shipped separately. They are installed in the field. This allows the frame members to be dropped shipped to the site.

Frame details

The frames have a commonality of parts. The same bracket is used on the front frame member as is used on the rear frame member. The bracket is designed to interface with the feet in the front or the legs in the rear. The same feet are used in the front as in the rear. The feet can attach to the legs or the front brackets. The horizontal and vertical frame members are all 4 inches deep by 3.5 inches wide.

The legs are also rolled galvanized steel and come from the same factory. They are slightly different dimensions, 4 inches deep by 2 inches wide. There is one diagonal brace for each half panel and it is also 4 inches by 2 inches.

The same screws are used for all fasteners. These galvanized, self-drilling, self-tapping screws are best installed by electric drivers (electric drill motors).

The pivot pin locations for the top horizontal frame member have to be installed accurately. This is accomplished by using the track bar (that connects all the modules together for uniform tracking) as a gauge. All other parts can be located using a tape measure. The frame goes together using fairly standard metal building construction techniques.

Tests

Design process

The C-section engineering parameters, such as section modulus, were supplied by the factory. We checked them. We then developed a computer spread sheet to calculate the stresses. A wind pressure of 50 pounds per square foot, equivalent to 100 miles per hour wind speed, was used to calculate the loads. A factor of safety of two was applied to the yield point of the steel. The spread sheet was used to try different depths and widths and support spacings. In this way, the optimum design was determined.

Prototype frames were built. The prototypes were used to get a feel for the design and to determine any problems with the assembly process. Initial prototypes were made of aluminum, with the aluminum thickness increased to provide the same moment of inertial as a steel member. The initial prototype frames were very flexible and various braces were added to improve the stiffness. Later prototypes had the additional supports with the braces removed.

Results

The prototype frames, with modules added, have proved very durable. We have had a number of wind storms on our roof with no failures.

Conclusions

The roll formed frames are very cost effective. They are approximately one tenth the cost of the previous aluminum frames. The prototype frames on our roof now are very stiff as compared to previous prototypes. We do not anticipate any difficulties with the frames in the field.

4.0 CONCLUSIONS

All technical milestones and deliverables under the contract have been met. Manufacturing of the PVI Powergrid has been substantially improved. The key results of the contract are:

- In-house, advanced lens extrusion system in place and producing quality lenses
- Second generation automated cell assembly station operational
- The first ever EVA encapsulated concentrator receivers are in production
- Volatile organic compounds and hazardous materials have been eliminated in module production
- Durability, quality, strength and cost have all been dramatically improved
- A low-cost rolled steel frame manufacturing is in place
- Module assembly has been made easier by using snap together features
- High volume manufacturing techniques for the module components have been implemented

The PVI PVMaT program has been immensely beneficial to our company. We now have in place high volume manufacturing processes. The product cost has been halved.

Although the program was a success, we have identified areas where the product would benefit from additional effort. There is additional work to be done in cell manufacturing, adding adjustable tilt to the panel, integrating an inverter with the panel, adding automated receiver laydown, and cost reduction of the tracker.

REPORT DOCUMENTATION PAGE			Form Approved OMB NO. 0704-0188	
Public reporting burden for this collection of information is estimated to average 1 hour per response, including the time for reviewing instructions, searching existing data sources, gathering and maintaining the data needed, and completing and reviewing the collection of information. Send comments regarding this burden estimate or any other aspect of this collection of information, including suggestions for reducing this burden, to Washington Headquarters Services, Directorate for Information Operations and Reports, 1215 Jefferson Davis Highway, Suite 1204, Arlington, VA 22202-4302, and to the Office of Management and Budget, Paperwork Reduction Project (0704-0188), Washington, DC 20503.				
1. AGENCY USE ONLY (Leave blank)	2. REPORT DATE October 1999	3. REPORT TYPE AND DATES COVERED Final Technical Report, 27 October 1997 – 31 October 1998		
4. TITLE AND SUBTITLE PVMaT Improvements in the Manufacturing of the PVI Powergrid™; Final Technical Report, 27 October 1997 – 31 October 1998			5. FUNDING NUMBERS C: ZAF-6-14271-11 TA: PV906101	
6. AUTHOR(S) N.R. Kaminar, T. Alexander, J. Amaya, W.R. Bottenberg, P. Carrie, K. Chen, P. Hobden, G. Lawyer, J. Zimmermann, C. Sherring				
7. PERFORMING ORGANIZATION NAME(S) AND ADDRESS(ES) Photovoltaics International, LLC (PVI) 171 Commercial St. Sunnyvale, CA			8. PERFORMING ORGANIZATION REPORT NUMBER	
9. SPONSORING/MONITORING AGENCY NAME(S) AND ADDRESS(ES) National Renewable Energy Laboratory 1617 Cole Blvd. Golden, CO 80401-3393			10. SPONSORING/MONITORING AGENCY REPORT NUMBER SR-520-26661	
11. SUPPLEMENTARY NOTES NREL Technical Monitor: R. Mitchell				
12a. DISTRIBUTION/AVAILABILITY STATEMENT National Technical Information Service U.S. Department of Commerce 5285 Port Royal Road Springfield, VA 22161			12b. DISTRIBUTION CODE	
13. ABSTRACT (Maximum 200 words) Photovoltaics International, LLC (PVI), is improving the manufacturing of the Powergrid™ under the Photovoltaic Manufacturing Technology (PVMaT) program in five basic areas: development of an advanced, state-of-the-art lens extrusion system; development of an advanced, state-of-the-art module side extrusion system; development of a second generation automated receiver assembly station; development of low-cost roll-formed steel panel frame members; and development of an automated module assembly process with low usage of volatile organic compounds and hazardous materials. The results of the program were as follows: <ul style="list-style-type: none"> • Manufacturing improvements have led to dramatic improvements in performance, quality, durability and cost. • The first ever ethylene vinyl acetate encapsulation system for photovoltaic concentrators was developed, thereby eliminating volatile organic compounds and hazardous materials in our encapsulation process. • An in-house extrusion system was developed that produces the highest quality cell assemblies at low labor cost. • An advanced automated cell assembly station was developed that produces quality cell assemblies at low labor cost. • Solvents have been eliminated in the module assembly eliminating volatile organic compounds and hazardous materials. • Roll formed steel panel frame members have been introduced to production that have dramatically reduced cost. • A snap-together module assembly has been developed that provides low-cost field assembly of components and thereby also greatly reduced shipping cost. The Powergrid has the potential to be very low cost in the short term. The PVI PVMaT program should allow PVI to reach the cost goals set by the company. This, in turn, will allow PVI to become a substantial player in the PV market and will allow the DOE goals of increased application of PV to become a reality.				
14. SUBJECT TERMS photovoltaics ; Photovoltaic Manufacturing Technology ; PVMaT ; Powergrid™ ; frame manufacturing ; module production and assembly ; lens extrusion ; concentrators			15. NUMBER OF PAGES	
			16. PRICE CODE	
17. SECURITY CLASSIFICATION OF REPORT Unclassified	18. SECURITY CLASSIFICATION OF THIS PAGE Unclassified	19. SECURITY CLASSIFICATION OF ABSTRACT Unclassified	20. LIMITATION OF ABSTRACT UL	