

# **ENERGY SELF SUFFICIENCY NEWSLETTER**

**July 2005**

**Off-Grid Living  
Biofuels / Hydro / Solar / Wind**

- \* Electric Vehicles \***
- \* Al Rutan On Methane \***
- \* Homestead Wind Power \***
- \* Renewable Energy Safety \***
- \* The Fachongle Stove - Revised \***
- and more ...**

# TABLE OF CONTENTS

**Page**

<b>2</b>	<b>From the Editor's Laptop</b>
<b>4</b>	<b>Off-Grid Journal Ghost Writing</b>
<b>5</b>	<b>Al Rutan - The Methane Man</b>
<b>6</b>	<b>Prologue to Methane Gas</b>
<b>12</b>	<b>Small Wind Turbine Basics</b>
<b>17</b>	<b>Self Sufficiency in Africa The Fachongle Stove</b>
<b>20</b>	<b>Allergy Free Gardening</b>
<b>22</b>	<b>Many Hands Make Light Work</b>
<b>24</b>	<b>Passive Solar Building Design</b>
<b>25</b>	<b>The Boy is Crazy!</b>
<b>29</b>	<b>Work Safe !</b>
<b>31</b>	<b>Making Bio-Diesel More Green</b>
<b>33</b>	<b>Bio-Diesel in Germany</b>
<b>35</b>	<b>Electric Vehicles</b>
<b>37</b>	<b>Classified Ads</b>

## From The Editor's Laptop

by Larry D. Barr, Editor

### What Is Happening?



I started this publication to provide a resource for those interested in the "hands on" aspects of energy self sufficiency and off-grid living. It is not intended to be any sort of political forum, and it never will be. However, for us to ignore entirely those events in the political arena which directly affect our chosen mode of living would be to our detriment.

It is easy to become so involved in achieving our goals for our own homesteads, that we disregard the big picture. I've discussed complacency previously in these pages, and we are too many times guilty of it in matters political.

Given the cold, hard fact that the vast majority of elected officials worldwide are not educated in renewable energy sources and utilization, it is not realistic to expect them to promote it. Add to that the fact that they are continually subject to the pressures of paid lobbyists, each promoting the individual points of view of their employer. Those points of view will inevitably be beneficial to those who foster them. Let's look briefly at a few current examples.

Recently, America's President Bush visited a commercial biodiesel production facility in Virginia. He said all the right things, stating that biodiesel was one of the fuels of the future. Regrettably, there is no funding, no government subsidies, in the works for ongoing biodiesel development. It is not enough to merely say the right things, it is essential to also do the right things.

In the US Senate, Senators Warner and Alexander have submitted a bill called the, "Environmentally Responsible Windpower Act." This bill, if passed, would disqualify wind farms located off coasts, near military bases, in national parks, and in other potentially sensitive locations from receiving a crucial federal tax subsidy.

While introducing the bill on the floor of the Senate, Senator Alexander said, "My studies suggest that at a time when America needs large amounts of low-cost, reliable power, wind produces puny amounts of high-cost, unreliable power. We need lower prices. Wind power production raises prices."

In a statement denouncing the Warner-Alexander bill, the American Wind Energy Association stated, "By severely limiting new wind energy development, Sen. Alexander's anti-wind bill would result in more air pollution and more acid rain from burning fossil fuels while also eliminating thousands of American jobs, many located in rural America."

Regardless of the senator's individual motivations for the introduction of such a bill, we cannot deny that legislation of this nature runs directly counter to what we believe in.

Continued on next page

## Energy Self Sufficiency Newsletter

[essn@rebelwolf.com](mailto:essn@rebelwolf.com)

### Editor/Publisher

Larry D. Barr

### Contributing Editors

Maria (Mark)Alovert

Al Rutan (RIP)

Steve Spence

Mike Nixon

Jerry Dycus

Laren Corie

Tom Ogren

Bryan Ball

Dan Fink

### Graphic Artist

Aaron W. Cagle

### Advertising Director

Steve Spence

[ads@rebelwolf.com](mailto:ads@rebelwolf.com)

All contents © 2005  
Rebel Wolf Energy Systems

The so-called "Hydrogen Highway" is another highly touted plan for our energy future that, as presented, has some glaring deficiencies. The major one is the simple fact that the preferred method of deriving hydrogen is by steam reforming from natural gas. That being the case, what is being presented as an alternative fuel is simply another fossil based fuel. Were the producers to utilize electrolysis from renewable sources of electricity, then the Hydrogen Highway moves closer to becoming a viable component of our energy future.

We must remember that many of these ideas are being promulgated by big energy companies who have a vested interest in maintaining the *status quo* with minimal, if any, changes. From their point of view, with an investment of billions of dollars in the existing infrastructure and a responsibility to their shareholders, this is the only logical course of action.

However, with peak oil rapidly approaching, global warming considered by many a certainty, and the natural resources of Planet Earth being ever more heavily depleted, we are forced to accept that the future must eschew the ways of the past. I've used examples from the USA here, simply because that's the country with which I'm most familiar. However, I'm aware that similar events are happening around the world. In many cases, resistance to renewable energy installations suffers from the NIMBY syndrome. Not In My Back Yard. Many people agree that wind power is a good idea, but nobody wants to look out their window at a wind farm.

Yes, a wind farm will alter the landscape, but that's not necessarily a bad thing, for the change will confirm by its presence that we are acting in a positive way to preserve the resources of Mother Earth. It may take a "little getting used to" but humans are an adaptable species. We adapted to vast oil fields, coal burning power plants and raw sewage flowing into our oceans and rivers. And we're coming to realize that many of the things we adapted to were not really good for us or for our planet.

It is our responsibility, our duty, not only to ourselves but to our planet and to future generations, to spread the word about renewable energy. We must strive to educate others about the necessity and the benefits of using renewable energy sources, and the pleasure and satisfaction of sustainable living. If you are anything like me, you're already talking to your friends and folks you meet about RE, simply because you are so passionate about it. That's a good thing and you, like me, will keep doing it. We can't help it. We love talking about it.

But let's not stop there. Remember I mentioned complacency earlier? This is where it applies. It's easy to talk to our friends because we're just having a conversation. "Hey, I added two more PV panels this week" or "Just by changing to CFLs I cut twenty bucks off my electric bill" or "I'm getting 50 miles to the gallon in my Jetta on biodiesel." But it's more difficult to break out of our complacency and let our elected officials know how we feel.

However, with very few exceptions, if we collectively fail to tell our representatives about renewable energy, to educate them if you will, there is no chance that they will promote future developments that reflect and support sustainable living. They are continuously inundated with so many requests for attention from so many different special interest groups that many times they can only act on information from their aides or consultants. Or from lobbyists who have their ear.

I believe that we must, being dedicated to sustainable living and the utilization of renewable energy, each make it a personal mission to introduce our local, state (or province) and national legislators to the tenets of sustainable living and the necessity of environmentally friendly renewable energy adoption. You can locate your legislator's contact information on the Web, so do that and let them know that these issues are important to you and to the future. If they come to town, take a chance to meet them and, again, let them know what's important to you.

Complacency is the enemy of progress. Let us all vow to shed our complacency, to attend to the details of conservation in our homes and our vehicles, and to spread the word of sustainable living and renewable energy to, not only our friends, but also to our elected officials. Together we can make a positive difference. ldb



## Off-Grid Journal

### Changing of the Guard, again



Life throws curve balls sometimes, and Greg and Chandra were thrown a doozy. They won't be able to join Green-Trust this year, but are likely to come on board sometime next year. In their place, we have our esteemed Human Powered Vehicle contributor, Bryan Ball, Managing Editor and his family coming in August. See <http://www.benrideronline.com>

### What have we been up to?

Still gathering components and info for a Veggie Oil powered RV. Still need a diesel bus.

Making biodiesel from ethanol with Rich Reilly of <http://www.biodieselwarehouse.com>

Teaching Appleseed biodiesel processor classes. Next one is July 24th at <http://www.tevacenter.org/> in CT and is open to the public. \$15 registration, plus \$35 at the door. Includes Girl Mark's Biodiesel Home Brewers Guide, Version 10.

Developing a 12vdc dimmable cold cathode fluorescent light fixture for off-gridders and rv's. Power consumption is 0.005 amps at 12vdc for the single bulb fixture, can run two bulbs.

More on these projects in their respective articles.

We aren't all work and no play, sometimes we have a bit of fun with friends.

Steve Spence  
Dir., Green Trust  
<http://www.green-trust.org>

Contributing Editor  
<http://www.off-grid.net>  
<http://www.rebelwolf.com/essn.html>

## Ghost Writing

Hey folks, do you have experiences you'd like to share with other ESSN readers. Many of you have energy self sufficiency related experiences or information that you'd like to share with ESSN readers. If you're comfortable writing, please submit your article to [essn@rebelwolf.com](mailto:essn@rebelwolf.com)

On the other hand, if you'd rather not do your own writing, this forum is the place where you can get together with folks who'd like to do some writing with you at this [Green Trust forum](#).

So, if you're one of those folks who wants to work on a collaborative article, just post here that your available and check out the posts from the folks who are looking for you.

I'm hoping to see a lot of fresh content for ESSN come from this forum. We'll be waiting for your posts. All of you!

Peace,  
ldb

### 12.5 kW BIODIESEL GENERATOR



**This is the heaviest duty 12.5 kW generator ever built combining the 2-71 Detroit Diesel engine with extremely heavy duty Delco or Emerson brushless alternators. The alternators are all copper wound and usually load test at over 15-20 kW.**

**The 2-71 diesel is the best engine because of its simple design, extremely heavy duty construction, reliability, low 1200 RPM, parts available worldwide, and because it is easy and inexpensive to work on and rebuild.**

**THIS IS THE GENERATOR STEVE SPENCE CHOSE FOR HIS OWN BIODIESEL SYSTEM!**

**We offer completely rebuilt units starting at \$4,395 FOB. We can add gas tanks and mufflers at additional cost.**

[www.affordablepower.com](http://www.affordablepower.com)  
1-888-454-1193 x 4

# AL RUTAN - THE METHANE MAN



There were just a few of us, collaborating via the Internet in the closing months of 2004, planning for the New Year's Eve debut of Energy Self Sufficiency Newsletter. Me, Steve Spence, Laren Corie, Maria 'Mark' Alover, Mike Nixon and Al Rutan. The Premiere Issue of ESSN "hit the stands" and life was good.

Then, on 9 January 2005, tragedy came to our renewable energy family. Al Rutan passed on. Death is a natural part of the life cycle and is inevitable. But that in no way lessened our sense of loss as we mourned Al's passing and the loss of his contribution to our movement and to our publication.

For many people, methane production is a very viable component of energy self sufficiency, and Al's writings were a valuable part of our message to you, our readers. Al had contributed several articles to Home Power Magazine before his death, and Ian Woofenden and the Home Power staff have graciously given us permission to reprint those articles.

We are proud to present, once again, Al Rutan's words in the pages of Energy Self Sufficiency Newsletter. Special thanks to Ian and the group at Home Power Magazine for their generosity.

Al, welcome back to ESSN. Your wisdom and knowledge are an indispensable part of our message. We'll always remember you. ldb

## Prologue to Methane Gas

Al Rutan, the Methane Man

©1991 Al Rutan

Home Power #26 • December 1991 / January 1992  
Alternative Fuels

### Gas Use

What about flammable gas? Why consider it? For those of us who spent much of our youth chopping wood to heat and cook at home, the idea of gas is like something from paradise. The idea and the experience of merely turning a valve to have instant flame without all the “bitching” and complaining involved in “go get that wood!” is amazing.

Almost everyone likes the ambiance around a campfire on an outing with friends. But for the day to day fuel needs, we wish to have it as “automatic” as possible, and for being controlled by a thermostat, gas is unsurpassed.

It is clean and uncomplicated. Clean? Yes, clean. There is no soot that collects in a chimney from the burning of methane gas. Does it need to be vented? It should be, if at all possible. The fumes from any type of combustion should be considered suspect.

Potential problems from the burning of methane are minimal. If the combustion is complete, what is produced is carbon dioxide and water vapor. Yet we have no practical assurance that combustion is always as perfect as it could be.

An interesting note historically is the fact that the Indian government some 40 years ago pushed the development of homestead production of methane because so many people were going blind from the effects of burning cow dung for fuel. Our early pioneers had similar experiences from the burning of buffalo chips. Burning raw manure should always be considered a “no-no.”

Low-tech methane production information comes from both India and China—two countries with vast populations, huge pollution problems from waste, and an immense need for fuel, which isn’t readily available.

### At Home

Our interest stems from the fact that homestead methane production is one more way to unplug from a utility company and provide access to energy, which substantially contributes to the quality of life.

So, one has to have the heart for it. Unlike electricity, that is for all practical purposes quite mechanical, gas production

means tending to living things, like a flock of chickens, a band of sheep, or milking goats. For abundant gas production, there needs to be a sensitivity to the special needs of the microscopic creatures that produce flammable gas as their waste product. This means providing for their basic wants and—don’t laugh—giving them a measure of love. All living things—plants, animals, and people—require love in order to flourish. This need extends even to living creatures that can’t be seen with the naked eye.

A person we know who had a methane system one day went up to his tank and gave it a good hefty kick as an experiment. The gas production stopped immediately, and started slowly again only after some time had passed.

Because one must assume responsibility for the care of a colony of living entities, producing gas to burn has another dimension some may need to consider before undertaking such a venture.

The advantages of gas are many-fold. It is so easy to use. It is so controllable. It is relatively easy to store. It can be used automatically. It will even run your vacuum cleaner if you put the methane gas through a fuel cell which will turn the gas directly into electricity. Plus, it is so clean—no soot, no creosote, no ash, and no chopping. What more could you ask?

### Making and Using Methane Gas

Methane is a natural gas. The reason it’s called “natural” is because it occurs in nature everywhere. It can be the gas found in a swamp or marsh, the gas found in a coal mine, the smell coming from a septic tank or sewer line, or the gas sold to us by a utility company under the title of “natural gas.” The product is substantially the same, CH<sub>4</sub>.

We’ve heard that methane is odorless, and it is. Sewer gas we know is not. So what is the difference? When the process that produces gas is underway, there are a variety of gases produced at the same time. All such gases result from microorganisms feeding upon organic matter and producing gas as a waste product. Methane, which is odorless, is one of them.

Continued on next page

All these burnable gases are produced by anaerobic organisms feeding upon organic matter. To say they are anaerobic means they only live when air is excluded from the space in which they are functioning.

They are the same organisms that cause us to have intestinal gas. Each time a warm blooded animal defecates, some of the gas producing organisms are contained in the feces. This is why it can be said that methane occurs virtually everywhere. Wherever air is excluded from the decomposition process, the production of methane and accompanying gases is likely to occur.

Stories are legion about a bunch of guys with nothing better to do than ignite the intestinal gas of one of their particularly "gassy" buddies, and then being amazed at how flammable the experiment was.

The micro-organisms that produce flammable gas are temperature sensitive. They want body temperature in order to function most effectively. In people that is 98.6°F. In a chicken or a pig the body temperature is 103°F. So right around 100°F is the optimum temperature for the process to work most effectively. The action can occur at lower temperatures. As the temperature drops so does the rate at which methane gas is produced.

People will sometimes ask, "Why can't I use the gas off my septic tank to burn in a stove?" The typical septic tank swings through such wide temperature fluctuations, the amount of gas produced is minimal. Each time a toilet is flushed with cold water, the tank goes into "shock." Each time some warm wash water from a bath or shower flows into the tank, it becomes more active until the next shot of cold water. Such tanks are ordinarily in the ground, which stays at a constant 50° to 55°F. The ground is a constant heat sink, draining heat away from the tank. About all one gets from a septic tank, by way of gas, is enough to cause an unpleasant odor. Because Hydrogen sulfide, which is smelly, is another. It is hydrogen sulfide which gives us the characteristic sewer gas or "fart" smell.

When these gases are encapsulated in the ground over a long period of time, the smell is purged, leaving an odorless gas. The sewer gas smell can be removed easily from the mixture by simply bubbling all the gas through calcium carbonate, which is simple barn lime, and thereby scrubbing it so to speak. The gas becomes odorless. The gas companies re-introduce an odor to odorless gas before selling it as a safety measure so that our noses can detect "loose gas" that could be potentially dangerous.

All these burnable gases are produced by anaerobic organisms feeding upon organic matter. To say they are anaerobic means they only live when air is excluded from the space in which they are functioning.

They are the same organisms that cause us to have intestinal gas. Each time a warm blooded animal defecates, some of the gas producing organisms are contained in the feces. This is why it can be said that methane occurs virtually everywhere. Wherever air is excluded from the decomposition process, the production of methane and accompanying gases is likely to occur.

Stories are legion about a bunch of guys with nothing better to do than ignite the intestinal gas of one of their particularly "gassy" buddies, and then being amazed at how flammable the experiment was.

The micro-organisms that produce flammable gas are temperature sensitive. They want body temperature in order to function most effectively. In people that is 98.6°F. In a chicken or a pig the body temperature is 103°F. So right around 100°F is the optimum temperature for the process to work most effectively. The action can occur at lower temperatures. As the temperature drops so does the rate at which methane gas is produced.

People will sometimes ask, "Why can't I use the gas off my septic tank to burn in a stove?" The typical septic tank swings through such wide temperature fluctuations, the amount of gas produced is minimal. Each time a toilet is flushed with cold water, the tank goes into "shock." Each time some warm wash water from a bath or shower flows into the tank, it becomes more active until the next shot of cold water. Such tanks are ordinarily in the ground, which stays at a constant 50° to 55°F. The ground is a constant heat sink, draining heat away from the tank. About all one gets from a septic tank, by way of gas, is enough to cause an unpleasant odor. Because the temperature cannot be maintained at the required working level, such tanks have to be pumped from time to time. The solids cannot be efficiently digested and so keep building up.



Continued on next page



## Key Considerations

It is the concept of a tank which offers us the most practical approach to the task of harnessing the production of methane. Liquid within a tank gives us two immensely important features—transport and the exclusion of air. Both are essential for maximum production.

Some methane production occurs in such places as an ordinary barnyard manure pile. The center of the pile is without air and with the heat generated by the pile some methane gas is bound to be produced. If we want to harness the concept, we will need a great deal of gas. A solid pile to give us what we would need would have to be, literally, a small mountain. In a tank, it's an entirely different matter. It is much easier to have the tank "just bubbling away" so that the amount of gas collected in a short time can be significant.

For "home-made methane," our pressure regulator is not any more complicated than a heavy rock on an inflatable gas holding bag, or the weight of a solid yet expandable gas holder floating in liquid. It's not very complicated.

## How Much Gas Does One Need?

To estimate the amount of gas needed, the average family of four burns somewhere around 200 cubic feet of gas a day. This covers the combined tasks of cooking, heating space and heating water. Obviously, individuals can trim this amount considerably by using efficient appliances, such as flow-on-demand water heaters, and high-efficiency space heaters.

The best way to get a handle on this information is to look at the amount of consumption listed on the utility bill of some family you know and then observe their lifestyle.

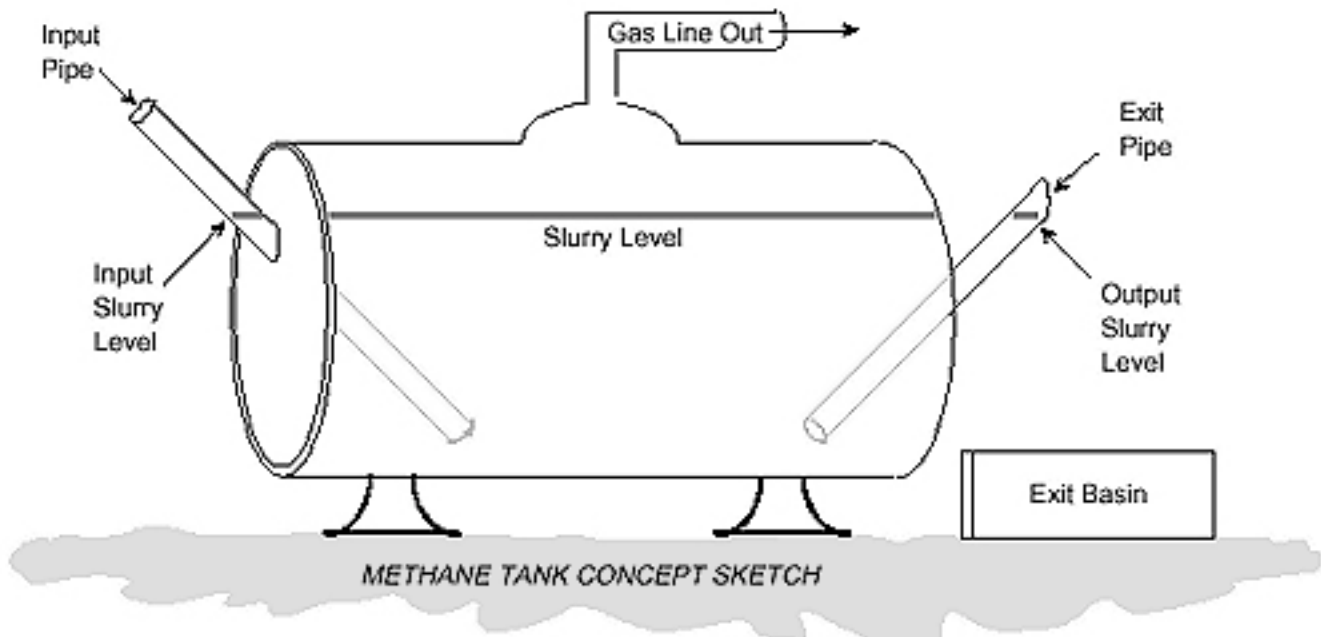

## Key Questions

How much gas do I need? That will determine how much gas must be produced. Next is, how much material do I need to produce this amount of gas? The third question is, how large must the equipment be to produce and store this amount of gas?

Gas is thought of in terms of cubic feet. We can all visualize a cubic foot—12 inches square in each direction. The amount of gas within such a space of 12 inches square is determined by the compression of the gas. Fortunately, when we are working with methane, we are talking about only ounces of pressure—just enough pressure to push the gas to the burner, whether it might be a stove, water heater, or refrigerator.

## Processes of Gas

We say that the liquid provides transport. That transport is two-fold. Obviously, we must transport the material to the tank. Equally important, yet not so obvious, is the transport of the micro organisms to the material or vice-versa, so that the material can be digested by the life forms. Within the digestive tract of a warm blooded animal, this action takes place by peristalsis. We imitate this transport by very gently moving the contents within the tank from time to time.

Continued on next page

## Concerning The Tank

A simple paddle mechanism works the best. Some systems re-circulate some of the gas to provide movement, but this has proven to be less than satisfactory. Often inorganic material is stirred from the bottom of the tank—material such as sand and small rocks if they are present—and the living organisms are injured in the process. The best method is a slow mixing action with a paddle of some sort. The paddle may be on a horizontal axis or a vertical axis. It merely has to move the material very gently a few times each day.

The exclusion of air is essential to have the process work. While we know that even water contains some air—otherwise how could fish breathe—once the activity of gas producing bacteria becomes established, even the air is mostly excluded.

The tank must be closed so that new air is not able to enter. This is done effectively by having both the fill pipe and the exit pipe extend below the water line. So, air exposure to the tank is limited to the surface of the water level in both the fill and exit pipes.

In the past much discussion focused on whether the tank should be horizontal or vertical. It is the consensus that when the tank is horizontal rather than vertical, it can work more effectively. (Note the illustration on pg. 25.) The reason is that the fill and exit pipes need to be spaced as far apart as possible. Then the material entering the tank has greater exposure to the activity within the tank before being moved near the exit pipe.

The gentle stirring action needed, of course, mixes up everything. Yet if the new material is forced to “migrate” some distance before reaching the exit pipe, then the micro-organisms will have more time to feed upon it before it is replaced by incoming material.

How big should the tank be? This is determined by how much material is available to the tank on a daily basis, and ultimately how much gas one wants to generate.

## Production Mixture

The input for the tank needs to be a mixture of manure and carbon material. Carbon material is ordinarily understood as waste vegetation, but it can't be just anything. It needs to be something that when soaked in water for a few days becomes very soft. The bacteria don't have any teeth. They have to “gum” it.

Hardness can be misleading. A carrot seems hard, but if soaked long enough it turns to mush. Grass clippings, on the other hand, contain a quantity of lignin, that cellulose fiber that makes wood very “woody.” Anything with a high content of lignin will not work well in a methane tank. Straw for the most part is acceptable. Hay is not.

Even such things as ordinary newspaper work well. Although newspaper at one point was wood, the lignin has been broken down so that when the newspaper is soaked for a day or so, it turns to mush—good stuff for our purposes. The bacteria want a mixture of 30 parts carbon to 1 part nitrogen. Manure is nitrogen rich—about 15 parts carbon to 1 part nitrogen, so manure needs to be balanced with more straight carbon material. This ratio isn't a critical proportion and the process still functions, but 30 to 1 is the ideal.

## Potency

The ability of manure to produce gas varies from animal to animal. Chicken manure can be especially potent. I have observed as high a yield as 10 cubic feet of gas from each pound of naturally moist chicken manure which was mixed with some finely ground spilled feed.

Hog manure usually yields about 4 cubic feet per wet pound. Cow manure usually yields about 1 cubic foot of gas for each pound of fresh manure. The reason there is such a difference is that much of the methane potential has already been released when the waste goes through the digestive system of a ruminant. There is usually so much of this kind of manure, using it is still worthwhile. Another good feature of the process is that raw manure is changed into something which is aged and totally acceptable to be placed on growing things. With any quantity of raw, green manure, this is not the case.

## Sizing the System

Having established that we need around 200 cubic feet of gas a day, we need to set about designing a system that will provide this. How much is 200 cubic feet? Visualize an inflatable bag that is six feet wide, six feet long and six feet high, and you're seeing a space of 200 cubic feet.

If we say that a mixture of manures will give us 4 to 5 cubic feet of gas per pound of naturally wet manure we are going to need about 40 to 50 pounds of manure a day. We would

Continued on next page

need even less manure if we use chicken waste. These forty pounds are going to be mixed with some type of additional carbon material, to which water, preferably warm water, will be added to give us a “slurry.” This will most likely be about 15 gallons of bulk. Visualize the content in three five gallon buckets.

**Size of the Tank**

It is generally a rule of thumb that the size of the tank needs to be 40 times the size of daily input. This means that when 1/40th of the volume of the tank is introduced at the input end then 1/40th of the volume will exit the overflow end simply by being displaced. Allowing some space at the top of the liquid for the gas to collect, the tank should be about 50 times the size of daily input.

Sewage plants that employ the methane process—and many do—like to have a holding time of 90 days. In other words the preference is to have the tank 90 times the size of the daily input. The purpose of this is to totally destroy any potential pathogens. That length of time within the tank does exactly that. Periodic inspections by the various health departments around the country keep a check on such activity and find consistently that the 90 day holding time accomplishes this goal.

Within a 40 day holding period most of the pathogens are eliminated. Because we are not dealing primarily with human feces (although this material may be used with animal waste) the longer holding time is not as imperative. Within a 40 day time span the greatest amount of gas is produced. In a period longer than 40 days, the gas production begins to slow down considerably.

We need a tank that is 50 times the volume of the daily input of 15 gallons, or a 750 gallon tank. Obviously, a 1,000 gallon tank would be ideal to take care of extra demand for production or additional material input.

**Tank Choice**

A 1,000 gallon discarded milk bulk tank would be ideal. Because bulk tanks already have a system for cooling the tank, this system could be easily adapted for holding the temperature of the tank at 100°F. rather than cooling it. One type has the “radiator” already built-in.

The fact that the tank is stainless steel is also an advantage because it would extend the life of the tank considerably over ordinary sheet metal. The acids within the mixture do not work rapidly on the tank, but they will deteriorate it over an extended period of time.

Originally, I had an ordinary 250 gallon fuel-oil tank that I used for demonstration purposes. It lasted for several years. It finally rusted through, but considering the fact the metal was relatively light gauge to begin with, the tank served well. Because oxygen is excluded in the process and the pH must be kept at neutral, the deterioration of the tank was not rapid.

Another great feature of a milk bulk tank is the fact it already has a mixing paddle as part of the tank’s design. All access ports above the water line would have to be sealed air tight for effective gas production and, more importantly, just common sense safety.

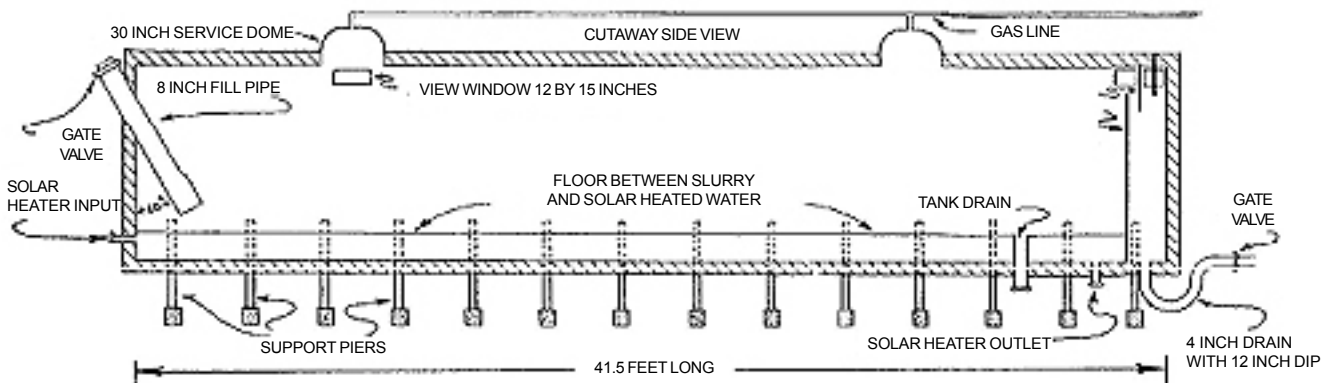

**Al Rutan’s Methane Digester Design**

Continued on next page

### The Gas Holder

Regarding a gas holder, one may use a solid vessel open at the top filled with liquid into which another solid vessel open at the bottom is placed. The gas pushes the top unit up out of the liquid as the gas is produced.

The simplest type of gas holder is an expandable bag. It can be something like a waterbed mattress upon which a weight is placed to produce enough pressure to send the gas to the point where it is used—a burner of some type.

One may use simply a vinyl of some type, but the best type of material is a nylon fabric that is impregnated with vinyl—not laminated, but impregnated—which becomes exceedingly durable. If this inflatable bag is placed inside a “silo” of some type, then there is a measure of assurance that the bag is not going to be punctured. The people who work with the nylon impregnated vinyl—one of the trade names is Herculite—seal it by a process of electro-statically welding it. Using an ordinary adhesive may not work because methane has a tendency to dissolve a number of adhesives

### For Now

The process of making methane gas is relatively simple if one is attuned to the basic needs of the process. They are: the right balance of material, the right temperature, and the exclusion of air. Given these three conditions, the methane process is virtually unavoidable. The trick is to be sensitive to the fine-tuning of each of these requirements.

Al Rutan



More of Al's articles will be published in the next few months. Peace, ldb

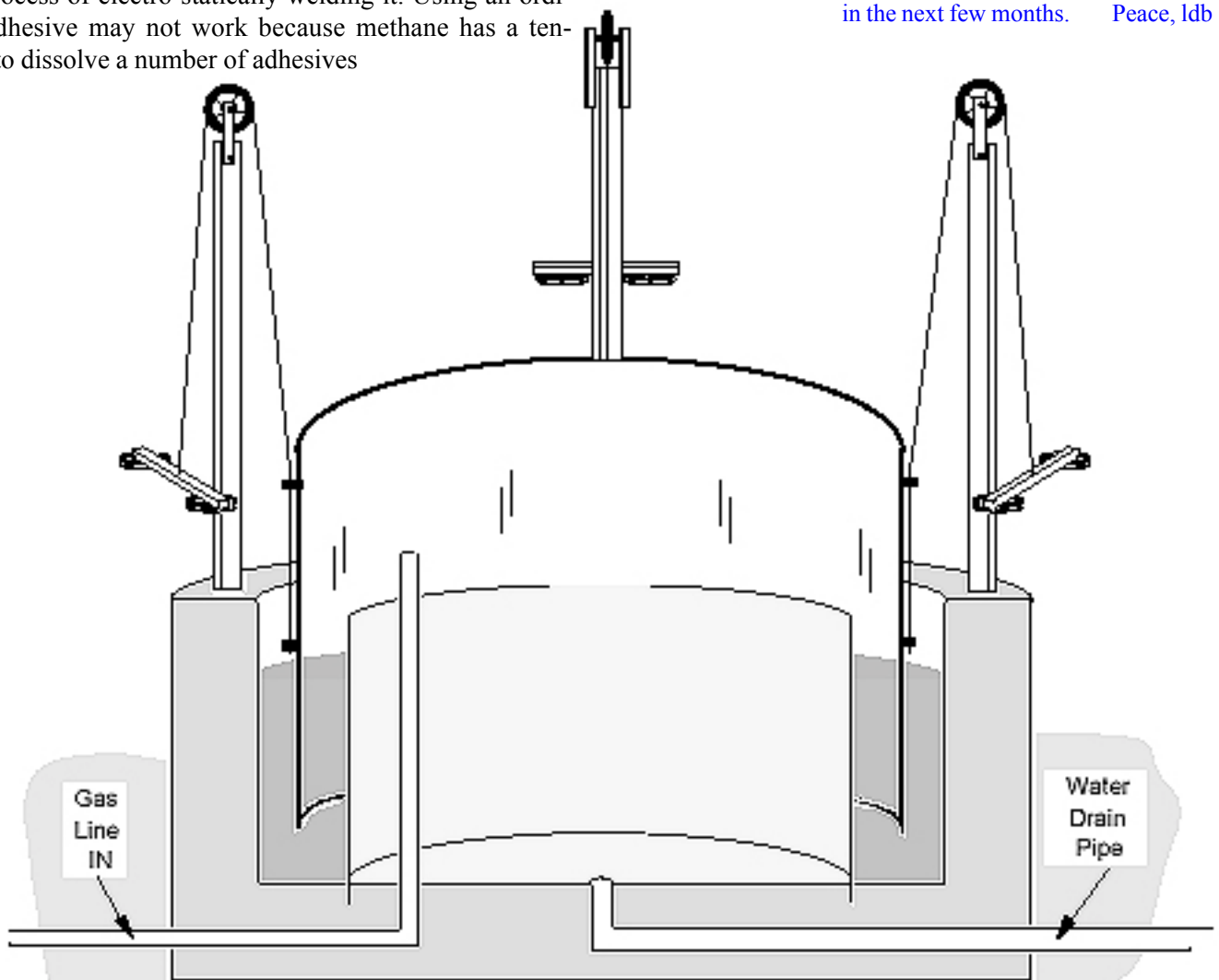

Gas Storage Tank

# SMALL WIND TURBINE BASICS

by Dan Fink

(Meet the Writer after this article)



Photo by Tim Fecteau

Wind power is taking off in a big way worldwide, in both giant utility-scale installations and small-scale turbines intended to power a single home. Remote off-grid dwellers are finding wind power an excellent supplement to solar during cloudy weather, and enjoying the extra freedom that more power input gives, especially after dark or during cloudy weather. On-grid folks are installing home wind turbines to offset rising power costs, and even selling extra power back to the utility.

Judging from the volume of questions I receive about wind power, there are many misconceptions amongst people out in the real world. Even though the physical laws and formulas governing wind power have been well understood for over 150 years, it has taken new fears about falling oil production, rising gas prices, and global climate change to generate the growing interest in wind power we have now with the general public. In this first article of the series, I'll attempt to explain the basics of how power is extracted from the wind, to help readers understand how much power they could expect from turbines of different sizes. Future parts of this series will cover many other small wind topics.

## How small wind turbines work

A wind turbine extracts energy from moving air by slowing the wind down, and transferring this harvested energy into a spinning shaft, which usually turns an alternator or generator to produce electricity. The power in the wind that's available for harvest depends on both the wind speed and the area that's swept by the turbine blades.

Caution: Mathematics ahead! But it's pretty simple, and if you are armed with a pocket calculator and some simple formulas and concepts, you should be able to make a wise choice in selecting a wind turbine, and be able to reject unsuitable products and detect scams. I apologize in advance for mixing metric and standard units!

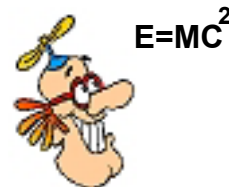

$$\begin{aligned} &\text{Power available in wind (in Watts)} \\ &= \\ &\frac{1}{2} * \text{air density} * \text{swept area} * \text{wind velocity}^3 \end{aligned}$$

where

**air density**

=

1.23 kg per cubic meter at sea level (1.0 here in Colorado)

and

**swept area** is in square meters

**wind velocity** is in meters per second

If we work the formula for a 5-foot diameter turbine in a 10 mph wind:

$$\begin{aligned} 5 \text{ feet} &= 1.524 \text{ m} \\ \text{swept area} &= \pi * r^2 = 1.8241 \text{ m}^2 \\ \text{wind Speed} &= 10 \text{ mph} = 4.4704 \text{ m/s} \\ \text{So} \\ \text{Power available (Watts)} &= \frac{1}{2} * 1.23 * 1.8241 * 4.4704^3 \\ &= \\ &\mathbf{100.22 \text{ Watts}} \end{aligned}$$

The first key concept that this formula shows is that when the wind speed doubles, the power available increases by a factor of 8. That means there's very little power available in low winds. Increase the wind speed for this 5-foot rotor to 20 mph (8.9408 m/s) and we get:

$$\begin{aligned} &\text{Power available (Watts)} \\ &= \\ &\frac{1}{2} * 1.23 * 1.8241 * 8.9408^3 \\ &= \\ &\mathbf{802 \text{ Watts}} \end{aligned}$$

The only way to increase the available power in low winds is by sweeping a larger area with the blades and that's the second key concept from this formula. Power available increases by a factor of 4 when the diameter of the blades doubles.

If we use a 10-foot (3.048 m) diameter rotor for a 7.30 m<sup>2</sup> swept area in a 10 mph wind, we get:

$$\begin{aligned} &\text{Power available (Watts)} \\ &= \\ &\frac{1}{2} * 1.23 * 7.30 * 4.4704^3 \\ &= \\ &\mathbf{401 \text{ Watts}} \end{aligned}$$

and in a 20 mph wind:

$$\begin{aligned} &\text{Power available (Watts)} \\ &= \\ &\frac{1}{2} * 1.23 * 7.30 * 8.9408^3 \\ &= \\ &\mathbf{3209 \text{ Watts}} \end{aligned}$$

However, there's no way to harvest ALL of this available energy and turn it into electricity. In 1919 a gentleman named Betz calculated that there's a limit to how much power a turbine blade can extract from the wind. Beyond the Betz Limit of 59.26% energy extraction, more and more air tends to go around the turbine rather than through it, with air pooling up in front. So 59.26% is the absolute maximum that can be extracted from the available power.

There are additional losses after Betz. Small wind turbine blades are never 100% efficient, even when running at their favorite speed. No alternator or generator is 100% efficient in converting the energy in a rotating shaft into electricity. There are friction losses from bearings, and from any gearing that's involved in the power conversion. And there are magnetic drag and electrical resistance losses in the alternator or generator.

Wind power researcher Mike Klemen did some volunteer math to benefit the wind power community, and came up with a web page about the Perfect Turbine:

[http://www.ndsu.nodak.edu/ndsu/klemen/Perfect\\_Turbine.htm](http://www.ndsu.nodak.edu/ndsu/klemen/Perfect_Turbine.htm)

A "perfect turbine" would work right at the Betz limit, the blades and the alternator would match perfectly at all wind speeds, and the alternator would have no internal magnetic or electrical losses. Klemen also averaged the efficiency of power conversion (called the "Coefficient of Power", or Cp) of several commercial small wind turbines, and got the figure of Cp=35% for what he calls on his page a "Good Turbine", though none of the commercial turbines he tested were able to reach that efficiency.

So now you are already armed with the knowledge to detect a wind power scam or a misleading advertisement and there are some out there. Caveat Emptor (Buyer Beware), and TANSTAAFL (There Ain't No Such Thing As A Free Lunch - Robert Heinlein). If an advertisement claims more power output than is even available in the wind, you are dealing with a con artist. If the power output claims beat Betz, you are either dealing with a mis-informed individual or company, or a con artist. And if output claims exceed Klemen's very optimistic Cp=35% guideline, you may have found an exceptionally good turbine, or more likely someone who is not measuring Cp carefully enough with their data acquisition equipment. Though giant utility-scale turbine designers are attempting to close the gap between reality and Betz, a small turbine that gives a Cp of 35% or more would be considered an exceptionally good design right now.

Continued on next page

## Average Wind

Another crucial concept to understand about wind power is at what speeds the wind usually comes to us for harvest. Folks that are new to wind power tend to think that if they put up a small, 4-foot wind turbine that's rated 400 watts, they'll be getting 400 watts power input whenever it gets breezy outside. In reality, at most locations the wind comes to us at low speeds 5-15 miles per hour. And we've already learned that low winds don't have much power in them, and that they can only make useful power when swept with a large rotor. Advertised wind turbine "ratings" are currently all based off of peak output in high winds which are relatively rare. Much more important is what the turbine will do in low winds, but this information can only be extracted from power curve charts supplied by the manufacturer.

It's easy to look up the average wind speed at your geographic location with the NREL (National Renewable Energy Laboratory) printed and online Wind Resource Atlas: (<http://rredc.nrel.gov/wind/pubs/atlas/>). It will show you your "wind zone" and the average wind speed in that zone. It's a good way to see if wind power is even appropriate for your site, but doesn't give you all the information you need to select a turbine for your location and power needs.

The statistics used to calculate the distribution of wind speeds are complicated, but the results are easy to understand. In most locations worldwide, the distribution of wind speeds keeps fairly close to a Weibull or (simplified) Rayleigh distribution of wind speeds, shown below. There are non-Rayleigh locations where the curve takes on other shapes, but these are relatively rare. The distribution shown here is relatively common.

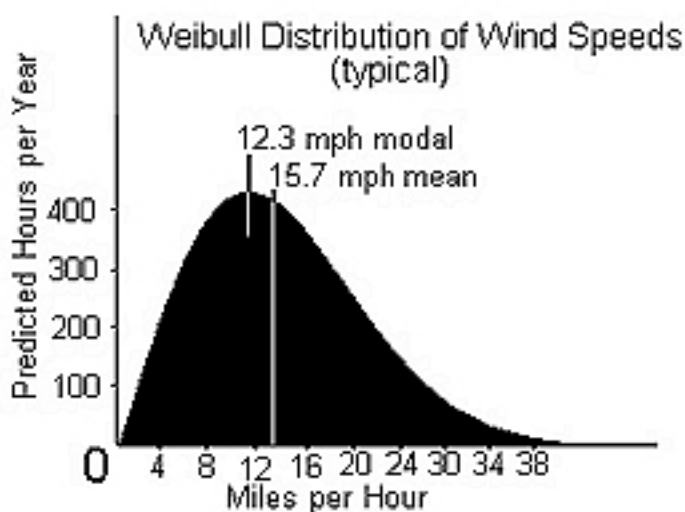

In the chart, the horizontal axis shows wind speed, and the vertical axis the probability (which can be condensed down to the predicted number of hours per year) that the wind is blowing

at that speed. The area under the graph is always equal to one, because the probability that the wind is either blowing or not blowing is always 100%.

An anemometer is an extremely valuable tool for evaluating your location for wind potential. Anemometers can be rented, built at home, or purchased. Some models even plot your Weibull distribution for you. See the links at the end of this article for more anemometer information and resources.

These concepts are the key to selecting the correctly sized wind turbine for any application select your turbine based on the SWEPT AREA, not the manufacturer's "rated output." Rated output is an almost meaningless figure, it's simply the peak power the turbine can make in high winds. But at what



wind speed does it make that rated power? Most manufacturer rated outputs are taken at around 28-30 mph. And for how many hours per year do you get wind at that high speed? In most locations, very few. Most winds come in at a much lower speed, and therefore have much less power available in them. The only way to compensate is with a bigger swept area.

Continued on next page

In a 10 mph wind (very common), there are 100 Watts of power available with a 5 foot diameter wind turbine. Betz lowers this to 59.26 Watts, and with Klemen's "good" turbine losses we are down to at most 35 watts of output. That's only enough power to fire up a couple of efficient CF light bulbs. By comparison, a 10 foot turbine has 401 Watts available, 238 W with a "perfect" turbine, and 140W output in an excellent turbine design. Much better, but not anything that's going to make your electric meter run backwards! A "good" 20-foot turbine could possibly give 740W at 10 mph.

When we double the wind speed to 20 mph, the exponential increase in power available becomes apparent 280 possible Watts from a "good" 5-footer, 1,100W from a 10-footer, and 5,900W from a 20-footer. Now we are talking some real power for a sailboat or cabin (the 5-foot machine), an off-grid home (the 10-foot machine), or an on-grid house trying to offset the power bill (the 20-foot machine). Of course it varies by location, but on a good wind power day that most people would call breezy, the wind will usually be between 10 and 20 mph.

Now you are armed with some realistic expectations of how much power different sized turbines can make at different wind speeds. You should be able to whip out your pocket calculator at any time and envision how much power is possible. And here's where some less scrupulous retailers and manufacturers try to promote wind power misconceptions to boost sales but now you are immune to hype! Some examples are listed below, and each future part of this series will have some hype-proof and misconception-busting information related to its topic. These examples are all fictional but you'll find great similarities to real ads if you prowl Ebay and Google for wind turbines.

400 Watt Wind Turbine only \$500! More power than \$1,600 worth of solar panels! No Reserve! That 400 Watt wind turbine rating will be peak output, probably in 28-30 mph winds. Check your Rayleigh distribution chart, and estimate how many hours per year that you'll see 30 mph winds. Not many! While in the meantime your 400 Watts of solar panels will be making the full 400 Watts for many hours per week. Comparing solar to wind is like comparing apples to oranges. A good renewable energy system will use BOTH solar and wind.

This remarkable innovation can make 3,000 Watts of power in 13 mph winds, all from an unobtrusive 6 by 6 foot box! Get out the calculator, and you'll see that they are claiming over 7 times more power output than is even available in the wind. It's a scam for sure, because it defies the laws of physics.

Don't want a big, unsightly wind turbine in your yard? Buy 3 of these small, 400 Watt turbines, and get as much power as a big, ungainly and expensive 1,200 Watt unit for half the price! Think back about power available in the wind and its factor of 8, and swept area and its factor of 4. At the rare rated peak output, which is probably around 30 mph, the 3 small 400W turbines might indeed be making near the same power as one big 1,200W model. But what about performance in your far more common low winds? The large turbine would be spinning and making some power, while the small ones most likely sit still, making nothing.

**900 Watt Wind Turbine! Under 3 feet in diameter!! No Reserve!!!** A quick check with pocket calculator shows some problems. Running the power available in the wind equation at 30mph, even Klemen's exceptionally "good" turbine guideline gives only 600 Watts output with a 3-foot rotor, so something is fishy here. A quick check of the turbine's specs shows that that that 900W rating is for 65 mph winds?" which are extremely rare. Commercial turbines are all given their ratings at around 30 mph that seems to be the industry standard.

This last example of hype again shows exactly why you should select a wind turbine based on swept area and not rated power output. There has been much controversy and discussion on the internet recently regarding rated output, since folks that are flying wind turbines can observe with their own power meters how useless peak power ratings at 30 mph really are, and how infrequently that output level occurs. The problem is that wind turbines manufacturers NEED some way to quickly and easily present their performance data to the public.

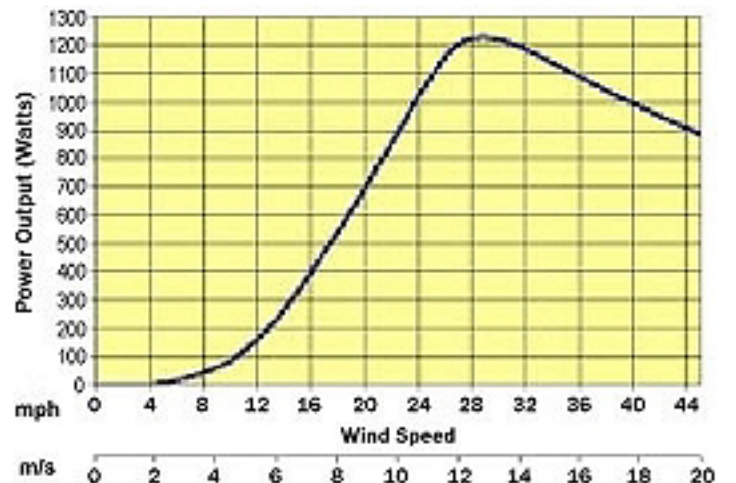

Sample power curve diagram: Wind turbine instantaneous power curve chart from a very reputable manufacturer. This one is for a Bergey XL.1, an 8.2-foot diameter, 1,000 Watt machine. Chart source: <http://www.bergey.com/>.

Continued on next page



For example, I could rate a nice 10 foot turbine at only 400 Watts, and that would very accurately reflect what it can make in common 15 mph winds. But no one would buy it, since they could get a 400 Watt turbine with only a 4-foot diameter from another manufacturer for a fraction of the cost and are not aware that the turbines are rated at vastly different windspeeds. The 10-footer would make far more power in all winds and far more power per year, but by comparing the peak output data the uninformed buyer would assume they would perform the same. Really, the only way to accurately rate wind turbines is by comparing their measured power curves, and most consumers are not willing to sit down and crunch the math.

Swept area is the most important concept in choosing a windturbine, but it's very difficult to get that concept across to an under-informed public.

Hopefully YOU now understand some of the issues involved in figuring how much power is available in the wind with different sizes of wind turbines. The next article in this series will cover the details of why wind turbine blades are shaped as they are, how electricity is generated by that spinning shaft, and how wind turbines regulate their output and protect themselves from extreme winds. Remember that factor of 8 increase in power when wind speed doubles? This massive increase in power can blow a wind turbine apart, and the turbine design must be able to compensate to keep incoming power at a reasonable level.

### Dan Fink

#### Links you may find interesting:

Excellent Danish wind power tutorial website, including formulas and online calculation programs for wind power:  
<http://www.windpower.org/>

#### Home-built wind turbine resources:

Wind turbine building information from Otherpower.com:  
<http://www.otherpower.com/>

Hugh Piggott's superb home-built wind turbine website:  
<http://www.scoraigwind.com/>

The Otherpower.com discussion board, where wind turbine builders worldwide meet to exchange questions, information and photos:

<http://www.fieldlines.com/>

Homebuilt data-logging anemometer information:

<http://www.otherpower.com/anemom2.html>

Inexpensive logging anemometers and Windows wind data logging software:

<http://www.inspeed.com/>

Fancy logging anemometers, with Rayleigh functions:

<http://www.nrgsystems.com/>

## MEET THE WRITER! DAN FINK



The article on Wind Power that you have just read was written by Dan Fink, seen here top left playing the Washtub Bass and vocalizing in enthusiastic harmony with his fellow members of the Dog Mountain Band (<http://www.DogMountainBand.com/>).

Dan Fink is not just a skilled musician, playing the Banjo, the Dobro guitar and the Kazoo in addition to the Washtub Bass, but in his spare time is the technical director for Forcefield in Fort Collins, Colorado, USA (<http://www.otherpower.com/> and <http://www.wondermagnet.com/>).

He has lived off-grid, 12 miles from the nearest power or phone pole, for 14 years, and maintains Forcefield's websites and servers via a satellite internet connection. His home is powered entirely by solar and wind, so he knows what he is talking about!

Dan's articles have appeared in such magazines as Back Home, Home Power, and Zymurgy. In his spare time, Dan is a volunteer firefighter for the Rist Canyon Volunteer Fire Dept. (<http://www.rcvfd.org/>)

How he finds time to write for us is a mystery!



Discuss this article on the Green-Trust forum

# THE FACHONGLE STOVE

Second in a series of articles about  
Self Sufficiency in Africa  
by Suzanne Ubick

## A VERSATILE FURNACE THAT YOU CAN BUILD YOURSELF

We designed and built the Fachongle Furnace with the idea of getting as much benefit as we could from burning wood. The furnace gives us space heating for a large area, a lot of very hot water, a hot plate and oven for cooking, and a smoke chamber. We burn the wood in a tunnel made from firebricks. The back is closed off and contains the back boiler for water. The front comes almost up to a hole in the house wall where we have built a fire door, so that the furnace can be fed from outside. We built brick walls on either side of the tunnel right up to the house wall, and rested a steel plate across them. The front of the plate serves as a hot plate, and over the back we have built an oven. There is a slit in the steel plate so that heat circulates all the way round the oven. At the very back is the chimney, which widens out above the oven to form the smoke chamber. Heat from the fire comes forward along the tunnel, curls up under the hot plate and oven, and continues on up the chimney. It is likely that your requirements will be different and will necessitate a modified design.

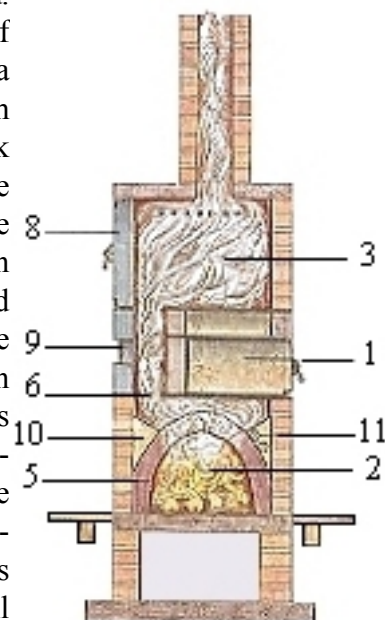
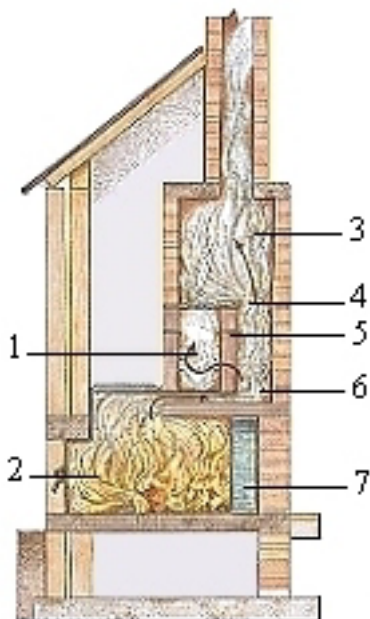

- |                |                     |                  |
|----------------|---------------------|------------------|
| 1. Oven        | 5. Firebrick        | 9. Access door   |
| 2. Fire box    | 6. Flue passage     | 10. Sand filling |
| 3. Smoking box | 7. Back boiler      | 11. Water pipes  |
| 4. Damper      | 8. Smoking box door |                  |

“Reproduced by permission of the John Seymour School for Self Sufficiency”

### My criteria were:

- Efficiency, to make the most of the wood supply.
- Hot water for bathing and laundry.
- An oven for baking.
- A boiling and broiling pit.
- Ease of feeding the beast. I’ve scorched off my eyelashes a couple of times with unfriendly donkey boilers.

When we first moved onto the smallholding, there was no house, just an old caravan with an enclosed porch in front of it, and a sacking-surrounded shower nook at back. Obviously the Fachongle furnace would have to be modified, as we knew it would take years to get the house finished.

My final design was based on the Fachongle furnace plan – with an extension at right angles to the heat stack. The property was fairly well-treed, by Transvaal terms anyway, but I have never liked waste, and did not want to kill trees for burning. I wanted to use stickwood, as the Nearings did, deadfalls, and waste wood from the trashed crates and pallets to be had for the taking in the hamlet of Hammanskraal.

Elias, the man-of-all-work, and I consulted, and scrounged till we had the materials together. XH bought good sand, cement, and some threaded metal piping and a couple of taps on one of his weekends at home.

Continued on next page

The roads department had dumped a lot of gravel nearby, and Elias brought in a load with a donkey cart – a real donkey, pulling a cart!. We had scraps of corrugated iron roofing from building the milking shed, and some black polyethylene piping left over from connecting the water tank to the stock troughs. A neighbor gave us a 44 gallon drum. We had some rather buckled lengths of those rods that go down inside the bore-hole tubes – from the time we dropped the pump down the well. We were in business.

We used the original rock fireplace as the base, lengthening it several feet, concreting in the rocks, and throwing a concrete slab inside it. The width of the slab was the same as the length of the drum, and the length of the lab was twice the diameter of the drum. Using rocks collected from the extremely abundant supply on the smallholding, we built a wall along both long sides and one short side, about 15” high. The closed end would be the major business end; this half of the donkey boiler was built up to about 30” high. Then we made a grid of the cut-up borehole rods, carefully positioned the drum onto it, and proceeded to build up stone and concrete around it, and at the closed (tapless) end. A couple of inches above the drum we put in more rods, and then continued building upward for another foot or so. Then Elias took another piece of iron and bent it to form a dome-shaped roof, with a small piece of metal pipe sticking out to vent the hot air. So now we had a sort of glorified beehive with a rock box sticking out at right angles to the long axis of the drum.

Returning to this end, we made another grid out of the buckled rods, laying them so the buckled bits were horizontal to get a non-tipping grid. These were cemented in place. And now we had to wait for it to cure...the weather was very hot, with intermittent thunderstorms. We covered our creation with thick throw-out sacks from the grain mill, and kept these damp.

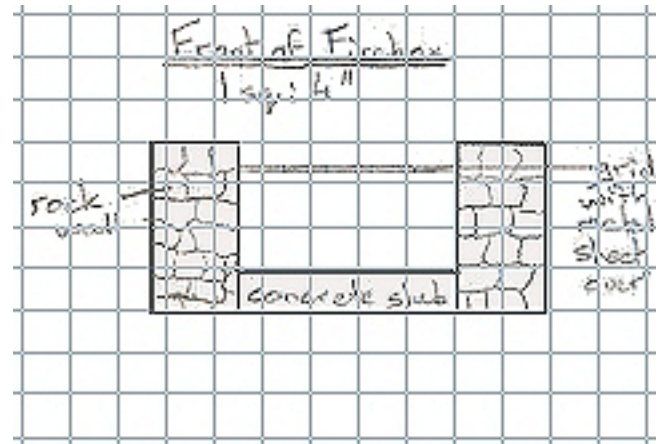

During this time, we connected a bung, tap, and screw fitting to each of the drum holes. The bigger hole was nearer the bottom, and this would be the cold water inlet. The holes were not vertically above each other – they were sort of staggered. The smaller hole was fitted the same way, as the hot water outlet. We tightened all the pipes and tubing with lengths of wire intertwined like mating snakes, and clinched up tight with pliers. The cold water inlet was hooked up to the black irrigation tubing, which was in turn connected to the drain spigot of the water tank.

Once the concrete was cured, we opened the cold water inlet. Water gushed into the drum. With due solemnity, I laid a fire under the low end grid and struck a match. Then I covered the grid with yet another piece of metal, and put a cut-open paraffin tin full of dog chow ingredients on to start simmering.

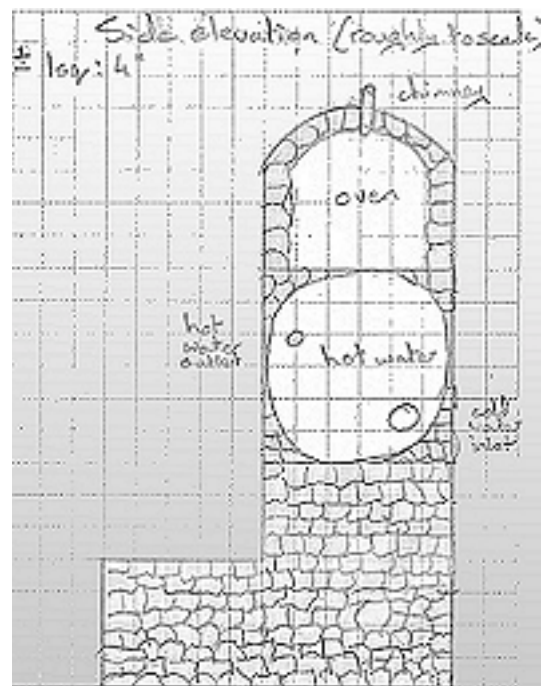
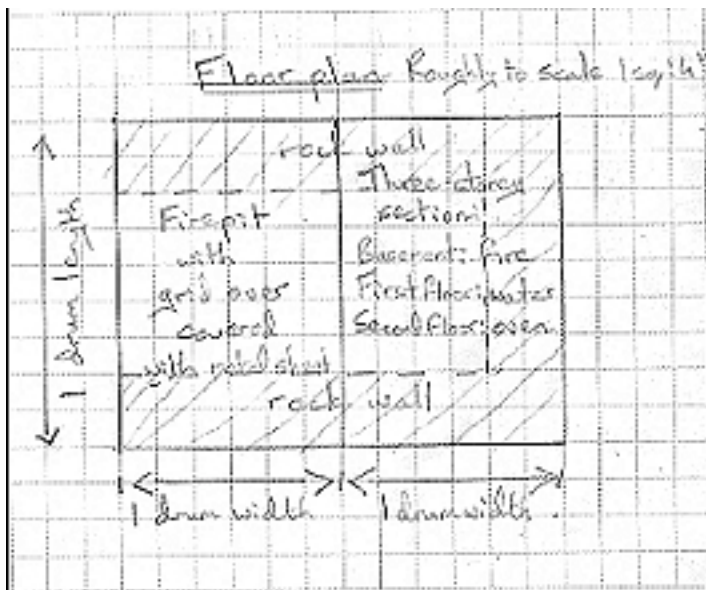

It worked! The fire burnt steadily under the dog pot, the metal sheet deflected the rising heat and funnelled it under the drum, when it shimmered its way around the drum and up into the oven. The oven door was yet another piece of left over metal, cut to size and attached to the oven by loops of wire which hooked over big nails driven into the concrete. When I opened the hot water tap, steaming water gushed into the strategically placed bucket beneath it.

I had started baking bread soon after taking to the nomadic life; often we were a hundred kilometers from the nearest store – and the so-called “government bread” is rather lacking. I had baked bread in the oven of the little gas stove in the caravan, in a big coal stove at a rest camp, and in a pot over a gas burner. I’d fried up balls of it, a delicacy called “vetkoek” that is much loved in South Africa. I had read with great interest how the Voortrekkers, the Cape Dutch pioneers, in their epic colonisation of the country had made sure to laager up at sites where there was a good anthep. After circling the ox-wagons in a big ring around it, the men would chop it open on one side and hollow it out. The women baked bread, cakes, and rusks in this natural earthen oven; a good fire of hard wood would be made, allowed to burn down to coals, the coals raked out and then the pans of food carefully slid in. The “door” would be covered with a thick tarp, and earth banked up against it. Aaahh, rusks; one of my favourite foods. They’re something like sweetened yeast buns, cut into quarters after baking, and then dried out at very low heat. That way they keep good for years, as long as they stay dry, and they beat hardtack hands down. If made unsweetened, they’re great dunked in soup.

I had pans of risen bread dough waiting; I slid them into the oven and hung the door over the nails. Every few minutes I’d peer in anxiously. About an hour after putting them in, the loaves were baked; crusty, brown and smelling delicious.

### **All this with one fire!**

With use, I learned that once the dog food had boiled, I could take a hoe and push the fire and coals directly under the drum. I learned that rich chocolate cake does not come out well, especially when I had carelessly allowed the fire to smoke. The residual heat would dry out rusks overnight, out of reach of the dogs. I found that meat roasted nicely in the oven. Once the kitchen was built, we hooked up the hot water pipe to the tap at the kitchen sink, and put a T-piece onto the cold water pipe, so we actually had hot and cold running water! Then we put a tank on a stand near the kitchen, fed by rain-water from the roof, and hooked that to the boiler.

What I’d do differently now is make the top of the oven flat; then there’d be a convenient heat-proof surface for putting the food on when it came out of the oven. I’d build the boil/broil section much higher, so I wouldn’t have to squat while frying up eggs or broiling chops. In fact, I’d make the whole thing higher, and two storeyed so to speak, using the “basement” for stacking firewood. This would keep the wood dry, as well as easily accessible. I’d use heavy steel plate over the cooking end. And definitely I would put on a good oven door, properly hinged, with a latch.

Suzanne



# Allergy Free Gardening

## Meet our new Writer

### Tom Ogren

If you're completely new to all of this, let me give you a bit of the history of Allergy Free Gardening. Some twenty years ago I became very interested in this subject mainly because my wife, Yvonne, had terrible allergies and asthma. I was teaching horticulture and one day I asked my students to do some "sniff tests" with me. We sniffed pansies and petunias and nothing happened. Then we tried sniffing bottlebrush flowers and BLAM! people started sneezing, hard. In later weeks we tried sniffing a great many more types of flowers. I quickly discovered that certain flowers never made anyone sneeze, that some flowers made a few folks sneeze, and that there were others that just literally trashed people.



Eventually I gave up doing these sniff tests because several people got dangerously sick from them. I realized I was playing with fire. By this time though I was hooked on the idea that the right garden wouldn't trigger any allergies. I soon also started testing plants to see if they would cause any odd skin reactions and again found plenty that did and others that never did. I tried to buy a good book on allergy free gardening but in those days there was nothing to buy; there was no such book to be had. And so I decided to just keep on researching the subject myself.

In the following years I learned a good deal. I went back to college and got my MS degree, focusing all of my graduate work on plant/allergy connections and on the different plant flowering systems. One thing that deeply interested me was that so many of the separate-sexed (dioecious) trees and shrubs often triggered severe allergies. Occasionally I would come across advice from lung associations or allergy groups that suggested no one plant any of these trees or shrubs.

It occurred to me though that since these "very worst" plants were indeed separate-sexed, where one tree would be all male, and another all female, that in truth only the males would produce pollen. It also dawned on me that since

female plants did not produce any pollen, that they were the ones that would be most truly allergy-free. This was no great piece of intellectual brilliance by any means, but for some reason no one else seemed to have noticed this crucial importance about the sex of plants and pollen allergies.

At one point I started to photograph flowers of suspect trees and shrubs. Rather suddenly I discovered that although it was easy to find plenty of males to shoot, female landscape plants were surprisingly rare. I found this same situation in city after city. What, I asked myself, was going on? It seemed almost as though the cities had been landscaped to cause allergies, but I knew this didn't make sense.

Eventually I came to realize that in the name of tidiness, for the cause of low maintenance, male trees and shrubs were being planted by the millions. Since the males produced no seeds, fruits, messy flowers or old seedpods, they were considered far superior to female plants.

That these same male plants would bombard urban areas with huge amounts of pollen never seems to have been considered. But this is exactly what has happened. When I realized what I was seeing, I decided that I had an obligation to try and do something about it. My most recent book on the interactions of plants and human health, *Safe Sex in the Garden*, gets its name from this peculiar, unnatural situation in our urban landscapes. I've been having some luck too. My work has attracted media from far and wide. My books have been reviewed in the London Times, the Jerusalem Post, in Der Spiegel, in dozens of other terrific publications. My research was the focus of a CBS Evening News special, the Discovery Channel in Canada filmed a documentary about my discoveries, Allegra hired me to do consulting work, and Linda Wertheimer interviewed me on NPR's Weekend Edition.

Continued on next page

I've spoken to groups of MD's and was well received. At the Chelsea Garden Show in England a college did a display of pollen-free plants based on my work. The display even won a silver medal. Allergists have passed out literature in their offices about my books. The USDA used my OPALS (see) scale to form allergy predictions for different cities, and the American Lung Association in Richmond, Virginia asked me to help design an allergy-free landscape for their new headquarters. Recently I helped a county asthma coalition select lawns and plants for a pollen-free landscape at a new elementary school. Lots of positive things have happened but still, I get impatient.

It is quite possible now to produce fine gardens and landscapes that do not trigger any allergies, but by and large this isn't being done. The opposite, high allergy, mostly male cloned plant materials, that's what being planted still. And every day people with allergies suffer needlessly. Kids with asthma have problems just breathing. School after school is landscaped with the most allergenic plants possible. Even at hospitals I see landscaping so explosively allergenic that it makes me shudder. And yet many people have now changed their own yards. They have



gotten rid of the worst plants and replaced them with pollen-free ones. Every day I get mail from appreciative readers. People tell me this has changed their life, and all for the better. But I feel there is so much more to be done. People with allergies or asthma they deserve clean air to breath.

Kids deserve schools that are not covered in pollen. I need your help. I need help to get the word out. I need help to get city arborists to stop planting all these male cloned trees. I need help to get schools to clean up their acts. I need your help to get people to appreciate a fruiting female tree

because she never sheds any pollen. I need your help to educate the allergists. I need your help to get cities to enact and enforce pollen control ordinances. I need your help to get the colleges and universities to start teaching this material in their landscape design classes, their urban forestry studies, in all of the horticulture classes. By the way, I give a great many talks and am always open to speaking to new groups of gardeners, horticulturists, arborists, or to interested health professionals. I also answer my own e-mail, although this gets tougher all the time. But through this e-mail correspondence with readers I also learn a great many things that I wouldn't know otherwise.

**Tom Ogren**  
[tloallergyfree@earthlink.net](mailto:tloallergyfree@earthlink.net)



# MANY HANDS MAKE LIGHT WORK

by Steve Spence

Ok, so it's 4 hands (I have two, and I'm quite sure Larry does as well), and one didn't quite light, but in the never ending quest for efficient lighting, Larry shared with us last month his LED lamp and I'm continuing with a DIY fluorescent lighting project, an extremely energy efficient lamp from Home Depot, and an LED nightlight. Three reports for the price of none!

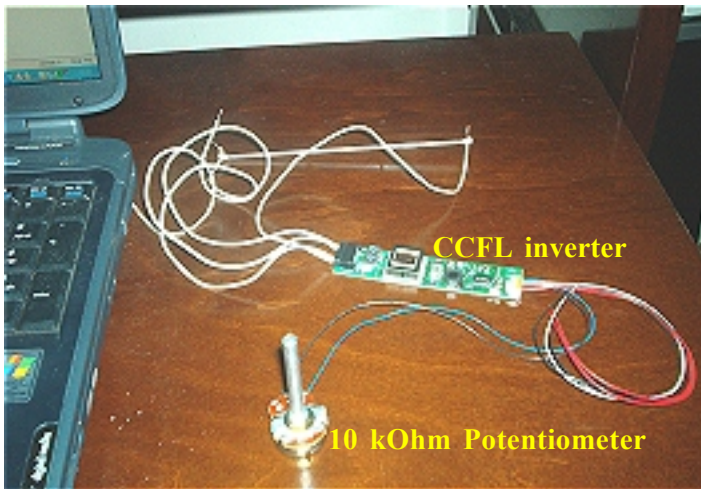

For the DIY project, I started with a 12vdc CCFL project. CCFL stands for Cold Cathode Fluorescent Light, and is what lights up LCD monitors.

No heaters in the ends of the tube, and brags a very lower power consumption of 0.005 amps at 12vdc. I started with a CCFL tube from digikey.com, part number 289-1136-ND, and a dimmable CCFL inverter, part number 289-1063-ND (see spec sheet on next page if you enjoy electronics!). This ran me about \$39. A 10k ohm potentiometer from Radioshack rounded out the project. After assembling according to instructions supplied by Digikey, I still only get it to briefly light upon disconnecting the power. This will require more thought, and a call to tech support (see circuit schematic next page).

The second item up is a \$11 battery operated (8 "AA") fluorescent from Home Depot. Their brand name is Amerelle, and it has a 12vdc input on the side, and takes a 30cm / 12" tube. Pulls 6 watts with my wall wart. A good deal in our estimation.



The third item is a LED night light. Paid \$2 for it at Giant Tiger. Acrylic "Praying Hands", it uses too little power (120vac) to register on my Kill-A-Watt. We use these in our off grid home, and they have no discernable impact on our battery consumption. Another winner.

Steve Spence



Discuss this article on the Green Trust forum





# STAYING COOL

Sixth in a series of Articles on  
Passive Solar Building Design  
by Laren Corie

About thirty years ago, an era started in housing design. This was the emergence of the “Solar house” into the Mainstream lexicon. In the northeast much was happening with active collector systems, and centered around Santa Fe the passive solar movement blossomed and spread. Some of us began creating hybrids, combining the best of both approaches to fit our own unique climates. All the while, we were learning from each other’s efforts, and gaining the knowledge to both adapt our designs to the unique climates, and to gain greater design flexibility. We studied historic architecture, to learn from those who came before us and had the experience of living comfortably without any fossil fuels or electrical grid. Design strategies, and guidelines became available for all the climates, and a lot of very good houses were designed and built. These houses would not only heat themselves in winter, but would also defend themselves from the heat of summer.

But the primary frontier of that movement was in the realm of heating, and though we had strategies for cooling, they were seldom challenged by the extremes of the deep South. Why was this? I can only speculate. In the seventies there was a great movement of population to the South as literally millions moved to Texas, Georgia, and other states. They were glad to escape the often double digit energy inflation that was a burden in the North. Usually, when there is a high demand for housing, as there happens to be today, there are strong reasons for builder to not be innovative. Innovation happens when the competition get desperately tough. I recall kicking off my design practice the month that the newspaper headlines read “Building Industry 99% Shut Down.” My Ex literally said; “Now, I know you are crazy” which was a rather disturbing comment coming from a psych professional. Fortunately, it was personal hyperbole, rather than a professional evaluation. What I am getting to with my ramblings, is that the South never got its fair chance to develop the strong energy efficient housing movement of the seventies and eighties that the North had. We still tend to use the term “Solar house” as a generic term for highly energy efficient.



The past thirty years has seen the near total disappearance of naturally cooled houses in the deep South, as generic subdivisions provide only identical housing to that in the north, but with bigger A/Cs. With all of our varied theories of how, and when it might be coming down, we all see a shortage of fossil fuel looming in our future, which will result in higher energy prices. That means that electrical costs will also be climbing. The number of us who are preparing for this change, and for a new “Solar Age”, is rapidly growing. This time the South is not going to be left out. Already there are a few smart, forward thinking, strong spirited individuals, who are fully preparing themselves for that day. As a matter of fact, some are already living off-grid, in total comfort, without a thought of air conditioning. This month we are fortunate to hear from Tony Adrian, one of those true pioneers of the new southern energy movement. I think you will enjoy his reflections as much as I have.

**Laren Corie** - Integral Solar and Energy Efficient Building Design and Consultation for Owner-Builders, Since 1975

Continued on next page

# THE BOY IS CRAZY!!!

## Misconceptions and Other Descriptions for Jungle Dwelling Off-Gridders

By Tony Adrian

“The boy is crazy”; “They don’t have no ‘lectricity”, “Can you believe it - those poor people don’t have air conditioning”; “They went to college, how can they live like that”, “They can afford that new house but can’t afford a water well”, “You can’t have too much electricity”, “The acid rain will get them”, “What if the terrorists strike?” ...

These are recently heard, local descriptions of my wife and me. How did two fairly well educated adults get themselves into such a predicament in the early 21st century? On the bright side, it is nice to know that there are many in the community who are concerned for our mental and physical health. They just haven’t decided how to save us from ourselves. This article is a very small collection of local reactions in the story of our journey towards energy independence, self sufficiency, and a sustainable lifestyle.

First, a little history. In 1986 I was a squatter in a small shack in some woods near St. Martinville, Louisiana. I had just graduated from the local university with a Bachelor of Science degree in nursing. Having lived hand-to-mouth for 10 years, I suddenly had a paycheck that seemed exorbitant. What to do? By definition squatters don’t pay rent. Now that I had a steady income, the sensible thing to do was to pay rent every month. The difference was that I paid it to myself every month like regular folks. This “rent” was systematically saved and invested for 18 years. Somewhere around 1990 I met my future wife at a local international music festival. She was a French teacher. Over the years, between our “rent”, savings, investments, a small home business, and lot of dumb luck, we were able to purchase 175 acres of wetlands/woods/pasture. In 2001 we met Eddie Cazayoux AIEE, a local green architect and university professor. Maybe the heat temporarily got to Eddie, but somehow he was persuaded to take us on as clients. Prior to designing our off-grid house Eddie performed a home visit, and must have determined that the Goodwill clothes, beat-up vehicles, and overgrown grass were positive signs. Somehow he figured that we really did want to follow through on our stated desire to build an off-grid house. Eddie is the foremost authority on sustainable building for our climate and culture. His body of work includes books, and numerous published scholarly works on Louisiana historical building practices, materials, and restoration. To many, the fact he took us seriously was more than a little surprising. Some felt he had experienced a lapse in his normally good judgment. He was an enabler, and co-conspirator in our creating of our disturbed lifestyle.

In May of 2004 we moved into our new, off-grid, rainwater supplied house, in rural French-Creole Louisiana. Located in a sub-tropical climate, about 50 miles north of the Gulf of Mexico. we really have one season - Summer. Occasionally we have a cold front or two, usually referred to as Winter. Typically it becomes stifling hot and humid around the middle of May, and we get a little relief around the end of September. Fall and spring are short, but the temperature and humidity are generally pleasant. Winter months are usually tolerably cool and wet. Throughout the year the monthly rains are fairly consistent, and total about 60 inches per year. Often the rains are torrential. We do experience hurricanes. The climate is jungle-like for much of the year. A description of the house itself can be found at the end of this article, but this is an overall view from the East when it was being built..



A single generation ago rural south central and southwest Louisiana was transitioning from a mostly rural, self sufficient, non-English speaking population, into what is now generally recognized as the typical failed model of city-suburban sprawl. Formerly a large portion of the population lived in small, cypress homes built with the environment in mind, to make the intolerably hot climate livable. Most families had at least a few chickens, a hog, a cistern for water, and a vegetable garden. In a few short years the number of people who live in such a manner became nearly none, and those few who remain are dwindling fast. The celebrated Acadian/Creole lifestyles are still celebrated - just not practiced. Subsidized electricity, air-conditioning, municipal water, shopping malls, lack of sidewalks, fast food, and television have nearly wiped

Continued on next page

out the formerly frugal, vibrant, self-sustaining cultures. Most new homes are over priced, poorly designed, and even more poorly built. Oversized boxes with black roofs, substandard insulation, and non-functional windows litter the landscape. Trees have been removed and burned in piles to make room for the monotony of green lawns. Housing developments featuring homes with decorative porches, without sidewalks are de rigeur. The evolving American dream, of being sequestered in a 3,500 square foot brick or vinyl sided facade home, within walking distance of nothing, has been accomplished. As a diversion, most people are less than a five mile drive to a mall. Unfortunately the five mile drive takes forty five minutes of sitting in traffic. Except for a few older people and even fewer young people, the majority of the population lives like Anybody from AnyTown, Anywhere, USA.

In December 2004 the local newspaper wrote a really good front page story, describing the house. They published excellent photos and a complimentary, reasonable article on our lifestyle and home. In the six months since the article was published, we have given countless "tours," and the number of tour requests is increasing. My wife and I have much first hand experience with the local reaction to our lifestyles. Sympathetic acquaintances and friends fill us in on other reactions and comments, usually complimentary, but not always.

Following are some common statements from local visitors:

"You can't have too much electricity" - This was the reaction of a utility worker when told we are supplied with electricity from photovoltaic panels. When told we used batteries to supply us during non-sunny periods, his reaction was very sensible. He is, after all, a trained technician. He thought we needed to know that if we wanted to run all of our appliances and tools simultaneously for hours on end or throughout most of the night, we'd be in trouble. He's correct, and we greatly appreciate astuteness. We have made it a policy to not run the blender, KitchenAid mixer, microwave, vacuum cleaner, ceiling fans, lights, computers, grinders, skill saws, etc ... all night long. In fact we wrote it down, to help us remember.

"What about terrorists?" - Amazingly, this is an extremely common reaction when it is discovered we harvest and use rainwater for 100% of our needs. I ask if they really think a terrorist would try to sneak down a 6,250 feet of driveway that runs through an open pasture, climb over or under a bunch of fences, creep past our dogs, climb on the cisterns, remove the concrete lids, and pour in some horrible chemical. It took me a while to understand that what they generally meant is terrorists flying over my house, spraying from airplanes, not

the pasture-sneaking kind. How does one differentiate a terrorist from a normal domesticated crop duster? Don't both fly over unsuspecting areas and spray huge amounts of poison everywhere?

"But the acid rain is dangerous!" - More rainwater concern, from people who get their water from municipal water supplies, or often contaminated wells. The city water is regularly so chlorinated that it kills tomato plants. Fairly frequently, the media warns about E. coli (a euphemism for feces), or arsenic contaminated water. I explain that, if acid rain is a concern, very little baking soda added to the cistern every month or so will neutralize the acid. Often, the reaction is that this is too much trouble. Of course, sitting in traffic to and from Walmart, to purchase 50 pound bags of salt, and adding it regularly to a \$1,200.00 water softener is less trouble than the unnecessary cure for a non-existent problem.

"What about the drought?" - Believe it or not, South Louisiana recently did have a three month period with no rain. Numerous areas, supplied with municipal water, were put on water restrictions. Worse yet, the water supplied was often the color of strong tea, smelled horribly, and was essentially unusable - "but safe to drink". The local television news sent a crew to interview us. We described the fact that we were living as we usually did, with plenty of clean, cool, fresh water. But of course, any minute the acid rain or terrorists could gum up the whole works ...

"Those poor people don't have air conditioning" - This from people of all ages, races, genders, and places of birth. Absolutely amazing, since residential air conditioning was a luxury for many, or most, until only 30 years ago. Today, it has replaced oxygen as the most basic human need on

Maslow's Hierarchy. Without a doubt, the fear of leaving behind refrigerated, processed, re-circulated, stale air is the biggest obstacle to people accepting the off-grid vision. Our house was designed from the ground up to be well ventilated, and to minimize environmental heat gain. Eddie used hard-won knowledge, gained by our ancestors, building on the foundation of the local Native American experience, then further refined using colonial Spanish and French techniques. Combining this hard-won knowledge with modern theories and



materials, we have built a house that is comfortable, even on the hottest of days. The operative word is “comfortable”. In our house we could not hang and age meat appropriately. We’ve pretty much decided not to do that. When people hear of the lack of air conditioning, visitors invariably the males in the relationships, say they themselves (the men) could tolerate it, but not the wives or girlfriends. When the couples finally take the tour, and experience the home on a hot day, there is universal surprise at the comfortable temperature. However, if there is negativity, it is more typically the men. The women almost always say they could easily live like this. The truth comes out: Lying on a couch flicking the remote control is much less effort in refrigerated air, and the men generally are more resistant to the very idea of switching channels in unprocessed air.



There are dozens more reactions to the idea of living off the grid in our challenging climate. The majority of the visitors relate their experiences as children visiting their grandparents’ homes. They remember that the house was comfortable in the summer. At night homes were actually cool, with the help of ceiling and attic fans. This I know is true, not some foggy memory, because currently my wife and I need a light blanket to sleep comfortably at night.

A lot of older visitors fondly remember their long-gone, bulldozed and burned, ancestral homes. They mourn the loss of a simpler, less sterile lifestyle. They come here to visit our throw-back home, and are reminded of what was. They leave to return to their new, air-conditioned 3,500 square foot, black roofed houses, with non-functioning windows set on lots stripped of all vegetation. They return to the air-conditioning - after all - a quality life demands it. There can be no discussion. For my wife and I, we think how difficult it must be to look out of the closed windows in an air-conditioned house, and watch life go by - like some really boring network TV show.

Things are not completely hopeless. The steady stream of visitors through our house is increasing. People are starting to make a point of visiting with their parents and grandparents. Those visitors are calling or emailing with sensible questions on energy efficiency, alternative renewable energy, and rainwater harvesting. A local group is designing an Intentional Community, that will feature off-grid small homes, organic gardens, and rainwater harvesting. Besides living lightly on the earth, and approaching the goal of self sufficiency, probably the most satisfying part of this journey has been the reactions of the very old and the young. The children naturally enjoy the elevated views, a house built to encourage activity, the idea of converting sunlight to electricity, and using a climbing wall instead of stairs to access our home’s loft. The older folks seem genuinely fond of recounting how they grew up poor in material things, but rich in spirit. They lament that their children and grandchildren are rich in material things, but poor in spirit. The general consensus is that all that disguises itself as progress, is not progress, and that the most important things in life have been exchanged for manufactured dreams. Most people seem to know that something is terribly wrong with our country, attitudes, and lifestyles. The current cultural trajectory is way off course. “The boy is crazy” was initially used to describe us as eccentric and misguided. Now, for most of our visitors, their friends, and families, it is meant as a compliment.

### Home Description



We built a 1,160 square foot (108 square meters) house, elevated 11 feet (3.4 meters) on recycled oil field drill pipe piling. The drill pipe sits in flanges, mounted to 12” diameter (30 centimeter) concrete pilings, that extend 10 feet (3 meters), into the clay soil. Underneath the house is a well insulated, unconditioned utility room, 19 feet X 16 feet. The Sun-Mar NE3000 Centrex composting toilet collection apparatus, the

Continued on next page

highly efficient Sears front loading clothes washer, and the propane dryer, are located in the utility room. On opposite sides of the house, there are sets of wide stairs made from salvaged steel, leading up to the living area. An eight foot wrap around, covered porch encircles the house. The porch overhangs were calculated to shade the house during the summer months, and allow sunlight to reach the walls and windows during the cooler months. Double French doors, and casement windows were custom built locally. These doors and windows are designed in the French tradition, for functionality, and to remind my wife of her home country of France.

The house is a salt box design, with a nineteen foot cathedral ceiling sloping to the north to 7 clerestory, awning windows. The home ventilates naturally through these elevated windows. The house was sited with the long axis running east to west. The prevailing summer breezes going over the roof actively ventilate the house. We do not have any mechanical air conditioner. We have a batch solar water heater on the roof that feeds an Aquastar propane, on-demand hot water heater. Our two stoves are propane with pilot lights. One is in the upstairs kitchen, and the other is outside under the porch for summer cooking. Keeps the heat down. Our floors and wood trim throughout the house are salvaged wood we milled.



The trees were pecan, oak, and ash, that were downed by Hurricane Lili, and were destined for a landfill. We heat with two air-tight EPA wood burning stoves. Casa Blanca ceiling fans are located in each room. The house is airy, open, uncluttered, easy to clean, and flooded in indirect natural light. We communicate with the outside world with radio phones and wireless, high speed internet beamed 6,250 feet via a Cantenna <http://tinyurl.com/2ultx>.

**Tony Adrian**

[Discuss It!](#)

Discuss this article on the Little Houses forum

### WHAT?

You don't know what a Cantenna is??

It's one of these of course!



... and 'can' be mounted like this



Read all about making a Cantenna [HERE](#)



# WORK SAFE



by Larry D. Barr  
and Steve Spence

**On 3 June 2005, John Drury, 45, of Little Silver, NJ died needlessly. Mr. Drury was repairing a pinhole leak in an 8,000 gallon tank at Environmental Alternatives, a biofuel company on Staten Island. The authorities believe that a spark from Mr. Drury's grinder ignited methanol vapors in the glycerin contained in the tank, which contained about 1,400 gallons of the byproduct of biodiesel production.**

This tragic and unnecessary death was caused, not by faulty equipment or a sudden failure of a safety cable, not by the collapse of a foundation or the impact of an errant vehicle. It was caused by failure to heed the safety precepts by which we all must live. For if we do not live by them, we ask to be injured or killed.

It is imperative that, as we work on our renewable energy projects and systems, we scrupulously adhere to all safety procedures which apply to the task at hand. Our own safety is not the only reason that necessitates this action. It is also essential that we maintain an exemplary safety record for our movement. Detractors and opponents of renewable energy and self sufficiency abound and each injury, each death among our community only give them more ammunition against our cause.

Let's review some of the rules for working safely with various components of our renewable energy systems. We'll start with  
**ELECTRICAL SAFETY**

- Do not work on live circuits. Before working on an electrical circuit, be sure that the breaker is off or the fuse pulled, and that the disconnect device is fixed in the off position. Also the disconnect should be tagged to indicate that it must be left in that position. The electrical industry's term for this safety practice is "Lock Out, Tag Out" and premade kits are available for the implementation of the practice.
- Never underestimate the destructive power of a low voltage DC system. A friend of mine, while working on a truck tractor, dropped a wrench between the battery bank and the frame rail. As he reached in to pick it up, his wedding band shorted between the positive battery post and the frame. The band vaporized instantly and Frank's finger was amputated and cauterized simultaneously. Remember that a battery bank will deliver essentially unlimited energy for a very short period of time.
- Remove jewelry and watches before working on electrical systems. Electricity will always take a shortcut. Don't make it easy for those electrons.
- Always wear protective gear if required, especially when working with batteries. Sulfuric acid is nasty stuff and will burn you severely. Wear a protective apron, glove and a face shield. Also, be sure to never generate sparks around batteries.

**ELECTRICAL SAFETY Cont.**

- When required to work on live circuits, turn them off while connecting the test equipment, and then reactivate the circuit after the test gear is securely connected.
- Always comply with NEC and/or manufacturer's grounding requirements. The purpose of grounding is to give any fault current a safe path to earth in the event of a malfunction. An improperly grounded circuit is an unsafe circuit.
- Be sure to use the proper size conductor for each application. Undersized conductors generate excessive heat and present a fire danger..
- Use common sense. A careful, thoughtful approach to the job is one of your best safety devices.

**BIODIESEL SAFETY.**

Biodiesel is made from a harmless liquid vegetable oil. However, the materials used to turn vegetable oil into biodiesel are far from harmless. Methanol and lye, both dangerous chemicals by themselves, combine into a mix called methoxide, that kills the nerves and eats the skin. The vapors are very dangerous, so the process should be accomplished outdoors, or in sealed containers that cannot be vented into the workspace where they might be breathed. Methanol vapors are also flammable, so keep away from flame and heat sources. The common white dust masks are ineffectual combating methanol fumes. Chem lab quality gloves and goggles are recommended.

Steve Spence  
Dir., Green Trust <http://www.green-trust.org>  
Contributing Editor  
<http://www.off-grid.net>  
<http://www.rebelwolf.com/essn.html>

**!! BE SAFE !!**

And if you want a salutary example of what NOT to do with gasoline ... [watch this movie!](#)

And for those that do not read German, the caption that comes up after the matches are offered says:  
"OK, we'll do that in a minute!"

# MAKING BIODIESEL MORE GREEN



by Steve Spence

Kermit tells us “It’s not easy being green”, but we thought it would be a good thing to look at the biodiesel process, and make it more environmentally friendly, and more self sufficient. The three ingredients in Biodiesel are vegetable oil, alcohol, and a catalyst. The alcohol is usually methanol, made from fossil fuels, and the catalyst is usually NaOH, known as Lye.

## There are two ways we can clean up this process.

1. Replace methanol with a home grown alcohol made from sugar/starch crops, called ethanol.
2. Replace the NaOH with KOH, which is plant friendly when it comes to composting the resulting glycerin and recycling the wash water.

In this article we will address the first step, and we will continue our experiments with the second at a later date.

Ethanol based biodiesel (ethyl esters) takes a few steps not as necessary with methanol based biodiesel (methyl esters).

1. The ethanol has to be 200 proof (100% “anhydrous”).
2. The oil has to be dewatered and fine filtered.

**Any** water in the reaction (including high humidity) can spoil the brew, so bear in mind that BCB’s (Burnt Crispy Bits) in the oil can contain water. Heat the oil to 300F or so until it stops crackling.

## We started with three batches of biodiesel:

1. 200 proof ethanol, NaOH, and virgin oil
2. 180 proof ethanol, NaOH, and virgin oil
3. 200 proof ethanol, NaOH and WVO (used fryer oil)

## The recipe for each batch was:

- 150 ml of ethanol
- 500 ml of oil
- 3.5 grams of NaOH (5 grams on the used fryer oil, based on titration results).

Mix the lye into the ethanol, and shake until the lye totally dissolves (about 10 minutes). This reaction creates heat, and we developed a leak in the plastic veggie bottle (due to the heat or the ethanol), so we switched to a glass bottle. Go Bacardi! Then add the oil, and gently end-over-end the bottle (5 to 10 times). Do not shake, or you will end up with soap! Mixture will turn black, then silver then back to amber as it mixes. From new oil, the resulting biodiesel looks almost crystal clear. This is the “Soon to be famous Bacardi Technique (no Patent Pending)”.





**Batch 1:**

200 Proof Ethanol, New soybean oil.  
**Success!**

**Batch 2:**

180 Proof Ethanol, New soybean oil.  
**No Success.**  
 Will put in sun to heat up and see if it recovers.  
**No recovery!**

**Batch 3:**

200 Proof Ethanol, used fryer oil.  
**Success!**



The results were clear. From the 2 batches of 200 proof ethanol, we got clean separation, and good biodiesel. From the watered down ethanol we got no reaction.

This recipe was developed in conjunction with Rich Reilly at Biodieselwarehouse.com, and performed at his location.

Steve Spence  
 Dir.. Green Trust  
<http://www.green-trust.org>

**Discuss It!**

Discuss this article on the Green-Trust forum

# Bio-Diesel in Germany

by Bryan J. Ball

Biodiesel has only begun to catch on in America, but it is definitely becoming a mainstream commodity in Germany. In 2004, this country produced nearly 1,000,000 tons of biodiesel fuel. This fuel is available at nearly 2,000 filling stations throughout the country. In a nation that is 350,000 square kilometers, this means that a biodiesel pump is usually no further than 15-20km away in many regions.

Most biodiesel available in Germany is made in Germany. The primary crop used to produce it is rapeseed. This winter annual crop is extremely plentiful here and turns the entire countryside a lovely shade of yellow as its blossoms appear in the spring. Rapeseed produces approximately 2,000 pounds of seed per acre. This amount can create one hundred gallons of oil and 1,200 pounds of meal. Approximately 12% of the world's rapeseed and canola production comes from Germany (the United States accounts for about 2%). Rapeseed is refined into biodiesel at nearly a dozen plants throughout the country.

It has taken the demand a bit of time to catch up with the supply in Germany, but the numbers are definitely booming. The demand for biodiesel has increased seven-fold over the last ten years alone. In the year 2001, Germans pumped 163.2 million liters of biodiesel into their cars. In 2004, that number had increased to 476 million liters. Most of this increase can be attributed to government incentives and industry encouragement. The capacity and supply were built up and put in place before the people really began asking for it. The German government basically decided to assemble the infrastructure first and then give the citizens reasons to make use of it. It's really proof that "If you build it, they will come."

In fact, the German government may have done their job a bit too well. There is a growing concern that there may not be enough rapeseed or other crops being grown to keep up with the increasing demand. There also may not be enough to reach the Kyoto Agreement's goal of replacing 5.75% of fossil fuels with biofuels by 2010. To combat this problem, Germany is beginning to produce BTL (biomass-to-liquid) fuel using wood and other biomass.

BTL can be made with wood, corn, straw and even garbage or sewage. The BTL process starts by grinding and drying



the biomass then forming it into pellets. These pellets are then converted into gas and solid (charcoal) components. The gas is then reprocessed back into a liquid and refined. During this final step, the fuel can be customized for different applications. (Hence the nickname "designer fuel") BTL emissions do not contribute to greenhouses gasses or acid rain. The first large-scale processing plant for this new fuel project was scheduled to open this year and produce 13,000 metric tons annually. If successful, another commercial plant with a 200,000 annual metric ton capacity will go online in 2008. Volkswagen and DaimlerChrysler are working together with a company called Choren on this project.

I recently spent some time at the local biodiesel pumps harassing and interrogating people. I found out that their reasons for using biodiesel vary greatly. Of course many of them are concerned about the environment. When you live in a small country with comparatively few resources, it's important that you protect what you have. Recycling is a compulsory activity here and much of the countries energy comes from wind farms. Therefore, most Germans grow up with a level of conservational awareness that exceeds that of most Americans.

However, the primary reason that most drivers gave for using biodiesel was the price. If there's one thing I've learned about the German people in the last two and half years of living with them, it's that they know a bargain when they see it. Germany does not currently apply motor-fuel taxes to biofuels and won't start until at least 2009. The European Union has allowed member states to grant a tax exemption for the share of biofuel in a blend until that time. This keeps the price of biodiesel in line with that of conventional diesel. In fact biodiesel is currently a few cents a liter cheaper than its fossil-based alternative.

These tax laws have also created another interesting phenomenon. Many German drivers are using biodiesel without even realizing it. Several companies such as BP and Shell are diluting their "regular" diesel with a 5% blend of biodiesel. This is a low enough blend that they don't have to divulge it and allows them to take advantage of the tax exempt status to make their diesel cheaper than that of their competitors.

Not all biodiesel in Germany is the product of big business. There is also a growing grassroots biodiesel movement. Currently, this is most evident among the farmers that grow the rapeseed for larger fuel producing companies. They've begun to realize how relatively easy it is to make their own

biodiesel for use around the farm. Some of them have begun forming small co-ops to work together and produce larger batches of home-brew biodiesel.

One way or the other, it definitely appears that biodiesel is here to stay in Germany. It's not just a fringe product anymore. Government incentives and promotion have turned biodiesel into a big time industry and a valuable national resource.

**Bryan Ball**



Bio-powered ... if not diesel!  
Bryan with his itsy bitsy teeny weeny  
Polka Dot Bi.....



We're getting a bit worried about our Bryan!





# ELECTRIC VEHICLES

## “AS THE EV TURNS”

by Jerry Dycus

Hi EEveryone,

I've been asked to write a column on EV's here which is cool as I've always wanted to write and EV's are my passion, added to that, ESSN is a great place to start.

My love of designing, building things got me into EV's as I had moved to land after living aboard my sailboats 20years and needed transportation but after taking 4 hrs to replace a thermostat on my car, I decided there had to be a better way.

I had played around with EV's before with my best one to that point being a B+S mini bike replacing the ICE motor with a Ford starter motor, a battery, a seleniod and a go button. It had gobs of power and if I didn't push off and lean way over the handlebars, it would wheelie, then land on top of me. EV's do not have to be slow!! It lasted a month riding to work until the police told me if they seen me riding it again, well you get the picture.

But it would not have lasted much longer anyway so filed it in the back of my mind to pop back out many years later when the thermostat problem reared it's ugly head.

Having designed, built many wood/epoxy and other boats, I had decided to build a 3-wheel EV enclosed car with a VW Bug front end and a drive wheel in the rear with the body, chassis made of wood/epoxy called the E woody.

It was my first car design and it showed!! I made several mistakes, mostly in the front wheelwells, fenders but other than that and a lack of ability to hold many batteries, it's worked fine for 10 years and still running today. While I realize it's ugly as sin, others really enjoy it bringing a smile to their faces. As for me, the one cent per mile electric fuel costs, \$200/year total cost brings a smile to mine. At the same time I built a series of E bikes, E trikes, some sucessful, some not, but all a good learning experience.

The current projects are a 45-50mph MC EV trike/pickup using a golf cart transaxle and a Honda Elite 80 scooter front end which should make a great grocery getter at a very low cost and trying to put a composite version of the E-woody, the Freedom EV into production with the help of a group of EV'ers. My guiding ideas are 'Keep it Sweet and Simple', inexpensive and reliable transport that doesn't use oil for fuel for so many reasons.

With this column I'll tell you how to make your own EV's from low cost componants you can find most anywhere, how to select and manitain them so you too can have an EV grin from driving your own EV you built!

Future columns will be about E bikes, E trikes, E garden/lawn tractors, E boats, EV MC's and car conversion EV's along with their components like batteries, chargers, speed controls among other things.

EV's are simple, easy to maintain, low cost responsible transport if you do them right and my goal is to show you how to do just that. I hope you enjoy it.

So stay tuned for more of,

“As the EV Turns”

by Jerry Dycus

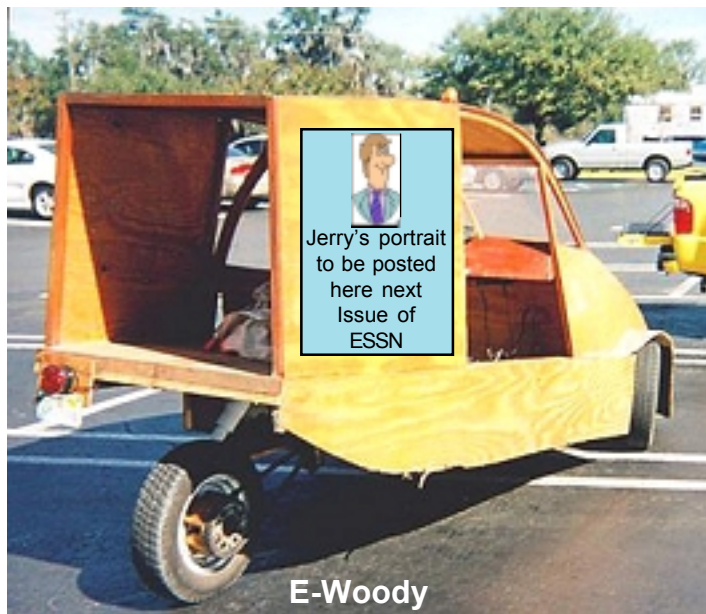

E-Woody

**Computers  
by  
Jared**

- > 12/24/48 VDC Power
- > 120/240 VAC Power
- > Custom Configuration
  - > Designed for YOU
  - > Energy Efficient
  - > Guaranteed

**Email today for  
info and a quote:  
info@jwross.net**



**Electricity - Make it, Don't Buy it**  
**Tired of high electric bills?**  
**This instant download eBook**  
**shows you how to set up your own**  
**power station in your back yard**

**FREE Biodiesel book!**

**Also... electricity saving tips,**  
**methane, free energy notes,**  
**solar heating & cooling, and**  
**much, much more.**

**For complete, no obligation**  
**details....**

**click here**

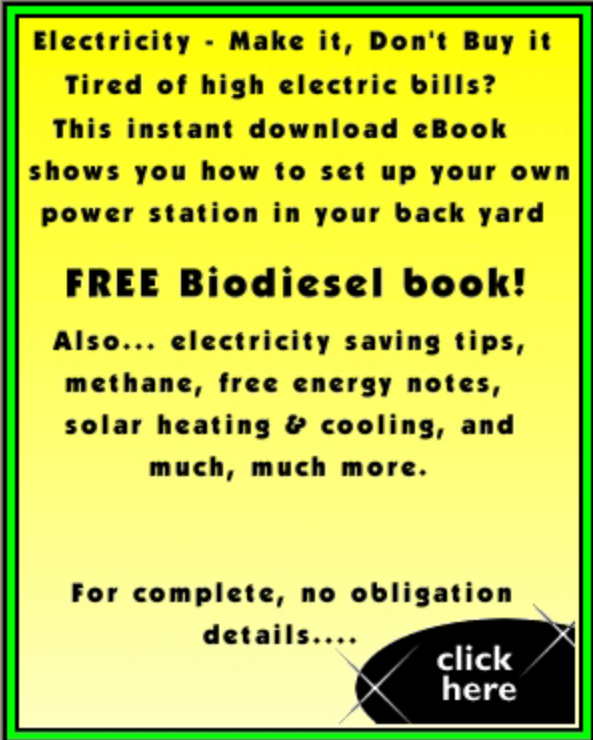

**BIODIESELWAREHOUSE.COM**

**WWW.POWERWERX.COM**  
**POWER CONNECTOR SUPERSTORE**

**Standardize Your Power Connectors**

**Best choice for New Hams**  
 Share Emergency Power • Reusable • Easy to Use  
 Anderson Powerpoles®, Adapters & Accessories



Build your own  
to buy assembled

VeriSign  
Easy secure  
online ordering

Authorized RIGblaster & RIGrunner Dealer

**powerwerx.com**

Huge savings • lowest prices  
Over 1500 products in stock • Satisfaction guaranteed!



**DIY BIODIESEL PROCESSOR KIT**  
**SALE PRICE - \$199.00**



**DELUXE BIODIESEL  
PROCESSOR KIT**  
**SALE! \$699.00**



**6 KW DIESEL GENERATOR**  
**120/240 VAC 60Hz 1Ø**  
**SALE PRICE - \$1,999.00**



**HAND SIPHON PUMP**  
**FOR 55 GALLON DRUM**  
**SALE! \$24.95**

**FOR MORE INFO:**  
**SERVICE@BIODIESELWAREHOUSE.COM**

## ESSN Classified Ads

**FOR SALE** -- 12.5 KW Biodiesel generators. Combines the 2-71 Detroit Diesel engine with an extremely heavy duty Delco or Emerson brushless alternator. This is the generator Steve Spence chose for his own BIODIESEL system. Rebuilt units starting at \$4395. Non-rebuilt units starting at \$1995.  
[www.affordablepower.com](http://www.affordablepower.com) 1-888-454-1193 X3

**ESSN  
Classified Ads  
are an effective  
and  
economical  
way  
to get your  
message out to  
the  
Renewable Energy  
Community**

[ads@rebelwolf.com](mailto:ads@rebelwolf.com)

Energy Self Sufficiency Newsletter is published monthly online at [www.rebelwolf.com](http://www.rebelwolf.com). The publication is free and unlimited printing and distribution is encouraged for the benefit of the renewable energy community. All contents are Copyright 2005 by Rebel Wolf Energy Systems. Please contact us for reprint permission. All printed copies and electronic distribution must contain the entire publication including this notice.

[essn@rebelwolf.com](mailto:essn@rebelwolf.com)

## Ad Rates

### Full Page

7½" W X 9¾" H

\$250/month

\$1000/6 months

\$1800/year

### Half Page

4<sup>7</sup>/<sub>8</sub>" H X 7½" W or 3<sup>5</sup>/<sub>8</sub>" W X 9¾" H

\$150/month

\$600/6 months

\$1000/year

### Quarter Page

3<sup>5</sup>/<sub>8</sub>" W X 4<sup>7</sup>/<sub>8</sub>" H

\$100/month

\$400/6 months

\$700/year

### Eighth Page

3<sup>5</sup>/<sub>8</sub>" W X 2<sup>7</sup>/<sub>16</sub>" H or 1<sup>13</sup>/<sub>16</sub>" W X 4<sup>7</sup>/<sub>8</sub>" H

\$75/month

\$300/6 months

\$500/year

### Classifieds

\$0.25/word/month

20 word minimum

Submit ad copy or advertising inquiries to:

[ads@rebelwolf.com](mailto:ads@rebelwolf.com)

**Want to barter for ads?  
What have you got to offer?**

## Circulation Info

After only three months of publication our circulation, measured by downloads of the PDF file, exceeded 10,000 for the first time with the March 2005 issue. As the word of our existence spreads, and our content increases, we will continue to share our experiences (and yours) in off-grid living and energy self-sufficiency with folks around the world. Thanks for your interest and your support. **ldb**