

Collecting and preserving adult butterflies

The basic equipment needed to collect adult butterflies and to establish a private butterfly collection includes a collecting bag, a net, at least one killing bottle, paper envelopes, pins, entomological forceps, setting boards, store-boxes, plastic bags and a notebook.

The serious field worker will soon discover that other items are extremely useful and even essential for special aspects of collection, rearing and preservation, especially when the immature stages are involved. A small pair of binoculars (x10 magnification), for instance, is extremely useful for identifying certain species, especially the smaller ones or those hilltopping species that perch in the canopy some distance from the ground. It is desirable to record the behavioural details in a small notebook, kept in a collecting field bag or shirt pocket, together with information on locality of capture, habitat and date for each captured specimen. Species observed, but not collected, should also be entered in the notebook so that a list of the fauna recorded for that area on that particular day is documented. At a later date the information can be transferred to a permanent diary, reference book or personal computer. It should be noted that the equipment and procedures outlined below are not universally adhered to, and most collectors develop their own particular methods when establishing collections.

Nets

Adult butterflies are usually collected in a net, the size and design of which can vary considerably. The specimen can be caught by a short rapid sweep of the net, followed by a twist of the handle to fold over the net bag, thus trapping the butterfly. If the specimen should be resting on the ground it is best, while holding the end of the bag

up with one hand, to place the net over it suddenly and then to allow the insect to fly upwards into the net before folding over the bag.

The simplest and one of the most effective nets has a circular metal frame about 460 mm in diameter, attached in some way to a wooden, bamboo or aluminium handle. If the frame is detachable it is much easier to pack when travelling and the fine net bag can be replaced more readily if it should be torn. Three simple methods for attachment are often used:

- 4 mm steel wire (No. 8 fencing wire) can be bent so that it fits into grooves in the end of the wooden handle and held in place by sliding a metal sleeve or hose clamp over them (Fig. 1A);
- a 12.5 mm x 3 mm aluminium strip can be used for the circular frame and bent and drilled so that it can be bolted to a wooden handle (Fig. 1B);
- the two ends of the steel wire can each be bent to form small rings which fit over a screw thread of appropriate diameter protruding from the end of the handle, and held firmly in place by a nut.

Alternatively, a light and strong net frame may be made from cane. The cane should be steamed and bent around to form a large loop, with its ends firmly clamped to a cut-down copper plumbing T or glued into a welded Y-shaped metal ferrule, into which the handle can also be fitted.

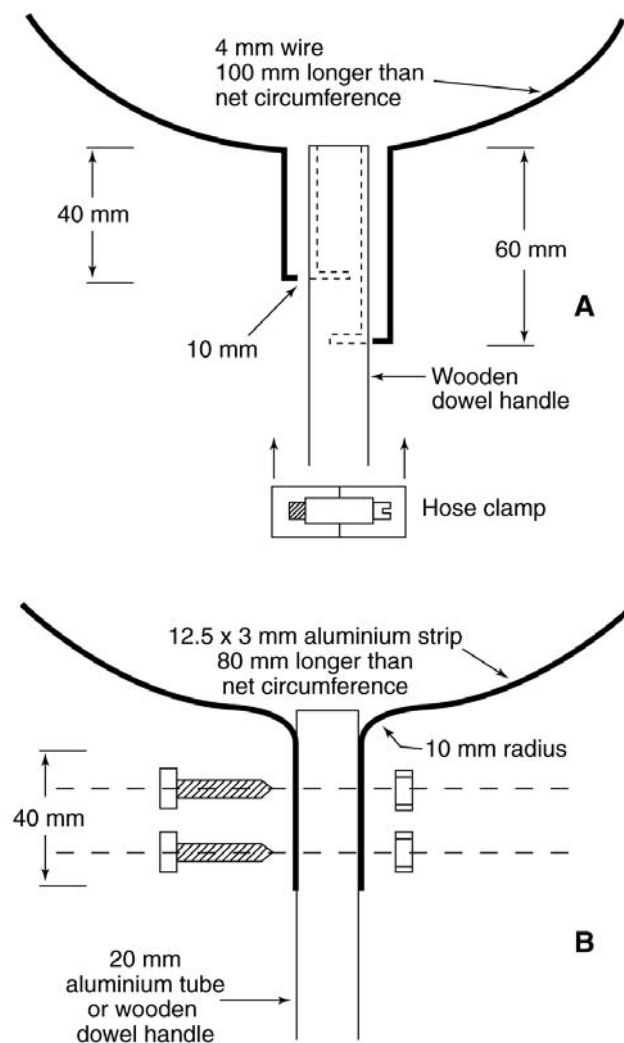

Fig. 1. Methods of attaching net frames to handles; **A**, net with wire frame; **B**, net with aluminium strip frame. After Upton (1991, 1994).

The net bag (Fig. 2) should be made of soft, lightweight, non-tear material such as Terylene, offering low air resistance, and capable of drying rapidly should it become wet. While many nets are made from white material, green or black nets will allow the contents to be seen more clearly and are not so visible to the butterfly being captured. For a frame 460 mm in diameter, the net bag should be about 810 mm in depth, to allow ample room for the enclosed insect to be trapped in the lower half of the bag when it is folded over. The bag should taper slightly and be rounded at the bottom. The mouth should have machined to it a doubled-over band of strong calico about 40 mm in width through which the wire or cane frame can be passed. A strong gusset should also be provided to prevent tearing the mouth of the net nearest the handle.

The length of the handle required depends on the height at which the desired specimens fly. Smaller handles are easier to manipulate and for most purposes the handle need not exceed 1.2 or 1.5 m in length. Most collectors carry a series of extension handles, which can be a considerable help for collecting specimens that settle on flowers, branches or foliage at different heights above the ground.

Killing bottles

Many collectors prefer to stun or immobilise larger butterflies while the specimen is still in the net. This can be done by first moving the net with the captured butterfly into a shaded area away from direct sunlight and letting the

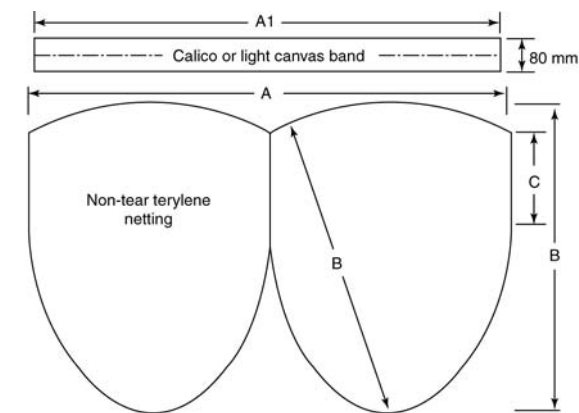

NOTE: Actual finished sizes are given. Allowance must be made for material required for seams.

Net type and diameter	A1 Circumference	A Length of reinforcing band	B Depth of net	C Parallel depth
Standard aerial 350 mm	1110 mm	1070 mm	620–700 mm	220 mm
Large aerial 460 mm	1470 mm	1430 mm	810–920 mm	280 mm

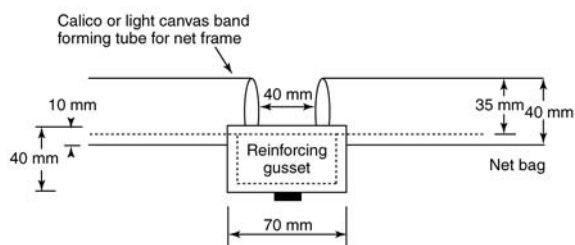

Fig. 2. Details for the construction of net bags. After Upton (1994)

insect settle for a few minutes. Once it has stopped rapidly beating its wings and has crawled to a folded region of the net with its wings held back above the body, the thorax is given a gentle but firm pinch between the finger nail of the thumb and the fore finger of the same hand from outside the net. Great care must be taken not to rub scales off the wings or break off the legs. When used quickly and deftly, this method has the advantage of preventing undue

damage to the specimen by its fluttering in the net or the killing bottle, and also makes its escape less likely. With practice the correct amount of pressure can be applied without causing noticeable external damage to the butterfly.

After a specimen is immobilised in this way it should be placed in a killing bottle (Fig. 3). The best killing bottle is prepared by very carefully placing about 7 mm of crystalline potassium cyanide in the bottom of a wide-mouthed glass jar and covering it with 7 mm of dry plaster of Paris. A circular piece of blotting paper is then placed over the dry plaster and a thick mixture, about 12 mm deep, of plaster of Paris and water is poured into the bottle. The bottle should have a tight-fitting rubber stopper or a quarter-turn-to-open screw-capped lid with a good seal. When the plaster has fully dried (preferably in the open air), a pad of tissue should be cut to fit firmly in the bottom of the bottle over the plaster to absorb surplus moisture and the lid replaced. For the potassium cyanide to give off its poisonous gas it must react with water, and it may therefore be necessary to add a drop or two of water to the tissue should the bottle dry out.

As cyanide is an extremely dangerous poison, the killing bottle should be well taped around the base with surgical adhesive tape to prevent accidental breakages, and it should be clearly labelled and kept well out of reach of children. If used sensibly, removing the stopper only momentarily when specimens are to be inserted or removed (and avoiding inhalation of the gas when the bottle is open!) a killing bottle can be used with complete safety and should be effective for a year or two with average use. In most States a permit is now required to obtain, store and use potassium cyanide.

If cyanide is not available, an effective killing bottle can be made by pouring 20 mm of the plaster of Paris mixture directly into the bottom of the glass jar and, when completely hardened and thoroughly dry, adding a few drops of liquid ethyl acetate to the plaster. It is a good idea to cover the plaster with a thick pad of tissue after the chemical has been totally absorbed to ensure specimens never come into contact with the liquid or moistened plaster. This kind of killing bottle needs to be recharged before each day's collecting. Ethyl acetate is relatively harmless, but you should avoid inhaling its vapour any more than necessary. Care must be taken with lycaenids as the wings are invariably permanently stained if the liquid has not been completely vaporised. Ethyl acetate may be bought from an

entomological supplier or obtained from nail polish remover from a pharmacy.

If living specimens are not immobilised by first pinching them in the net, they should be introduced to the killing bottle inside the net. This can be done by carefully working the bottle, with stopper or lid removed, into the net bag, and placing the mouth of the bottle over the specimen; the stopper can be gently replaced on the outside of the net until the specimen stops fluttering. The bottle is then withdrawn from the net and the stopper replaced. Many butterflies, lycaenids especially, reverse their wings in the killing bottle and if this is not corrected at the time they are very difficult to handle later without damage. As soon as they stop fluttering in the bottle the legs or thorax should be gently grasped with a pair of curved-ended forceps and the wings returned to their normal position by gently blowing them apart.

After specimens have remained in the killing bottle for 10 to 15 minutes, they should be removed and transferred individually into paper envelopes (see below) to reduce unnecessary scale loss that might otherwise occur. Alternatively, some collectors, whilst in the field, prefer to pin the specimens (especially hesperiids and lycaenids) and place them into a small relaxing-box (see below) to keep them fresh. If specimens cannot be removed promptly after death they should be prevented from sliding about inside the killing bottle and becoming damaged during field transportation. By loosely filling the bottom half of the bottle with a wad of tissue, the butterflies, with their wings folded over their bodies, are placed carefully between the tissue and the inside of the bottle by means of forceps. In order to allow the specimens to be pinned or spread within the next couple of days they should not be

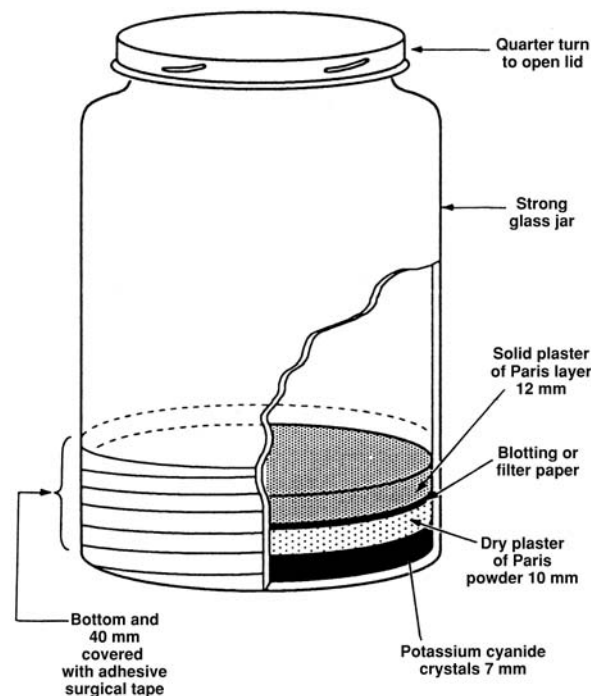

Fig. 3. Construction of potassium cyanide killing jar. After Upton (1991).

allowed to dry out. After a specimen has been killed *rigor mortis* sets in quite rapidly and a period of about six to 12 hours must elapse before it again becomes fully relaxed and suitable for handling.

At home, specimens may be killed by placing them in a freezer after first transferring them to a jar or plastic vial. Except for alpine and subalpine species, which may survive for several days, most butterflies die within about 24 hours when kept in deep freeze. This technique works well when rearing specimens indoors, and the specimens may be kept fresh in the freezer for many months provided the jar or vial is secured with an airtight lid.

Paper envelopes

Paper envelopes (Fig. 4) are made from semi-transparent, rigid, greaseproof paper and may be rectangular or triangular in shape.

Rectangular envelopes can be purchased from most post offices or philatelic shops, whereas triangular envelopes need to be made from rectangles of light weight paper, such as high quality tracing paper (90–95 gsm), one and a half times longer than wide; they can be cut to various sizes depending on the size of the specimens to be papered. A supply of these should be cut and folded in preparation for the day's collecting.

Before enclosing the specimen in the envelope the locality, date and other information should be written on the opened flap. Alternatively, if several specimens are being collected from the same locality the details can be entered on a separate sheet of paper that is placed in the container of papered specimens. However, if this method is adopted great care must be taken that specimens from different localities are not mixed with one another. The specimen is placed in the envelope with its wings folded back-to-back with the antennae lying parallel to the costa of the forewing, preferably along the diagonal fold of the paper triangle. In this way the antennae are less likely to break when the dry specimen is later removed from the envelope. The two triangular flaps are then folded down.

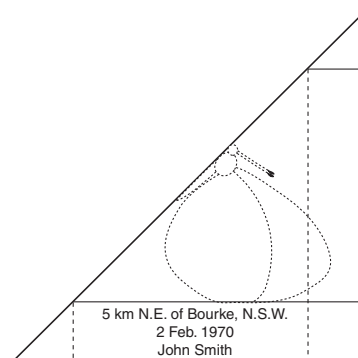
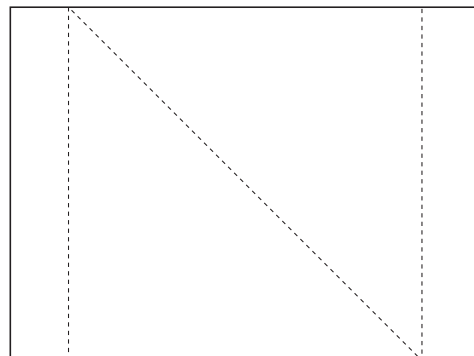

Fig. 4. Method of folding triangular paper envelopes. After Common and Waterhouse (1981).

In the field, paper envelopes into which the fresh specimens have been transferred can be placed flat into a small container, such as a tobacco or cigar tin or plastic box which can be carried in a pocket, or directly into a relaxing-box (see below). The container should be moistened slightly by placing a damp sheet of blotting or tissue paper into it to prevent drying of the soft tissues of the specimens.

Alcohol collection for DNA preservation

In recent years there has been considerable interest among the scientific community in molecular biology and its application to systematics and taxonomy. One focus of research

has been to compare the nucleotide sequences of certain genes of the deoxyribonucleic acid molecules (DNA) from different butterflies to determine their evolutionary relationships and higher classification. Butterfly specimens collected for these types of analysis are stored in alcohol in order to preserve their DNA, and it is here that the amateur field collector can make a valuable contribution by assisting scientists with the supply of specimens for subsequent laboratory analysis. The following provides a simple procedure for making an alcohol collection of adult butterflies.

For each species it is preferable to collect a small series of individuals (three is optimal), although if only one or two individuals are available these will be very useful. Butterfly specimens that have only moderate, little or no wing damage are desirable in order to facilitate accurate identification by other workers. After capture, the butterfly is kept alive, placed into a paper envelope and then kept cool until it is ready to be processed. It is usually easier to manipulate and process the specimen indoors after returning from the field.

To process the specimen, immobilise the butterfly by pinching it firmly on the thorax using a set of forceps. Immediately after stunning the specimen carefully remove the wings at their base using a second, finer set of forceps with sharply pointed ends or with a pair of fine scissors. The detached wings are placed back into the paper envelope. The wingless body containing the head, thorax and abdomen is then placed into a small plastic vial containing alcohol (100% ethanol). The opening of the vial should be secured with a screw-top lid fitted with an o-ring rubber seal to prevent leakage or evaporation. It is crucial that each specimen be processed as freshly as possible: once the specimen has been immobilised or killed it should be transferred into alcohol immediately before the DNA has time to deteriorate. The ethanol should be as pure as possible in order to properly desiccate the specimen: it must not be diluted with water.

The next step is to prepare a small card label slightly smaller than the dimensions of the plastic vial. Using a pencil or waterproof pen a unique identification number (e.g. B001) is written on the label for each specimen; the label is then inserted into the vial containing the wingless body and alcohol. The same identification number must then be clearly written on the paper envelope containing the four corresponding detached wings. The envelope should also include the field collection data (i.e. locality, date, collector) and the name of the species and, if possible, the sex of the specimen. The envelopes can be conveniently stored in a small box with a few flakes of naphthalene or in a unit tray of the main butterfly collection. It is important to retain the wings as these will serve as vouchers for the alcohol collection and subsequent DNA sequence profiles.

Relaxing-boxes

Freshly collected papered specimens should, at some stage during a day's collecting, be transferred to a relaxing-box so that they remain moist and soft. In this way the specimens can be pinned or spread that evening or within 48 hours.

Plastic containers (e.g. Tupperware, take-away, ice-cream) are suitable for relaxing-boxes, provided they are airtight. The bottom of the container should be covered with a piece of plastic absorbent sponge cut to shape and a piece of 5 mm thick balsa wood of the same dimensions placed above it, followed by several layers of tissue paper. The balsa wood can be secured by means of fine pins through the wall of the container. The plastic sponge should be kept thoroughly wet so that the balsa wood remains moist, but not over saturated with free water. Some crystals of chlorocresol must be added to prevent mould growth.

The papered specimens are laid carefully between the layers of tissues on top of the balsa wood. If the specimens are not to be pinned or spread immediately on the day of collection it is often a good idea to place the relaxing-box into a

car-fridge or large esky with an ice-block to keep the material cool to further reduce moisture loss, especially if working in hot or tropical climates. If the specimens are not to be pinned or spread for several weeks or months the relaxing-box should be kept in a freezer so that the specimens remain frozen. For those collectors who prefer not to use paper envelopes the specimens are pinned directly into the balsa wood.

If the specimens are not to be handled for many months or years, the papered specimens should be allowed to dry out completely. They may then be kept for an indefinite period in dry containers containing a small amount of naphthalene. Similarly, pinned specimens can be allowed to dry out and kept, unspread, in store-boxes (see below). Both papered and pinned specimens can be relaxed and spread at a later date (see below).

Pinning

The best specimens will be those that are pinned soon after being killed and spread while still fresh. A specimen must be properly relaxed before it can be pinned. To pin the specimen, first gently hold the thorax between the thumb and forefinger of one hand so that the wings are folded back above the body. Then with light pressure open the wings slightly so that the point of the pin, held in the other hand, can be carefully inserted from above into the middle of the thorax. The pin should pass vertically through the thorax (not angled in any direction) so that the point emerges between the bases of the mid legs. The pin is then gently pushed through the specimen until two-thirds (approx. 24 mm) of it protrudes beneath the body. Accuracy of pinning is important for successful spreading of the wings.

Butterflies should be pinned only with stainless steel entomological pins. These are usually 38 mm in length and are manufactured especially for this purpose. No. 3 pins will be found suitable for most species, but the largest species, such as birdwings, will require No. 5, and some of the very small lycaenids may require No.

2 pins or even micropins (D1). Nickel or plated brass pins are not satisfactory, because in many species the body acids will corrode the brass and the green products of corrosion, called verdigris, will eventually destroy the specimen. Household pins are also unsatisfactory because they will corrode and are too small, thick and blunt for the pinning of insects that are to be included in a permanent collection.

After pinning, the fresh specimen may have its wings spread immediately on a setting board, or it may be pinned temporarily either into a relaxing-box for spreading within the next 48 hours or into a store-box to dry and be relaxed and spread at a later date.

Store-boxes

Pinning specimens temporarily into store-boxes is particularly useful during long field trips when there is a surplus or backlog of material that cannot be spread. Each pinned specimen is placed in the store-box, preferably with the wings held either flat or partially open above the body. All the specimens collected from a specific locality on a particular day should be neatly and compactly arranged in a row or rows at the end of which there is a single label giving the relevant collecting details. It is advisable when field pinning to only use one side of the store-box, otherwise the wing tips of specimens placed on opposite sides of the box may damage one another. Large specimens should be held in position with two cross-pins placed over the abdomen to prevent the specimen from moving and damaging adjacent specimens.

Store-boxes are constructed of wood with plywood tops and bottoms in standard sizes, and open so that specimens can be pinned into the polythene foam or cork that lines the inside of both top and bottom. Boxes should be deep enough so that the heads of the pins do not touch one another when the box is closed. Convenient sized boxes are 450 mm x 300 mm x 100 mm or 360 mm x 250 mm x 100 mm. They should be light-proof, airtight and insect-proof. The boxes

should not be coated with a wood finish as this prevents the moisture from escaping and the insects drying properly. Coated boxes may be used for storing fully dried and spread specimens in a permanent collection.

Relaxing dried specimens

Specimens that have been pinned and dried in a store-box or dried in paper envelopes must be fully relaxed before they can be spread. The dried specimens are placed in a relaxing-box as described above: papered specimens are simply laid on the damp surface, whereas pinned specimens are pinned into the balsa wood sheet. The time required to relax specimens varies with the temperature, but 12 to 48 hours should be adequate for most butterflies. The specimens should be examined periodically during the relaxing period to make sure the wings are not becoming wet and stained. If still not wholly relaxed after this period the damp specimen may be carefully removed and 0.1 to 0.2 ml of boiling water injected into the thorax using a small syringe. The hot water softens the flight muscles and permeates the veins of the wings, but care must be taken not to inject too much water as this may lead to excessive wing damage, including staining and scale loss. The specimen should be ready for spreading within a few minutes of injection.

Setting-boards

Setting-boards are used to spread the wings of specimens flat in the correct position, and to hold them in this position until the body is thoroughly dry.

Setting-boards (Fig. 5) have a central groove, to accommodate the body of the insect, flanked by two flat surfaces on which the insect's wings are spread. They are usually 250 to 300 mm long, and can be made using a 4 mm sheet of waterproof plywood or masonite as a base on top of which is glued a 10 mm thick sheet of

polyethylene foam or soft cork. Two pieces of soft balsa wood 15 mm thick are then glued to the polyethylene or cork, leaving a central groove. The top of the balsa wood is smoothed with very fine emery paper and preferably covered with 1 mm x 1 mm squared graph paper or white, gloss, art paper. The paper, placed over the board in one piece, should be glued with wallpaper paste so that it can be readily removed and the board repapered as it becomes worn. When the paper dries, the groove is then cut. Polystyrene foam is not recommended for the construction of setting-boards because the pins create a small permanent hole, and the material is very soluble in most solvents such as ethyl acetate.

Setting-papers, used to hold the wings in the desired position, are long rectangular pieces of cellophane, clear plastic, drafting paper or similar transparent material that will more than cover the entire spread of the wings. They should be a few millimetres narrower than the width of the

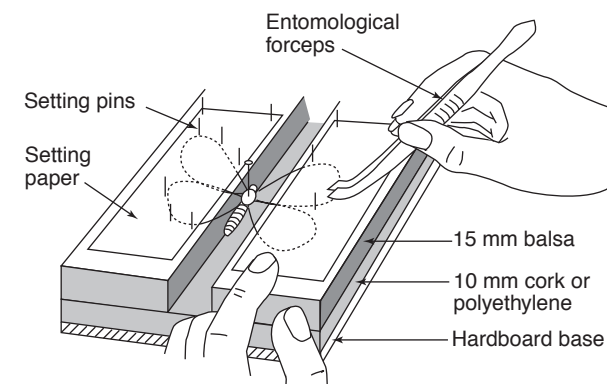

Fig. 5. Setting-board and method of spreading specimen. After Upton (1994).

balsa wood so that the wings can be manoeuvred with ease during the spreading procedure.

The width and the groove size of the setting-board depend on the size of the insect to be spread. A setting-board should always be at least 3 to 5 mm wider than the wingspan of the specimen,

and most collectors have a range of different sized boards to accommodate their specimens.

If, when constructing boards, the plywood or masonite base is allowed to project about 5 to 10 mm at each end to form a narrow ledge, the boards may be secured into an appropriate sized store-box or specially constructed setting-box. This may be achieved by inserting a strip of wood above the ledge to prevent the boards moving when the box is closed, or by constructing a runner or groove along which the ledge of each board can be slid. The runner should be slightly wider than the thickness of the ledge and may be made by fitting two parallel strips of 6 mm x 6 mm square dowel on each side of the box. Carrying a number of setting-boards in this manner is particularly useful in the field when many specimens are to be brought back in a pinned and spread condition.

Spreading

A specimen is in suitable condition for spreading only when the wing muscles are sufficiently well relaxed to permit the wings to move up and down when gently blown. To spread the wings the specimen is pinned centrally in the groove of a suitable setting-board with the bases of the wings level with the surface so that the wings can be easily manoeuvred on the board (Fig. 5). It is critical that the body does not slope up or down on the setting board, nor slant to the left or right. An entomological pin should be placed against one side of the specimen where the thorax and abdomen meet to prevent the specimen moving while the wings of that side are correctly positioned.

A setting-paper is placed over the area that will be occupied by the wings and fastened to the board at the front edge by two or three pins, preferably 10 mm x 0.25 mm micropins (D1). The wings are positioned either with a setting-needle, a 38 mm entomological pin or preferably with a micropin held in a pair of entomological forceps. The tip of the needle or micropin is placed behind one of the main veins near the

wing base so as not to damage the wing membrane. First, the fore wing is moved forwards so that the dorsum or inner margin is at right angles to the body, temporarily held in place by tightening the setting-paper with the fore finger, then fixed permanently with one or more micropins inserted through the setting-paper close to the wing margin. Alternatively, No. 3 entomological pins may be used to secure the setting-paper, but these are often awkward when handling the boards. The hind wing is then similarly positioned and fixed. The wings on the other side are spread in the same manner, and the micropin restraining the body is removed. Care should be taken to see that the wings are arranged symmetrically on the setting board. The antennae should then be arranged in position parallel to the costa of the fore wing and secured under the setting-paper or held by cross-pins.

Finally, cross-pins are inserted below, and if necessary above, the abdomen to hold it in a central horizontal position. A temporary or permanent data label (see below) should be pinned beside the specimen immediately: never trust your memory, always prepare the labels when the information is fresh in your mind! A few flakes of naphthalene should be placed along the groove of the setting-board, or in the store-box into which the setting-board is to be stored, to prevent possible attack from unwanted pests such as ants. In the field, loose flakes may move and break legs or antenna during transportation so it is advisable to protect the specimens by providing the naphthalene in porous containers or as pinned mothballs (see *Curation* below), which are firmly fixed to the store-box.

Skippers are more difficult to spread than other groups, especially when arranging the hind wings. This problem can be reduced by first making a short longitudinal cut with the point of a scalpel or razor blade on each side of the thorax below the bases of the hind wings. The severing of some of the stronger wing muscles in this way should permit the hind wings to be moved forward more freely. A micropin may have to be

inserted through the setting paper and hind wing as an additional means of keeping the wing in place during drying. The small hole created by the micropin rarely detracts from the aesthetic value of the specimen.

Drying

Spread specimens should be dried as quickly as possible (at a temperature no higher than 38°C), preferably in a drying cabinet or oven that is well ventilated but protected against attack by museum beetles, ants, growth of mould, etc. Exposure to direct light is to be avoided; storage in complete darkness is preferable. If an oven or drying cabinet is not used the setting-boards should be placed in a well-ventilated, pest-free wooden store-box or cardboard box. The drying time will vary with the size of the specimen, temperature and humidity according to the season and climate. Large specimens should be left on the boards longer than small ones, and drying always takes longer in humid conditions than in dry conditions. For example, during summer three to four weeks is usually necessary for large specimens, whereas small ones may be thoroughly dry in less than a week. However, it is advisable to leave specimens on the setting-boards as long as possible. If specimens are properly relaxed when spread and thoroughly dry before being removed from the boards, the wings should remain in a horizontal plane, in their correct position, and not droop provided they are stored in a dry atmosphere.

When drying is complete the specimens should be removed from the setting-boards with great care as they are brittle and damage easily. The cross-pins are carefully removed from the setting-board first, followed by the pins holding the setting-papers. Once the setting-papers are removed the central pin carrying the dried specimen can be carefully withdrawn. If some of the dried structures of the specimen, such as legs, antennae or abdomen, happen to break off during the removal stage, these should be carefully glued back using a hard-bonding,

quick-drying (1–2 minutes) clear glue; a quick-finish clear nail polish is ideal for repairing damaged specimens. Alternatively, the broken pieces may be placed in a suitable sized gelatin capsule, which can be impaled on the central pin beneath the specimen. The data label (see below) is then attached to the specimen by passing the pin through the centre of the label and only a short distance from the point of the pin so that it can easily be read from above.

Labels

A permanent data label showing the precise locality, the date of capture and the collector's name must be attached to every specimen. A specimen without a locality label is of no scientific value. The data should be printed, typed or written neatly in water-proof black ink with an 0.1 to 0.2 mm draftsman's pen on archival white card. These labels should be as small as practicable; sizes of 20 mm x 10 mm or 15 mm x 10 mm are generally suitable.

The locality data should include the distance (at least to an accuracy of 2 km) and correct compass direction from the nearest town or prominent landmark (e.g. mountain peak, lake, etc.), preferably measured from a topographic map, as well as the State or Territory. The distance by road should not be used. Where possible, latitude and longitude should be included; this can be obtained from national topographic maps or, more conveniently, from reasonably priced Global Positioning System (GPS) units. Where specimens are likely to be sent overseas it is recommended that the country of origin, in capital letters, come first. The date of collection is important for information on seasonal occurrence and should be written as '17 Jul. 1959'; Arabic numerals ('6') or Roman numerals ('vi') should never be used for the month.

Should the specimen have been reared and emerged from the pupal stage, the abbreviation 'emg.' should precede the date to indicate this. Other details such as altitude and broad habitat type (e.g. rainforest, open-forest, woodland,

grassland, etc.) may be given where significant. The collector's name permits the authenticity to be checked and allows credit to be given. Specimens collected in copulation (i.e. a mating pair comprising male and female) should each bear an additional label indicating that they were captured whilst mating. A separate label should be prepared for each sex, one stating 'Specimen A, in cop. with B' and the other stating 'Specimen B, in cop. with A'. Details of the larval food plant, dates of pupation and adult emergence of reared specimens from immature stages should be recorded on a separate label. Rearing labels should always be precise, for example, 'reared from larva on *Harpullia pendula* flowers'. Commonly seen labels in collections 'ex. *Harpullia pendula*' or 'b. *Harpullia pendula*' convey very little information and are ambiguous.

The following example of a reared specimen of the Regent Skipper, *Euschemon rafflesia*, illustrates how two labels should be prepared:

10 km N of
Burleigh Heads, Qld
emg. 2 Jan. 1982
I.F.B. Common

Reared from larva on
Wilkiea macrophylla
in littoral rainforest
coll. 24 Nov. 1981
pupated 8 Dec. 1981

These data will provide important information that can be now entered into a computer database to progressively build up a more complete picture of the species' geographical distribution, habitat and phenology, which contributes to our overall understanding of its life cycle and ecology.

Storage

After pinning, spreading, drying and labelling, the specimens are ready to be placed permanently in the collection, which may be stored in either entomological cabinets or store-boxes.

Entomological cabinets are constructed either of steel or wood and contain a number of drawers lined with polyethylene foam or cork and with more or less airtight glass lids. The better cabinets

have an internal cell surrounding each drawer, into which a small quantity of naphthalene flakes is placed to protect the collection from pests. Some cabinets have a door or shutter on the front to provide extra protection.

Cabinets are a fairly expensive item but are well worth having because they greatly reduce the problems of damage by insect pests and mould. In addition, they permit easy examination of specimens through the glass lid and greatly enhance the appearance of the collection. Store-boxes are less secure and specimens are sometimes damaged through excessive handling. Regardless of how specimens are stored, they must be kept in a dry environment and never be exposed to light for any length of time for they will gradually lose their colours.

Curation

Once a collection has been assembled considerable care should be taken to ensure that the material is maintained in good condition in the long term. A collection of dried specimens that is not well curated will eventually be attacked by several insect pests, such as museum beetles (*Anthrenus*), book lice, ants, silverfish and cockroaches, if adequate measures are not taken to discourage them. The eggs of museum beetles are laid in the slightest cracks around the lids of drawers or store-boxes and the tiny larvae enter through extremely minute openings. Close-fitting lids will normally exclude larger pests such as ants, silverfish and cockroaches.

Naphthalene, in flake form or as mothballs, is a satisfactory deterrent and should always be present in all cabinet drawers and store-boxes. Flake naphthalene can be placed in a cell or tied or sewn into small muslin bags pinned into the corners of drawers or store-boxes, or it can be carefully dissolved in liquid chloroform and the thick solution poured along one side of a store-box: on solidifying the strip of naphthalene will adhere to the lining of the box and may last for 12 months or more. Mothballs mounted on pins can

be pinned into drawers and store-boxes, but they must always be placed at the bottom where they can do no damage should they come loose. These can be made by heating the head of a common household pin until it is red-hot and then thrusting it firmly into the centre of the mothball, holding it in position until the naphthalene around the pin solidifies. Naphthalene slowly vaporises and should be renewed at regular intervals. It should be noted that naphthalene only acts as a deterrent and will not kill pests once they are established.

Presence of pests will be indicated by small, accumulated piles of fine dust beneath affected specimens. They can best be controlled by placing the drawer or store-box into a freezer (-20°C) for a minimum of 36 to 48 hours. Alternatively, the drawers or store-boxes may be fumigated by carefully introducing a piece of Dichlorvos pest-strip or some paradichlorobenzene crystals into one corner, closing the container and then sealing it inside a plastic bag for a few days. Paradichlorobenzene should not be used as a replacement for naphthalene for normal pest control indoors as it is known to be carcinogenic. Paradichlorobenzene, like other solvents, should not come into contact with polystyrene foam.

In tropical and humid coastal areas of Australia, a close watch should be kept to see that no specimens develop mould as this can cause considerable damage and loss. Chlorocresol will prevent mould becoming established in collections but, like naphthalene, should be renewed periodically. Where mould is likely to occur it is recommended to paint setting-boards and the insides of store-boxes from time to time with a saturated solution of chlorocresol crystals in alcohol. Slightly mouldy specimens can be restored by thoroughly drying the specimen and then by carefully removing the mould with a fine brush, dampened with chloroform. In humid climates, small dehumidifiers, that are now available commercially, may be used in the room in which the collection is kept.

Some species often become unsightly as a result of the spread of fat from the body to the wings. Species known to become 'greasy' should have a strip of rolled filter paper affixed to the pin directly beneath and touching the body to absorb the grease. Greasy specimens may be restored by dissolving the grease, by floating the specimen in a container of diethyl ether or ethyl acetate for several days. To prevent the wings from collapsing the specimen is removed from the solvent by slipping beneath the wings a small flat metal plate, with a slot cut in it to accommodate the pin and body of the specimen. After the solvent evaporates from the body and wings, the specimen can be lifted off the metal plate. The appearance of the restored specimen can then be improved by gently disturbing any matted hairs on body or wings with a fine brush. Ethyl acetate is not recommended for lycaenids and other butterflies with iridescent wing scales because the chemical destroys the light refractive properties of the scales. These specimens should be immersed in lighting fluid or petroleum spirits (e.g. Shellite) or diethyl ether for one or a few hours to remove the grease.