

Repairing Outerwear Garments

CCM-00075

Outerwear garments are expensive items in a winter wardrobe. When they are torn or when seams rip, snaps come loose and zippers break, immediate repair is usually needed. It is especially important to repair a hole or tear in an insulated garment as soon as possible. Expensive down and other types of insulation can fall out or come loose. Unless the insulation is replaced, the garment loses some of its warmth.

SUPPLIES FOR REPAIRING OUTERWEAR GARMENTS

When repairing a garment, it is best to use self-fabric from the end of a belt, a pocket or an inside garment hem, a facing or lining. If this isn't possible, check labels in the garment and then look for similar fabric or fabric patches (matching or contrasting) from fabric stores, notion counters, repair shops, or from outerwear kit companies like Altra® and Frostline®.

To help insure a sturdy and satisfactory patch, repair garments with fabric of the same fiber content and thread count. This is important. Downfilled garments and garments insulated with some types of fiberfill or battings require down proof fabric. Since lining fabrics are usually not down proof nor very sturdy, they are not suitable for repairing garments. The fabric weave and finish of fabric used in repairing garments should also be considered.

Outerwear kit companies, sporting goods stores and fabric stores are some sources for repair supplies such as: fusible patches, fabric tapes, replacement pockets, zippers and snaps, seam sealers (for water-proof garments), and knitted cuffs, collars and waistbands. Some upholstery shops and fabric stores carry heavy-weight zippers which are suitable for outerwear garments.

REPAIRING HOLES AND TEARS ON OUTERWEAR GARMENTS

Nylon fabrics, like nylon taffeta and nylon ripstop, are often used for repairing garments. Since they fray easily when handled and also in wearing and cleaning, it is best to sear all cut edges of the **patch** and of the garment hole or tear before applying the patch. Sear means to melt the edges of the nylon fabric to prevent fraying.

A lighted candle can be used for searing. A short candle with a thin wick works best. To sear, hold the fabric taut between your hands. Move the fabric past the base of the candle flame, not through it. Approach the flame directly from the front and at the level of the base of the flame. The heat from the candle will sear the fabric. Figure 1.

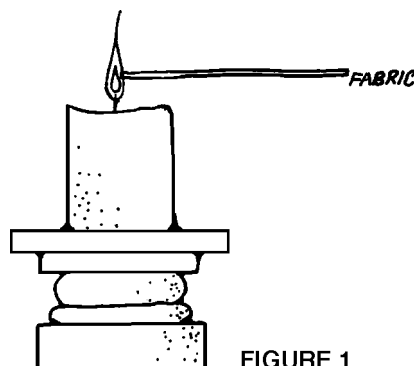

FIGURE 1

To prevent insulation from burning, push it back into the garment, away from the hole or tear. Trim frayed threads from fabric before searing, as they were apt to burn rapidly and mar the fabric edges.

When repairing heavily insulated garments it is best not to stitch through the insulation. Compressed insulation is not as warm as insulation at its normal thickness. Stitching through all thicknesses can cause cold spots.

If it is necessary to machine stitch when repairing heavily insulated garments, open the garment from the bottom of the garment or sleeve. In some cases, it might be best to open a garment at a sleeve or side seam.

When repairing, stitch through the repair fabric and outer fabric **only**, not through the insulation and lining fabric. After repairing the damaged area, restitch the opened seam or hemline.

There are several ways of repairing holes and tears on outerwear garments; some are more suitable for downfilled garments than others. Read through the following methods before deciding on the method most suitable for your garment.

Hemmed Patch

This type of repair is especially suitable for downfilled garments. It does not compress the down, cause cold spots or cause down leakage from machine stitching.

If the garment is insulated and there is a possibility of the insulation falling out or coming loose, stitch the tear closed with a tiny seam. Figure 2.

If it's impossible to use machine stitching, use hand stitching.

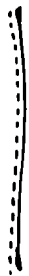

FIGURE 2

Cut the repair patch. It should extend about 1" (2.5 cm) on all sides of the hole or tear. Seal, if necessary. Turn all edges under 1/4" (6 mm). Figure 3.

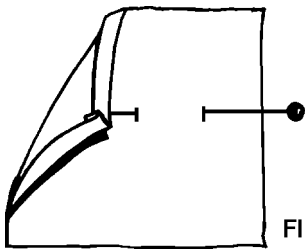

FIGURE 3

Pin the patch over the garment hole or tear. Figure 4.

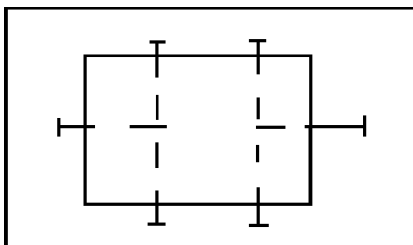

FIGURE 4

With matching polyester or polyester-wrapped cotton thread, slip-stitch the repair patch in place. Use small, close stitches, about 10 to 12 per inch (2.5 cm). Figure 5.

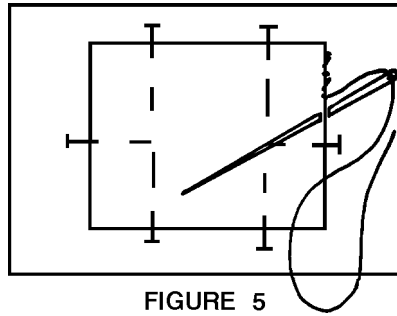

FIGURE 5

If the garment is uninsulated or lightly insulated, the repair patch could be machine stitched in place. Figure 6.

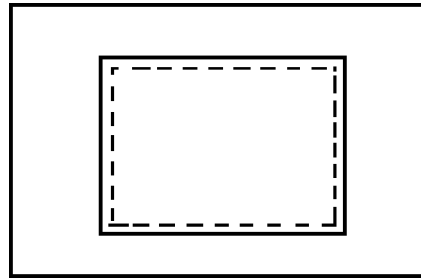

FIGURE 6

Machine stitching will be sturdier and more suitable for play or work clothes. Some insulated garments are quilted in squares. A hemmed patch may be less noticeable if the entire square is covered. Figure 7.

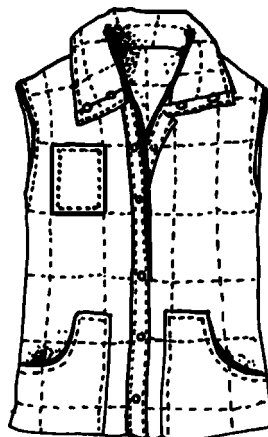

FIGURE 7

Heat Fusible Nylon Patch

There are several types of heat fusible or iron-on products on the market. They are quick and easy to use and come in a variety of colors. They are made of lightweight and heavy-weight fabrics. Some are washable but not drycleanable. Read product directions carefully before using.

Directions usually suggest cutting the patch 1/2" (1.3 cm) larger on all sides than the area to be repaired, then rounding the corners of the patch. Figure 8.

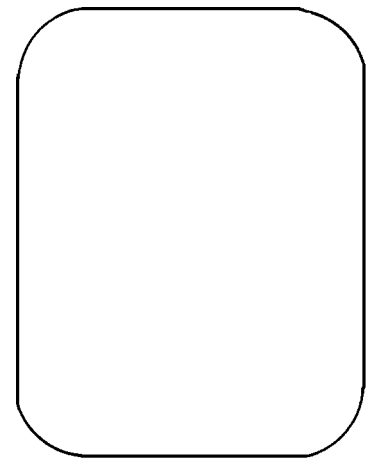

FIGURE 8

Cutting the patch 1" (2.5 cm) larger on all sides will give a sturdier patch. Often in washing and drying, edges of patches come loose and fray. To prevent this, machine zigzag the edges. Use a fairly wide, close stitch. Figure 9.

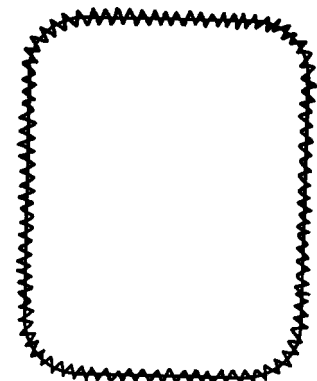

FIGURE 9

If you can't find a matching color or if you'd like a decorative effect, choose a contrasting color for a repair patch. Cut the patch in the shape of an initial, fruit or other design. Figures 10 and 11.

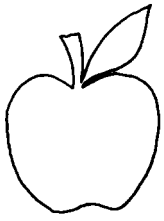

FIGURE 10

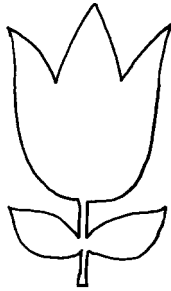

FIGURE 11

A child's coloring book is a good source for design patterns.

You might like to cut several decorative shapes. Cover the hole or tear with one and add several others just for decoration. Figure 12.

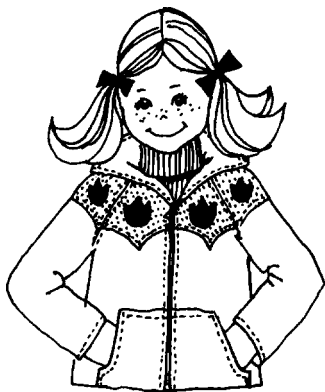

FIGURE 12

These ideas would be especially attractive when used on children's clothing. Because zigzag stitching is recommended, this type of patch is not suitable for downfilled garments.

Homemade Fusible Patch

Making your own fusible or iron-on patch is another possibility. This would be a good option to use if a matching fusible patch could not be purchased.

To make your own fusible patch, use a layer of fusible web and a layer of repair fabric. Cut both layers $\frac{1}{2}$ " (1.3 cm) larger than the hole or tear. Trim

the fusible web slightly smaller. Round the corner of both layers.

Sandwich the webbing between the patch and the garment to be repaired.

Following directions on the fusible web package, fuse the patch in place. Since nylon taffeta and nylon ripstop have a low melting point, use a low iron setting (nylon or synthetic) and use a press cloth.

Secure the edges of the patch with a machine zigzag stitch. Refer to Figures 8 and 9 under *Heat Fusible Nylon Patch* for repair steps, Figures 10, 11 and 12 for decorative ideas. Because zigzag stitching is recommended, this type of patch is not suitable for downfilled garments.

Adhesive Patch

Adhesive or pressure sensitive repair tapes are also available. They are quick and easy to use and are available in many colors. They are made of nylon taffeta and nylon ripstop. They are washable, but not drycleanable.

Directions usually suggest cutting the patch to size, rounding the corners, peeling off backing tape and pressing it firmly over rip or tear. Secure the edges of the patch with a machine zigzag stitch.

Refer to Figures 8 and 9 under *Heat Fusible Nylon Patch* for repair steps, Figures 10, 11 and 12 for decorative ideas. Because zigzag stitching is recommended, this type of patch is not suitable for downfilled garments.

REPAIRING SPLIT OR FRAYED SEAMS

In wearing and laundering, seams on outerwear garments often split or fray. They can be easily repaired. The repair can be concealed or it can be used as a decorative effect.

To repair a split seam, restitch the damaged seam. Then stitch again $\frac{1}{4}$ " (6

mm) in toward cut edge of seam allowance. Figure 13.

If the fabric is nylon, sear both edges to prevent fraying.

If the seam has already frayed, trim the frayed area. Then restitch the seam. Stitch again $\frac{1}{4}$ " (6 mm) in toward cut edge of seam allowance as shown in Figure 13.

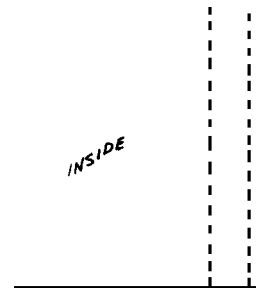

FIGURE 13

For a decorative effect, select a contrasting repair fabric. Before cutting a fabric strip, experiment with a strip of paper. You may want to cover only the repaired area or you may choose to cover the entire seam. Experiment with different fabric strip widths since one width may be more pleasing than another.

After deciding on width and length of strip, add $\frac{1}{4}$ " (6 mm) to $\frac{1}{2}$ " (1.3 cm) for seam allowance. If you decide on covering only the damaged area, you may choose to cut ends in a V shape. Use a paper pattern to cut fabric strip. Figure 14.

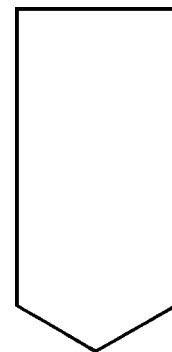

FIGURE 14

If using nylon fabric, sear cut edges. Turn seam allowance under. Pin strip in place. Figure 15.



FIGURE 15

Topstitch close to the edges of the strip. Use matching thread or for a decorative effect use a contrasting thread. Figure 16.

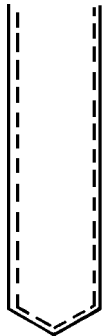

FIGURE 16

REPAIRING QUILT STITCHING

Some threads used in quilting may break and ravel back. In most insulated garments it's important that they be repaired as soon as possible to prevent insulation from shifting or coming loose.

A drop of fabric glue on a damaged quilting stitch will prevent further raveling and serve as a temporary type of repair. Machine stitching is a quick and durable method of repairing quilt stitching.

Adjust your machine stitch length so the repaired stitch length matches the original stitching. Try a sample stitch on a seam allowance or belt end.

On garments that get hard use and where durability is important, overlap the new stitching with the old stitching for about $\frac{1}{2}$ " (1.3 cm). Backstitch at beginning and ending of stitching. Figure 17.

For delicate garments or those that do not receive hard wear, pull the damaged threads to the back and tie

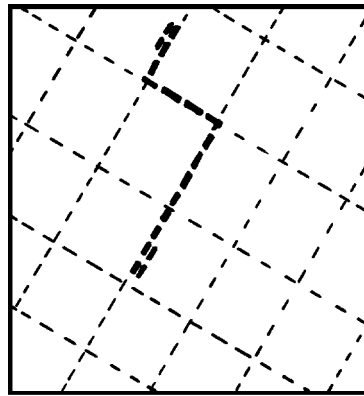

FIGURE 17

them together securely. Restitch the damaged area, overlapping each end of the new stitching over the old stitching by one stitch. Figure 18.

At each end of stitching, pull threads to the back, tie securely and snip off excess thread about 1" (2.5 cm) from knot.

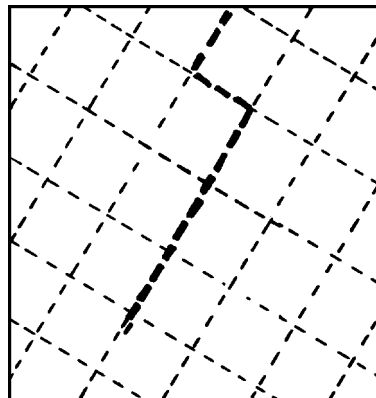

FIGURE 18

REPLACING SNAPS

As a garment is continually opened and closed, snaps may work loose or pull out. They can be easily replaced with new snaps, using a snap setting tool.

Replacement snaps come in different sizes and a variety of colors. Heavy-duty snaps, approximately $\frac{5}{8}$ " (1.5 cm) in diameter, are suitable for heavy-weight garments. The medium duty snaps have a shorter shank than the heavy duty and are often referred to as "baby durables." Choose the weight and color most suited to your garment.

Snap setting tools also come in different sizes. Use the size that matches the size of the replacement snaps.

Before replacing a snap, reinforce the damaged area. The reinforcement should extend about 1" (2.5 cm) around all sides of the snap. If bulk is a problem, use two layers of firmly woven nylon fabric as a reinforcement. If the fabric isn't bulky, one layer of quilted fabric might be suitable.

To set the snap on your garment, sandwich the reinforcement fabric between the outer and inner garment fabric. Center it in the area of snap replacement. Follow the directions on the snap setting tool carefully.

It would be best to practice setting a snap on a similar weight fabric before setting it on an actual garment. If the top of the snap mars in setting, try inserting a fabric scrap between the die plate (part of the snap setting tool) and the snap. This will cushion the force when hammering the two parts of the snaps together.

REPLACING ZIPPERS

With hard use, zippers may wear out and must be replaced. When replacing a zipper, choose one that is durable and suited to your garment.

There are many sizes, qualities and makes of zippers on the market. The synthetic (plastic or nylon) zippers are best for use in cold weather, since metal zippers can freeze and also corrode.

Zippers are available in several styles. Non-separating zippers close in one direction and are used for areas as in pockets. Separating zippers with a single slide zip in one direction only. They are often used in overalls and short jackets. Figure 19.

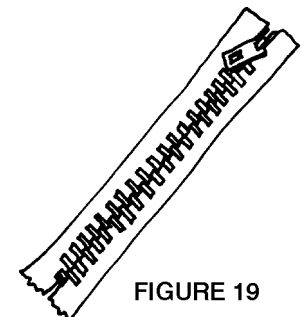

FIGURE 19

Separating zippers with a double slide zip from both bottom and top. Figure 20. This is a good choice for a longer jacket or coat, as they can be unzipped for sitting room or to allow body heat to escape.

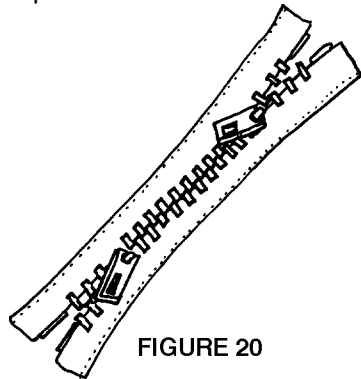

FIGURE 20

Lightweight, spiral nylon zippers, commonly used on women's clothing, are not suitable for outerwear garments as they are too delicate. The best choice is nylon coil which is a continuous spiral without edges or teeth that can snag and break off. A large size zipper, 9 or 10, would be a good choice for an insulated jacket.

When choosing any type of a zipper, closely examine the bottom of the zipper where the two pieces interlock. The right side of the zipper should have an extended area or tongue, which will allow a good interlock between the two sides of the zipper. Figure 21.

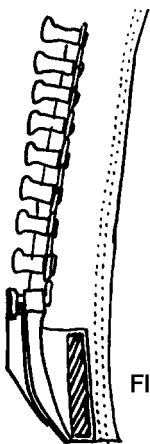

FIGURE 21

If there is not a good interlock between the two sides of the zipper, the ends or pins of the zipper will wear down with use. When this happens, it is difficult to align the two sides. At this point the zipper jams and must be replaced.

It is often difficult to find just the right zipper length. If it is necessary to shorten a zipper, measure the garment opening. Measure from the bottom zipper pull tab to the desired length. Mark both zipper sides. Make a knot in the end of a double strand of heavy-duty thread and take three or four whipstitches across each zipper coil at marked points. Figure 22.

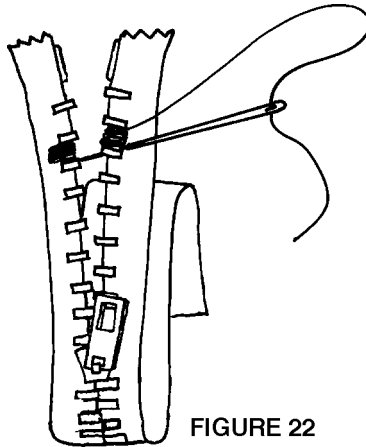

FIGURE 22

These whipstitches will be the new zipper stop, so be sure they are secure. Cut across the zipper tape and coil about 1" (2.5 cm) above the stitches.

Before removing a damaged zipper, baste all garment layers together 1" (2.5 cm) from both zipper edges. Basting will hold insulation and lining in place. Figure 23.

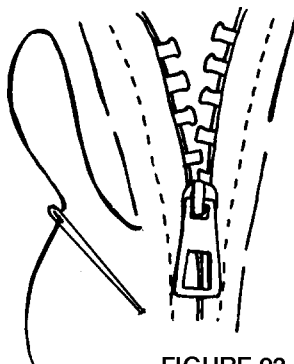

FIGURE 23

Carefully remove damaged zipper. Insert replacement zipper between outer fabric and lining. Baste zipper to lining only. Stitch in place. Figure 24.

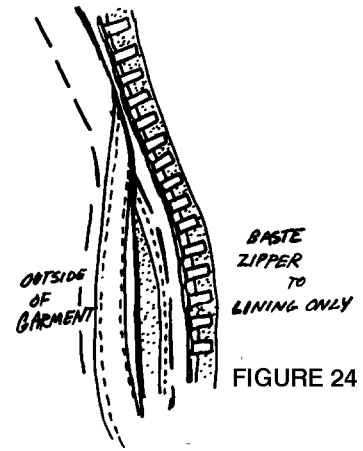

FIGURE 24

Pull fabric taut in front and back of presser foot while stitching. Stitch both sides in the same direction.

Baste outer fabric over zipper. Following original stitching lines, stitch through all thicknesses. Figure 25.

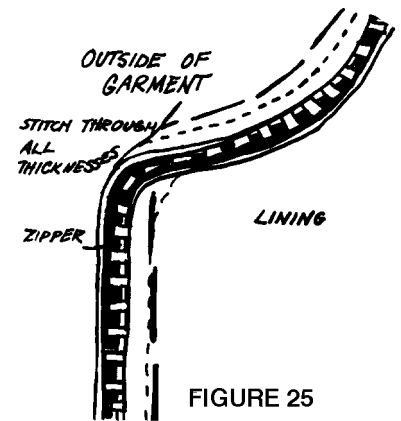

FIGURE 25

To secure zipper, zigzag with a narrow close stitch for 1/2" (1.3 cm) at both ends. Figure 26.

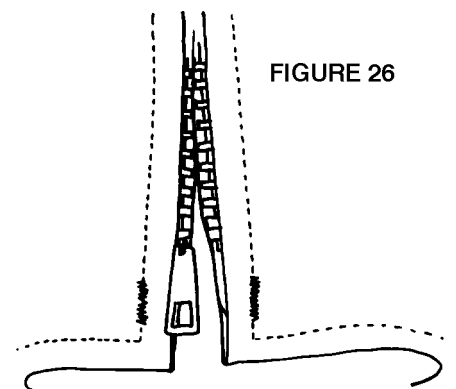

FIGURE 26

REPLACING KNITTED CUFFS

Knitted cuffs on outerwear garments often wear out sooner than the garment. Replacement cuffs, either of a single or double thickness, come in many colors and are available in nylon or a nylon/cotton blend. One hundred percent nylon cuffs keep their shape better and dry quicker than the nylon/cotton blends.

To replace a cuff, run a line of hand basting about 3" (7.5 cm) above the cuff. This will hold the lining and insulation in place when the cuff is removed. Figure 27.

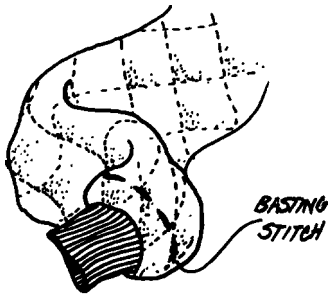

FIGURE 27

Turn the sleeve inside out and remove the stitches where the lining meets the cuff. Pull the lining up and pin out of the way. Remove sleeve cuff stitches.

If outer sleeve fabric is slippery and garment is insulated, baste the two layers together just above the cuff seam.

Mark the new cuff in four equal parts by folding it in half, then in half again. Mark the four parts with pins or contrasting thread. Figure 28.

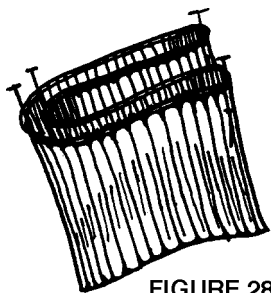

FIGURE 28

If the knitted cuff is unfolded, Figure 29, fold into position, Figure 30, before marking into equal parts. Machine zigzag ribbing edges together.

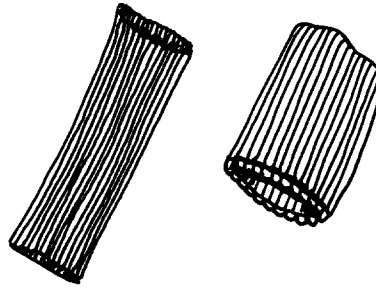

FIGURE 29

FIGURE 30

Fold and mark the sleeve in four equal parts. Figure 31.

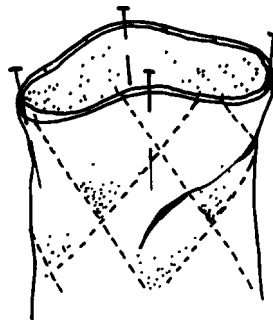

FIGURE 31

Place the new cuff over the sleeve with right sides together and raw edges even. Match markings and pin. Figure 32.

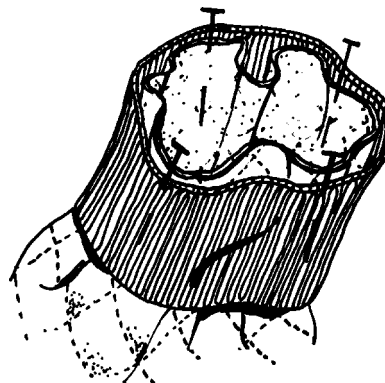

FIGURE 32

With ribbing on top, stretch ribbing to the size of the sleeve. Stitch seam. Figure 33.

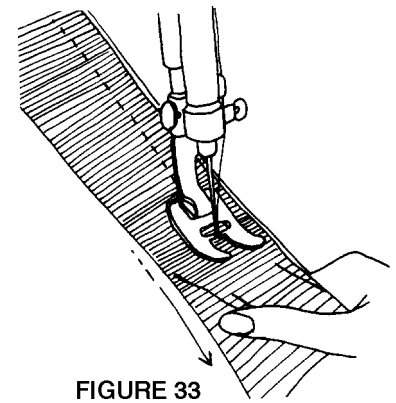

FIGURE 33

Turn seam allowance towards sleeve seam. Bring folded lining edge over cuff seam and hand stitch in place. Figure 34.

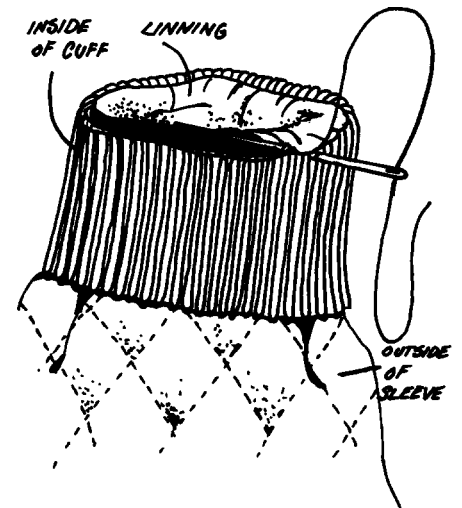

FIGURE 34

If one needs to replace knitted collars and waistbands, follow the same directions.

RESEALING SEAMS

After wearing and cleaning, seams in waterproof garments often start to leak. There are products on the market that will rewaterproof leaky seams. They are called seam sealers.

Read product information carefully, as some seam sealers are designed for use with natural, synthetic and laminated fabrics, while others are designed for use with **only** synthetic fabrics.

Directions for sealing seams will vary. For best results follow direction carefully. Try sealing a seam in an inconspicuous area first. If satisfied, repair all seams.

Be sure to heed warning information. Some seam sealers are toxic and very flammable. They should be used only in well-ventilated areas. Skin contact should be avoided, and they should not be used near heat, sparks or open flames.

OTHER REPAIR OPTIONS

Since garments are made of different fabrics, insulations, designs and for various age groups, the type of repair must be chosen on an individual basis. Keep in mind that machine stitching is not recommended for attaching repair fabrics to downfilled garments. Here are some options to consider.

Purchased Appliqué

Purchased appliqué comes in a variety of sizes and styles and are suitable for almost any age. They work well for covering a small hole or tear, or perhaps a cigarette burn.

If necessary, sear the edges of the small hole or tear, and then weave back and forth with small hand stitches. A drop of fabric glue will help to strengthen damaged area also. Figure 35.

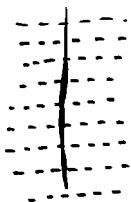

FIGURE 35

Pin purchased appliqué in place. With matching thread, attach with small slip-stitches, Figure 36, or by machine stitching (straight or zigzag). Figures 37 and 38.

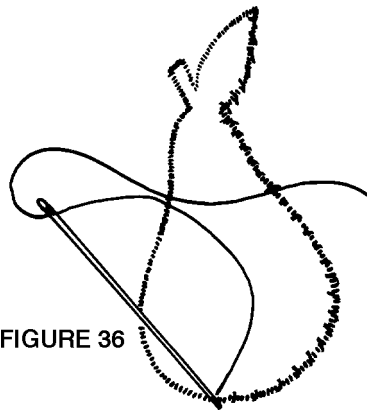

FIGURE 36

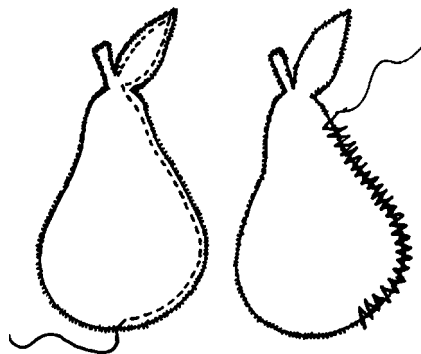

FIGURE 37

FIGURE 38

A purchased appliqué also adds an interesting effect to an initial or other design. Figure 39.

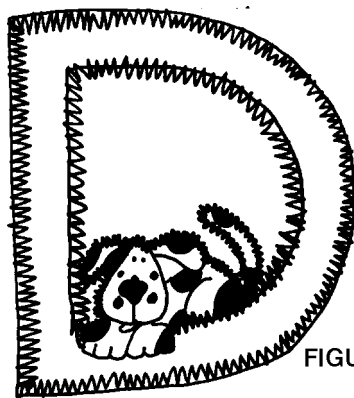

FIGURE 39

Homemade Appliqué

Making an appliqué to cover a damaged area is another possibility. A child's coloring book is a good source for suitable designs. Simply cut appliqué of a contrasting fabric and large enough to extend 1" (2.5 cm) or more on all sides of hole or tear.

If necessary, sear edges of hole or tear and appliqué. Turn edges of appliqué under $\frac{1}{4}$ " (6 mm) and pin in place. Attach to garment with small blindstitches or machine stitching (straight or zigzag). Refer to Figures 36, 37 and 38 under *Purchased Appliqué*.

For a decorative effect, use a contrasting thread or yarn (same fiber content as garment) and embroider the appliqué in place. This would be appropriate for a design like a flower. You might choose to use a decorative stitch, like the buttonhole stitch, when attaching the appliqué. Other decorative designs such as stems and leaves could be added. Figure 40.



FIGURE 40

OVERLAYS

Overlays are similar to appliqué, but differ in the way they are stitched to the garment. Overlays are pieces of fabric laid over garment fabric and machine stitched in place.

They work well to cover damaged areas on patch pockets, sleeves, jacket fronts or back and pant legs. With insulated garments, seams must be opened, so machine stitching is through outer garment fabric only.

When using an overlay, make a paper pattern before cutting fabric.

Experiment with paper pattern pieces before cutting overlays of fabric. Consider a straight contrasting stripe (or stripes), Figure 41, or a chevron effect, Figure 42.

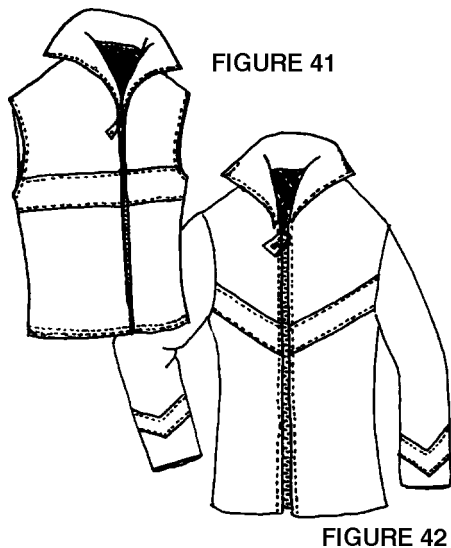

FIGURE 41

FIGURE 42

A complete new yoke, Figure 43, a new pocket, Figure 44, or decorative designs in several different colors, Figure 45, are other possibilities.

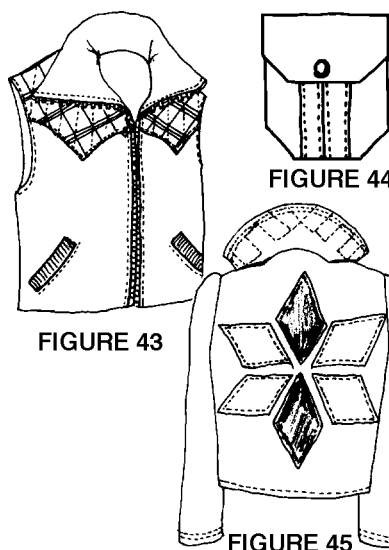

FIGURE 43

FIGURE 44

FIGURE 45

After deciding on size, shape and placement, make a paper pattern piece to fit damaged section of the garment. Add $\frac{1}{4}$ " (6 mm) to all sides for turning under. Cut overlay on same fabric grain as garment. Sear if necessary. Turn edges of overlay under $\frac{1}{4}$ " (6 mm). Figure 46.

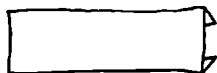

FIGURE 46

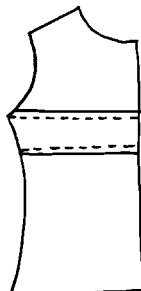

FIGURE 48

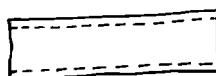

FIGURE 47

Hold overlay over garment. If colors or seam allowances show through, cut a lightweight non-woven interfacing the same size as the overlay. Place interfacing fabric on wrong side of overlay and stitch the two layers together slightly less than $\frac{1}{4}$ " (6 mm) from each edge. Figure 47.

Trim interfacing to stitching and press under $\frac{1}{4}$ " (6 mm). Place overlay on right side of garment fabric. Pin or baste in place. Topstitch $\frac{1}{8}$ " (3 mm) in from edges of overlay. Figure 48. Restitch garment seams.

When using an overlay with curved edges, it is best to cut two design pieces, stitch them together, turn and topstitch to the garment.

Elbow Patches

Elbow areas may wear out or are damaged easily. A purchased elbow patch could be the most suitable type of repair.

Before applying an elbow patch, repair the damaged area by searing (if necessary) and hand weaving the tear or hole together. Machine or hand stitch elbow patches in place. Figure 49.

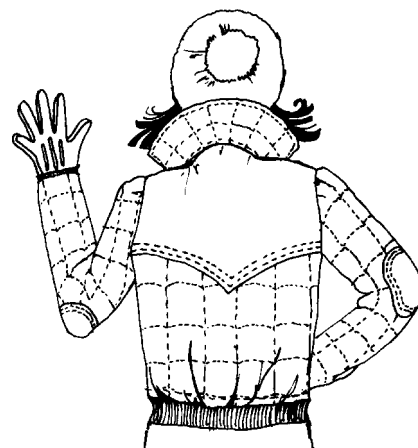

FIGURE 49

Author - Ruth R. Gulbrandson, Clothing & Textiles Specialist, Cooperative Extension Service, North Dakota State University. The author wishes to thank Ethel M. Buehl, Textiles and Clothing Department, College of Home Economics, North Dakota State University and Byron Suter, Suter's Mill, Moorhead, Minnesota for review of the circular.

The information given herein is for educational purposes only. Reference to commercial products or trade names is made with the understanding that no discrimination is intended and no endorsement by the Alaska Cooperative Extension is implied.

Reprinted October 1996